

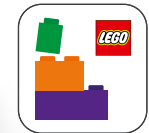

10340



Booklet available in English  
Heft in deutscher Sprache erhältlich  
Livret disponible en français  
Libretto disponibile in italiano  
Folleto disponible en español  
如需中文版手册



LEGO® Builder

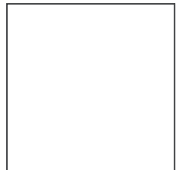



LEGO.com/sustainable-packaging



FR  
**DONNEZ  
OU  
RECYCLEZ**



ASSOCIATION

OU



MAGASIN

OU



DÉCHÈTERIE

Adresses sur [quefairedemesdechets.fr](http://quefairedemesdechets.fr)



# BUILDER



Apple and the Apple logo are trademarks of Apple Inc., registered in the U.S. and other countries and regions. App Store is a service mark of Apple Inc. Google Play and the Google Play logo are trademarks of Google LLC. Tencent and the Tencent logo are trademarks of Tencent Inc.

LEGO.com/devicecheck



LEGO® Builder





## Warm feelings for cold days

When the first signs of autumn and winter set in, it seems nature invites us to play with all its beautiful, seasonal colours and bounties. Bright berries complement evergreen branches, and leaves seem to radiate and spread rays of warm hues as they fall at your feet. Bringing these gorgeous bundles of colour into your home can create cosy sparkles of joy as we wait for lighter days to return. Add to that the delightful sense of accomplishment in the creative process as you bring all the shapes and colours that inspire you together, and you have a perfect excuse to snuggle up and indulge your senses. With this elegantly crafted LEGO® wreath or garland, you can extend that feeling of joy and change your decor throughout the winter season.



## Festive aromas

Each season has its charms. Even dark winter days give us moments of light to share with loved ones. Nothing evokes fond memories like the sweet, aromatic fragrances of the festive season – invigorating fir tree foliage, zesty orange slices, warm cinnamon or earthy pine sap. When you sit down to build this set, you can find inspiration from all these familiar scents and spices. Build a decorative wreath to hang on the wall, or a festive garland centrepiece for your tablescape. Add your own creative touch and customise it to suit your celebration, mood or interior decor. From the shape of the arrangement to the tiny details, simply swap out the berries or reconfigure the decorative elements and experiment with the elements to create new expressions. We hope this leaves you feeling toasty and comfortable on cool days, and that you will create new memories to look back on for years to come.

**KENYON ANDREW BRADY**

*LEGO® Model Designer*



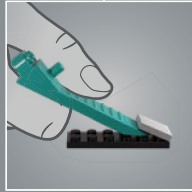
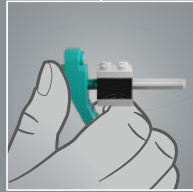
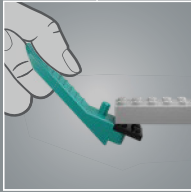
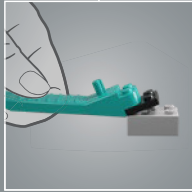
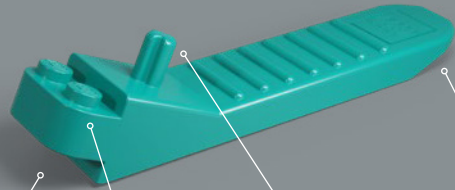



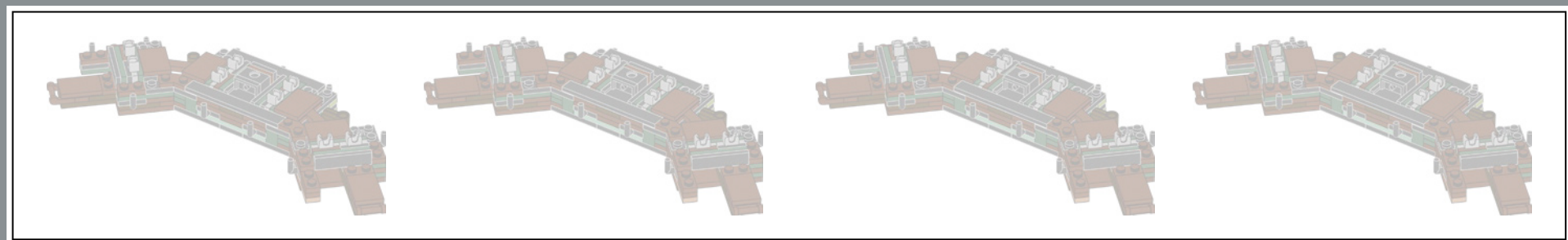



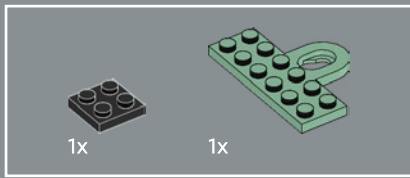

5

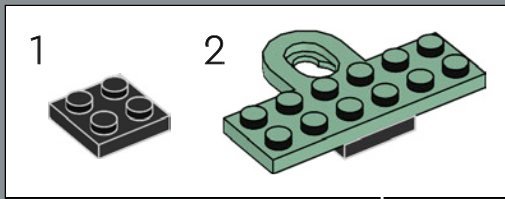
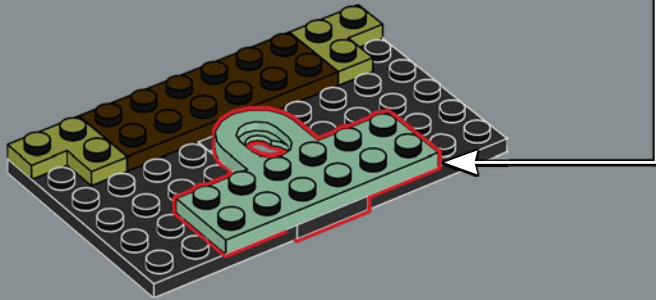

7

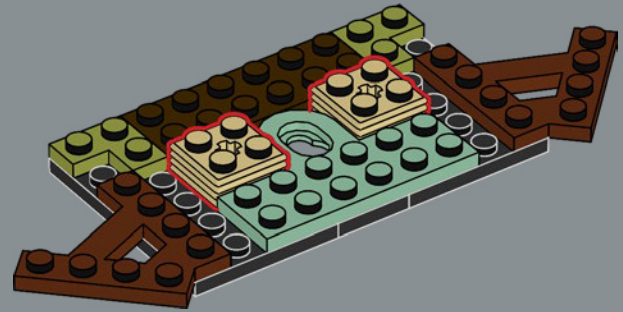

6

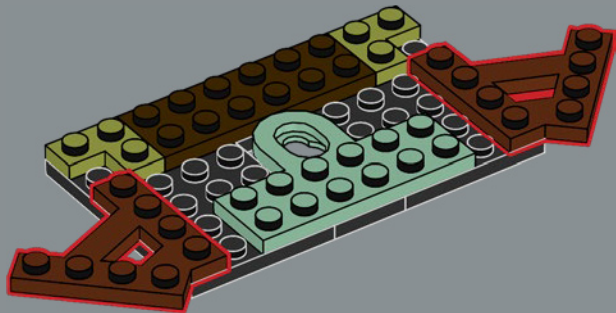

8

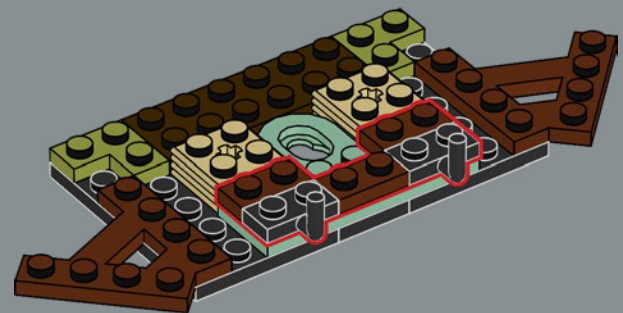

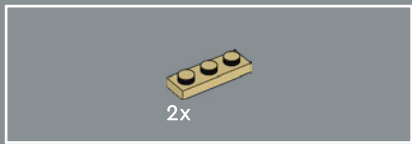

9

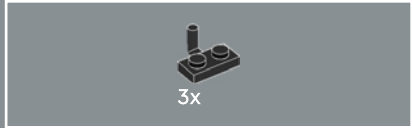
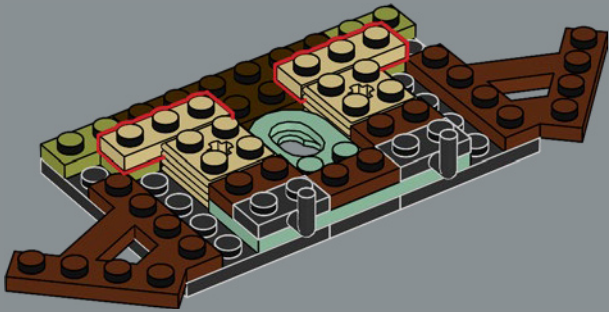

10

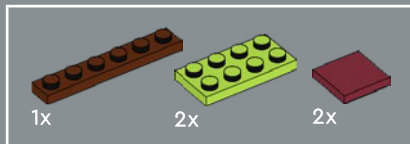
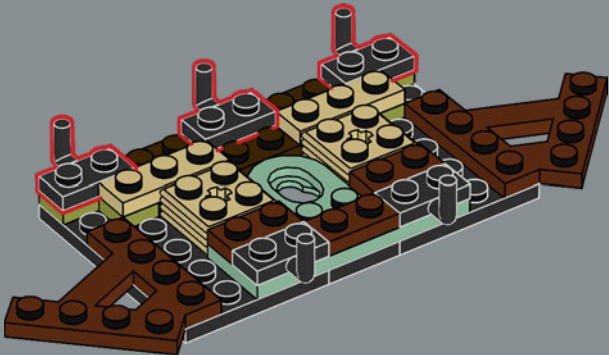

11

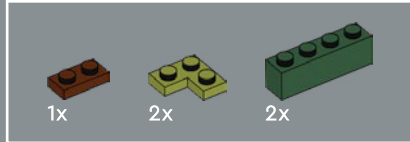
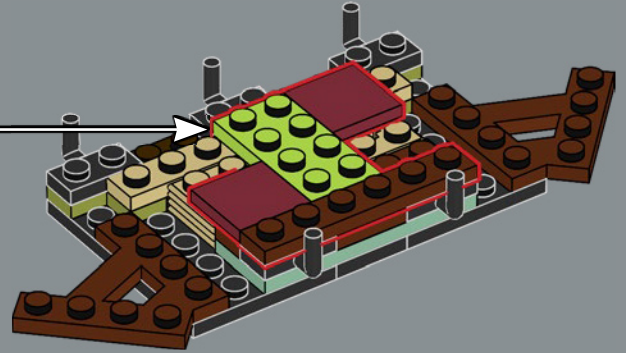
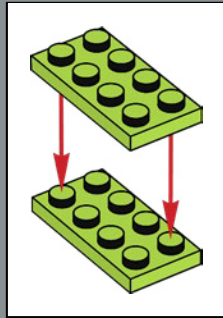

12

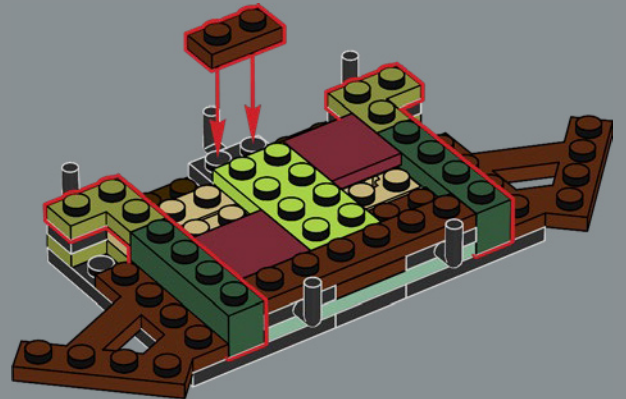



13

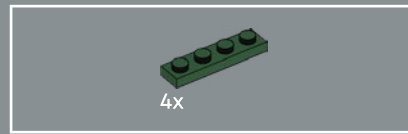
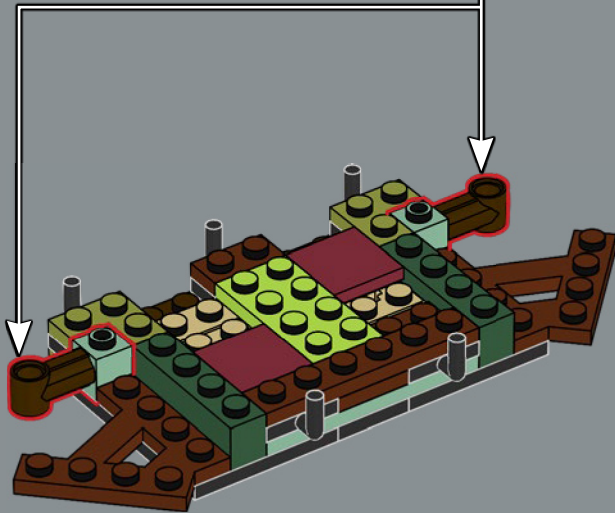
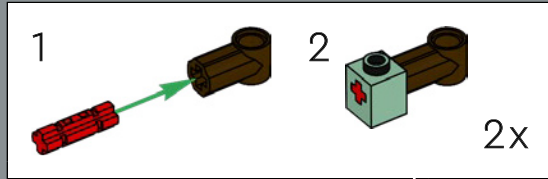

14

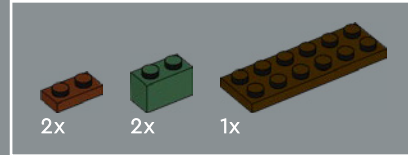
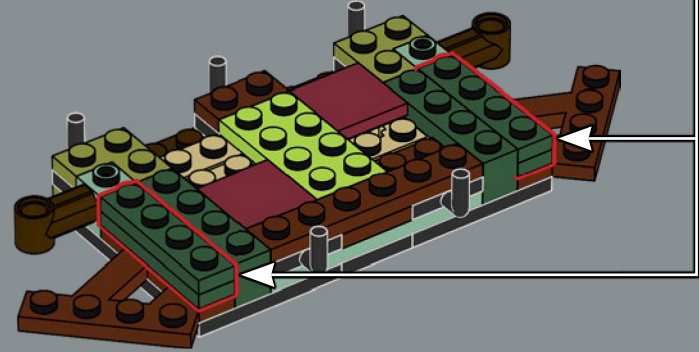
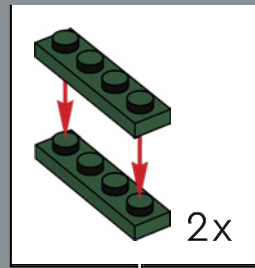

15

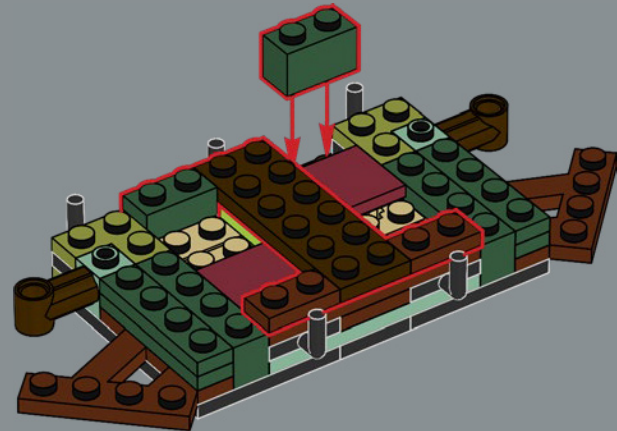

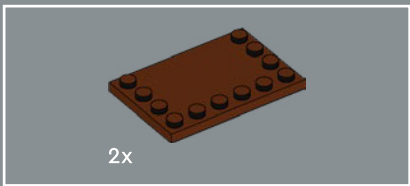

16

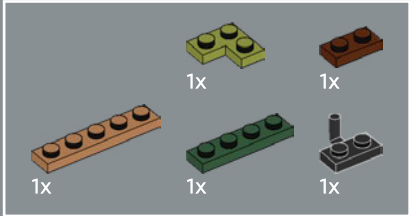
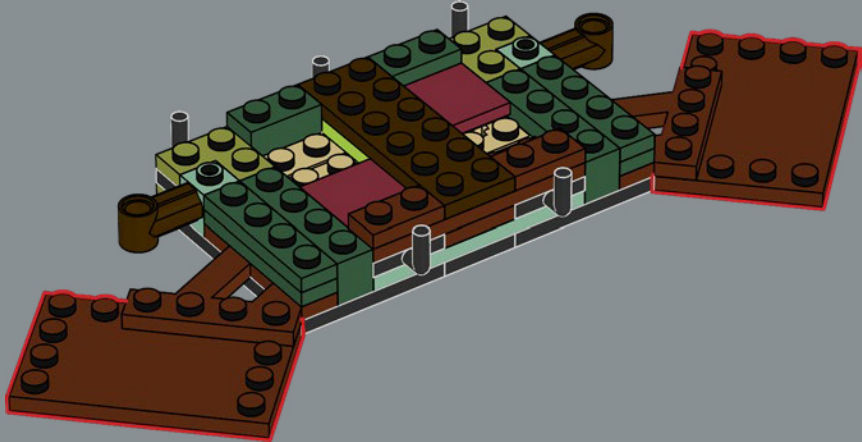

17

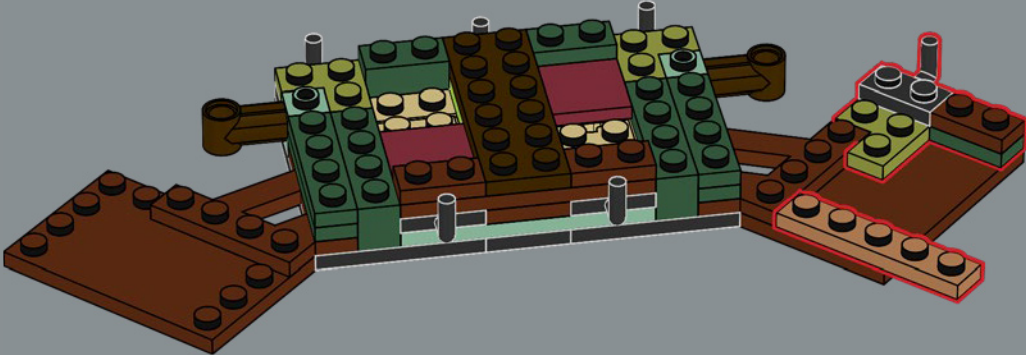
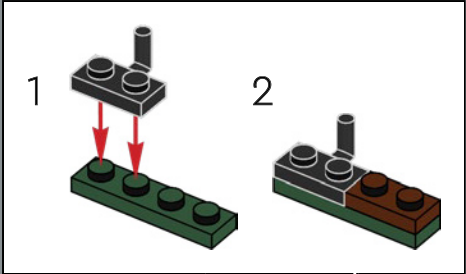

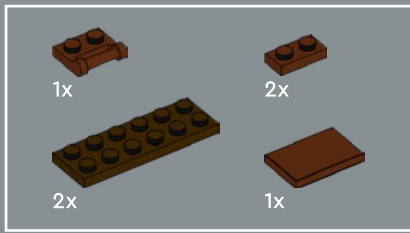

18

1

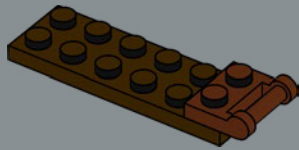

2

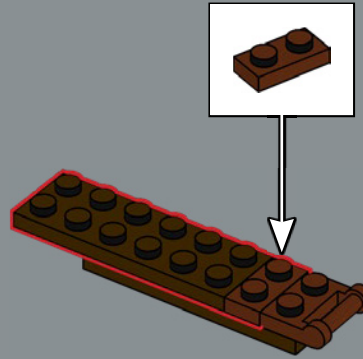

3

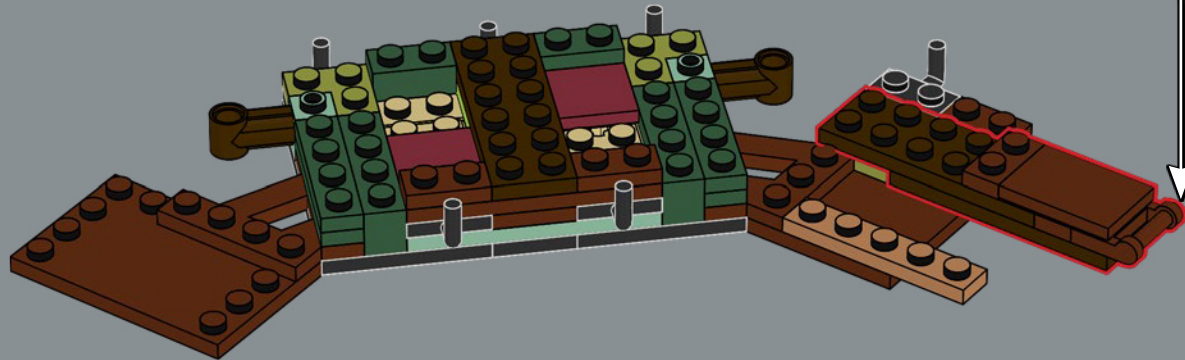
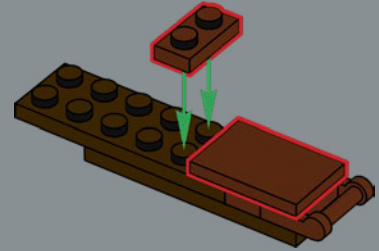

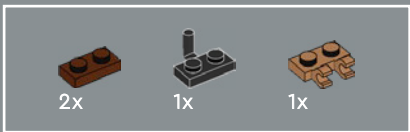

19

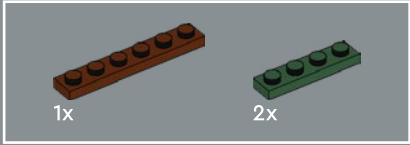
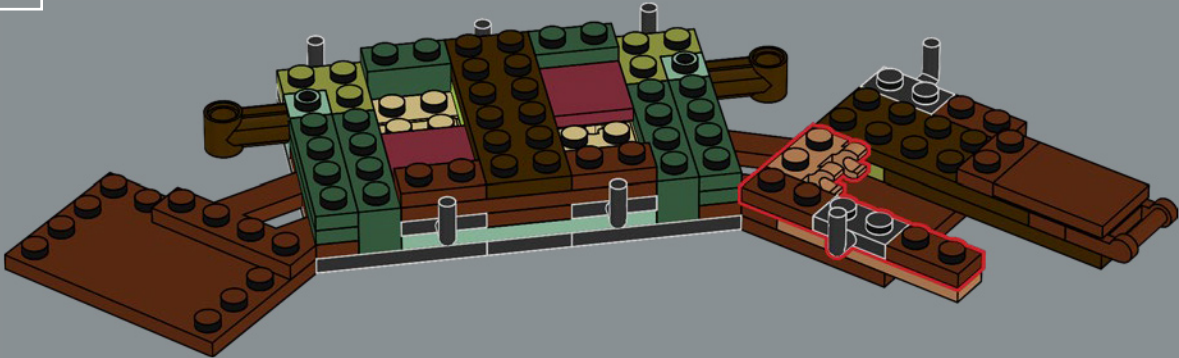

20

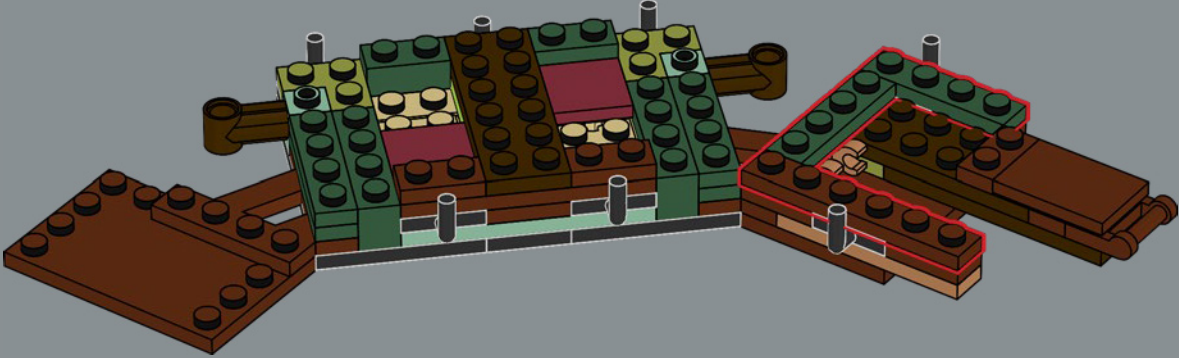





21

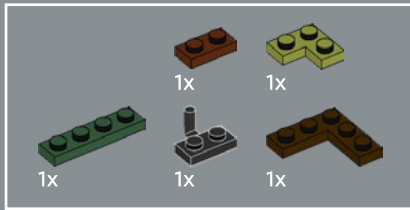
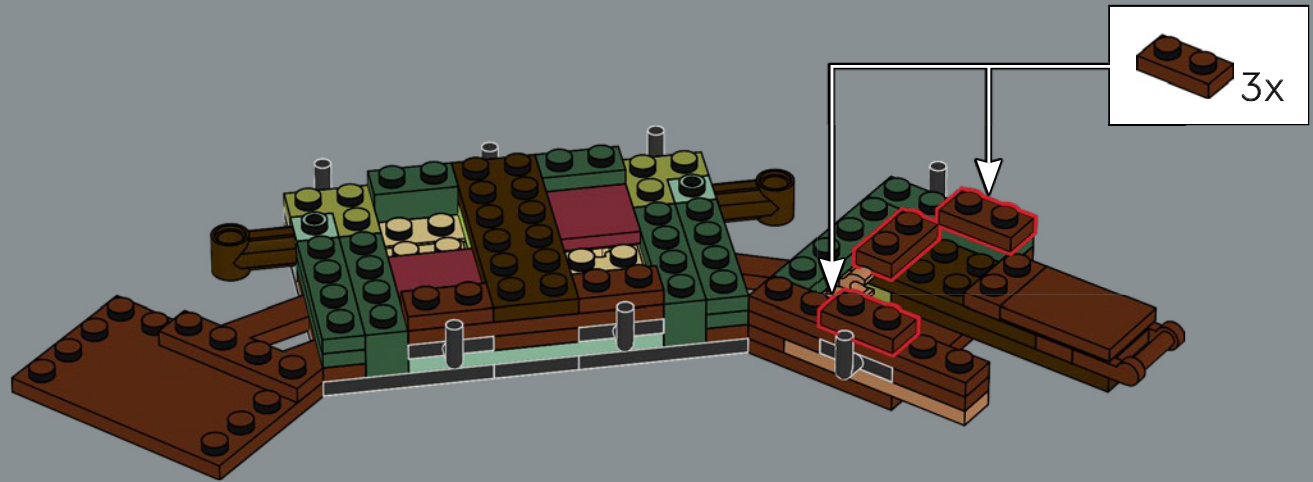

22

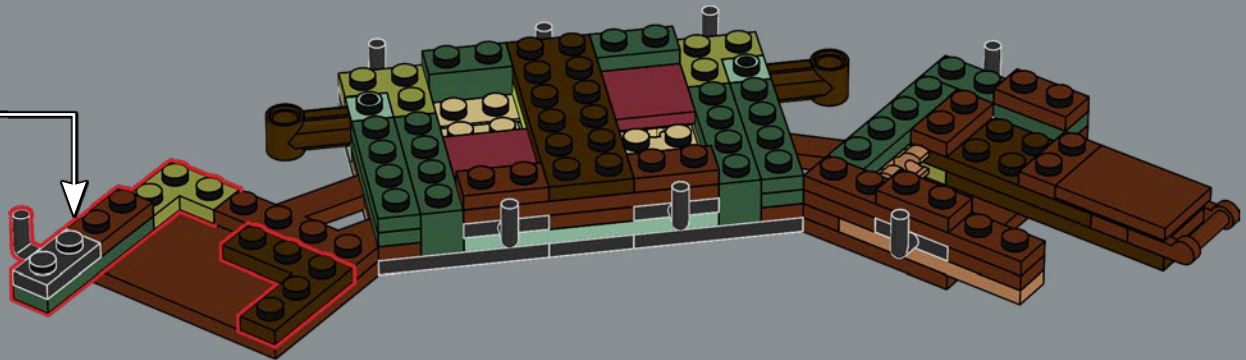
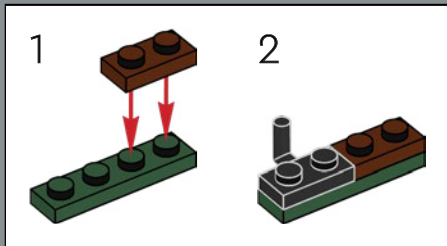

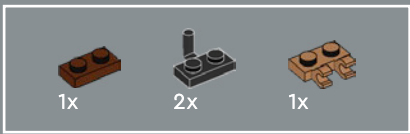

23

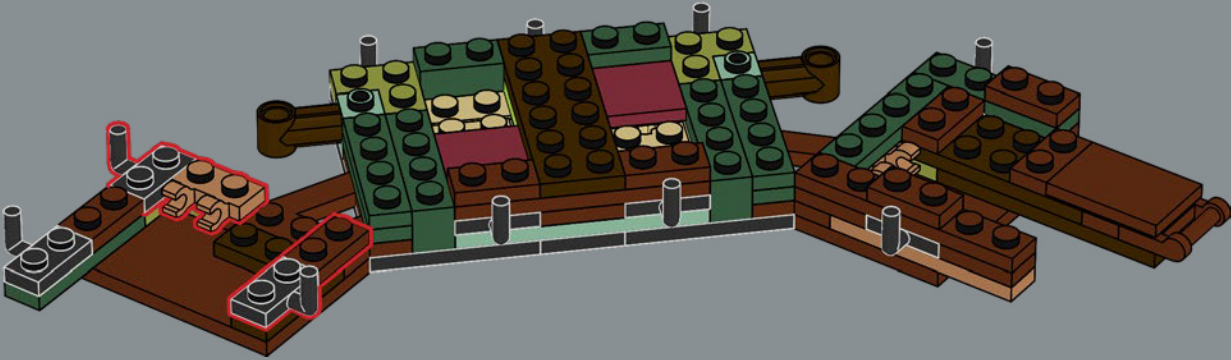

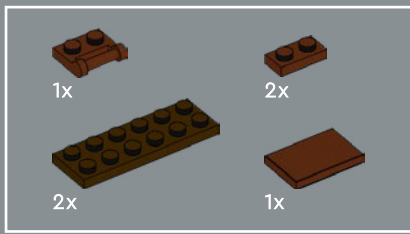

24

1

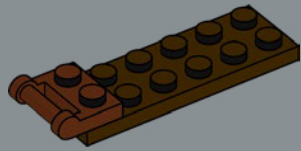

2

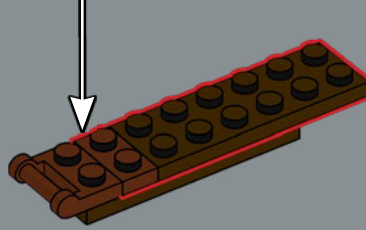

3

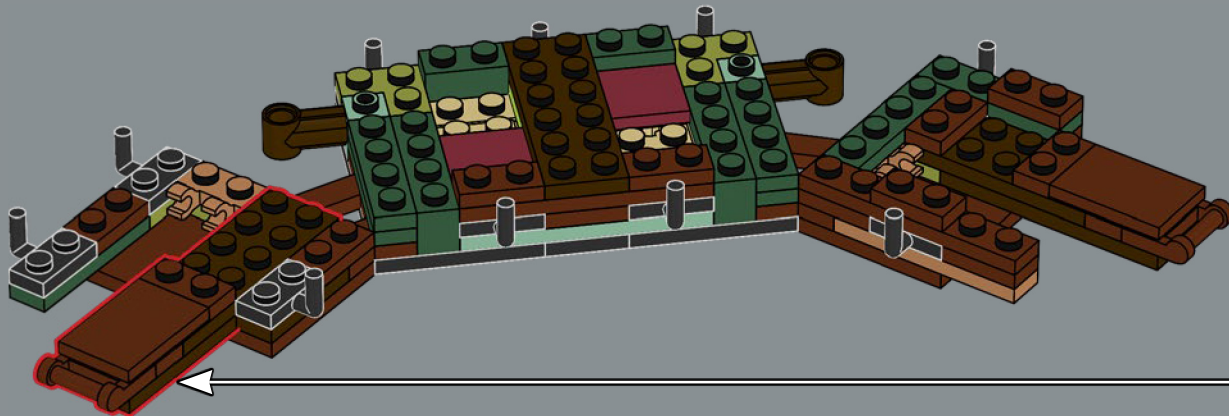
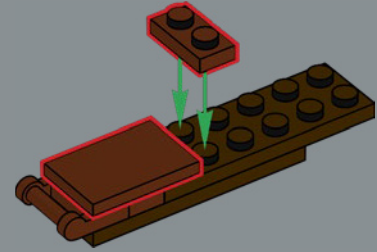

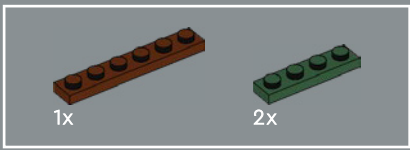

25

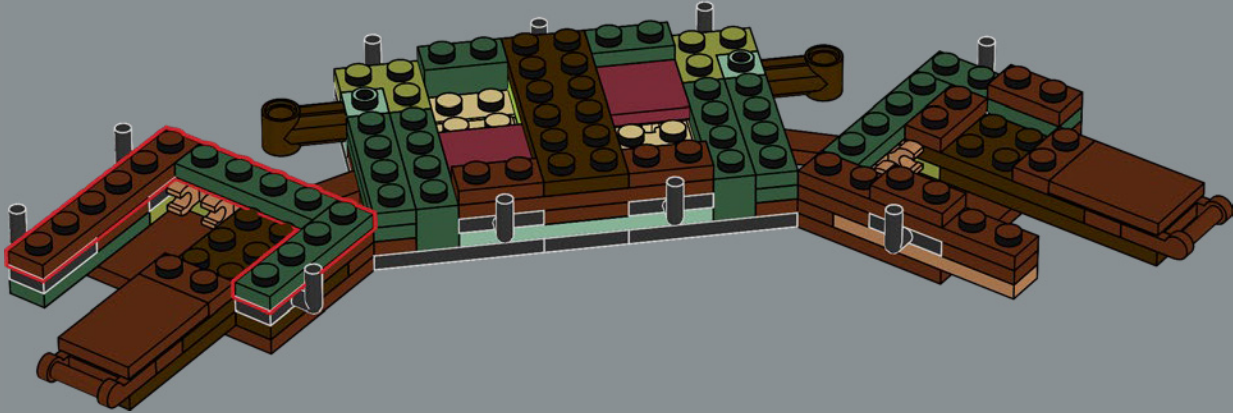

26



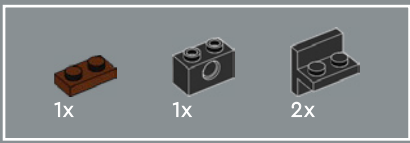

27

1

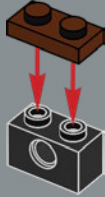

2

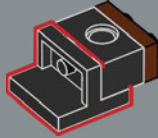

3

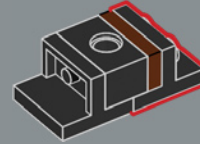

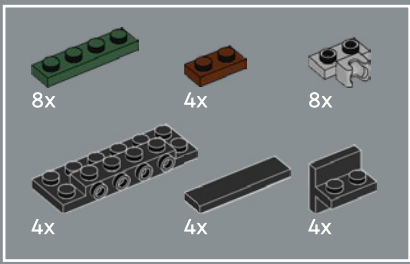

28

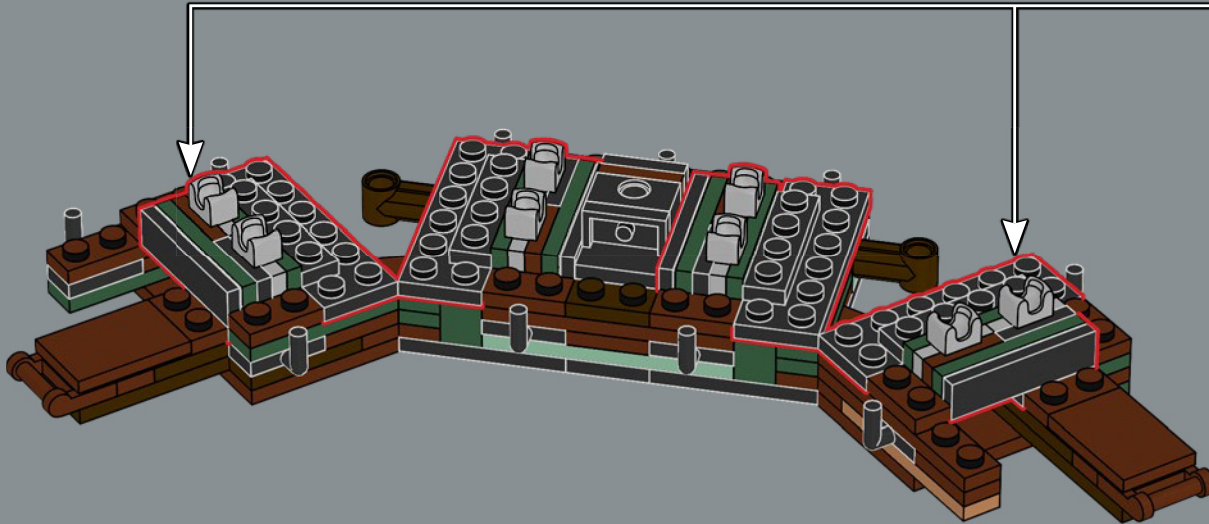
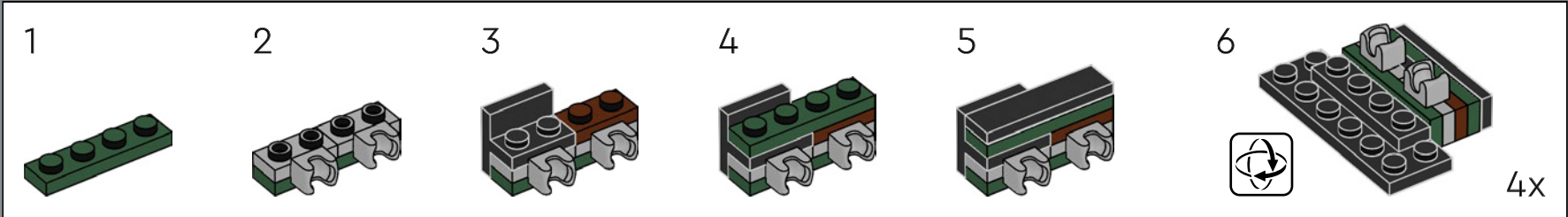



29

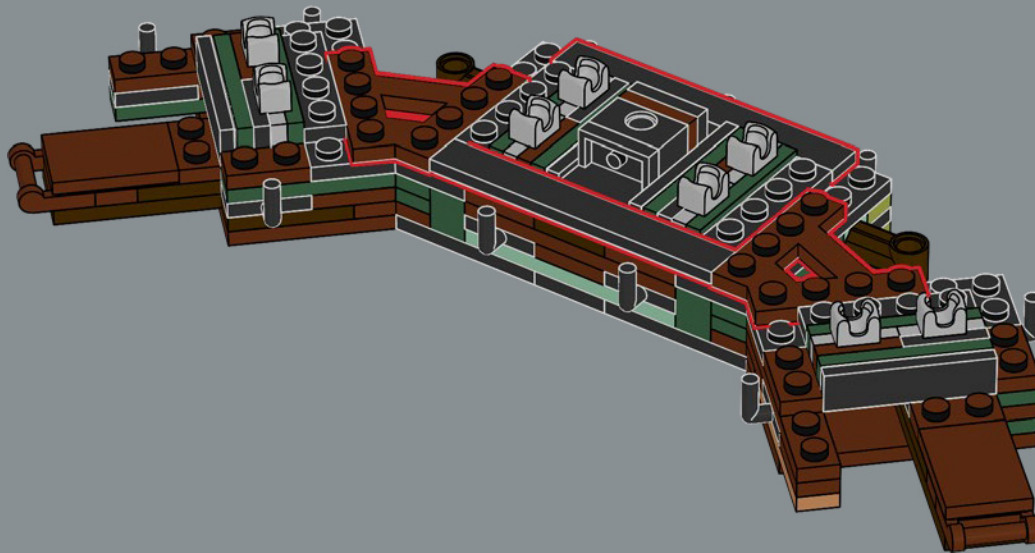

30

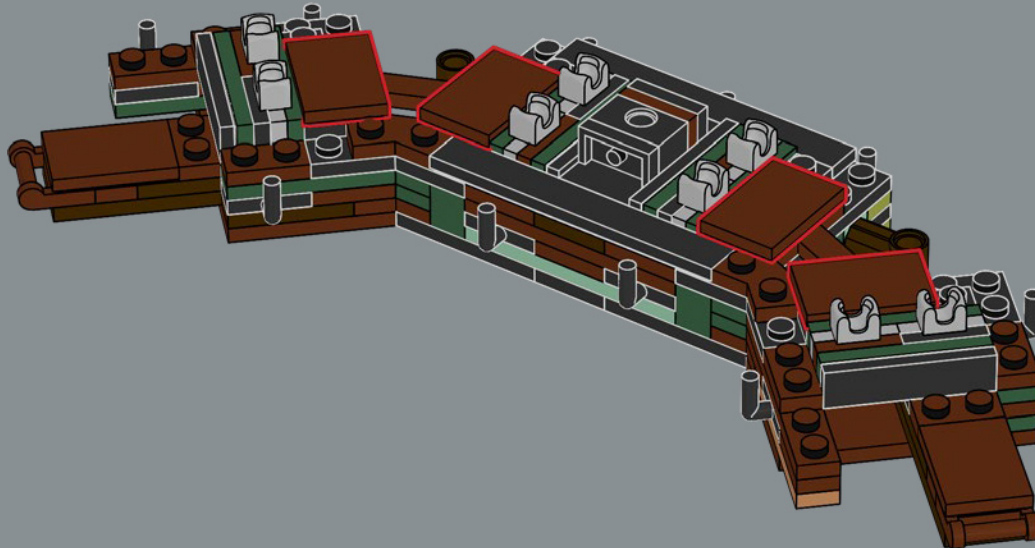

4x

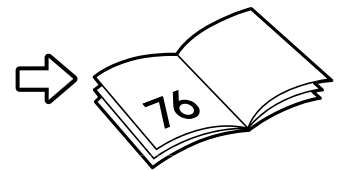
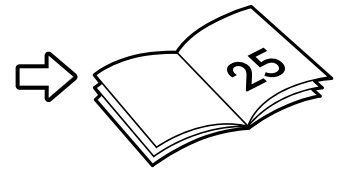





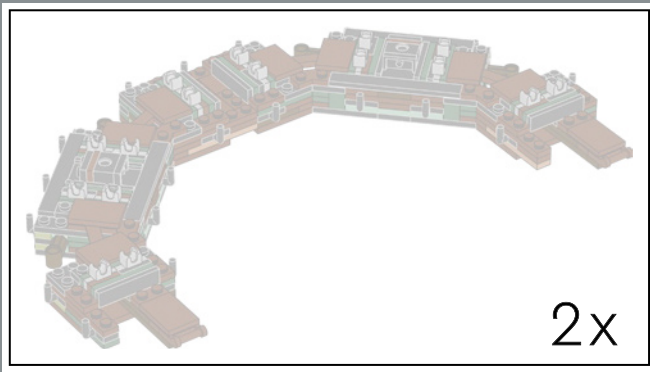

2x

31

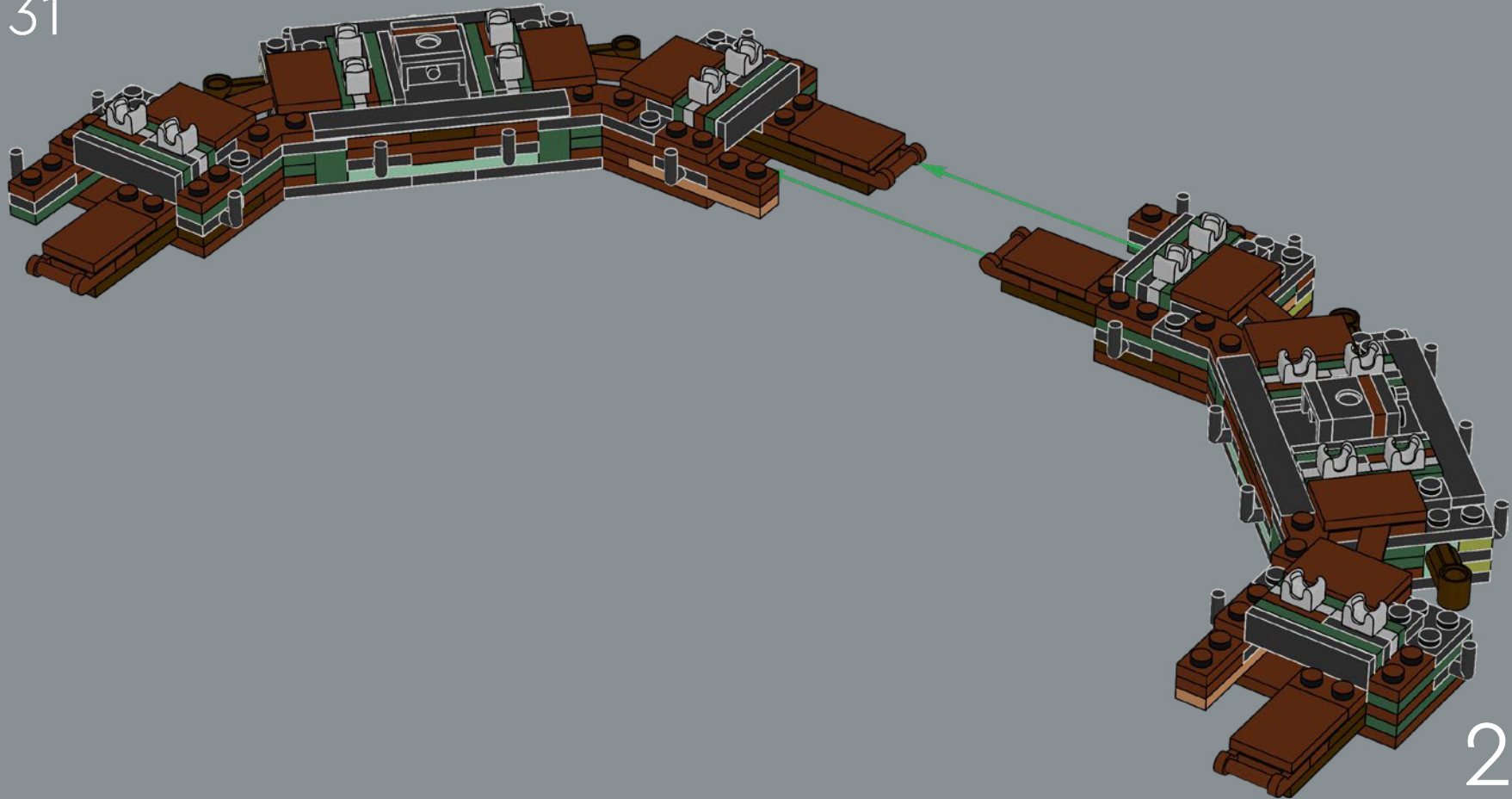

2x



32

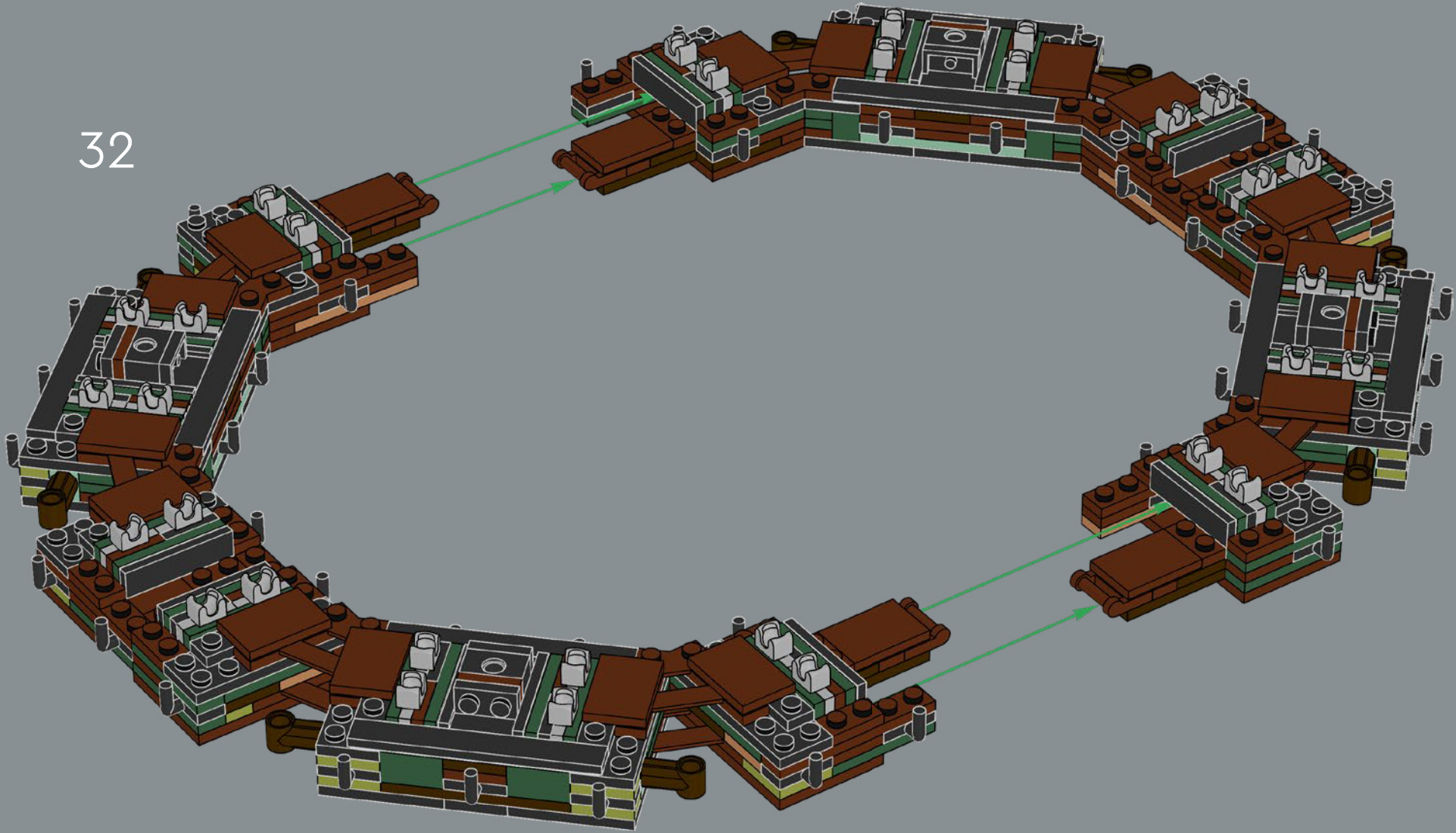



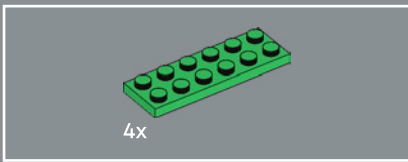

33



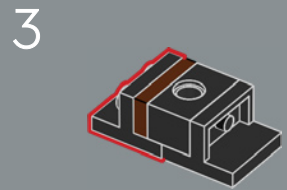
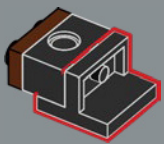
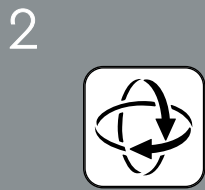
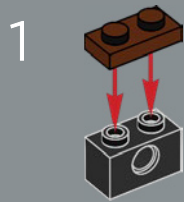
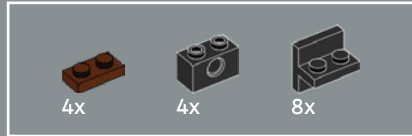
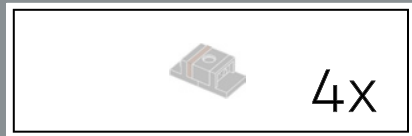

4x

34

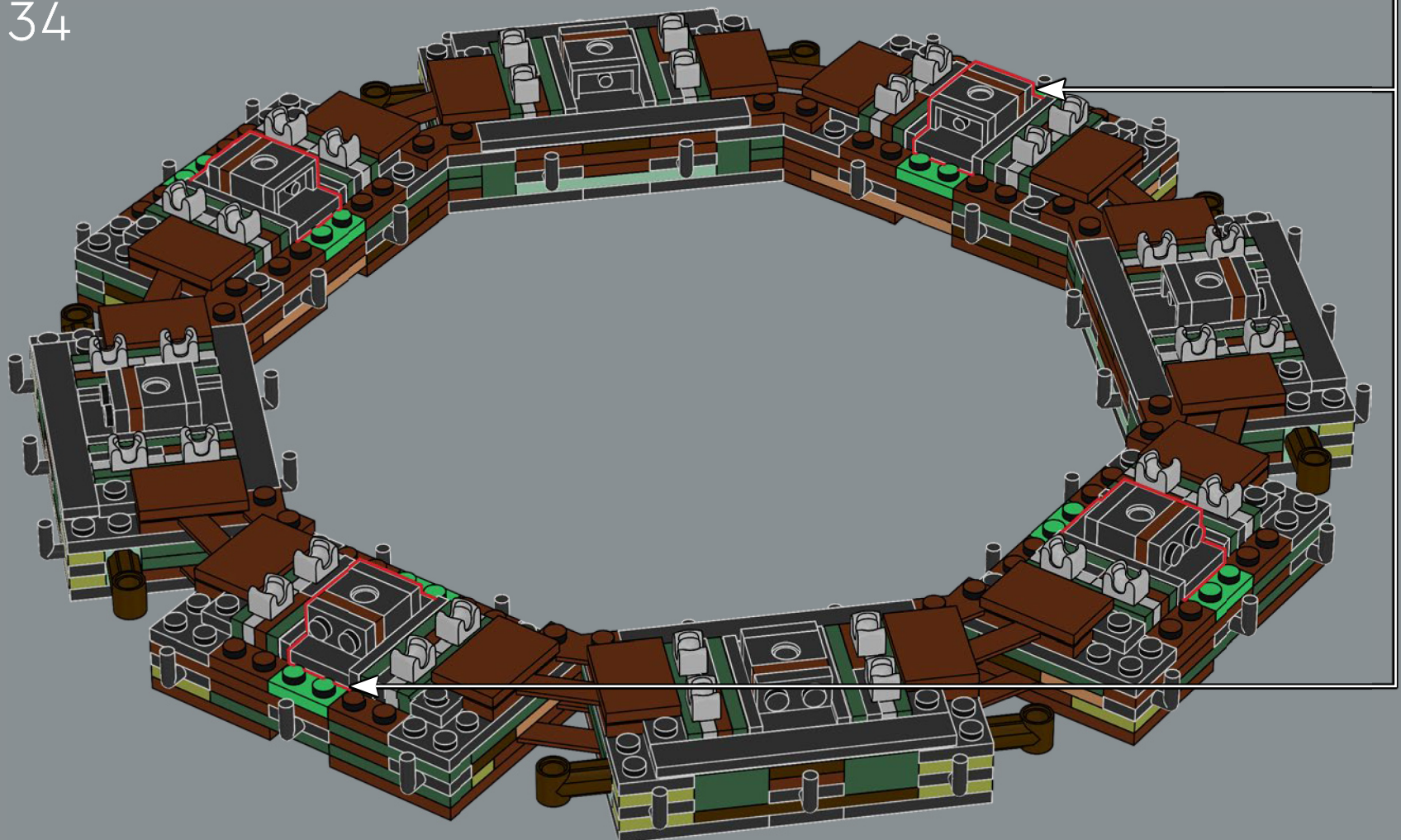

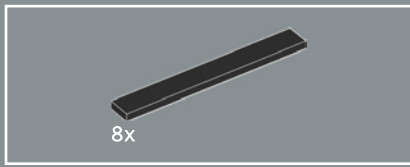

35

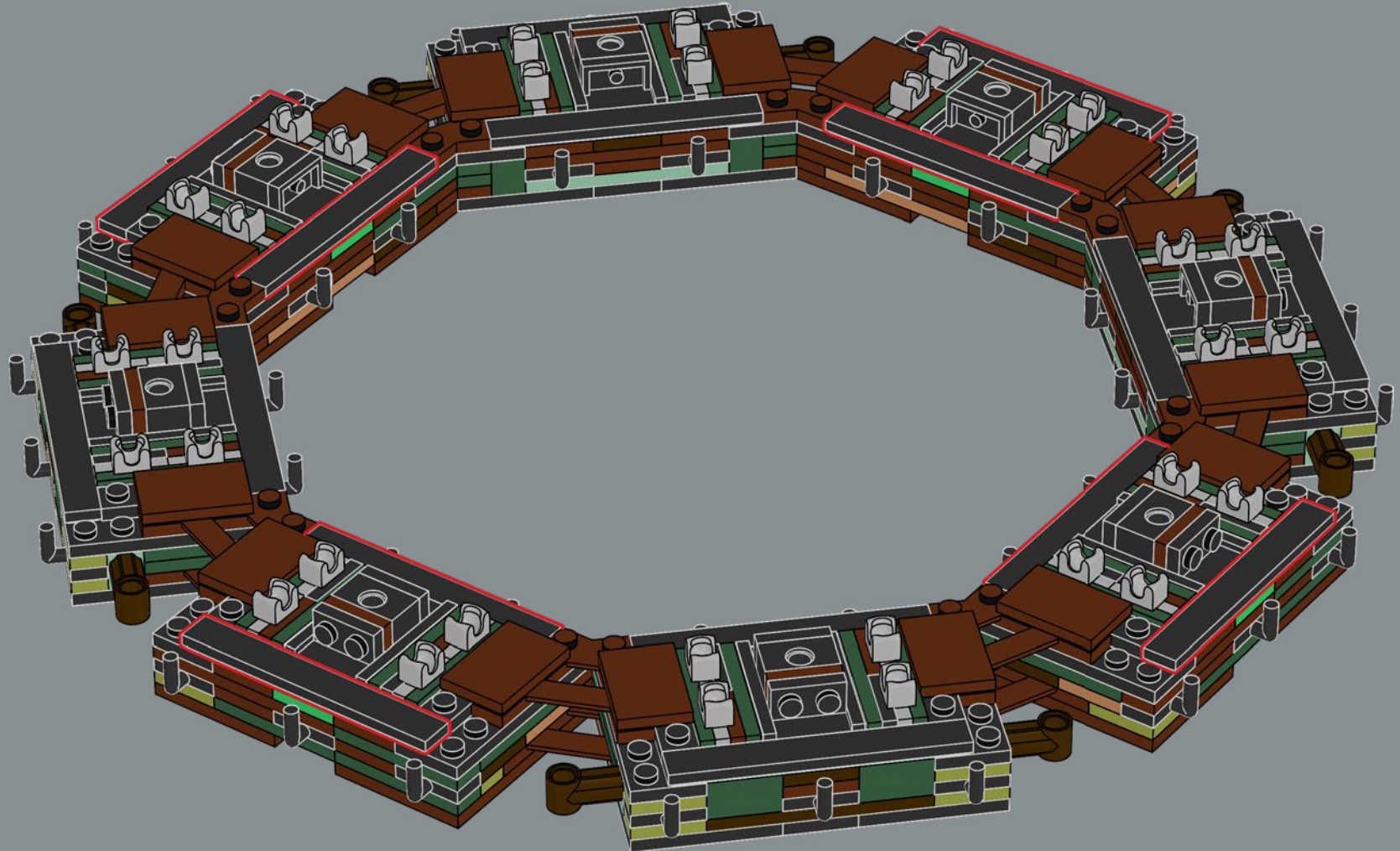

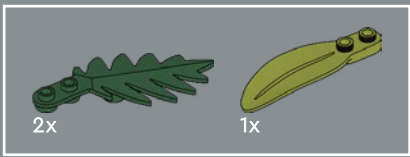

36





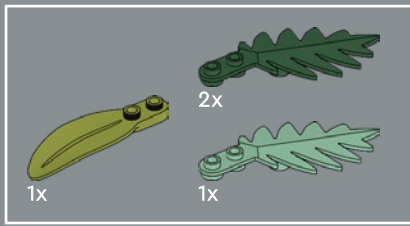

37



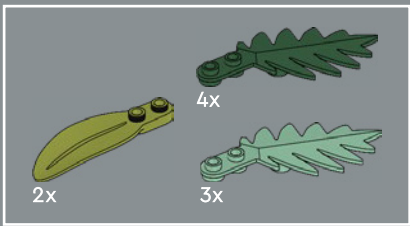

38





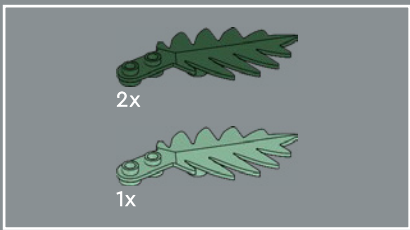

40



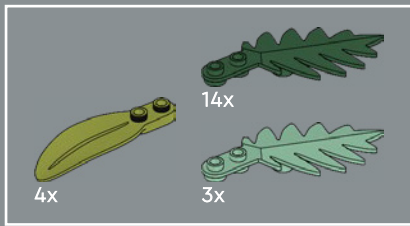

41





8x

42



8x





When connected in sequence, the LEGO® flower stem elements make for perfectly pointy pine needles.

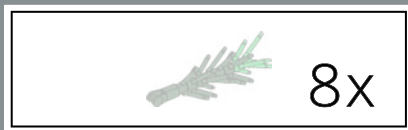

43

1

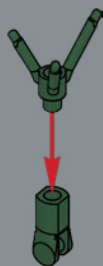

2

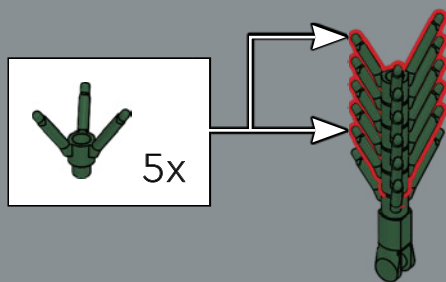

3



4

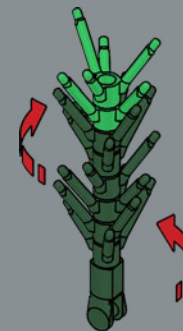

8x









The underside of Fraser fir needles has a blueish tint, represented here by sand-green palm leaf elements – a new colour for this classic LEGO® element, which first appeared in 1989.

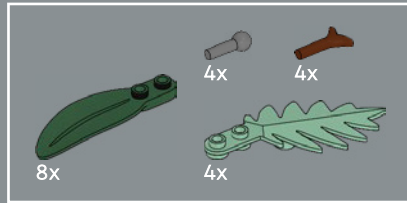
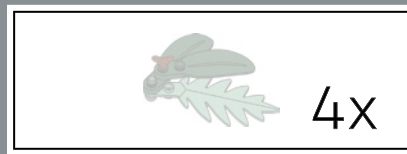

45

1

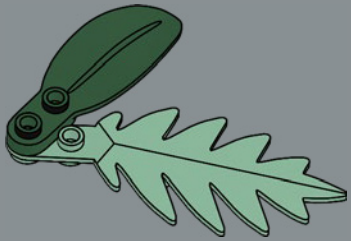

2

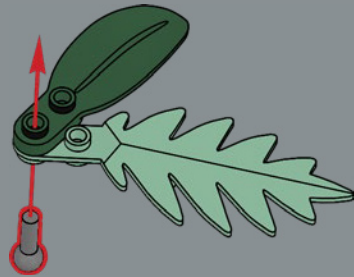

3

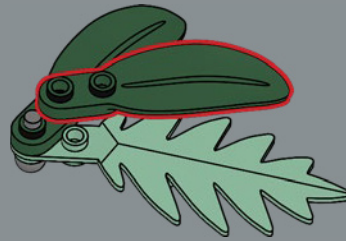

4

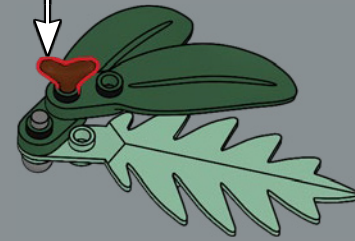

4x



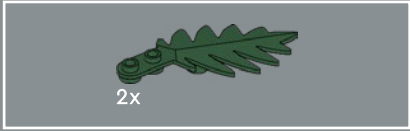
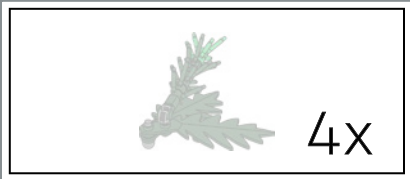

46

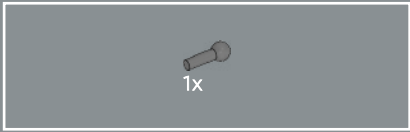
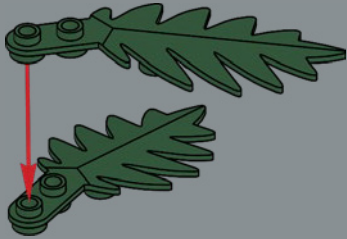

47



48

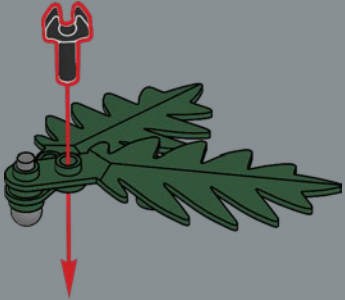



49

1

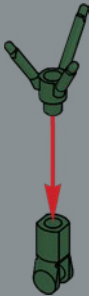

2

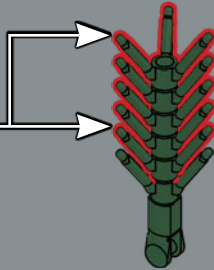
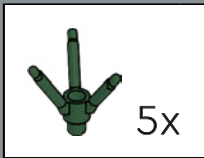

3



4

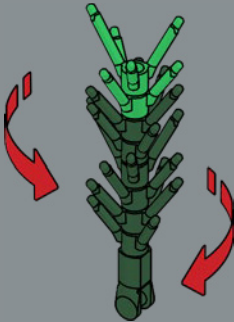



4x







Some species of magnolia are evergreen, making their leaves perfect for year-round arrangements.

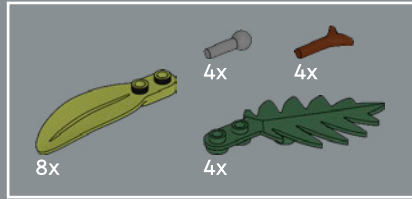

51

1

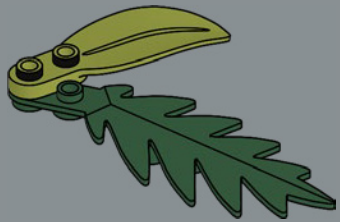

2

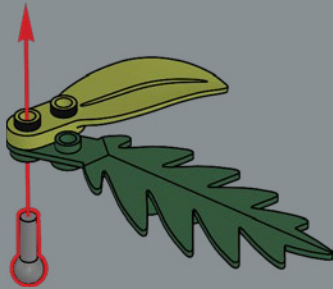

3

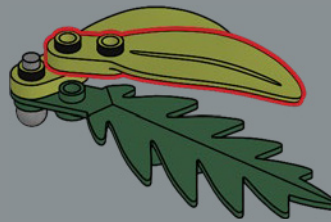

4

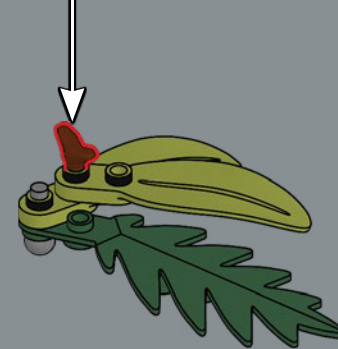
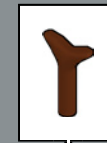

4x







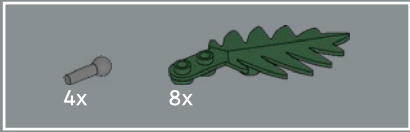
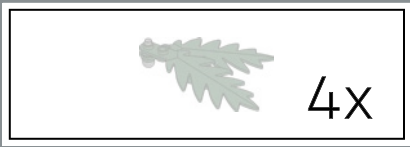

52

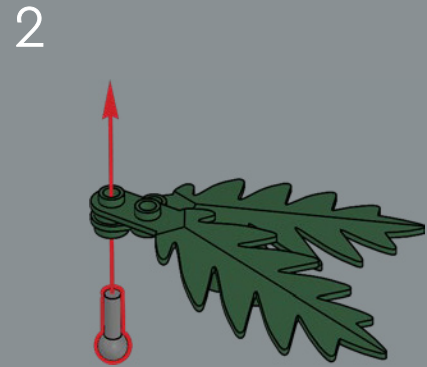
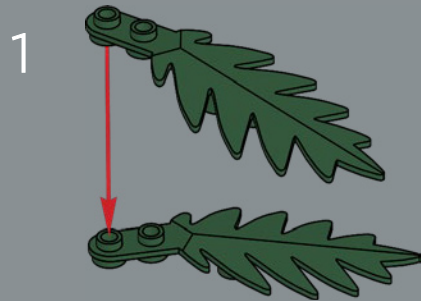

4x





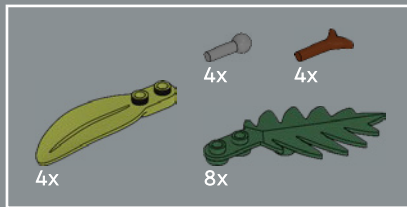
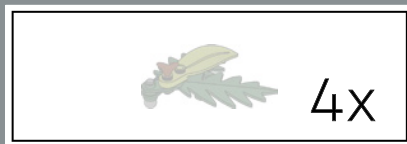

53

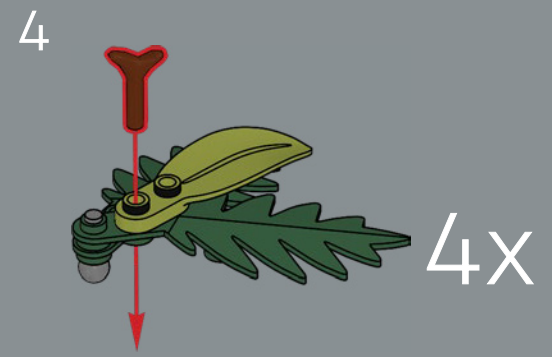
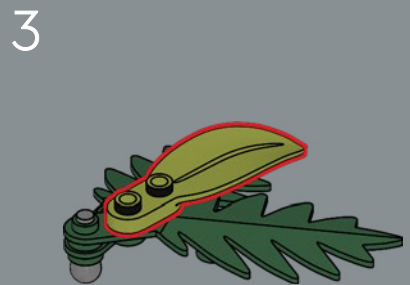
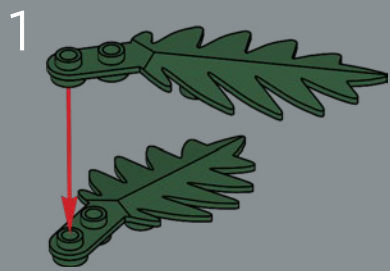



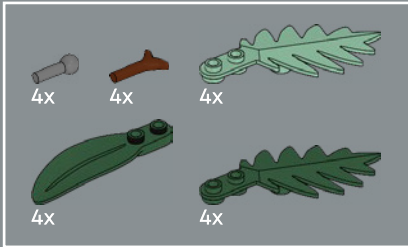

54

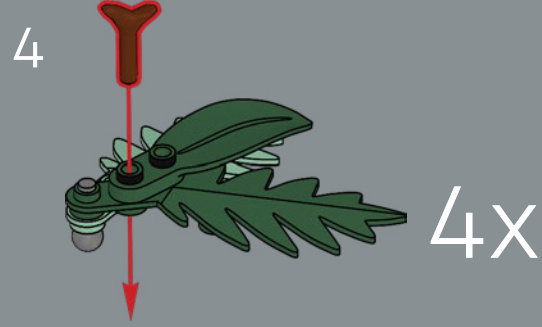
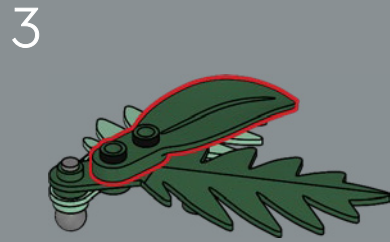
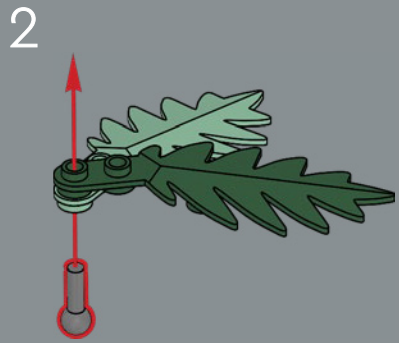





55

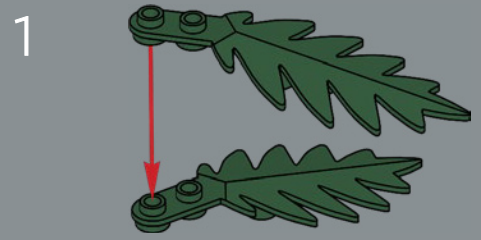









56

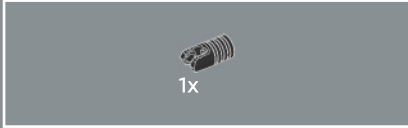

57

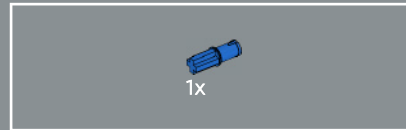

58



59



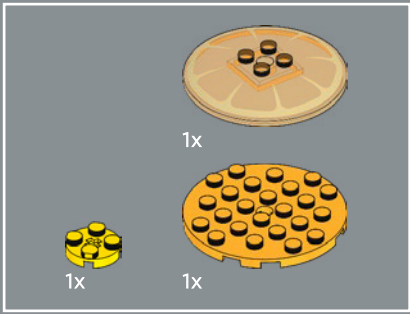

60

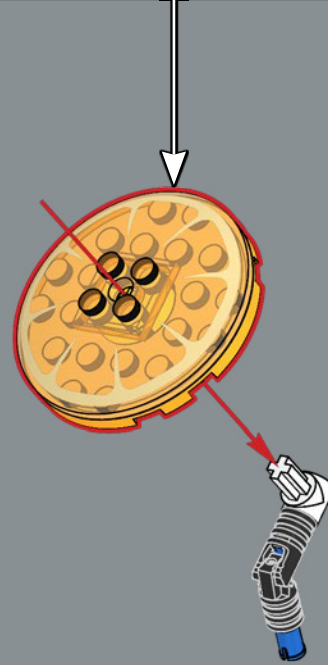
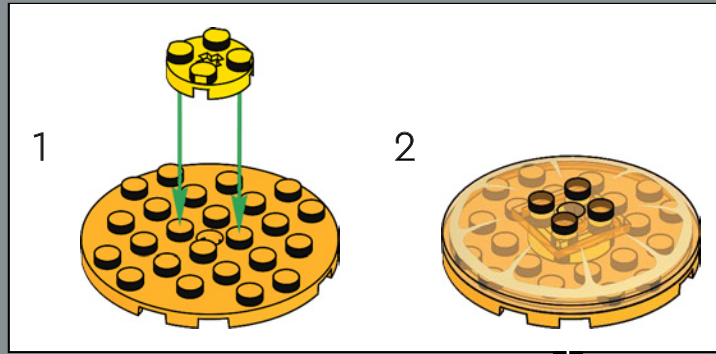

Printed transparent orange satellite dish elements replicate the translucent quality of dried orange slices.



61

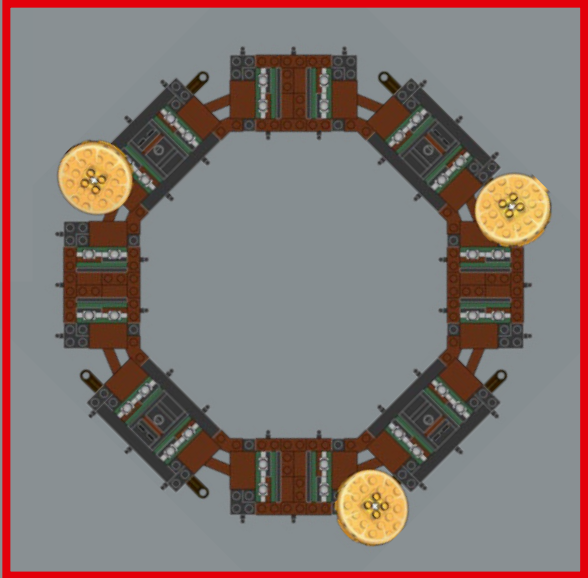



62



63

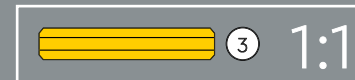
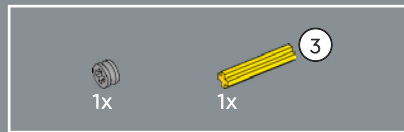

64



65

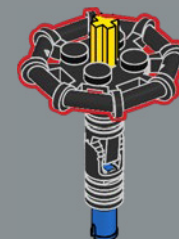



66



67

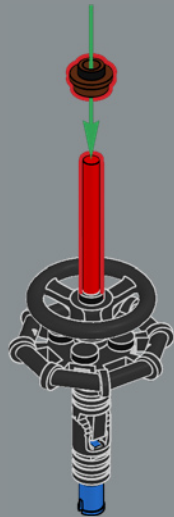

68

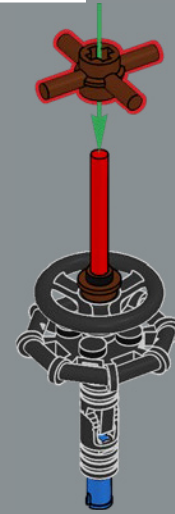

69

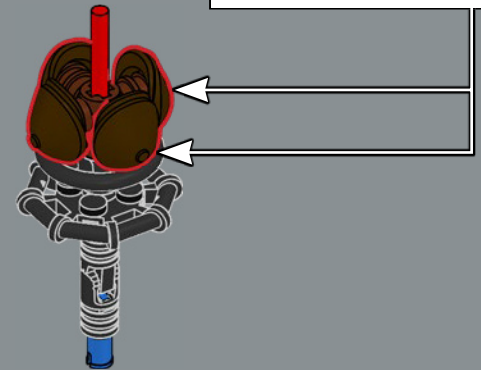
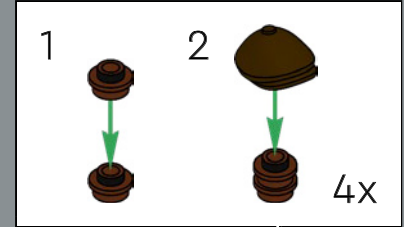



70

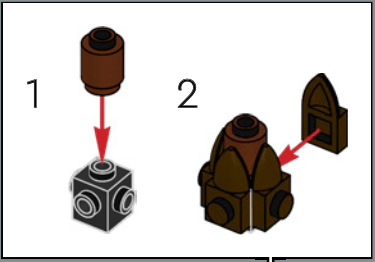

71

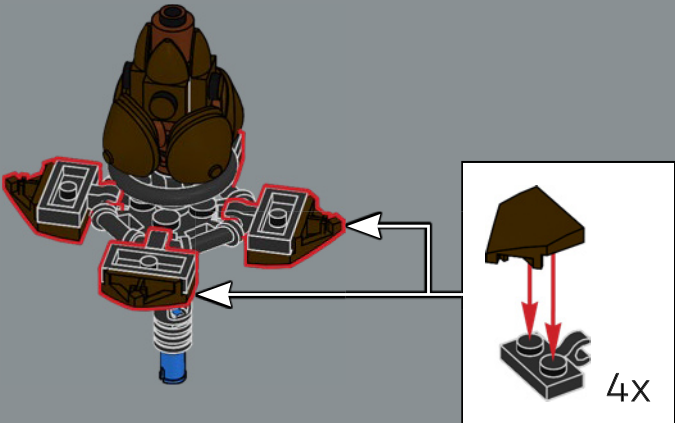

72

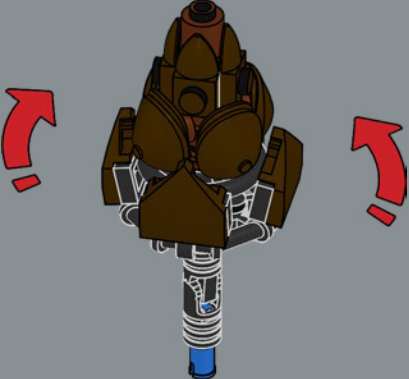

3x





73

The pine cone of the Scots pine (or Scotch pine) has scales that feature a small protuberance resembling the button on the top of a newspaper kid's cap.



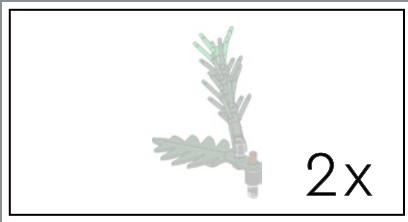

74



75

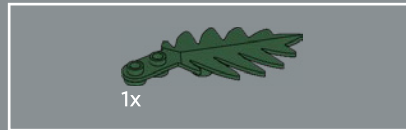

76

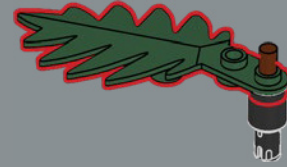

77

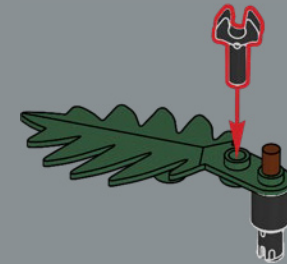



78

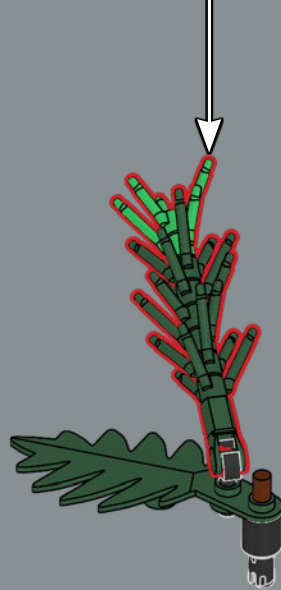
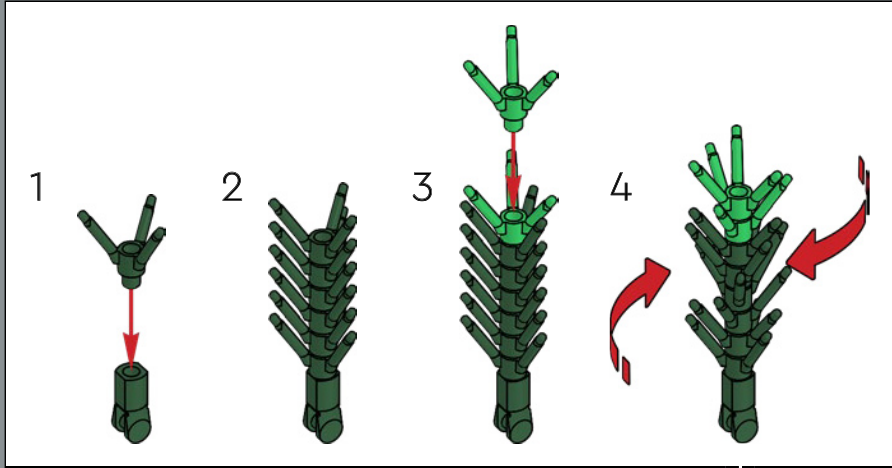

2x





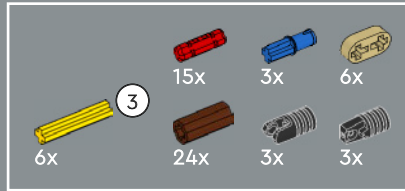
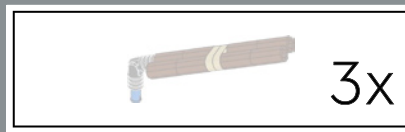

80

1



2



3



4





A cinnamon stick comes from the dried inner bark of a cinnamon tree. In ancient times, the spice was considered more valuable than gold.

5



6

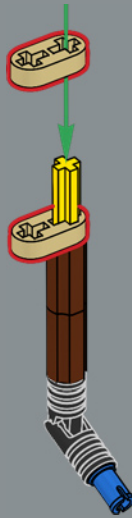

7

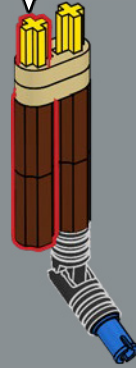

8



3x

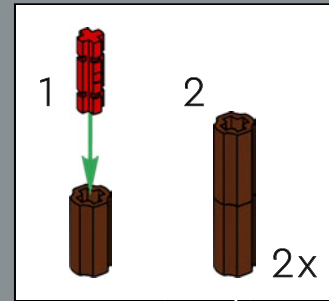
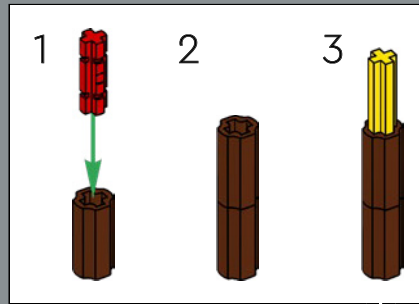







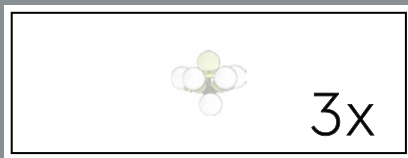

3x



82

1



2

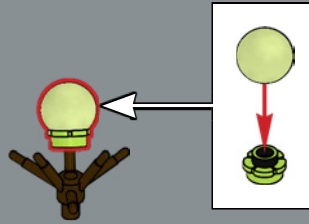

3

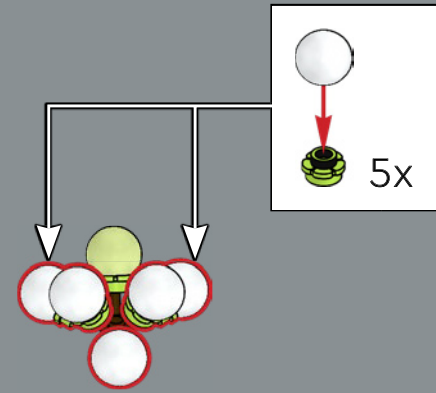

3x

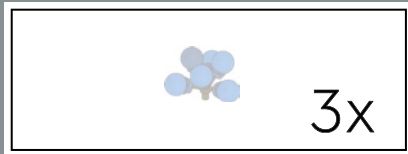

3x

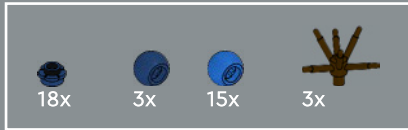

83

1



2

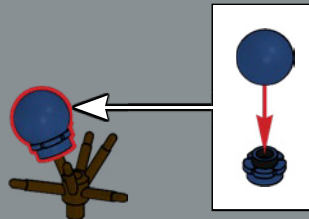

3

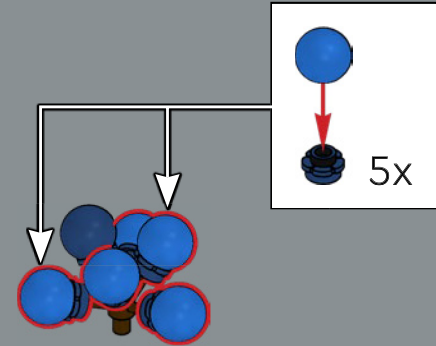

3x

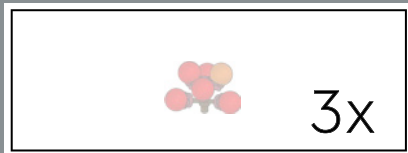

3x



84

1



2

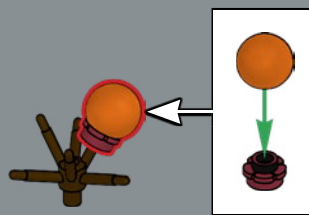

3

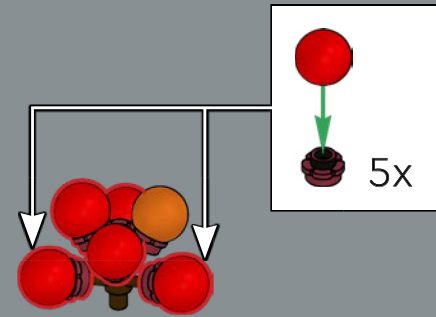

3x

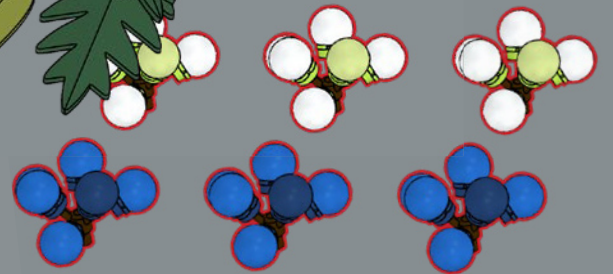
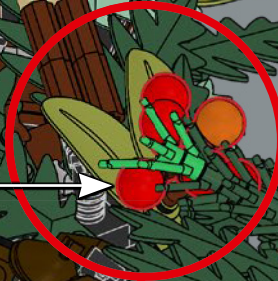
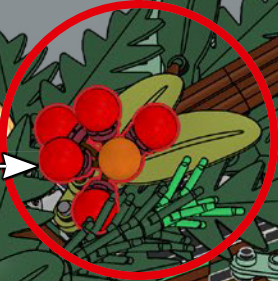
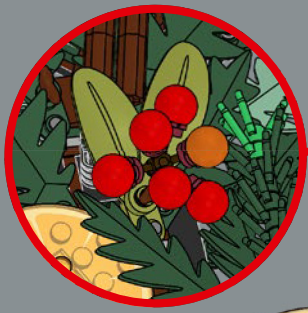



Vibrant red winterberries provide an important food source for birds in the winter season.





31

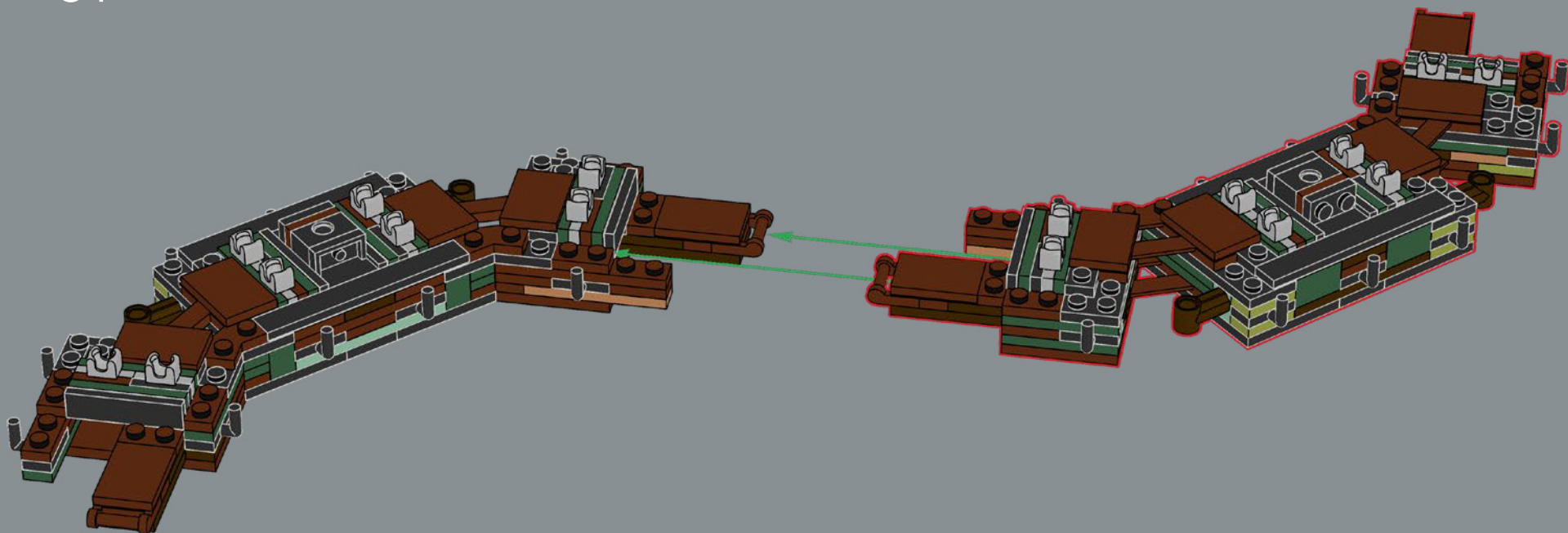

32

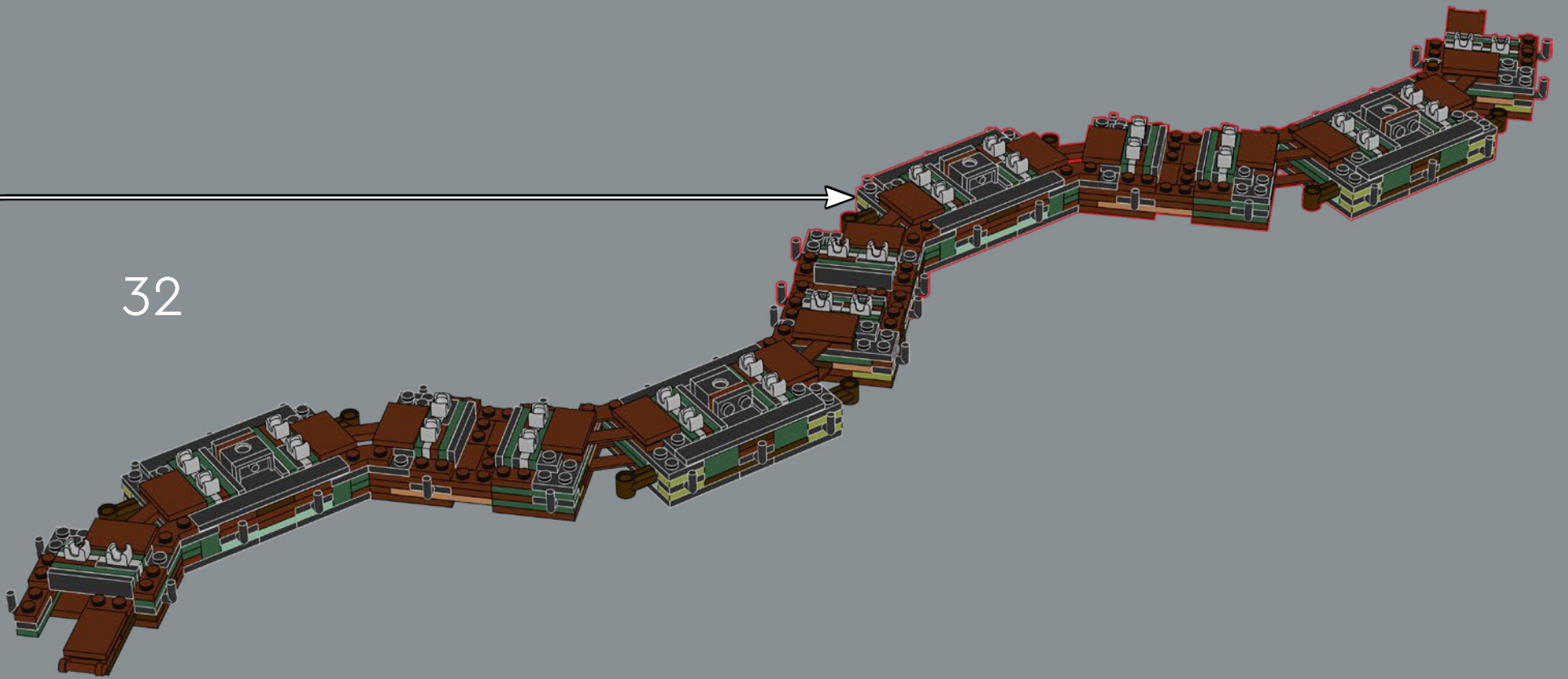

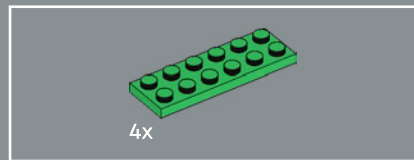

33



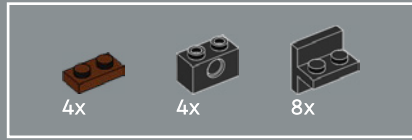
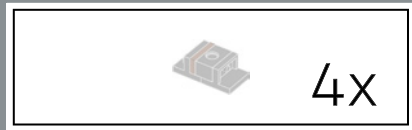

34

1

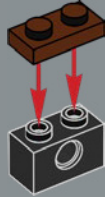

2

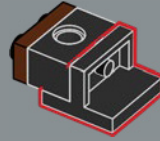

3

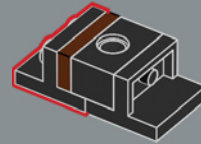

4x





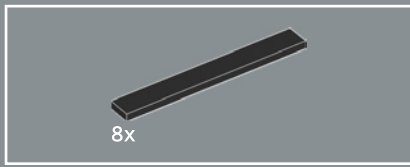

35

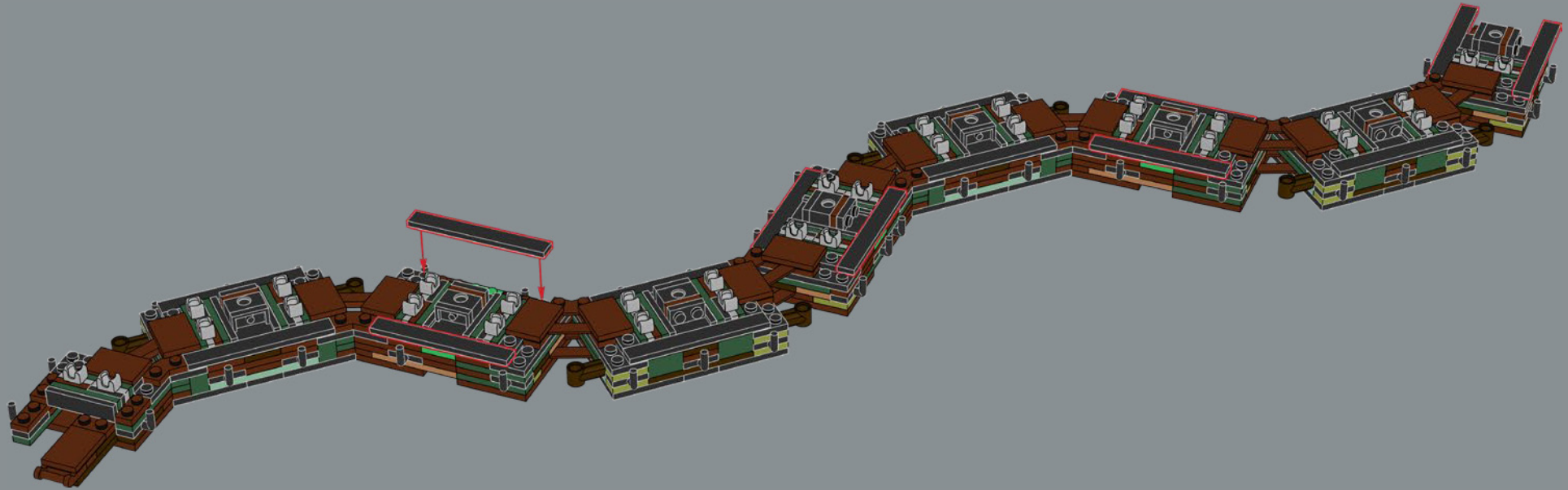

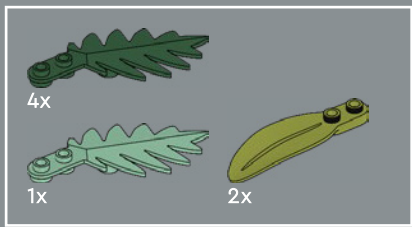

36

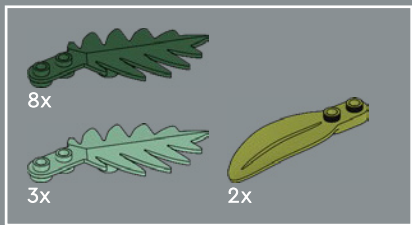
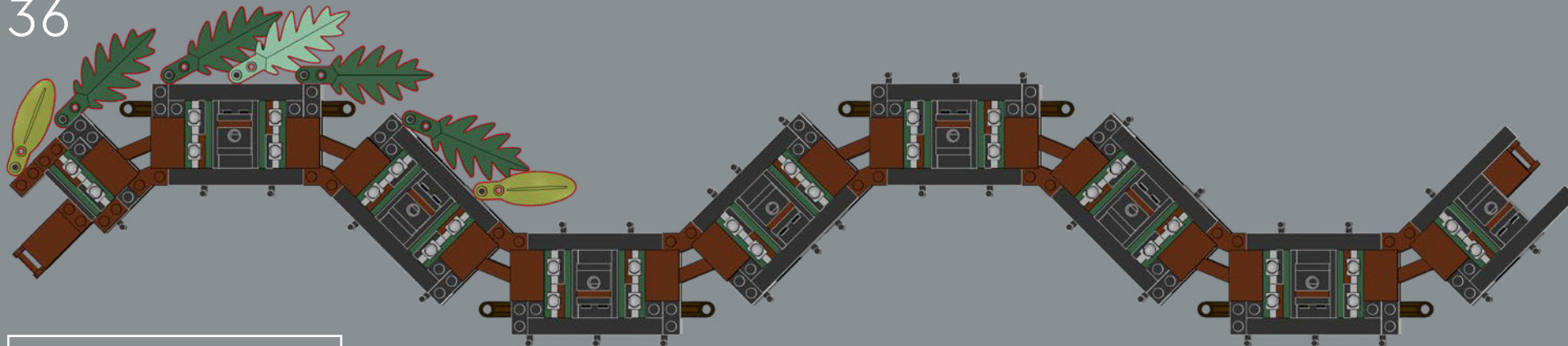

37

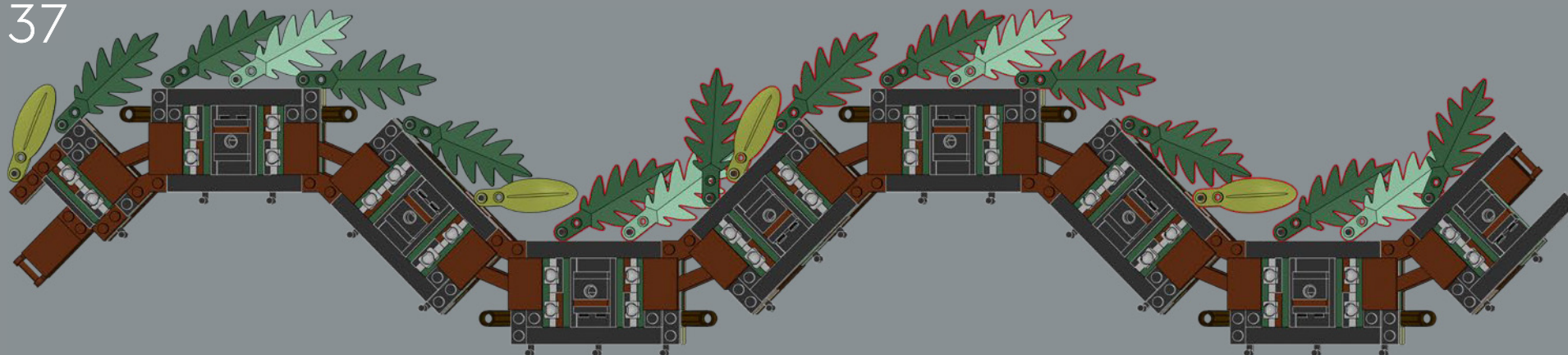

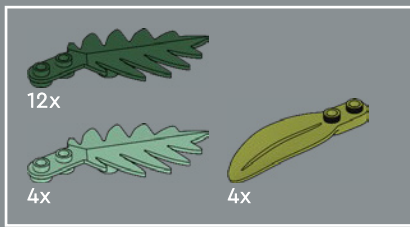

38





8x

39

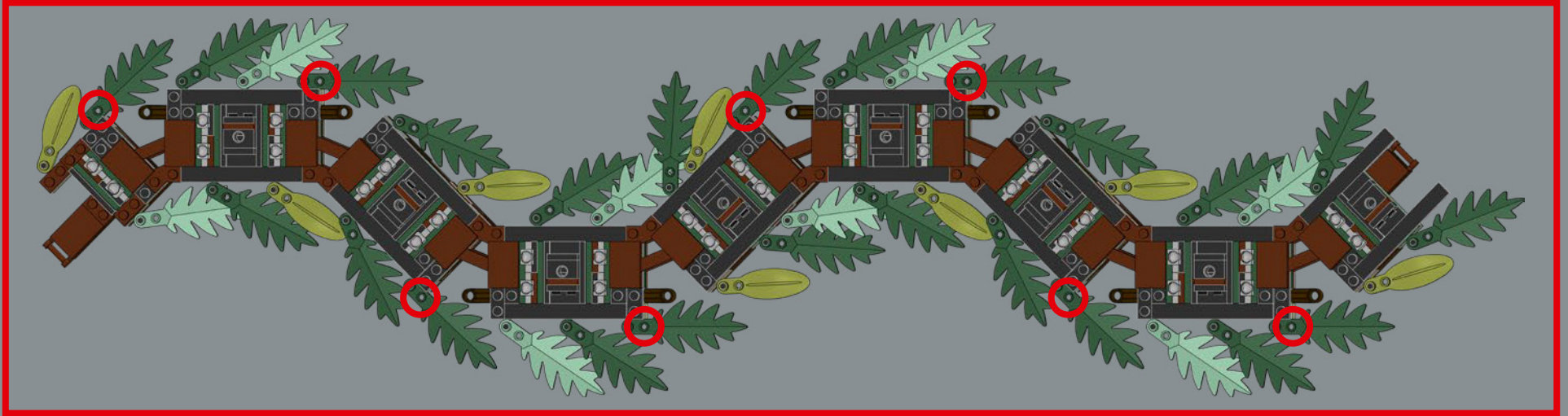

8x



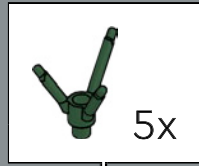
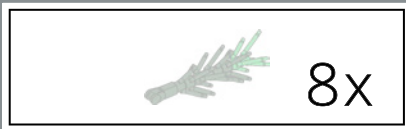

40

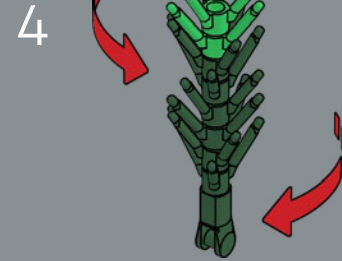
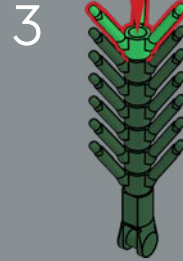
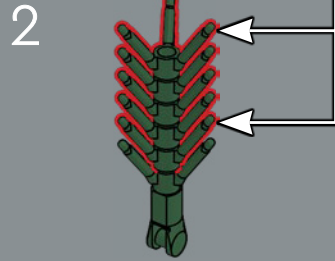
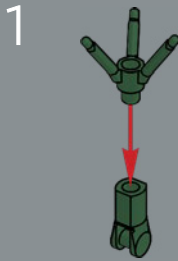

8x



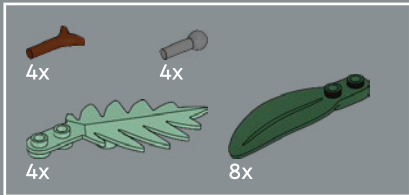

41

1

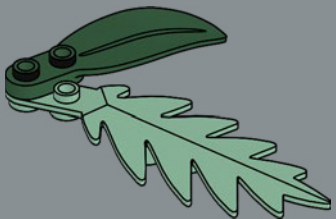

2

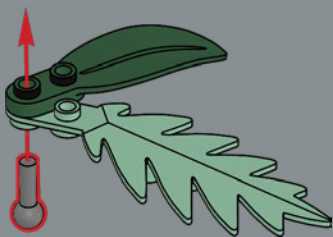

3

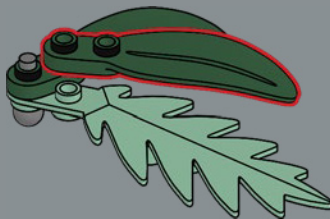

4

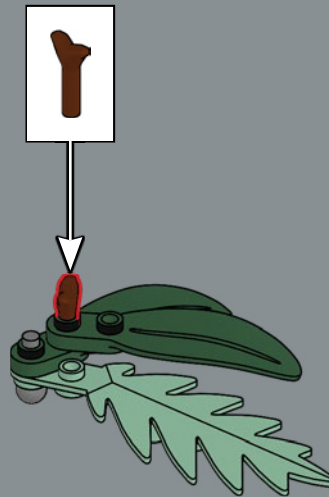

4x

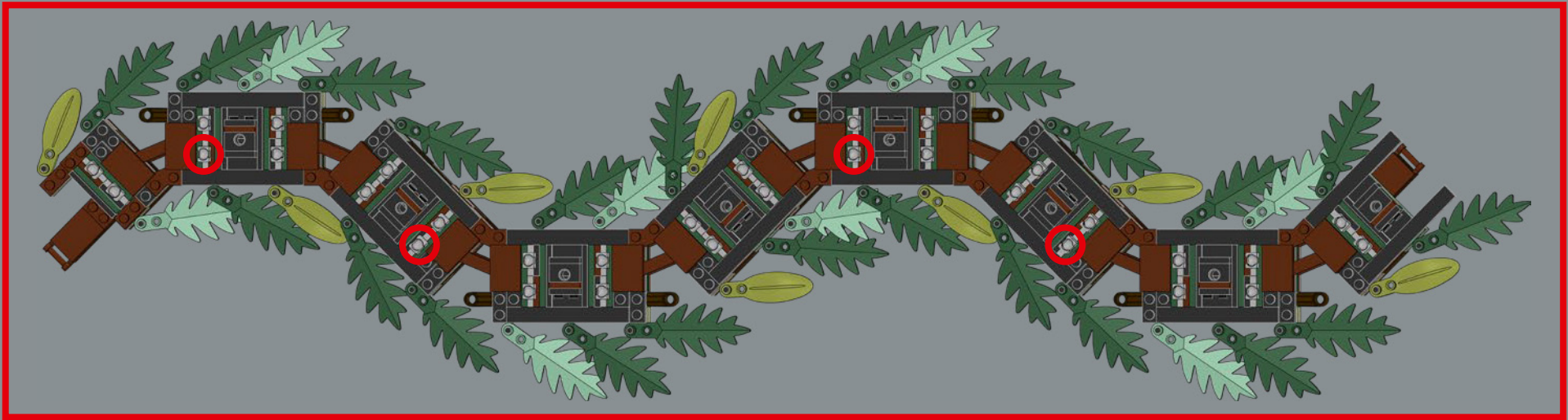

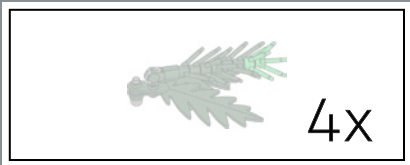

42

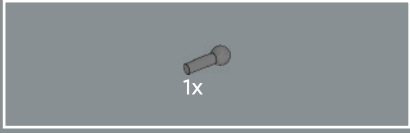
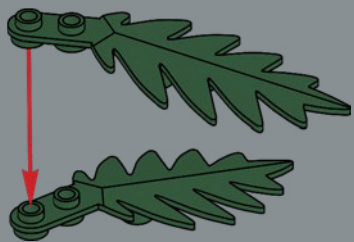

43

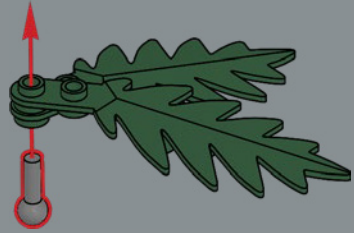

44

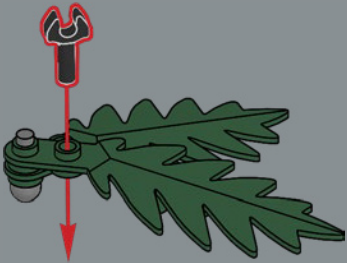





45

1

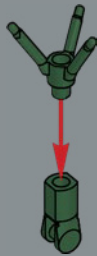

2

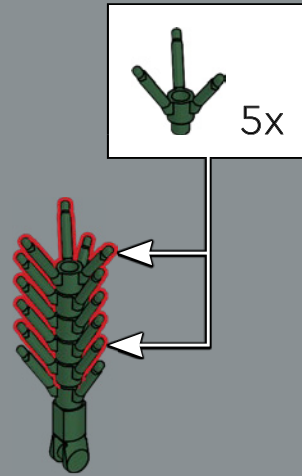

3



4

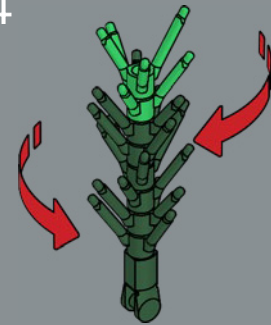

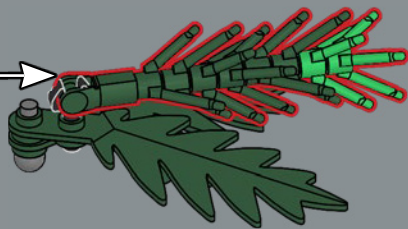

4x

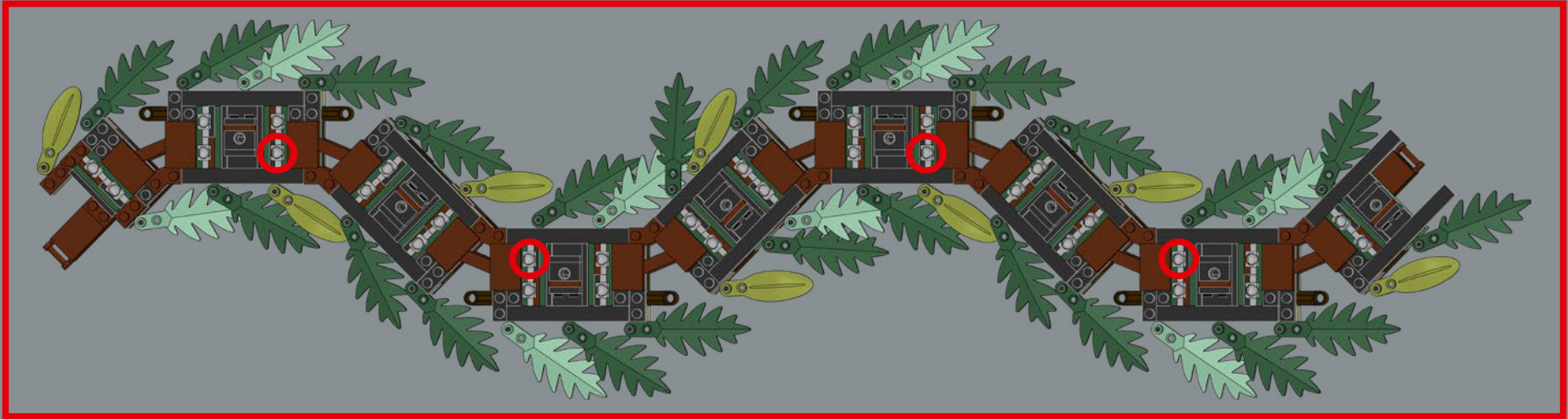

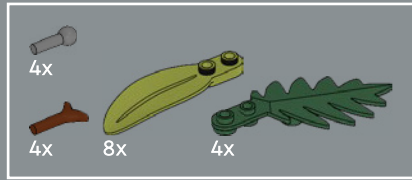
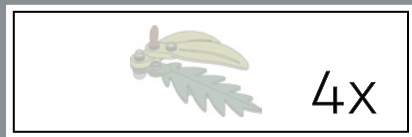

47

1

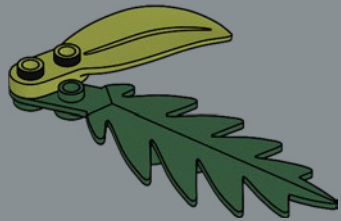

2

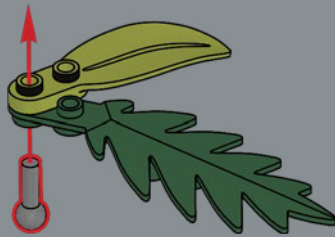

3

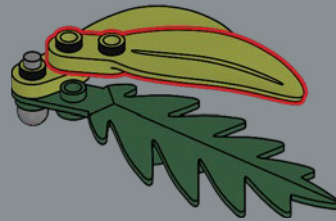

4

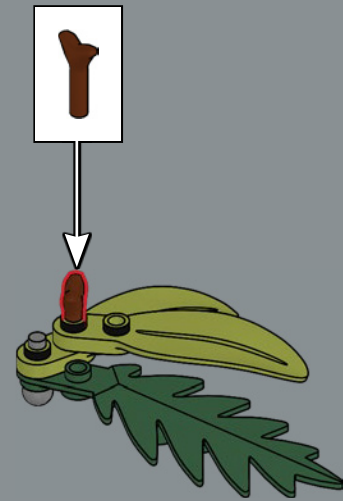

4x

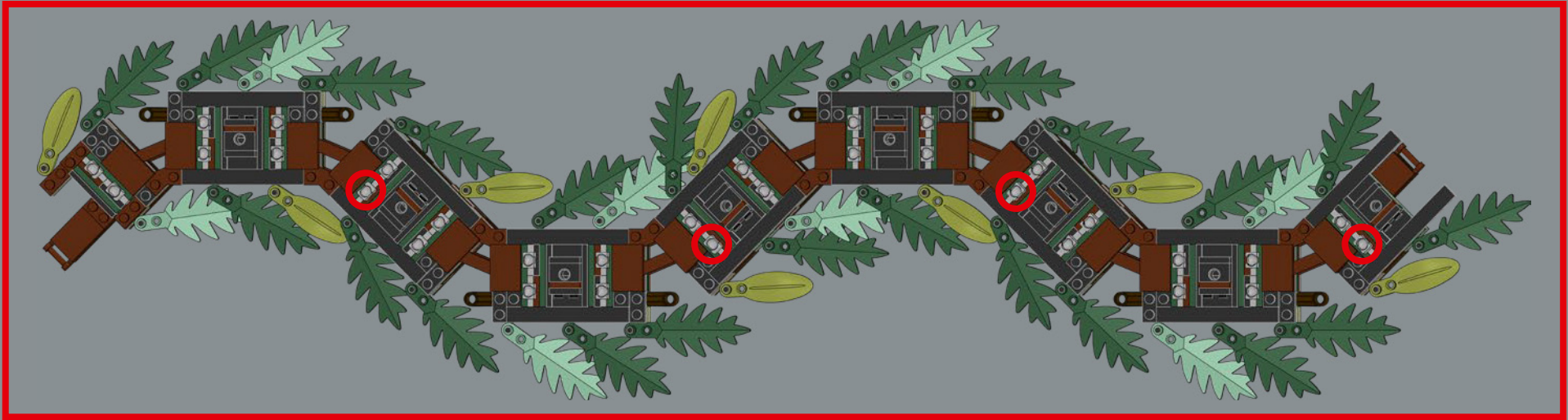

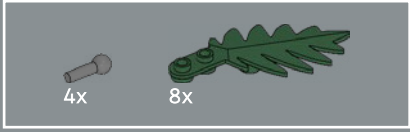
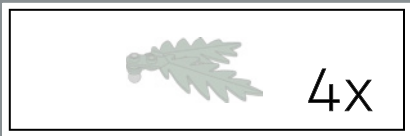

48

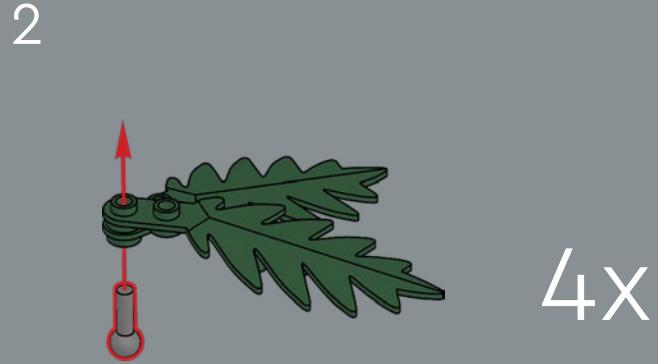
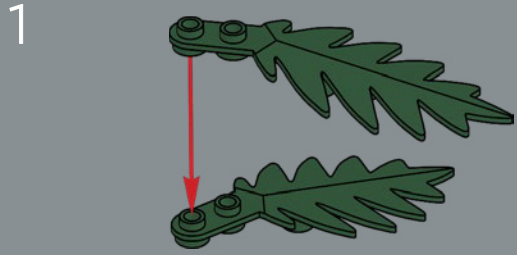

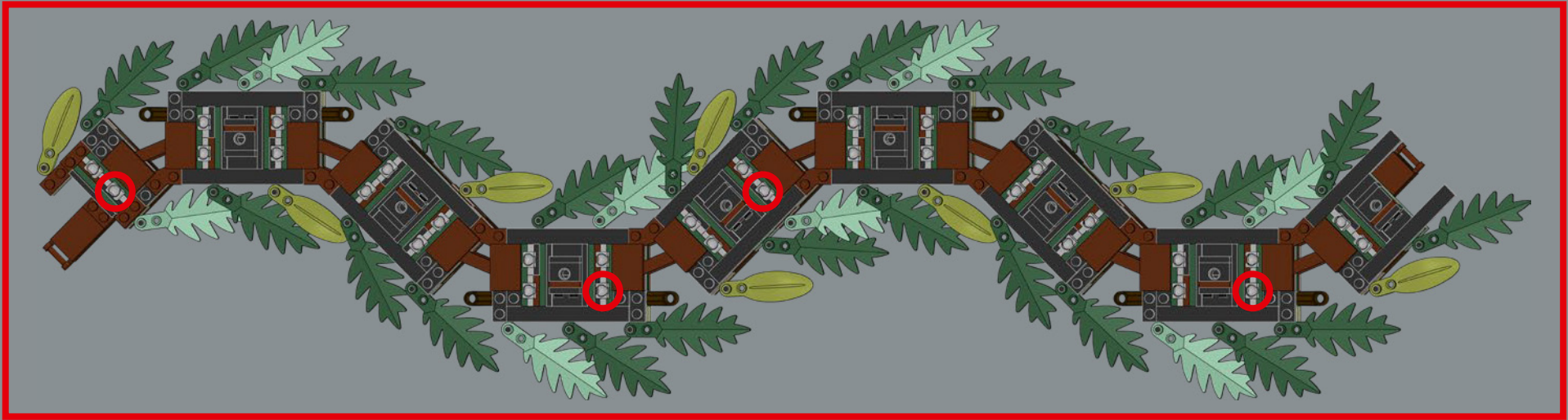

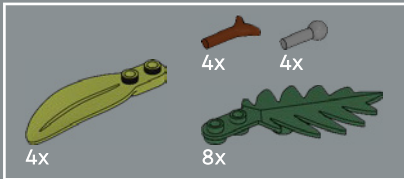

49

1

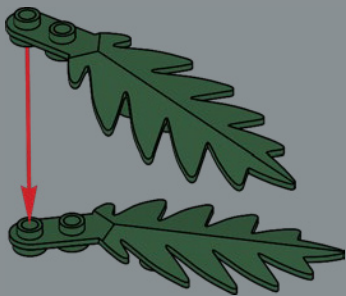

2

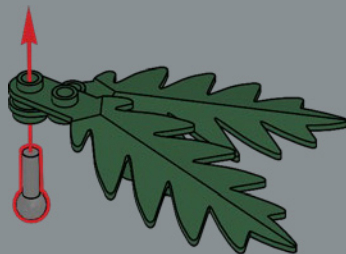

3

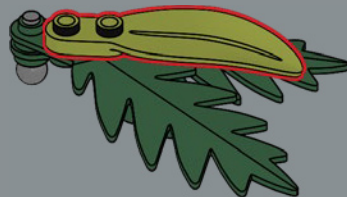

4

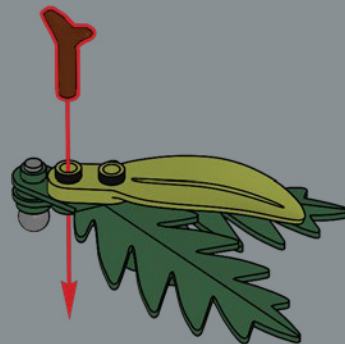

4x



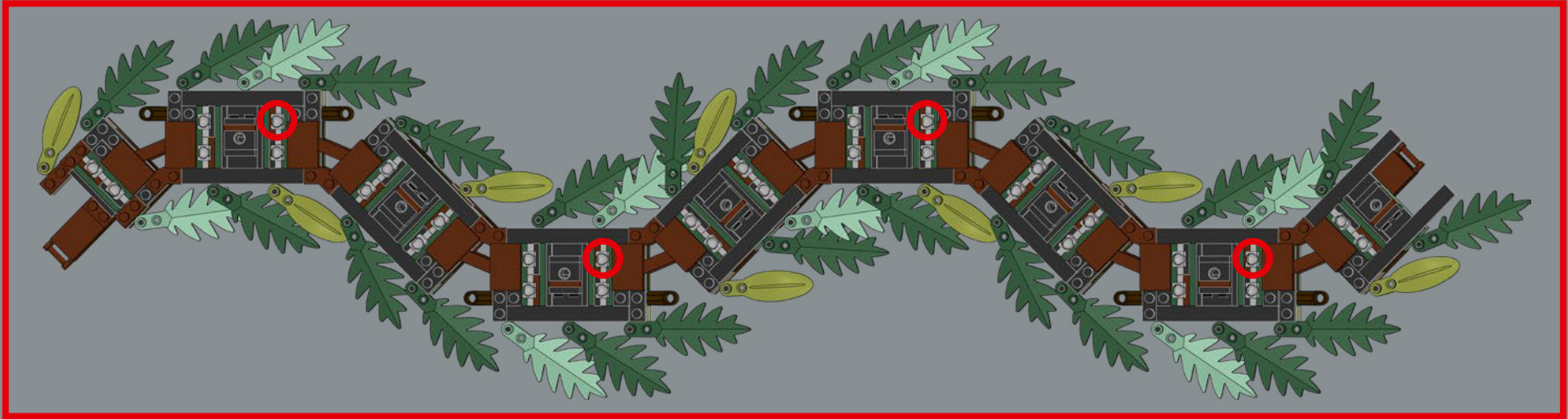

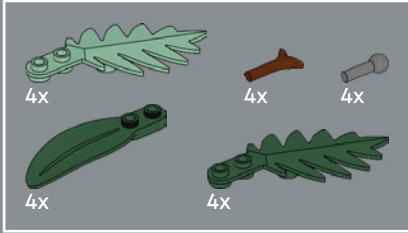
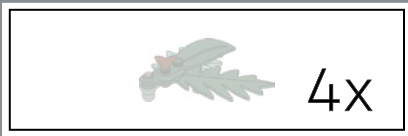

50

1



2

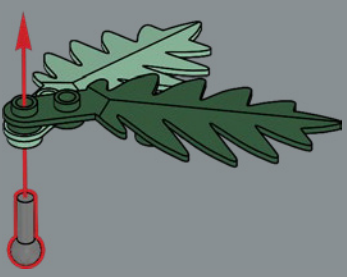

3



4



4x

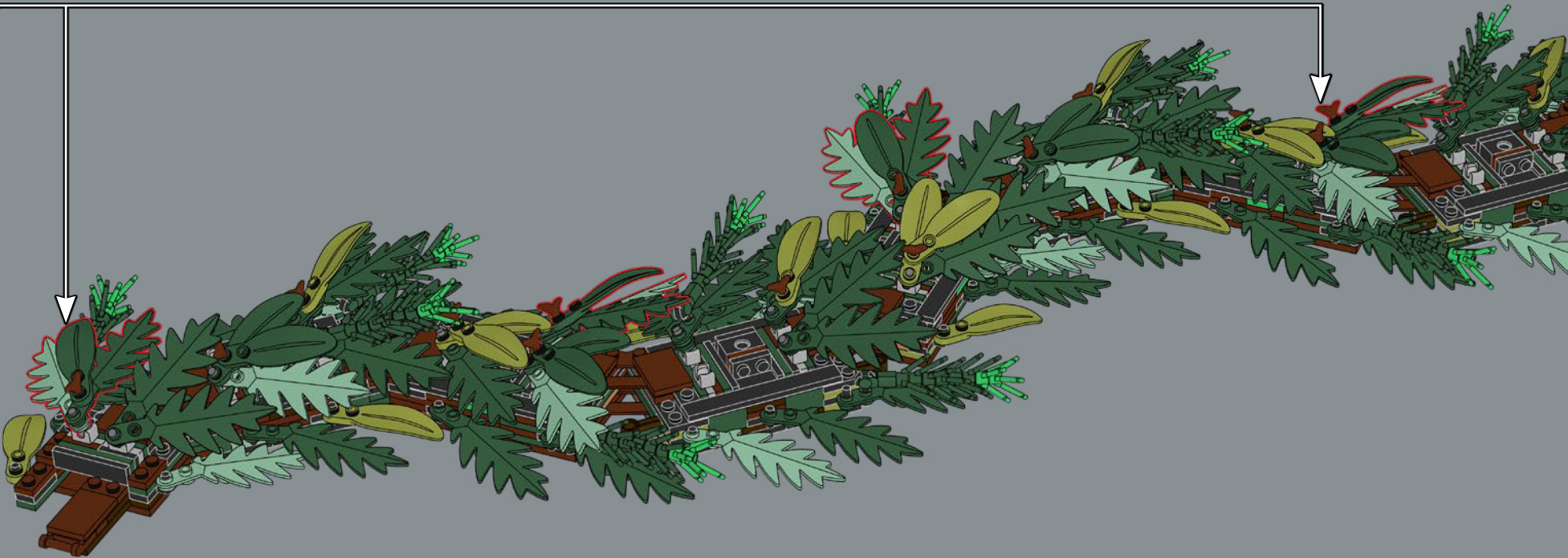
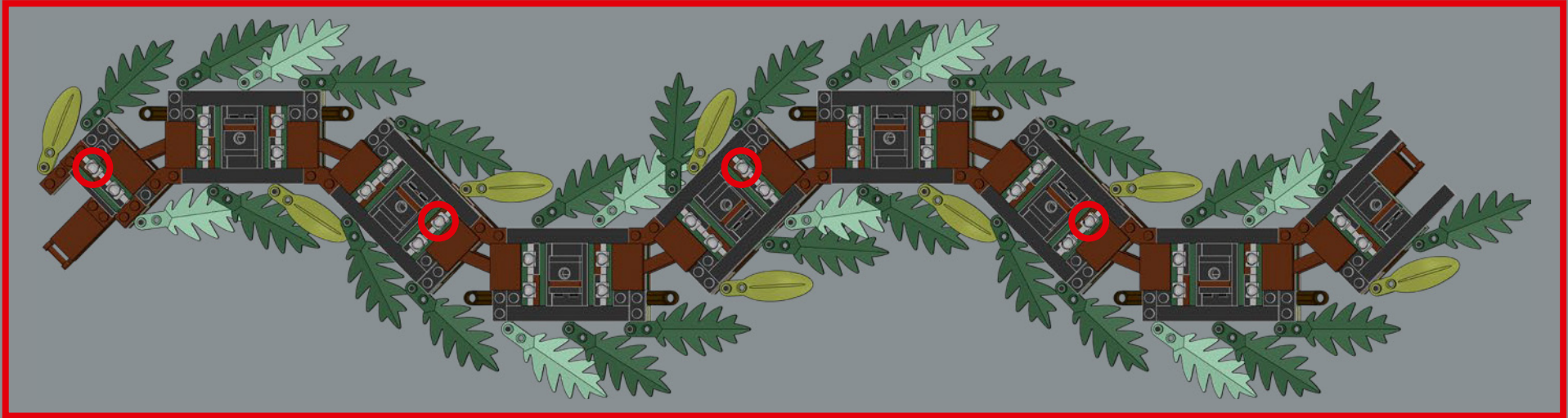

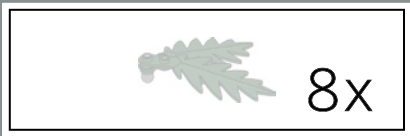

51

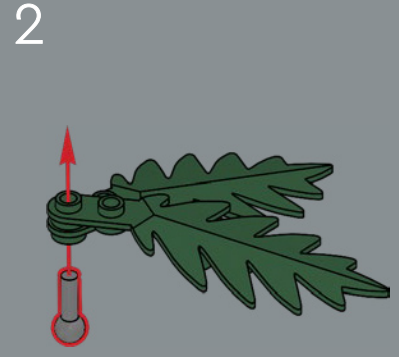
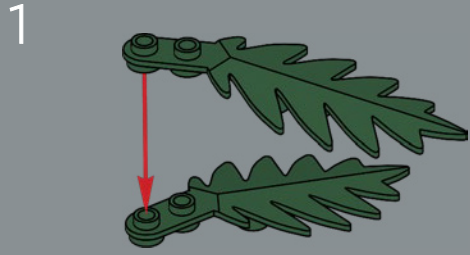

8x

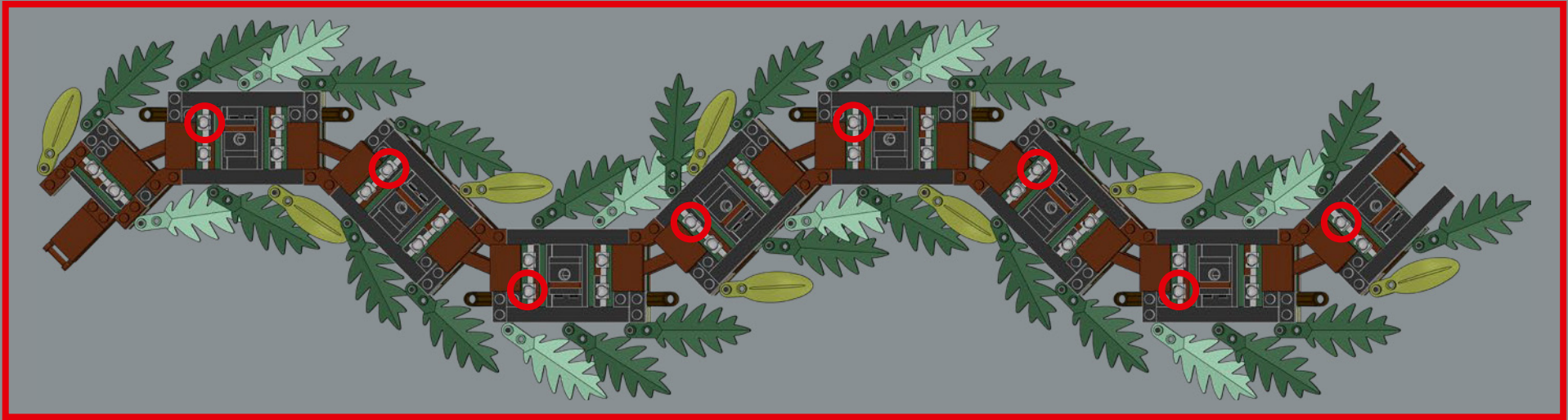

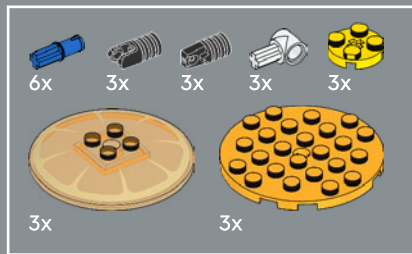

52

1



2



3



4

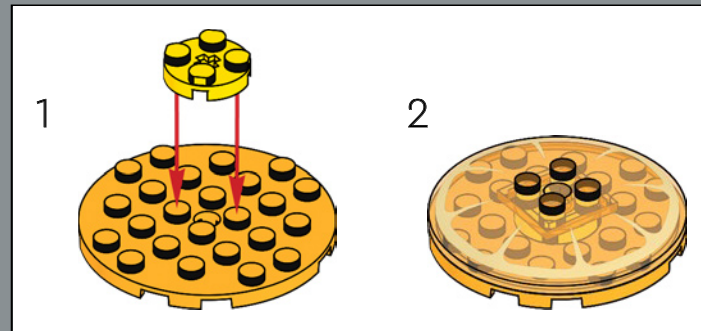
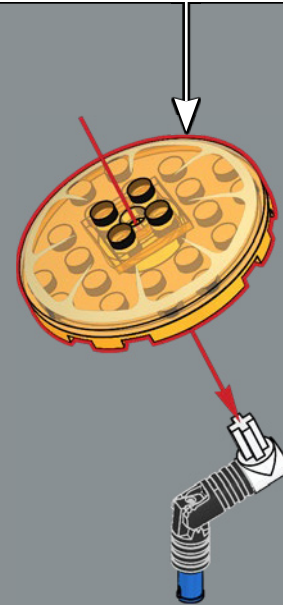

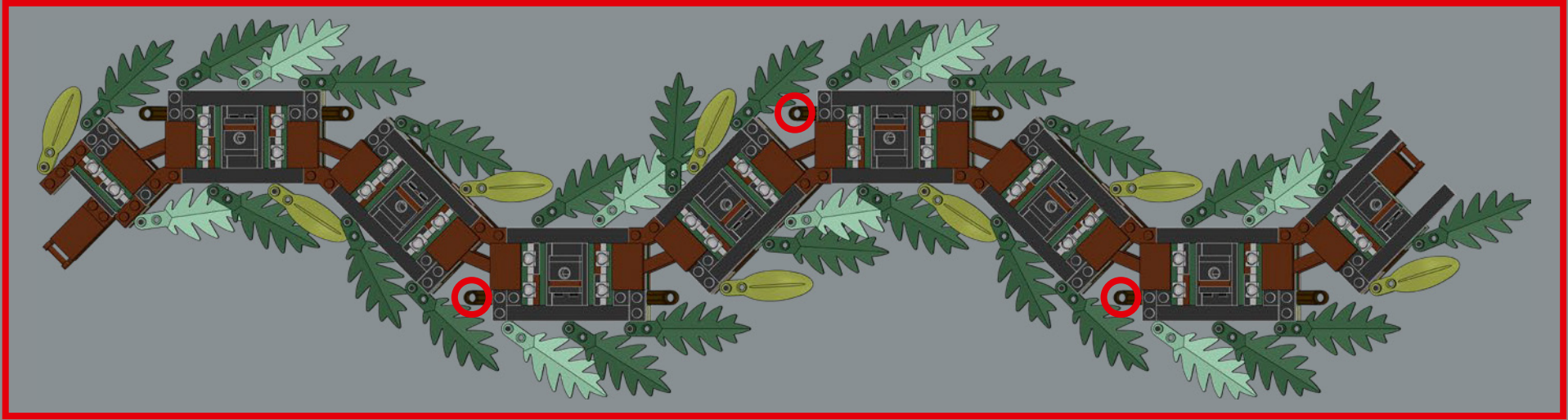

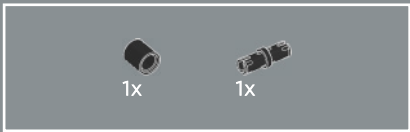
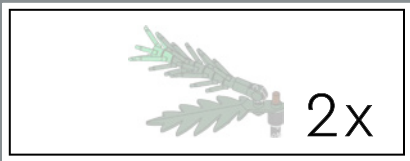

53



54



55



56

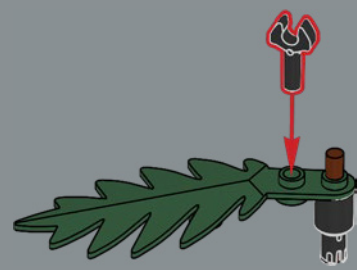





57

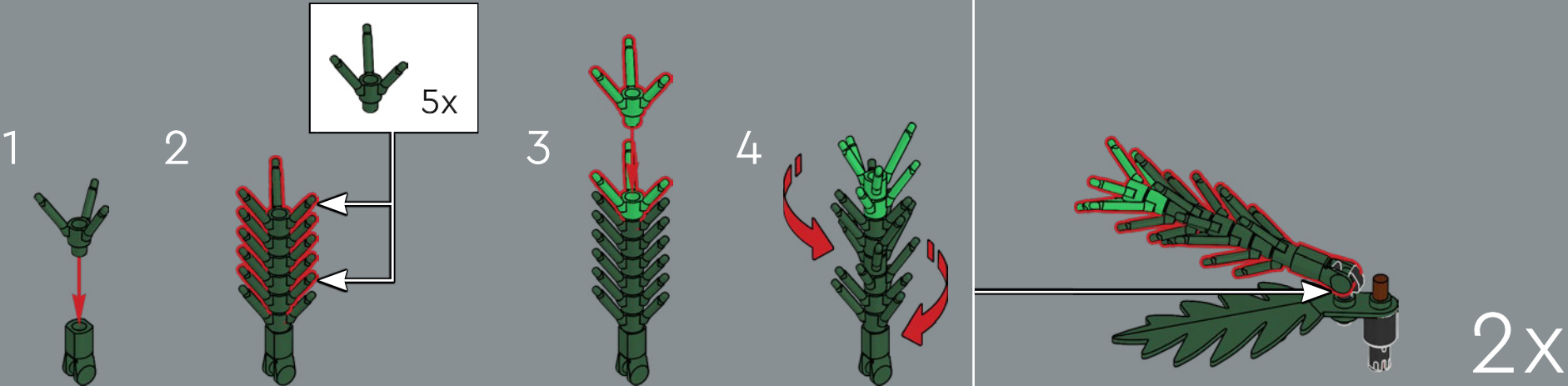

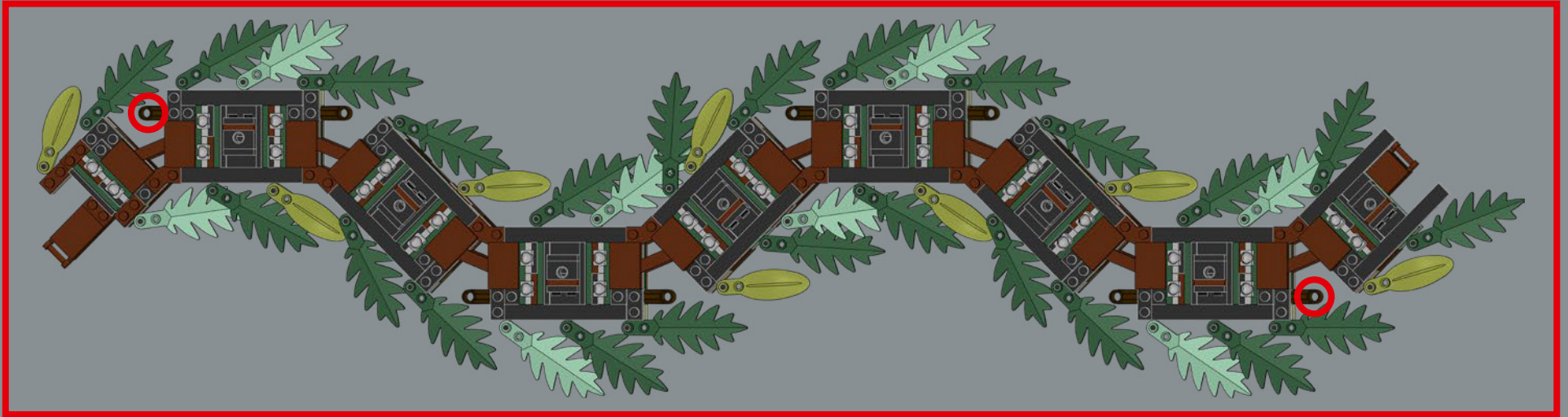

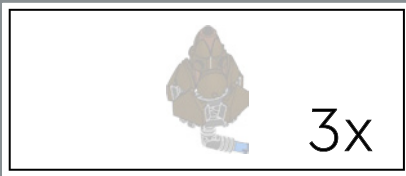

59



60

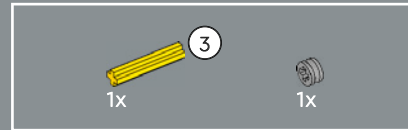

61



62





63



64

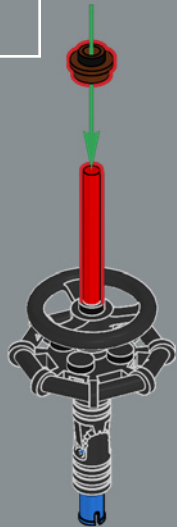

65



66

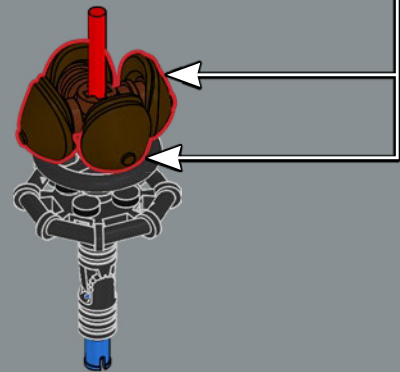
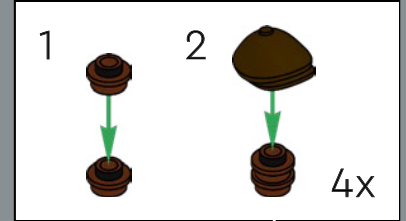



67

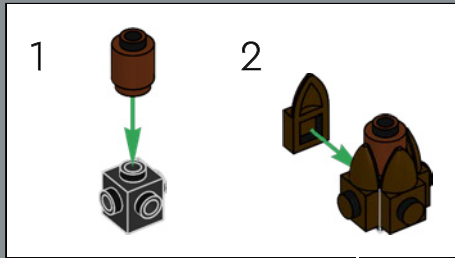

68

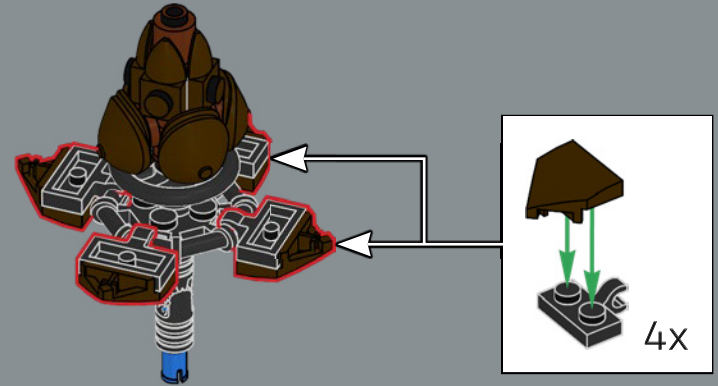

69

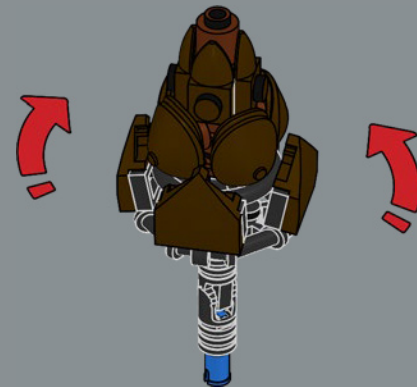

3x

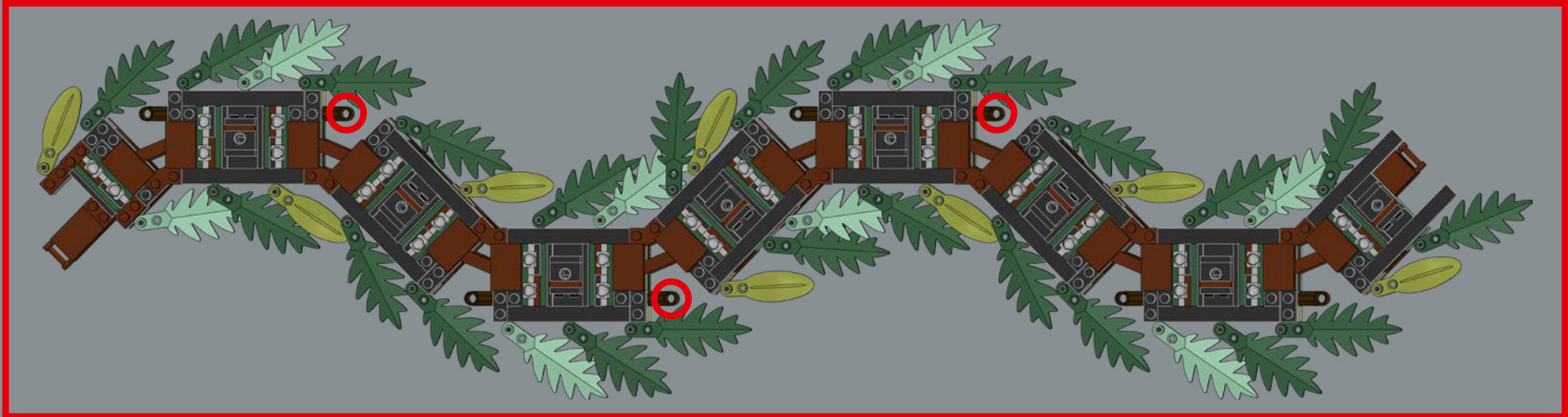

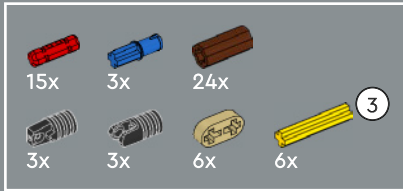
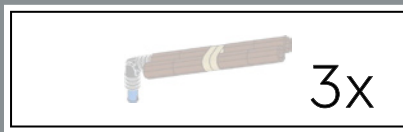

71

1



2



3



4

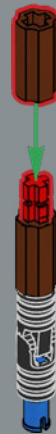

5



6

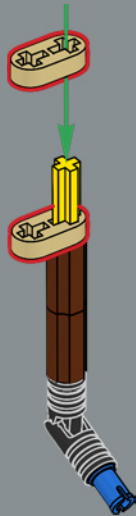

7

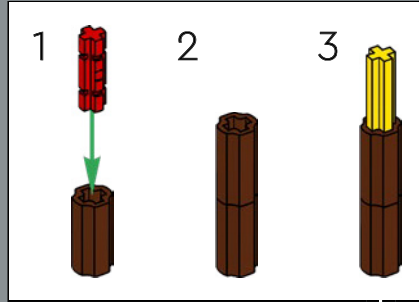
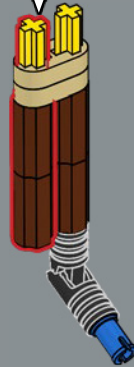

8

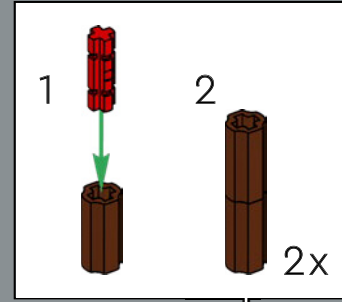

3x



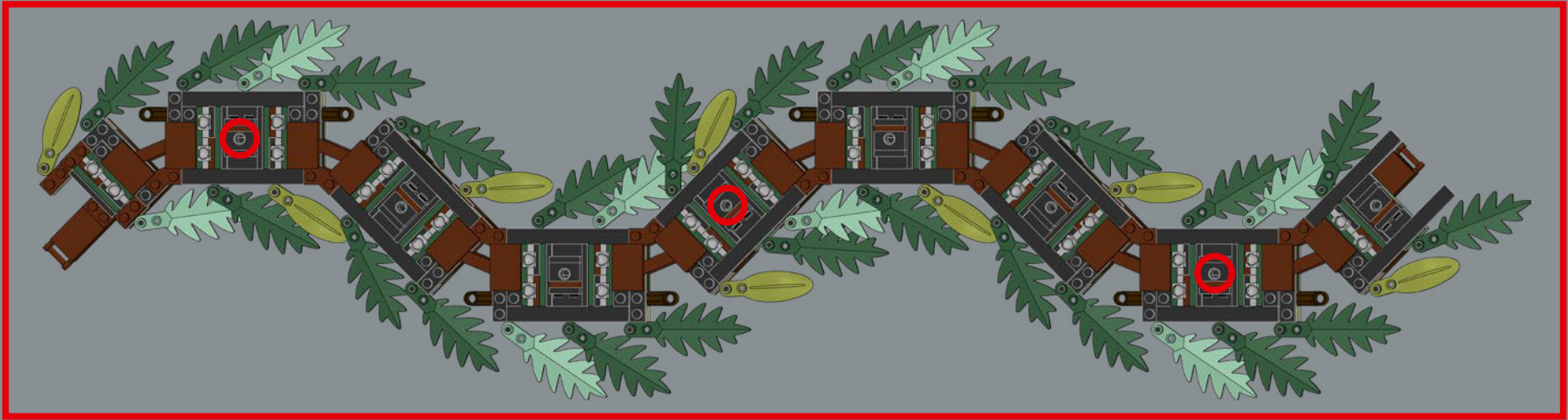

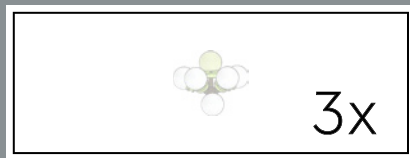

72

1



2

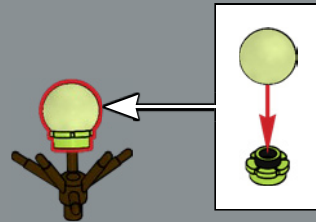

3

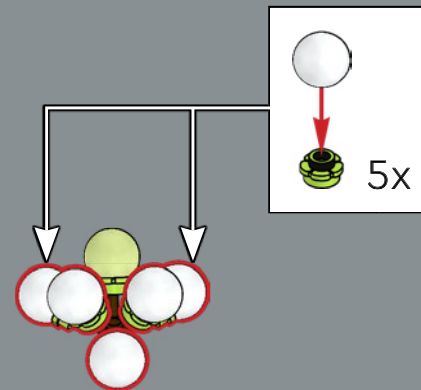

3x

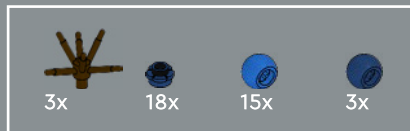
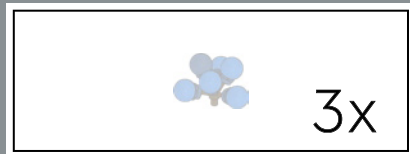

73

1



2

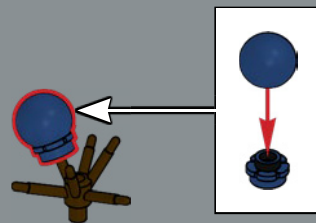

3

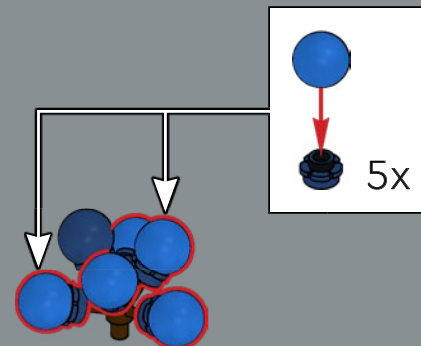

3x



74

1



2

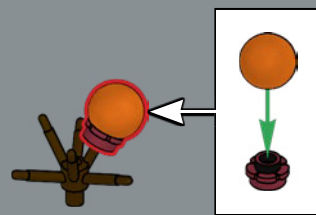

3

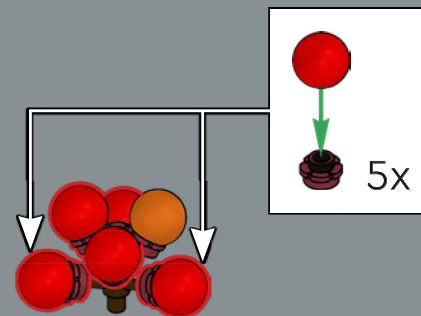

3x







15x  
6052864

3x  
6179606

6x  
6376461

8x  
6330903

8x  
4121921

15x  
4290714

23x  
4142865

3x  
6296954

15x  
6224247

12x  
4206482

3x  
403224

9x  
6130007

18x  
6495167

3x  
6498566

3x  
6495163

3x  
6491212

18x  
6209692

8x  
4537936

24x  
6473460

20x  
6495168

28x  
6269971

4x  
379528

3x  
6509614

3x  
6131694

8x  
6347306

4x  
6343854

14x  
6499873

84x  
6498565

8x  
4245570

72x  
6020923

8x  
4245571

12x  
6491214

74x  
6420219

8x  
6359069

16x  
6491215

4x  
6495166

1x  
6254100

3x  
6271165

32x  
6043656

3x  
4211183

27x  
6215659

16x  
6078605

24x  
4531751

108x  
4211150

8x  
6236915

2x  
6428805

3x  
6316697

24x  
6311441

16x  
6084573

12x  
4221590

8x  
6370000

18x  
6458394

8x  
4539105

32x  
6364352

12x  
6491211

8x  
6332586

12x  
6501311

12x  
6308903

9x  
6452882

4x  
6473454

24x  
4518687

14x  
6439039

9x  
6265699

9x  
6271535

2x  
6279875

2x  
6121485

3x  
473326

12x  
6313116

40x  
6261348

8x  
370026

32x  
6250020

8x  
302226

3x  
4580509

3x  
6018805

16x  
243126

16x  
6401209

16x  
416226

8x  
303226



LEGO.com/service



# YOU COULD WIN



## YOU COULD WIN

Your feedback will help shape the future development of this product series.

Visit:

## DU KÖNNTEST GEWINNEN

Dein Feedback trägt zur Weiterentwicklung dieser Produktreihe bei.

Geh auf:

## VOUS POURRIEZ GAGNER

Vos commentaires nous aideront à concevoir les futurs produits de cette gamme.

Visitez :

## POTRESTI VINCERE TU

La tua opinione ci aiuterà a migliorare la creazione futura di questa linea di prodotti.

Visita:

## PUEDES GANAR

Tu opinión contribuirá al futuro de esta serie de productos.

Visita:

## 轻松获奖

您的反馈将有助于我们在今后改进本产品系列。

请访问:

---

[LEGO.com/productfeedback](https://www.lego.com/productfeedback)

---

You also have the chance to win a LEGO® set.

Terms and conditions apply.\*

Außerdem hast du die Chance, ein LEGO® Set zu gewinnen.

Es gelten die Teilnahmebedingungen.\*

Vous pourriez également gagner un ensemble LEGO®.

Des conditions s'appliquent.\*

Hai anche la possibilità di vincere un set LEGO®.

Termini e condizioni sono applicabili.\*

También tienes la oportunidad de ganar un set LEGO®.

Aplican términos y condiciones.\*

您还有机会赢取乐高®套装。

条款和条件适用。\*

\*[LEGO.com/productfeedback-terms](https://www.lego.com/productfeedback-terms)

