



# MINECRAFT

21281



LEGO® Builder



### **Get excited about our new packaging!**

We're switching from plastic to paper-based packaging. That's why you might find a mix of paper and plastic in our boxes!

### **Nos nouveaux emballages vous emballeront !**

Nous passons des emballages en plastique aux emballages à base de papier. C'est pourquoi vous pourriez trouver un mélange de papier et de plastique dans nos boîtes !

### **¡Te presentamos nuestros nuevos empaques!**

Estamos sustituyendo las bolsas de plástico por bolsas con base de papel. ¡Por eso, puedes encontrar una mezcla de papel y de plástico en nuestras cajas!

**[LEGO.com/sustainable-packaging](https://www.lego.com/sustainable-packaging)**



Q LEGO® Builder

# BUILDER



Apple and the Apple logo are trademarks of Apple Inc., registered in the U.S. and other countries and regions. App Store is a service mark of Apple Inc. Google Play and the Google Play logo are trademarks of Google LLC. Tencent and the Tencent logo are trademarks of Tencent Inc.

Q [LEGO.com/devicecheck](https://lego.com/devicecheck)

**EN** Ask parents' permission before going online | **DE** Eltern um Erlaubnis bitten, bevor du online gehst | **FR** Demande l'autorisation d'un parent avant d'aller en ligne | **IT** Chiedi il permesso ai tuoi genitori prima di andare online | **ES** Pídeles permiso a tus papás antes de conectarte a Internet | **PT** Pede autorização aos pais antes de acederes online | **ZH** 上网前应先征得父母的同意 | **PL** Poproś rodziców o zgodę, zanim wejdiesz do Internetu | **CS** Než půjdeš na internet, požádej rodiče o svolení | **SK** Skôr než pôjdeš na internet, vypýtaj si povolenie od rodičov | **HU** Kérj szülői engedélyt, mielőtt online csatlakoznál! | **RO** Cere permisiunea părinților înainte de a te conecta online | **BG** Поискайте разрешение от родител, преди да влезете онлайн | **LV** Pirms došanās tiešsaistē palūdz atļauju vecākiem | **ET** Enne Interneti kasutamist küsi vanematelt luba | **LT** Prieš prisijungdami prie interneto, atsiklauskite tėvų

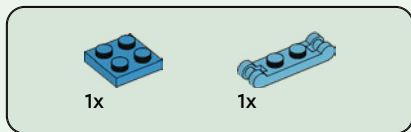
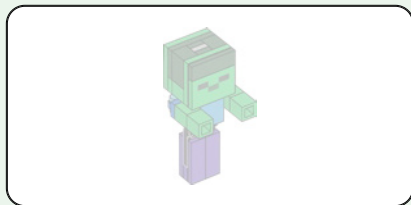

1

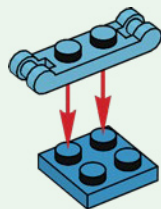



1x

2

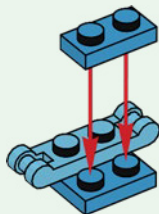

1x



1x

3

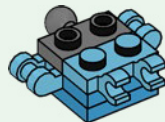

1x

4

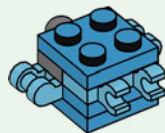

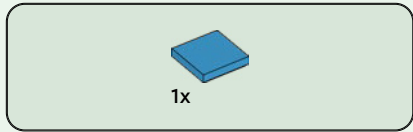

5

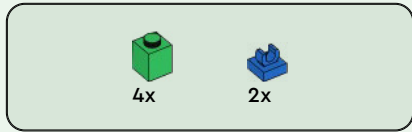
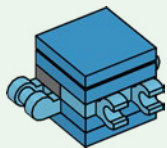

6

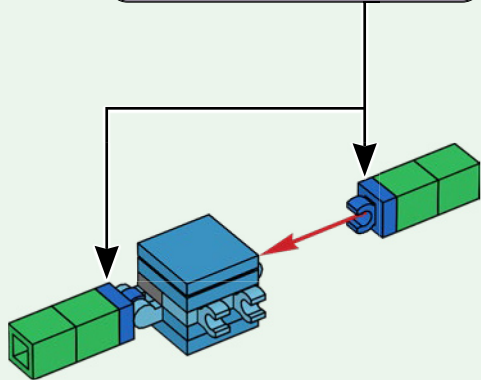
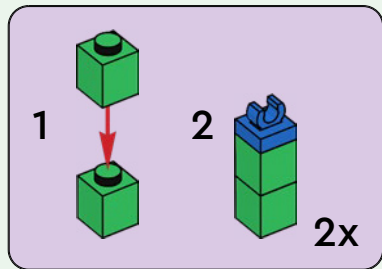

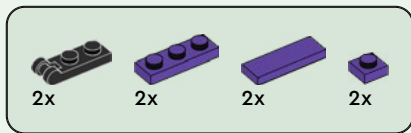

7

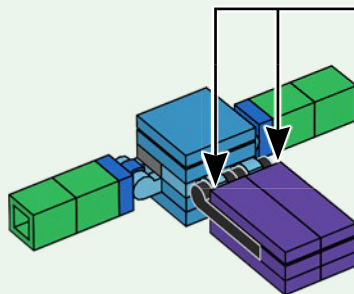
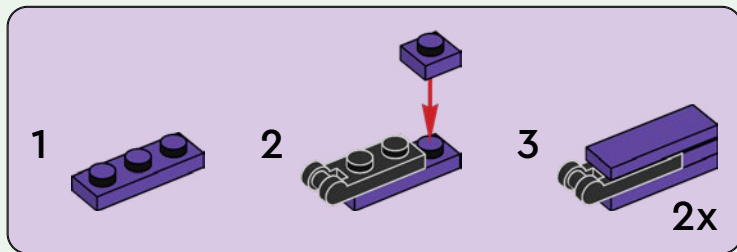



1x

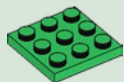

1x

8

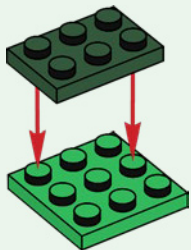

2x

9

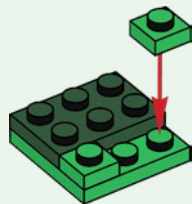





2x



1x

# 10

1

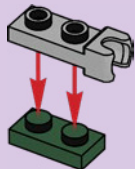

2

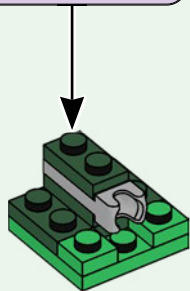
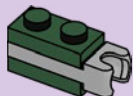

2x



2x

# 11

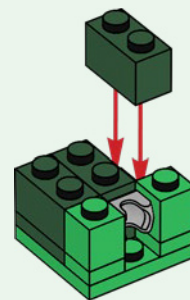

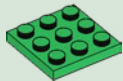

1x

12

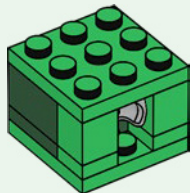

1x



1x

13

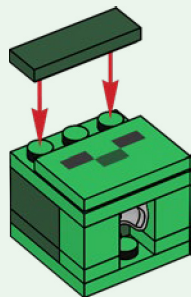

14

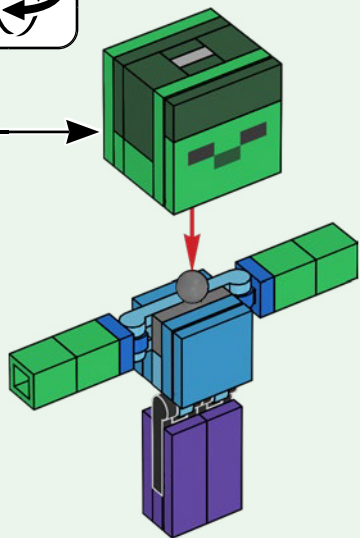
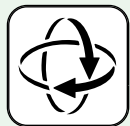

15

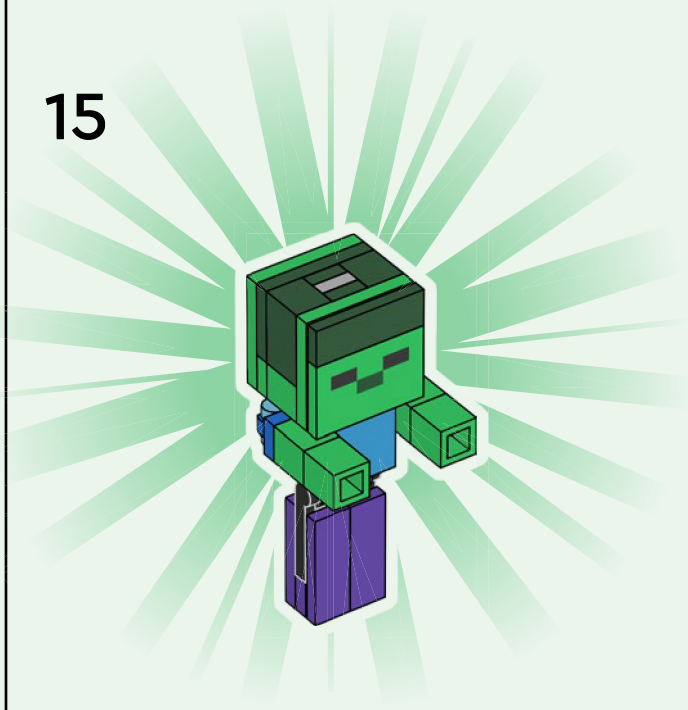

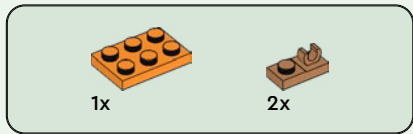
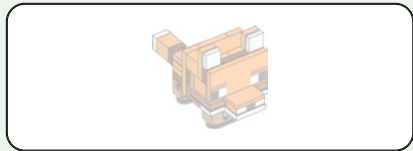

1

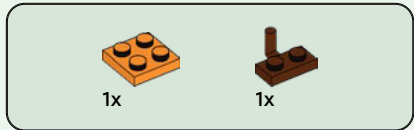
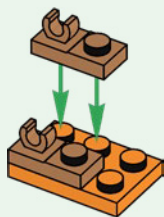

2

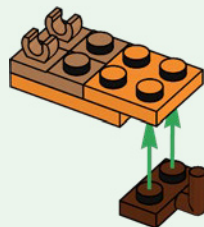

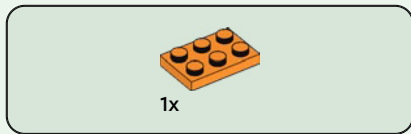

3

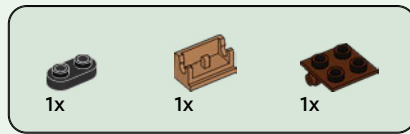

4

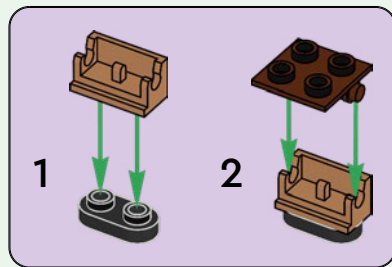



1x



1x

5

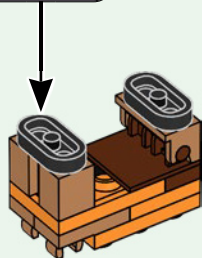
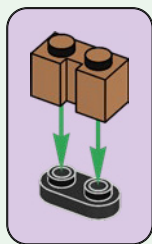

2x

6

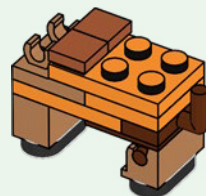



2x

7

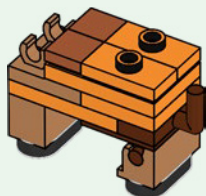

1x



1x



1x

8

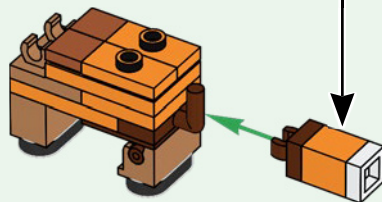
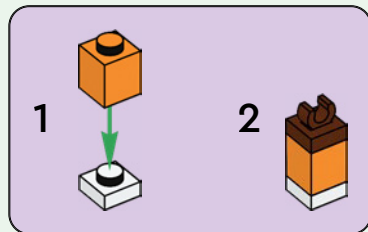

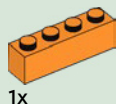
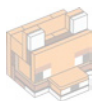

1x



1x

9

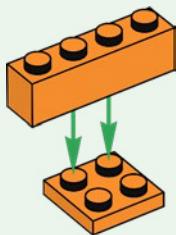

2x

10

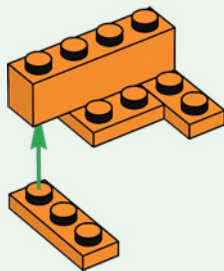



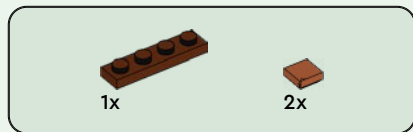

11

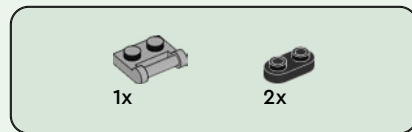
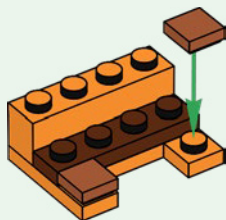

12

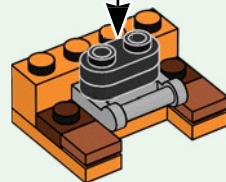
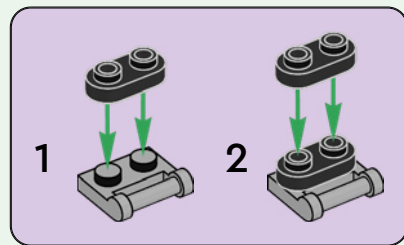

2x



2x



2x



2x

# 13

1

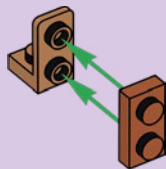

2

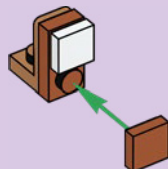

2x

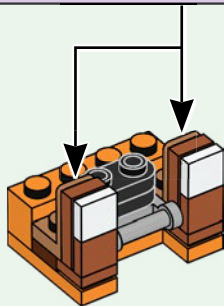

2x

# 14

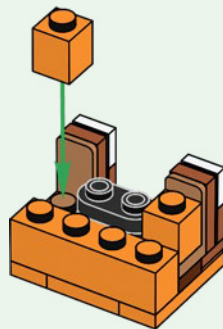



2x

15

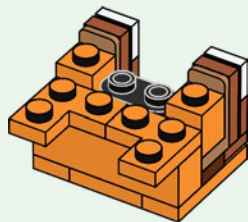

1x

16

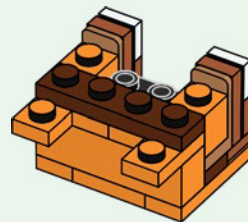

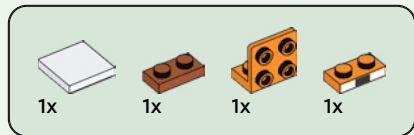

17

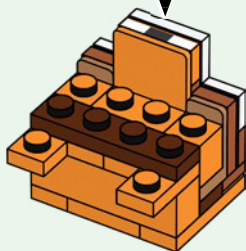
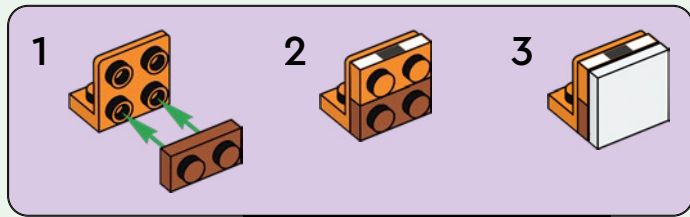

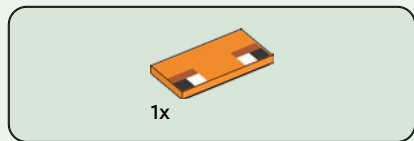

18

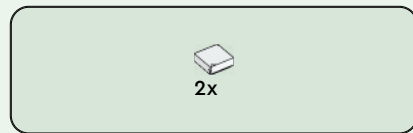
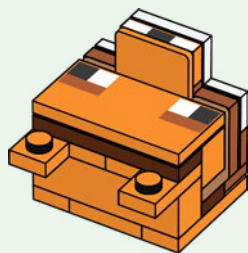

19

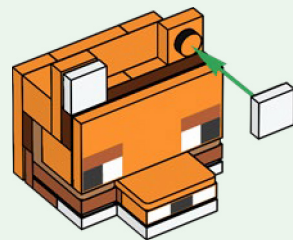
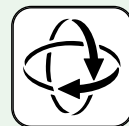

20

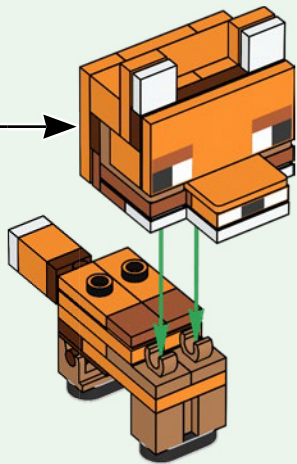

21

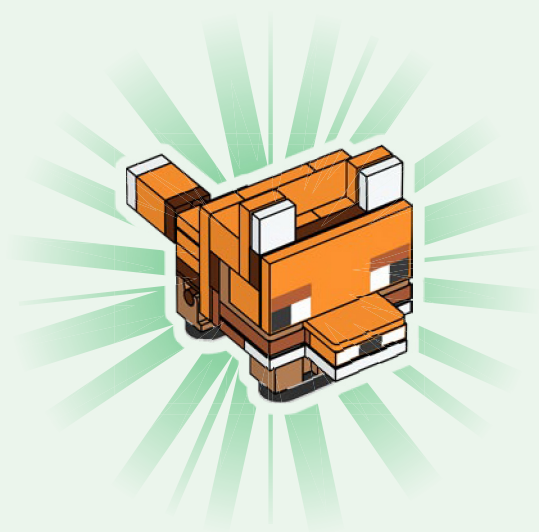

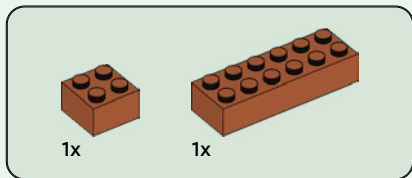
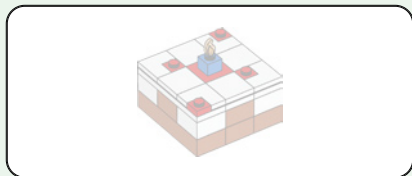

1

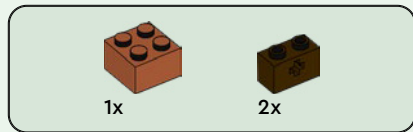
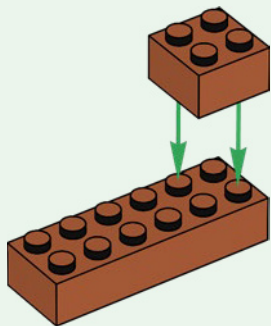

2

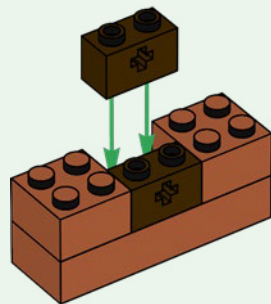

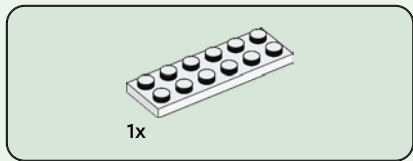

3

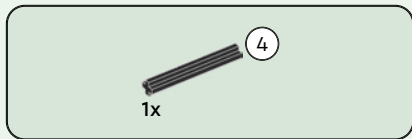
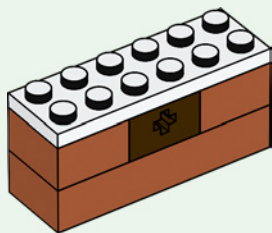

4

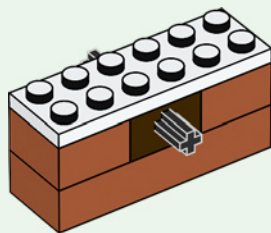





2x



1x

5

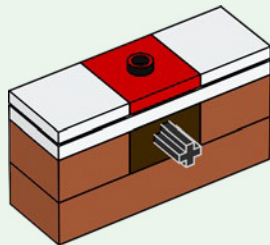

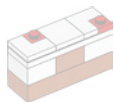

2x



1x

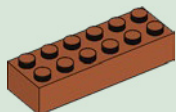

1x

6

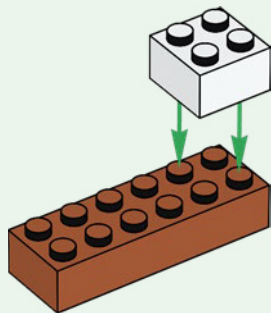

1x



1x



1x

7

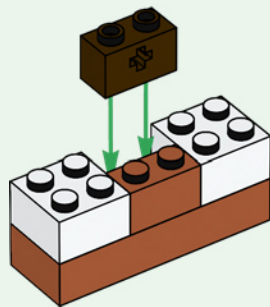

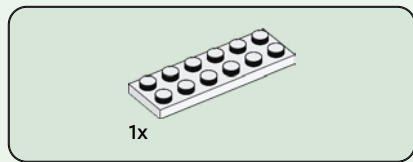

8

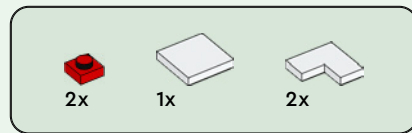
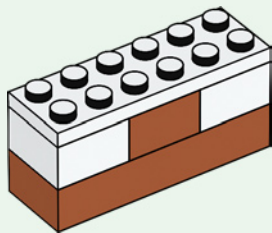

9

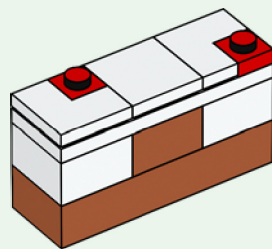

2x

10

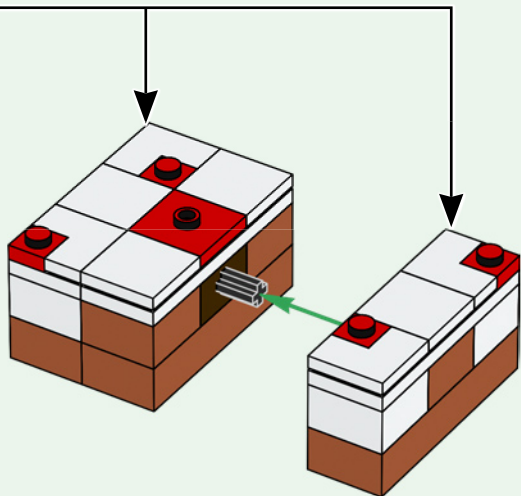

11

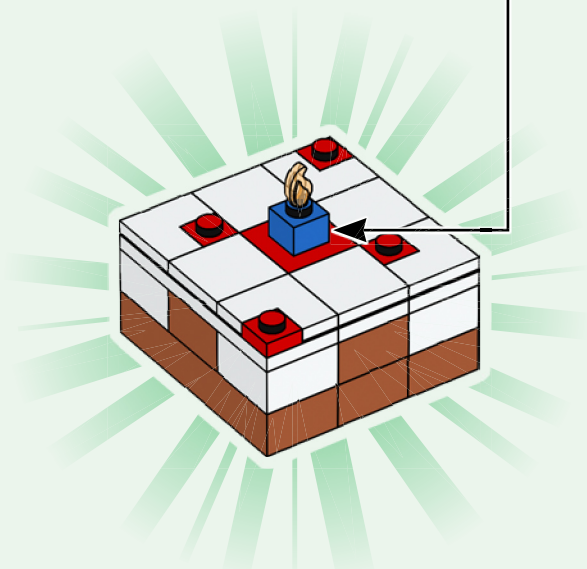
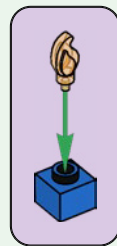
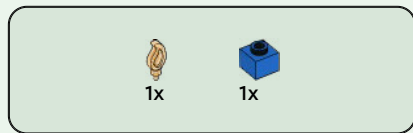

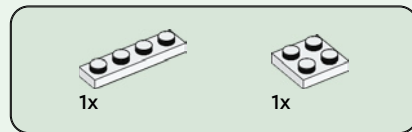
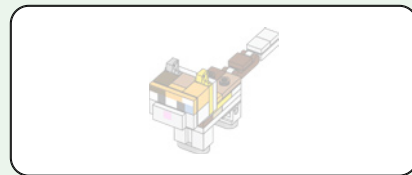

1

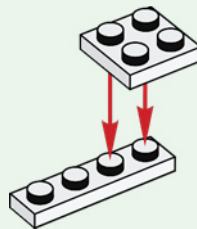



1x

2

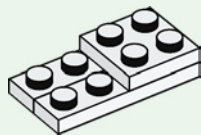

1x



1x

3



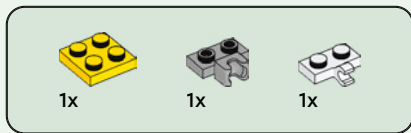

4

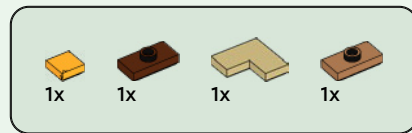
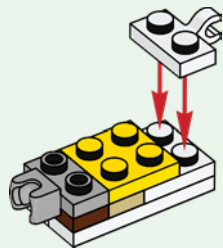

5

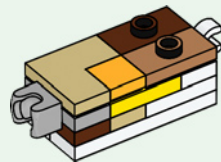

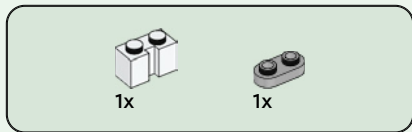

6

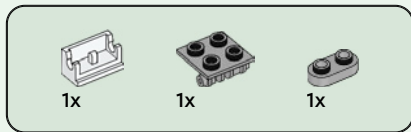
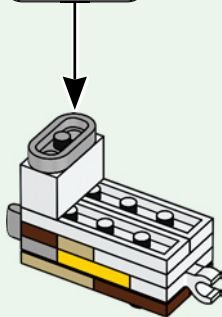
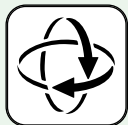
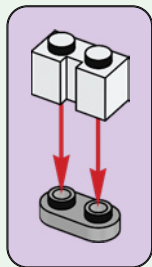

7

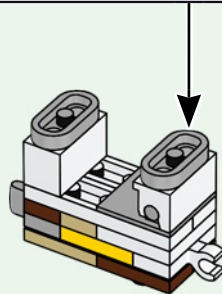
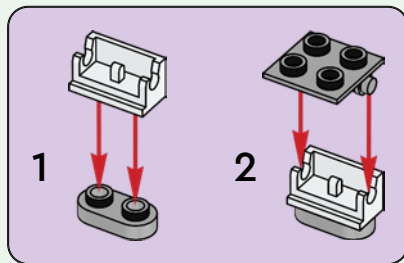



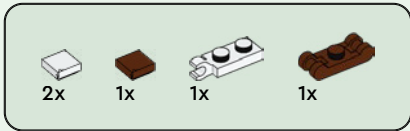

8

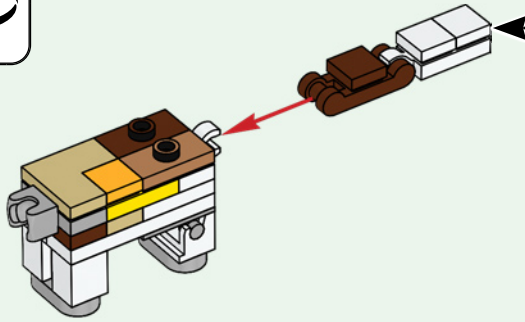
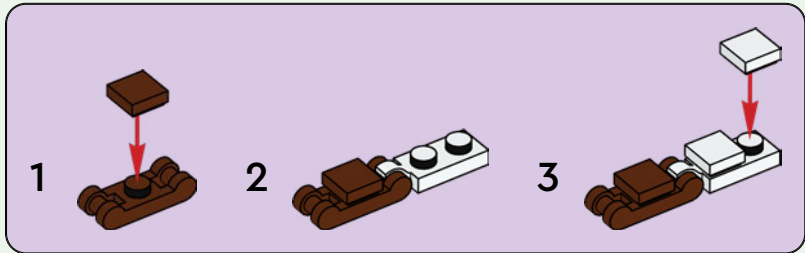



1x



1x

9

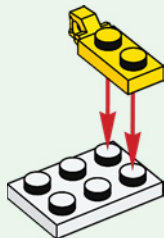

1x

10

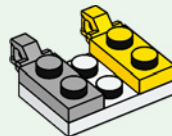



1x



1x

# 11

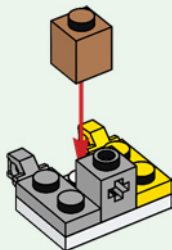

1x

# 12

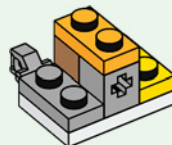

1x

# 13

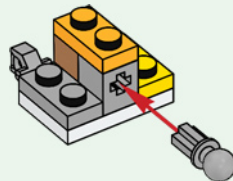

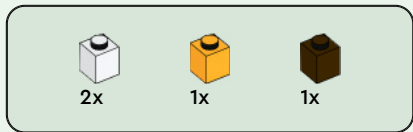

14

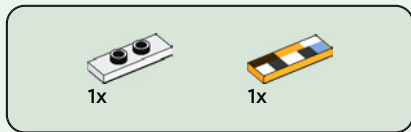
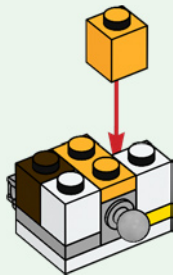

15

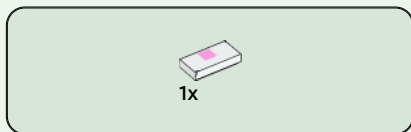

16

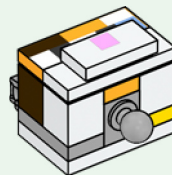

17

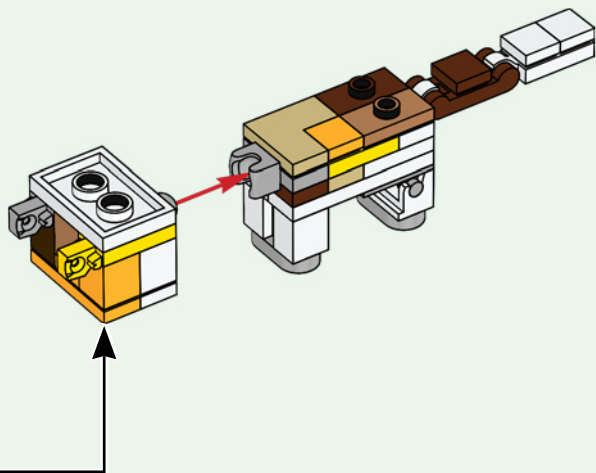

18

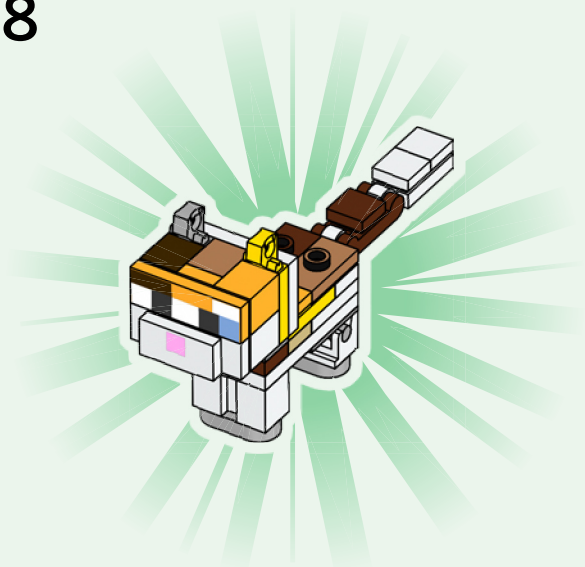

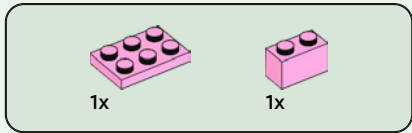
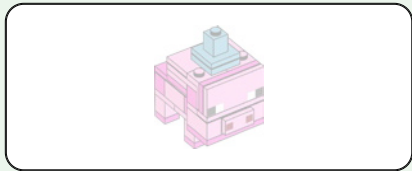

1

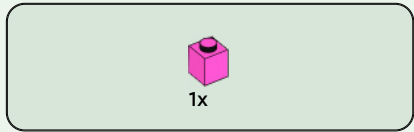
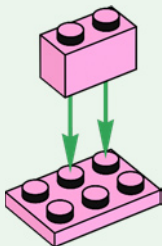

2

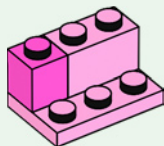



1x

3

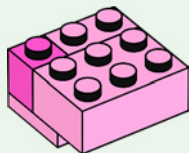

1x

4

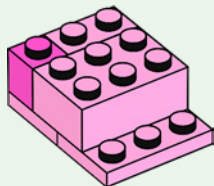

2x



1x

5

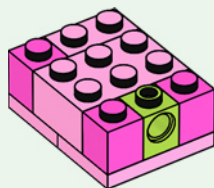



2x

6

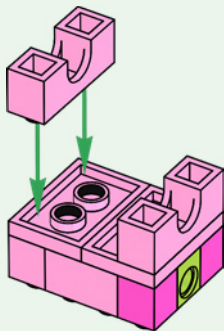
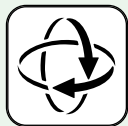

4x

7

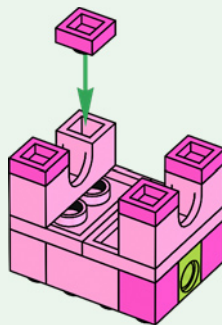



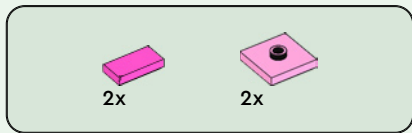

8

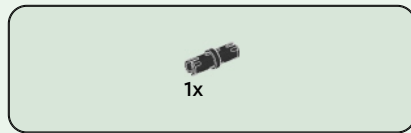
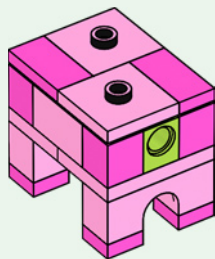

9

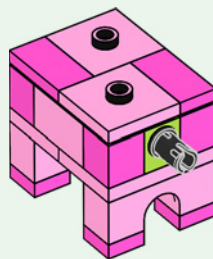

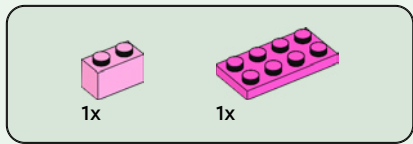

10

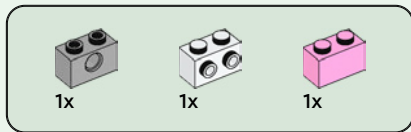
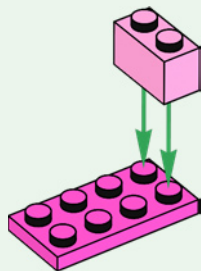

11

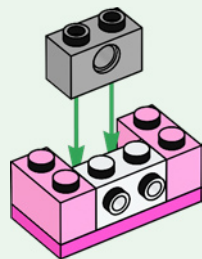

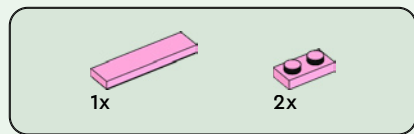

12

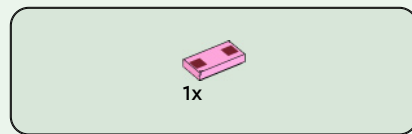
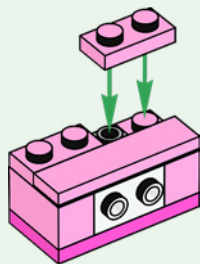

13

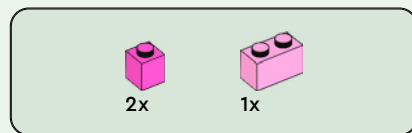
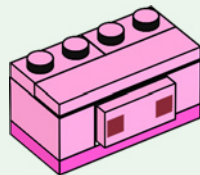

14

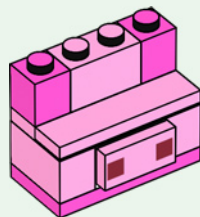

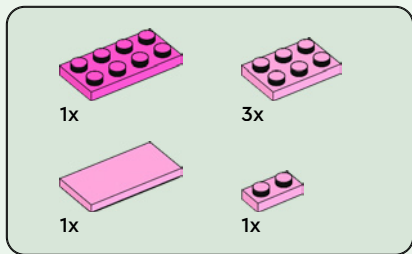

15

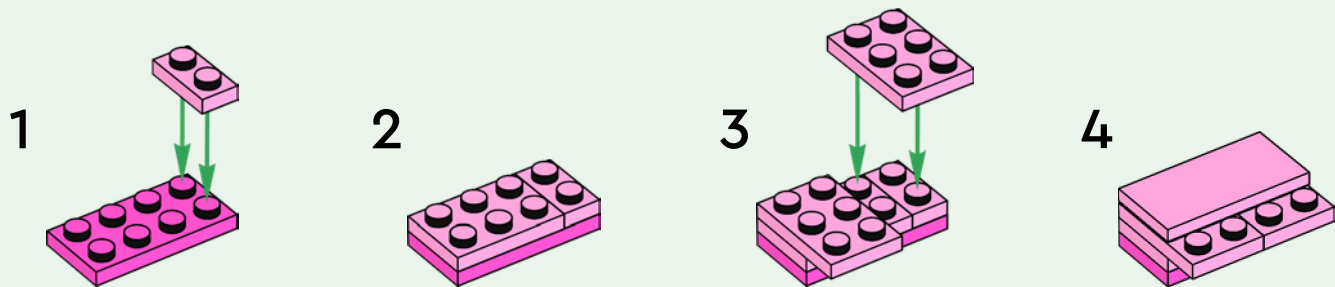

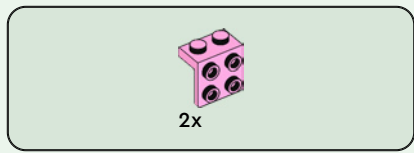
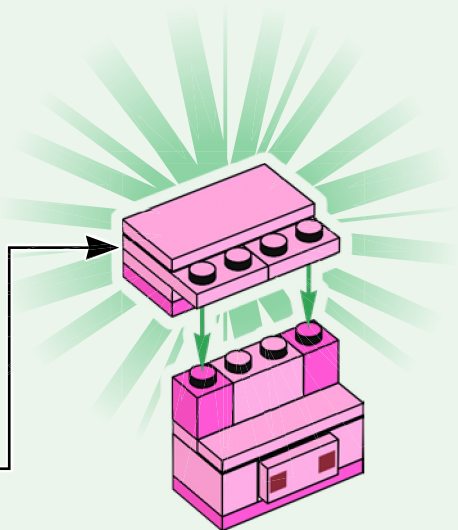

16

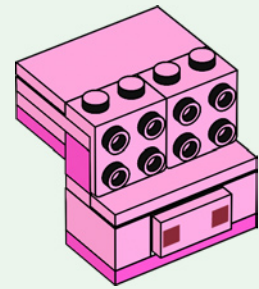

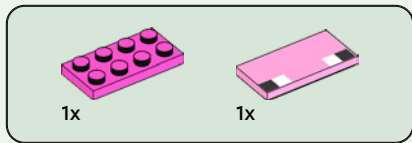

17

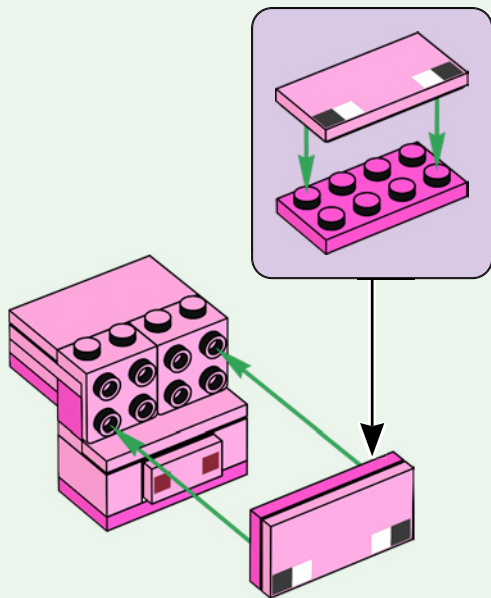

18

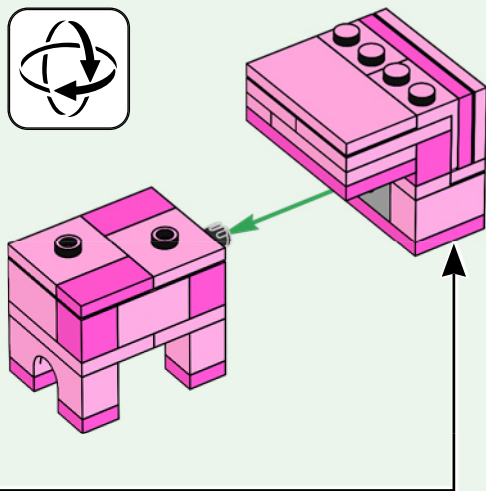

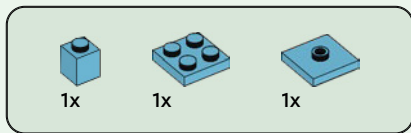

19

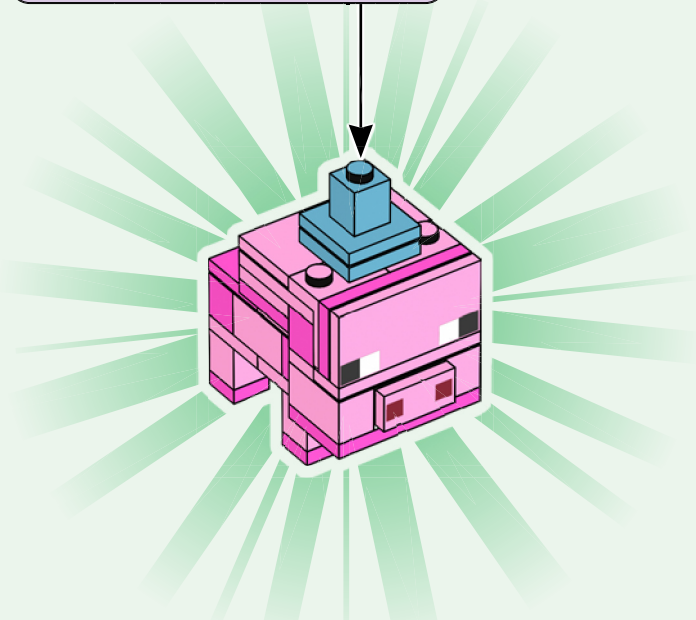
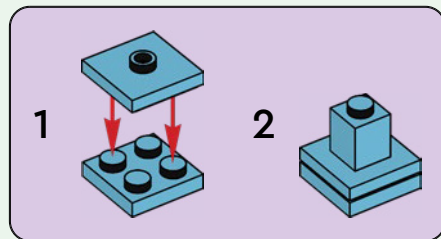

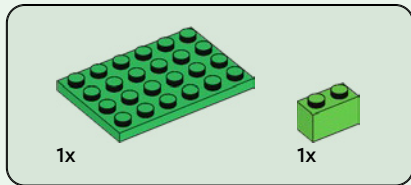
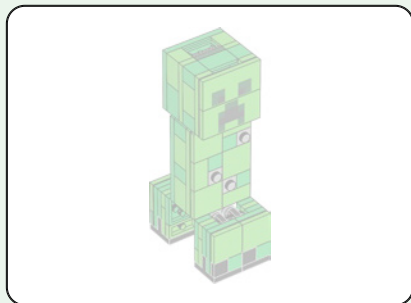

1

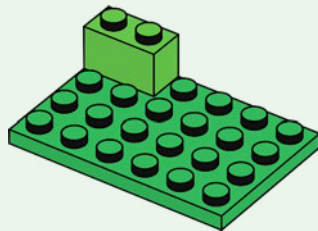



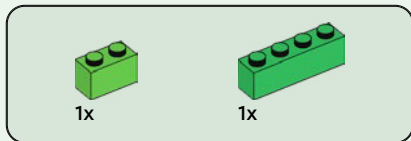

2

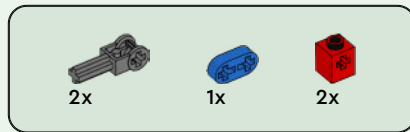
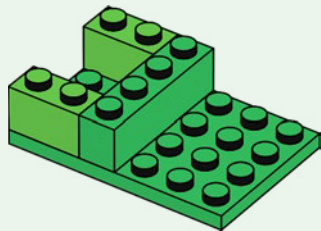

3

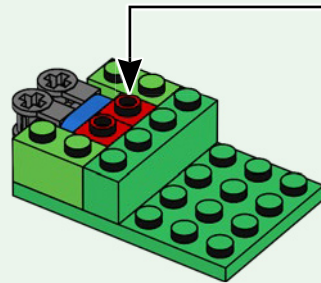
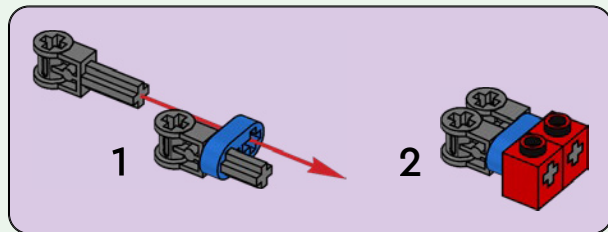



2x

4

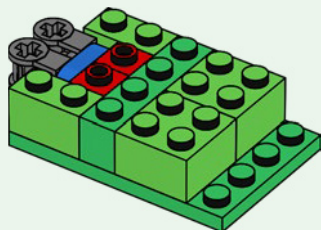

2x



1x

5

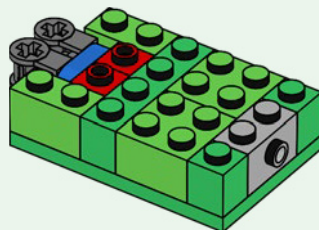

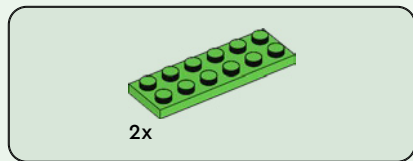

6

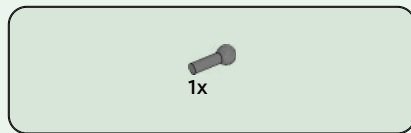
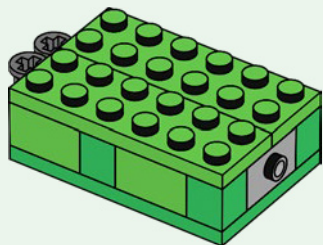

7

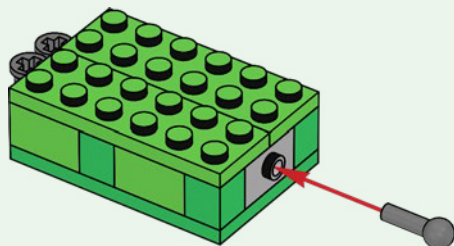



3x

8

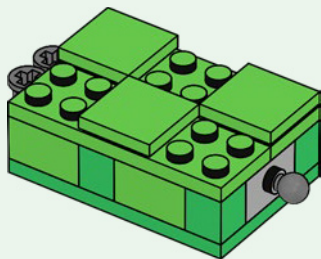

3x



3x



3x

9

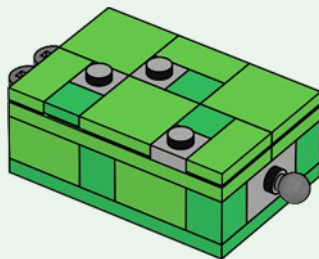

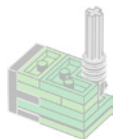

2x



1x



1x

10

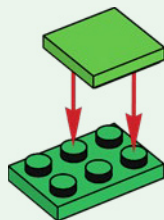

1x



1x

11

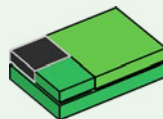

1x



1x

12

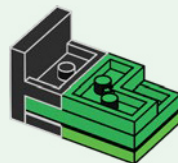



13

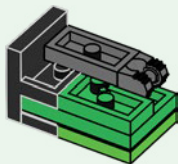

14

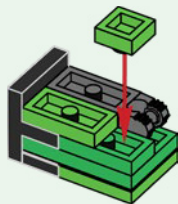



1x

15

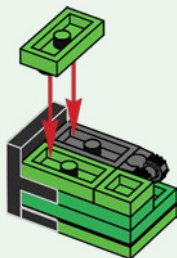

1x

16

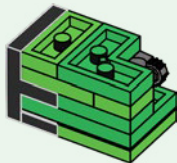

1x



1x

17

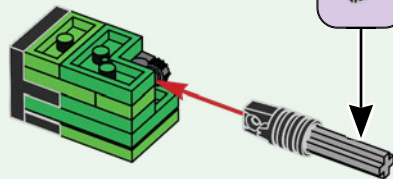

3

1:1

18

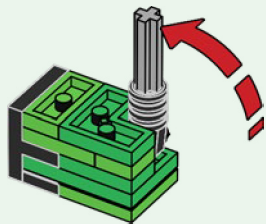

2x

19

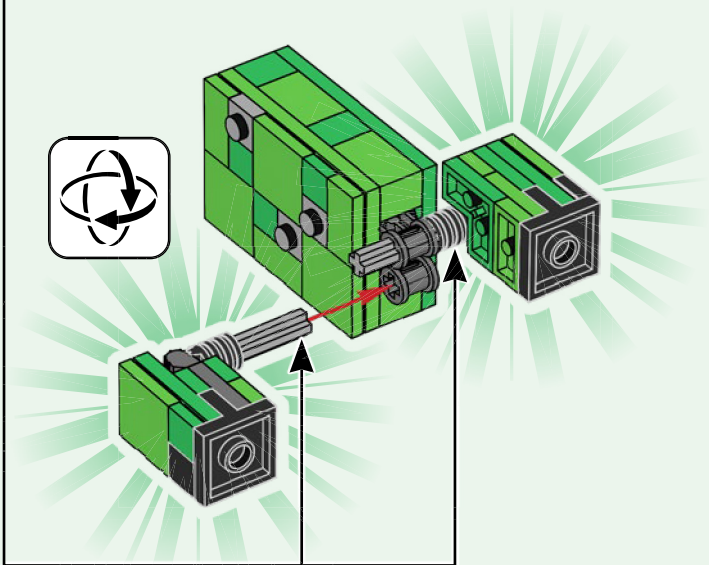
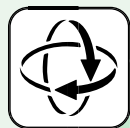



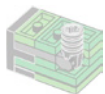

2x



1x



1x

20

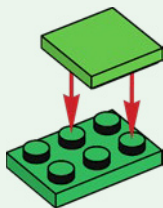

1x



1x

21

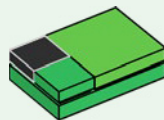



1x



1x

# 22

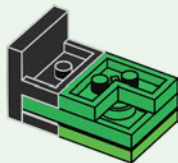

1x

# 23

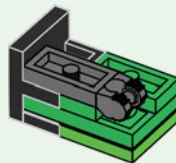



1x



1x

# 24

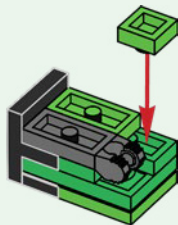

1x

# 25

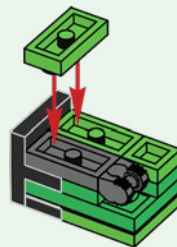



1x

26

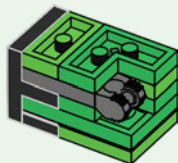

1x

27

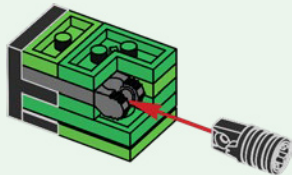

28

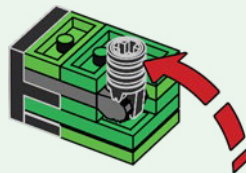

2x

29

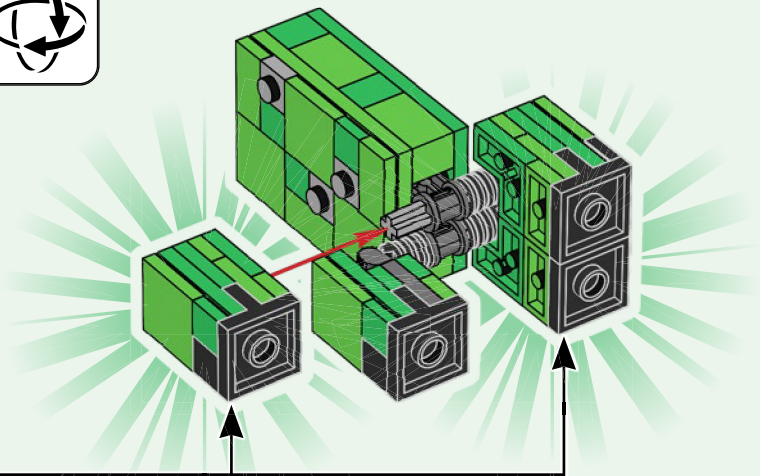

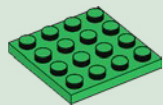

1x



1x

30

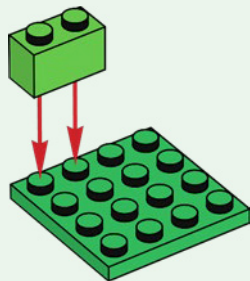

2x

31

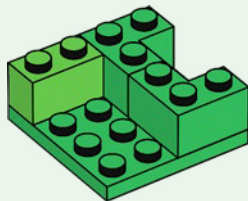



1x

32

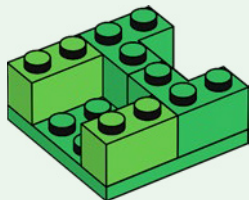

1x



2x

33

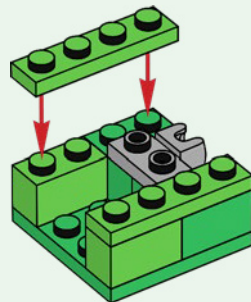

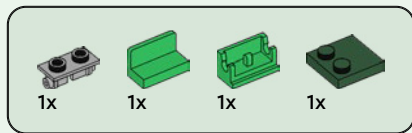

# 34

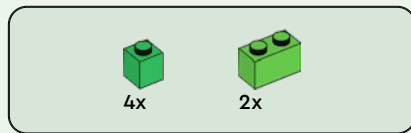
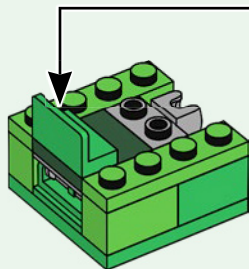

# 35

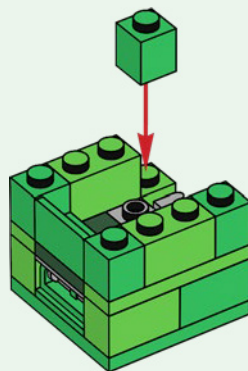





1x



1x

36

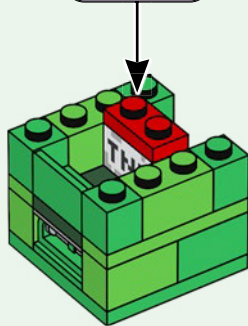
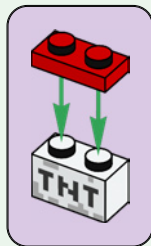

2x

37

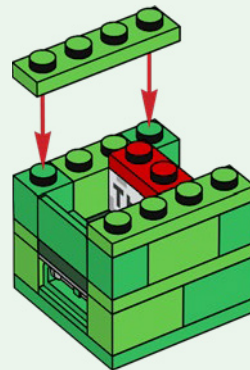

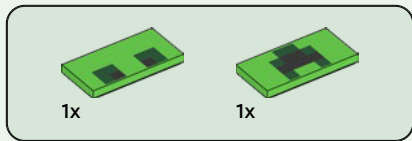

38

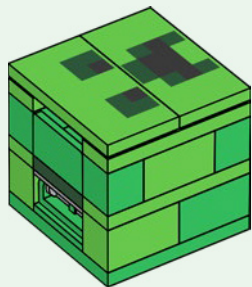

39

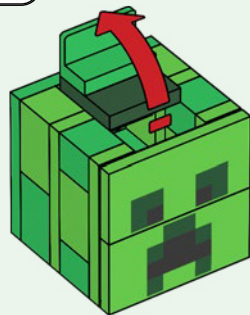

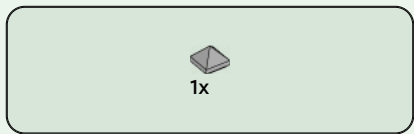

40

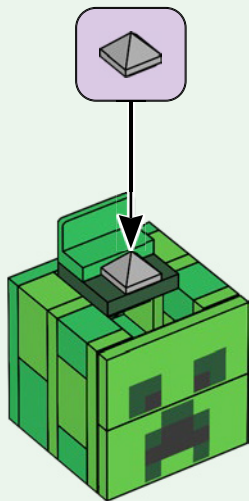

41

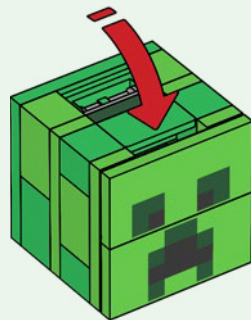

42

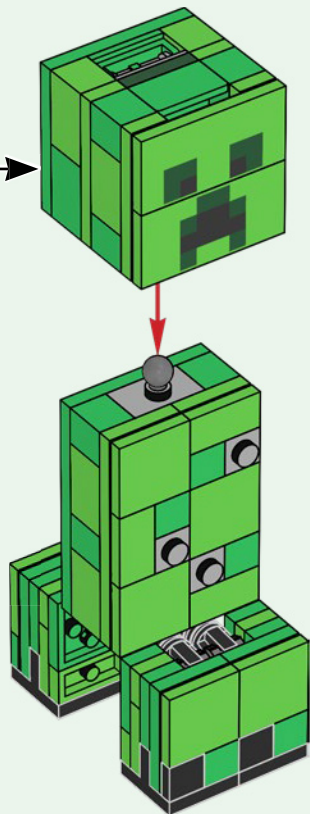

43

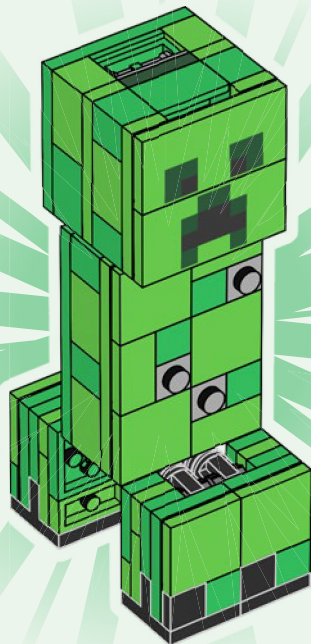

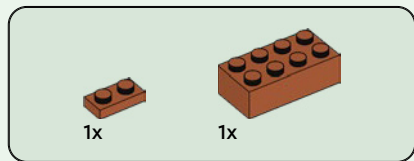
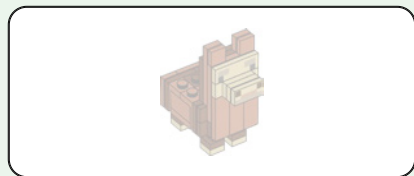

1

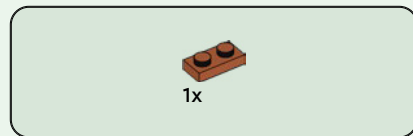
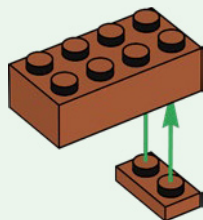

2

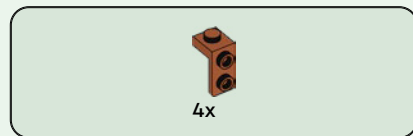
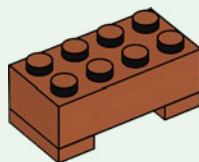

3

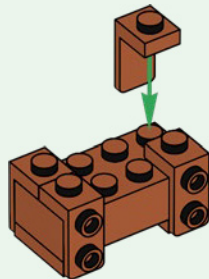

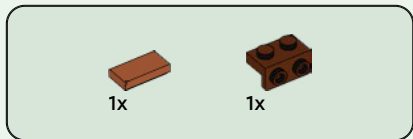

4

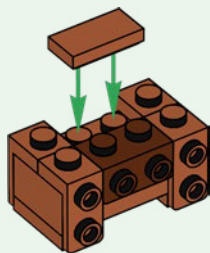

5

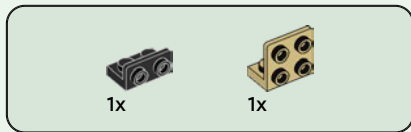
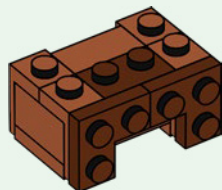

6

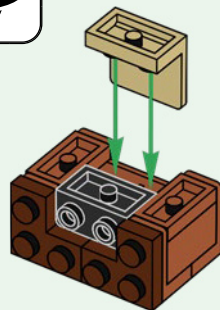



1x

7

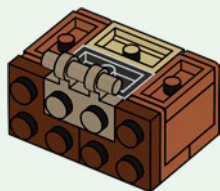

2x



1x

8

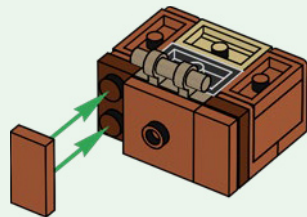

1x

9

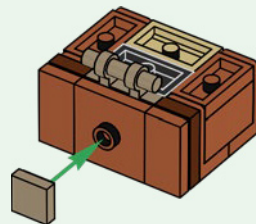



2x

10

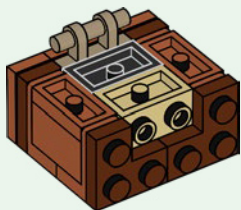

1x

11

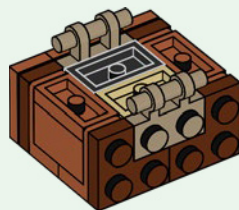



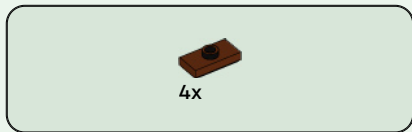

12

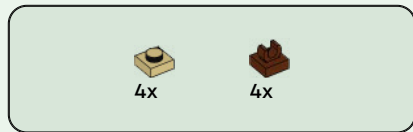
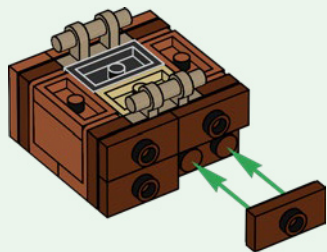

13

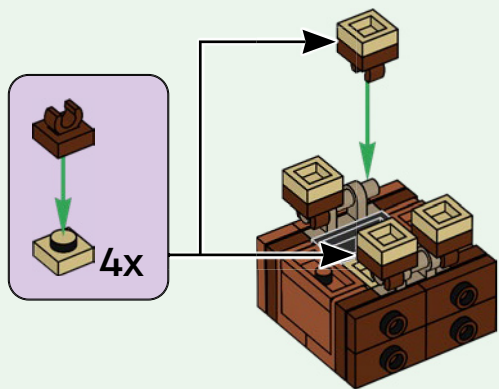

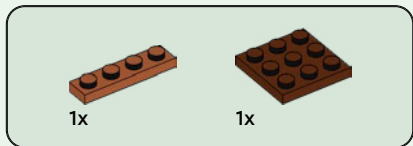
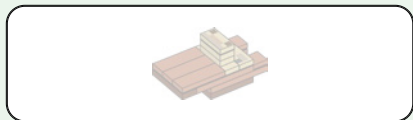

14

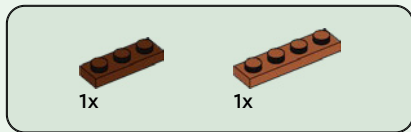
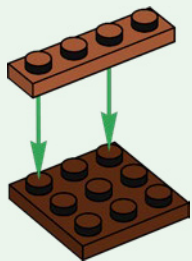

15

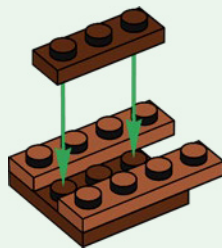



16

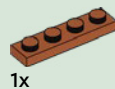
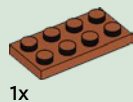
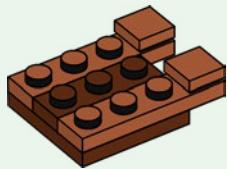

17

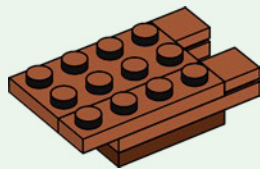

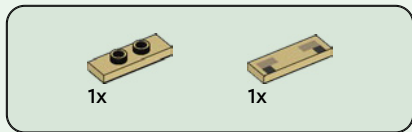

18

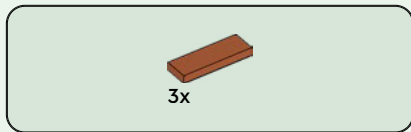

19

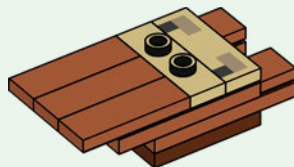

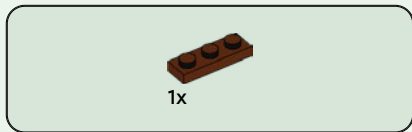

20

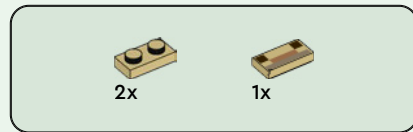
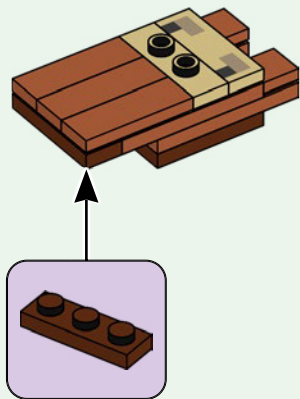

21

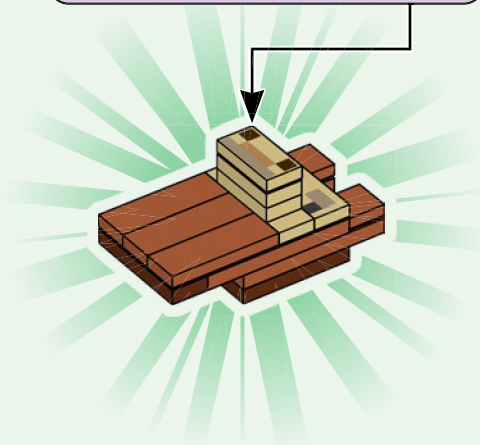
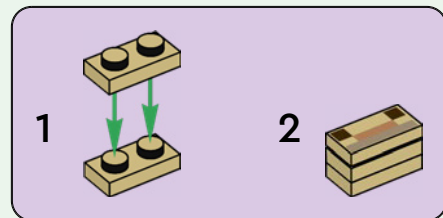

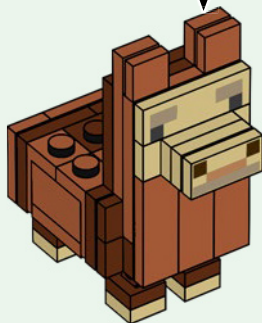





# MINECRAFT

21263



21261



21262





21264



21259



21260



 1x 302401	 5x 306801	 3x 4113917	 2x 6344028	 2x 4515368	 4x 302128	 7x 6294513	 3x 4614158	 3x 4173805
 6x 307001	 4x 6058329	 1x 6510522	 1x 6432005	 1x 370526	 1x 4112838	 2x 6442896	 2x 4579659	 2x 6092599
 2x 300501	 4x 300301	 1x 6174925	 1x 6360123	 12x 300528	 2x 6253139	 4x 6395814	 1x 6315197	 1x 6510771
 1x 6097028	 4x 300301	 1x 6173057	 1x 6411797	 2x 302428	 1x 4243821	 1x 6510527	 2x 6212081	 1x 6061676
 1x 6058177	 1x 302201	 1x 6510521	 1x 302224	 7x 4558593	 1x 4116671	 1x 6510526	 3x 6340118	 2x 4159007
 1x 6313115	 1x 6195371	 1x 6211966	 4x 307026	 1x 6170765	 1x 4116671	 2x 6399741	 3x 6074892	 2x 6106027
 1x 4264360	 1x 302101	 2x 6473604	 4x 6265699	 1x 6146227	 4x 6401817	 8x 6143431	 1x 6487946	 2x 6147047
 1x 393701	 2x 371001	 4x 302421	 4x 6210270	 8x 4157120	 3x 6195258	 8x 6143431	 1x 6487946	 2x 6147047
 1x 6510524	 3x 379501	 1x 302321	 1x 6020193	 2x 4125281	 6x 4647553	 4x 6515558	 1x 4535928	 2x 4125278
 1x 6361170	 4x 4159553	 1x 6126048	 4x 6250020	 1x 6510530	 8x 6343326	 5x 4570877	 3x 6511224	 1x 4118827

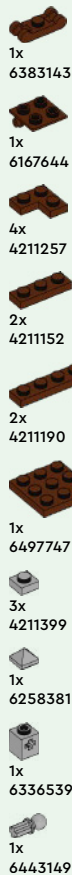
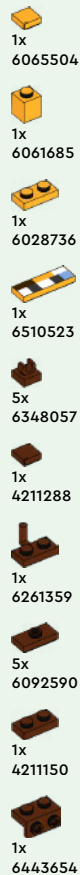

 [LEGO.com/service](https://www.LEGO.com/service)

YOU COULD  
**WIN**

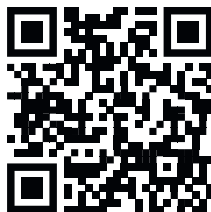

Scan this QR code or go to  
**LEGO.COM/PRODUCTFEEDBACK** and give  
us your short feedback about this LEGO® set  
for a chance to win a cool LEGO prize.

Terms and Conditions apply\*

**EN: YOU COULD WIN.** Terms and Conditions apply\* **DE: Du könntest GEWINNEN.** Es gelten die Teilnahmebedingungen\* **FR: Tu pourrais GAGNER.** Des conditions s'appliquent\* **IT: Potresti VINCERE tu.** Termini e condizioni sono applicabili\* **ES: Puedes GANAR.** Aplican términos y condiciones\* **PT: Poderá GANHAR.** Aplicam-se termos e condições\* **ZH: 轻松获奖. 条款和条件适用\*** **PL: Szansa na WYGRANĄ.** Obowiązują warunki korzystania\* **CS: Máte šanci VYHRÁT.** Platí všeobecné smluvní podmínky\* **SK: Máte šancu VYHRAŤ.** Platia všeobecné zmluvné podmienky\* **HU: TE IS NYERHETSZ.** Felhasználási feltételek érvényesek\* **RO: Ai putea CÂȘTIGA.** Se aplică termenii și condiții\* **BG: Можете да СПЕЧЕЛИТЕ.** Има определени правила и условия\* **LV: Tu vari LAIMĒT.** Ir spēkā noteikumi un nosacījumi.\* **ET: Sul on võimalus VÕITA.** Kehtivad tingimused\* **LT: Jūs galite LAIMĖTI.** Taikomos sąlygos\*

\*[LEGO.com/productfeedback-terms](https://www.lego.com/productfeedback-terms)

LEGO and the LEGO logo are trademarks of the/son des marques de commerce du/son marcas registradas de LEGO Group. ©2024 The LEGO Group.  
© 2024 Mojang AB. All Rights Reserved. Minecraft, the Minecraft logo, the Mojang Studios logo and the Creeper logo are trademarks of the Microsoft group of companies.

6541114