



FORTNITE®

77070





Q LEGO® Builder



LEGO.com/sustainable-packaging



FR
DONNEZ
OU
RECYCLEZ

 OU  OU 

ASSOCIATION MAGASIN DÉCHÈTERIE

Adresses sur quefairedemesdechets.fr

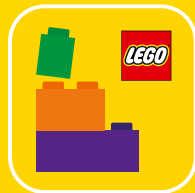

LEGO® Builder

BUILDER



Apple and the Apple logo are trademarks of Apple Inc., registered in the U.S. and other countries and regions. App Store is a service mark of Apple Inc. Google Play and the Google Play logo are trademarks of Google LLC. Tencent and the Tencent logo are trademarks of Tencent Inc.

LEGO.com/devicecheck

EN Ask parents' permission before going online | **DE** Eltern um Erlaubnis bitten, bevor du online gehst | **FR** Demande l'autorisation d'un parent avant d'aller en ligne | **IT** Chiedi il permesso ai tuoi genitori prima di andare online | **ES** Pídeles permiso a tus papás antes de conectarte a Internet | **PT** Peça autorização aos pais antes de acederes online | **ZH** 上网前应先征得父母的同意 | **PL** Poproś rodziców o zgodę, zanim wejdiesz do Internetu | **CS** Než půjdeš na internet, požádej rodiče o svolení | **SK** Skôr než pôjdeš na internet, vypýtaj si povolenie od rodičov | **HU** Kérj szülői engedélyt, mielőtt online csatlakoznál! | **RO** Cere permisiunea părinților înainte de a te conecta online | **BG** Поискайте разрешение от родител, преди да влезете онлайн | **LV** Pirms došanās tiešsaistē palūdz atļauju vecākiem | **ET** Enne Interneti kasutamist küsi vanematelt luba | **LT** Prieš prisijungdami prie interneto, atsiklauskite tėvų



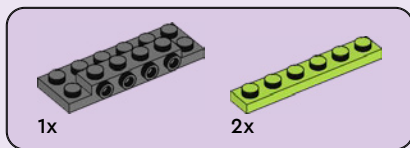

1

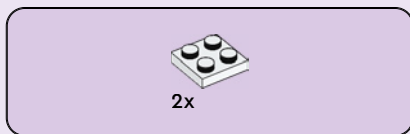
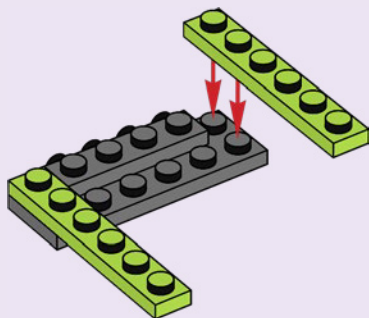

2

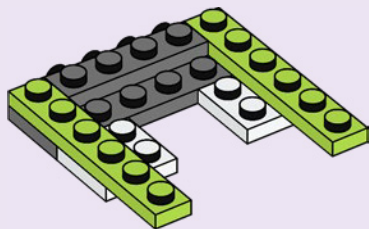



1x

3

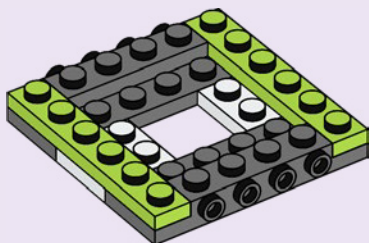

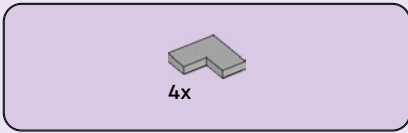

4

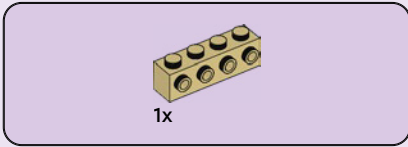
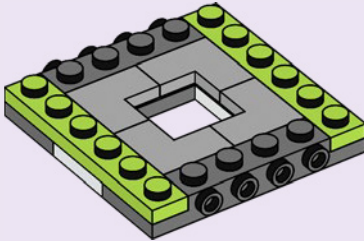

5

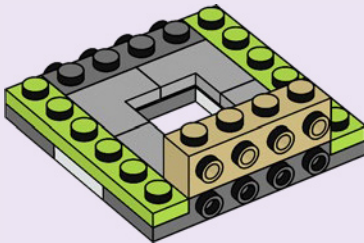

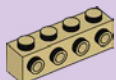

3x

6

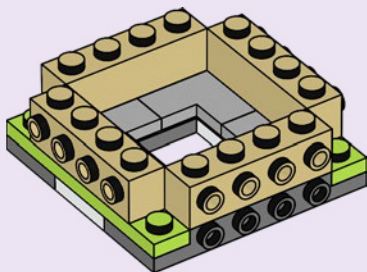



4x

7

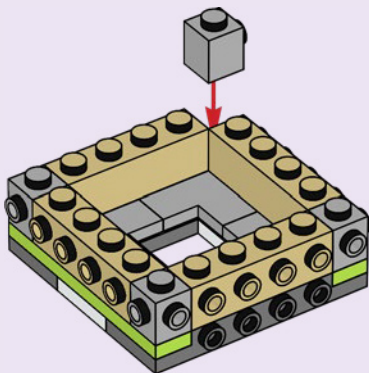



2x



4x

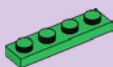

2x



2x



2x



2x



2x

8

1

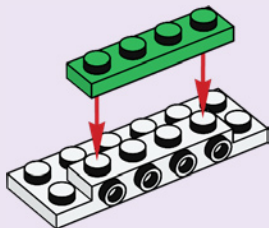

2

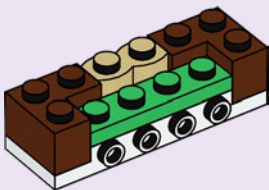

3

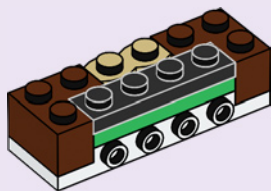

4

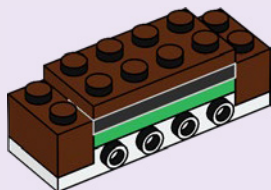

2x

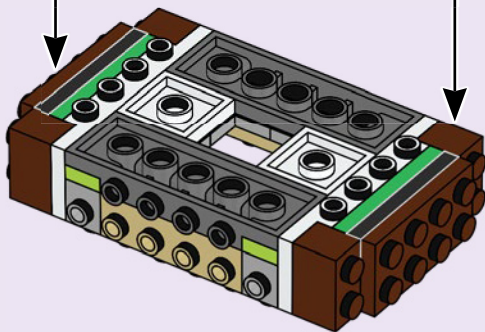

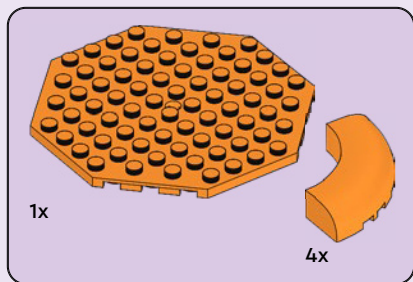

9

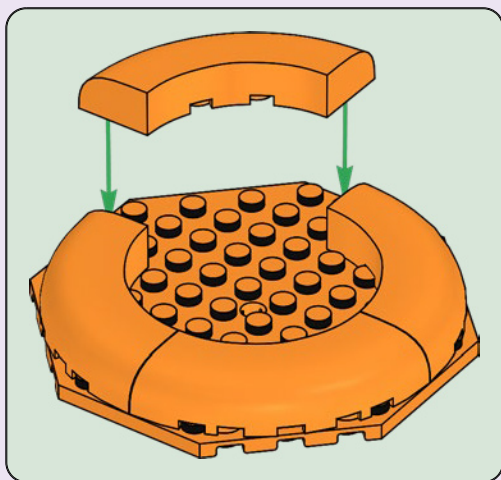

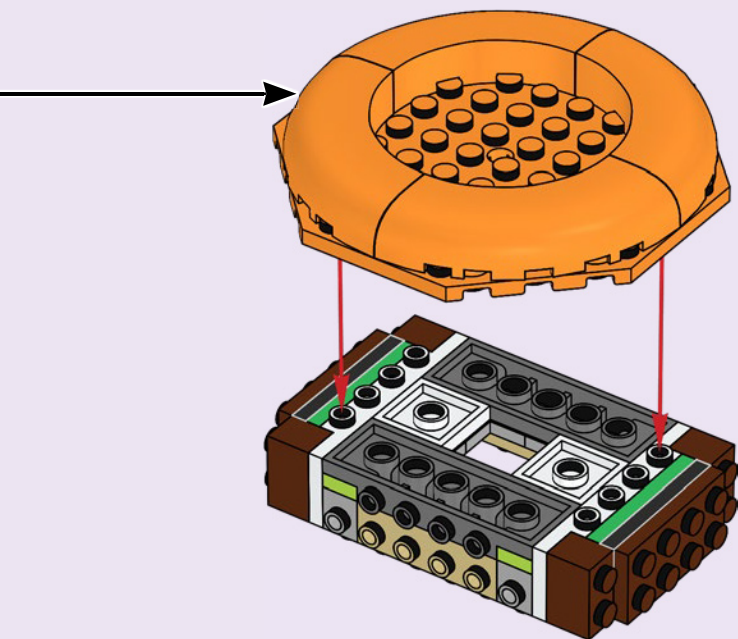
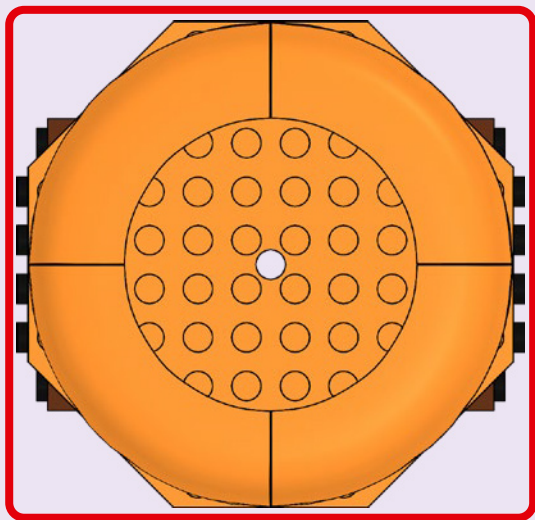



2x

10

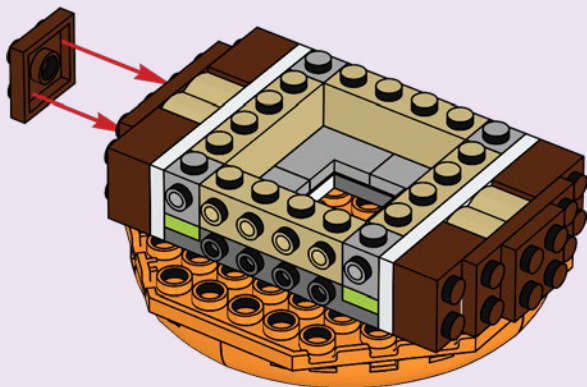

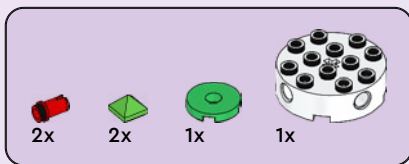

11

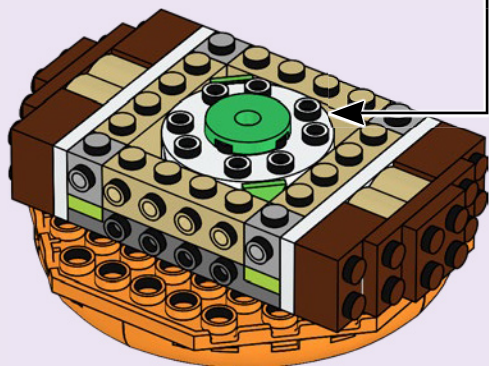
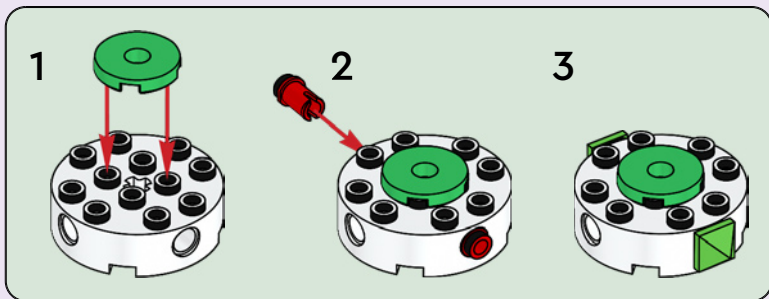



2x

12

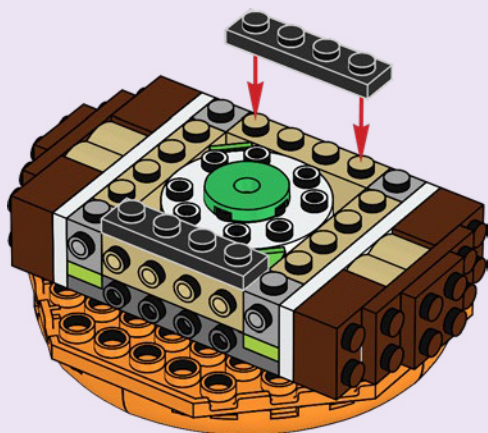



6x

13

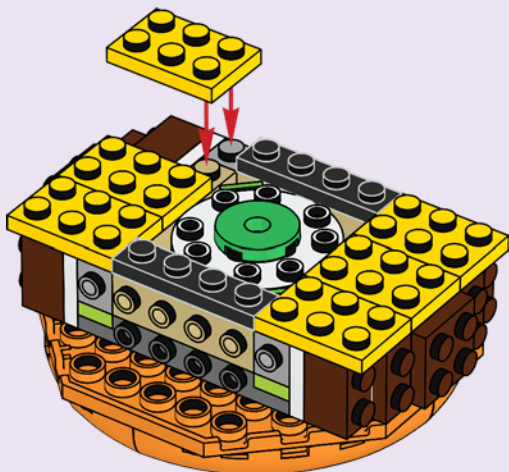

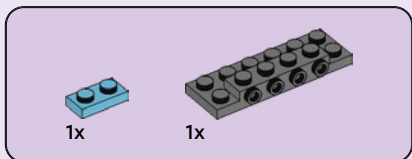
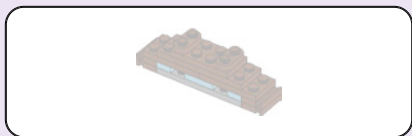

14

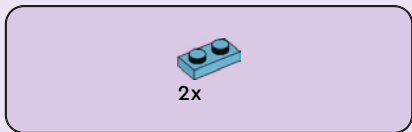
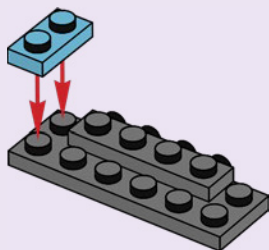

15

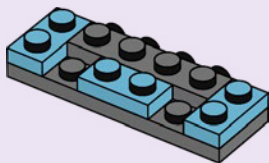

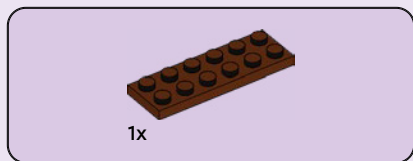

17

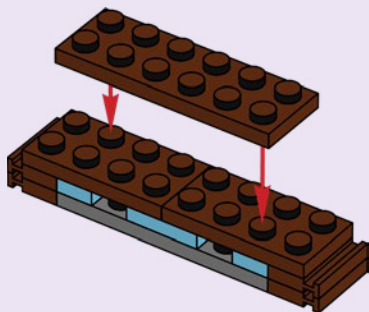

18

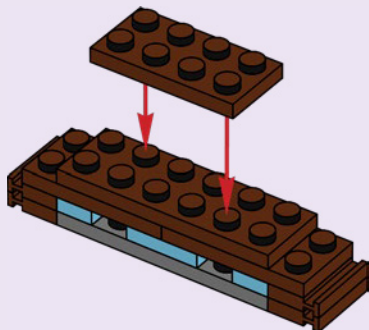



2x

19

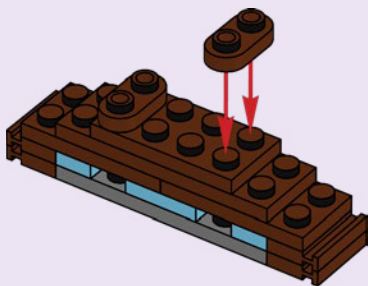

20

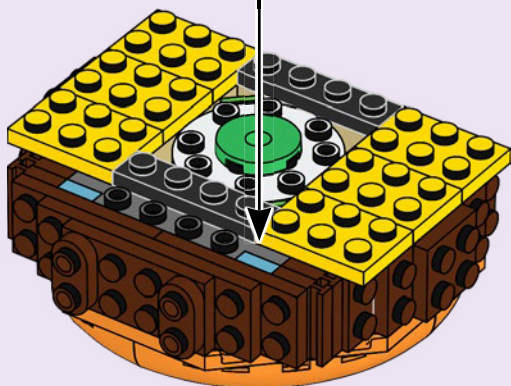



1x



1x

21

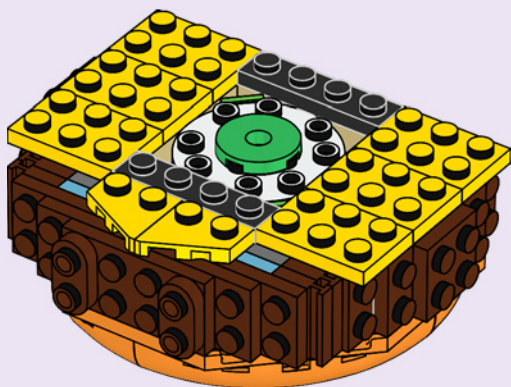



1x



2x



2x

22

1



2



3

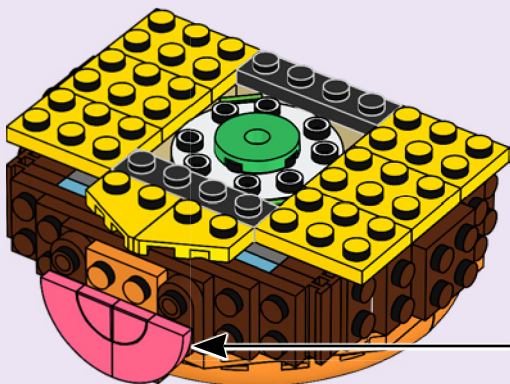
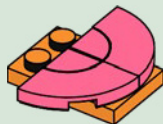

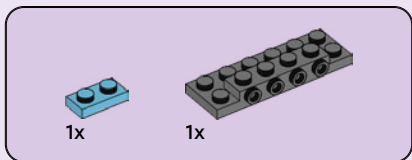
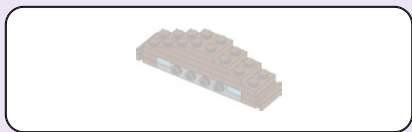

23

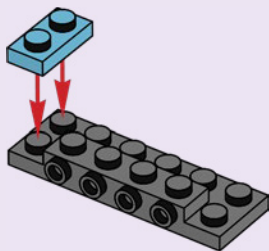

24

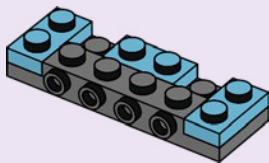

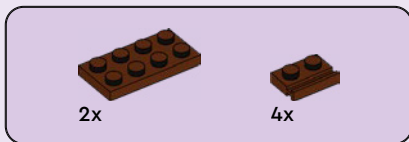

25

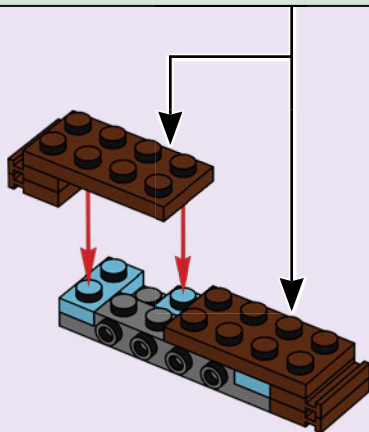
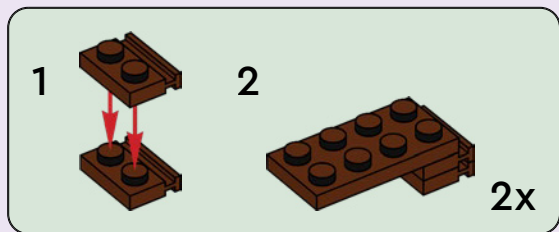



1x

26

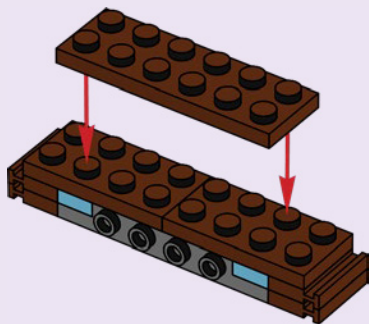

1x

27

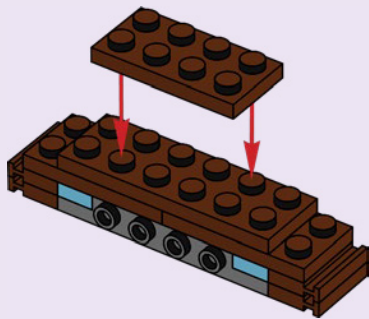



1x

28

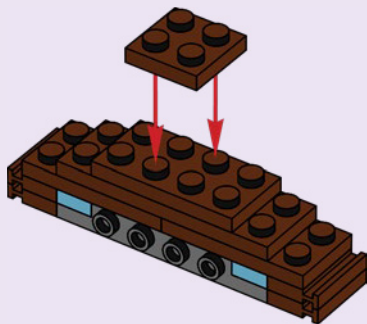

29

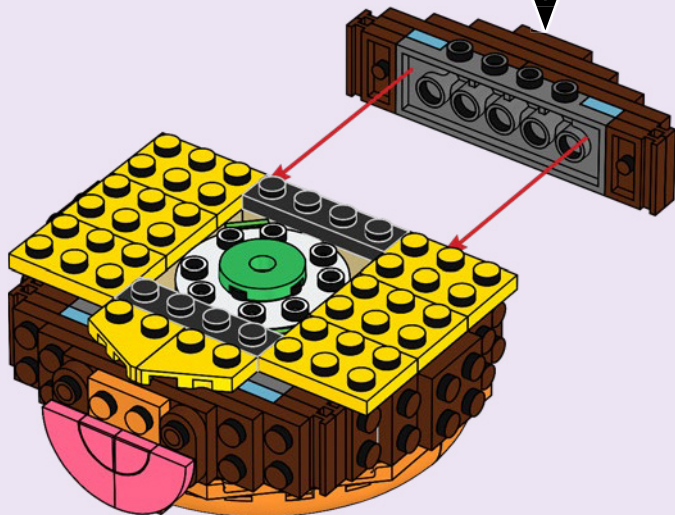

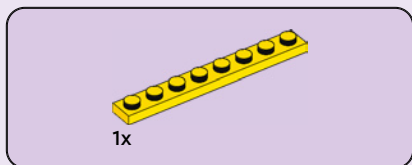

30

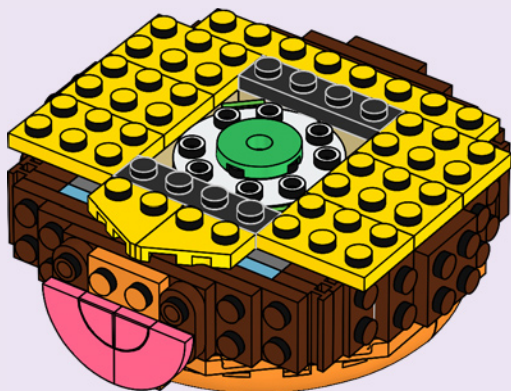

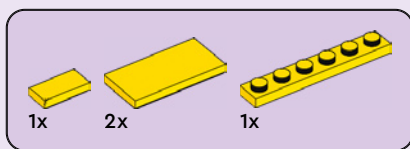

31

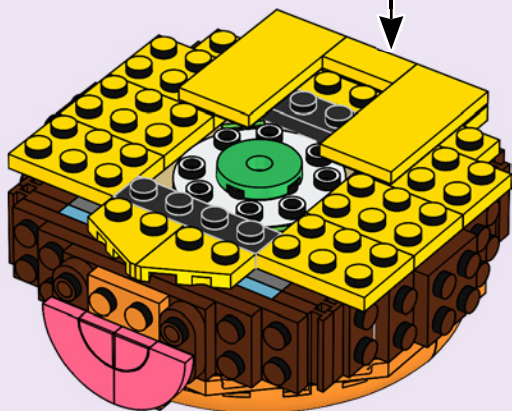
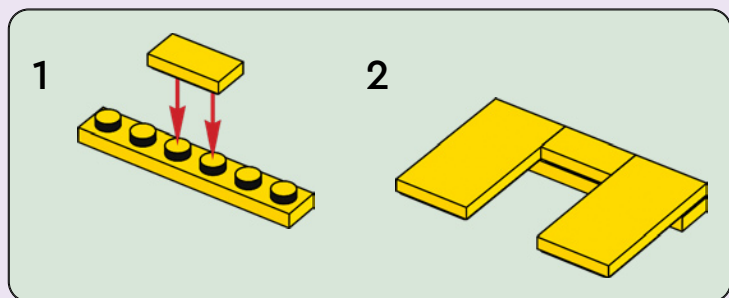

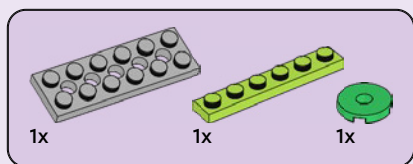

32

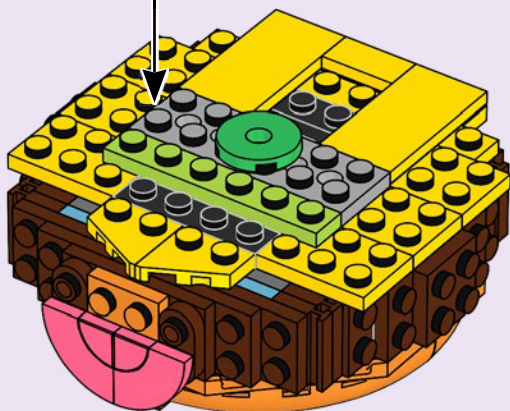
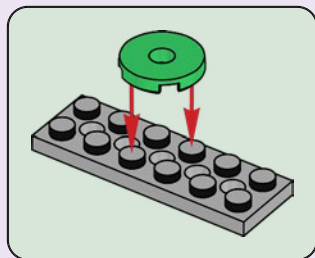



2x



2x

33

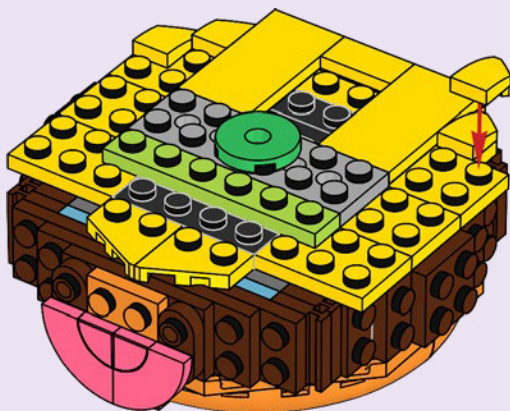



2x

34

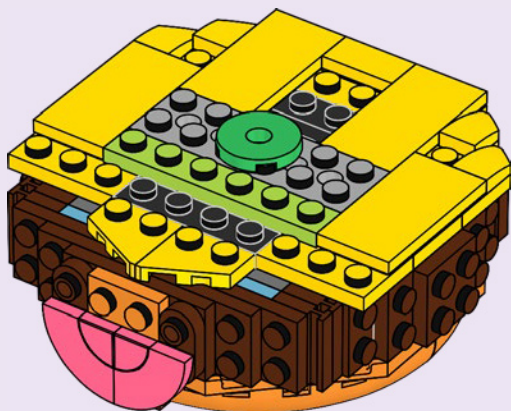

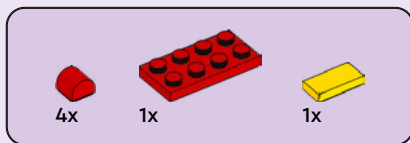

35

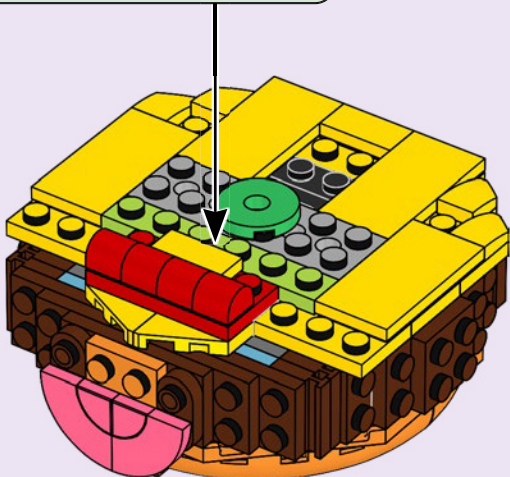
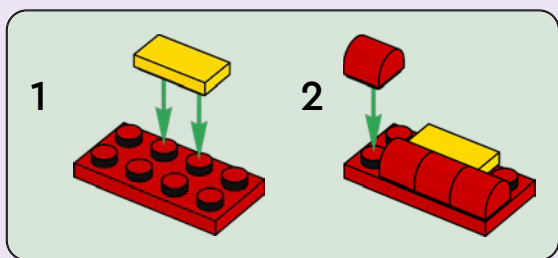



2x



1x



1x

36

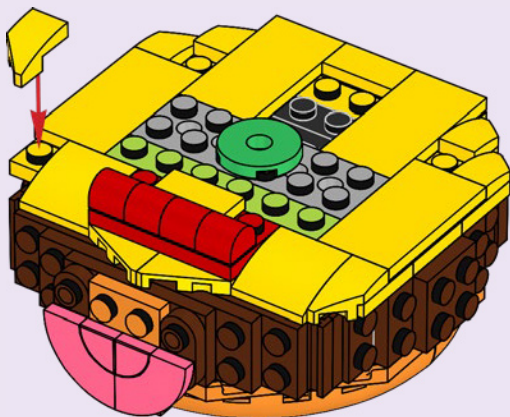

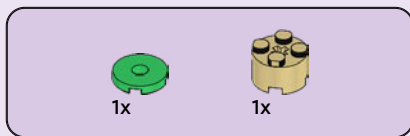

37

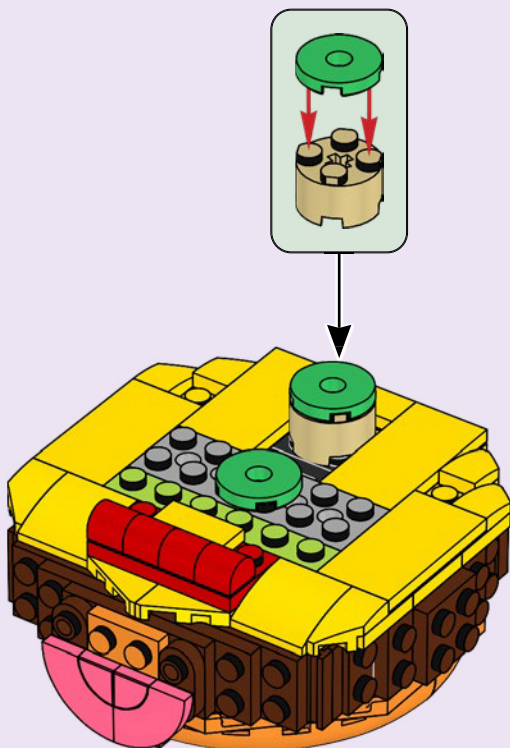



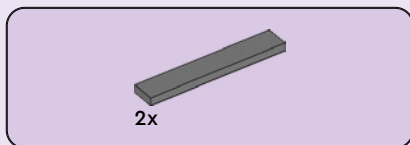

38

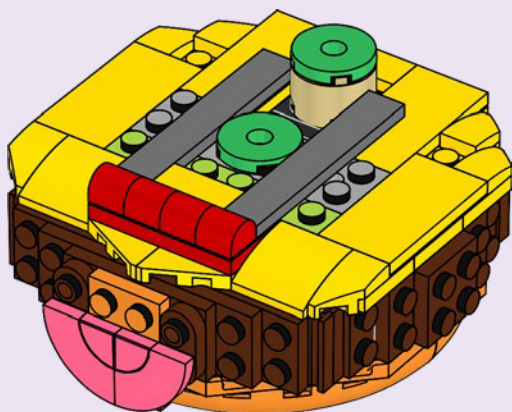

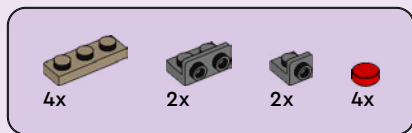

39

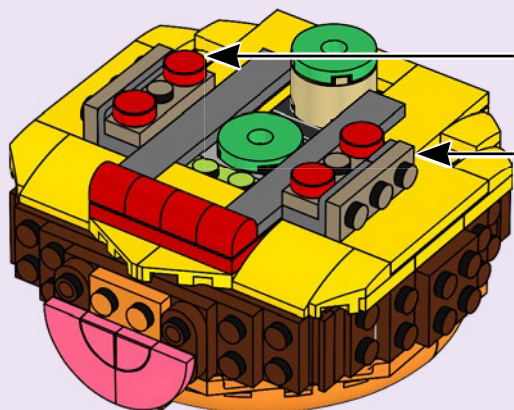
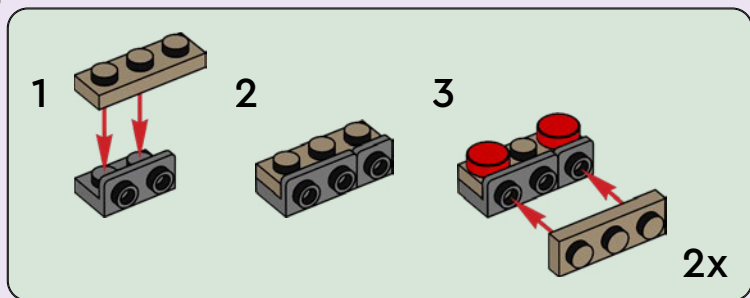

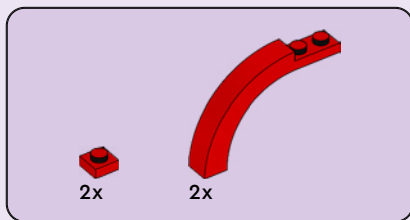

40

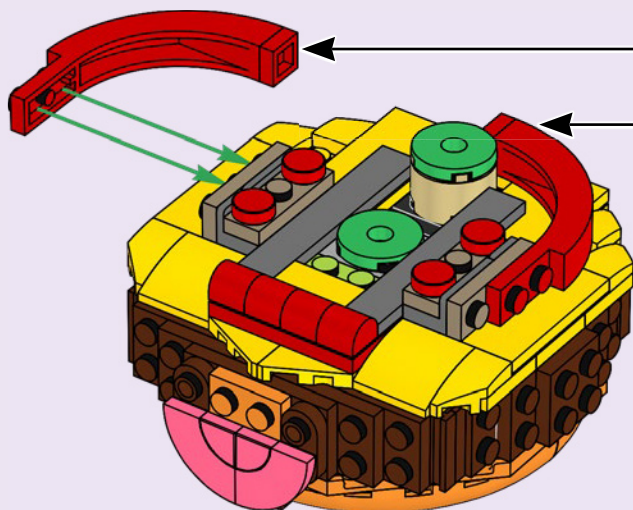
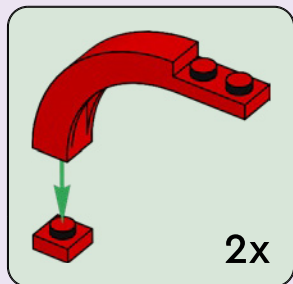



2x

41

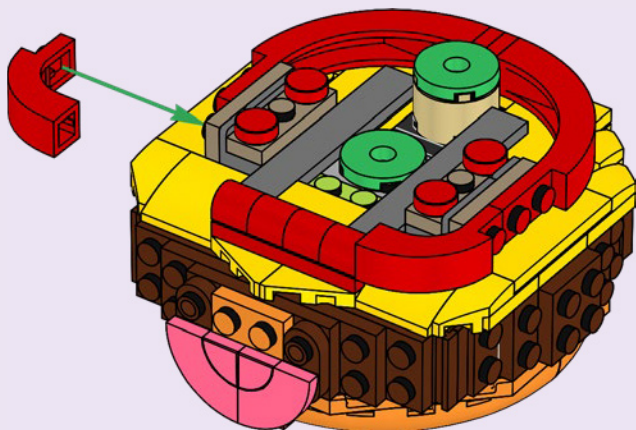



2x

42

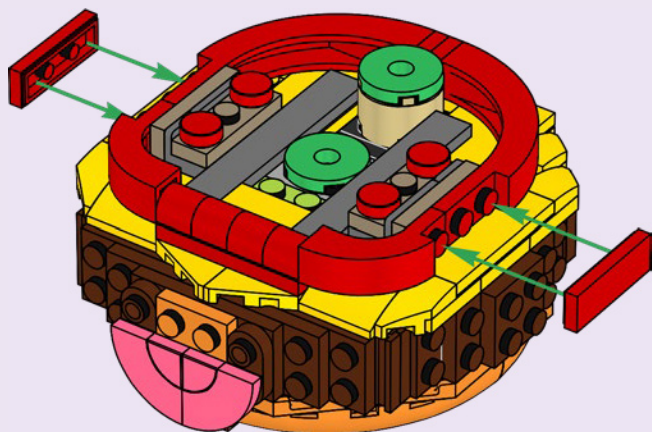

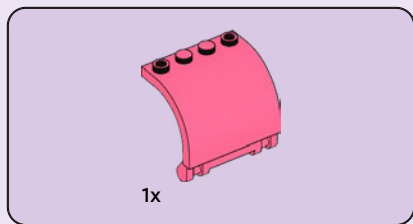

43

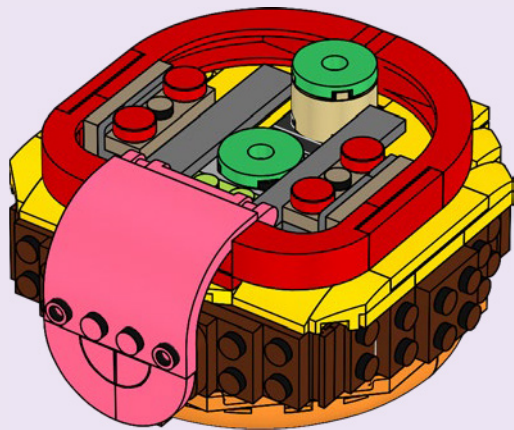

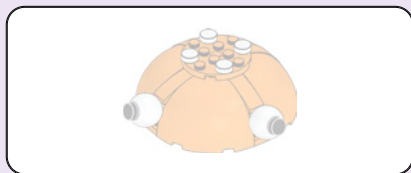

44



45

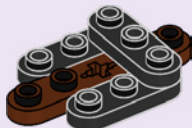



2x



1x

46

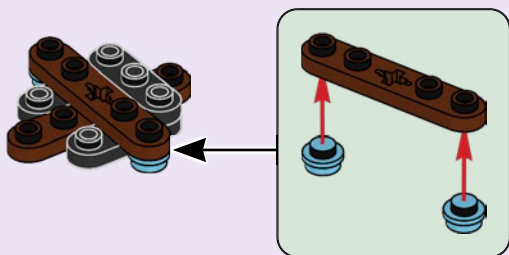



1x

47





2x

48

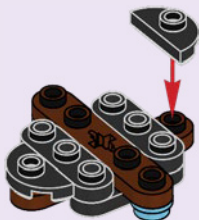

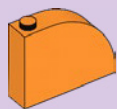

2x

49

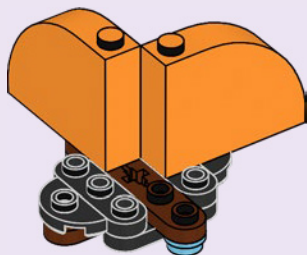

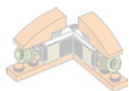

1x



1x

50

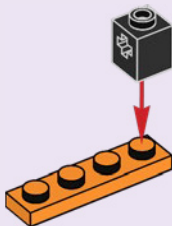

1x

51

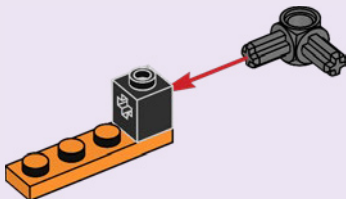



1x



1x

52

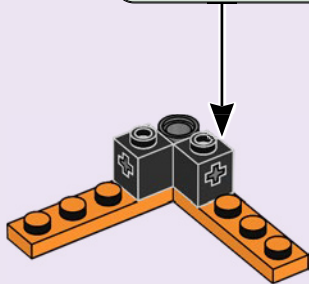
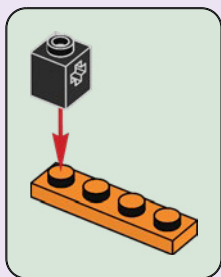



2x



2x

53

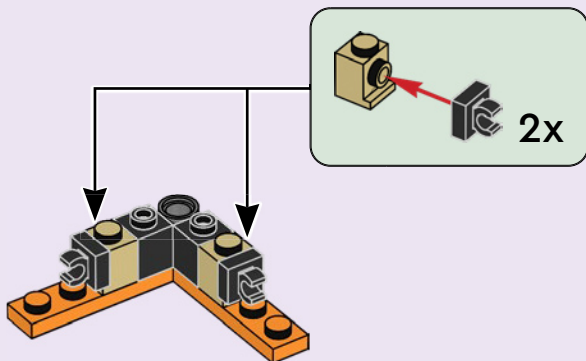



2x

54

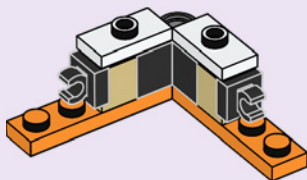



2x

55

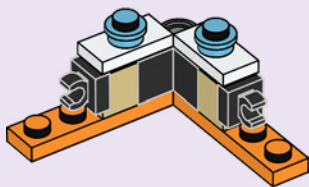

2x



2x

56



2x

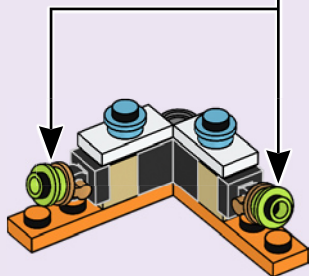



2x

57

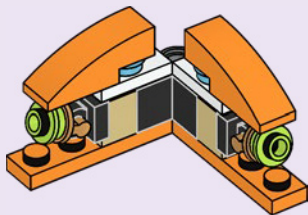

58

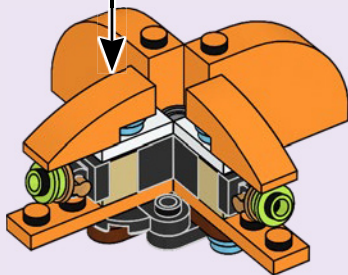

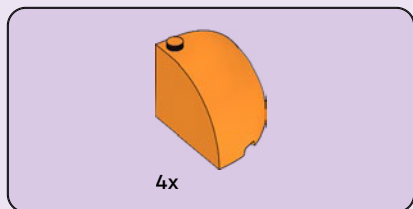

59

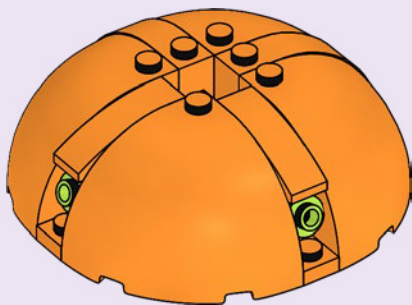



1x

60

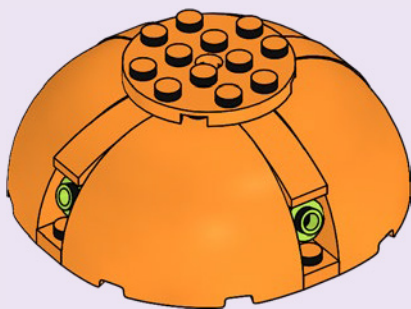



4x

61

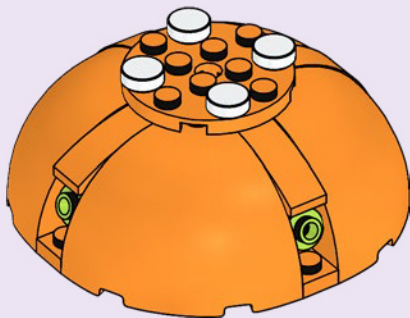



62



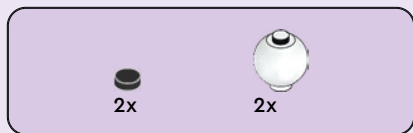

63

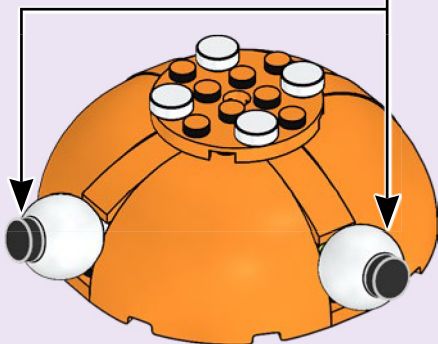
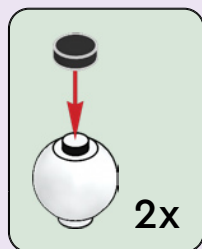

64

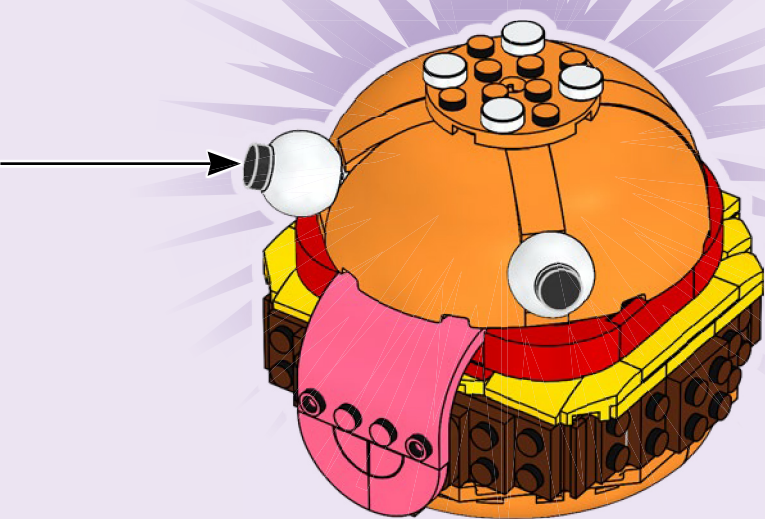

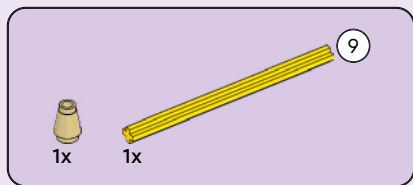

65

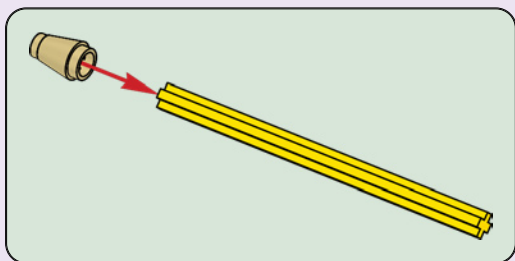

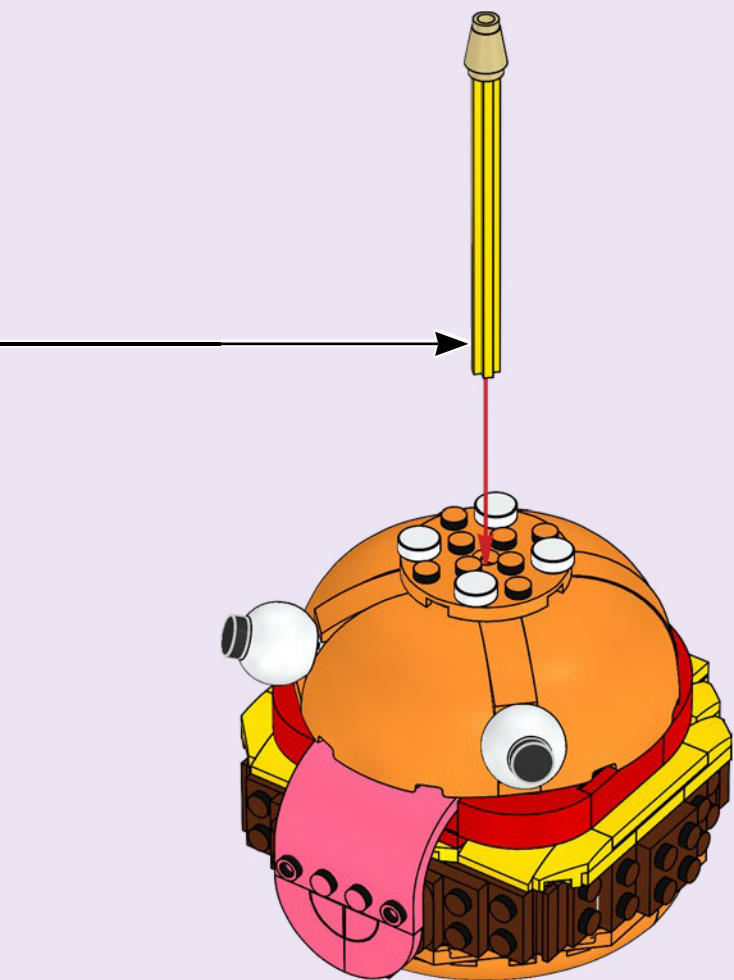



1x



1x

66

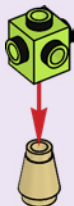



67

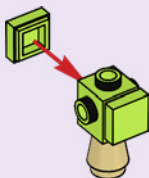

68

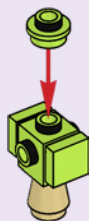



2x

69





1x



1x

70

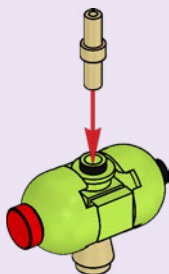

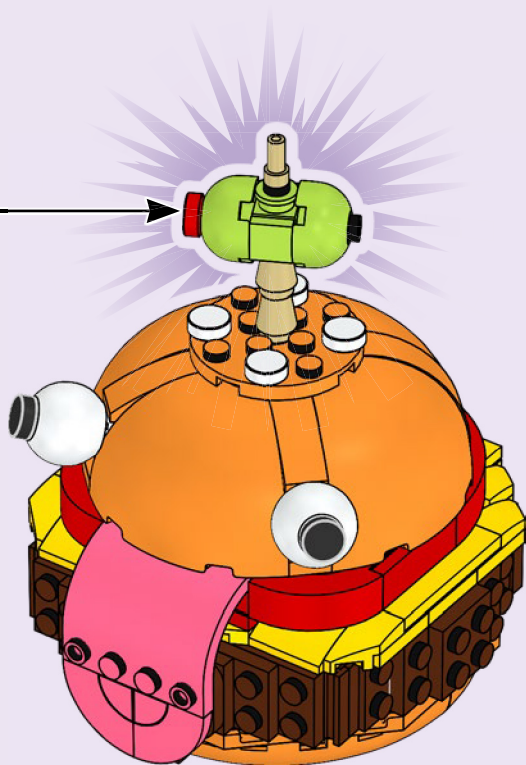

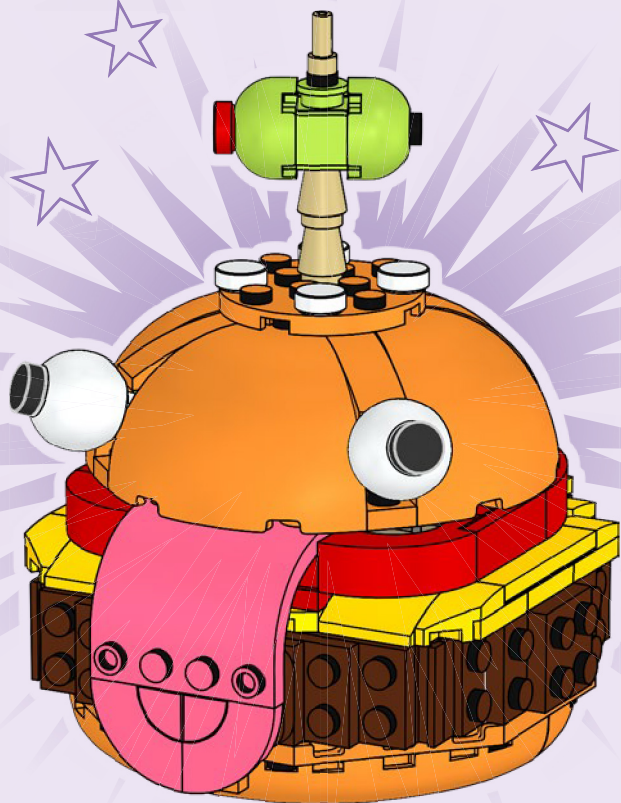



FORTNITE

77072



77070



77071

77073



4x
6284572

2x
6221773

2x
6051511

2x
302201

1x
4203583

2x
6430548



2x
4529237

2x
4118793

3x
6447501

1x
4125220

2x
4218749

4x
4201062

5x
6284574

4x
6278441

2x
6378120

2x
302421

2x
4533742

2x
6212012

1x
302021

2x
6297822

3x
6289740

1x
6132609

1x
6132201

3x
6289743

2x
306924



2x
6079007

6x
302124

4x
4560181

1x
366624

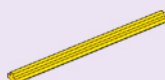
1x
346024

1x
6130010

2x
6284070

2x
6335388

2x
6344819

2x
6438919

4x
6428168

4x
371026

2x
4251969

4x
6515842

1x
4125278

2x
4118782

2x
6515841

1x
6226926

4x
6515840

1x
6515843

3x
6190251

2x
4537251

1x
6174006

2x
6429057

3x
4529160

2x
6248944

8x
4645103

4x
4211200

3x
4216695

2x
6280388

8x
4211186

2x
4211247

4x
6267495

4x
6065824

1x
4211542

4x
6132768

3x
6074954

2x
6299946

2x
371028

2x
6501299

4x
6102986

6x
6097419

2x
6250022

2x
6250024

1x
6510319

2x
6225494

1x
6005331

2x
6000606

2x
4210651

4x
6401210



 [LEGO.com/service](https://www.LEGO.com/service)

YOU COULD

WIN



Scan this QR code or go to **LEGO.COM/PRODUCTFEEDBACK** and give us your short feedback about this LEGO® set for a chance to win a cool LEGO prize.

Terms and Conditions apply*

EN: YOU COULD WIN. Terms and Conditions apply* **DE: Du könntest GEWINNEN.** Es gelten die Teilnahmebedingungen* **FR: Tu pourrais GAGNER.** Des conditions s'appliquent* **IT: Potresti VINCERE tu.** Termini e condizioni sono applicabili* **ES: Puedes GANAR.** Aplican términos y condiciones* **PT: Poderá GANHAR.** Aplicam-se termos e condições* **ZH: 轻松获奖. 条款和条件适用*** **PL: Szansa na WYGRANĄ.** Obowiązują warunki korzystania* **CS: Máte šanci VYHRÁT.** Platí všeobecné smluvní podmínky* **SK: Máte šancu VYHRAŤ.** Platia všeobecné zmluvné podmienky* **HU: TE IS NYERHETSZ.** Felhasználási feltételek érvényesek* **RO: Ai putea CÂȘTIGA.** Se aplică termenii și condiții* **BG: Можете да СПЕЧЕЛИТЕ.** Има определени правила и условия* **LV: Tu vari LAIMĒT.** Ir spēkā noteikumi un nosacījumi.* **ET: Sul on võimalus VÕITA.** Kehtivad tingimused* **LT: Jūs galite LAIMĖTI.** Taikomos sąlygos*

*[LEGO.com/productfeedback-terms](https://www.lego.com/productfeedback-terms)