



Get excited about our new packaging!

We're switching from plastic to paper-based packaging. That's why you might find a mix of paper and plastic in our boxes!

Nos nouveaux emballages vous emballeront !

Nous passons des emballages en plastique aux emballages à base de papier. C'est pourquoi vous pourriez trouver un mélange de papier et de plastique dans nos boîtes !

¡Te presentamos nuestros nuevos empaques!

Estamos sustituyendo las bolsas de plástico por bolsas con base de papel. ¡Por eso, puedes encontrar una mezcla de papel y de plástico en nuestras cajas!

[LEGO.com/sustainable-packaging](https://www.lego.com/sustainable-packaging)

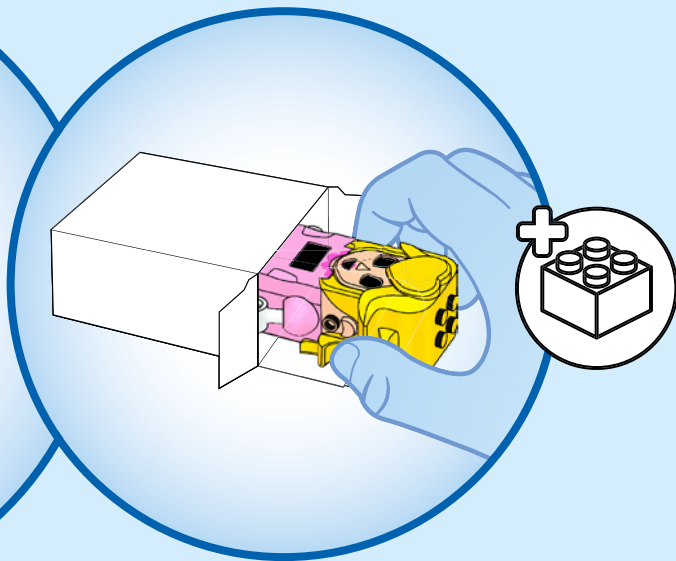

AVERTISSEMENT : RISQUE D'ÉTOUFFEMENT.

Le jouet contient des petites pièces ainsi qu'une petite boule.
Il ne convient pas aux enfants de moins de 3 ans.



ADVERTENCIA: PELIGRO DE ASFIXIA.

Juguete que contiene partes pequeñas y una pelota pequeña.
No recomendado para niños menores de 3 años.

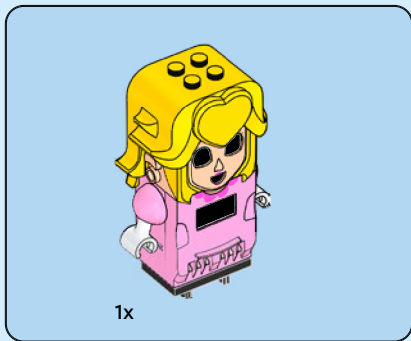

1

4

1

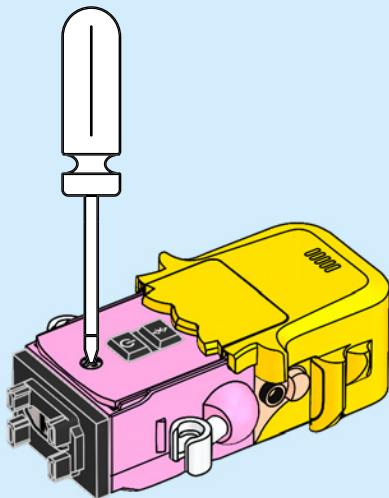

2

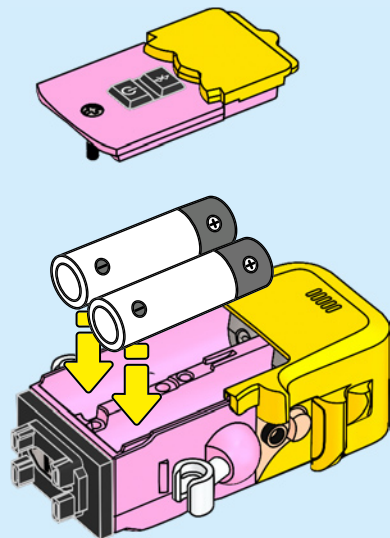

2x AAA

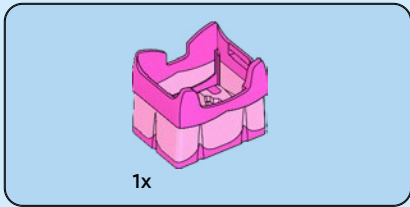

2

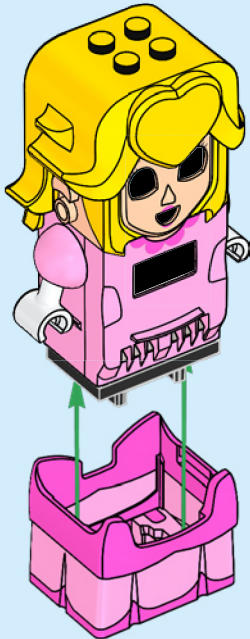
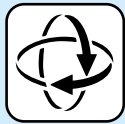

3



4

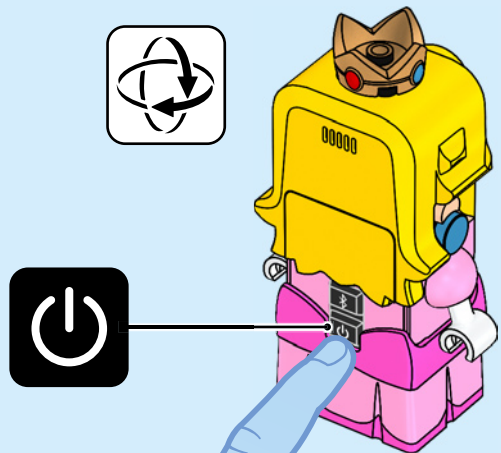

6

5



6



7



Update your LEGO® Peach™ in the LEGO® Super Mario™ app to get new features



Pour bénéficier de nouvelles fonctionnalités, faites une mise à jour de votre LEGO® Peach™ dans l'application LEGO® Super Mario™

Actualiza tu LEGO® Peach™ en la app LEGO® Super Mario™ para recibir nuevas funciones

8

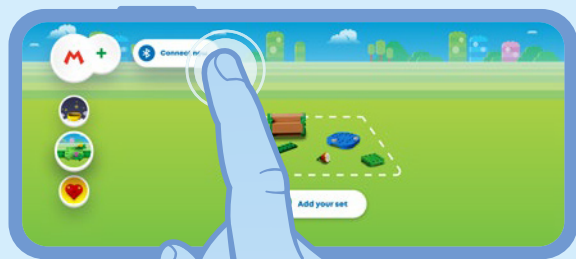

9

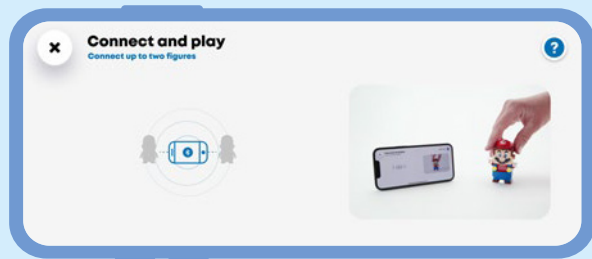

10

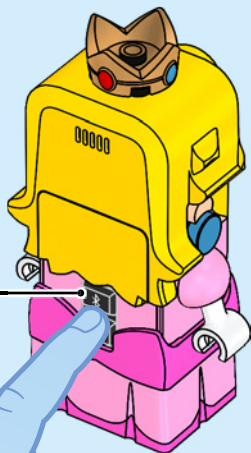

10

11

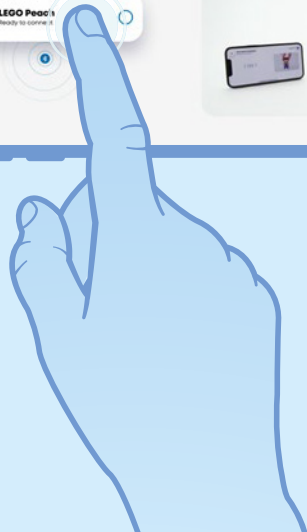
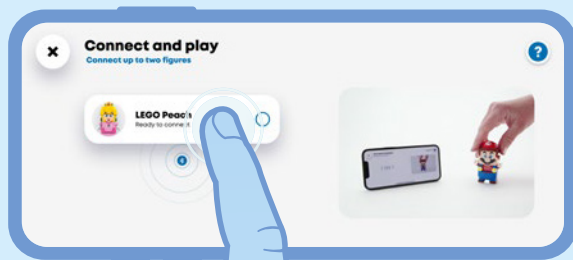

12

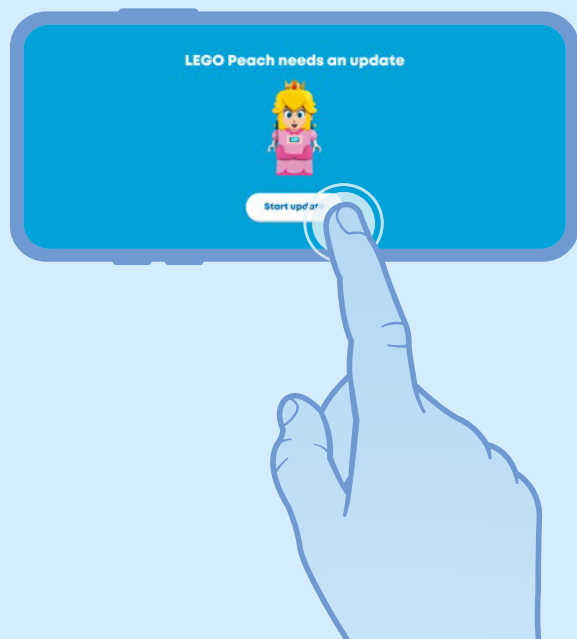

13

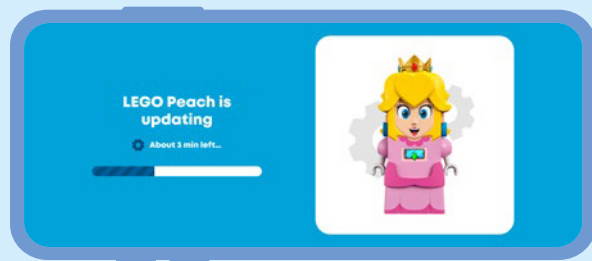

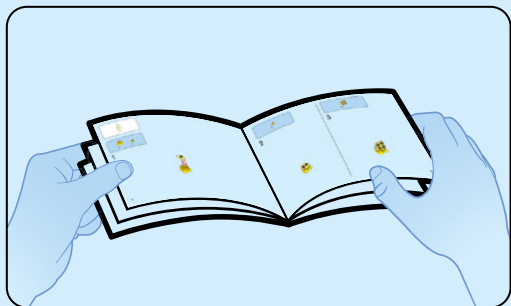

14

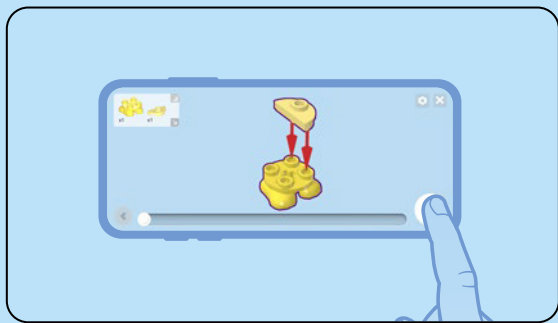
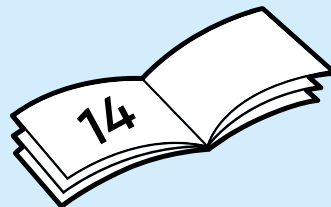

14



15

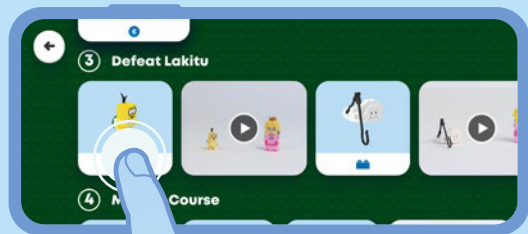

16





1x



1x

1

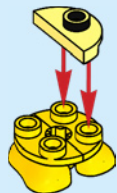



1x

2



1x

3





2x

4

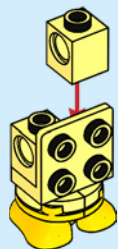



2x

5

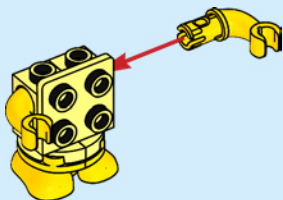

1x

6

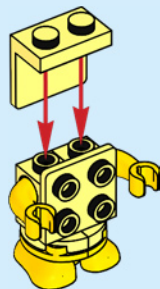



1x

7

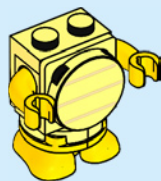



1x



1x

8

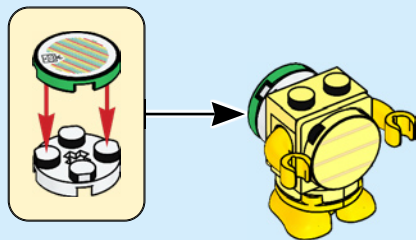

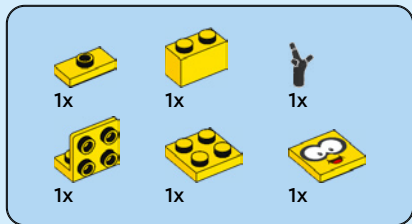

9

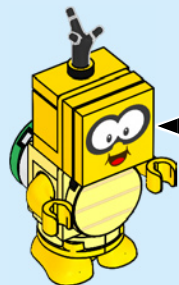
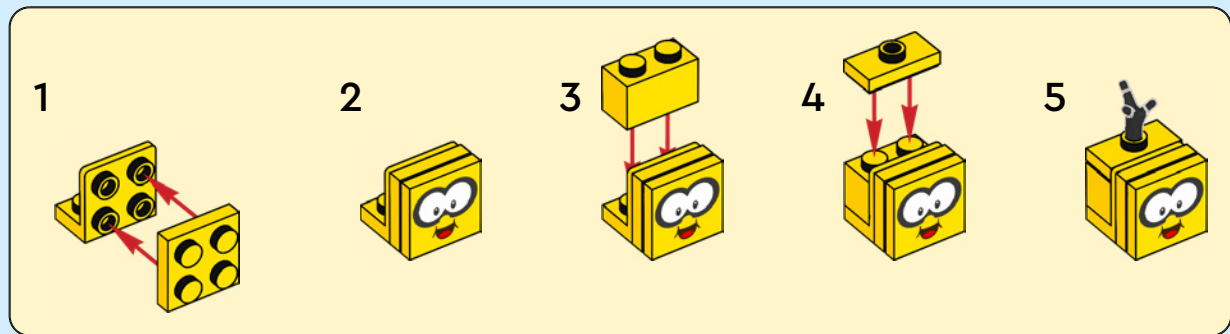

10

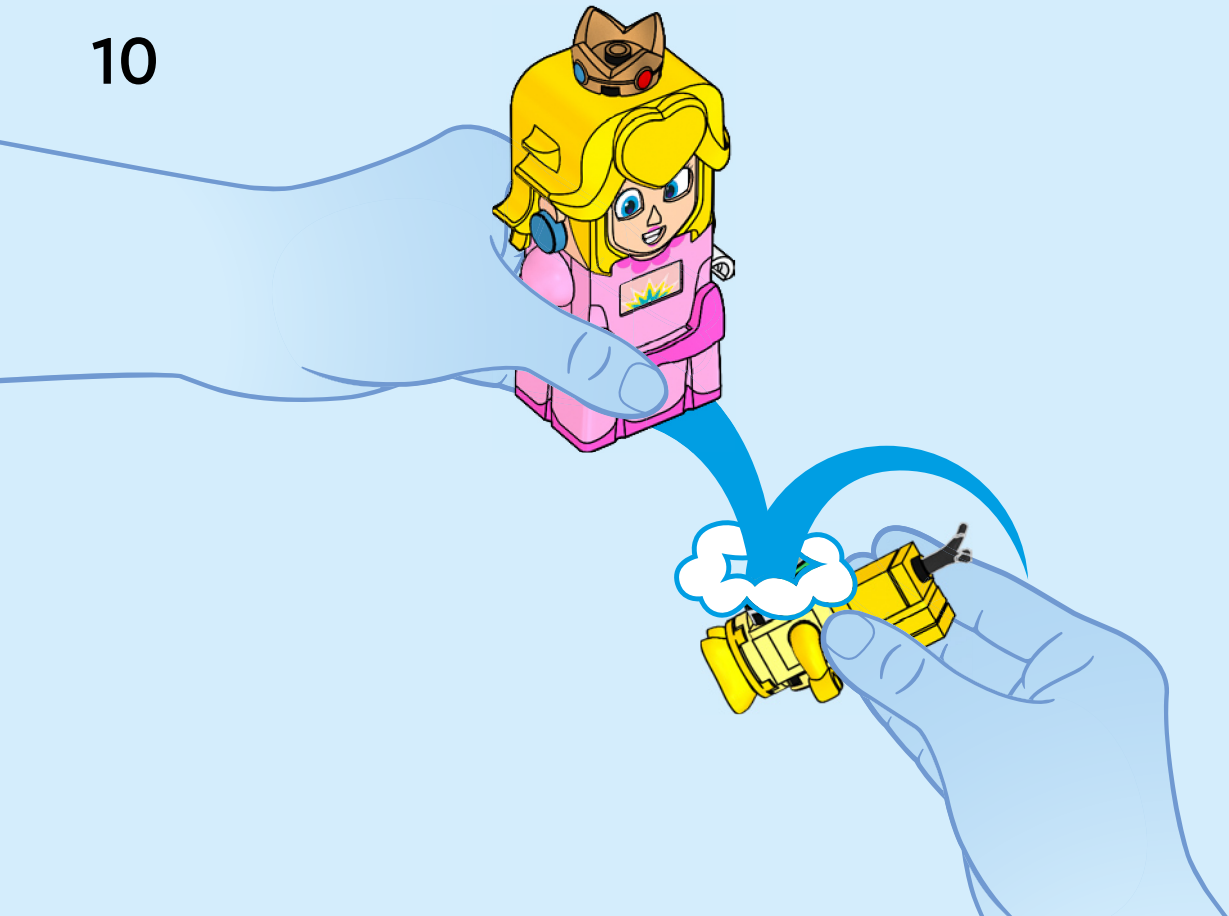

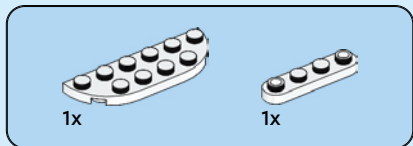
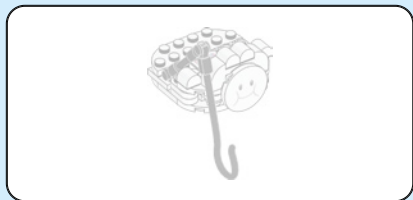

1

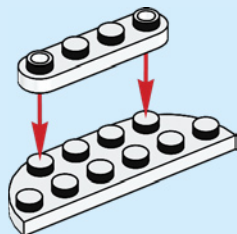

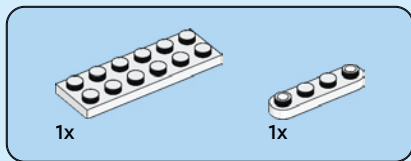

2

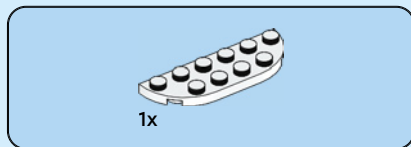
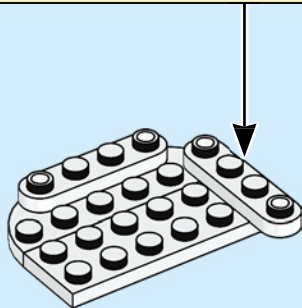
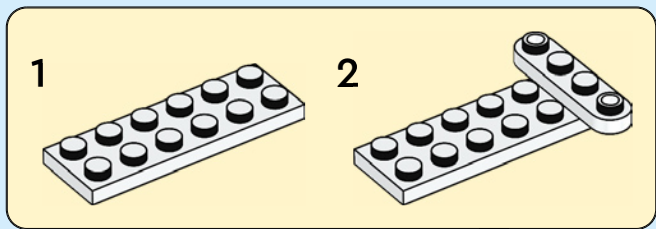

3

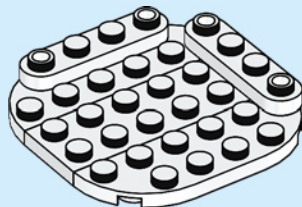

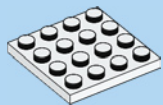

1x

4

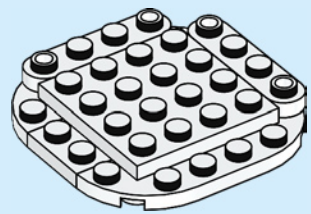

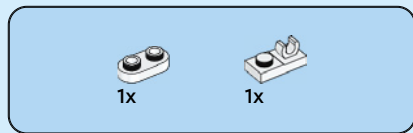

5

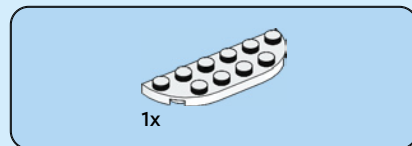
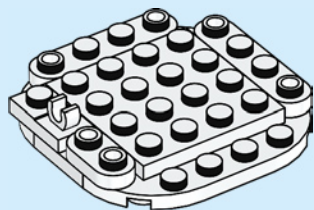

6

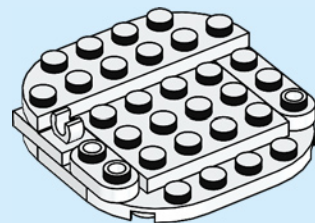



1x



2x

7

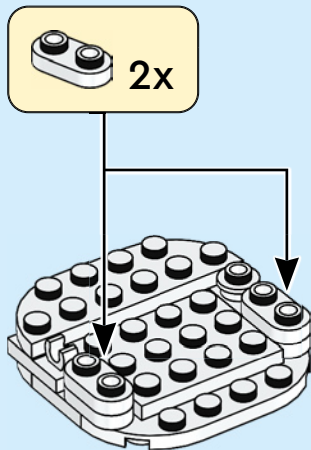



8

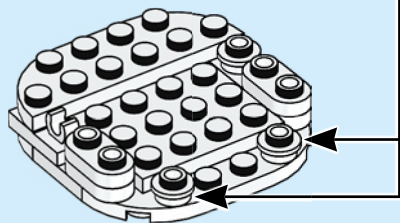

9

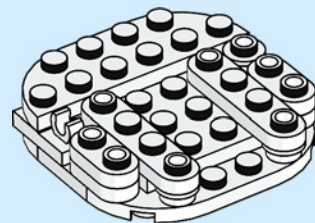



1x

10

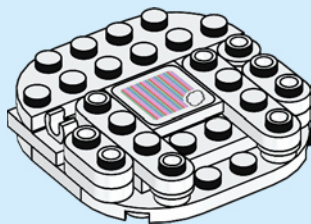



1x

11

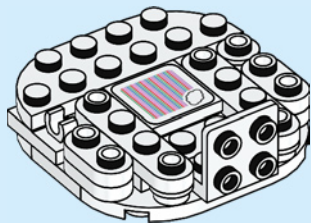

1x

12

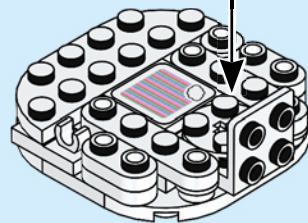

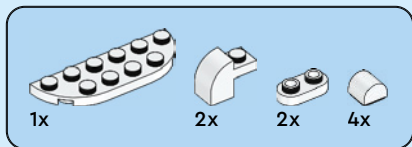

13

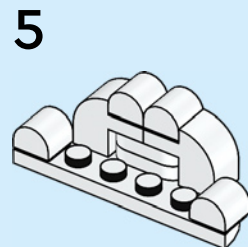
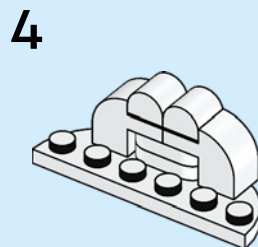
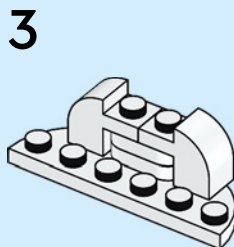
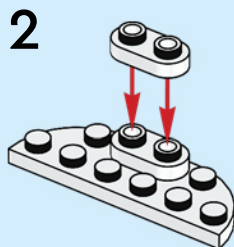
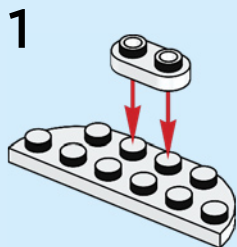





1x

14

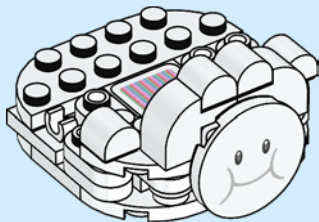

1x

15

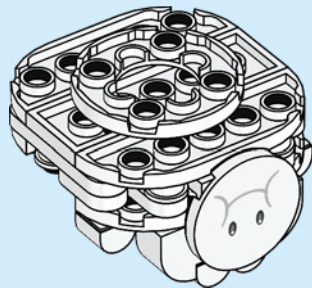

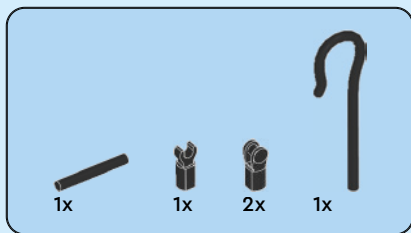

16

1

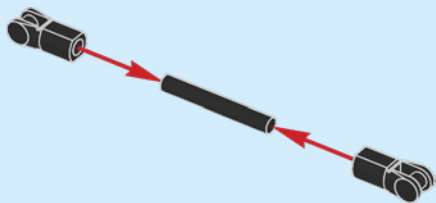

2

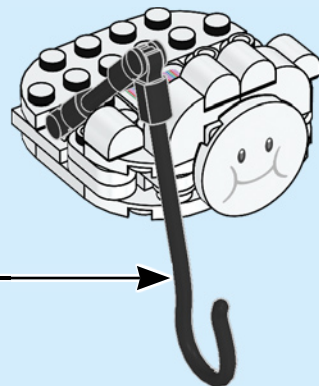
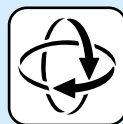
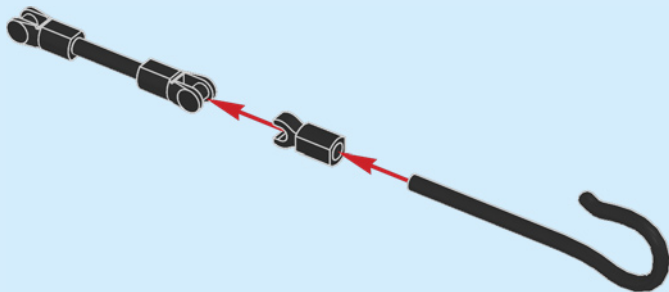

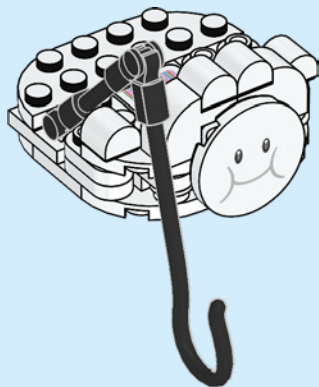

18

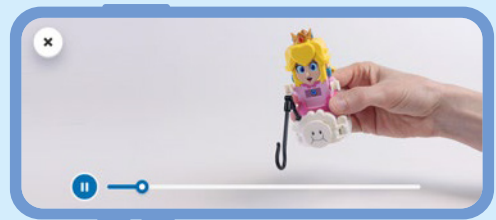
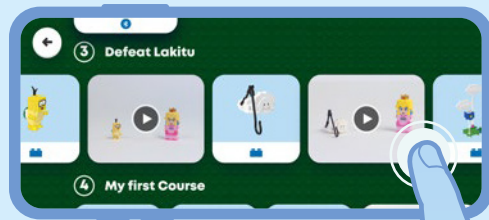

19

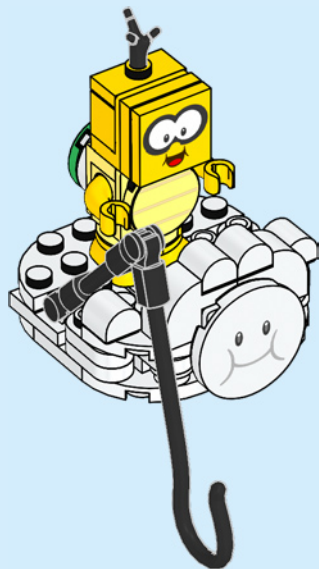

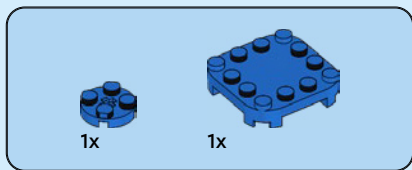
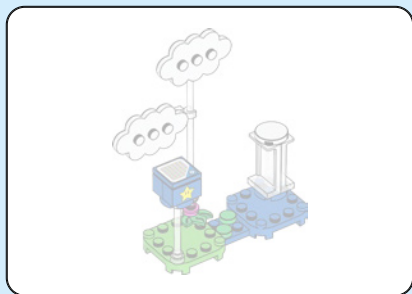

1

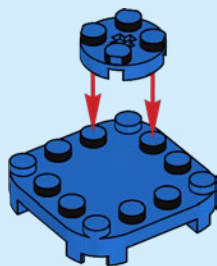

2



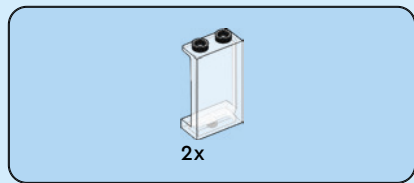

3

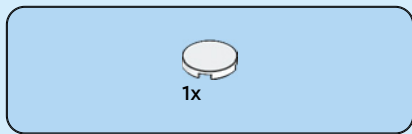
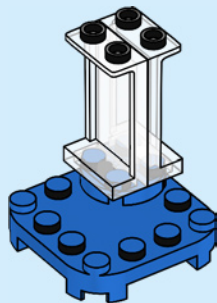

4

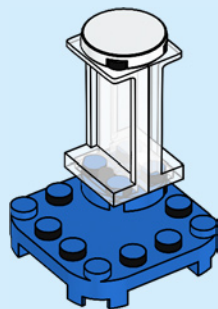

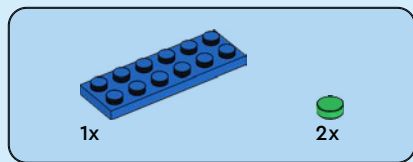

5

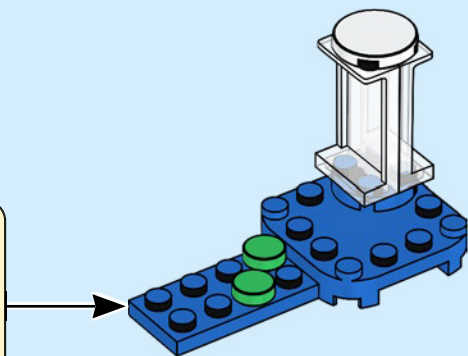
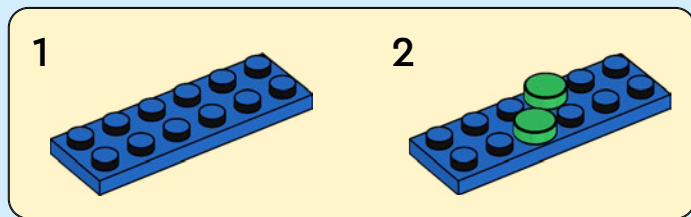

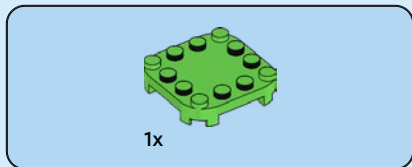

6

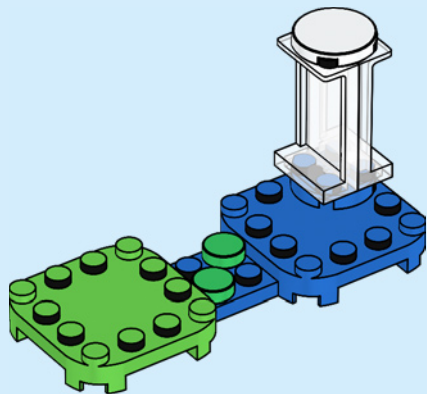

7

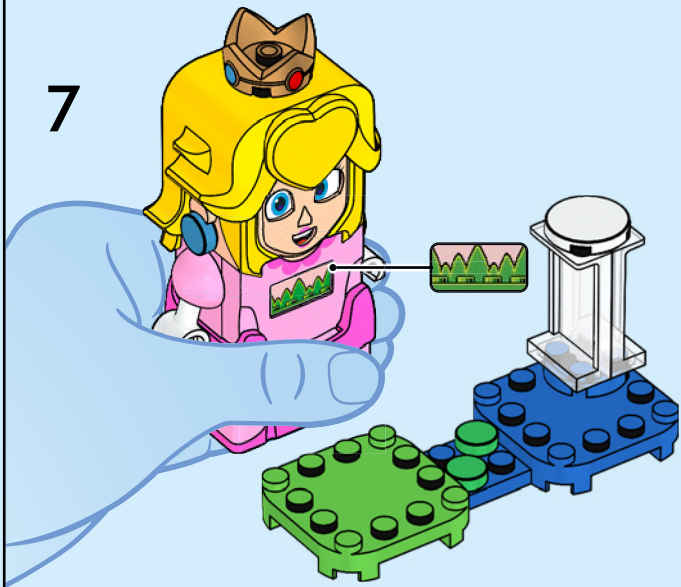



1x



1x

8

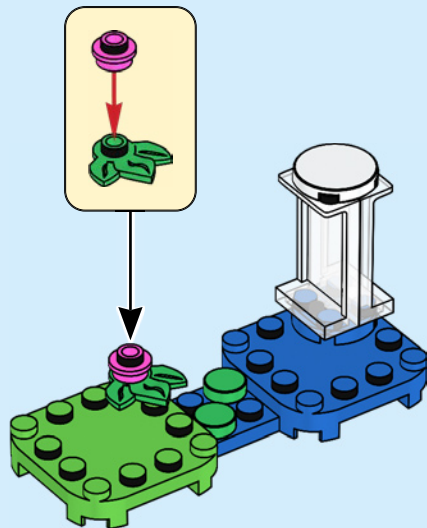

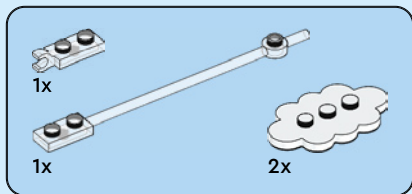

9

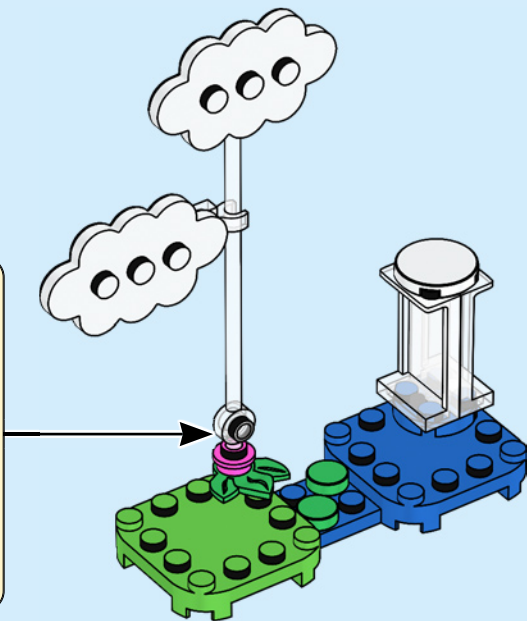
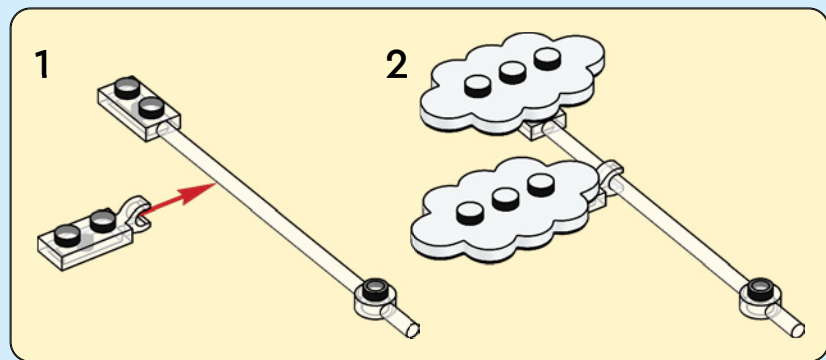

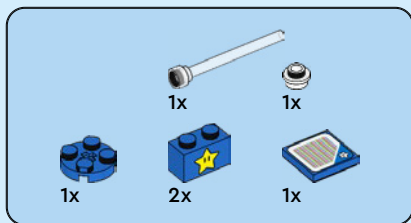

10

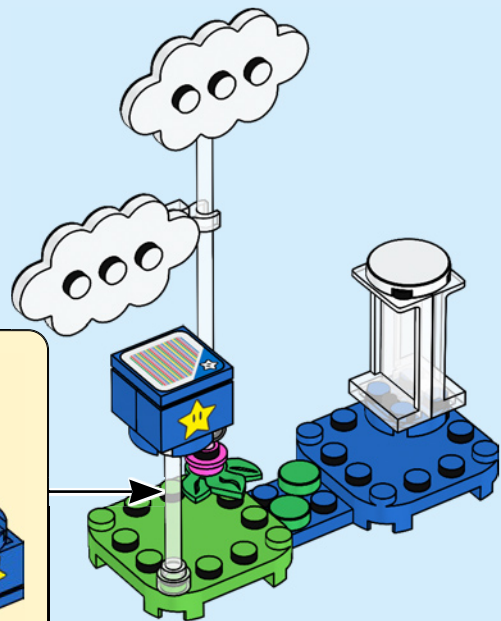
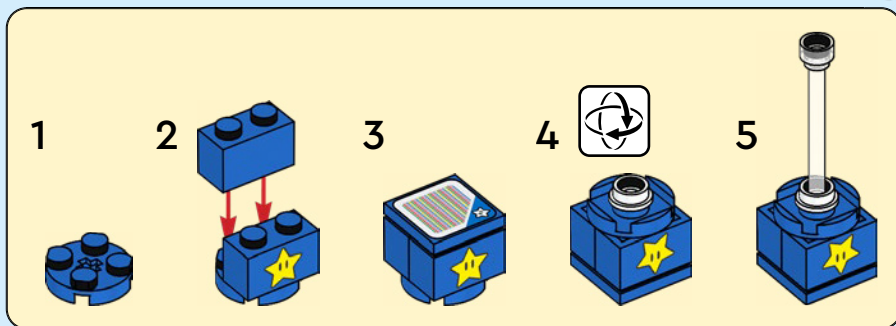

11

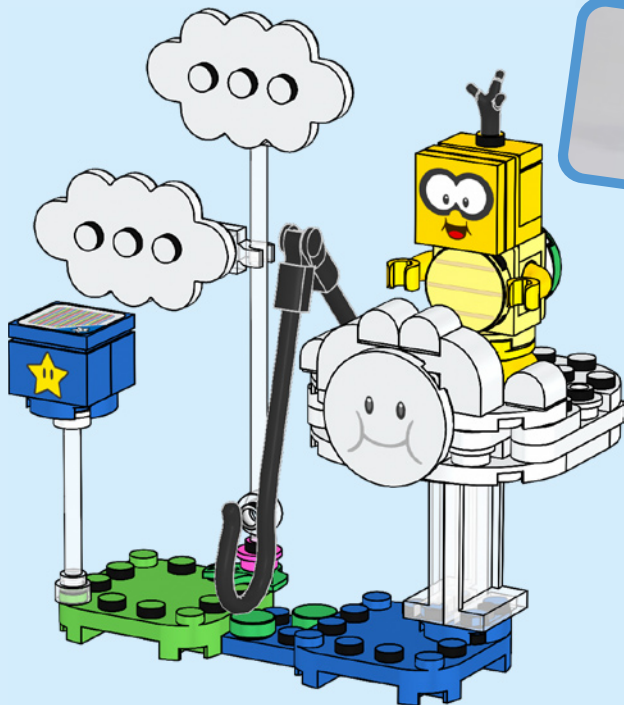

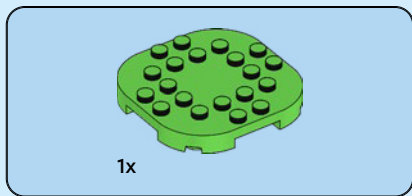

1

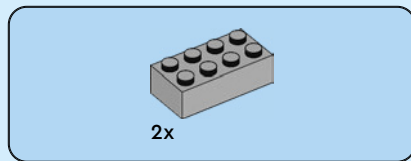
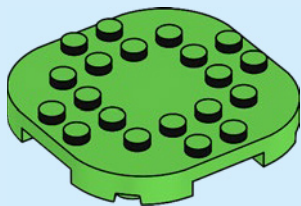

2

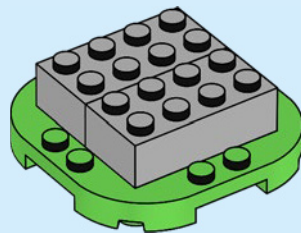

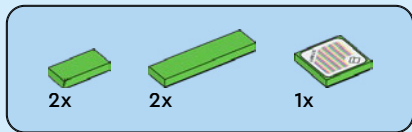

3

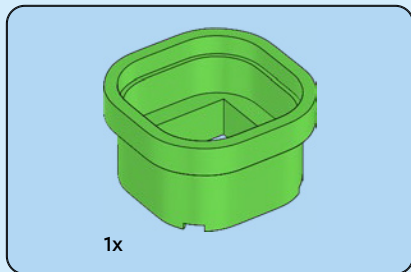
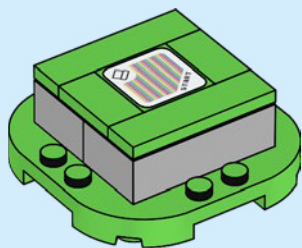

4

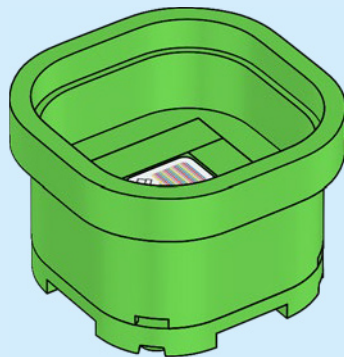

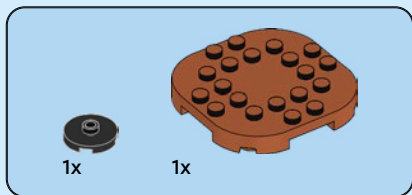

1

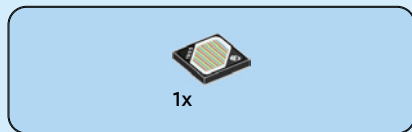
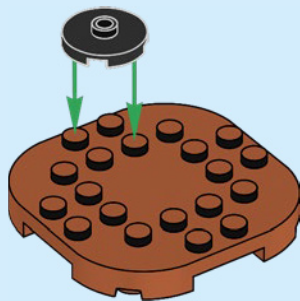

2

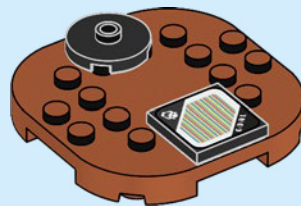

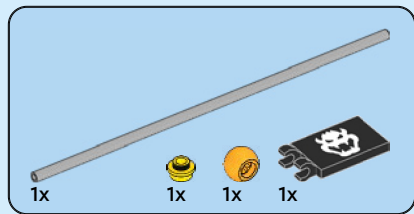

3

1

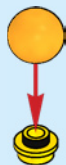

2

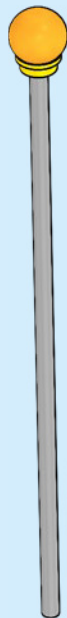

3

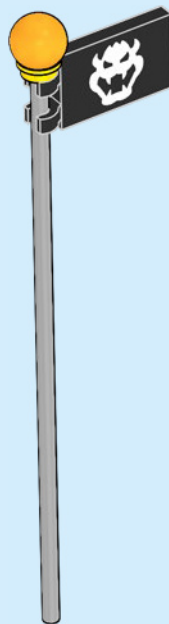

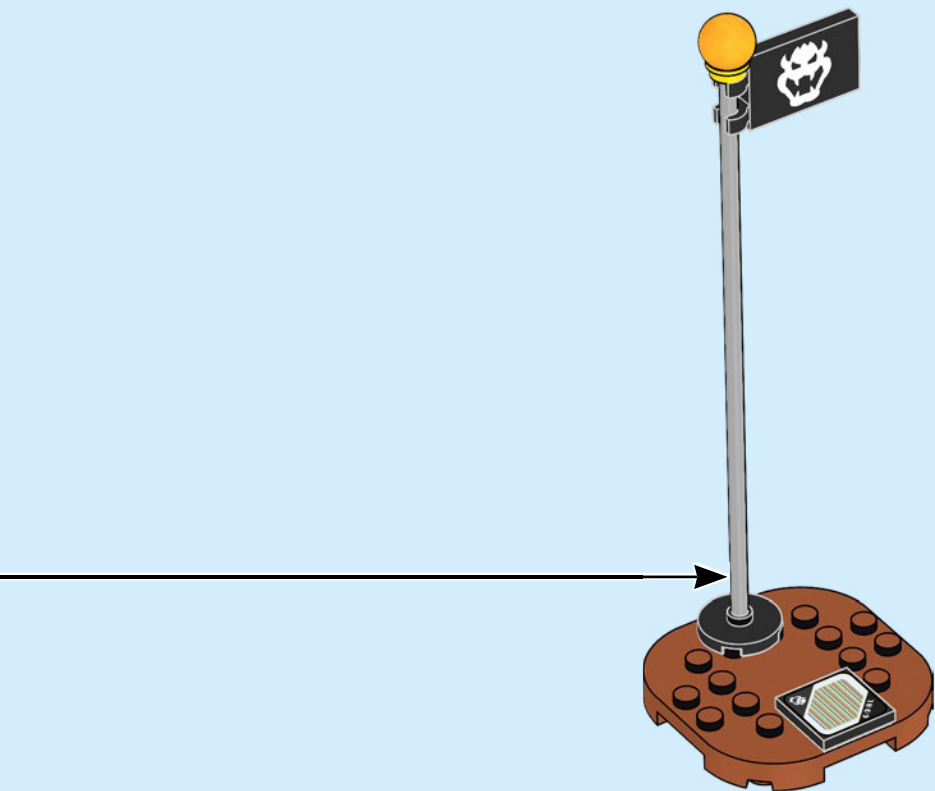

4

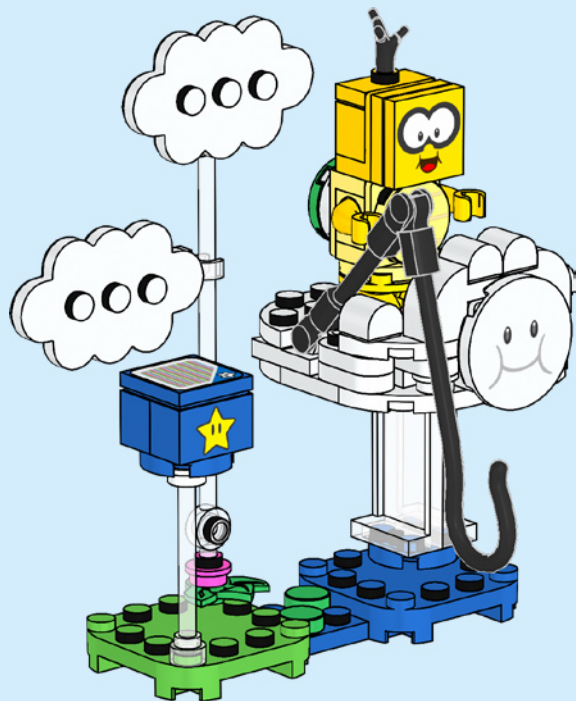

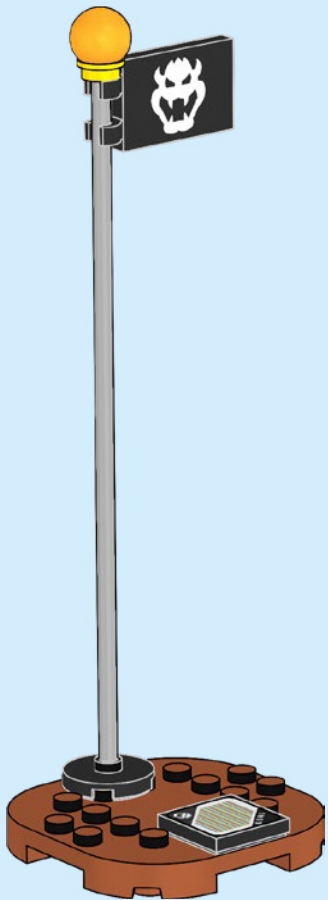



1

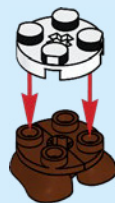



1x

2



2x

3





1x

4

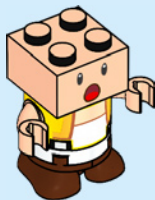

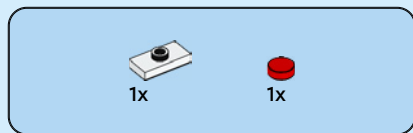

5

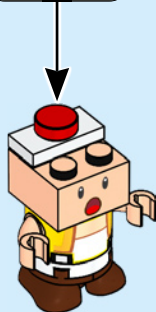
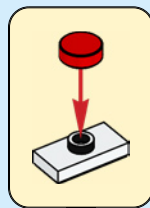

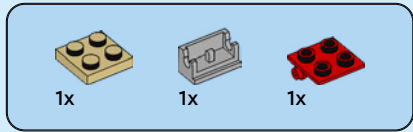

6

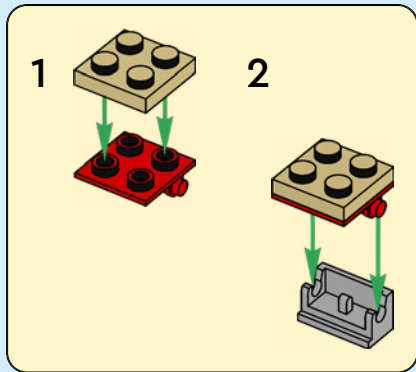

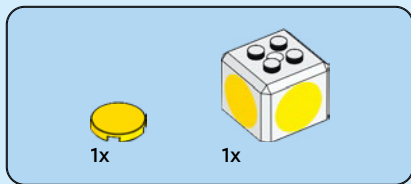

7

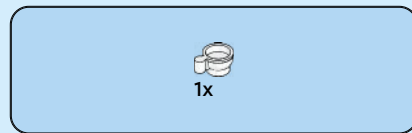
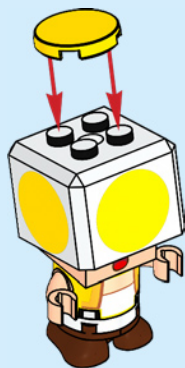

8





1x



1x

1

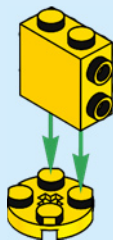



1x

2



1x

3





4x

4

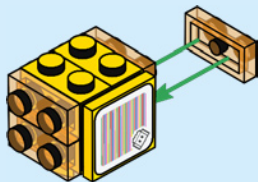

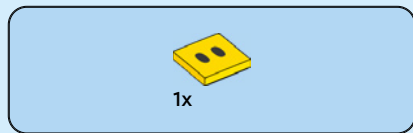

5

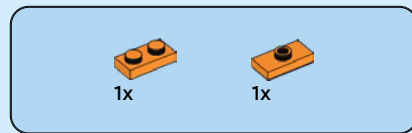

6





3x

7

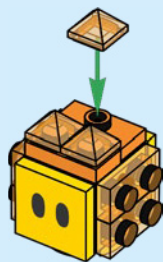

8

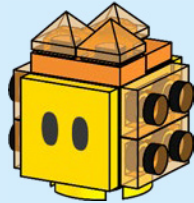

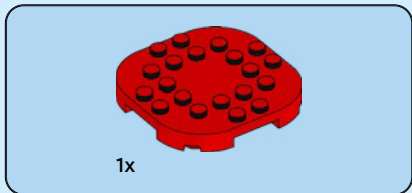
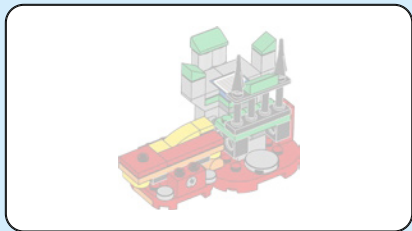

1

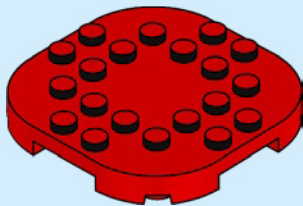

2

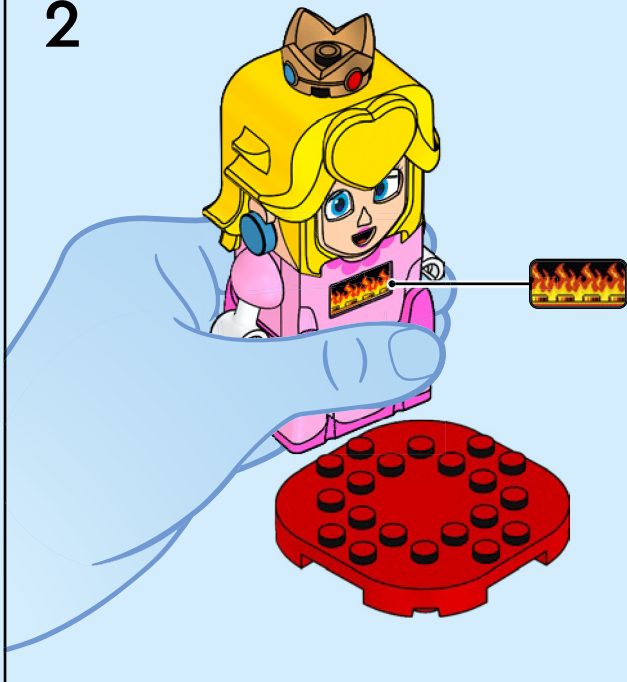

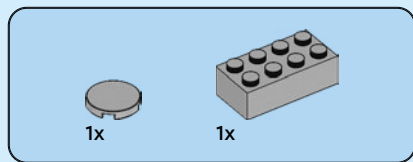

3

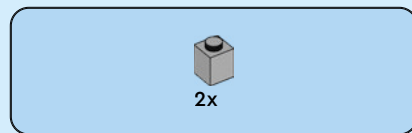
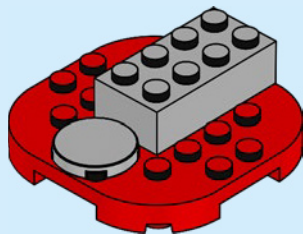

4

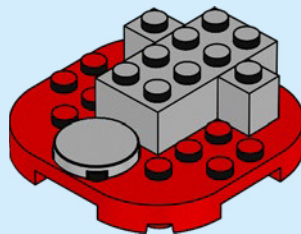



1x

5

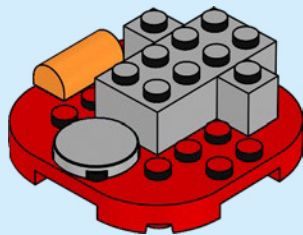

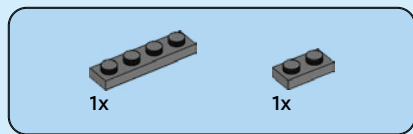

6

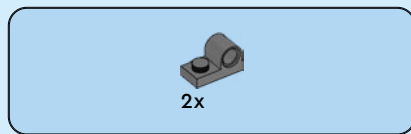
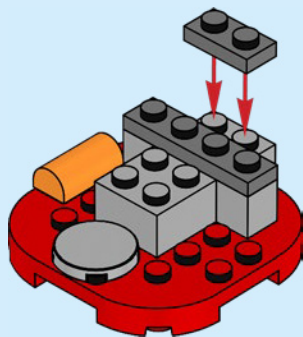

7

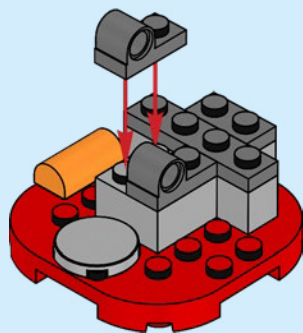



1x

8

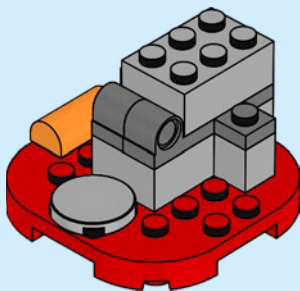



2x

9

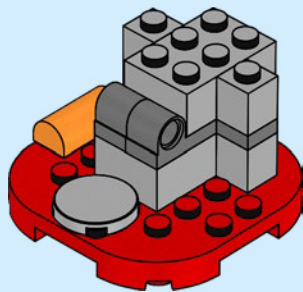

1x



4x

10

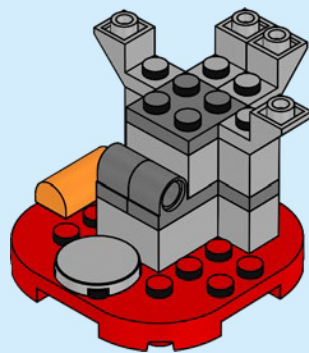

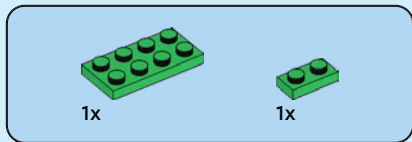

11

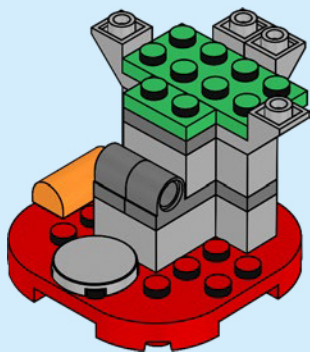



2x



1x

12

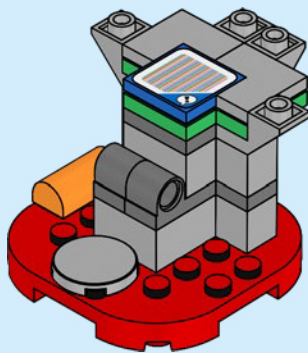

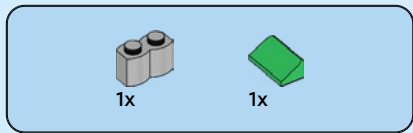

13

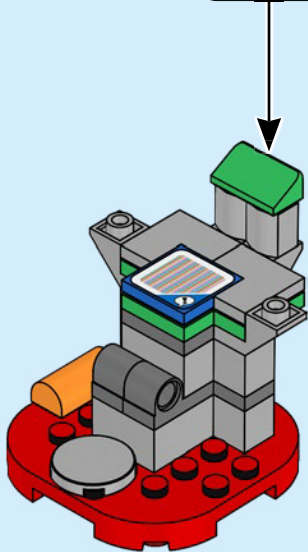
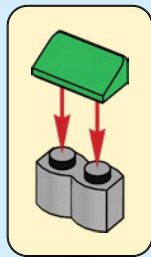

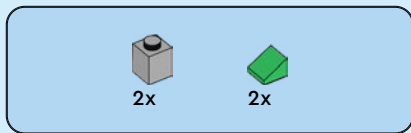

14

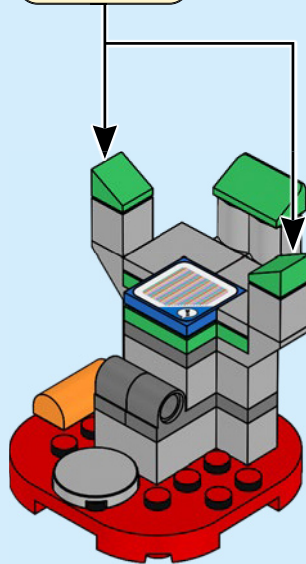
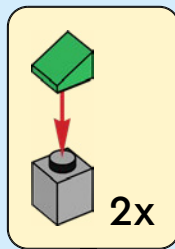

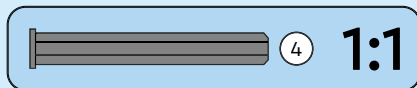
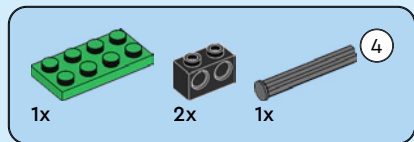

15

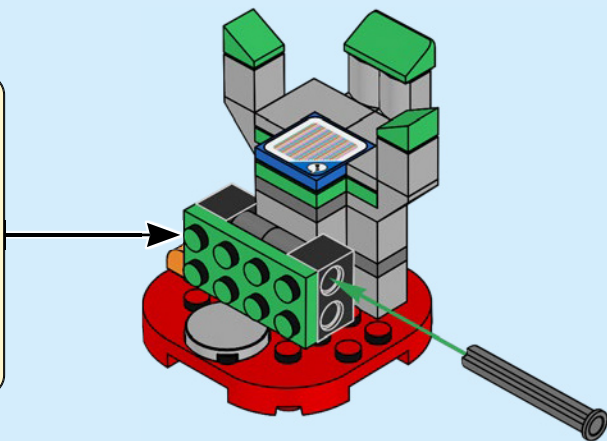
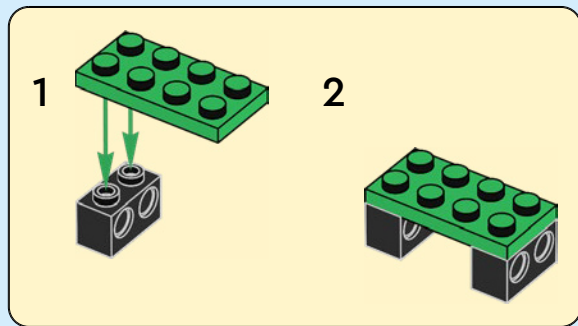

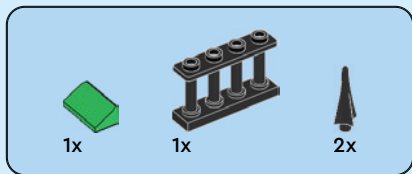

17

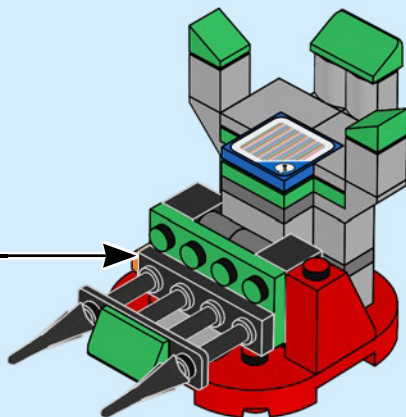
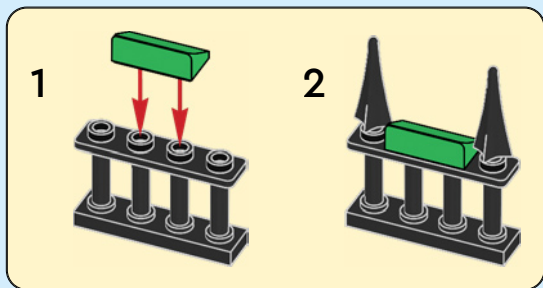

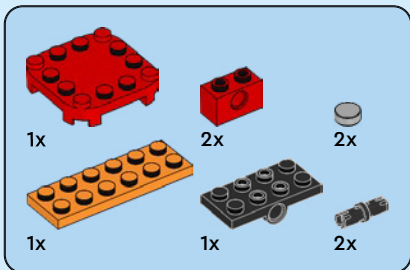
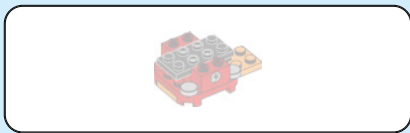

18

1

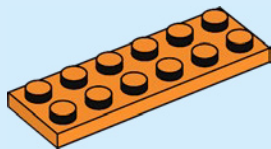

2

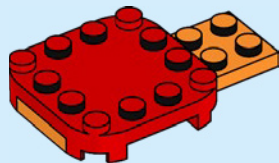

3

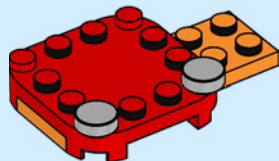

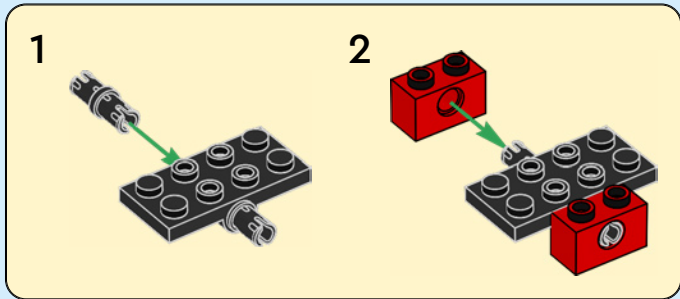

4

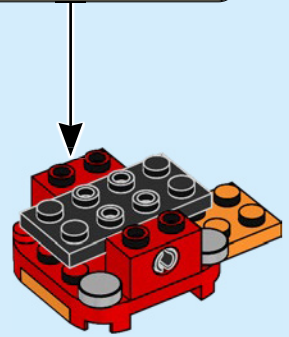

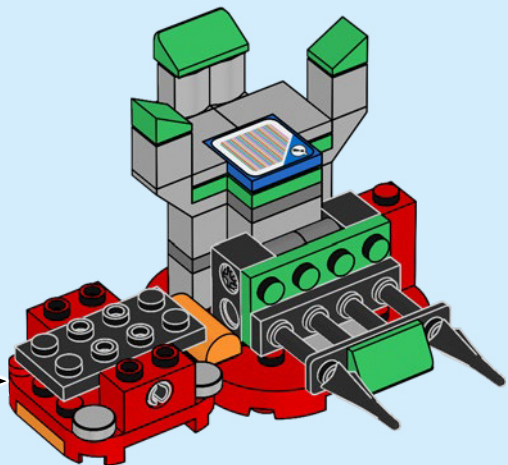

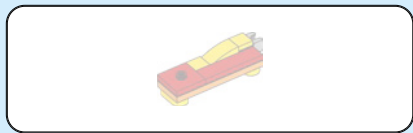

19

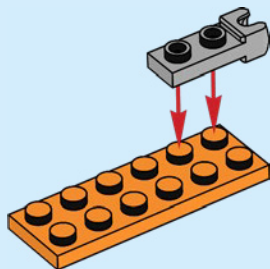

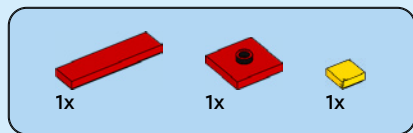

20

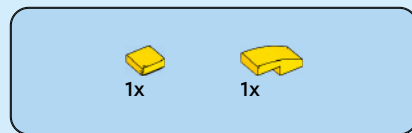
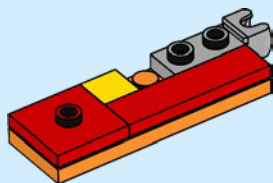

21

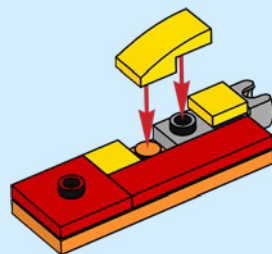



2x

22

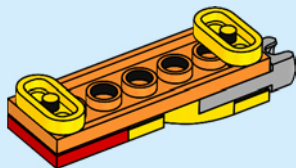

23

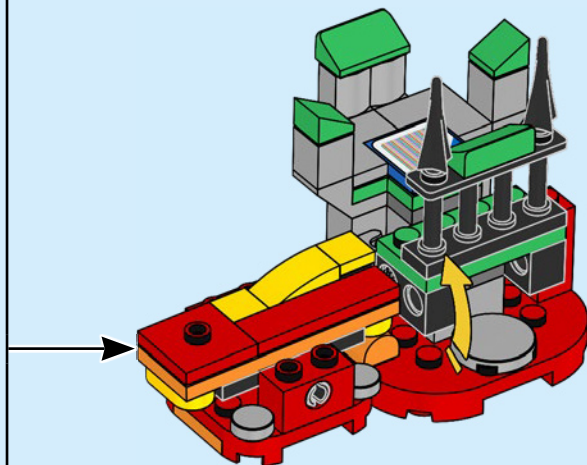

24

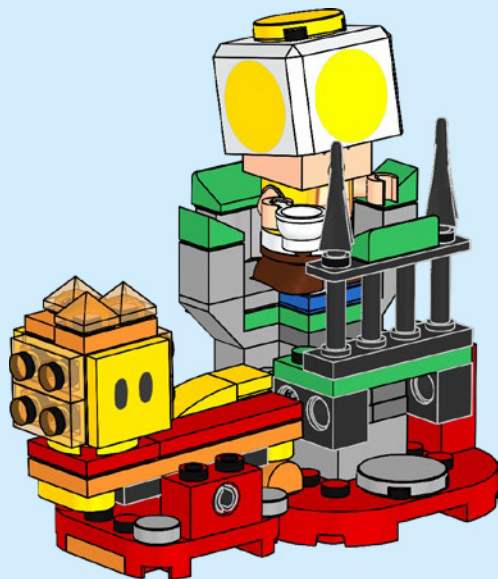

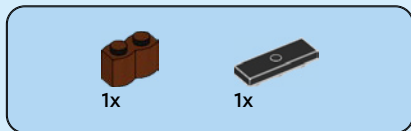

1

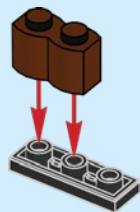

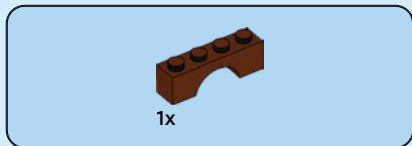

2

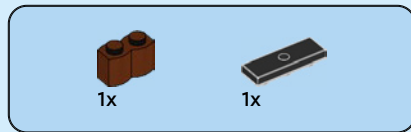

3

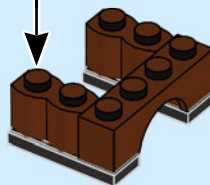
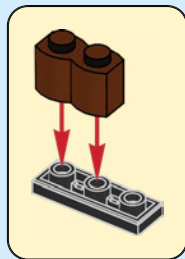



1x

4

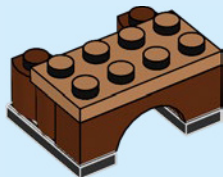

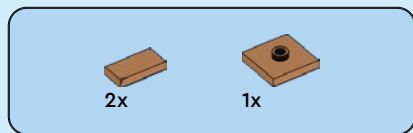

5

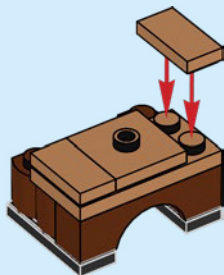

6

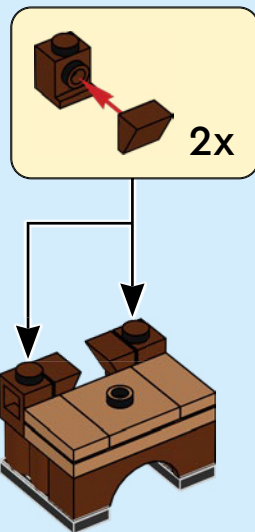

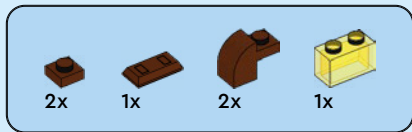

7

1

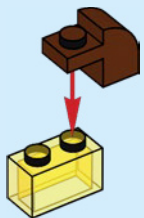

2



3



4

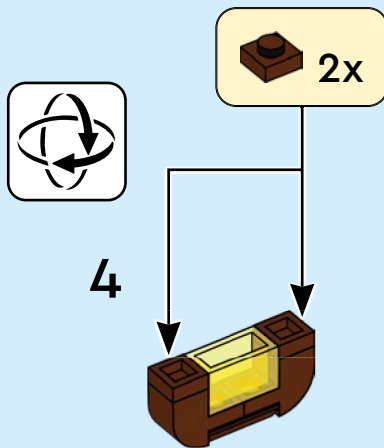



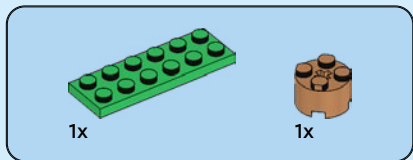
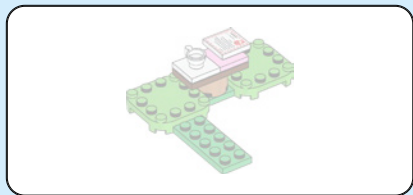

1

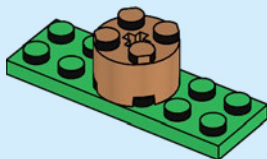

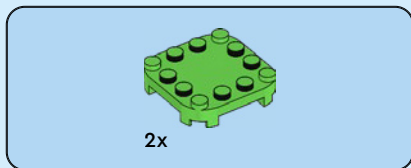

2

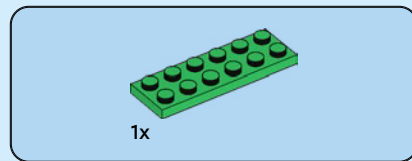
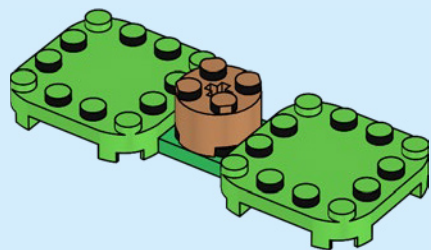

3

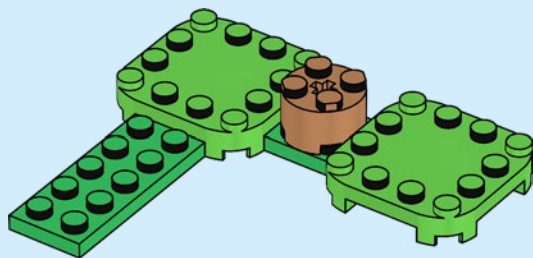

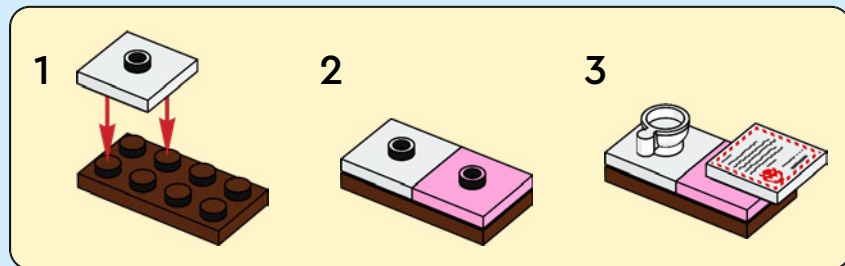
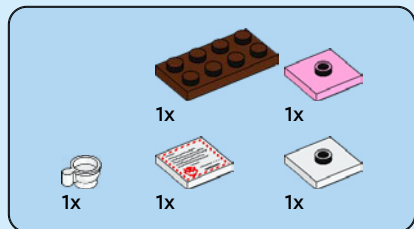

4

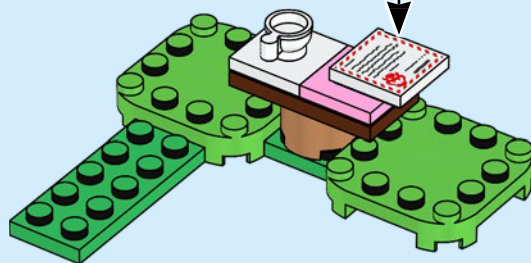

5

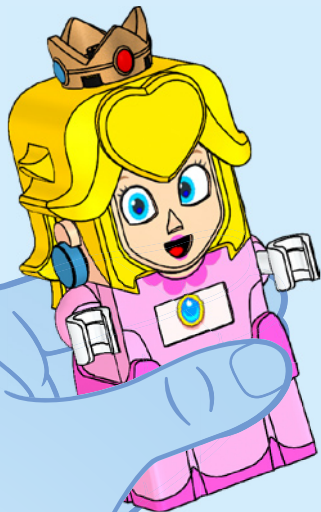

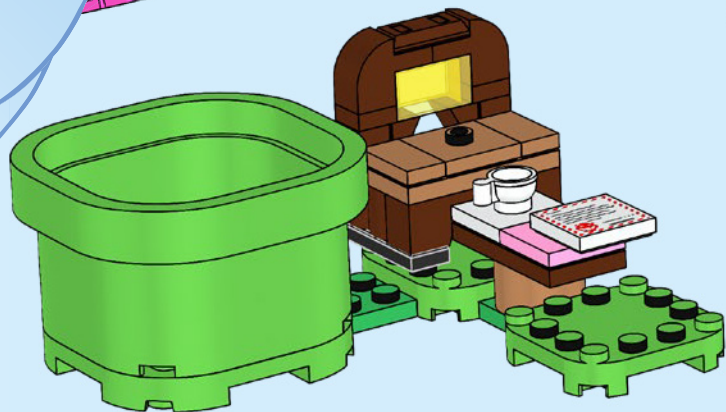
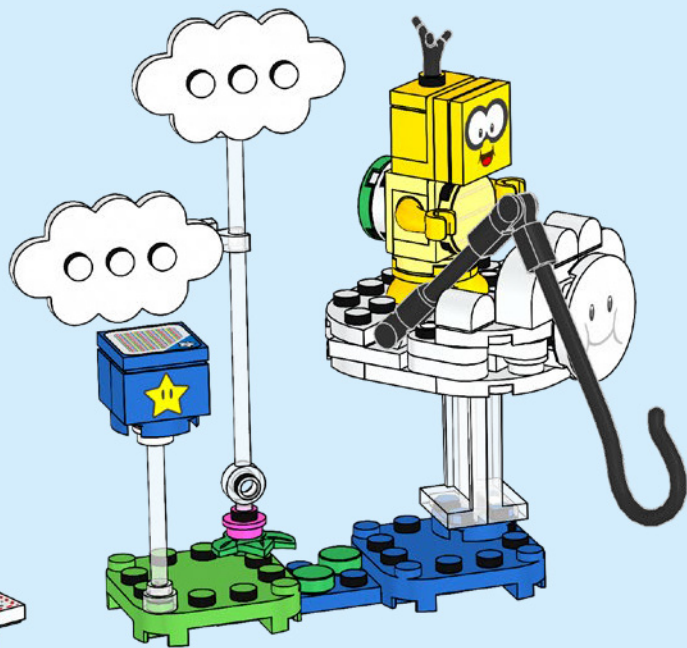

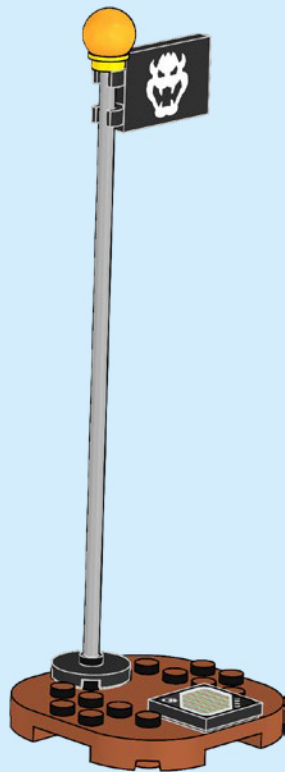
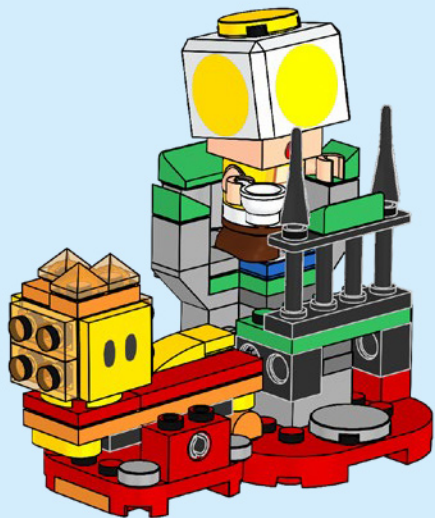



**MAKE SURE TO UPDATE
YOUR INTERACTIVE FIGURE
IN THE LEGO® SUPER MARIO™
APP TO BE READY TO PLAY**

**METTEZ À JOUR
LA FIGURINE INTERACTIVE
DANS L'APPLICATION
LEGO® SUPER MARIO™ POUR
POUVOIR JOUER**

**ASEGÚRATE DE ACTUALIZAR
TU FIGURA INTERACTIVA EN
LA APP LEGO® SUPER MARIO™
Y PREPÁRATE PARA JUGAR**



**TEAM UP FOR
MULTIPLAYER
FUN!**



**JEU
MULTIJOUEUR !**

**¡EXPERIENCIA
MULTIJUGADOR
EN EQUIPO!**



**CONNECT 2
FIGURES FOR
TEAM PLAY**

**CONNECTEZ 2
FIGURINES POUR
UN JEU D'ÉQUIPE**

**CONECTA 2
FIGURAS PARA
JUGAR EN EQUIPO**



71441 + 71439



71441 + 71440

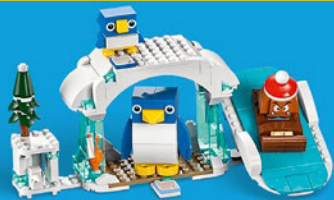

71430



71437



71435



71428



71432



71429



71428



71429



71430



71431



71432



71433



71434



71435



71436



71437

**ADD SET FOR
INTERACTIVE
PLAY**



71439



71440



**AJOUTEZ UN
ENSEMBLE POUR
UN JEU INTERACTIF**

**JUEGO
INTERACTIVO CON
ESTOS SETS**



71441



71439

OR/
OU/O



71440

OR/
OU/O



71441

EN

Important information about batteries

Never use different types of batteries together, or a combination of old and new batteries. Always remove the batteries if the product is not to be used for a long time or if the batteries have run down. Never use damaged batteries. Only use alkaline type batteries. Insert the batteries so that the poles are correctly positioned. Never attempt to recharge non-rechargeable batteries. Never short-circuit the battery holder.

DE

Wichtige Informationen zu Batterien

Benutzen Sie niemals unterschiedliche Arten von Batterien oder alte und neue gleichzeitig. Nehmen Sie stets die Batterien heraus, wenn mit dem Modell längere Zeit nicht gespielt wird oder wenn die Batterien leer sind. Verwenden Sie niemals beschädigte Batterien. Verwenden Sie ausschließlich Alkali-Batterien. Achten Sie beim Einsetzen der Batterien auf die richtige Polung. Versuchen Sie unter keinen Umständen, „normale“ Batterien wieder aufzuladen. Schließen Sie das Batteriefach niemals kurz.

FR

Informations importantes concernant les piles

Ne jamais utiliser un mélange de différents types de piles, ou de piles neuves et de piles anciennes ou déjà utilisées. Toujours retirer les piles si le produit n'est pas utilisé durant une période prolongée ou si les piles sont vides. Ne jamais utiliser de piles endommagées. N'utiliser que des piles alcalines. En insérant les piles, respecter scrupuleusement le sens d'orientation des pôles (+/-). Ne jamais essayer de recharger des piles non rechargeables. Ne jamais court-circuiter le compartiment des piles.

IT

Importanti informazioni sulle batterie

Non usare mai contemporaneamente batterie di tipo diverso o batterie nuove e usate insieme. Rimuovere sempre le batterie qualora il prodotto non venga utilizzato per periodi prolungati, oppure se le batterie sono esauste. Non utilizzare mai batterie danneggiate. Utilizzare solo batterie di tipo alcalino. Inserire le batterie avendo cura che la loro polarità sia corretta. Non tentare mai di ricaricare batterie non ricaricabili. Non cortocircuitare mai il portabatterie.

NL

Belangrijke informatie over batterijen

Gebruik nooit verschillende soorten of een combinatie van oude en nieuwe batterijen tegelijktijd. Verwijder de batterijen altijd als je het product lange tijd niet wilt gebruiken of als batterijen leeg zijn. Gebruik nooit beschadigde batterijen. Gebruik alleen alkalinebatterijen. Plaats de batterijen met de polen in de juiste richting. Probeer nooit niet-oplaadbare batterijen opnieuw op te laden. Laat de batterijhouder nooit kortsluiten.

ES

Información importante acerca de las pilas

No use pilas de diferentes tipos ni pilas nuevas y antiguas para alimentar el producto. Extraiga las pilas del producto si este va a permanecer sin uso durante un período prolongado de tiempo o aquellas se han agotado. No use pilas dañadas. Use solo pilas alcalinas. Inserte las pilas de modo que los polos queden situados en las posiciones correctas. No trate de cargar pilas no recargables. No cortocircuite el compartimento de las pilas.

DA

Vigtige oplysninger om batterier

Brug aldrig forskellige batterityper sammen eller en kombination af gamle og nye batterier. Fjern altid batterierne, hvis produktet ikke skal bruges i lang tid, eller hvis batterierne er flade. Brug aldrig beskadigede batterier. Brug kun alkaliske batterier. Sæt batterierne i, så polerne vender den rigtige vej. Forsøg aldrig at oplade ikke-genopladelige batterier. Kortslut aldrig batteriholderen.

IS

Mikilvægar upplýsingar um rafhlöður

Aldrei skal nota mismunandi gerðir rafhlaðna samtímis, né nýjar og eldri rafhlöður samtímis. Ef ekki á að nota tækið í lengri tíma eða ef rafhlöðurnar eru orðnar tómar skal fjarlægja rafhlöðurnar. Aldrei skal nota rafhlöður sem hafa skemmst. Eingöngu má nota alkaline-rafhlöður. Setja skal rafhlöðurnar í þannig að plús- og mínusskaut þeirra snúi rétt. Aldrei skal reyna að endurhlaða rafhlöður sem ekki eru endurhlaðanlegar. Aldrei ætti að valda skammhlaupi í rafhlöðuhólfinu.

FI

Tärkeää tietoa paristoista

Älä koskaan käytä erityyppisiä paristoja yhdessä. Älä myöskään käytä samassa laitteessa sekä vanhoja että uusia paristoja. Poista paristot tuotteesta aina, kun se on pitemmän aikaa käyttämättä, tai kun paristot ovat tyhjentyneet. Älä koskaan käytä viallisia paristoja. Käytä vain alkaliparistoja. Aseta paristot siten, että navat osoittavat oikeaan suuntaan. Älä koskaan aiheuta oikosulkua pariston kosketinien välillä.

SV

Viktig information om batterier

Använd aldrig olika sorters batterier samtidigt, och inte heller en kombination av gamla och nya batterier. Ta alltid ur batterierna om produkten inte ska användas under en längre tid eller om batterierna är slut. Använd aldrig skadade batterier. Använd endast alkaliska batterier. Sätt i batterierna så att polerna hamnar i rätt läge. Försök aldrig ladda icke-laddningsbara batterier. Kortslut aldrig batteriutrymmets kontaktytor.

NO

Viktig informasjon om batterier

Bruk aldri ulike typer batterier sammen og heller aldri gamle og nye batterier sammen. Ta alltid ut batteriene hvis produktet ikke skal brukes på lang tid, eller hvis batteriene er brukt opp. Bruk aldri skadde batterier. Bruk bare alkaliske batterier. Sett inn batteriene med polene vendt riktig vei. Forsøk aldri å lade opp ikke-oppladbare batterier. Kortslett aldri batteriholderen.

PT

Informação importante sobre as pilhas

Nunca use diferentes tipos de pilhas em simultâneo, ou uma combinação de pilhas usadas e novas. Retire sempre as pilhas se o produto não for usado durante muito tempo ou se as pilhas já não tiverem carga. Nunca use pilhas danificadas. Use apenas pilhas alcalinas. Insira as pilhas de forma a que os polos fiquem corretamente posicionados. Nunca tente recarregar pilhas não recarregáveis. Nunca deixe o compartimento das pilhas entrar em curto-circuito.

EL

Σημαντικές πληροφορίες για τις μπαταρίες

Μην χρησιμοποιείτε ποτέ διαφορετικούς τύπους μπαταριών μαζί και μην συνδυάζετε παλιές και καινούργιες μπαταρίες. Αφαιρείτε πάντα τις μπαταρίες αν δεν σκοπεύετε να χρησιμοποιήσετε το προϊόν για αρκετό καιρό ή αν οι μπαταρίες έχουν αδειάσει. Ποτέ μην χρησιμοποιείτε μπαταρίες που έχουν φθορές. Χρησιμοποιείτε μόνο αλκαλικές μπαταρίες. Τοποθετήστε τις μπαταρίες με τους πόλους στη σωστή θέση. Μην επιχειρήσετε ποτέ να επαναφορτίσετε μη επαναφορτιζόμενες μπαταρίες. Ποτέ μην βραχυκυκλώνετε τη θήκη των μπαταριών.

JA

電池取扱いに関する重要事項

異なるタイプの電池や古い電池を混ぜて使用しないでください。商品を長時間使用しないときや電池が切れたときは、電池を必ず取り外してください。不具合のある電池は絶対に使用しないでください。アルカリタイプの電池のみを使用してください。電極を確認して電池を正しい向きに入れてください。充電式ではない電池は絶対に充電しないでください。電池ホルダをショートさせないでください。

ZH

電池使用注意事項

请勿同时使用不同类型的电池，或把新旧程度不同的电池混合使用。如果产品将有很长时间不会使用，或者电池已经没电，请注意取出电池。切勿使用已破损的电池。仅可使用碱性电池。装入电池时请注意正负极。请勿尝试给非充电电池充电。切勿对电池仓进行短路连接。

KO

배터리 사용 시 주의사항

다른 종류의 배터리를 함께 사용하거나, 새 전지와 오래된 전지를 혼용하지 마세요. 배터리가 방전되었거나 장기간 제품을 작동하지 않을 때에는 반드시 배터리를 분리하세요. 파손된 배터리는 사용하지 마세요. 알칼라인 타입의 배터리만을 사용하세요. 양극과 음극의 위치를 잘 맞춰서 넣으세요. 일반 배터리는 충전해서 사용할 수 없습니다. 배터리 홀더의 접촉부에 배터리를 정확히 끼워서 사용하세요.

RU

Необходимая информация об элементах питания

Ни в коем случае не используйте одновременно элементы питания различных типов, а также элементы питания с разным сроком годности. В обязательном порядке вынимайте элементы питания из терминалов в случае, если вы не пользуетесь прибором в течение долгого времени, либо в случае, если в элементах питания закончился заряд. Ни в коем случае не используйте поврежденные элементы питания. Используйте только элементы питания щелочного типа. Установите элементы питания, соблюдая указанную полярность. Ни в коем случае не пытайтесь подзарядить непerezаряжаемые элементы питания. Ни в коем случае не пытайтесь замкнуть полюса в устройстве для элементов питания.

PL

Ważne informacje dotyczące baterii

Nigdy nie należy stosować razem różnych rodzajów baterii ani stosować równocześnie starych i nowych baterii. Jeżeli produkt nie jest używany przez dłuższy czas lub jeżeli baterie się wyczerpały, należy wyjąć baterie. Nigdy nie należy stosować uszkodzonych baterii. Należy używać wyłącznie baterii alkalicznych. Przy wkładaniu baterii należy zwrócić uwagę na właściwe położenie biegunów. Nigdy nie należy próbować ładowania baterii jednorazowych. Nigdy nie należy doprowadzać do zwarcia w gnieździe baterii.

CZ

Důležitá informace o bateriích

Nikdy nepoužívejte najednou různé typy baterií nebo kombinaci starých a nových baterií. Nebude-li se výrobek delší dobu používat nebo jsou-li baterie vybité, vždy je vyjměte z výrobku. Nikdy nepoužívejte poškozené baterie. Používejte pouze alkalické baterie. Baterie instalujte se správnou orientací pólů. Nikdy se nesnažte nabíjet baterie, které nejsou nabíjitelné. Nikdy nezkratujte kontakty v prostoru pro baterie.

SK

Dôležitá informácia o batériách

Nikdy nepoužívajte naraz odlišné typy batérií ani nekombinujte staré batérie s novými. Batérie vždy vyberte, ak sa výrobok nebude dlhšie používať, alebo ak sa batérie vybili. Nikdy nepoužívajte poškodené batérie. Používajte iba alkalické batérie. Batérie vkladajte so správnou orientáciou pólov. Nikdy sa nesnažte nabíjať batérie, ktoré nie sú nabíjateľné. Nikdy neskratuje kontakty v priestore pre batérie.

HU

Fontos tudnivalók az elemekről

Soha ne használjon különböző típusú elemeket, illetve ne használjon vegyesen új és használt elemeket. Mindig távolítsa el az elemeket, ha a készüléket előre láthatóan hosszabb ideig nem fogják használni, vagy ha az elemek lemerültek. Soha ne használjon megrongálódott elemeket. Csak alkáli elemeket használjon! Az elemeket helyesen helyezze be, a polaritásuknak megfelelően. Soha ne próbálja meg feltölteni a nem tölthető elemeket. Soha ne hozzon létre rövidzárlatot az elemtartó kivezetésén.

UA

Необхідна інформація про батарейки

Ніколи не використовуйте одночасно батарейки різних типів або батарейки з різним терміном придатності. Обов'язково вилучайте батарейки з приладу, якщо довго не користуєтесь ним, або якщо в батарейках уже скінчився заряд. Ніколи не використовуйте пошкоджені батарейки. Використовуйте лише лужні батарейки. Вставляйте батарейки, враховуючи задану полярність. У будь-якому випадку не намагайтеся підзарядити батарейки, що не підлягають підзарядці. У будь-якому випадку не намагайтеся зробити коротке замикання в приладі для батарей.

HR

Važne obavijesti o bateriji

Nikada nemoj koristiti različite vrste baterija zajedno, isto tako ni kombinaciju starih i novih baterija. Uvijek izvadite baterije ako dugo nećeš koristiti proizvod ili ako su one potrošene. Nikada nemoj koristiti oštećene baterije. Upotrebljavajte samo alkalne baterije. Umetni baterije pazeci da dobro okreneš polove. Nikada ne pokušavaj puniti baterije koje nisu predviđene za punjenje. Nikada ne izazivaj kratki spoj u držaču baterija.

SR

Важне информације о батеријама

Nikada ne koristite različite tipove baterija zajedno niti kombinaciju starih i novih baterija. Uvek izvadite baterije ukoliko proizvod nećete duže vreme koristiti ili ukoliko su baterije prazne. Nikada ne koristite oštećene baterije. Koristite samo alkalne baterije. Stavite baterije tako da su polovi pravilno pozicionirani. Nikada ne pokušavajte da puniti baterije koje ne mogu da se pune. Nikada ne izazivajte kratak spoj u kućištu za baterije.

МК

Важни информации за батериите

Никогаш не користете различни типови батерии заедно или комбинација од стари и нови батерии. Секогаш отстранувајте ги батериите доколку не го користите производот подолго време или доколку се потрошиле. Никогаш не користете оштетени батерии. Користете само алкални батерии. Вметнете ги батериите така што точно ќе ги наместите половите. Никогаш не обидувајте се да ги полните батериите за еднократна употреба. Никогаш не предизвикувајте краток spoj на држачот за батерии.

SL

Pomembne informacije o baterijah

Nikoli ne uporabljajte skupaj različnih baterij ali kombinacije starih in novih baterij. Vedno odstranite baterije, če izdelka dlje časa ne boste uporabljali ali če so iztrošene. Nikoli ne uporabljajte poškodovanih baterij. Uporabljajte le alkalne baterije. Baterije vstavite tako, da so njihovi polji pravilno obrnjeni. Nikoli ne poskušajte polniti baterij, ki niso akumulatorske. Pazite, da ležišč za baterije ne boste spravili v kratek stik.

RO

Informații importante despre baterii

Nu folosiți niciodată împreună tipuri diferite de baterii, sau o combinație de baterii vechi și noi. Îndepărtați întotdeauna bateriile dacă produsul nu este folosit timp îndelungat sau dacă bateriile s-au epuizat. Nu folosiți niciodată baterii deteriorate. Utilizați numai baterii de tip alcalin. Introduceți bateriile astfel ca polii să fie poziționați corect. Nu încercați niciodată să reîncărcați baterii nereîncărcabile.

Nu scurtcircuitați niciodată suportul bateriei.

BG

Важна информация за батериите

Никога не използвайте едновременно различни типове батерии или комбинация от стари и нови батерии. Винаги изваждайте батериите, ако изделието няма да се използва продължително време или ако батериите са се изтозили. Никога не използвайте повредени батерии. Използвайте само алкални батерии. Поставете батериите така, че полюсите да са разположени правилно. Никога не опитвайте да зареждате батерии, които не са акумулаторни. Никога не свързвайте на късо контактите на отделението за батериите.

LV

Svarīga informācija par baterijām

Nekad vienlaikus nelietojiet dažādu tipu, kā arī vecas un jaunas baterijas. Vienmēr izņemiet baterijas, ja tās ir izlādējušās vai ja produkts ilgāku laiku netiek lietots. Nekad nelietojiet bojātas baterijas. Izmantojiet tikai sārma tipa baterijas. Ievietojot baterijas, ievērojiet pareizu polaritāti. Nekad nemēģiniet uzlādēt baterijas, kas nav uzlādējamās. Nepieļaujiet issavienojumu bateriju nodalījumā.

ET

Oluline teave patareide kohta

Ära kunagi kasuta koos erinevat tüüpi patareid, samuti vanu ja uusi patareid. Kui mänguasja ei kasutata pika aja jooksul, võta patarei sellest välja. Ära kunagi kasuta kahjustatud patareid. Kasuta ainult leelispatareid. Pane patareid mänguasja sisse nii, et pluss- ja miinuskllemmi asend oleks õige. Ära kunagi proovi akulaadijaga laadida talvisi patareid. Patareipesa klemmide vahel ei tohi tekkida lühist.

LT

Svarbi informacija apie elementus

Vienu metu nenaudokite skirtingų elementų, taip pat su naujais elementais nenaudokite senų. Jei nenaudosite gaminio ilgesnį laiką arba jei elementai išseko, visuomet išimkite juos iš gaminio. Niekada nenaudokite pažeistų elementų. Naudokite tik šarminius elementus. Elementus dėkite atsižvelgdami į jų poliškumą. Niekada nebandykite įkrauti vienkartinį elementų. Saugokitės, kad elementų įdėkle nesukeltumėte trumpojo jungimo.

TR

Piller hakkında önemli bilgiler

Hiçbir zaman farklı tipte pilleri ya da eski pillerle yeni pilleri bir arada kullanmayın. Ürün uzun süre kullanılmayacaksa ya da piller bitmişse, pilleri ürünün içinden çıkarın. Hiçbir zaman zedelenmiş piller kullanmayın. Sadece alkalin piller kullanın. Pilleri kutupları doğru konumda olacak şekilde yerleştirin. Hiçbir zaman, şarj edilebilir olmayan pilleri şarj etmeye çalışmayın. Hiçbir zaman pil kutusuna kısa devre yaptırmayın.

AR

معلومات مهمة عن البطاريات

يحظر استخدام أنواع مختلفة من البطاريات معاً أو مزيج من البطاريات القديمة و الجديدة. أحرص دائماً على نزع البطاريات في حال عدم استخدام المنتج لفترة طويلة أو إذا نفذت طاقة البطاريات. تجنب استخدام البطاريات التالفة. لا تستخدم إلا البطاريات القلوية فقط. قم بتكيب البطاريات بحيث تكون الأقطاب في موضعها الصحيح. يحظر إعادة شحن البطاريات غير القابلة لإعادة الشحن. تجنب إحداث دائرة قصر في حامل البطارية.

ID

Informasi penting tentang baterai

Jangan gunakan baterai yang jenisnya berlainan, atau mencampur baterai lama dan baterai baru. Lepas baterai jika produk tidak akan digunakan untuk waktu lama atau jika baterai sudah lemah. Jangan gunakan baterai yang rusak. Gunakan hanya baterai alkali. Masukkan baterai dengan posisi kutub yang tepat. Jangan pernah coba mengisi ulang baterai biasa. Jangan pernah membuat arus pendek pada dudukan baterai.

MS

Maklumat penting tentang bateri

Jangan guna jenis bateri yang berbeza bersama-sama, atau gabungan bateri baharu dan lama. Tanggalkan bateri jika produk tidak akan digunakan untuk tempoh masa yang lama atau jika bateri telah kehabisan kuasa. Jangan guna bateri yang rosak. Guna bateri jenis alkali sahaja. Selitkan bateri supaya paksi berada pada kedudukan yang betul. Jangan cuba untuk mengecap semula bateri yang tidak boleh dicaskan semula. Jangan pintas litar pemegang bateri.





EN

Protect the environment by not disposing of this product with your household waste.
Check with your local authority for recycling advice and facilities. Penalties may apply for improper disposal.

DE

Schützen Sie die Umwelt und entsorgen Sie dieses Produkt nicht mit Ihrem Hausmüll.
Informationen zu Recycling-Möglichkeiten erhalten Sie bei den örtlichen Behörden. Bei unsachgemäßer Entsorgung können Strafen verhängt werden.

FR

Protégez l'environnement : ne jetez pas ce produit avec vos autres déchets ménagers.
Contactez les autorités locales pour obtenir des informations sur le recyclage et connaître les points de collecte. Des sanctions peuvent être appliquées en cas d'élimination inappropriée.



IT

Proteggi l'ambiente! Non smaltire questo prodotto con i rifiuti domestici.
Per consulenza sul riciclaggio dei rifiuti e le strutture di riciclaggio, rivolgersi alle proprie autorità locali. Uno smaltimento improprio può comportare sanzioni.

NL

Bescherm het milieu: gooi dit product niet samen met het andere huisvuil weg.
Raadpleeg de plaatselijke instanties voor locaties van milieustations en advies over hergebruik. In geval van onjuiste verwijdering kunnen boetes worden opgelegd.

ES

Proteja el medio ambiente no deshaciéndose de este producto junto con sus residuos domésticos.
Solicite asesoramiento e información sobre instalaciones de reciclaje a las autoridades locales. La eliminación inadecuada puede ser objeto de sanciones.

DA

Beskyt miljøet! Smid ikke dette produkt ud sammen med husholdningsaffaldet.
Få vejledning om genbrug og genbrugsstationer hos din kommune. Ukorrekt bortskaftelse kan medføre bøde eller straf.

IS

Stuðlið að umhverfisvernd með því að farga þessari vöru ekki með heimilissorpi.
Leitið upplýsinga um endurvinnslu- og förgunarstaði hjá yfirvöldum á hverjum stað. Viðurlögum kann að vera beitt ef förgun er ekki með réttum hætti.

FI

Tämä tuote on hävitettävä ympäristöystävällisesti ja erillään muusta talousjätteestä.
Tietoja kierrätyksestä ja keräyspisteiden sijainnista saat paikkakuntasi teknisestä virastosta. Epäasianmukaisesta hävittämisestä saattaa aiheutua seuraamuksia.

SV

Skydda miljön genom att inte kasta denna produkt bland ditt hushållsavfall.
Kontakta din kommun för frågor om återvinning och miljöstationer. Påföljder kan tillkomma för felaktig avyttring.

NO

Beskytt miljøet. Ikke kast dette produktet i husholdningsavfallet.
Kontakt kommunen for veiledning om gjenbruk og miljøstasjoner. Feil avfallshåndtering kan være straffbart.

PT

Proteja o ambiente não eliminando este produto com o seu lixo doméstico.
Consulte as autoridades locais para informação sobre reciclagem e sistemas de recolha. Podem ser aplicadas coimas por eliminação inadequada.



EL

Προσπατήστε το περιβάλλον. Μην πετάτε αυτό το προϊόν μαζί με τα συνηθισμένα οικιακά απορρίμματα. Επικοινωνήστε με τις τοπικές αρχές σχετικά με συμβουλές και εγκαταστάσεις ανακύκλωσης. Ενδέχεται να επιβάλλονται κυρώσεις για ακατάλληλη διάθεση απορριμμάτων.

JA

環境保護のため、本製品は家庭ごみとは別に処分してください。リサイクルに関する指示や施設については、お住まいの地方自治体にお問い合わせください。不適切な廃棄を行った場合、罰則が適用されることがあります。

ZH

注意保护环境，请勿将本产品与生活垃圾一起丢弃处理。请咨询当地相关部门，了解与回收相关的设施与建议。处理不当可能会导致处罚。

KO

환경 보호를 위해 이 제품을 생활폐기물과 함께 버리지 마십시오. 재활용 방법 및 시설에 관한 사항은 현지 관계 당국에 문의하십시오. 부적절하게 폐기할 경우 벌칙이 부과될 수 있습니다.

RU

Позаботьтесь об окружающей среде: не утилизируйте этот продукт вместе с бытовым мусором. Узнайте в органах местного самоуправления правила вторичной переработки и утилизации таких отходов. В случае ненадлежащей утилизации могут быть наложены штрафы.

PL

Aby chronić środowisko naturalne, nie należy wyrzucać tego produktu wraz z odpadkami z gospodarstwa domowego. W celu uzyskania wskazówek dotyczących recyklingu oraz adresów zakładów należy skontaktować się z lokalnym urzędem. Za nieprzestrzeganie zasad związanych z utylizacją odpadów grożą kary.

CZ

Nevyhazujte tento produkt do domácího odpadu, chraňte životní prostředí. Zjistěte si prosím u místních úřadů možnosti recyklace a dostupná zařízení. Nesprávná likvidace může být pokutována.

SK

Nevyhadzujte tento produkt do domáceho odpadu, chráňte životné prostredie. Zistite si na miestnych úradoch možnosti recyklácie a dostupné zariadenia. Za nesprávnu likvidáciu môžu byť uložené sankcie.

HU

Környezetét óvja, ha ettől a terméktől nem a háztartási hulladékkal együtt válik meg. Érdeklődjék a lakóhelyéhez közel eső hatóságnál az újrachasznosítás módjáról és lehetőségeiről. A nem megfelelő hulladékelhelyezésért büntetés járhat.

UA

Допоможіть захистити довкілля: не утилізуйте цей виріб разом із побутовим сміттям. Вказівки з утилізації та відомості про пункти прийому з'ясуєте в місцевих компетентних органах. У разі неналежної утилізації можуть застосовуватися штрафи.

HR

Zaštitite okoliš tako da ovaj proizvod ne odložite u otpad zajedno s kućanskim otpadom. Od lokalnih vlasti zatražite savjet ili informacije o pogonima za recikliranje. Moguća je kazna za nepropisno zbrinjavanje.

SR

Zaštitite životnu sredinu tako što nećete da odlazete ovaj proizvod sa kućnim otpadom. Raspitajte se kod lokalnog nadležnog organa o načinu reciklaže i o sabirnom centru. U slučaju nepravilnog odlaganja u otpad, mogu biti izrečene kazne.

MK

Zaštitite ja oколната така што нема да се ослободите од производот со домашниот отпад. Консултирајте се со локалните власти за да дознаете за советите и објектите за рециклирање. Возможно е да бидат применети казни за неправилно исфрлање.



SL

Zaščitite okolje! Okolje varujte tako, da tega izdelka ne zavržete skupaj z gospodinjstvi odpadki.
Pri krajevni upravi preverite, kakšne možnosti in kateri obrati za recikliranje obstajajo v vaši okolici. Za nepravilno odlaganje odpadkov vas lahko doleti kazen.

RO

Protejați mediul înconjurațor și nu vă debarasați de acest produs împreună cu deșeurile menajere.
Consultați autoritățile locale pentru îndrumări și facilități de reciclare.
Dezafectarea necorespunzătoare poate atrage sancțiuni.

BG

Защитете околната среда и не изхвърляйте този продукт заедно с битовите си отпадъци.
Свържете се с местните власти относно съвети и съоръжения за рециклиране. Възможно е да има глоби за неправомерно изхвърляне.

LV

Lai saudzētu vidi, neizmetiet šo izstrādājumu kopā ar sadzīves atkritumiem.
Vērsieties vietējās varas iestādēs, lai noskaidrotu, kur un kā tas nododams pārstrādei. Par neatbilstošu likvidēšanu var tikt piemērots sods.

ET

Keskkonda saate kaitsta nii, et ei kõrvalda seda toodet koos olmejäätmetega.
Nõuandeid toote taaskasutusse võtmise ja ümbertöötlelemispunktide kohta saate asjaomaselt kohalikult asutuselt.
Nõuetele mittevastav kasutuselt kõrvaldamine võib kaasa tuua trahvid.

LT

Saugokite aplinką: nemeskite šio produkto kartu su buitiniėmis atliekomis.
Atsižvelkite į savo vietos valdžios rekomendacijas dėl pakartotinio panaudojimo ir sąlygas. Už netinkamą šalinimą gali būti taikomos baudos.

TR

Bu ürünü, evsel atıklarla birlikte atmayarak çevreyi koruyun.
Geri dönüşüm tavsiyeleri ve tesisler hakkında bilgi için yerel yönetimle iletişime kurun. Uygunsuz atılması durumunda cezalar uygulanabilir.

AR

احم البيئة بعدم التخلص من هذا المنتج مع المخلفات المنزلية.
استشر السلطة المحلية لديك للحصول على نصح بخصوص إعادة تدوير المخلفات ومرافقه.
قد يتم تطبيق عقوبات على التخلص غير السليم.

ID

Jagalah lingkungan dengan tidak membuang produk ini bersama sampah rumah tangga Anda.
Periksa peraturan pemerintah setempat tentang saran dan fasilitas daur ulang. Pembuangan yang tidak sesuai ketentuan dapat dikenakan denda.

MS

Lindungi alam sekitar dengan tidak melupuskan produk ini bersama sisa isi rumah anda.
Rujuk pihak berkuasa tempatan anda tentang nasihat dan kemudahan kitar semula. Penalti boleh dikenakan untuk pelupusan yang tidak wajar.

- EN Please retain the leaflet and packaging as they contain important information
- DE Broschüre und Verpackung bitte aufbewahren, sie enthalten wichtige Informationen
- FR Veuillez conserver le dépliant et l'emballage, car ils contiennent des informations importantes
- IT Conserva l'opuscolo e la confezione in quanto contengono informazioni importanti
- NL Bewaar a.u.b. de folder en verpakking: die bevatten belangrijke informatie
- ES Conserve el folleto y el embalaje; contienen información importante
- DA Gem hæftet og emballagen, da de indeholder vigtige oplysninger
- IS Geymið bæklinginn og umbúðirnar þar sem þau innihalda mikilvægar upplýsingar
- FI Säilytä esite ja pakkaus, koska ne sisältävät tärkeää tietoa
- SV Spara broschyren och förpackningen eftersom de innehåller viktig information
- NO Heftet og emballasjen inneholder viktig informasjon og skal beholdes
- PT Por favor guarde o folheto e a embalagem, pois contém informação importante
- EL Κρατήστε το φυλλάδιο και τη συσκευασία γιατί περιέχουν σημαντικές πληροφορίες
- JA 説明書とパッケージには重要な情報が含まれていますので保管しておいてください
- ZH 说明书和包装均包含重要信息, 请妥善保存
- KO 중요한 정보가 담겨 있으므로 리플릿과 포장을 보관해주세요
- RU Пожалуйста, сохраните эту брошюру и упаковку, поскольку они содержат важную информацию
- PL Prosimy zachować ulotkę i opakowanie, ponieważ zawierają one ważne informacje
- CZ Ponechte si prosím leták i obal, neboť obsahují důležité informace
- SK Ponechajte si prosím leták aj obal, pretože obsahujú dôležité informácie
- HU Kérjük, őrizze meg a szórólapot és a csomagolást, mert fontos tudnivalókat tartalmaznak
- UA Будь ласка, зберігайте вкладиш та упаковку, оскільки вони містять важливу інформацію
- HR Spremite letak i ambalažu jer sadrže važne obavijesti
- SR Молимо да сачувате упутство и паковање јер се на њима налазе важне информације
- MK Чувајте ги брошурата и амбалажата бидејќи содржат важна информација
- SL Prosimo, da brošurico in embalažo shranite, saj vključujeta pomembne informacije
- RO Vă rugăm să păstrați prospectul și ambalajul întrucât conțin informații importante
- BG Запазете листовката и опаковката, тъй като съдържат важна информация
- LV Lūdzu, saglabājiet bukletu un iepakojumu, jo uz tā ir norādīta svarīga informācija
- ET Hoidke infoleht ja pakend alles, sest nendele on märgitud oluline teave
- LT Išsaugokite informacinį lapelį ir pakuotę, nes ant jų pateikiama svarbi informacija
- TR Önemli bilgiler içerdigi için broşürü ve ambalajı saklayın
- AR الرجاء الاحتفاظ بالنشرة والغلاف لاحتوائهما على معلومات هامة
- ID Harap simpan brosur dan kemasan ini karena berisi informasi penting
- MS Sila simpan risalah dan pembungkusan kerana ia mengandungi maklumat penting
- LEGO System A/S
Aastvej 1
DK-7190 Billund

LEAF NO.3

EN

The LEGO Group hereby declares that above product/products comply with the essential requirements and other relevant provisions of Directive 2014/53/EU.

Complete declaration on www.LEGO.com/compliance

DE

Hiermit erklärt die LEGO Gruppe, dass das oben genannte Produkt/die oben genannten Produkte den notwendigen Anforderungen und weiteren relevanten Bestimmungen der Richtlinie 2014/53/EU entspricht bzw. entsprechen. Vollständige Erklärung auf www.LEGO.com/compliance.

FR

Par la présente, le Groupe LEGO déclare que le(s) produit(s) mentionné(s) ci-dessus est/sont conforme(s) aux exigences essentielles et aux autres dispositions pertinentes de la Directive 2014/53/UE. Déclaration complète sur www.LEGO.com/compliance

IT

Con la presente, LEGO Group dichiara che il prodotto/prodotti di cui sopra sono conformi ai requisiti essenziali e alle altre disposizioni pertinenti stabiliti dalla Direttiva 2014/53/UE. Dichiarazione completa su www.LEGO.com/compliance

NL

De LEGO Groep verklaart bij dezen dat het bovenstaande product/de bovenstaande producten voldoet/voldoen aan de essentiële eisen en overige relevante bepalingen van Richtlijn 2014/53/EU.

De volledige verklaring is te vinden op www.LEGO.com/compliance

ES

The LEGO Group declara que el producto o los productos anteriores satisfacen los requisitos fundamentales y demás disposiciones correspondientes de la Directiva 2014/53/UE.

La declaración completa está disponible en www.LEGO.com/compliance

DA

LEGO Koncernen erklærer hermed, at produktet/produkterne nævnt ovenfor opfylder de væsentlige krav og andre relevante bestemmelser i direktiv 2014/53/EU.

Komplet erklæring på www.LEGO.com/compliance

IS

LEGO Group lýsir því hér með yfir að ofangreind vara uppfyllir grundvallarkröfur og samræmist öðrum viðeigandi ákvæðum tilskipunar nr. 2014/53/ESB. Yfirlýsinguna í heild er að finna á www.LEGO.com/compliance

FI

LEGO Group vakuuttaa täten, että edellä mainittu yksi tai useampi tuote on direktiivin 2014/53/EU oleellisten vaatimusten ja ehtojen mukainen.

Täydellinen vaatimustenmukaisuusvakuutus on osoitteessa www.LEGO.com/compliance

SV

LEGO Koncernen intygar härmed att ovanstående produkt/produkter uppfyller de väsentliga kraven och andra relevanta bestämmelser i direktiv 2014/53/EU.

Fullständig förklaring på www.LEGO.com/compliance

NO

LEGO konsernet erklærer herved at ovennevnte produkt/produkter oppfyller de obligatoriske kravene og andre relevante bestemmelser i Europaparlaments- og rådsdirektiv 2014/53/EU.

Hele erklæringen ligger på www.LEGO.com/compliance

PT

O LEGO Group declara que o/os produto(s) acima mencionado(s) está/estão em conformidade com os requisitos essenciais e outras disposições relevantes da Diretiva 2014/53/UE.

Declaração completa em www.LEGO.com/compliance

EL

Δια της παρούσης ο Όμιλος LEGO Group δηλώνει ότι το/τα παραπάνω προϊόν/προϊόντα συμμορφώνεται/ονται με τις ουσιώδεις απαιτήσεις και άλλες σχετικές διατάξεις της Οδηγίας 2014/53/ΕΕ.

Η πλήρης δήλωση βρίσκεται στο www.LEGO.com/compliance

JA

LEGO Groupによる上記の製品はすべて、2014年EU指令(2014/53/EU)の基本的な要求事項およびその他の関連規定に準拠しております。

準拠宣言の全文はこちら：
www.LEGO.com/compliance

ZH

乐高集团特此声明，上述产品符合欧盟2014/53/EU指令的基本要求和其它有关规定。请访问 www.LEGO.com/compliance 网站查看完整声明

KO

레고 그룹은 상기 제품이 2014/53/EU 지침의 필수 요건 및 기타 관련 조항을 준수함을 선언합니다. 자세한 내용은 www.LEGO.com/compliance에서 확인할 수 있습니다.

RU

Настоящим LEGO Group заявляет, что указанные выше товары отвечают основополагающим требованиям и иным применимым положениям Директивы 2014/53/ЕС.

Полный текст см. на сайте www.LEGO.com/compliance.

PL

Grupa LEGO niniejszym oświadcza, że wymienione produkty są zgodne z zasadniczymi wymaganiami oraz innymi właściwymi postanowieniami dyrektywy 2014/53/UE.

Pełna treść deklaracji na stronie www.LEGO.com/compliance

CZ

LEGO Group tímto prohlašuje, že všechny výše uvedené produkty odpovídají základním požadavkům a všem příslušným ustanovením směrnice 2014/53/EU.

Kompletní prohlášení na www.LEGO.com/compliance

SK

LEGO Group týmto vyhlasuje, že hore uvedené produkty zodpovedajú základným požiadavkám a všetkým príslušným ustanoveniam smernice 2014/53/EU.

Kompletné prehlásenie na www.LEGO.com/compliance

HU

A LEGO Csoport ezennel kijelenti, hogy a fenti termék/termékek megfelelnek a 2014/53/EU irányelv alapvető követelményeinek és egyéb vonatkozó rendelkezéseinek.

A nyilatkozat teljes szövege itt olvasható: www.LEGO.com/compliance

UA

LEGO Group заявляє, що цей продукт чи продукти відповідають головним вимогам та іншим відповідним положенням Директиви 2014/53/EU. Повний текст заяви можна переглянути на сайті www.LEGO.com/compliance

HR

LEGO Group ovim izjavljuje da su gore navedeni proizvod/proizvodi sukladni bitnim zahtjevima i drugim odgovarajućim odredbama direktive 2014/53/EU.
Cjelovita izjava nalazi se na www.LEGO.com/compliance

SR

Компанија LEGO Group овим путем изјављује да је/су горенаведени производ/-и усклађен/-и са основним захтевима и другим релевантним одредбама Директиве 2014/53/EU.
Комплетну изјаву можете пронаћи на адреси www.LEGO.com/compliance

МК

LEGO Group со ова изјавува дека производот/производите погоре се во согласност со основните барања и другите релевантни одредби на директивата 2014/53/EC.
Целосна декларација на www.LEGO.com/compliance

SL

LEGO Group izjavlja, da izdelek ustreza osnovnim zahtevam in drugim relevantnim določilom Direktive 2014/53/ES.
Celotna deklaracija je na spletni strani www.LEGO.com/compliance

RO

Grupul LEGO declară prin prezenta că produsul/produsele de mai sus se conformează cerințelor esențiale și altor prevederi relevante ale Directivei 2014/53/UE.
Declarația completă pe www.LEGO.com/compliance

BG

LEGO Group декларира, че посочените продукти по-горе съответстват на основните изисквания и други съответни разпоредби на Директива 2014/53/EC.
Пълна декларация на www.LEGO.com/compliance

LV

Ar šo LEGO Group paziņo, ka iepriekšminētais(ie) produkts(i) atbilst Direktīvas 2014/53/ES būtiskajām prasībām un citiem saistītajiem noteikumiem.
Pilns deklarācijas teksts pieejams vietnē www.LEGO.com/compliance

ET

Käesolevaga teatab LEGO Group, et eespool nimetatud toode/tooted vastavad direktiivi 2014/53/EL olulistele nõuetele ja muudele asjakohastele sätetele. Täielik deklaratsioon on saadaval aadressil www.LEGO.com/compliance

LT

Šiuo dokumentu „LEGO Group“ deklaruoją, kad anksčiau nurodytas (-i) produktas (-ai) atitinka svarbiausius reikalavimus ir kitas 2014/53/ES direktyvos sąlygas.
Visą deklaraciją rasite www.LEGO.com/compliance

TR

LEGO Group işbu belge ile yukarıdaki ürünün/ürünlerin 2014/53/EU sayılı direktifin temel gereksinimlerine ve diğer ilgili hükümlerine uygun olduğunu beyan eder. Beyanın tam metnine www.LEGO.com/compliance adresinden ulaşabilirsiniz.

AR

تعلم مجموعة LEGO Group بموجب هذه الوثيقة أن المنتج/المنتجات تتوافق مع المتطلبات الأساسية والأحكام الأخرى ذات الصلة بالتوجيه EU/2014/53. التصريح كاملاً على الموقع www.LEGO.com/compliance

ID

LEGO Group dengan ini menyatakan bahwa produk di atas sesuai dengan persyaratan penting dan ketentuan terkait lainnya dalam Directive 2014/53/EU. Pernyataan selengkapnya tersedia di www.LEGO.com/compliance

MS

LEGO Group dengan ini mengumumkan bahawa produk di atas mematuhi keperluan asas dan peruntukan relevan lain dalam Directive 2014/53/EU. Pengisytiharan lengkap di www.LEGO.com/compliance



有毒有害物质/元素的名称及含量表						
根据中国<电子信息产品污染控制管理办法>						
有毒有害物质/元素						
部件名称	铅 (Pb)	汞 (Hg)	镉 (Cd)	六价铬 (Cr(VI))	多溴联苯 (PBB)	多溴二联苯 (PBDE)
印刷电路板组件	X	O	O	O	O	O

本表格依据 SJ/T 11364 的规定编制。
 O:表示该有害物质在该部件所有均质材料中的含量均在GB/T 26572 规定的限量要求以下。
 X:表示该有害物质至少在该部件的某一均质材料中的含量超出GB/T 26572 规定的限量要求。
 (由于技术原因目前尚未能替代化,除非破坏产品,否则消费者接触不到相关组件。)

取得審驗證明之低功率射頻器材,非經核准,公司、商號或使用者均不得擅自變更頻率、加大功率或變更原設計之特性及功能。低功率射頻器材之使用不得影響飛航安全及干擾合法通信;經發現有干擾現象時,應立即停用,並改善至無干擾時方得繼續使用。前述合法通信,指依電信管理法規定作業之無線電通信。低功率射頻器材須忍受合法通信或工業、科學及醫療用電波輻射性電機設備之干擾。

台灣樂高貿易股份有限公司
 台北市信義區忠孝東路四段555-1號11樓B室



This device complies with part 15 of the FCC Rules. Operation is subject to the following two conditions:

- (1) This device may not cause harmful interference, and
- (2) this device must accept any interference received, including interference that may cause undesired operation.

NOTE: This equipment has been tested and found to comply with the limits for a Class B digital device, pursuant to part 15 of the FCC Rules. These limits are designed to provide reasonable protection against harmful interference in a residential installation. This equipment generates, uses and can radiate radio frequency energy and, if not installed and used in accordance with the instructions, may cause harmful interference to radio communications.

However, there is no guarantee that interference will not occur in a particular installation. If this equipment does cause harmful interference to radio or television reception, which can be determined by turning the equipment off and on, the user is encouraged to try to correct the interference by one or more of the following measures:

- Reorient or relocate the receiving antenna.
- Increase the separation between the equipment and receiver.
- Connect the equipment into an outlet on a circuit different from that to which the receiver is connected.
- Consult the dealer or an experienced radio/TV technician for help.

Caution: changes or modifications not expressly approved by the party responsible for compliance could void the user's authority to operate the equipment.

This device contains licence-exempt transmitter(s)/receiver(s) that comply with Innovation, Science and Economic Development Canada's licence-exempt RSS(s). Operation is subject to the following two conditions:

- (1) This device may not cause interference.
- (2) This device must accept any interference, including interference that may cause undesired operation of the device.

L'émetteur/récepteur exempt de licence contenu dans le présent appareil est conforme aux CNR d'Innovation, Sciences et Développement économique Canada applicables aux appareils radio exempts de licence. L'exploitation est autorisée aux deux conditions suivantes :

- (1) L'appareil ne doit pas produire de brouillage;
- (2) L'appareil doit accepter tout brouillage radioélectrique subi, même si le brouillage est susceptible d'en compromettre le fonctionnement.

CAN ICES-3 (B)/NMB-3(B)

เครื่องโทรคมนาคมและอุปกรณ์นี้มีความสอดคล้องตาม
มาตรฐานหรือข้อกำหนดทางเทคนิค ของ กสทช



EN CAUTION: Risk of explosion if the battery is replaced by an incorrect type.

DE ACHTUNG: Es besteht Explosionsgefahr, wenn die Batterie durch einen ungeeigneten Batterietyp ersetzt wird.

FR ATTENTION : Risque d'explosion si la pile est remplacée par un modèle incompatible.

IT ATTENZIONE: rischio di esplosione se la batteria è sostituita con una di tipo errato.

NL VOORZICHTIG: Explosiegevaar indien de batterij wordt vervangen door een onjuist type.

ES PRECAUCIÓN: Sustituir la batería por otra de tipo incorrecto representa un riesgo de explosión.

DA ADVARSEL: Der er risiko for eksplosion, hvis batteriet udskiftes med en forkert type.

IS VARÚÐ: Hætta á sprengingu ef rafhlöðunni er skipt út fyrir rafhlöðu af rangri gerð.

FI VAROITUS: Räjähdyksvaara, jos pariston tilalle vaihdetaan vääriin tyyppinen paristo.

SV VARNING: Explosionsrisk om batteriet byts ut mot ett batteri av fel typ.

NO FORSIKTIG: Kan eksplodere hvis batteriet skiftes ut med feil type batteri.

PT ATENÇÃO: Risco de explosão se as pilhas forem substituídas por um tipo incorreto.

EL ΠΡΟΣΟΧΗ: Κίνδυνος έκρηξης εάν η μπαταρία αντικατασταθεί με μια άλλη λανθασμένου τύπου.

JA 注意: 誤った種類の電池を挿入すると爆発する恐れがあります。

ZH 注意事项: 如果所更换的电池类型不正确, 则存在爆炸的风险。

KO 주의: 출고 시 규격 이외의 배터리를 교체할 경우 폭발의 위험이 있습니다.

RU ВНИМАНИЕ! Установка элемента питания неправильного типа может привести к его взрыву.

PL UWAGA: Zastosowanie nieprawidłowego typu baterii stwarza zagrożenie wybuchem.

CZ POZOR: V případě nahrazení baterie nesprávným typem hrozí riziko výbuchu.

SK VAROVANIE: Ak batériu nahradíte nesprávnym typom, hrozí riziko výbuchu.

HU VIGYÁZAT! Robbanásveszély, ha az akkumulátort nem megfelelő típusúra cserélik.

UA ОБЕРЕЖНО! Якщо вставити невідповідний тип батарейки, може статися вибух.

HR OPREZ: Opasnost od eksplozije ako se baterija zamijeni vrstom koja nije propisana.

SR ОПРЕЗ: Опасност од експлозије ако се батерија замени неодговарајућом врстом.

МК ВНИМАНИЕ: Има ризик од експлозија, ако батеријата е заменета со погрешен тип.

SL POZOR: Če vstavite baterijo napačnega tipa, tvegate, da bo eksplodirala.

RO ATENȚIE: risc de explozie dacă bateria este înlocuită cu una de un tip incorect.

BG ВНИМАНИЕ: Има риск от експлозия, ако батерията бъде заменена с такава от неправилен тип.

LV UZMANĪBU! Ja baterija tiek nomainīta ar nepareiza tipa bateriju, pastāv sprādziena risks.

ET ETTEVAATUST! Plahvatusoht, kui patarei asendatakse vale tüüpi patareiga.

LT ATSARGIAI! Įstačius netinkamo tipo elementą, gali kilti sprogimo pavojus.

TR UYARI: Yanlış türde pil kullanılırsa patlama riski bulunur.

AR تنبيه: خطر الانفجار في حالة استبدال البطارية بنوع غير صحيح.

ID HATI-HATI: Risiko ledakan dapat timbul jika baterai diganti dengan jenis yang berbeda.

MS PERINGATAN: Risiko letupan jika bateri ditukarkan dengan jenis bateri yang salah.

Este equipamento não tem direito à proteção contra interferência prejudicial e não pode causar interferência em sistemas devidamente autorizados.

La operación de este equipo está sujeta a las siguientes dos condiciones:
 (1) es posible que este equipo o dispositivo no cause interferencia perjudicial y
 (2) este equipo o dispositivo debe aceptar cualquier interferencia, incluyendo a la que pueda causar su operación no deseada.

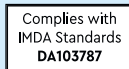



4x
6168642



2x
6285777



4x
6501816



1x
379501



1x
243121



2x
6235083



1x
6347309



1x
6508216



1x
4114084



1x
6301842



4x
6258135



1x
6097637



1x
6382151



1x
6284574



1x
6294705



5x
6210272



1x
6392162



2x
370021



2x
6334673



1x
6044691



1x
6126046



2x
6223667



1x
4515371



1x
6308879



3x
403201



1x
6483011



4x
6147792



1x
613421



1x
6051511



1x
6483012



1x
4243812



1x
6126048



1x
379523

 2x 403223	 1x 6092583	 1x 6483009	 1x 6390370	 1x 6369098
 1x 6315998	 1x 300424	 1x 6317953	 1x 6194233	
 1x 6354341	 1x 6029947	 1x 6308990	 2x 6279875	 2x 6396247
 1x 6168644	 1x 6208753	 2x 6272184	 1x 6195325	 2x 4546705
 2x 307024	 2x 6310247	 2x 6269965	 2x 3200026	 1x 6229130
 2x 6248971	 2x 6315218	 1x 6315887	 1x 6093525	 2x 6195258
 1x 6078279	 1x 6302719	 1x 6302576	 1x 6315659	 2x 6000071
 1x 403224	 1x 302224	 2x 6321194	 1x 6066113	 1x 302328
 1x 6407818				 1x 6506165

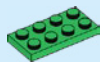

2x
302028

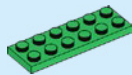

2x
379528



1x
6407663

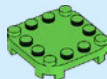

3x
6308875

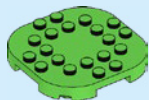

1x
6301631

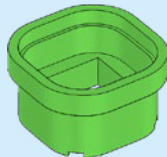

1x
6294708



2x
6195267



1x
6358934



2x
6507949



1x
6166111



1x
6276993



1x
6071608



1x
6514265



3x
6250584



4x
6514005



1x
6301632



1x
6489351



1x
6092599



1x
4177932

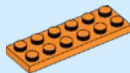

2x
4121741



2x
4225469



2x
4221744



2x
4504376



1x
6261744



2x
6335567



2x
4211180



1x
6300006



1x
6177697



1x
4211186



2x
6284071



6x
4211389



4x
6407767



1x
6052200

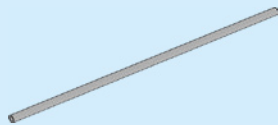

1x
6409852

1x
4550325

1x
4211469

2x
6065824

1x
4211386

3x
4211385

1x
6043639

2x
6019987

1x
4211063

1x
4211094

1x
6083620

1x
4211001

1x
6230582

1x
6368024

1x
6251842

2x
6316263

2x
6503683

1x
6310506

1x
6503668

1x
6296485

2x
6297281

1x
6353857

1x
6405108

1x
6454167

2x
6021997

1x
6102994

1x
6093494

2x
6322824

1x
6365768

 [LEGO.com/service](https://www.LEGO.com/service)

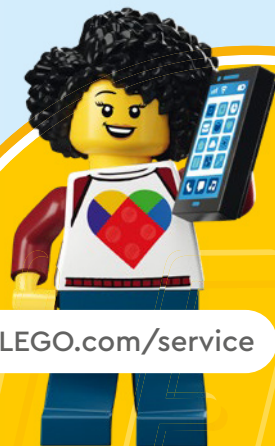

YOU COULD
WIN

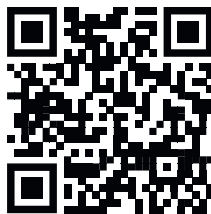

Scan this QR code or go to
LEGO.COM/PRODUCTFEEDBACK and give us
your short feedback about this LEGO® set for
a chance to win a cool LEGO prize.

Terms and Conditions apply*

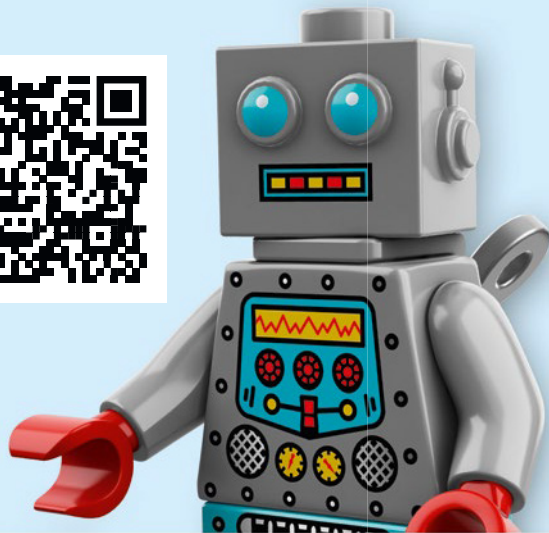

EN: YOU COULD WIN. Terms and Conditions apply* **DE: Du könntest GEWINNEN.** Es gelten die Teilnahmebedingungen* **FR: Tu pourrais GAGNER.** Des conditions s'appliquent* **IT: Potresti VINCERE tu.** Termini e condizioni sono applicabili* **ES: Puedes GANAR.** Aplican términos y condiciones* **PT: Poderá GANHAR.** Aplicam-se termos e condições* **ZH: 轻松获奖. 条款和条件适用*** **PL: Szansa na WYGRANĄ.** Obowiązują warunki korzystania* **CS: Máte šanci VYHRÁT.** Platí všeobecné smluvní podmínky* **SK: Máte šancu VYHRAŤ.** Platia všeobecné zmluvné podmienky* **HU: TE IS NYERHETSZ.** Felhasználási feltételek érvényesek* **RO: Ai putea CÂȘTIGA.** Se aplică termeni și condiții* **BG: Можете да СПЕЧЕЛИТЕ.** Има определени правила и условия* **LV: Tu vari LAIMĒT.** Ir spēkā noteikumi un nosacījumi.* **ET: Sul on võimalus VÕITA.** Kehtivad tingimused* **LT: Jūs galite LAIMĖTI.** Taikomos sąlygos*

*[LEGO.com/productfeedback-terms](https://www.lego.com/productfeedback-terms)

LEGO, the LEGO logo and the Brick and Knob configurations are trademarks of the/son des marques de commerce du/
son marcas registradas de LEGO Group. ©2024 The LEGO Group.

© Nintendo.

6540769