



40701







[LEGO.com/sustainable-packaging](https://LEGO.com/sustainable-packaging)



**FR**  
**DONNEZ**  
OU  
**RECYCLEZ**

 OU  OU 

ASSOCIATION MAGASIN DÉCHÈTERIE

Adresses sur [quefairedemesdechets.fr](http://quefairedemesdechets.fr)

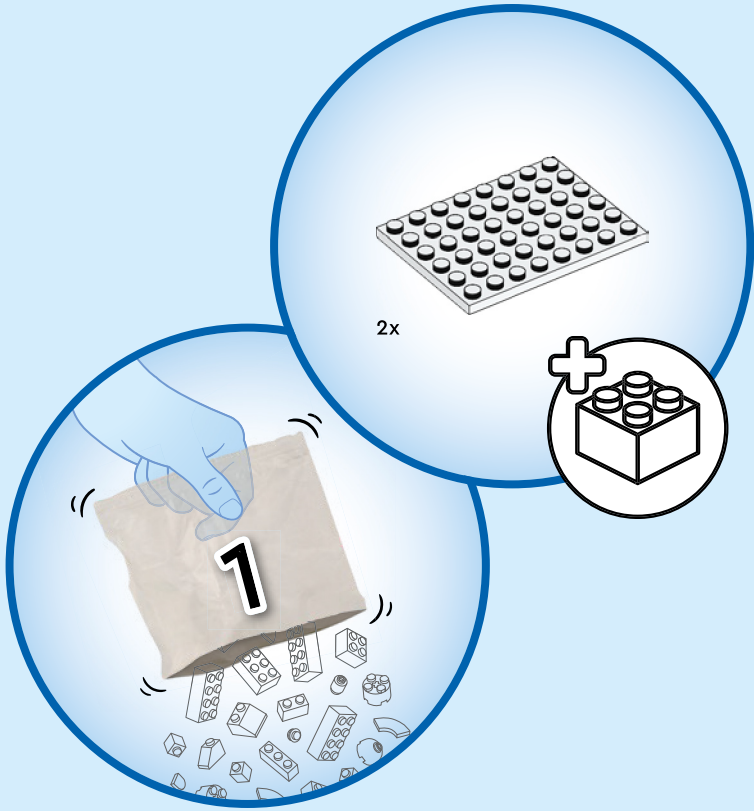

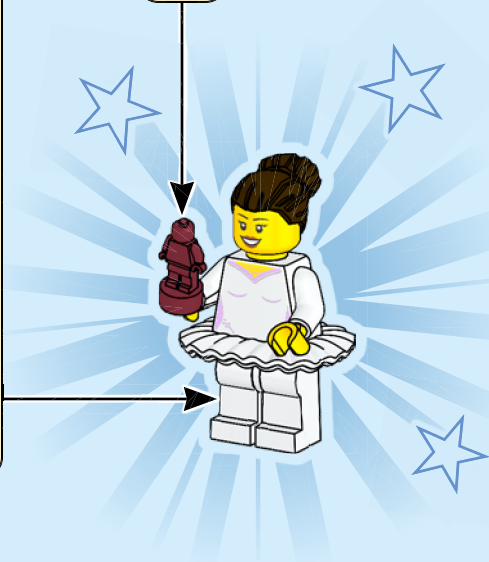
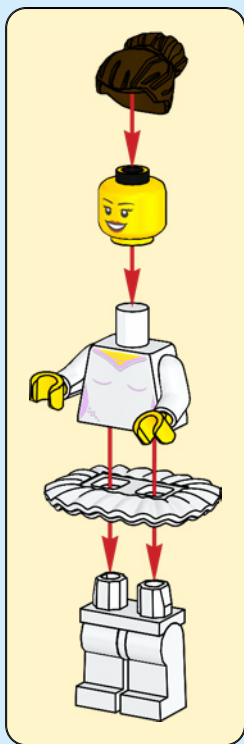

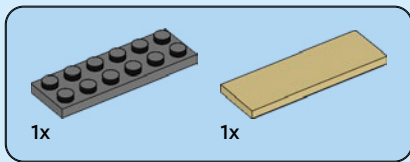
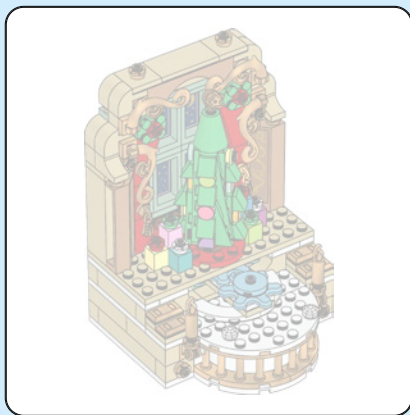

1

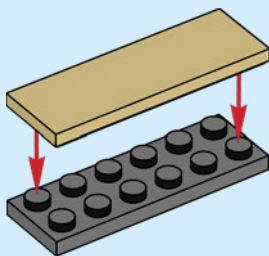

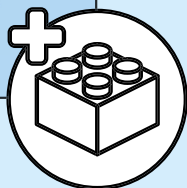
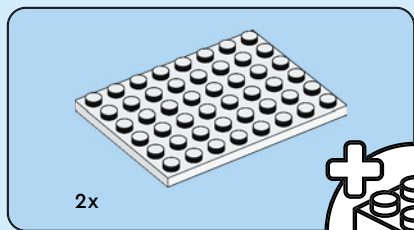

2

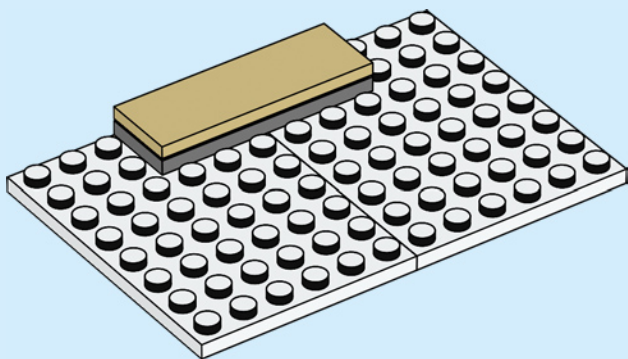



1x



1x

# 3

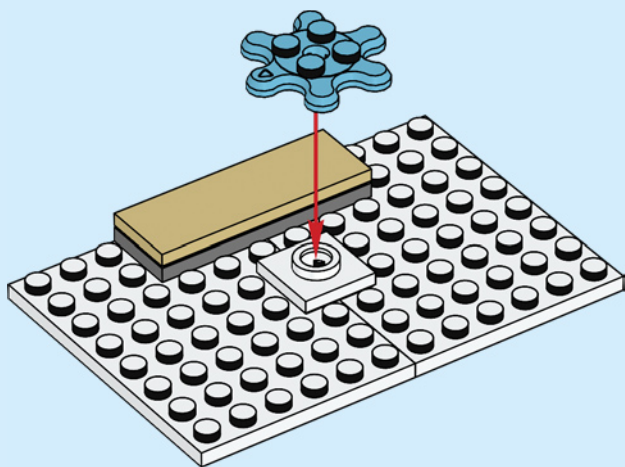

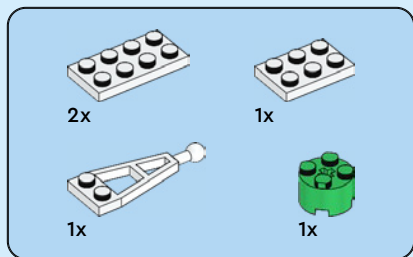

4

1

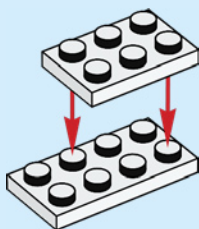

2

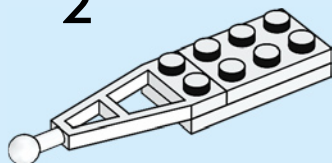

3

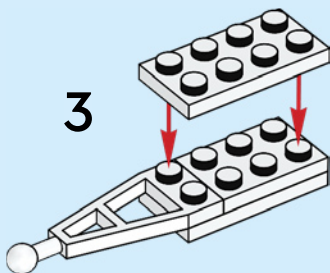

4

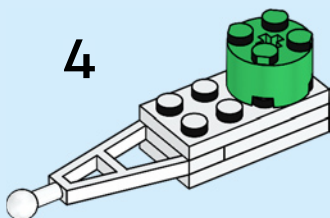



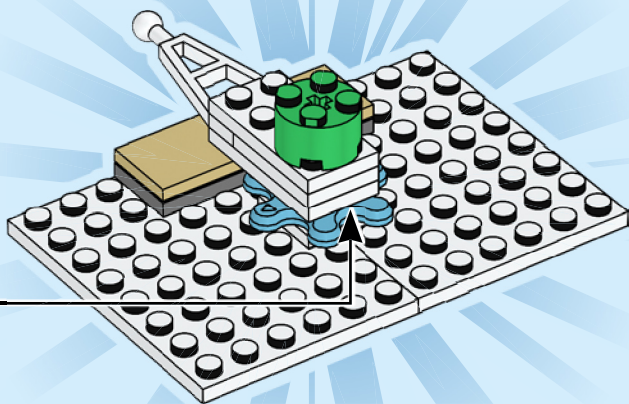

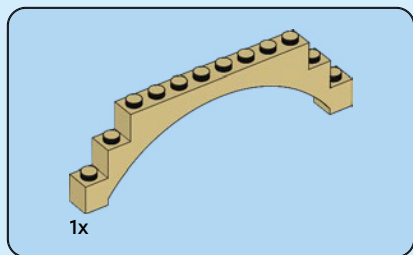

5

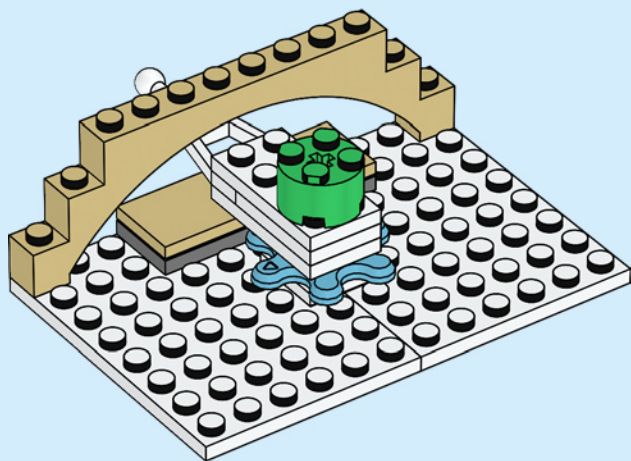

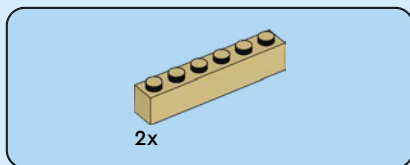

6

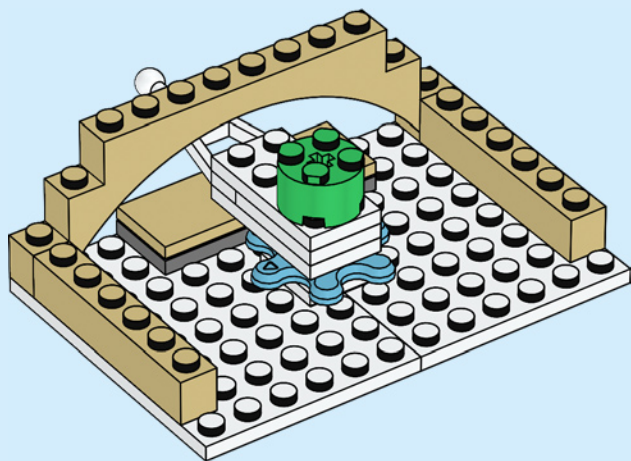



2x



2x

# 7

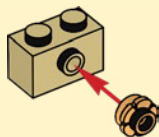

2x

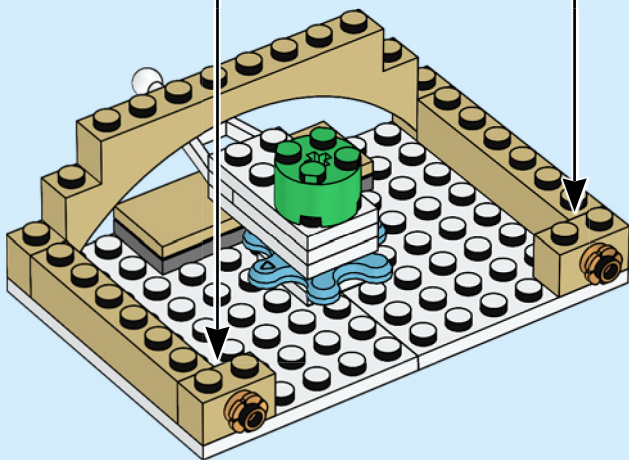



4x

8

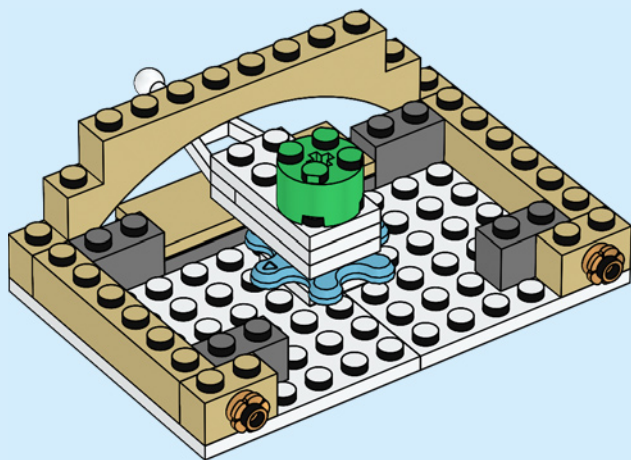



2x

9

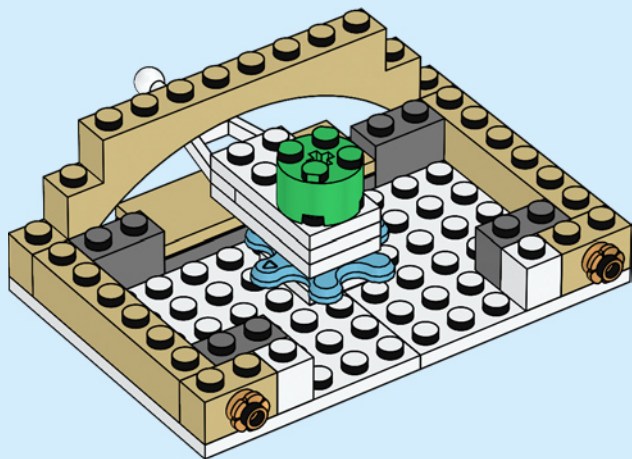

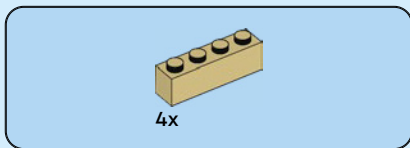

10

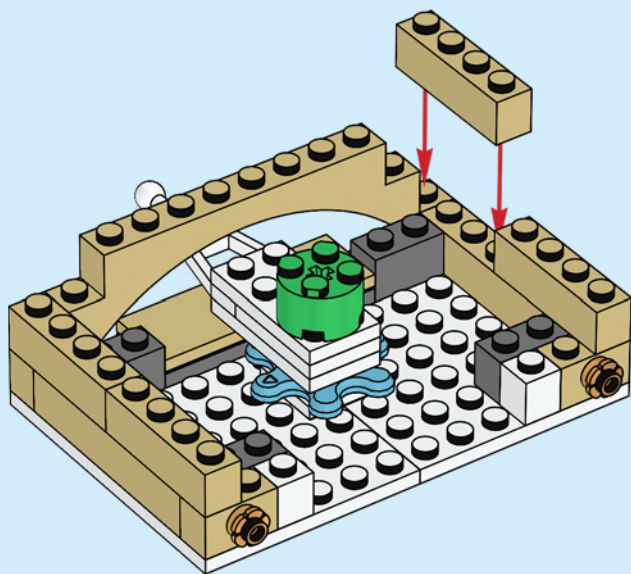

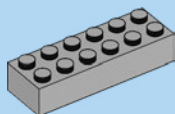

2x

# 11

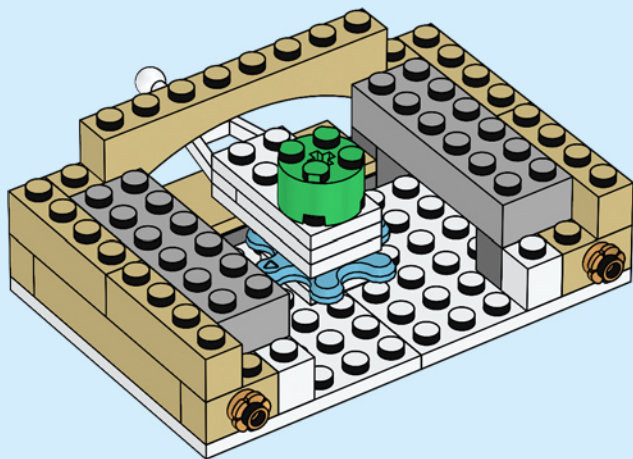





2x



2x

# 12

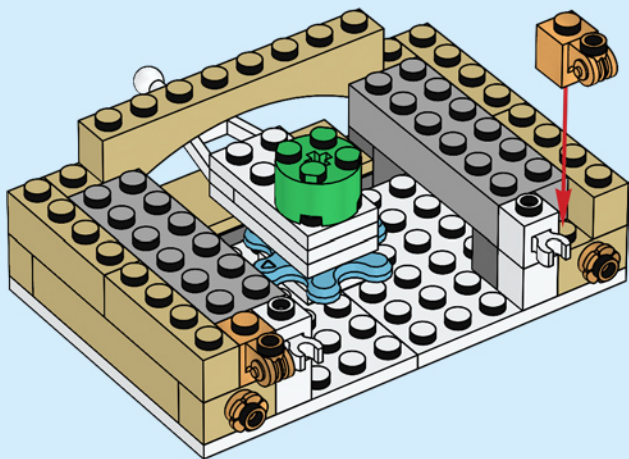

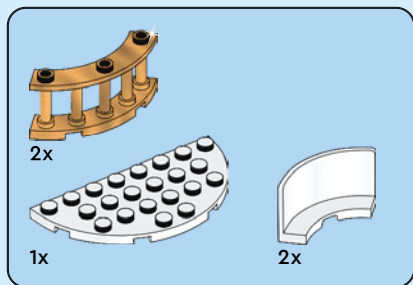

13

1

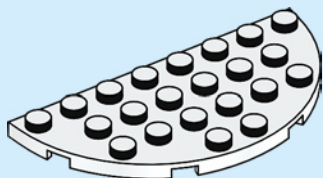

2

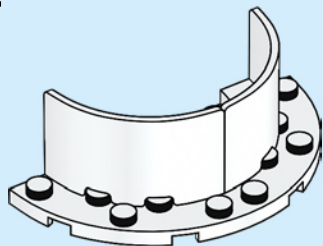

3

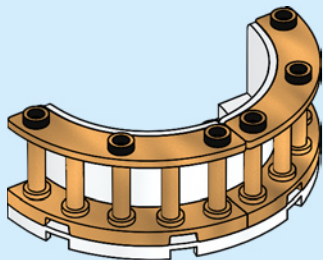

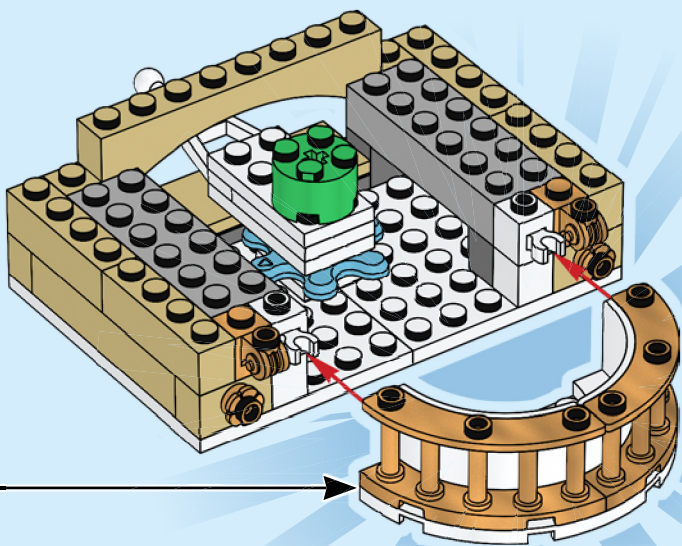



1x

14

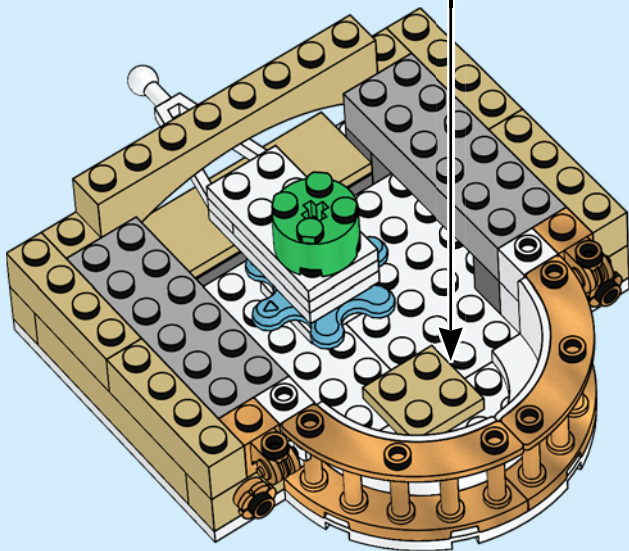

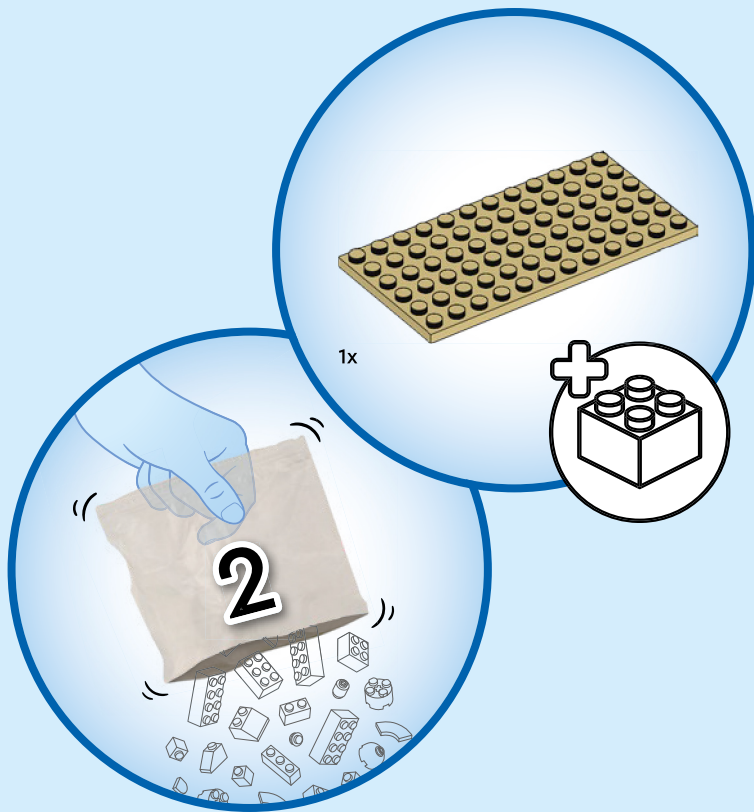



2x

15

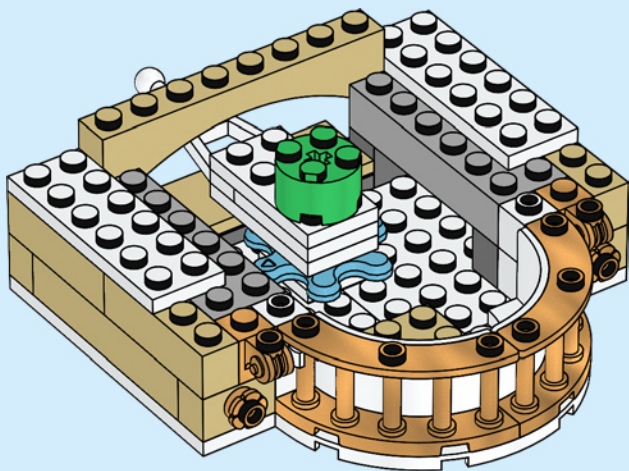

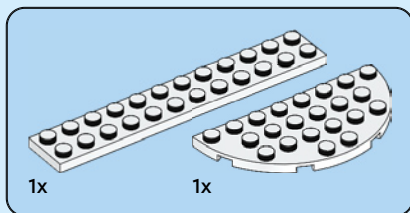

16

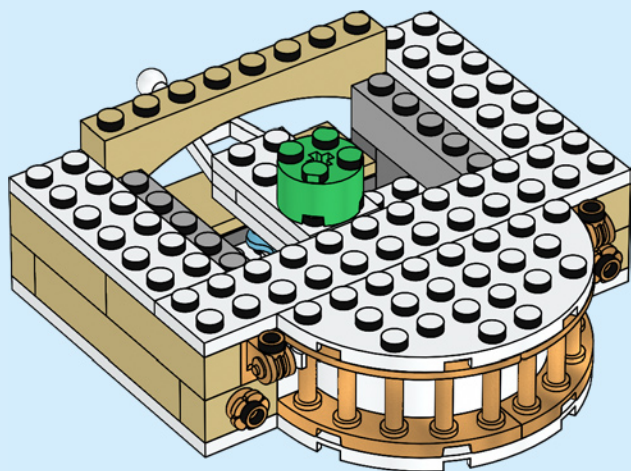

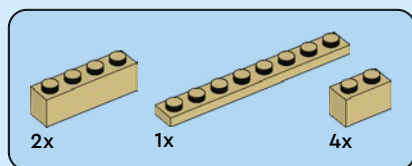

17

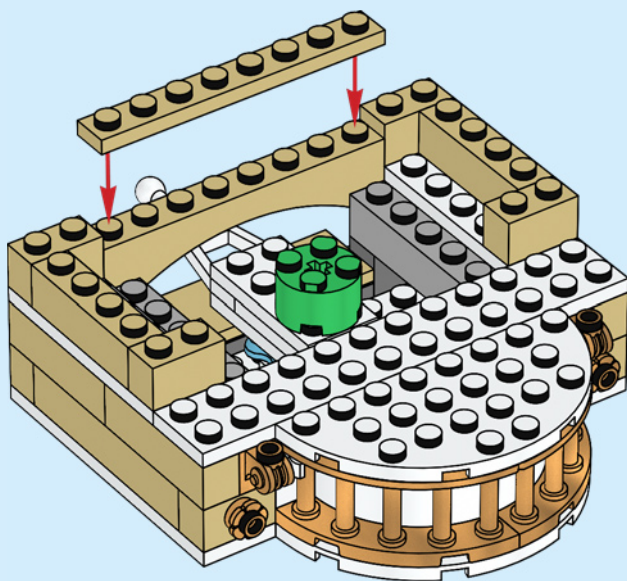



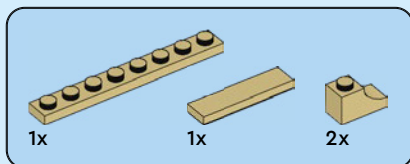

18

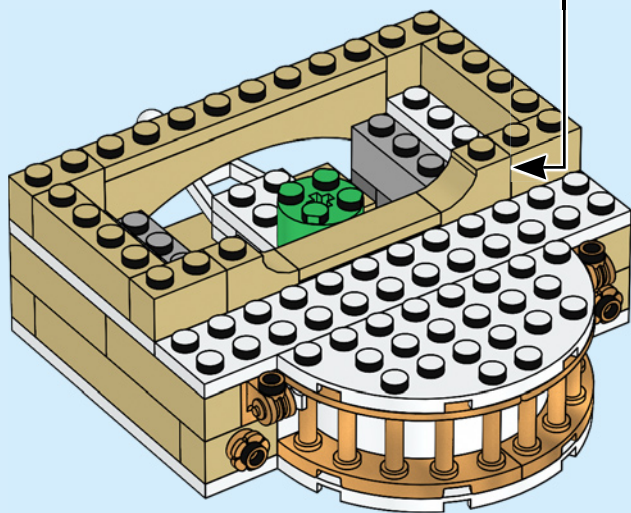
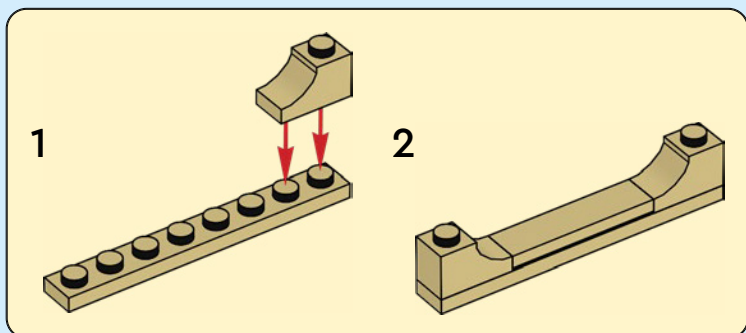



2x



2x

# 19



2x

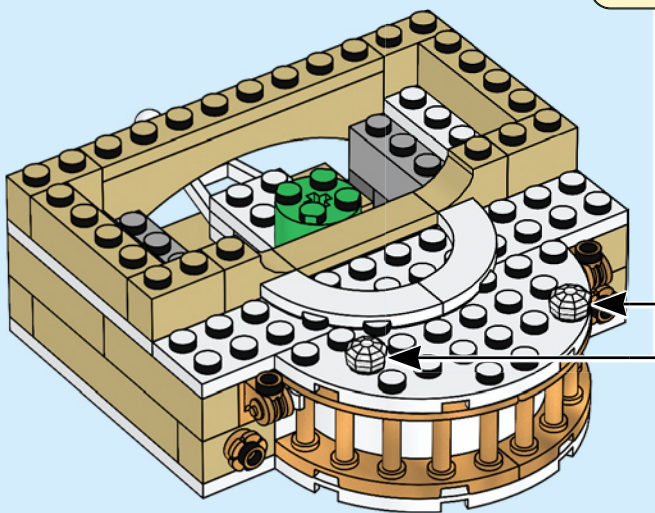



20

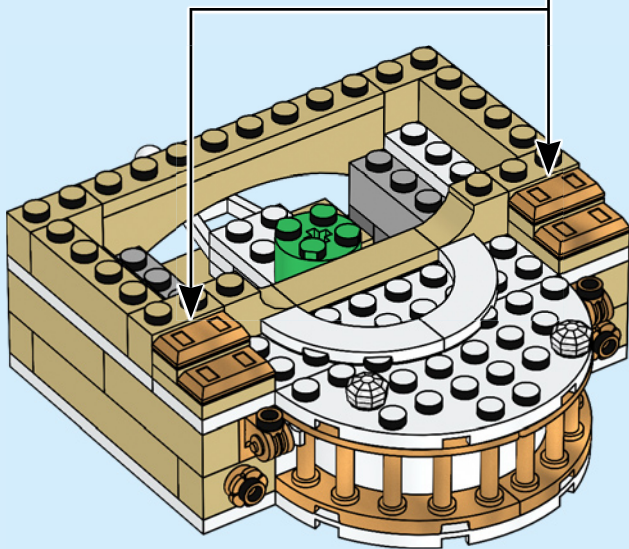
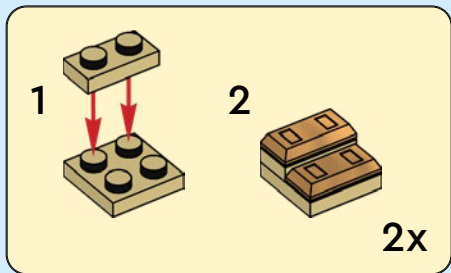

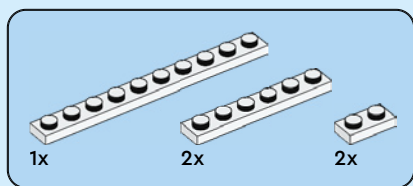

# 21

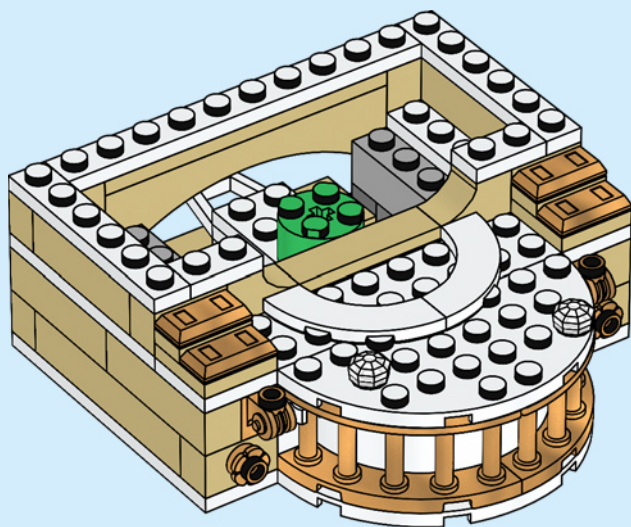

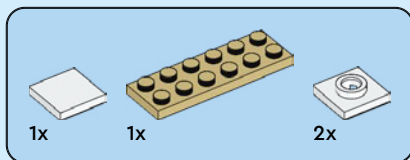

22

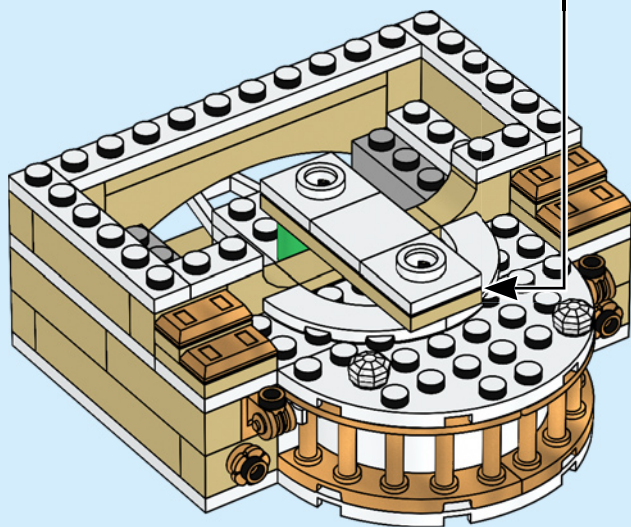
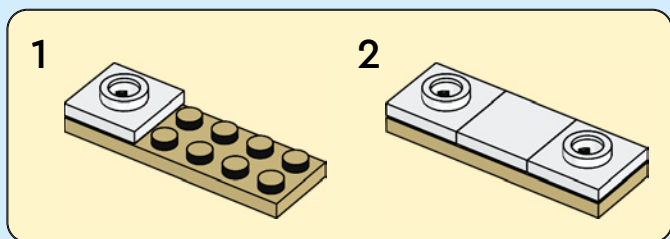

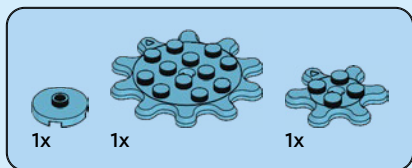

23

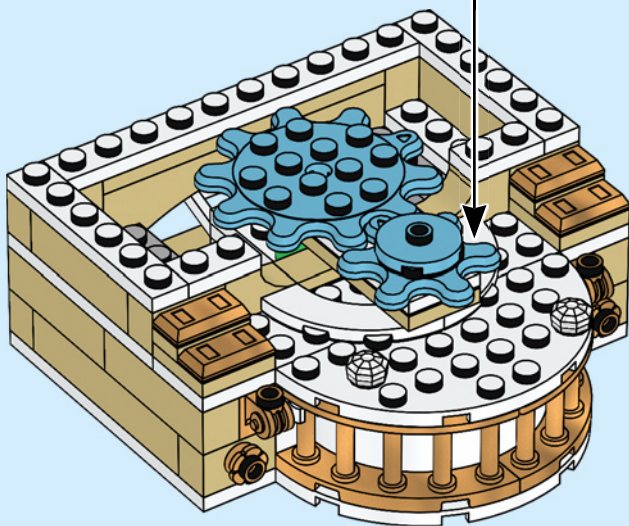
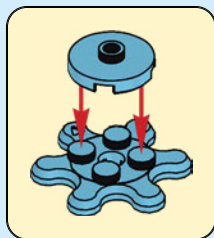

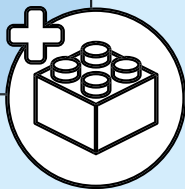
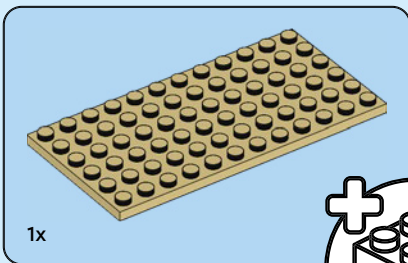

24

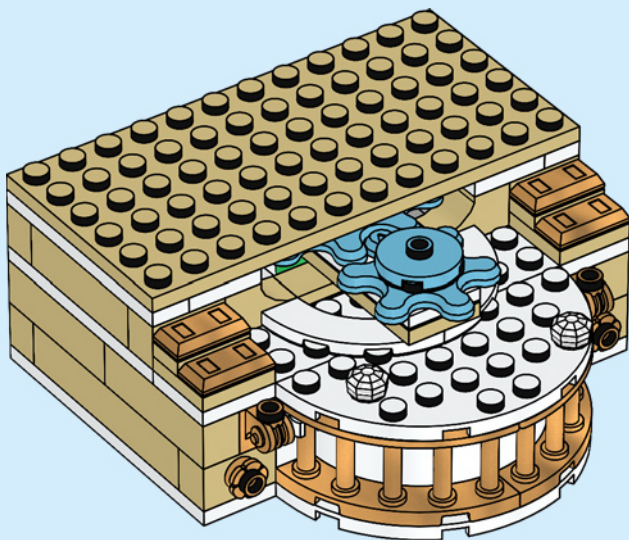





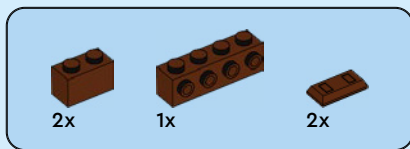

25

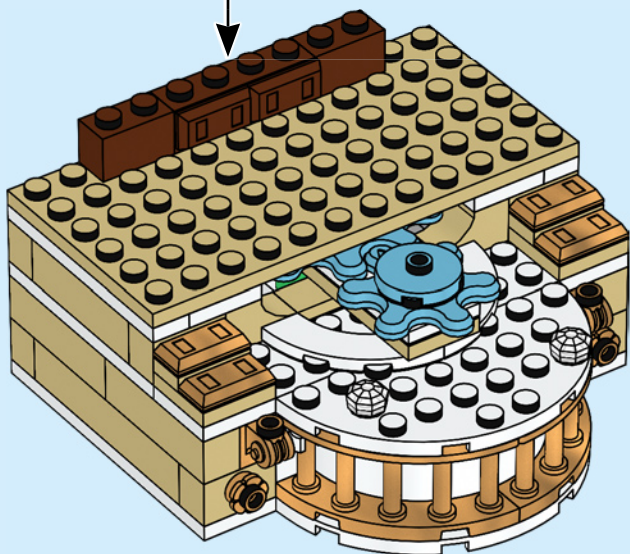
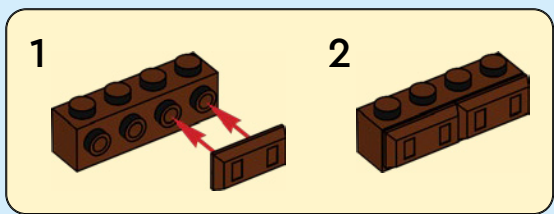

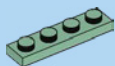

2x

26

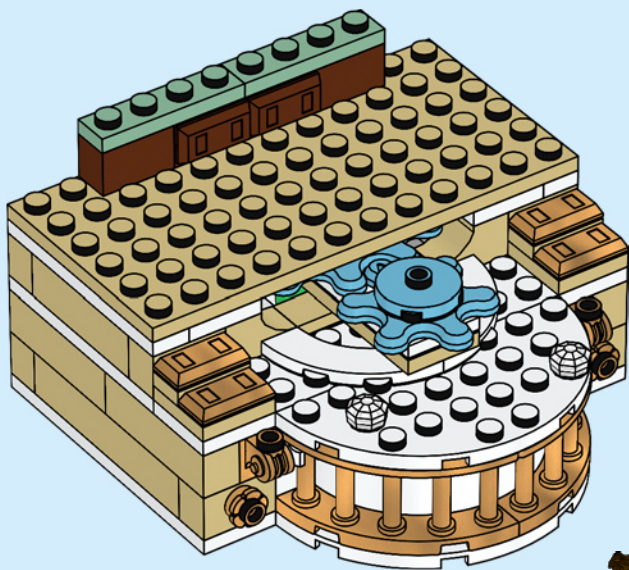

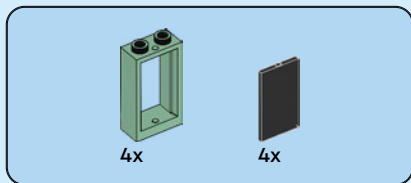

27

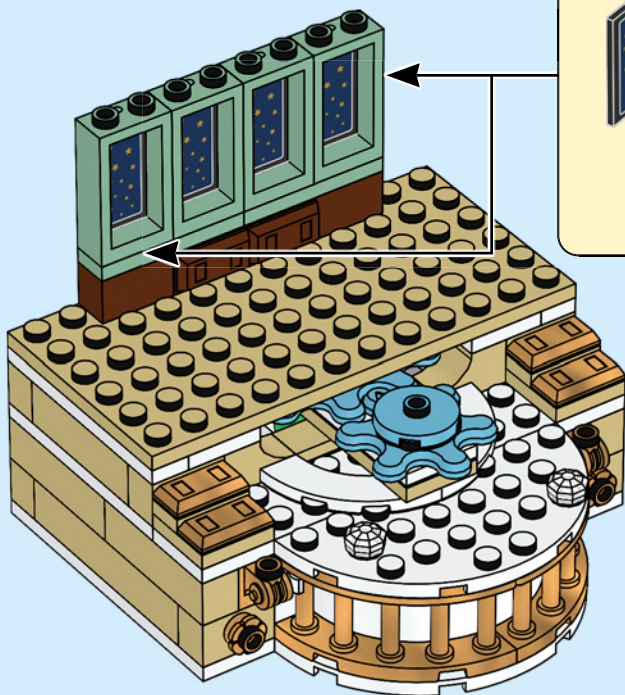
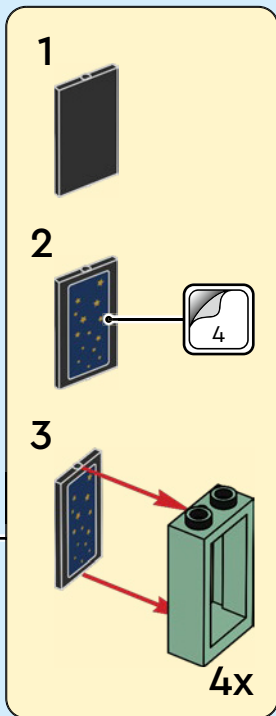

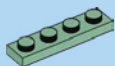

2x

28

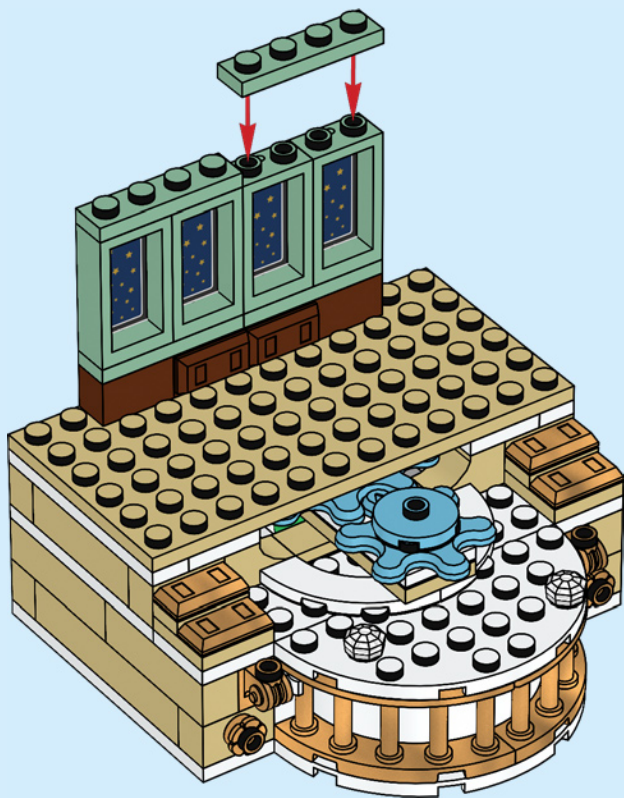

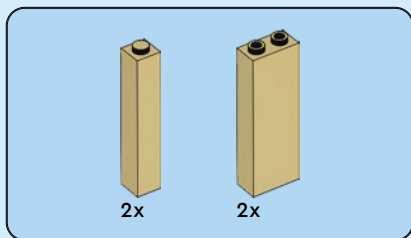

29

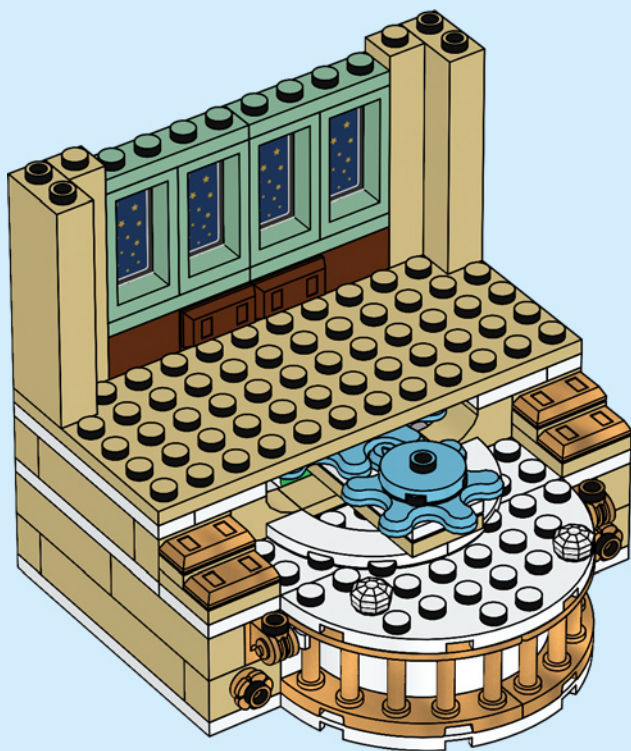

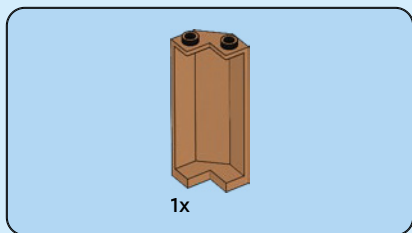

30

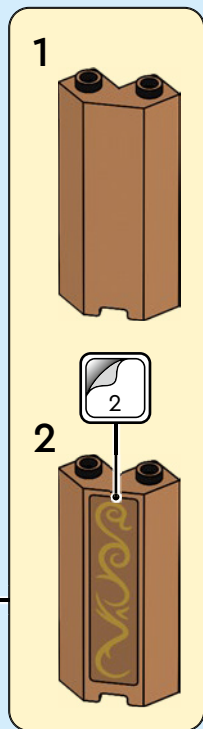
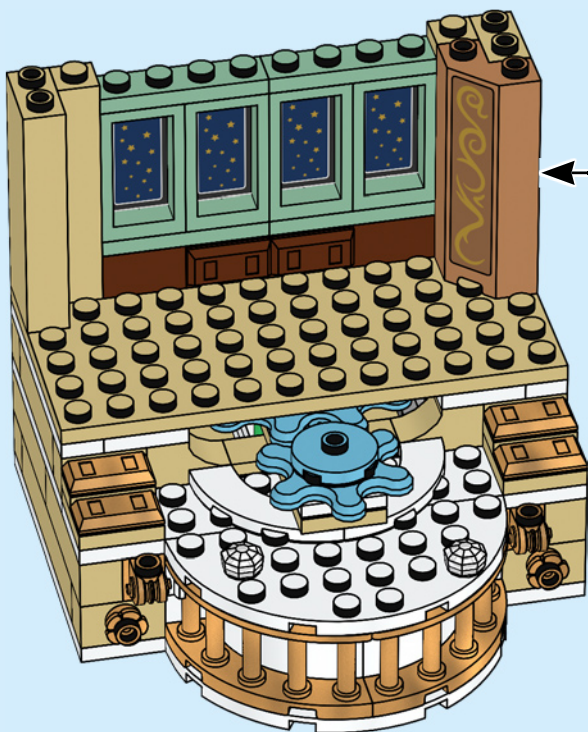

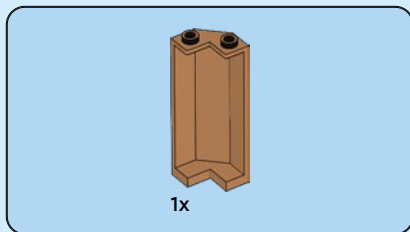

31

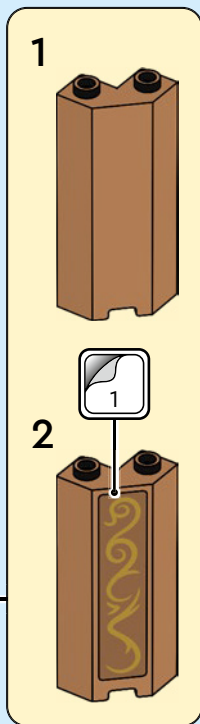
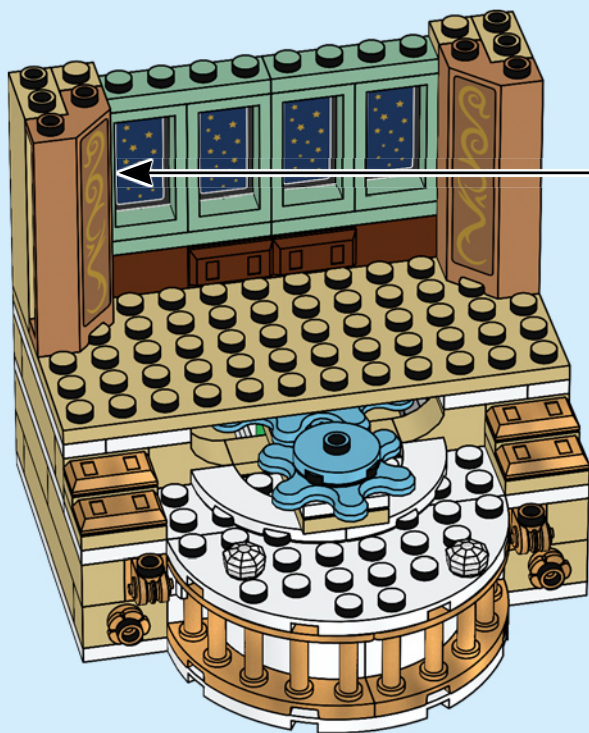



2x



2x

# 32

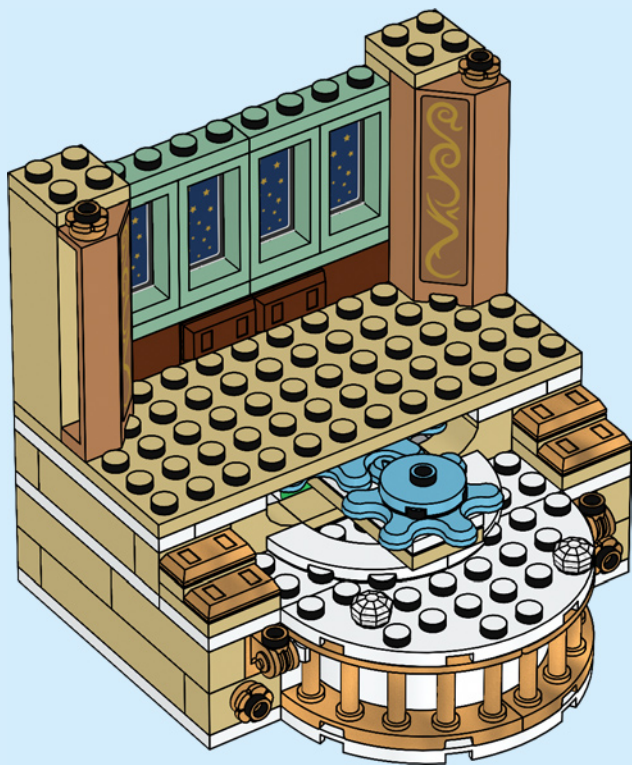



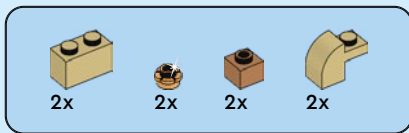

33

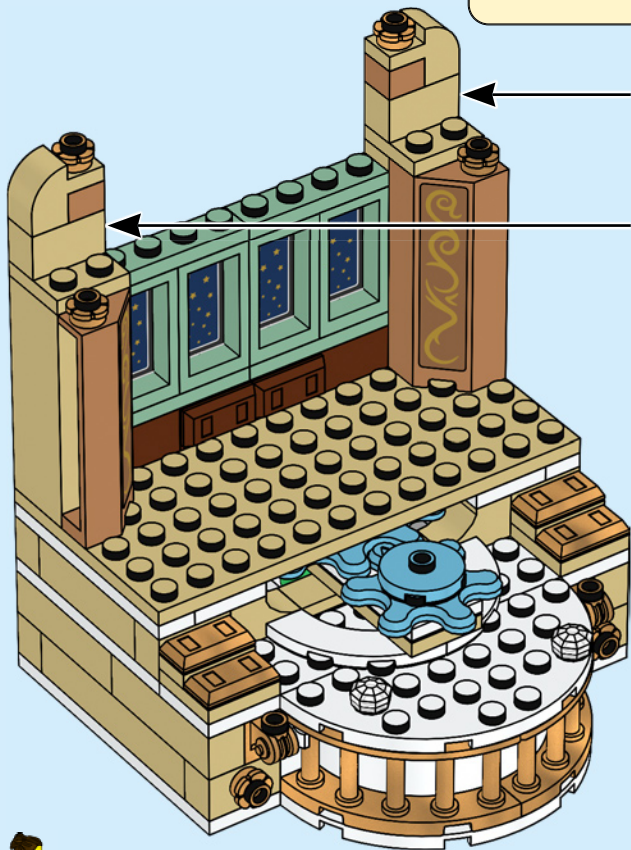
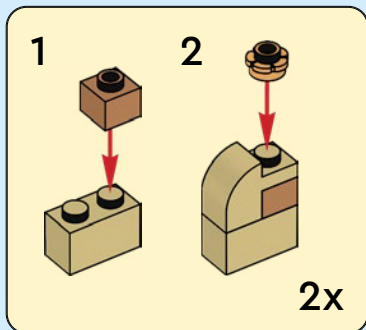



2x

34

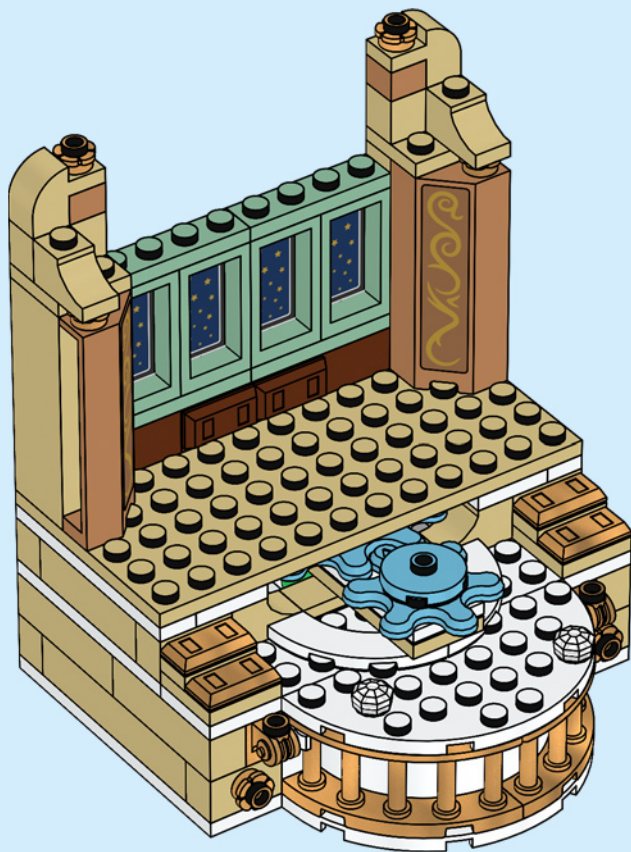



2x



2x



2x

# 35

1



2



2x

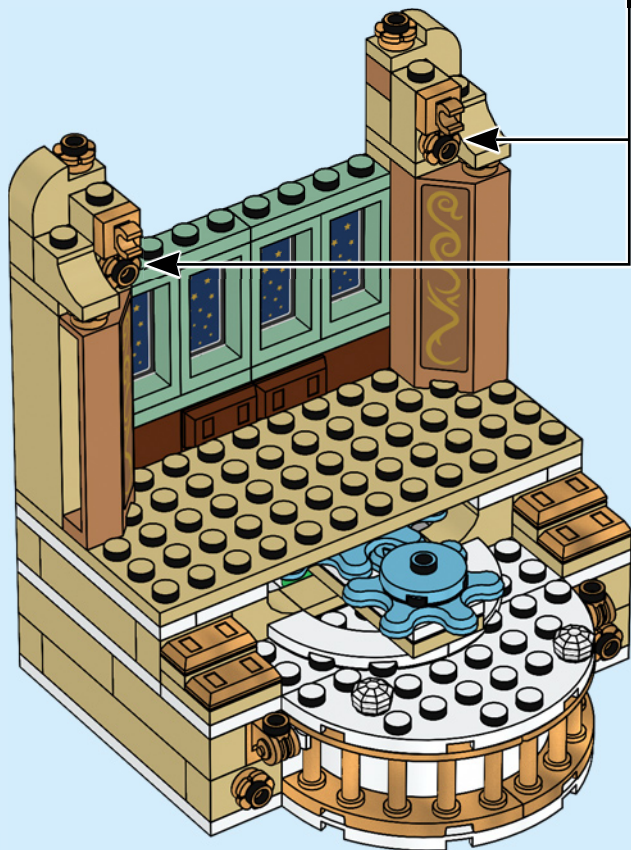



2x

36

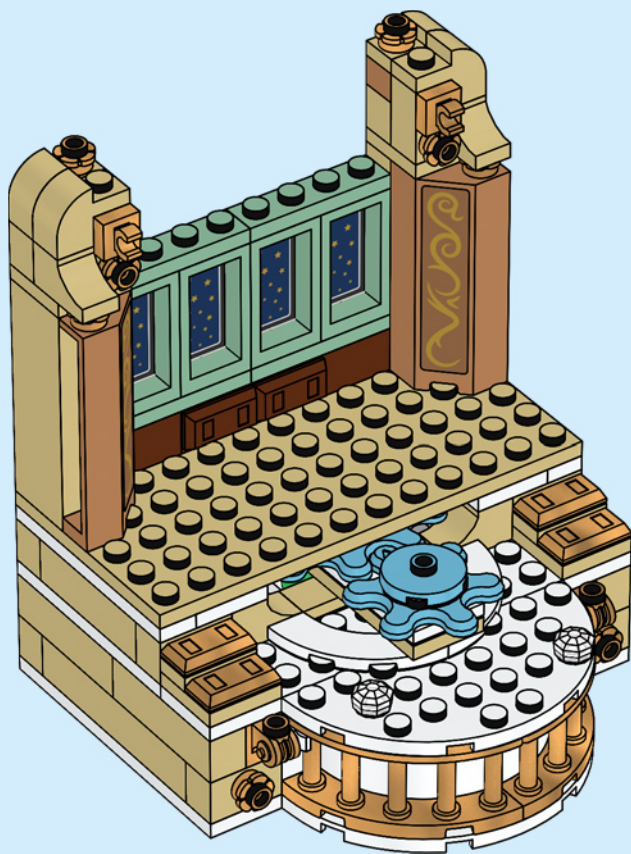

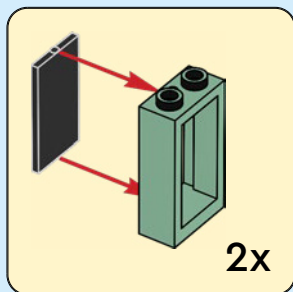
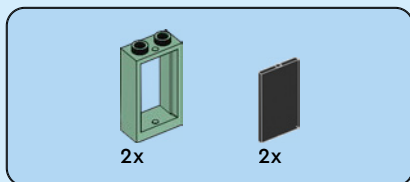

37

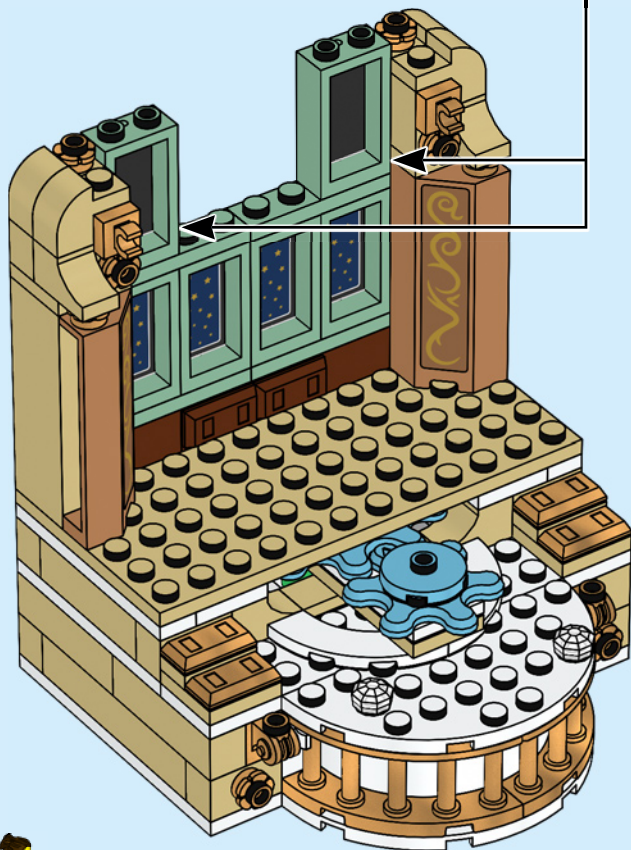

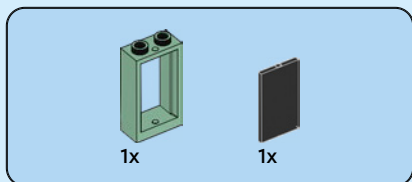

38

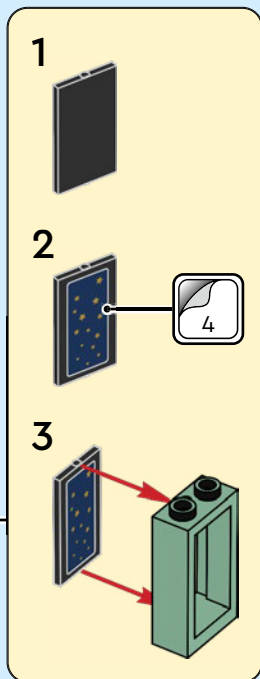
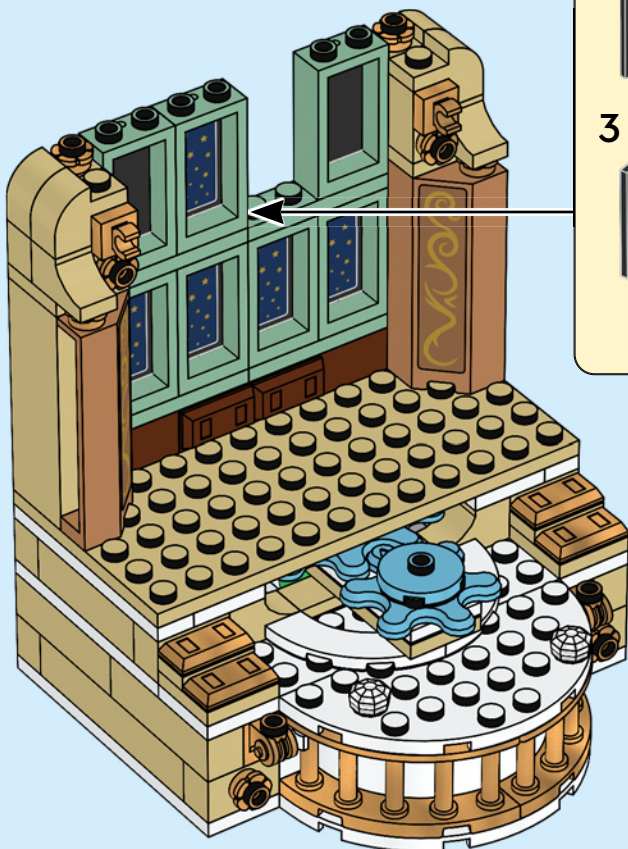

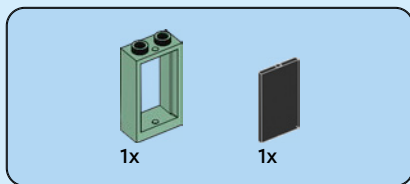

# 39

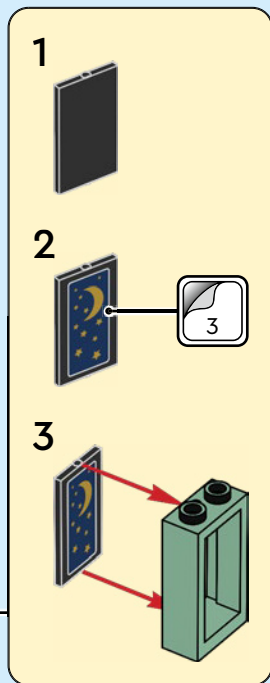
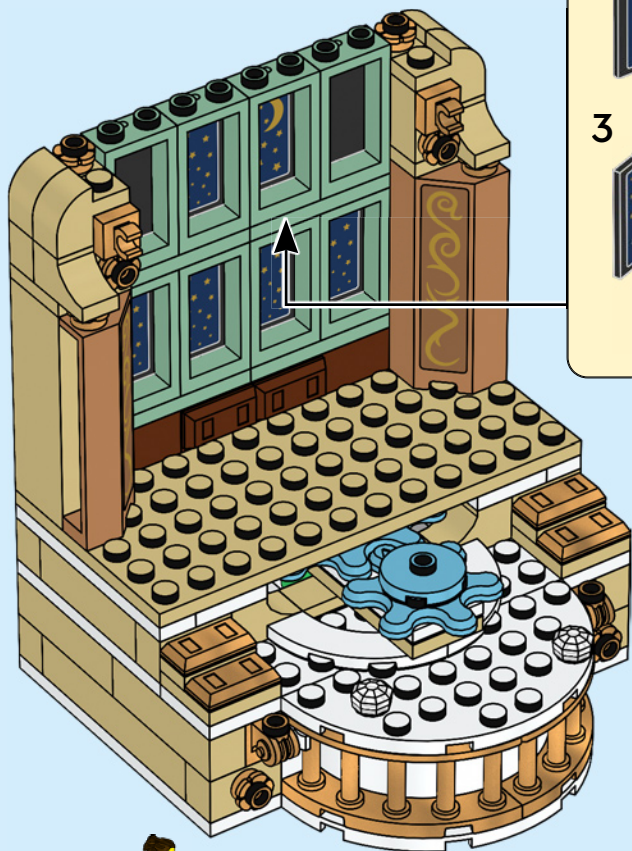

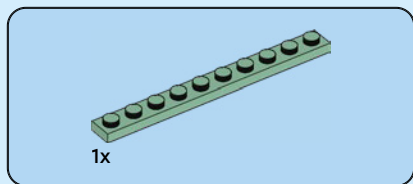

40

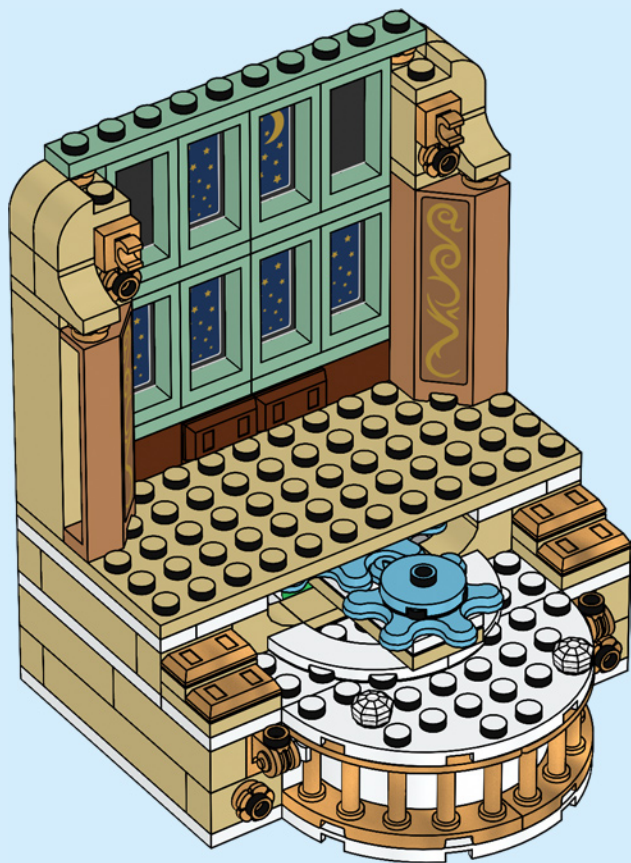







41

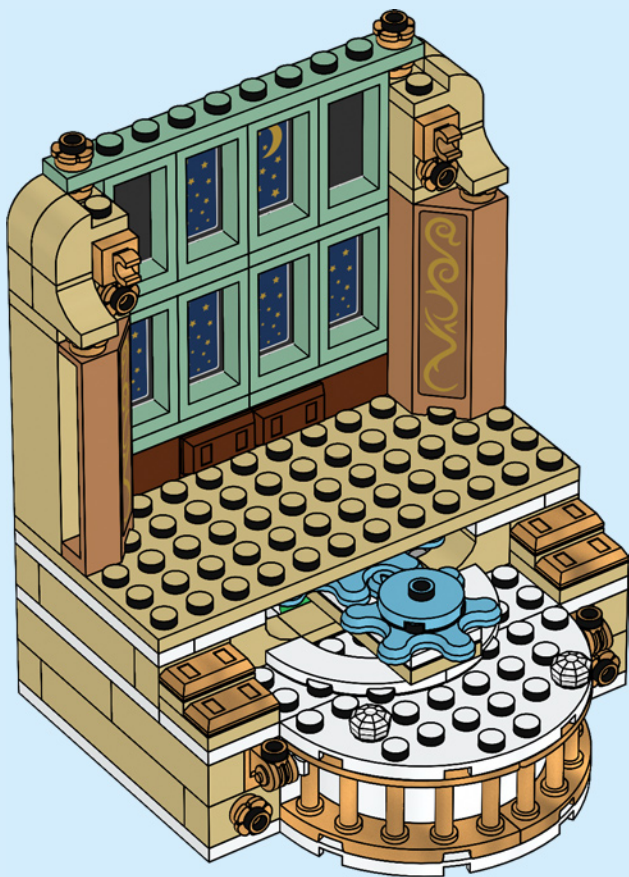

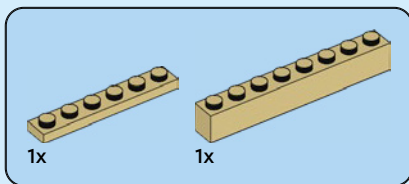

42

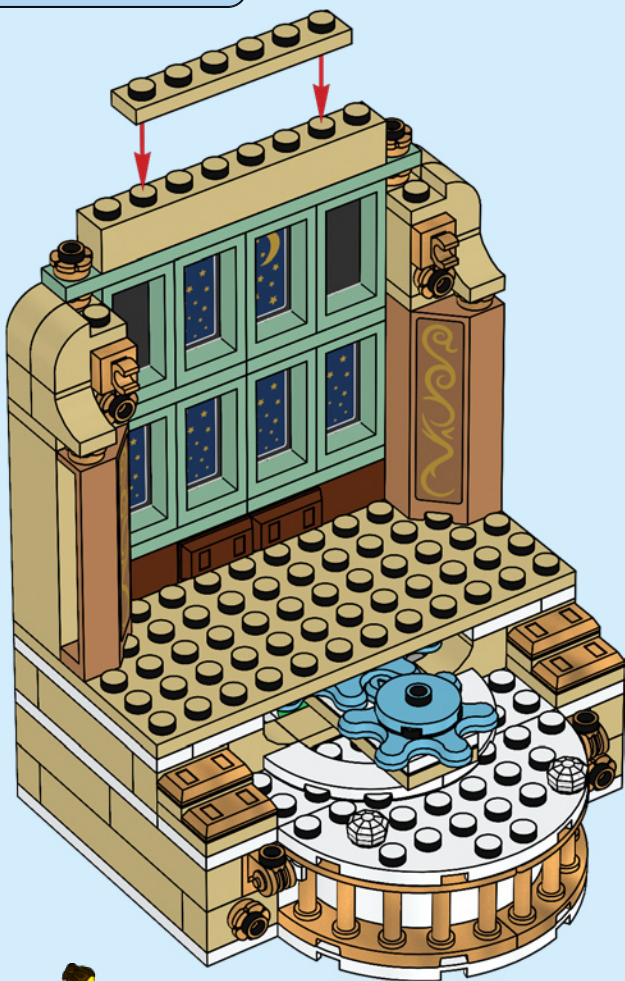



2x



2x



2x



2x



2x



2x

43

1

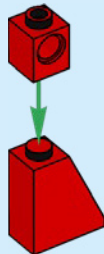

2

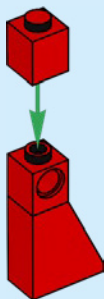

3

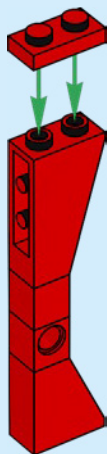

2x

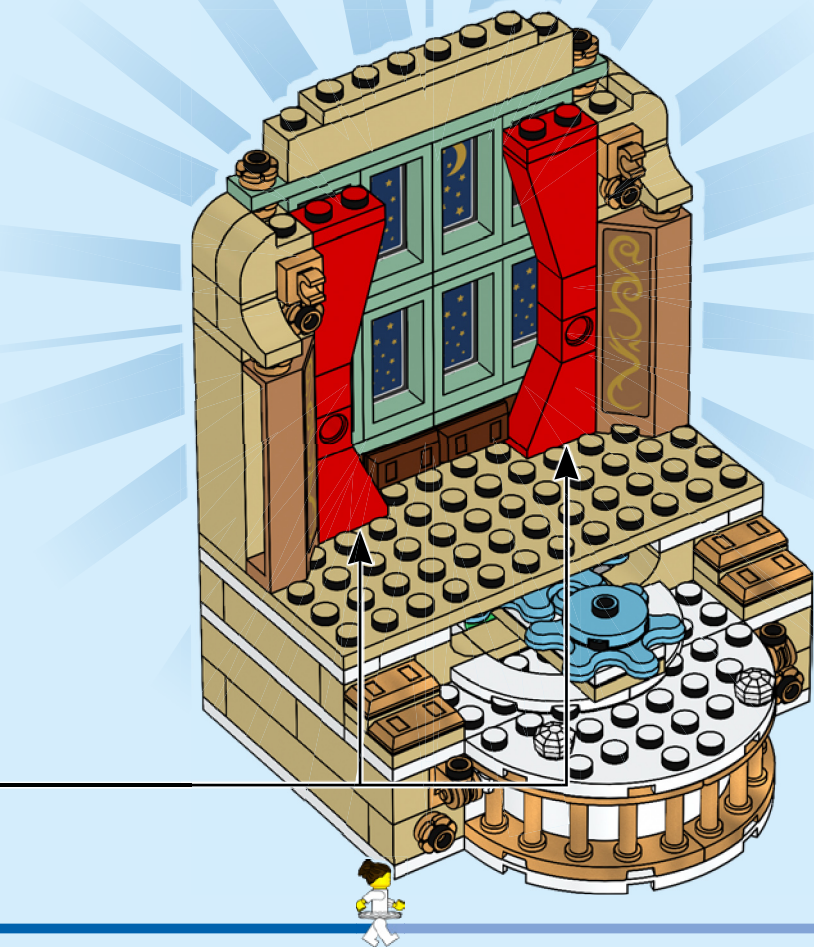

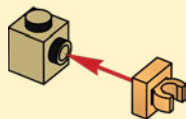

2x

44

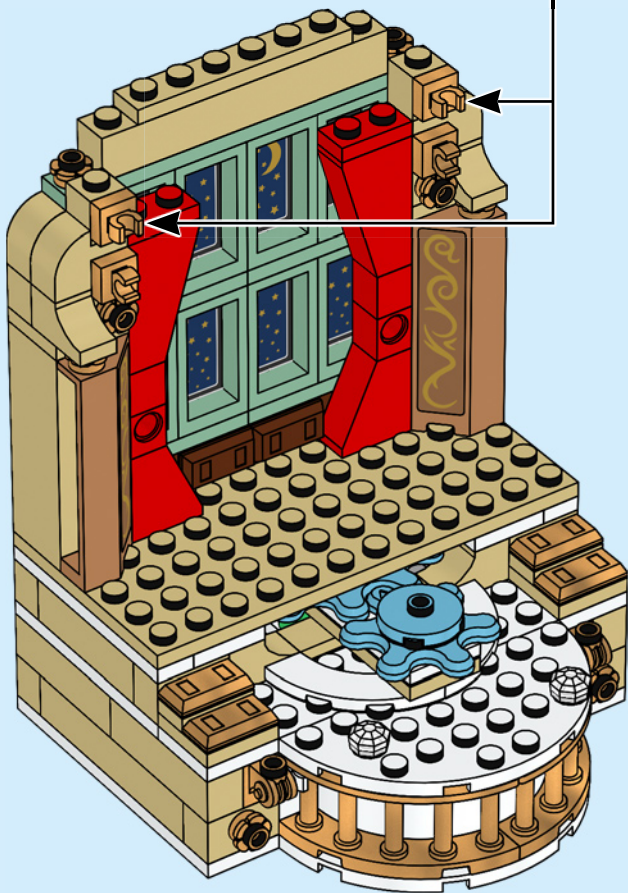

2x



2x

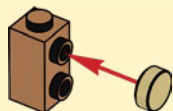

2x

45

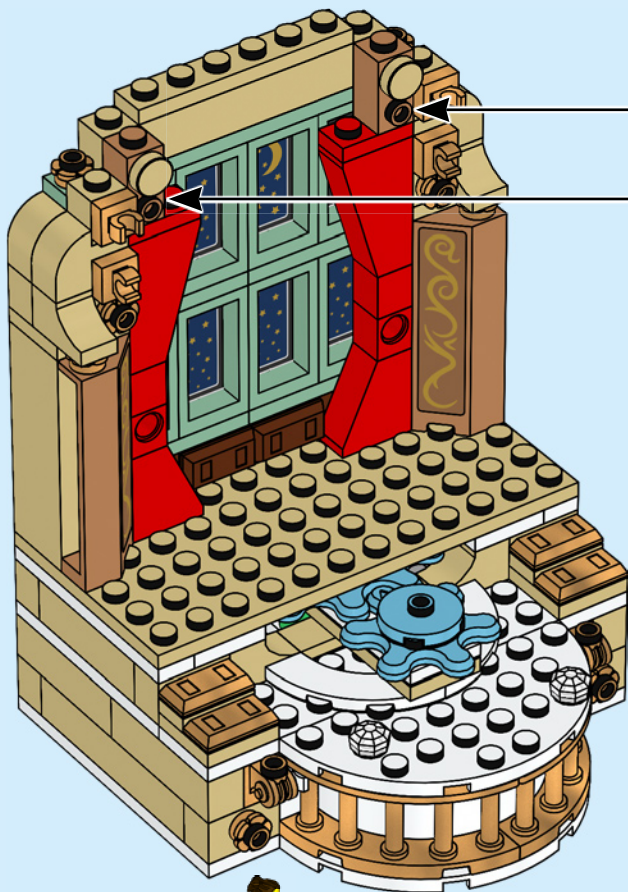

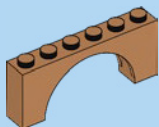

1x

46

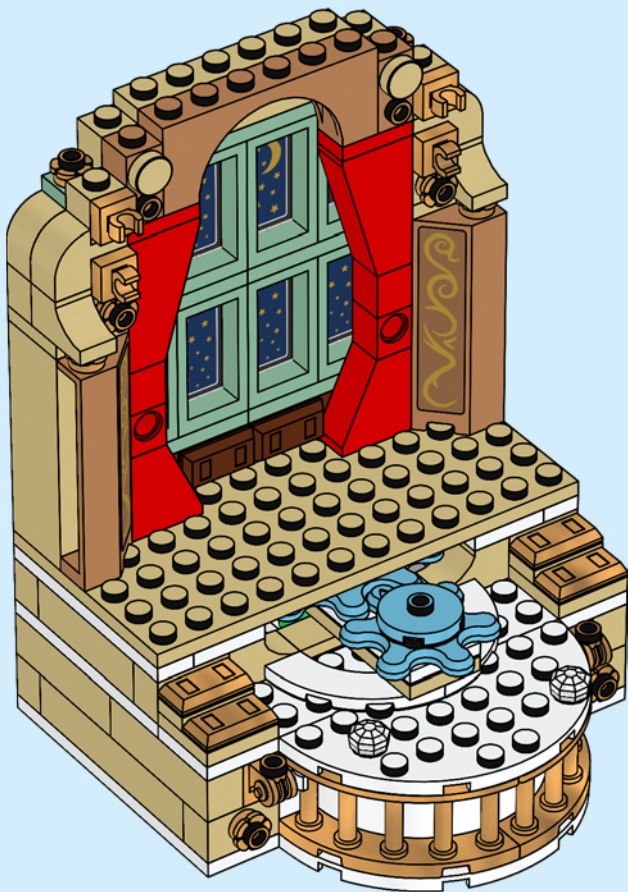





4x

47

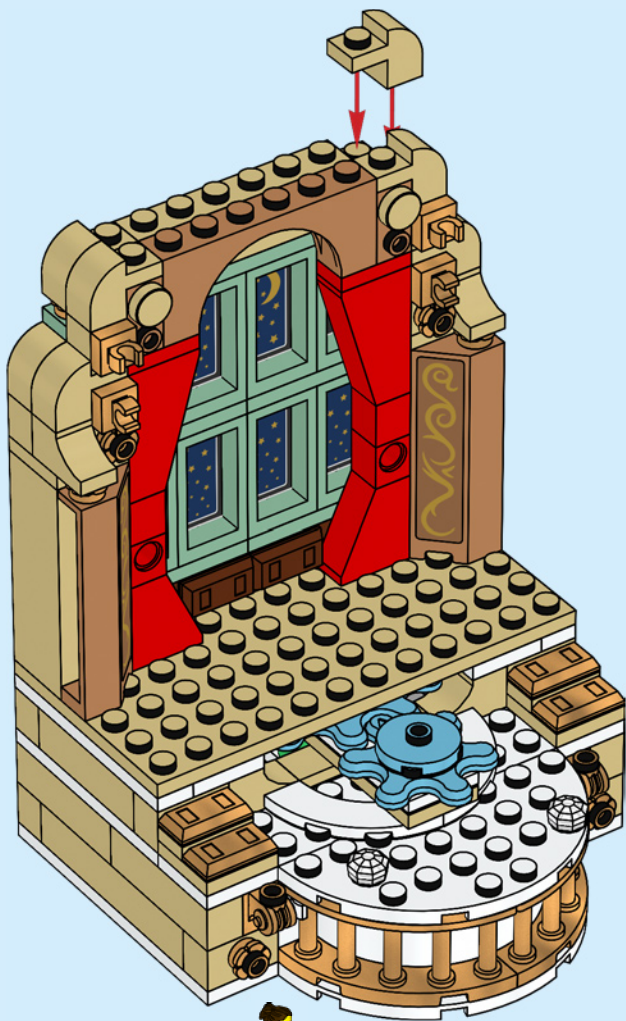

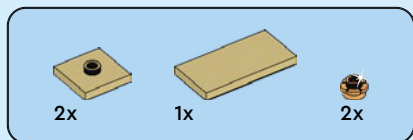

48

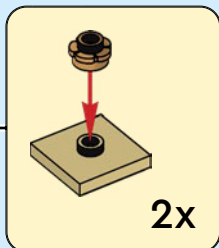
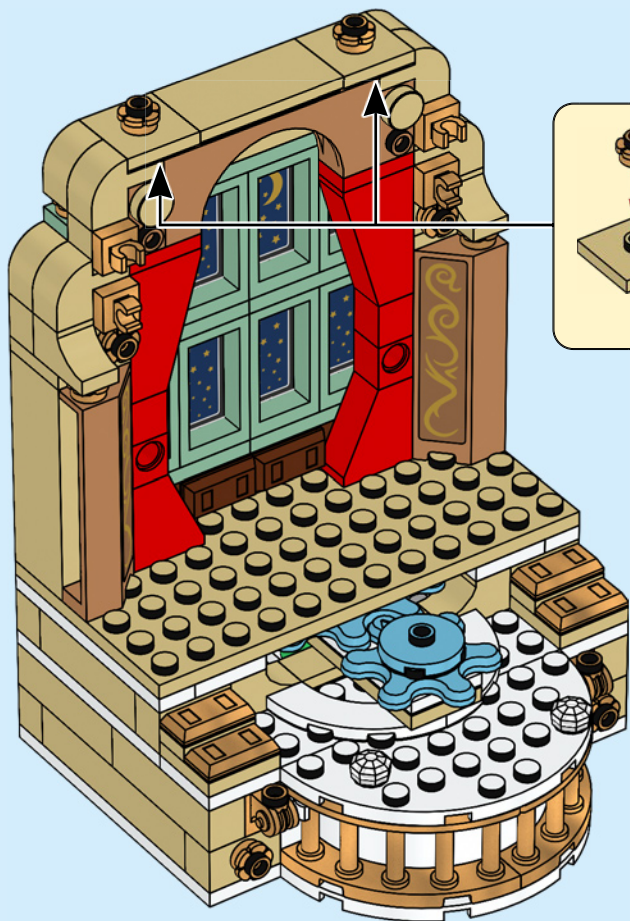



2x

# 49



2x

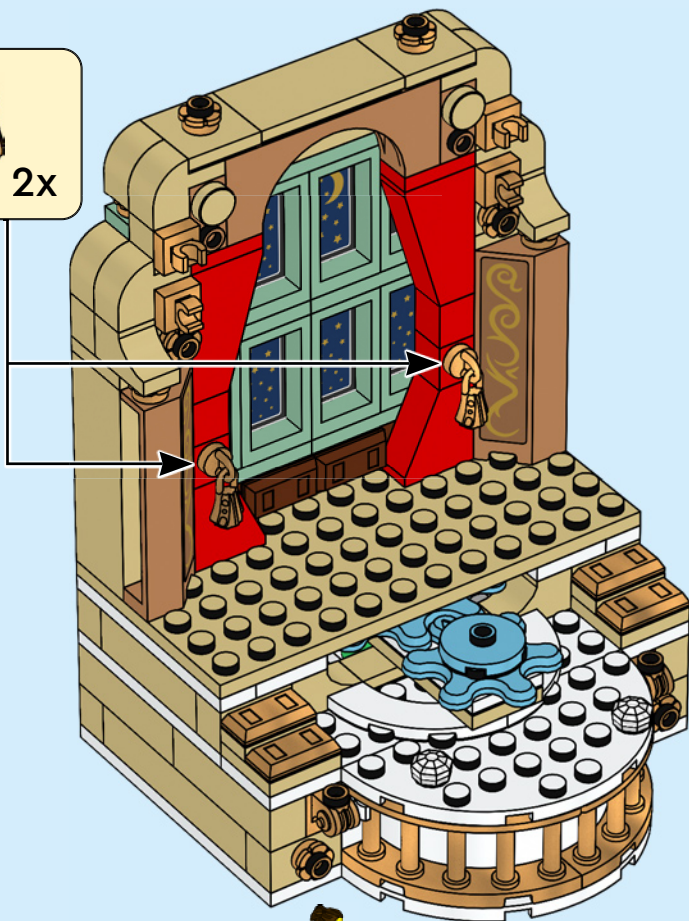





2x



2x

# 50

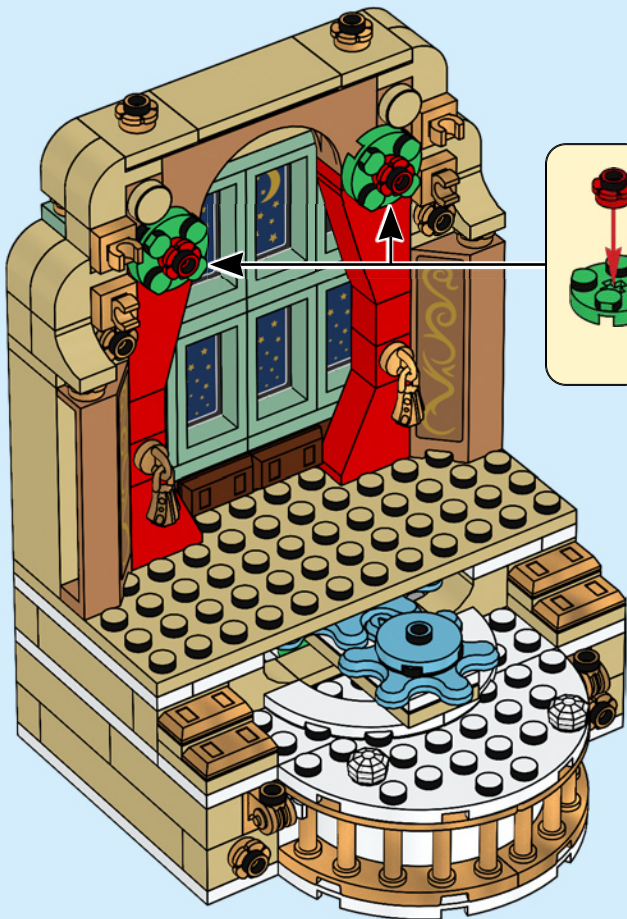

2x





4x

51

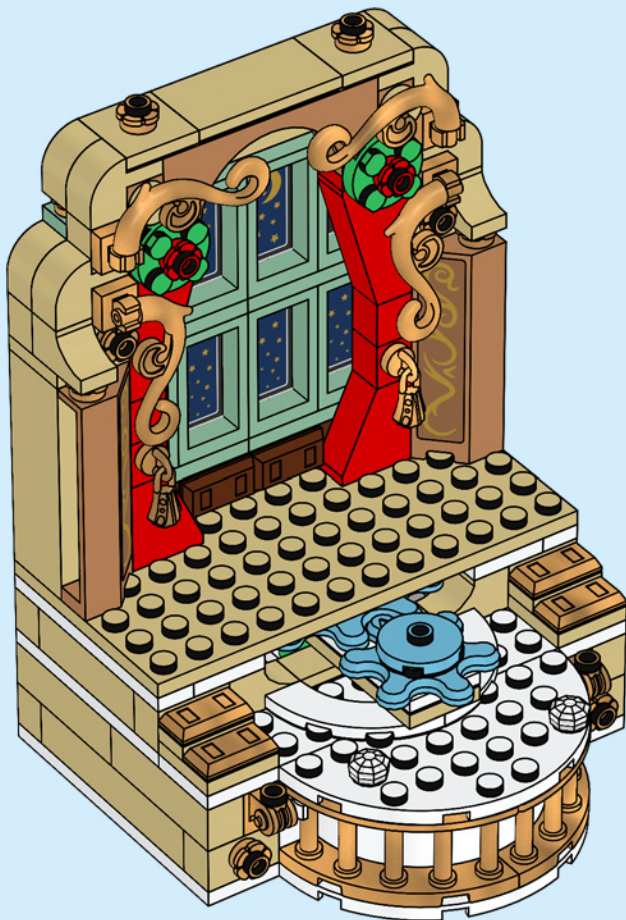



52

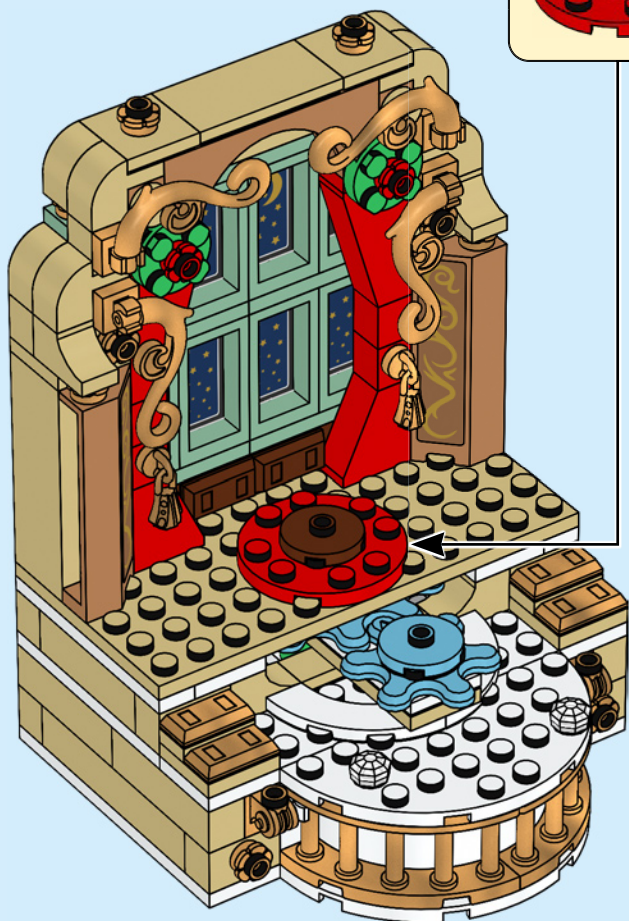



53

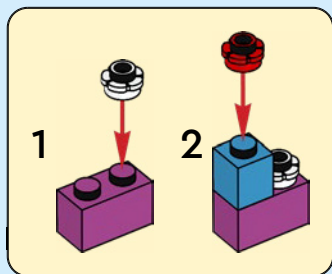





1x



1x



1x



1x

# 54

1

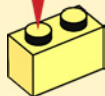

2

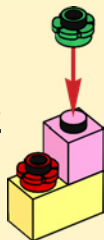



1x



1x



1x



1x

# 55

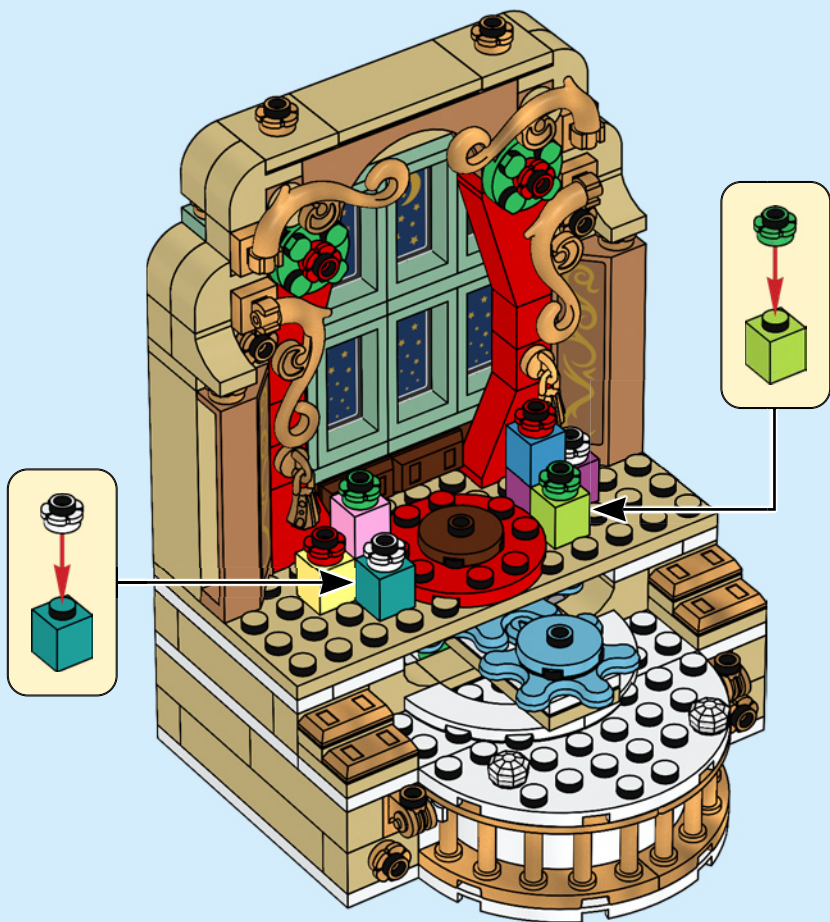



1x



1x

# 56

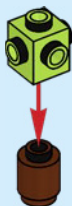



1x



1x

# 57



1x



1x

# 58

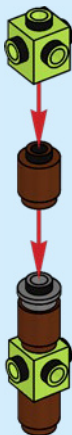

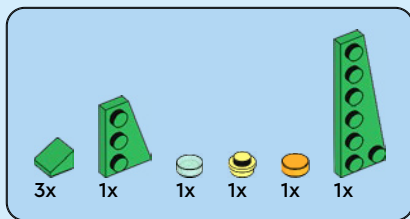

# 59

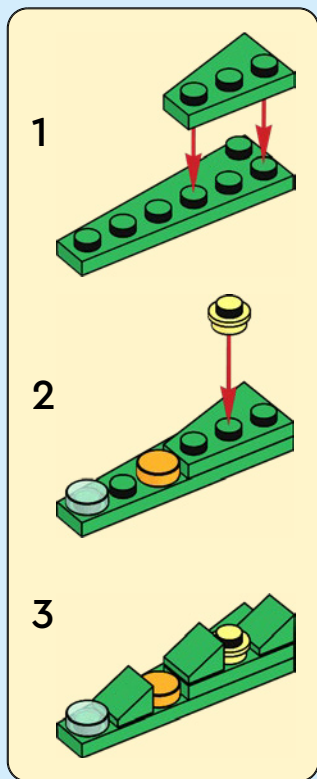

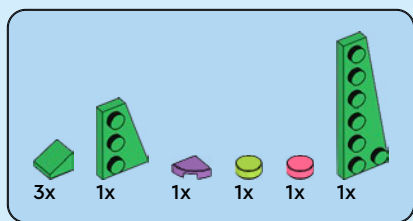

# 60

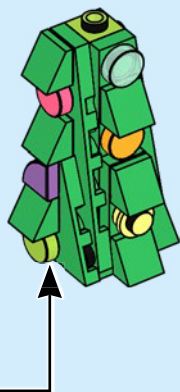
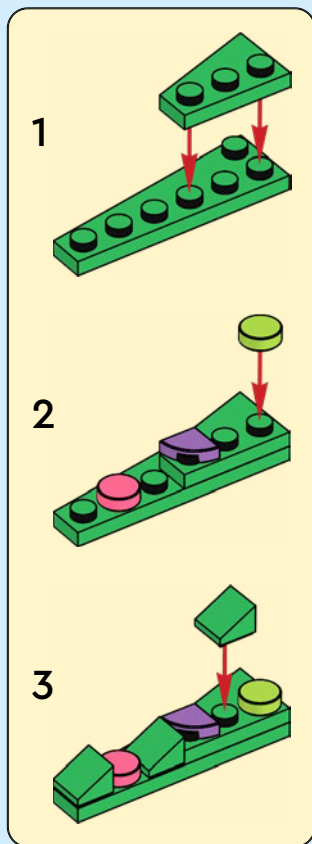

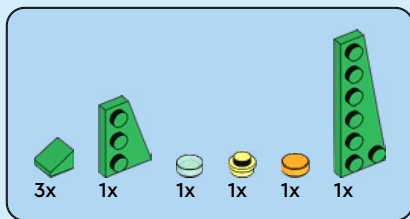

61

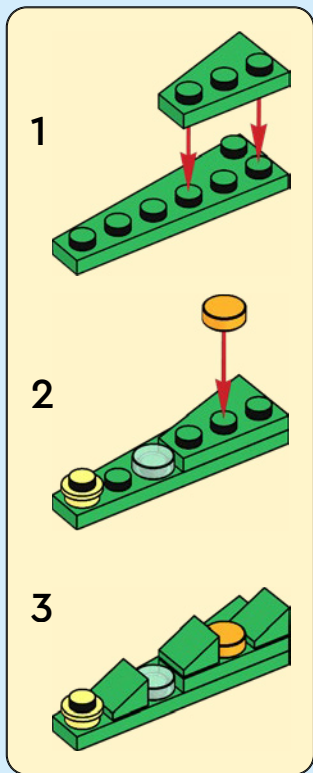

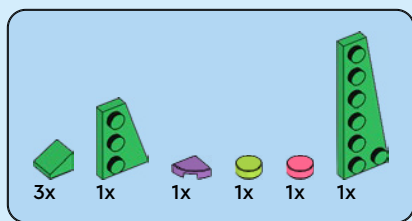

62

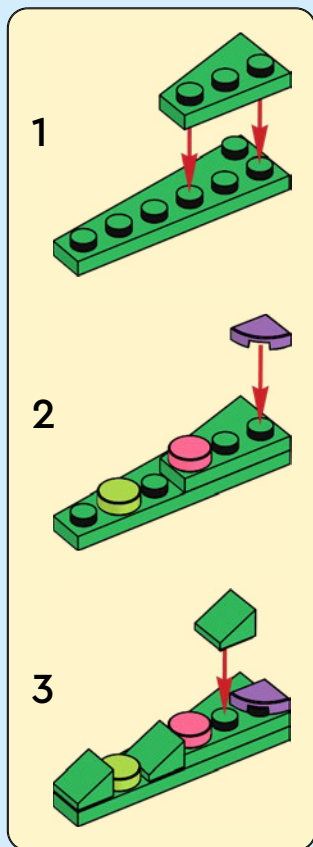





1x

63



1x



1x

64

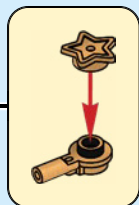

65





2x



2x



2x

# 66



2x





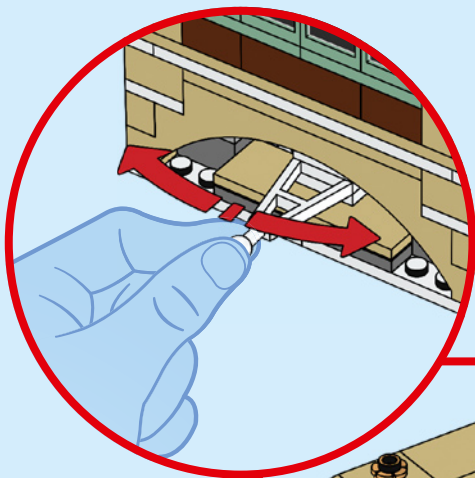

2x  
6206149



2x  
300501



2x  
6321349



1x  
9327



2x  
302301



3x  
6238334



1x  
306801



1x  
6504675



1x  
6460676



2x  
6472652



1x  
302101



2x  
6373439



2x  
302001

78

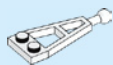

1x  
6333949



2x  
366601



2x  
379501



2x  
6138699



1x  
447701



2x  
303601



1x  
244501



1x  
244501



1x  
6246845

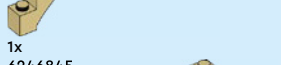

1x  
6185313

2x  
6284573



2x  
4579260



2x  
6232135



2x  
4112980



4x  
6383295



6x  
4109995



2x  
4113917



2x  
6478176



8x  
6411329



1x  
6331158



1x  
4113993



2x  
4114324



2x  
4159774



1x  
4114064



5x  
4114084



2x  
4565387



6x  
4113916



1x  
4550324



1x  
6122047



2x  
4112982



1x  
4124067



1x  
6331158



1x  
4113993



2x  
4114324



1x  
4159774



4x  
6206148



2x  
654121



2x  
300521



2x  
4515371



2x  
302321



2x  
300521



2x  
4515371



2x  
302321



2x  
4501534



1x  
4515348



1x  
4651443



8x  
6476097



2x  
6135287



12x  
4546705



4x  
6385261



1x  
6385261



1x  
6385261



1x  
6385261



1x  
6385261



1x  
6385261





4x  
4621947



2x  
403228



1x  
6189162



1x  
4251378



1x  
6213776



2x  
6284583



1x  
4220634



2x  
6174006



1x  
4519195



8x  
6468393



4x  
6100234

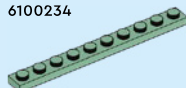

1x  
6328184



2x  
6357747



2x  
6322822



3x  
4211183



1x  
6102360



2x  
4211149



2x  
6261744



1x  
6153594



2x  
4211795



1x  
6231765



4x  
4211088



1x  
4211002



1x  
4286050



2x  
6319958



2x  
6290401



2x  
6274711



14x  
6209691



1x  
6184647



4x  
6262138



1x  
6335111



2x  
6112307



4x  
6207933



4x  
6172437



2x  
6155062



1x  
6301335



1x  
6158322



2x  
6422082



2x  
6383946



2x  
6499103



1x  
6106193



1x  
6225538



1x  
6022083



1x  
6136419



2x  
6271207



1x  
6238331



2x  
6199893



2x  
6311436



2x  
6287309



2x  
6299900



LEGO.com/service

YOU COULD

WIN



Scan this QR code or go to **LEGO.COM/PRODUCTFEEDBACK** and give us your short feedback about this LEGO® set for a chance to win a cool LEGO prize.

Terms and Conditions apply\*

**EN: YOU COULD WIN.** Terms and Conditions apply\* **DE: Du könntest GEWINNEN.** Es gelten die Teilnahmebedingungen\* **FR: Tu pourrais GAGNER.** Des conditions s'appliquent\* **IT: Potresti VINCERE tu.** Termini e condizioni sono applicabili\* **ES: Puedes GANAR.** Aplican términos y condiciones\* **PT: Poderá GANHAR.** Aplicam-se termos e condições\* **ZH: 轻松获奖. 条款和条件适用\*** **PL: Szansa na WYGRANĄ.** Obowiązują warunki korzystania\* **CS: Máte šanci VYHRÁT.** Platí všeobecné smluvní podmínky\* **SK: Máte šancu VYHRAŤ.** Platia všeobecné zmluvné podmienky\* **HU: TE IS NYERHETSZ.** Felhasználási feltételek érvényesek\* **RO: Ai putea CÂȘTIGA.** Se aplică termeni și condiții\* **BG: Можете да СПЕЧЕЛИТЕ.** Има определени правила и условия\* **LV: Tu vari LAIMĒT.** Ir spēkā noteikumi un nosacījumi.\* **ET: Sul on võimalus VÕITA.** Kehtivad tingimused\* **LT: Jūs galite LAIMĖTI.** Taikomos sąlygos\*

\*[LEGO.com/productfeedback-terms](https://www.lego.com/productfeedback-terms)

LEGO and the LEGO logo are trademarks of the LEGO Group. ©2024 The LEGO Group.

6538467