



40707





## **Get excited about our new packaging!**

We're switching from plastic to paper-based packaging. That's why you might find a mix of paper and plastic in our boxes!

## **Nos nouveaux emballages vous emballeront !**

Nous passons des emballages en plastique aux emballages à base de papier. C'est pourquoi vous pourriez trouver un mélange de papier et de plastique dans nos boîtes !

## **¡Te presentamos nuestros nuevos empaques!**

Estamos sustituyendo las bolsas de plástico por bolsas con base de papel. ¡Por eso, puedes encontrar una mezcla de papel y de plástico en nuestras cajas!

**[LEGO.com/sustainable-packaging](https://www.lego.com/sustainable-packaging)**



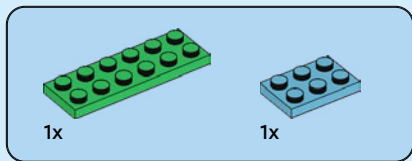

1

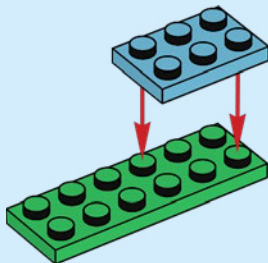



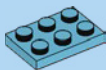

1x

2

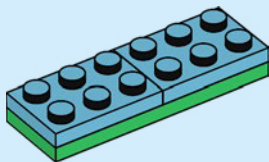

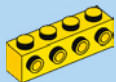

2x



1x



2x

# 3

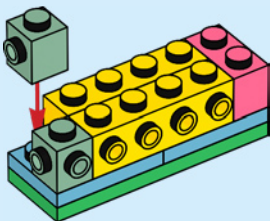



1x



1x

4

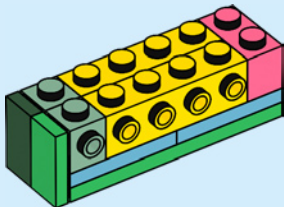



1x

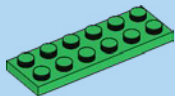

1x

5

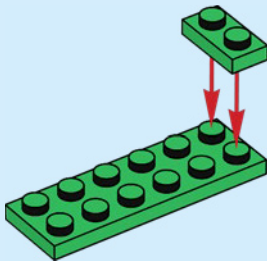

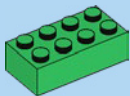

1x



1x

6

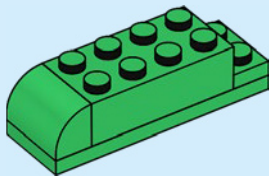



1x



2x

7

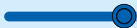
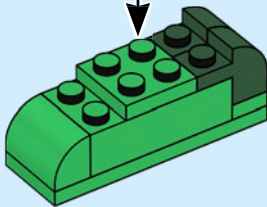
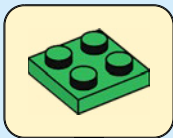



1x



1x

8

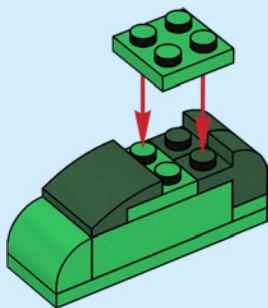

9

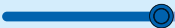
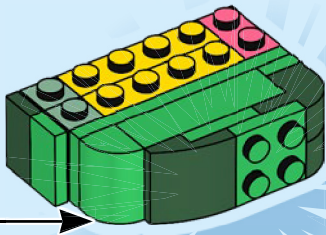





1x

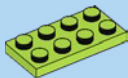

1x

# 10

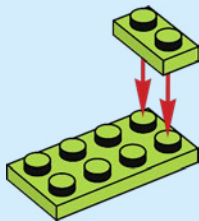

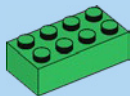

1x

11

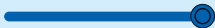
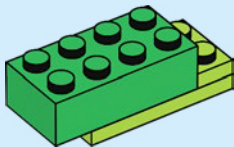



1x



1x

# 12

1

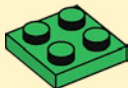

2

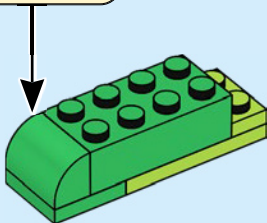
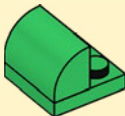



1x



2x

# 13

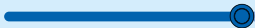
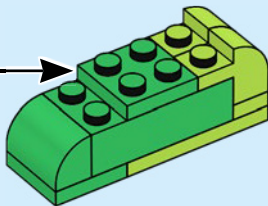
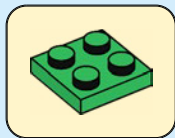



1x



1x

# 14

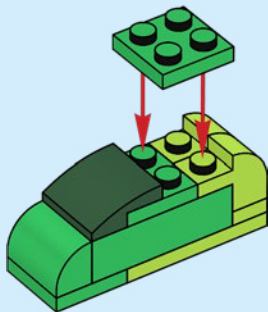

15

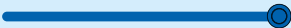
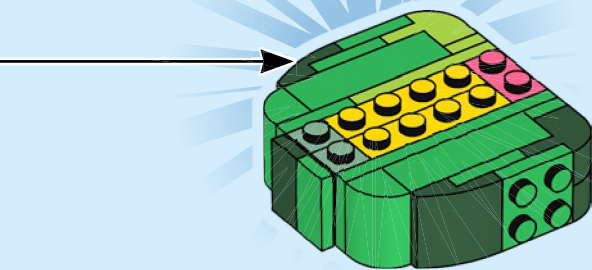



1x

16

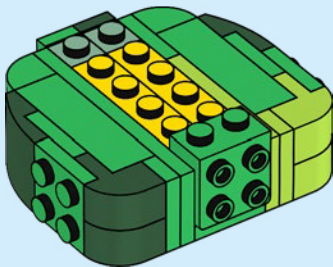



1x



1x

17

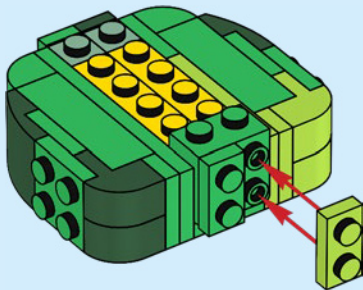







4x

# 18

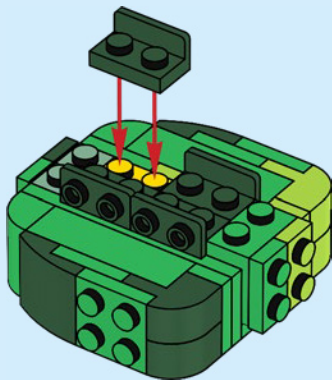



1x

19

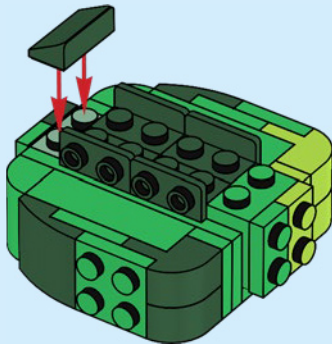

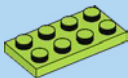

1x

20

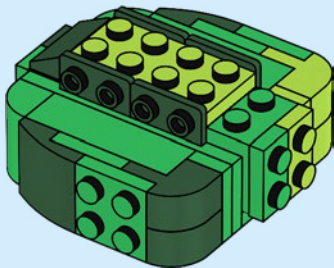



1x



2x



2x

# 21

1

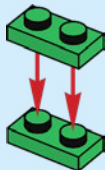

2

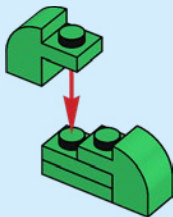

3

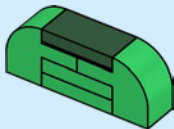

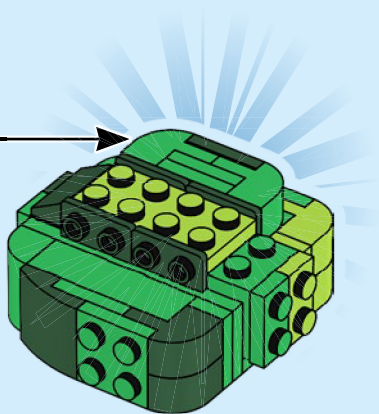



2x



2x

22

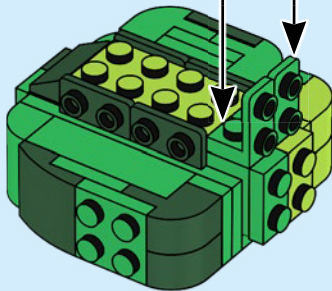

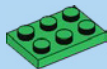

1x



1x



1x

# 23

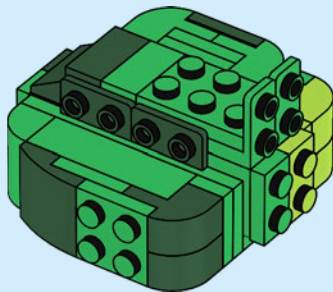





1x



1x



1x

# 24

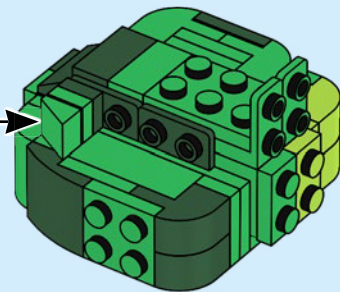
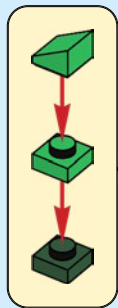



1x



2x



1x



1x

# 25

1

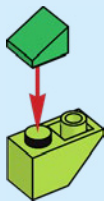

2

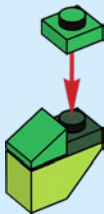

3

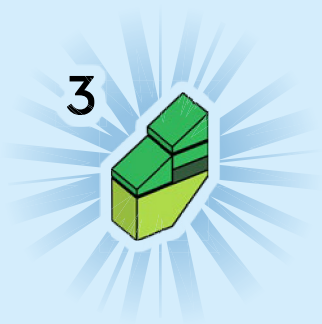

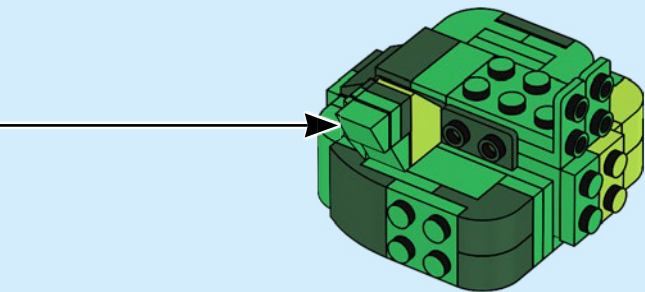



2x



1x



1x

# 26

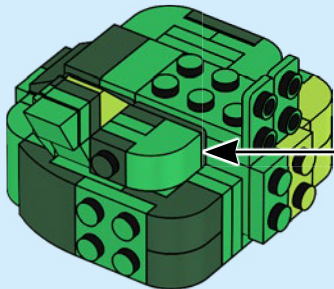



1x



1x



1x

# 27

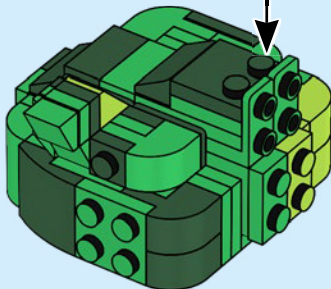
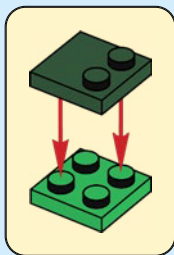



1x



1x

# 28

1



2

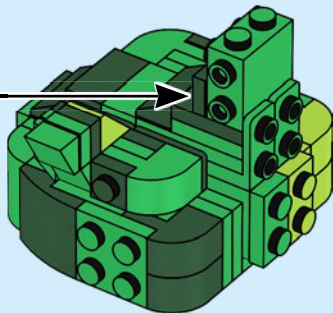



2x

29



2x

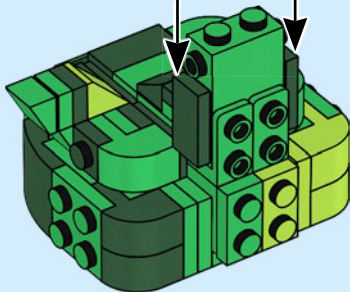



1x

30

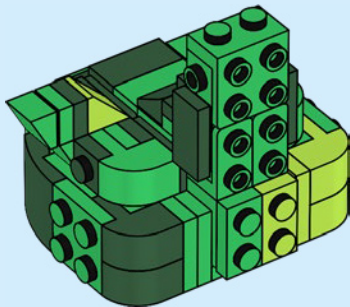



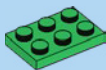

1x

31

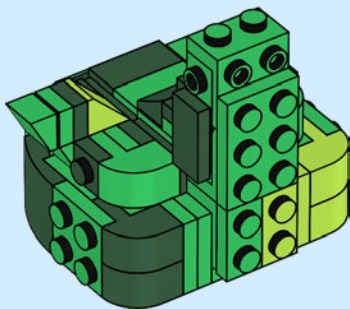

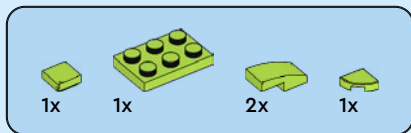

32

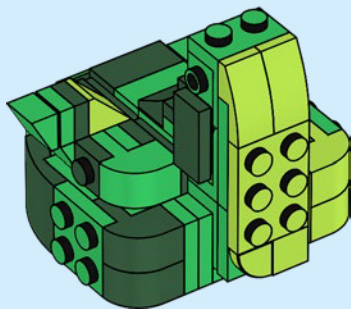





1x



2x

# 33



2

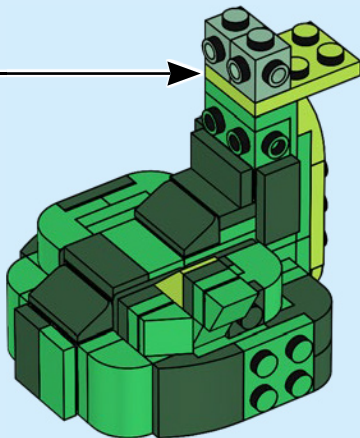
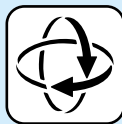
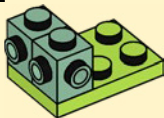
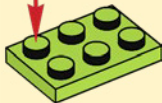



2x



2x

34

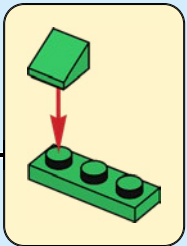
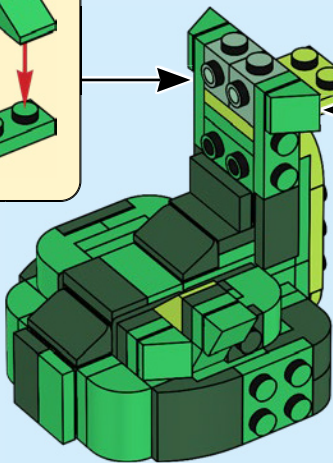
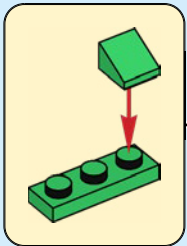



1x



1x

# 35

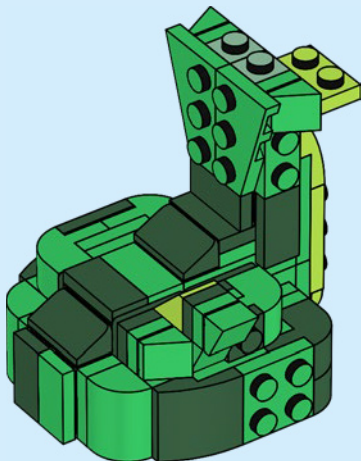



1x



1x

# 36

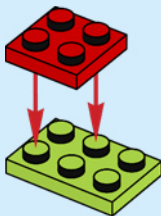



2x

37

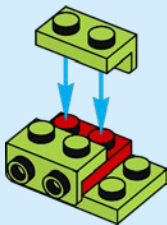





2x



2x



2x

# 38



2

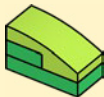

2x

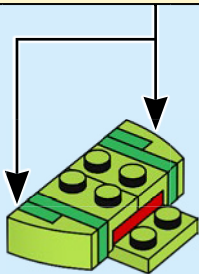



2x



2x

# 39

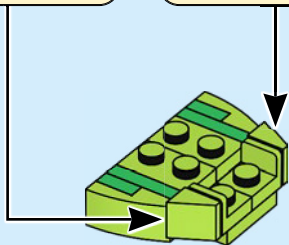
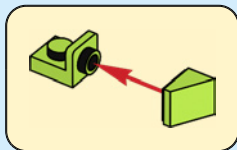
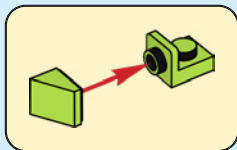



2x

40

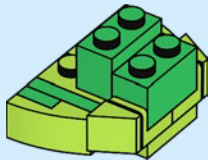



1x

41

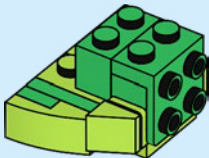



1x



1x

# 42

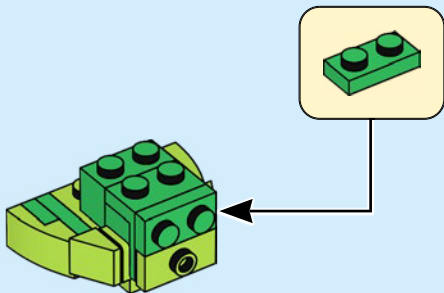

43

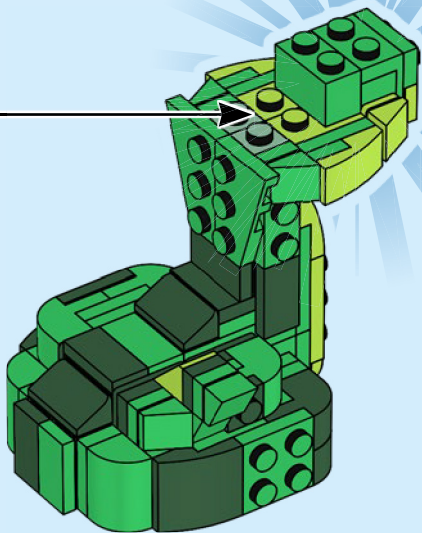



1x



1x

# 44

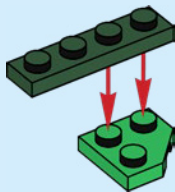



1x

45

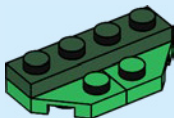





2x

46

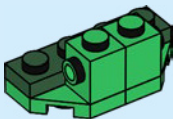



2x

47



2x

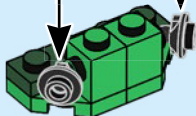



2x



1x

48

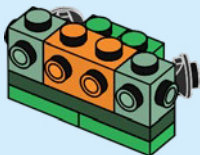
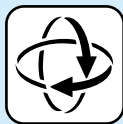



1x



1x

49

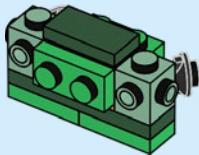

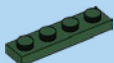

1x



2x

# 50

1

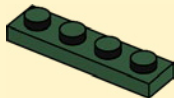

2

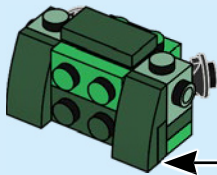
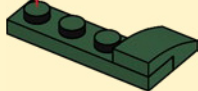

51

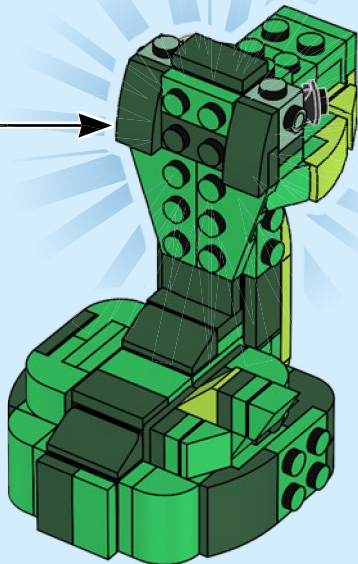



1x



1x



1x

# 52

1

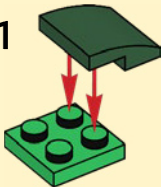

2

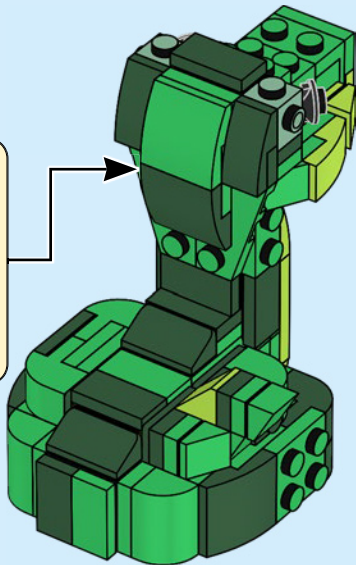



2x

53



2x

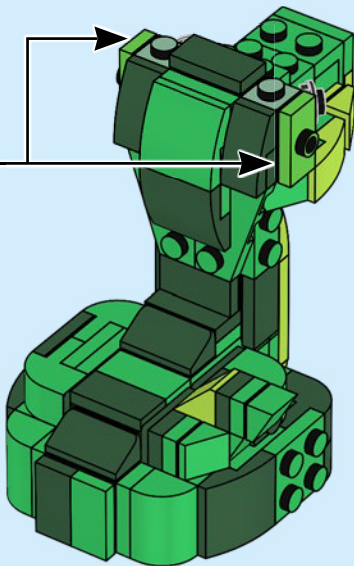





2x



1x



1x

# 54

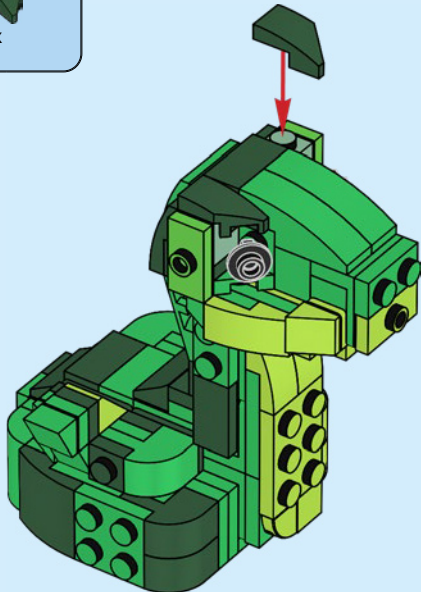



2x

55

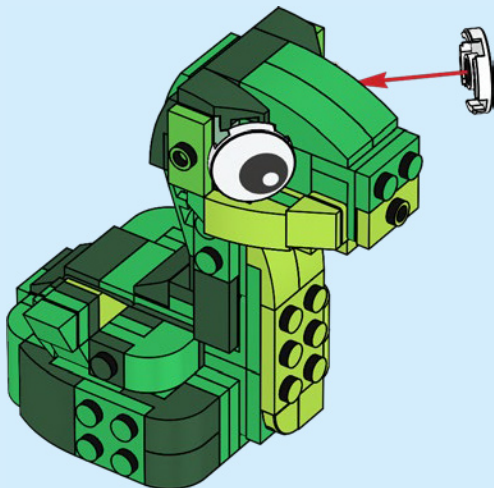



1x

56

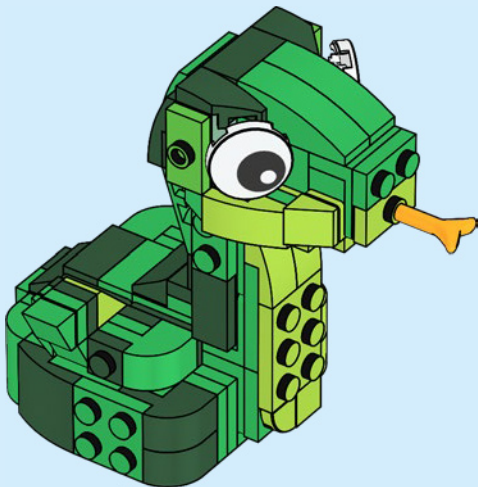



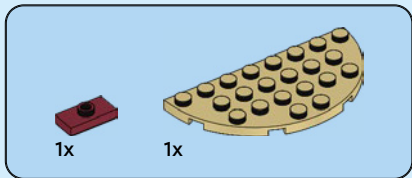
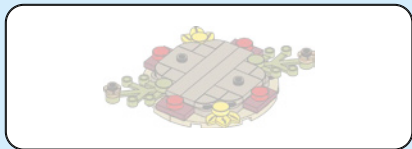

57

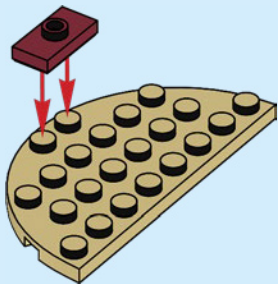



2x

58

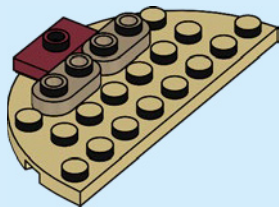



2x

# 59

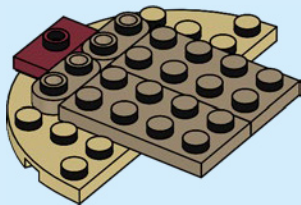

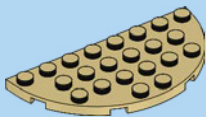

1x

60

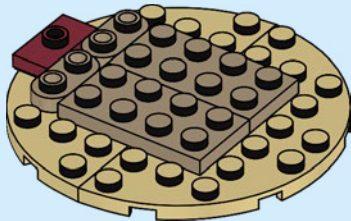





2x



2x

# 61

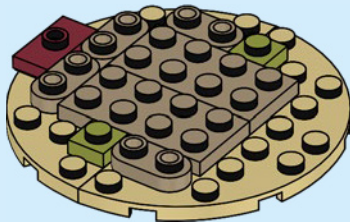



2x

62

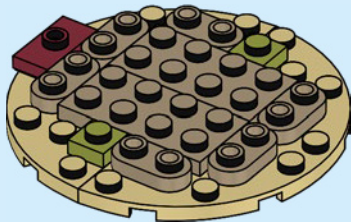



3x

63

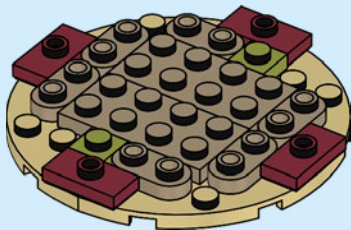



4x

64

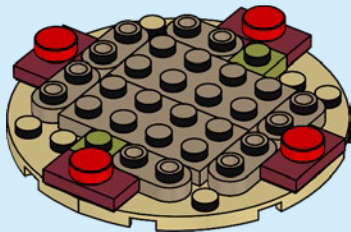

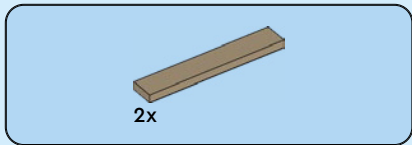

65

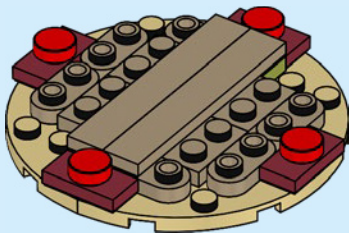



2x

66

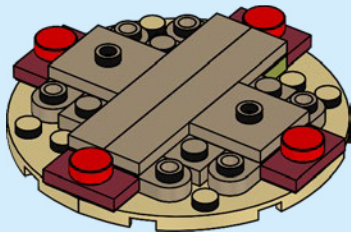



4x

67

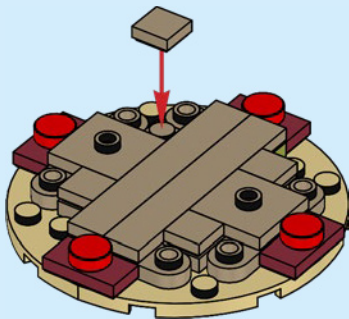



6x

68

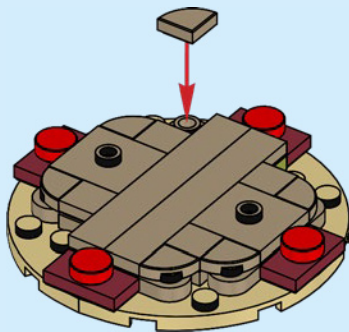





2x



2x

69



2x

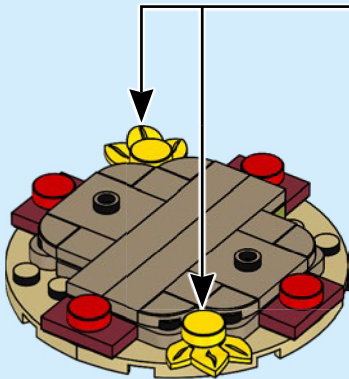



2x



2x



2x

# 70

1

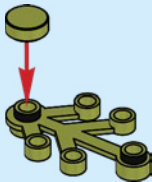

2



# 2x

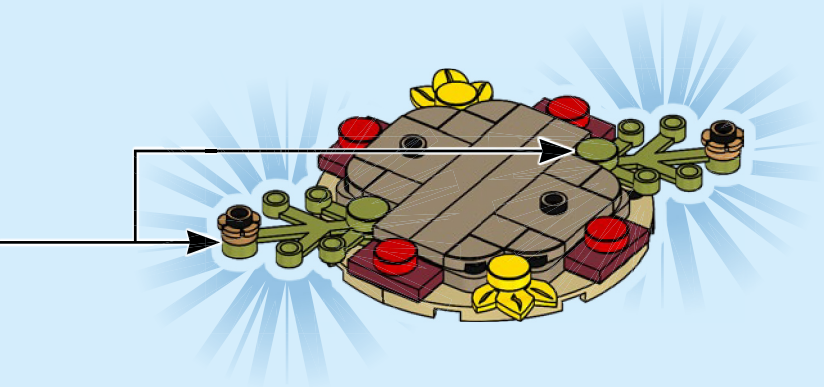

71

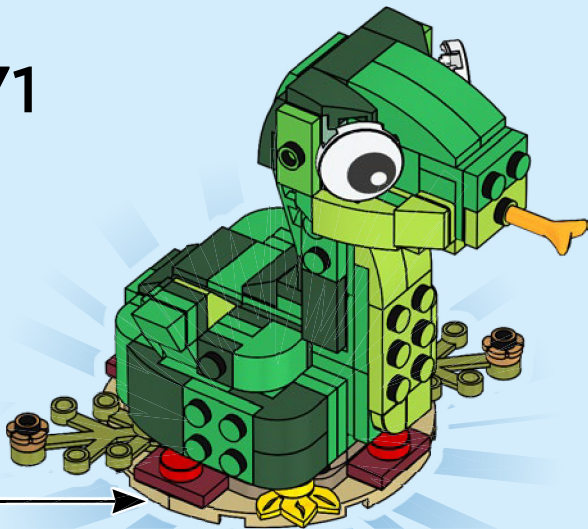

80





2x  
6060734



2x  
6123812



4x  
6284574



1x  
302221



2x  
6284577



2x  
6286830



2x  
4164073



2x  
6510193



1x  
6223454



2x  
6385644



5x  
302428



2x  
6462580



1x  
4621946



1x  
4621947



2x  
6270719



8x  
302328



2x  
6311453



2x  
4107736



3x  
6374489



3x  
6117971



2x  
4107758



2x  
306928



5x  
4546705



1x  
6451739



7x  
302228



1x  
6116259



2x  
6039946



2x  
302128



2x  
4106356

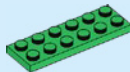

2x  
379528



2x  
6314378



1x  
6096682



2x  
6209691

1x  
6211875



2x  
6411328



4x  
6069006



1x  
6030276



2x  
6310279



1x  
4537251



2x  
4504372



3x  
6013530



2x  
4537936

2x  
6365620



2x  
4164037



1x  
6092592



4x  
6055172



6x  
6362967



6x  
6231386



2x  
6126075



2x  
4267874



2x  
4507047

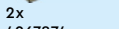

2x  
6055225



2x  
6411352



4x  
6254478



3x  
6101285



1x  
6484031



2x  
6020923



4x  
6055169



1x  
6214813



1x  
6214814



2x  
6168574



7x  
6326011



2x  
4619513



2x  
6284595



2x  
6058245



2x  
6268815



1x  
6258572



6x  
6223225



4x  
6092597



YOU COULD **WIN**



Scan this QR code or go to  
**LEGO.COM/PRODUCTFEEDBACK** and give us  
your short feedback about this LEGO® set for  
a chance to win a cool LEGO prize.

Terms and Conditions apply\*



**EN: YOU COULD WIN.** Terms and Conditions apply\* **DE: Du könntest GEWINNEN.** Es gelten die Teilnahmebedingungen\* **FR: Tu pourrais GAGNER.** Des conditions s'appliquent\* **IT: Potresti VINCERE tu.** Termini e condizioni sono applicabili\* **ES: Puedes GANAR.** Aplican términos y condiciones\* **PT: Poderá GANHAR.** Aplicam-se termos e condições\* **ZH: 轻松获奖.** 条款和条件适用\* **PL: Szansa na WYGRANĄ.** Obowiązują warunki korzystania\* **CS: Máte šanci VYHRÁT.** Platí všeobecné smluvní podmínky\* **SK: Máte šancu VYHRÁŤ.** Platia všeobecné zmluvné podmienky\* **HU: TE IS NYERHETSZ.** Felhasználási feltételek érvényesek\* **RO: Ai putea CÂȘTIGA.** Se aplică termeni și condiții\* **BG: Можете да СПЕЧЕЛИТЕ.** Има определени правила и условия\* **LV: Tu vari LAIMĒT.** Ir spēkā noteikumi un nosacījumi.\* **ET: Sul on võimalus VÕITA.** Kehtivad tingimused\* **LT: Jūs galite LAIMĖTI.** Taikomos sąlygos\*

\*[LEGO.com/productfeedback-terms](https://lego.com/productfeedback-terms)

LEGO and the LEGO logo are trademarks of the/sont des marques de commerce du/  
son marcas registradas de LEGO Group. ©2024 The LEGO Group.

6536629