



40698



Booklet available in English
Livret disponible en français
Folleto disponible en español

[LEGO.com/service/buildinginstructions](https://www.LEGO.com/service/buildinginstructions)



WE'RE MAKING OUR PACKAGING MORE SUSTAINABLE

We're transitioning from single-use plastic to paper-based packaging. As we progress, you may find a mix of paper and plastic in our boxes.

NOUS RENDONS NOS EMBALLAGES PLUS DURABLES

Nous passons des emballages en plastique à usage unique aux emballages à base de papier. Durant la transition, vous pourriez trouver un mélange de papier et de plastique dans nos boîtes.

QUEREMOS HACER MÁS SUSTENTABLES NUESTROS MATERIALES DE EMBALAJE

Estamos cambiando las bolsas de plástico desechables por bolsas con base de papel. Conforme avanzamos en este propósito, puedes encontrar una mezcla de papel y de plástico en nuestras cajas.

[LEGO.com/sustainable-packaging](https://www.lego.com/sustainable-packaging)



IDEAS¹

MEET ANNA

LEGO® Ideas Challenge Winner



Anna (LEGO® Ideas name Fr-An) won the Me, Myself and I Challenge with this beautiful reading corner.

"I love building with LEGO® bricks. It is my main hobby, next to reading. I like going to bookstores and libraries, so when I imagined a perfect day to spend by myself, it would be in a cozy place for reading. I would sit in a comfortable armchair with Earl Grey tea and a whole bookcase full of novels chosen especially for me. And I would read and read and read.

"When I returned to building with LEGO bricks as an adult and I discovered the LEGO Ideas platform, I always imagined it would be amazing to have an idea transformed into an official LEGO set. Winning the challenge was a dream come true. Thanks to everyone who voted! I hope you enjoy building!"

RENCONTREZ ANNA

Gagnante du défi LEGO® Ideas

Anna (pseudonyme LEGO® Ideas : Fr-An) a remporté le défi « Me, Myself and I » avec ce magnifique coin lecture.

« J'adore construire avec des briques LEGO®. C'est mon passe-temps principal, après la lecture. J'aime aller dans les librairies et les bibliothèques, alors quand j'imagine une journée parfaite à passer seule, ce serait dans un endroit confortable pour lire. Je m'installerais dans un fauteuil confortable avec du thé Earl Grey et une bibliothèque entière remplie de romans choisis spécialement pour moi. Et je lirais pendant des heures.

Lorsque j'ai recommencé à construire avec des briques LEGO à l'âge adulte et que j'ai découvert la plateforme LEGO Ideas, j'ai imaginé qu'il serait extraordinaire de voir mon idée devenir un ensemble LEGO officiel. Remporter le défi était un rêve devenu réalité. Merci à tous ceux qui ont voté ! J'espère que vous apprécierez la construction ! »

CONOCE A ANNA

Ganadora del desafío LEGO® Ideas

Anna (apodada Fr-An en LEGO® Ideas) ganó el desafío Me, Myself and I con este bonito rincón de lectura.

“Me encanta construir con bricks LEGO®. Es mi principal pasatiempo, además de la lectura. Me gusta ir a las librerías y visitar bibliotecas, así que, cuando imaginé cómo sería un día perfecto para pasarlo sola, se me ocurrió un lugar acogedor para leer. Me sentaría en un confortable sillón con un té earl grey y un librero lleno de novelas elegidas especialmente para mí. Y allí leería, leería, leería.

Quando volví a construir con bricks LEGO siendo adulta y descubrí la plataforma LEGO Ideas, siempre imaginé que sería increíble ver una idea transformada en un set LEGO oficial. Ganar el desafío fue un sueño hecho realidad. ¡Gracias a todos los que votaron! Espero que disfruten construyendo”.

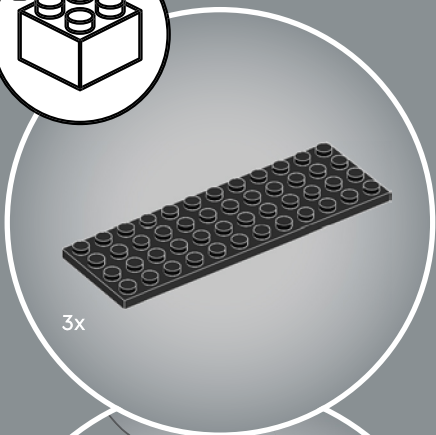
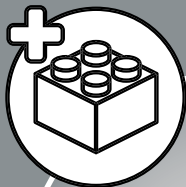

3x



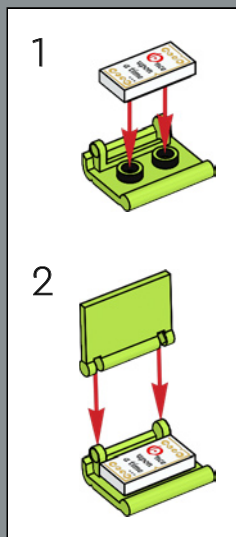

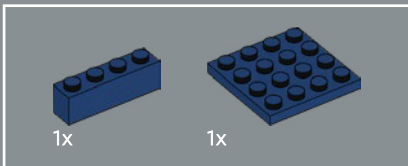
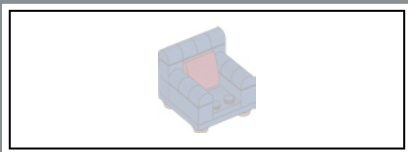

1

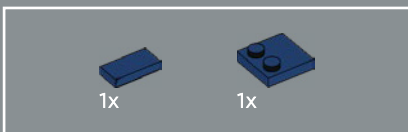
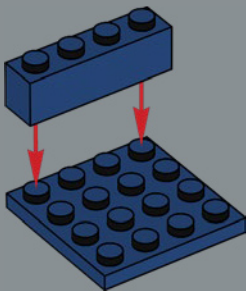

2

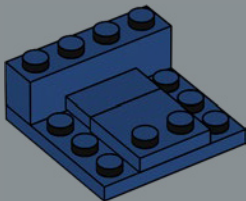

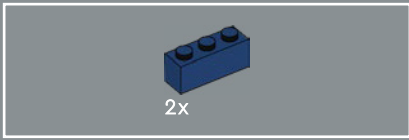

3

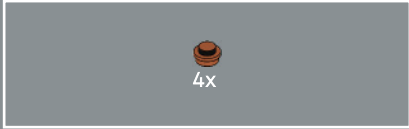
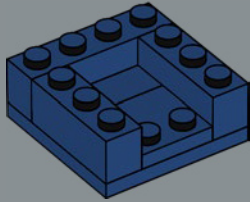

4

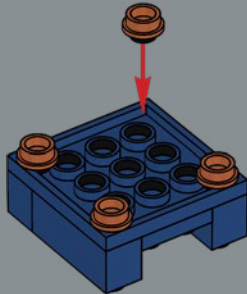

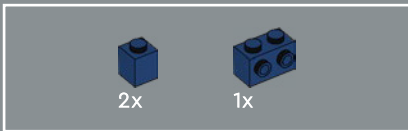

5

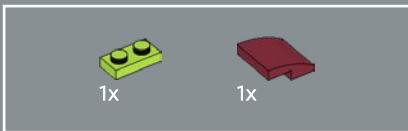
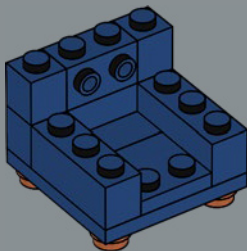

6

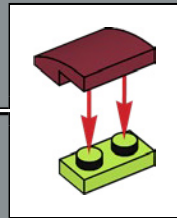
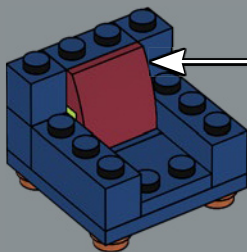



10x

7

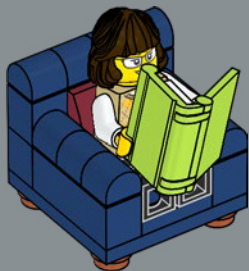
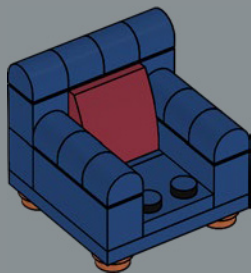

10



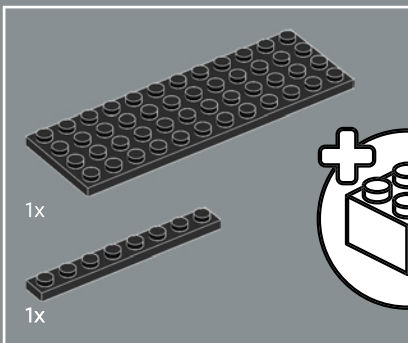

1

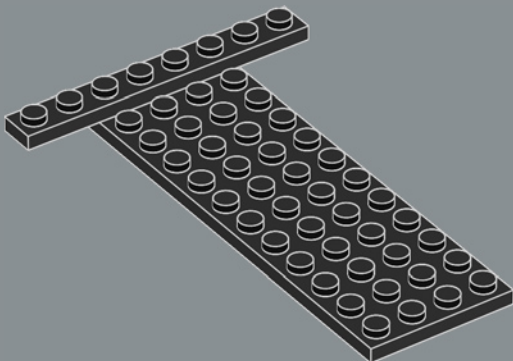

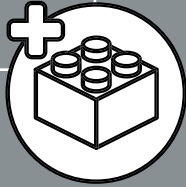
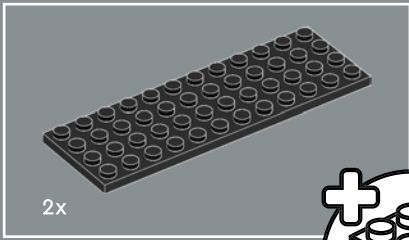

2

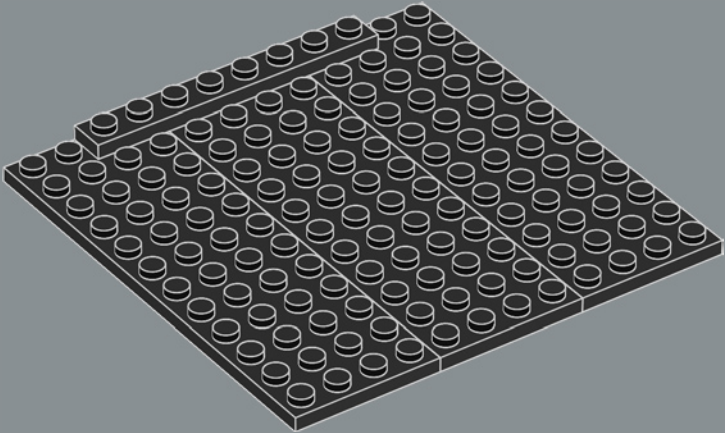

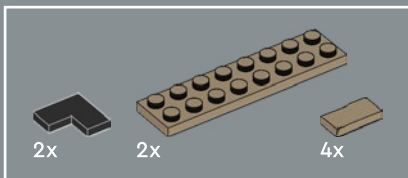

3

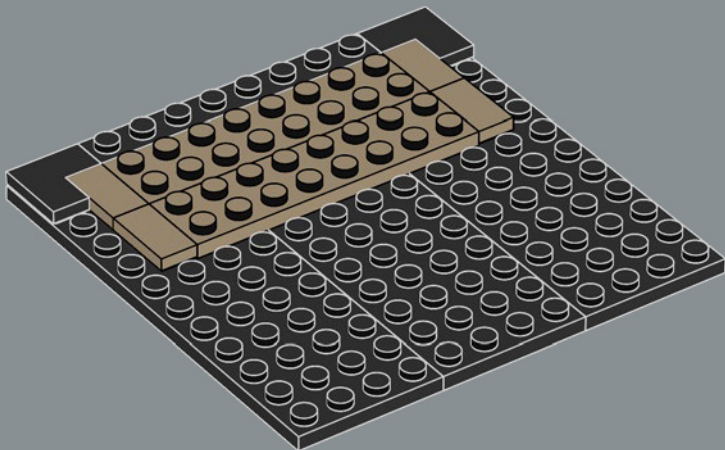

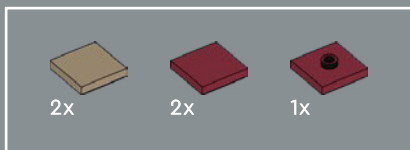

4

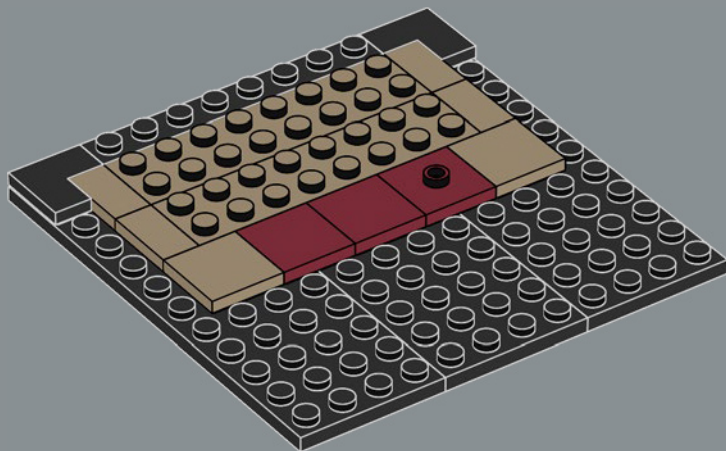

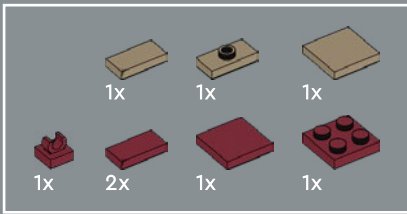

5

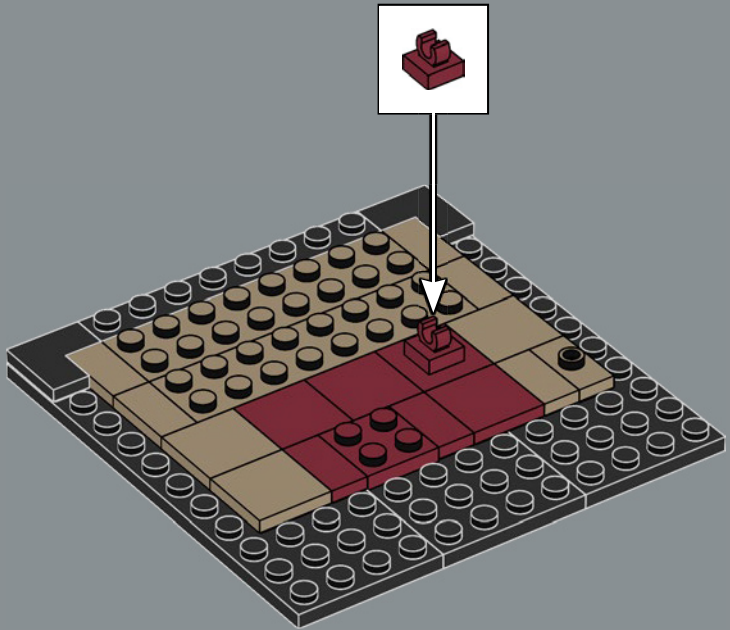

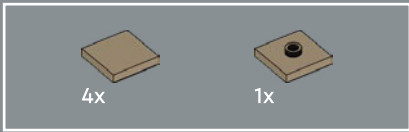

6

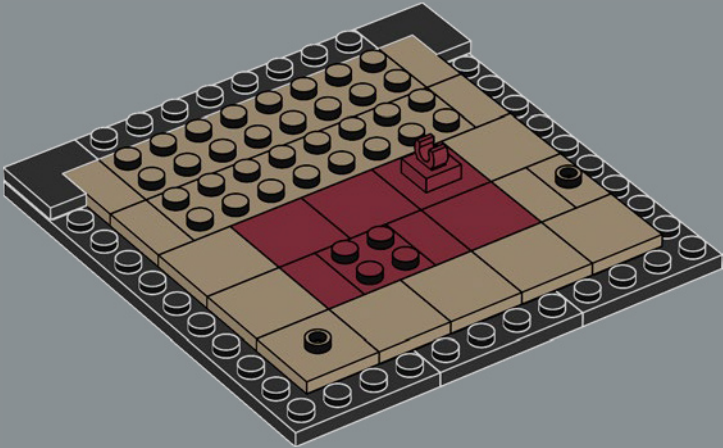

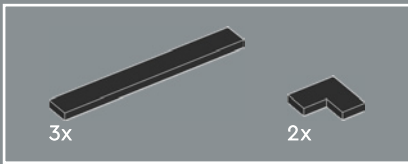

7

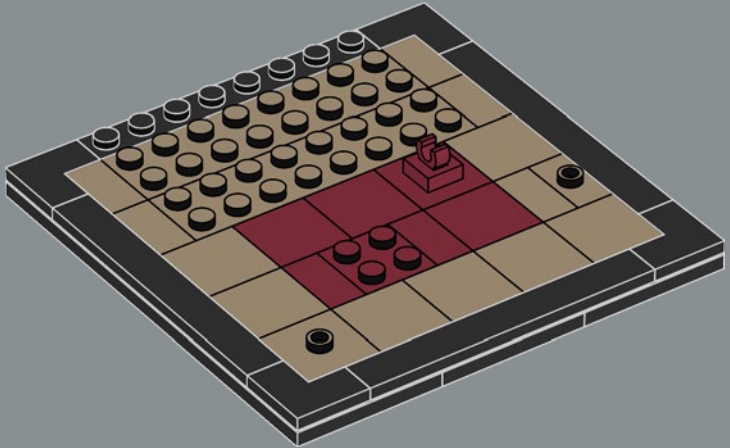

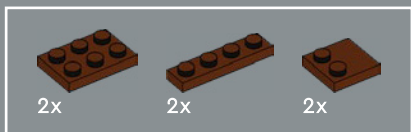

8

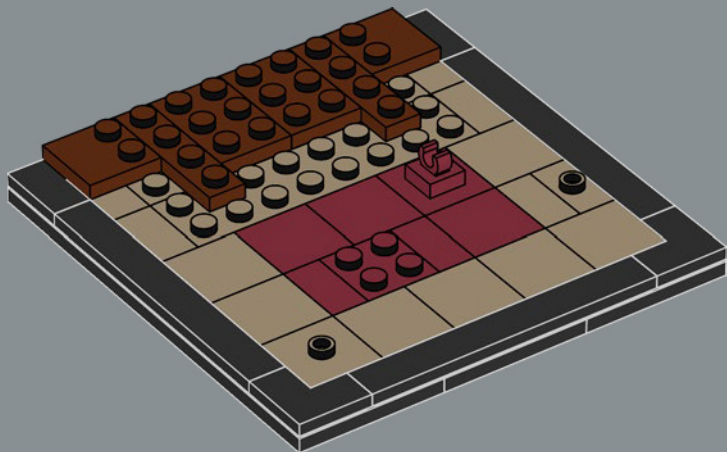

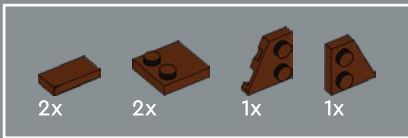

9

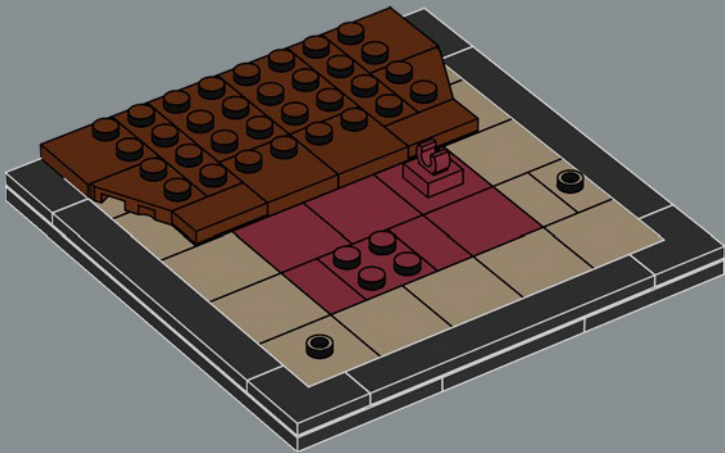

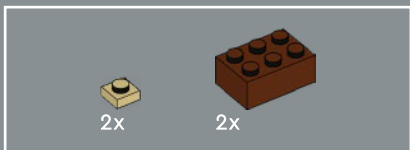

10

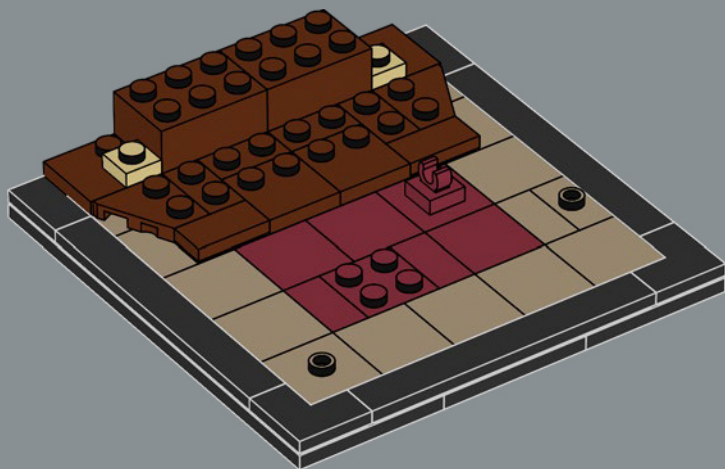



2x



2x

12

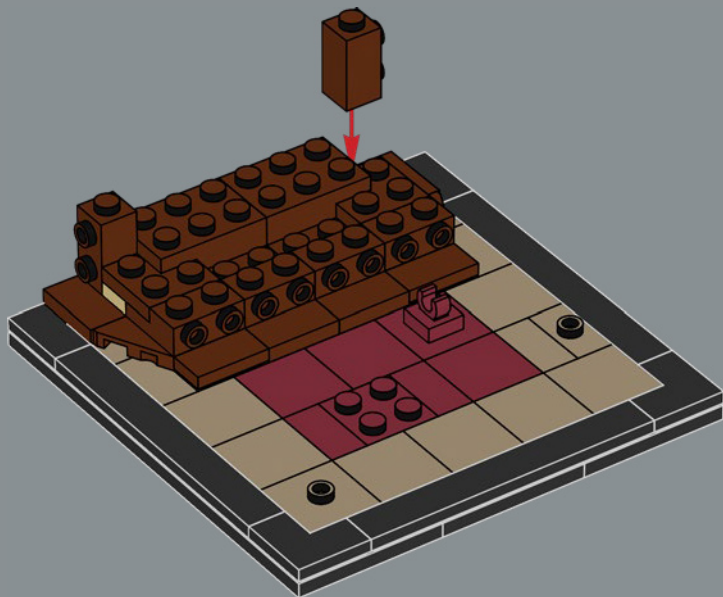

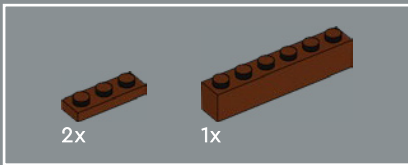

13

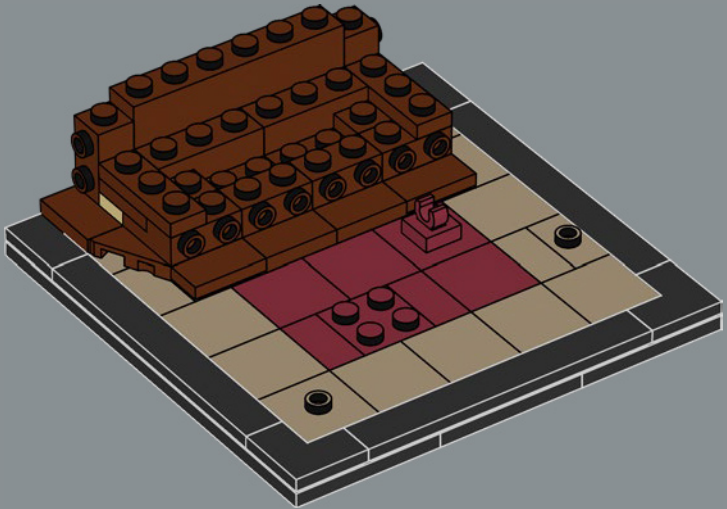



14

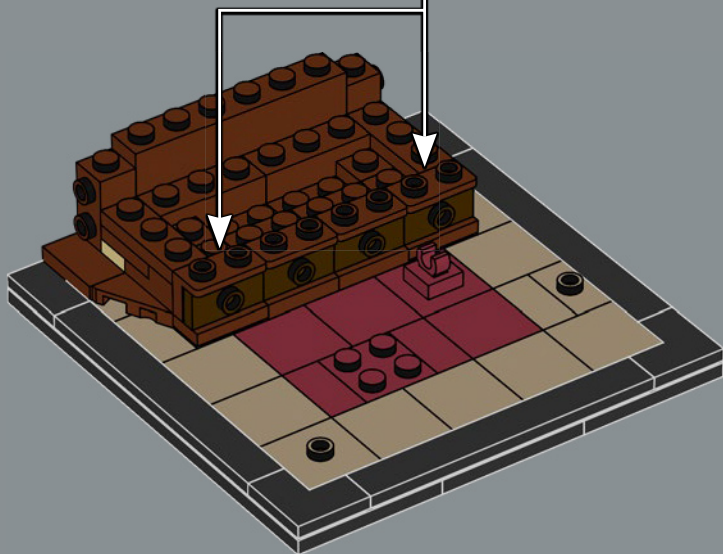
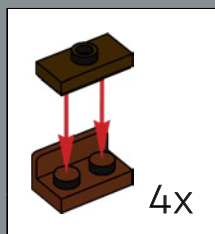

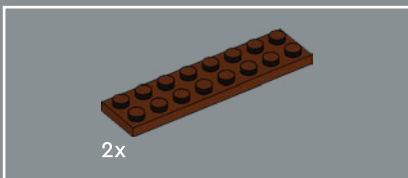

15

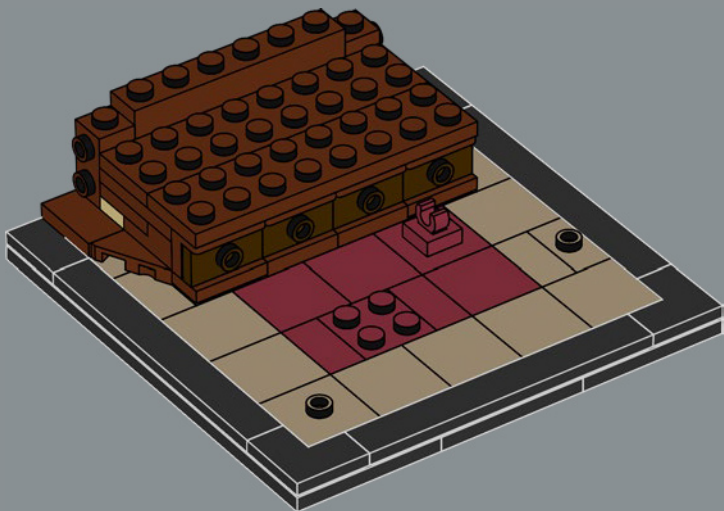

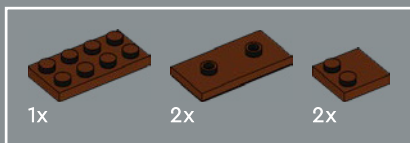

16

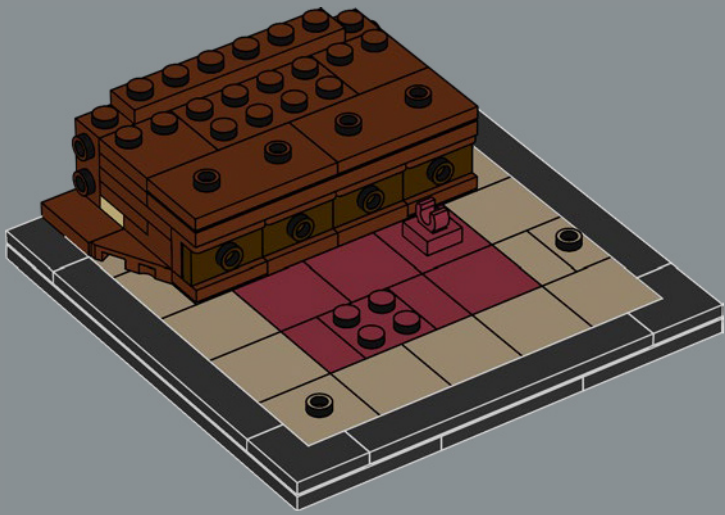

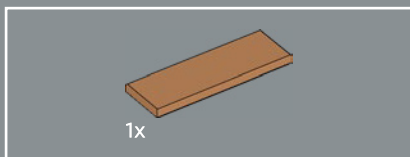

17

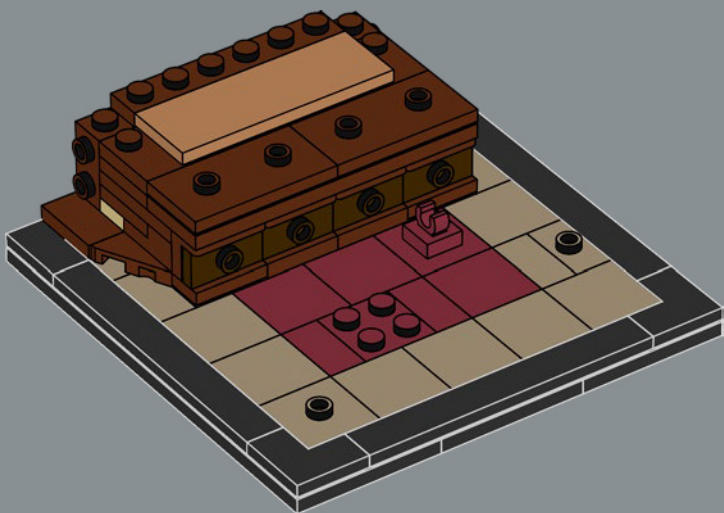



18

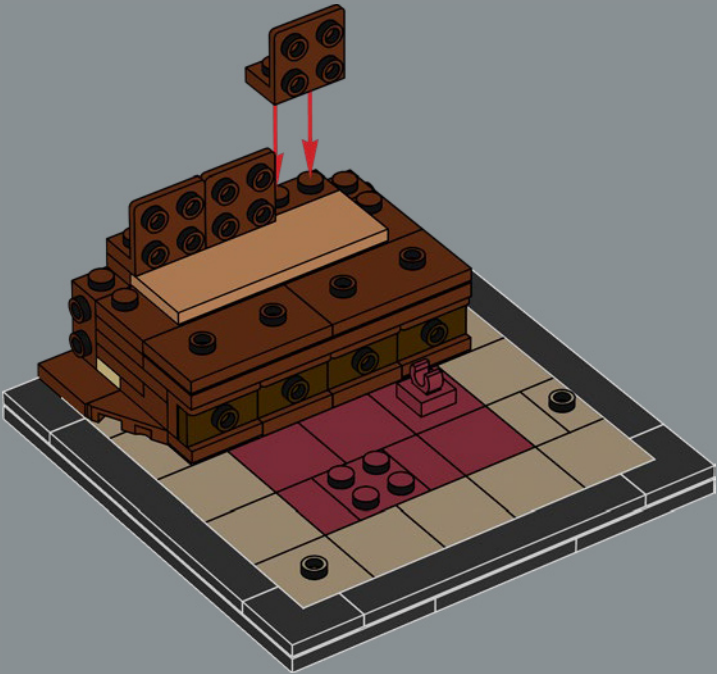

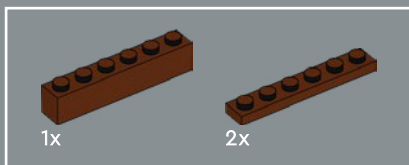

19

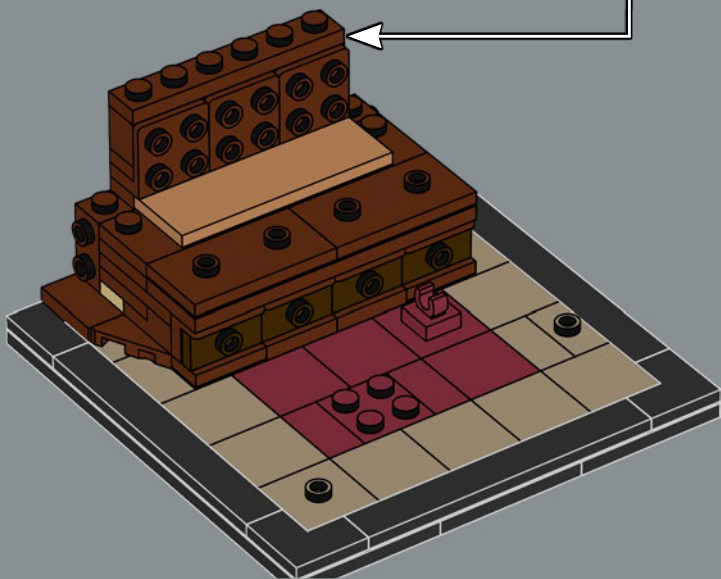
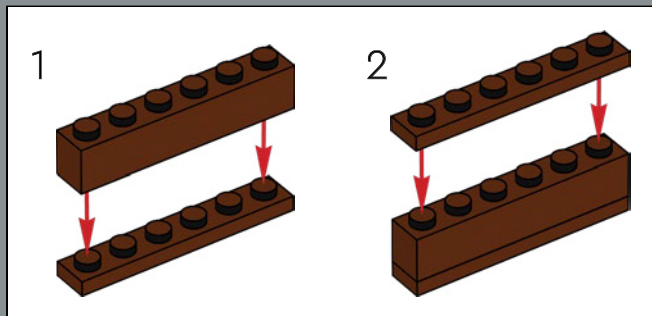

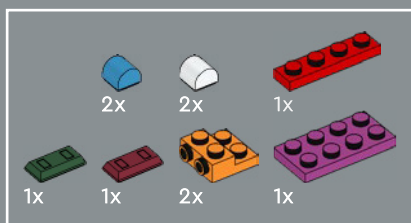

20

1

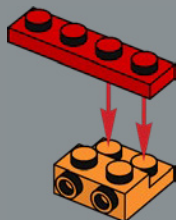

2

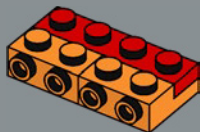

3

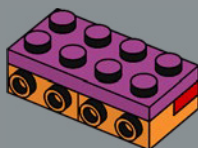

4

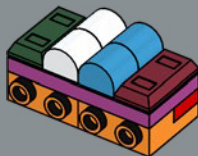

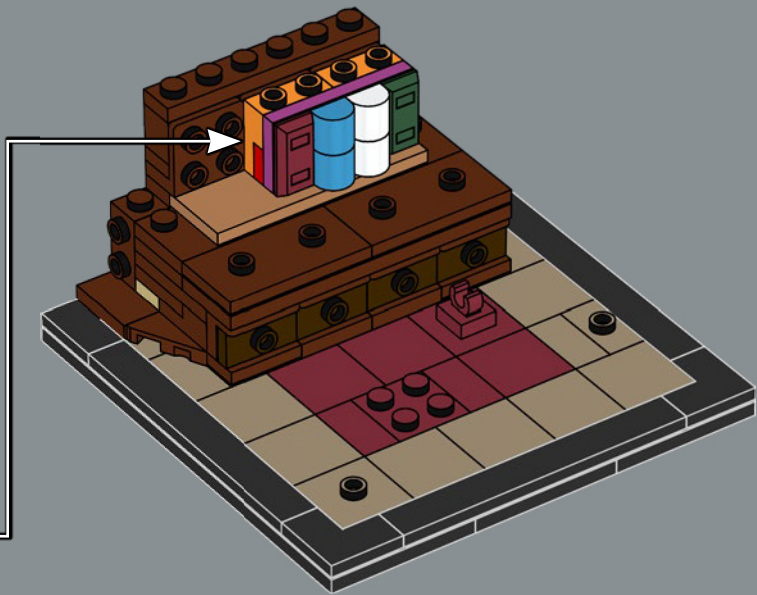

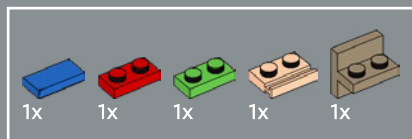

21

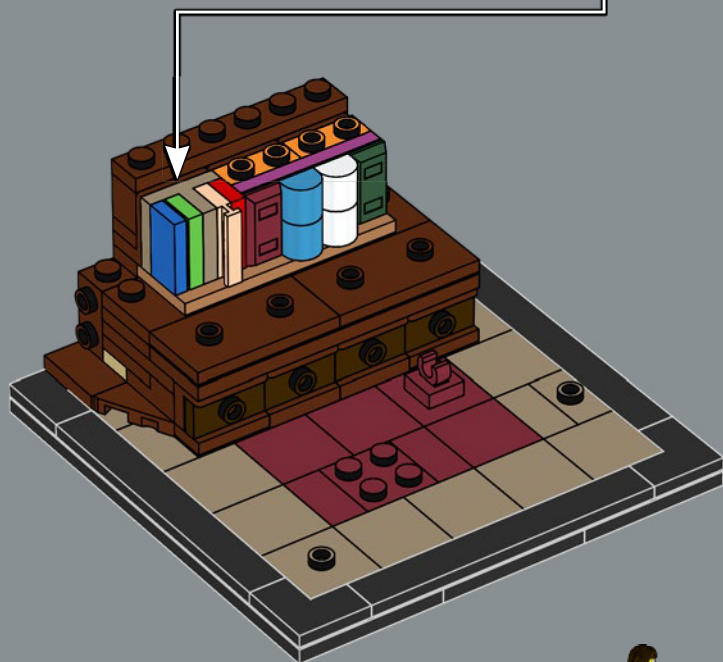
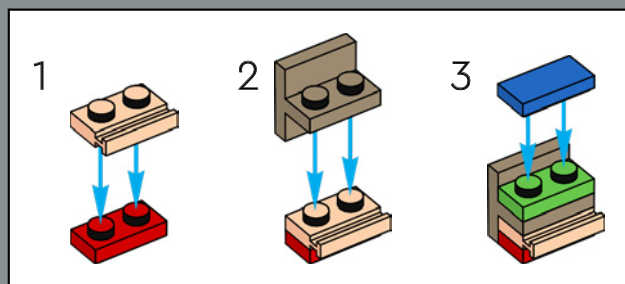

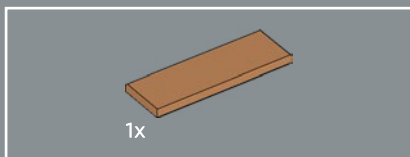

22

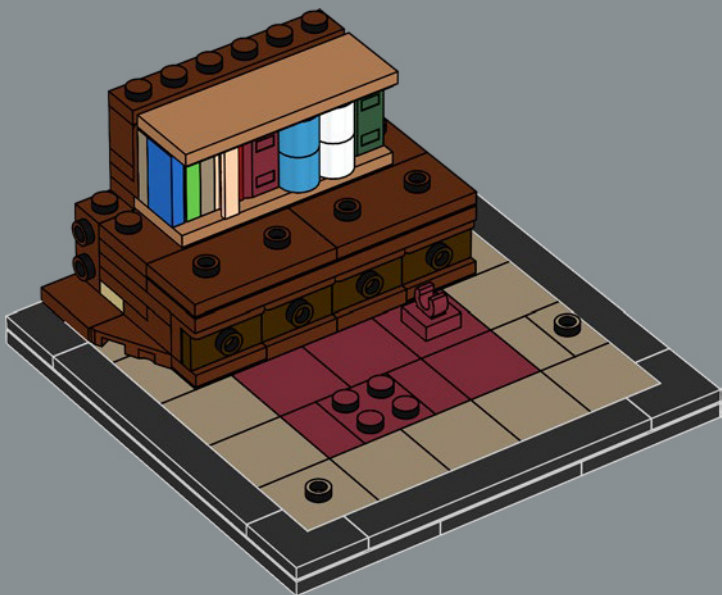

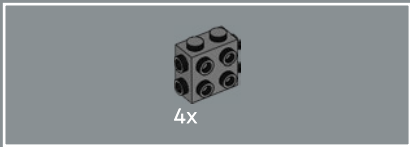

23

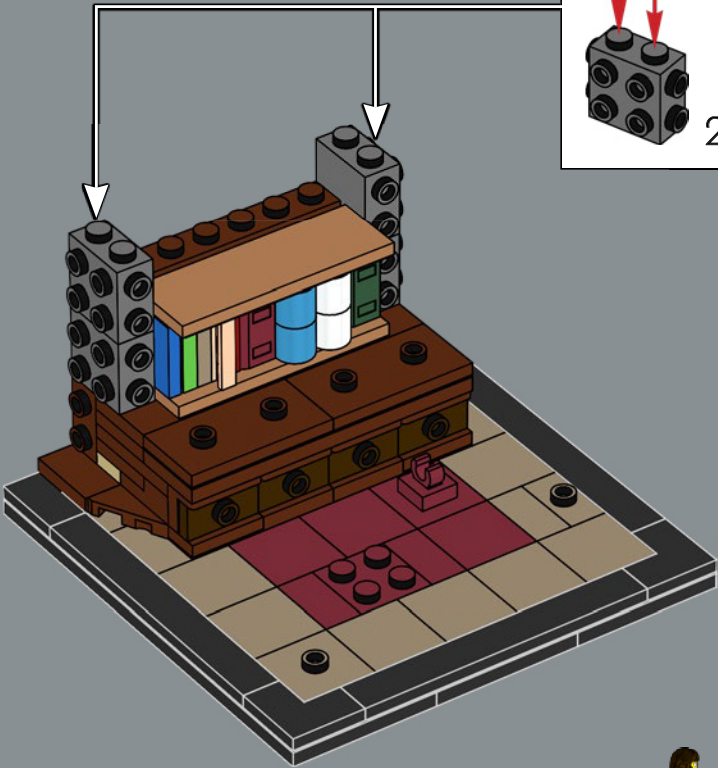
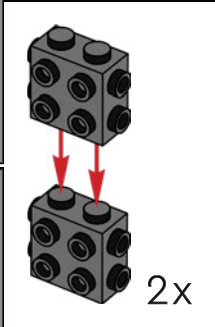

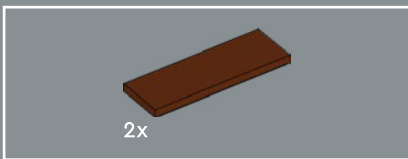

24

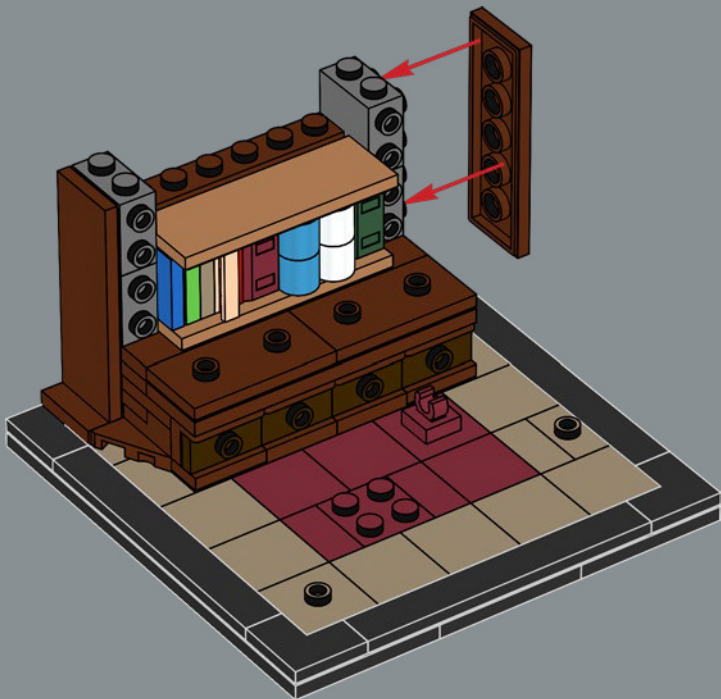

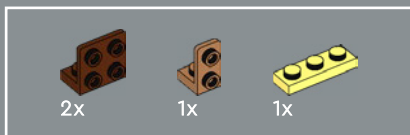

25

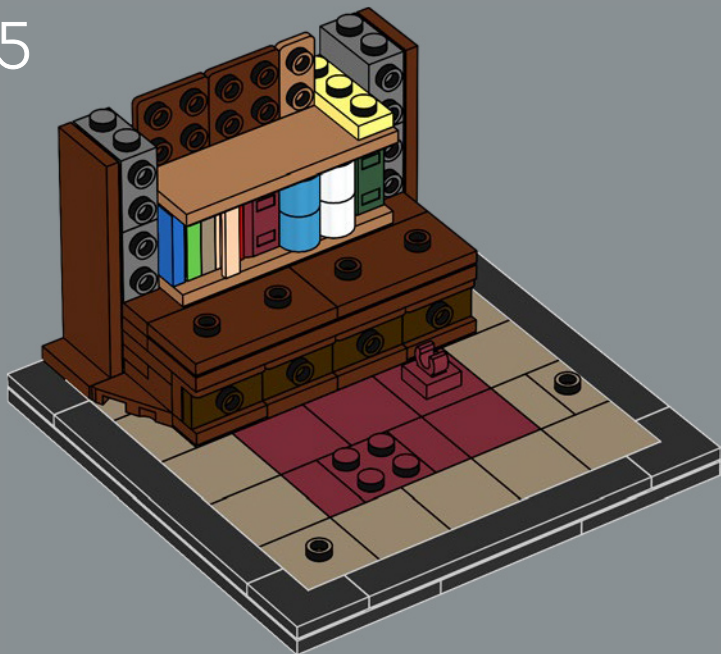

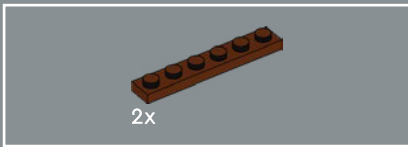

26

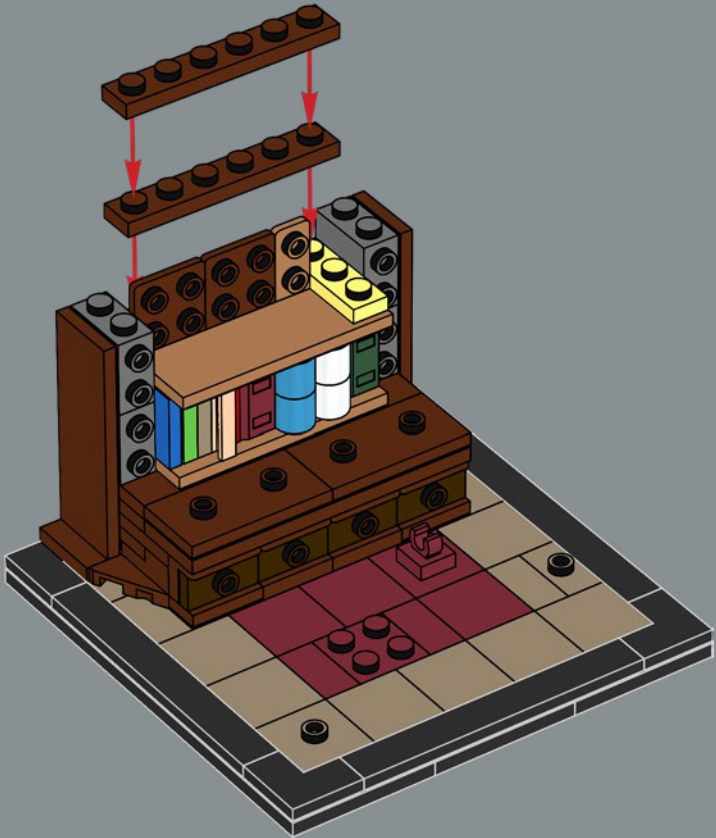



2x



2x

27

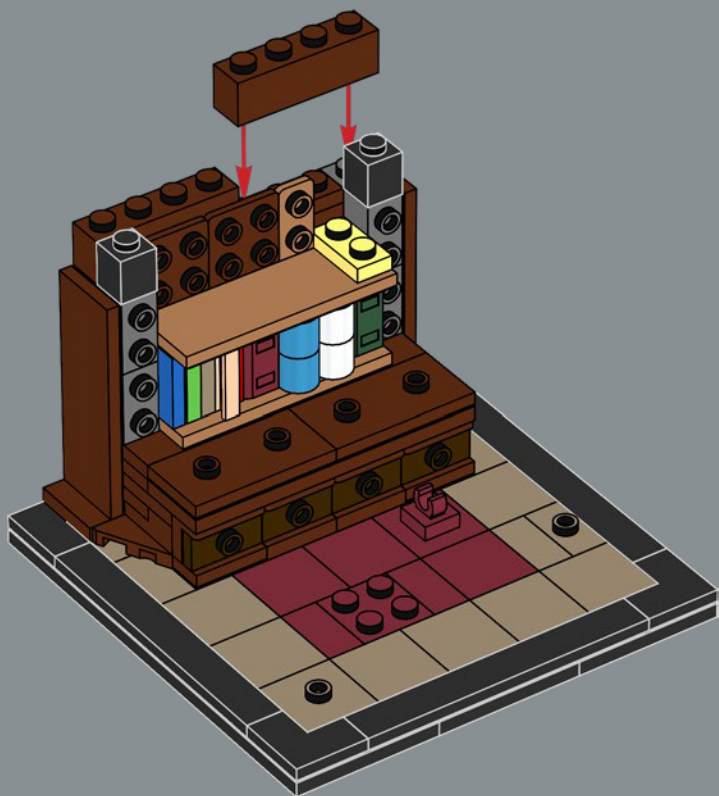

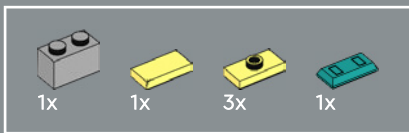

28

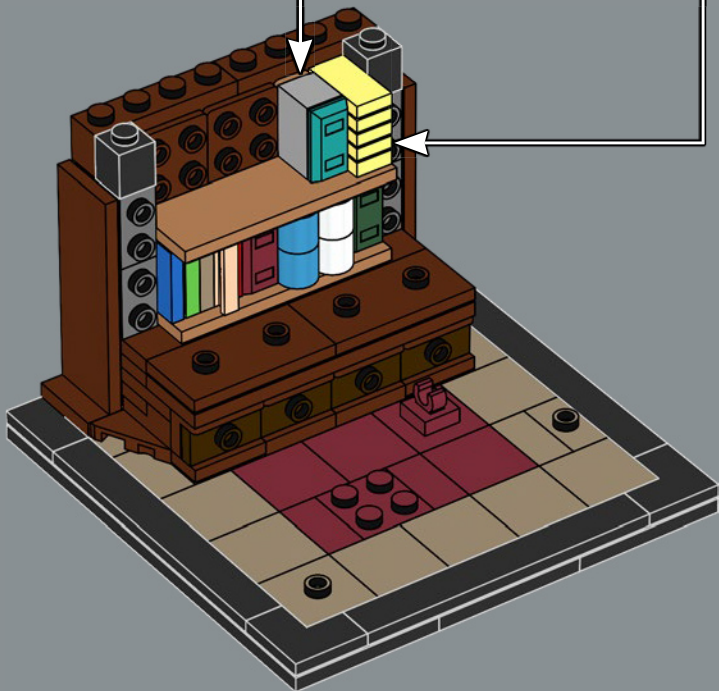
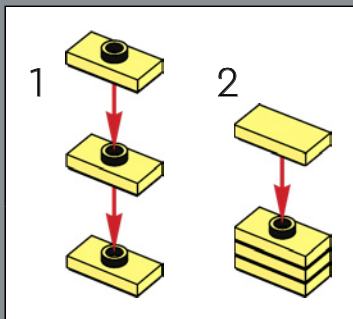
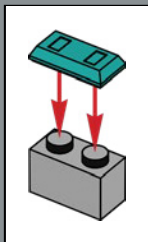

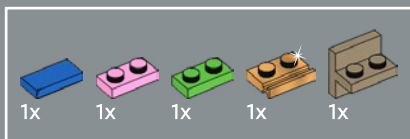

29

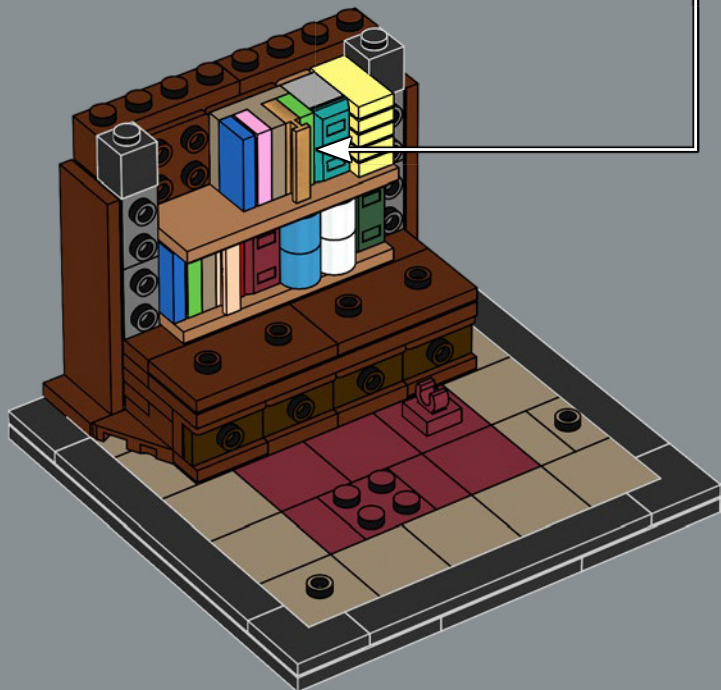
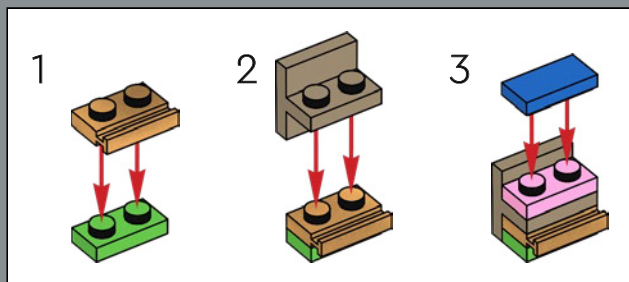

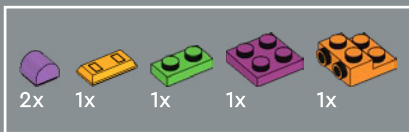

30

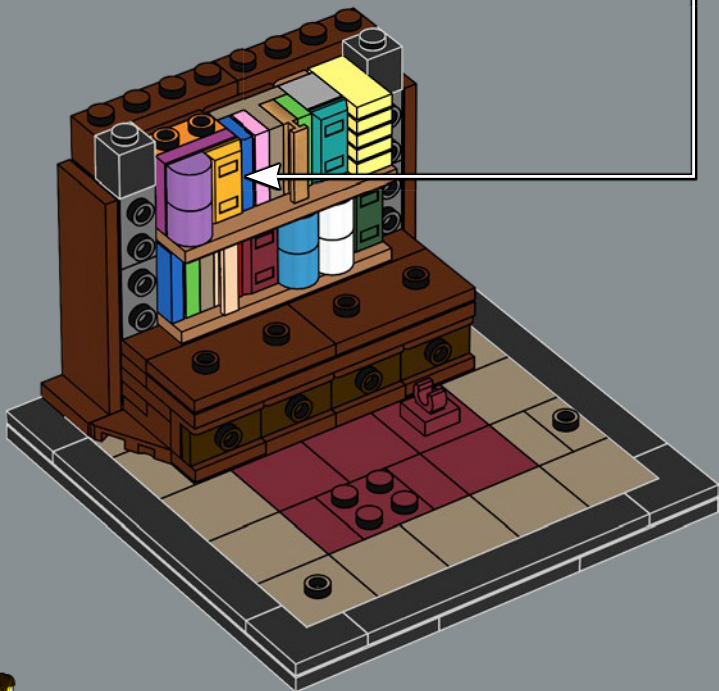
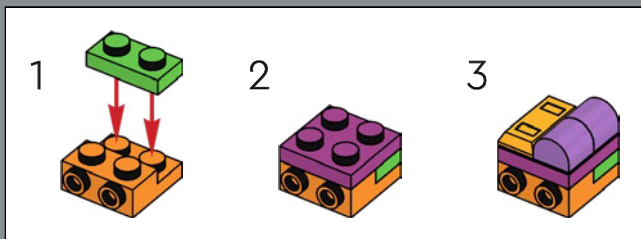

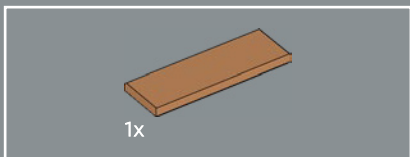

31

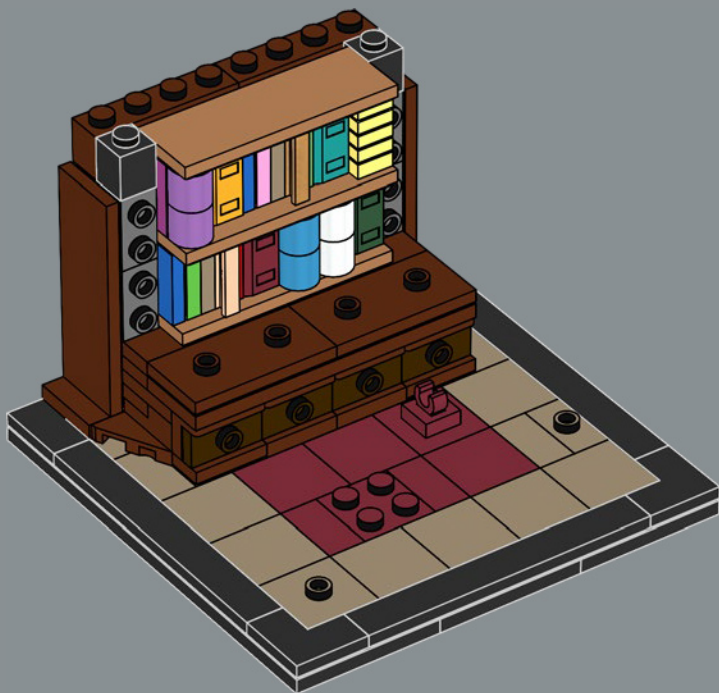

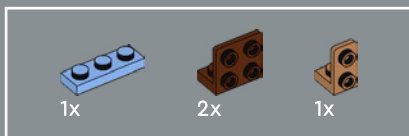

32

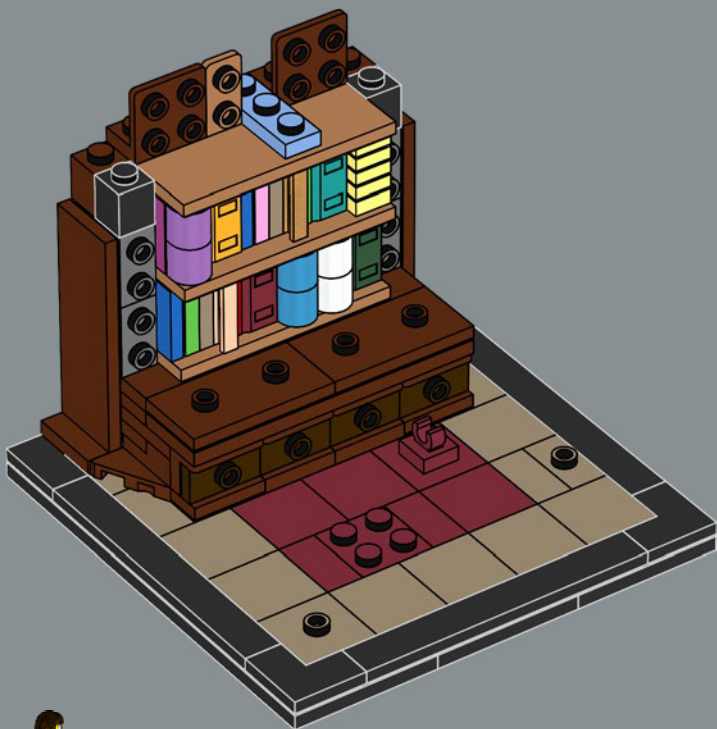

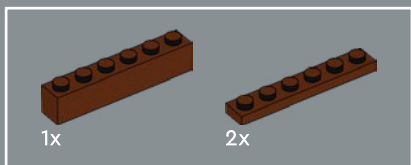

33

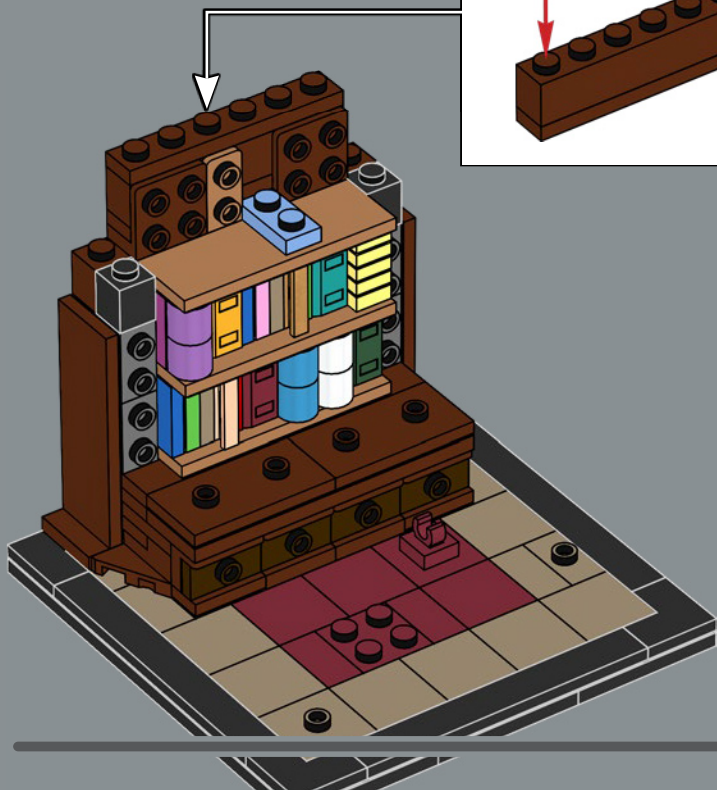
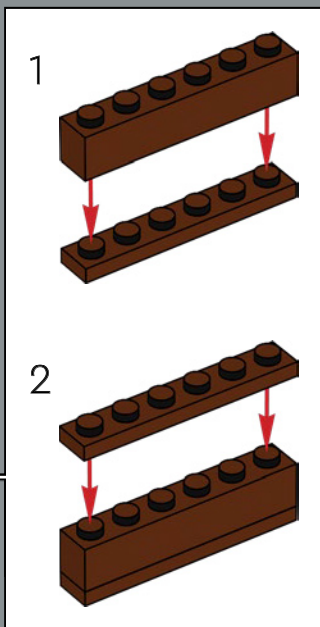

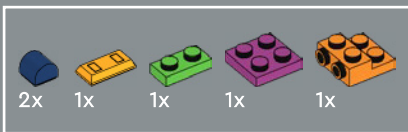

34

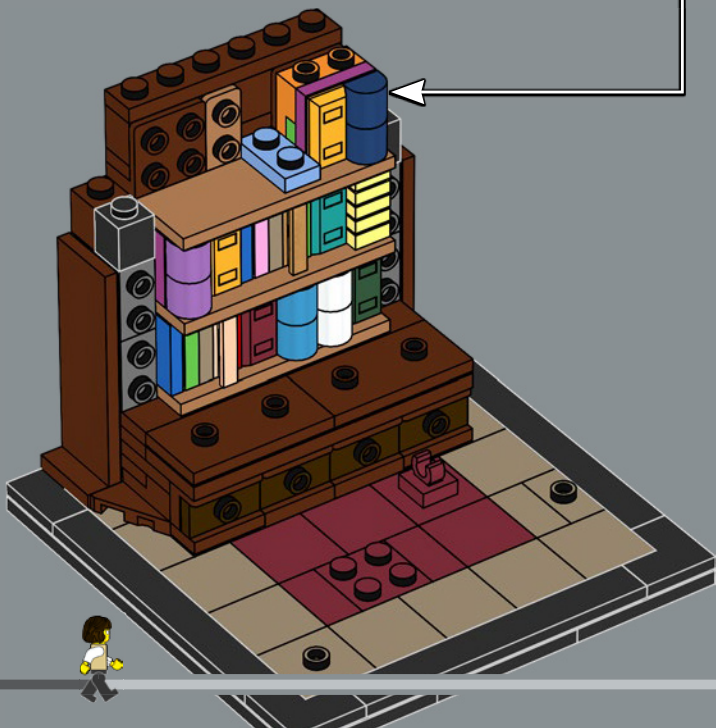
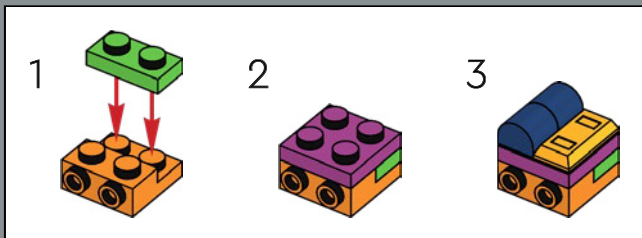

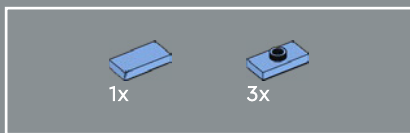

35

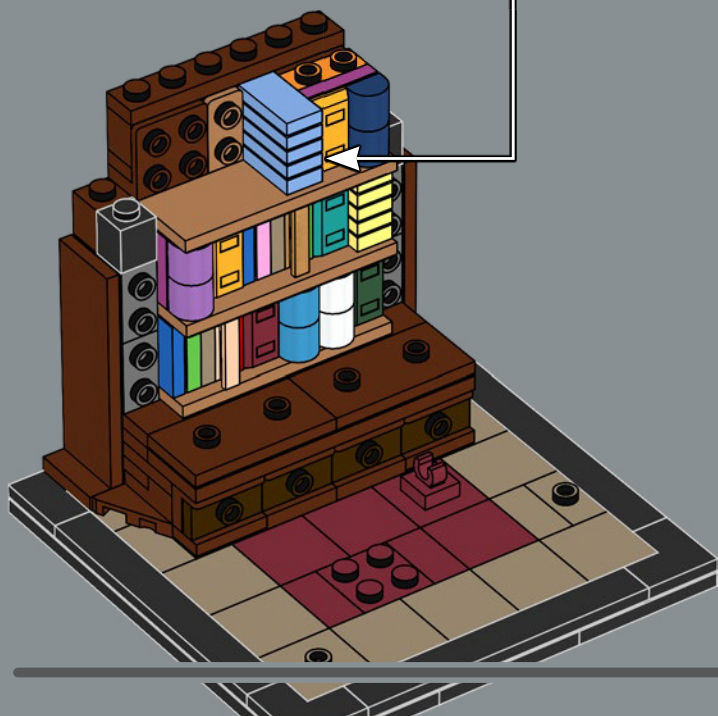
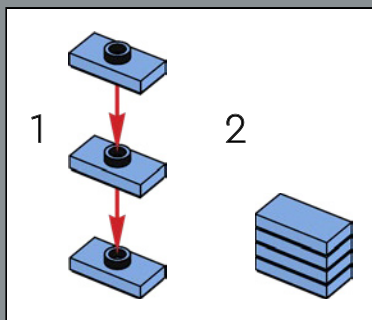

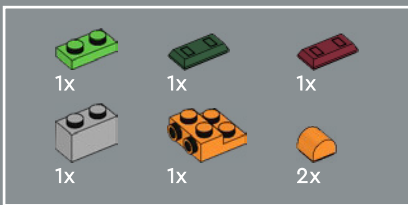

36

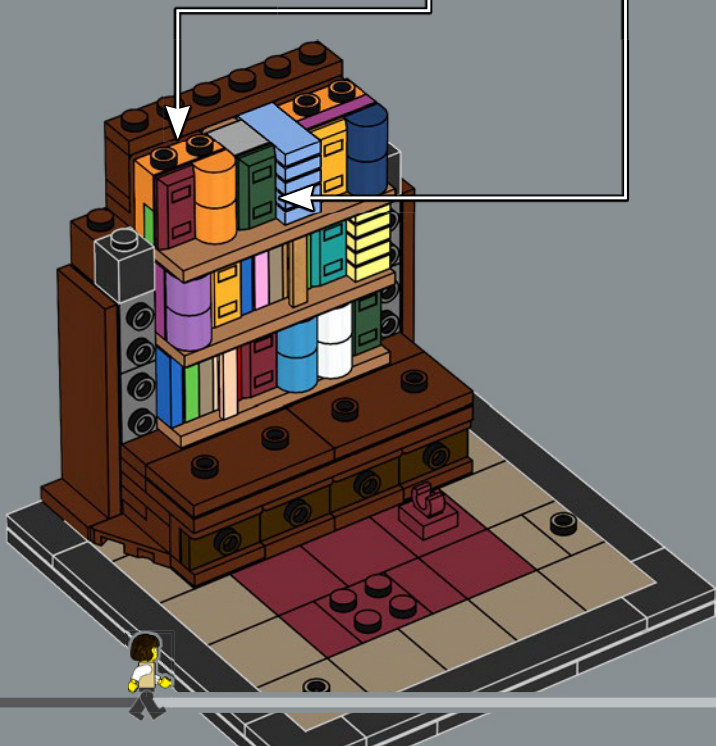
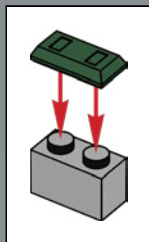
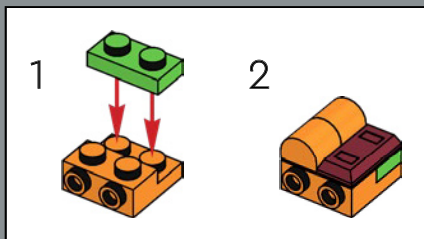

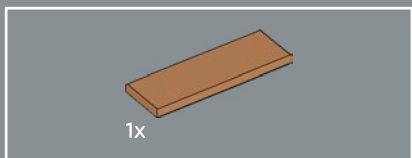

37

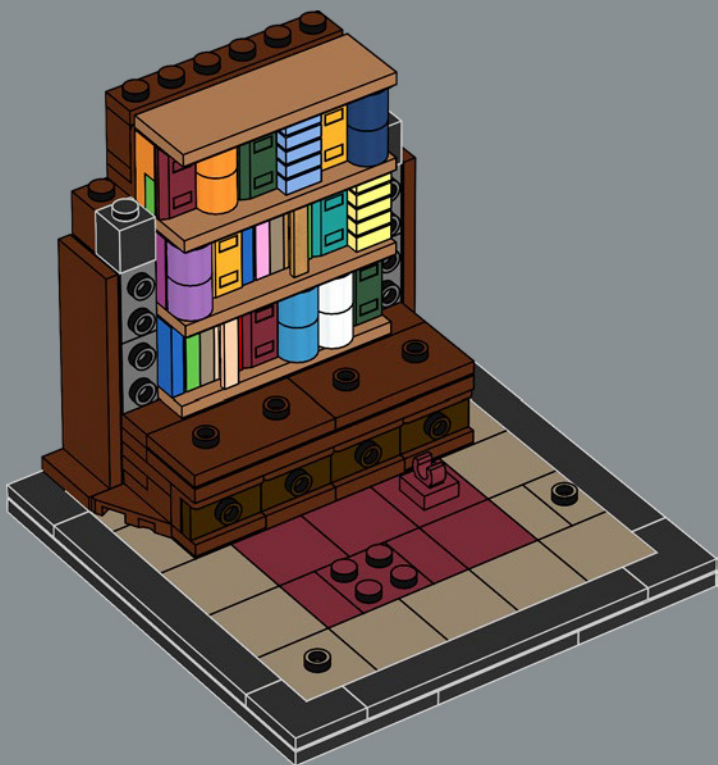

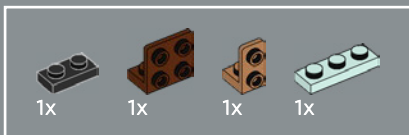

38

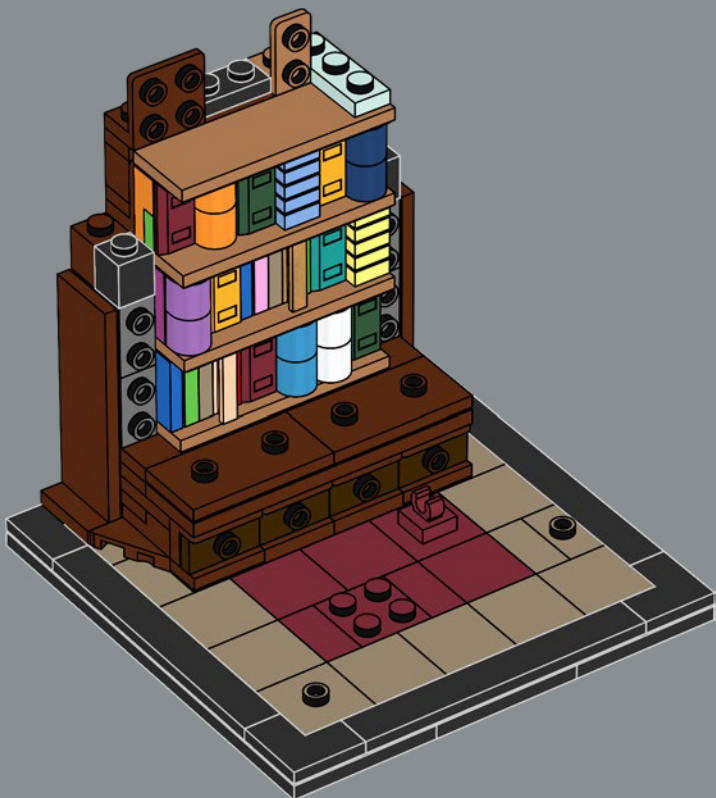

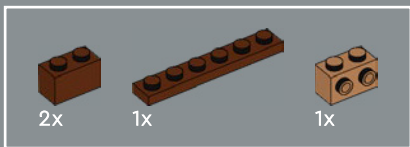

39

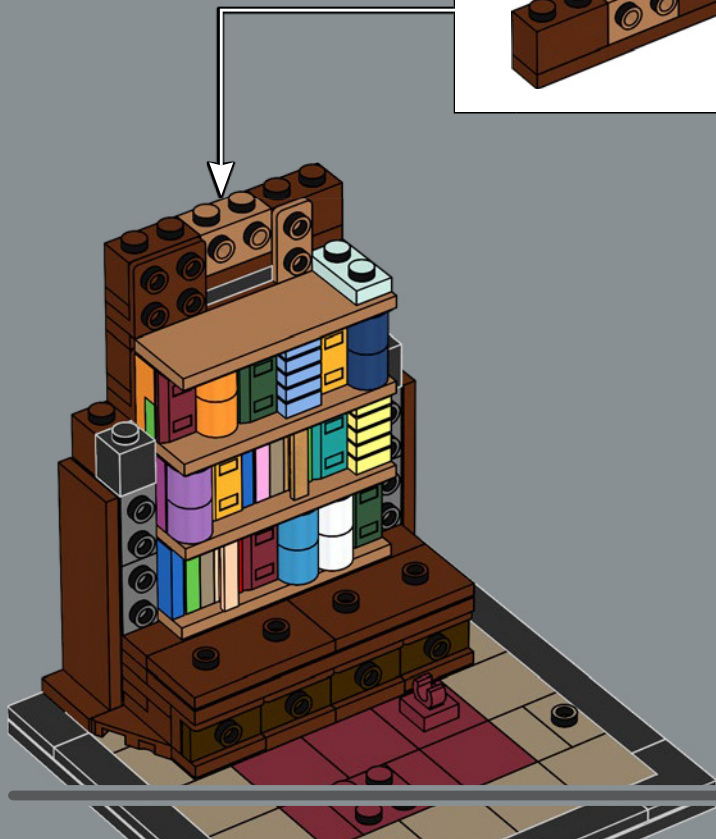
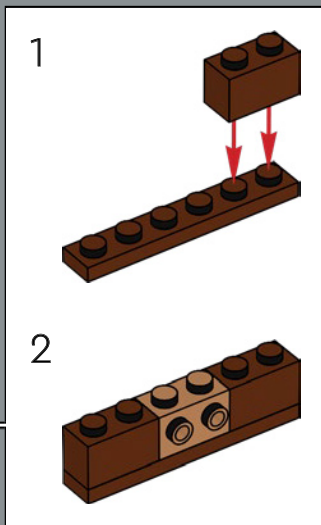

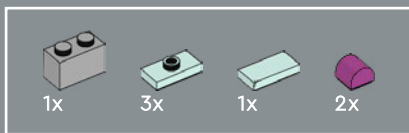

40

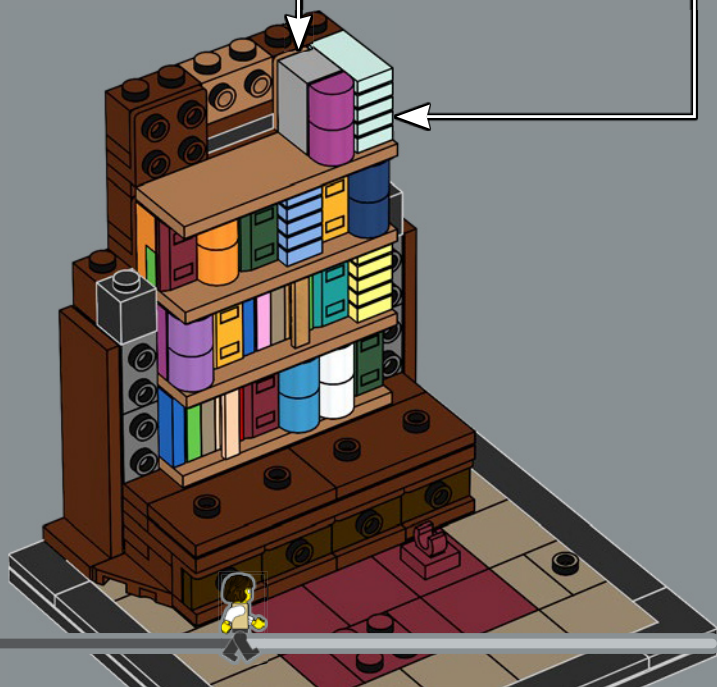
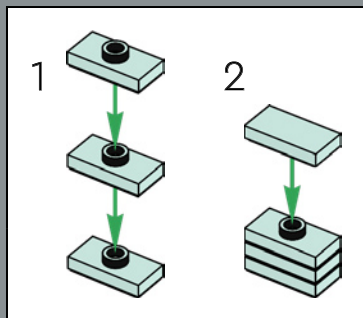
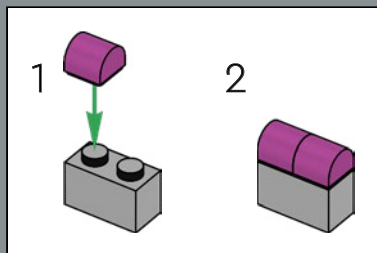

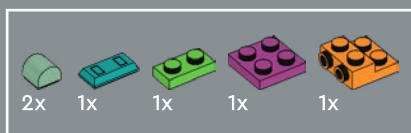

41

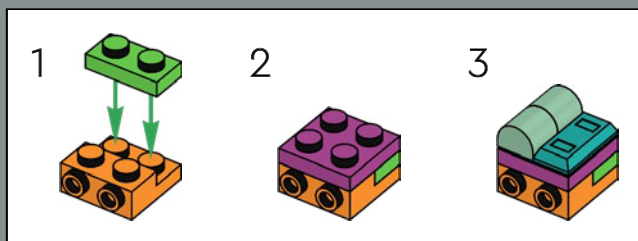

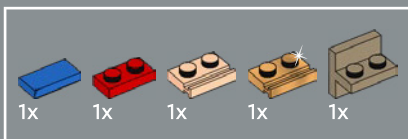

42

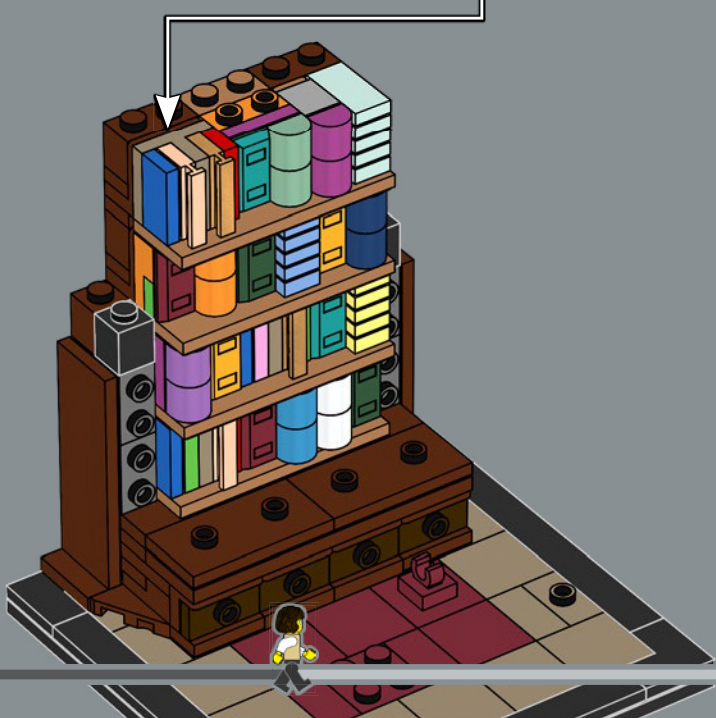
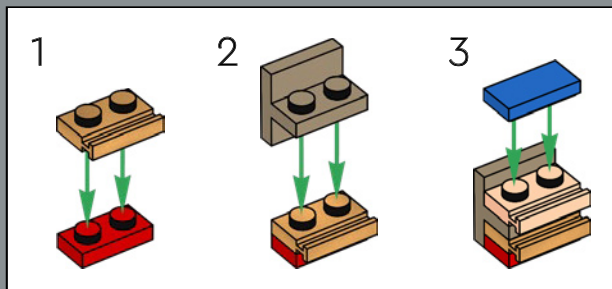

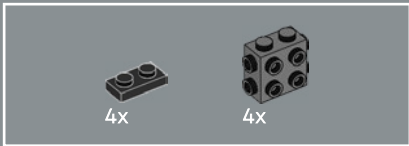

43

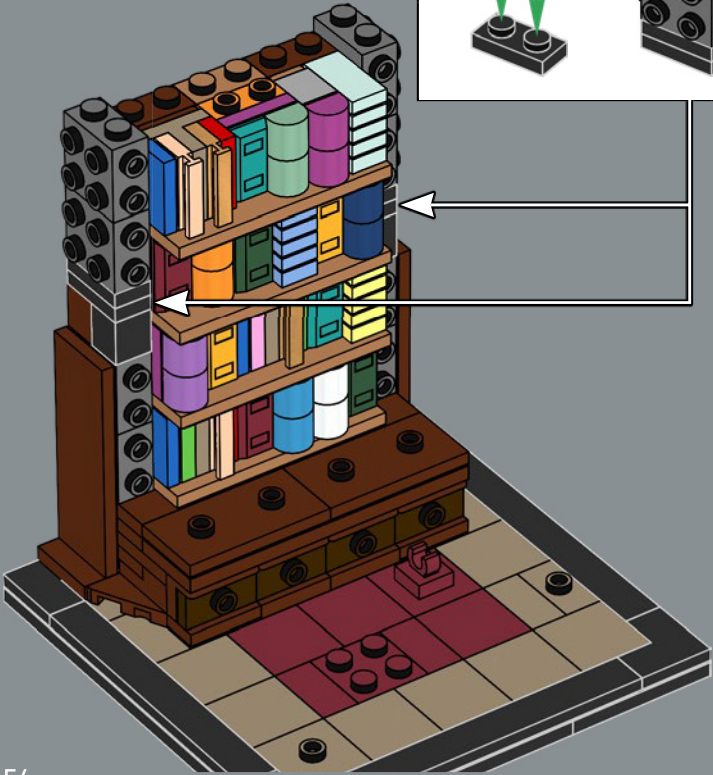
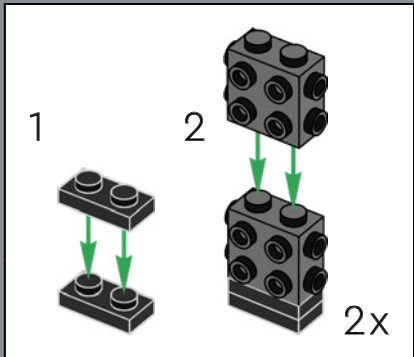

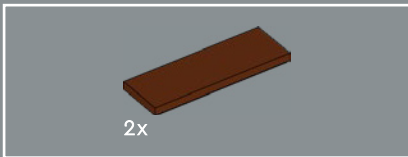

44

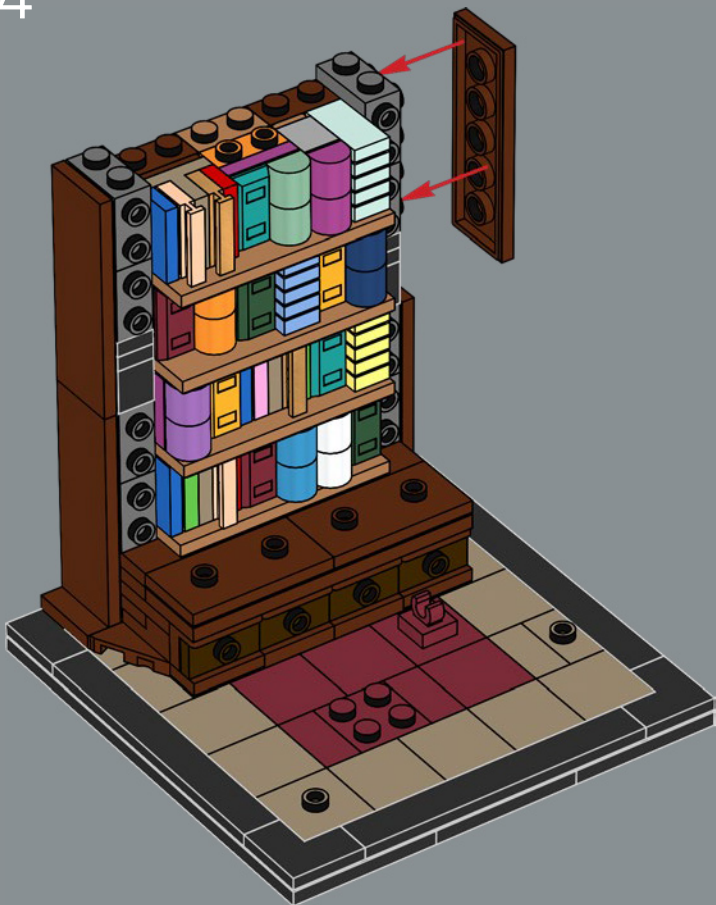



45

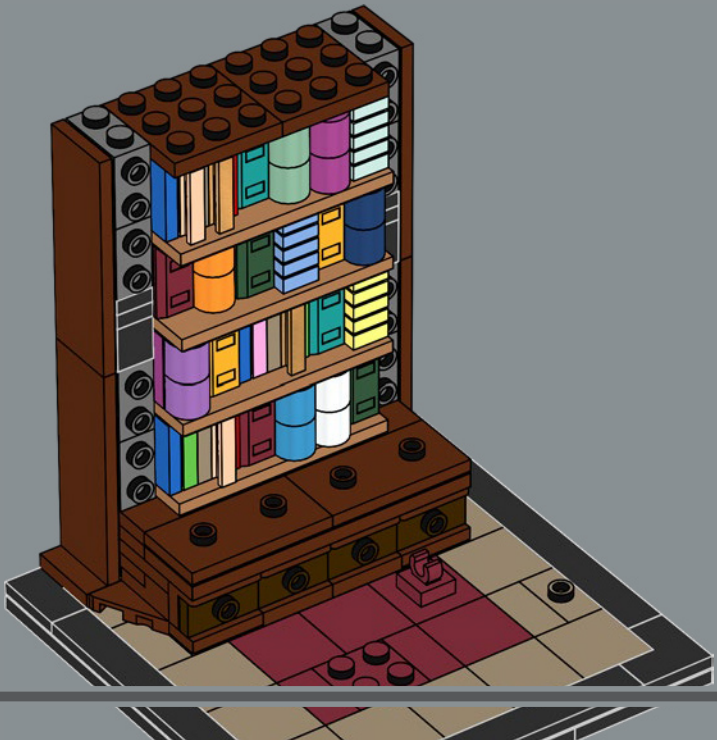

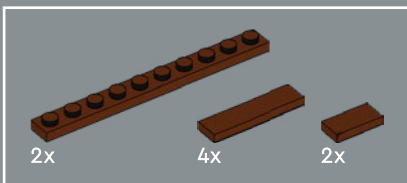
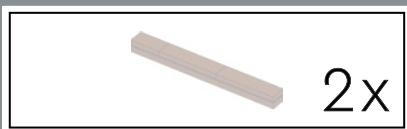

46

1

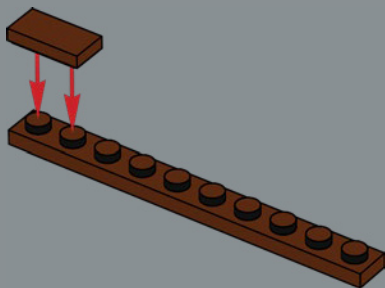

2

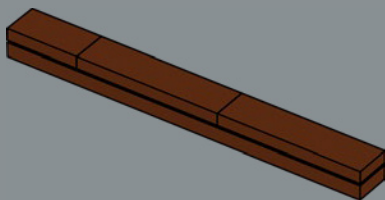

2x



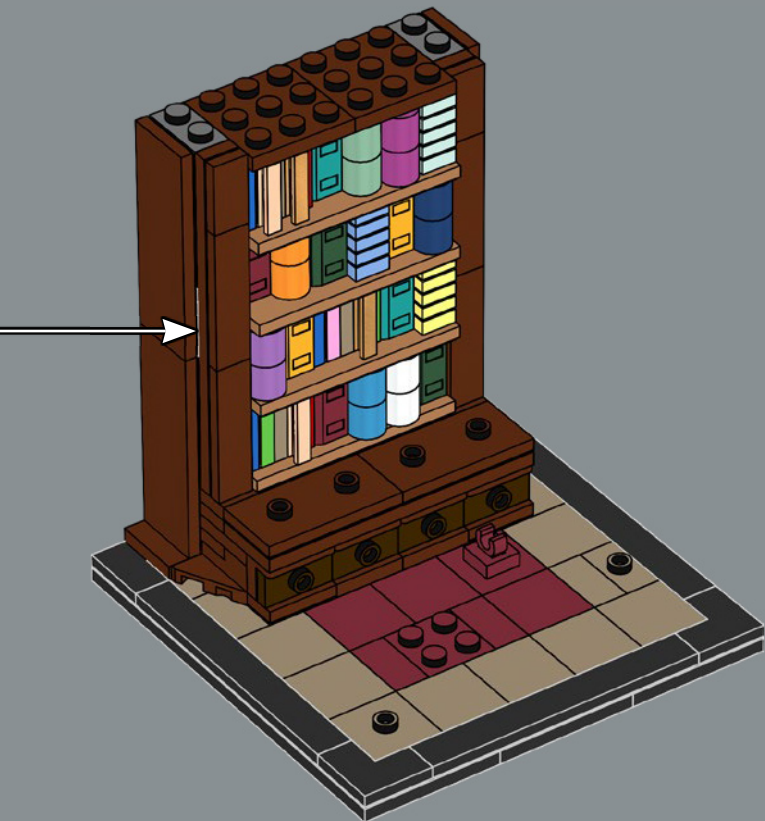

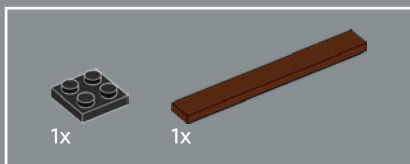

47

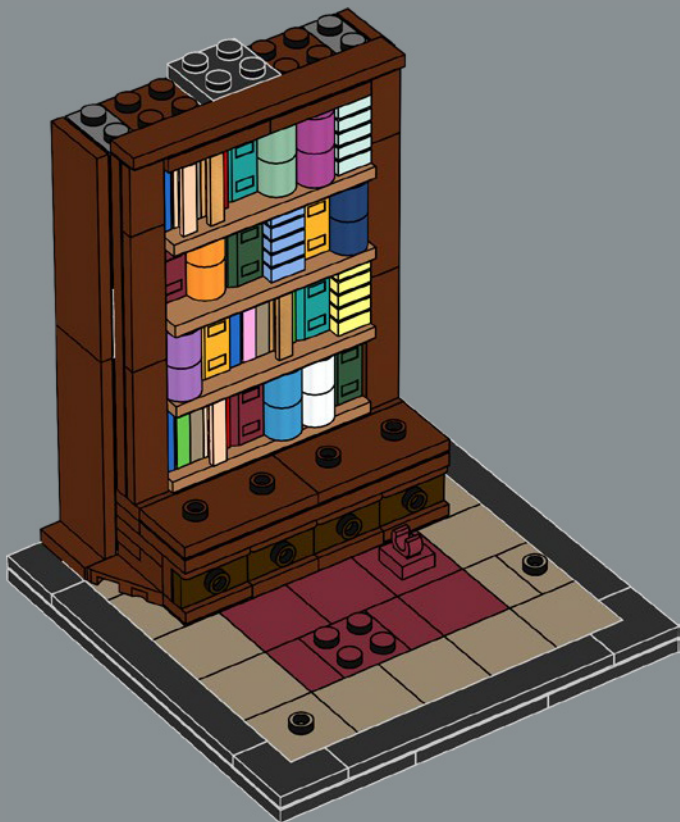

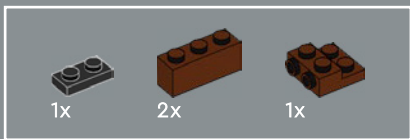

48

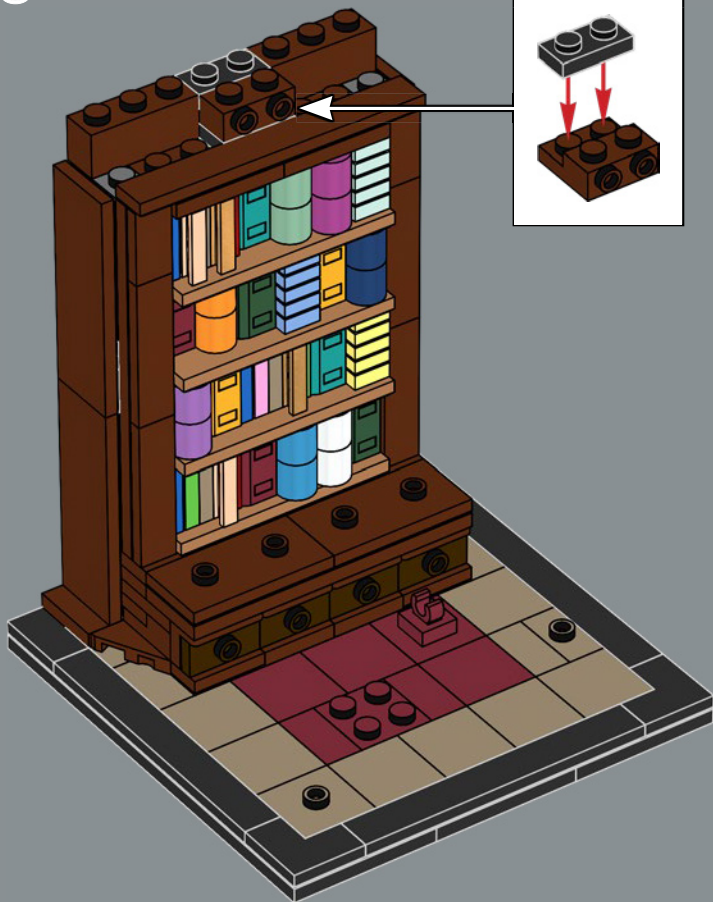

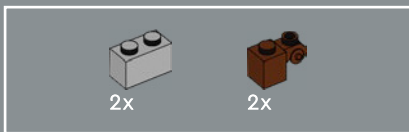

49

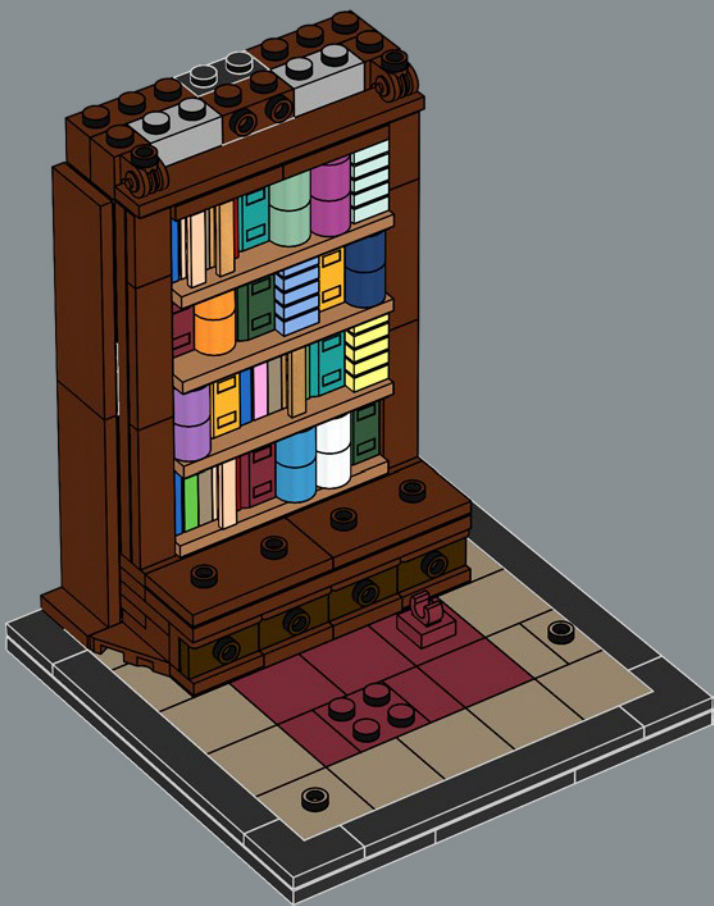

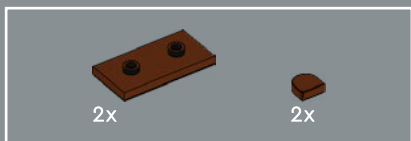

50

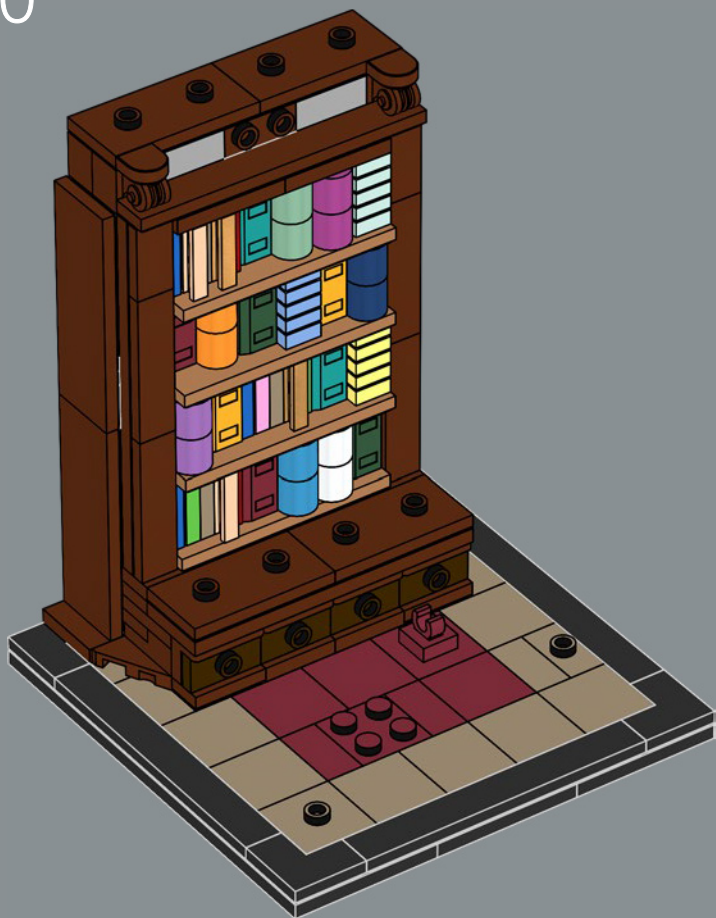

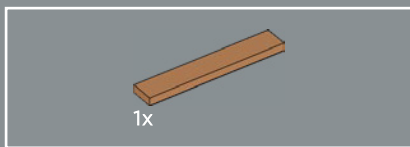

51

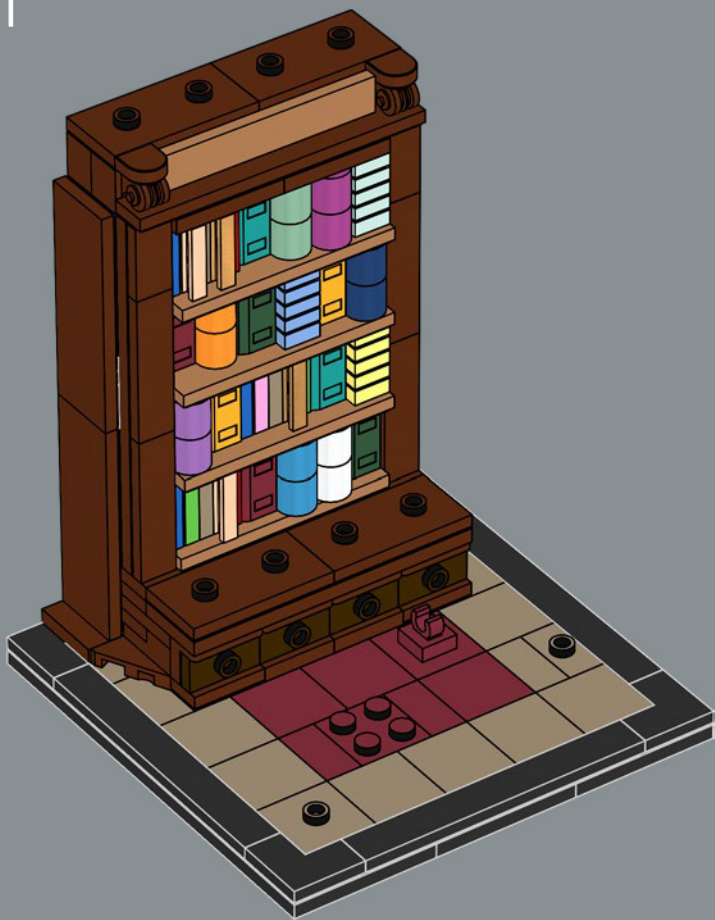

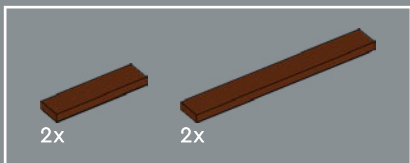

52

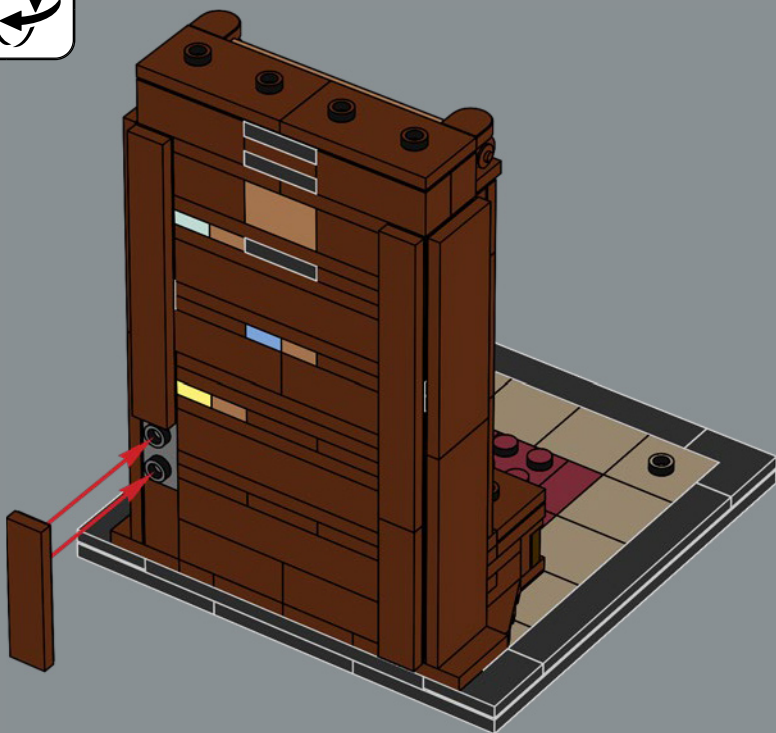

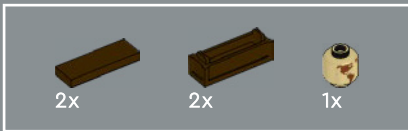

53

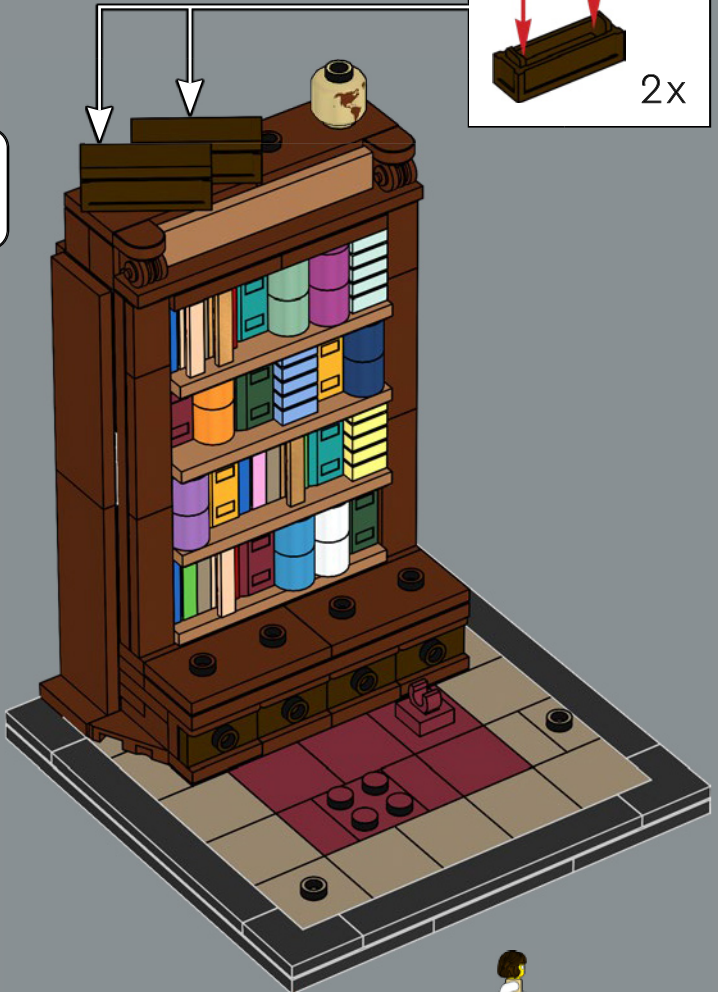



54

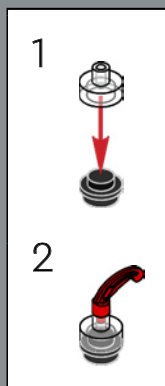
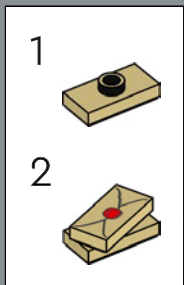

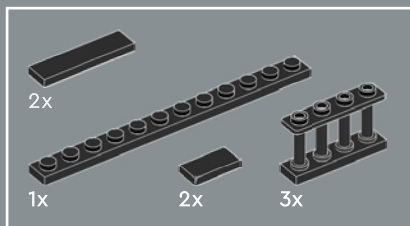

55

1

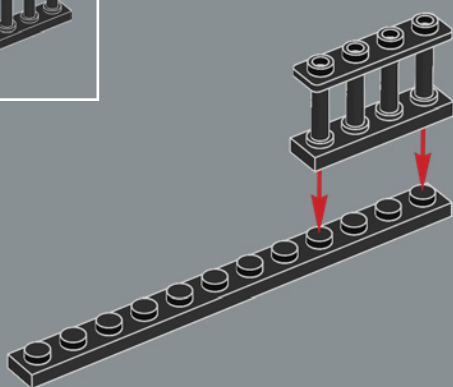

2

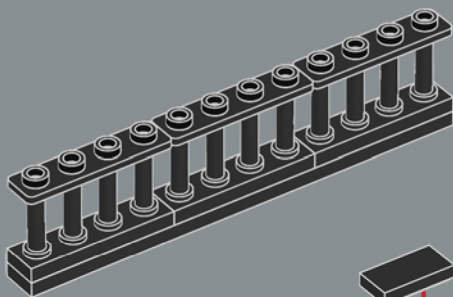

3

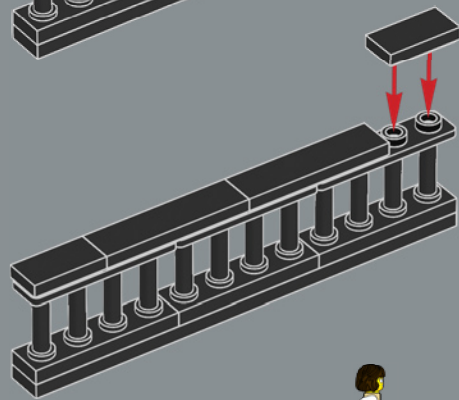

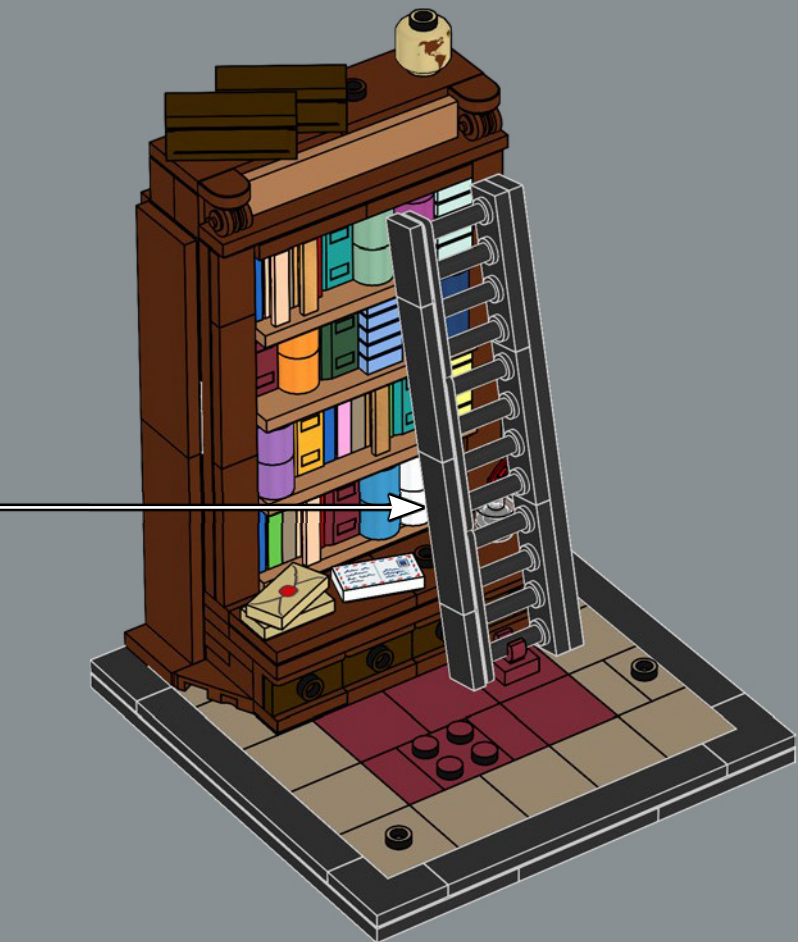

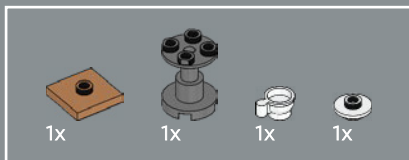

56

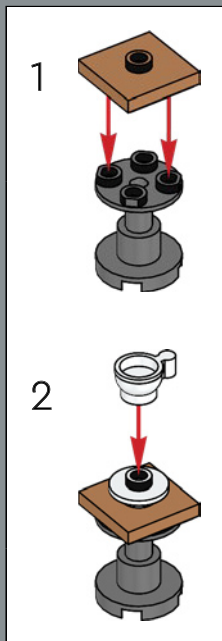
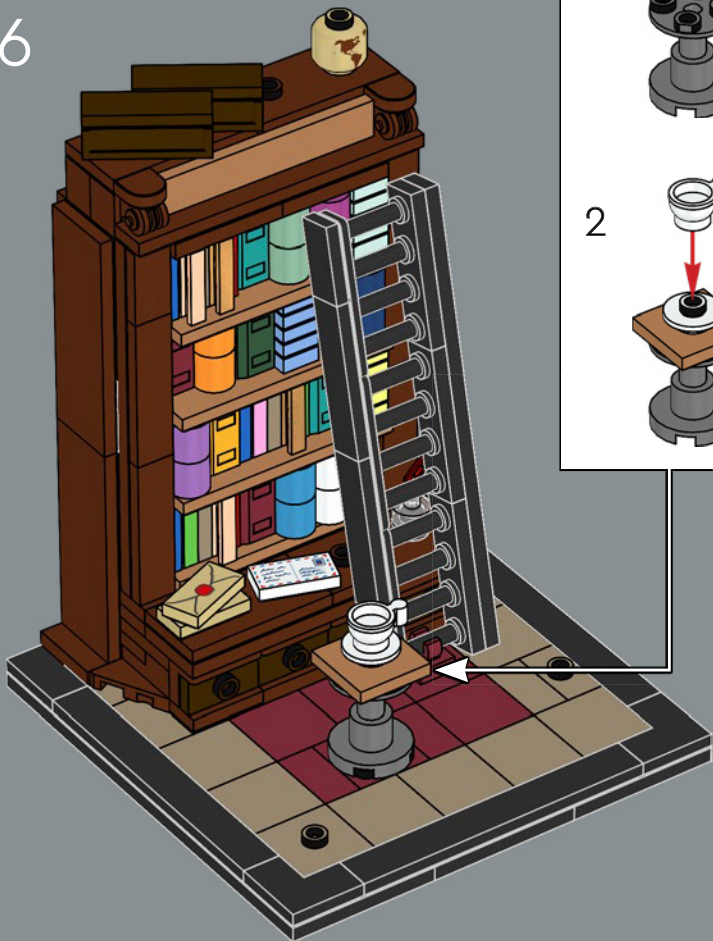



57

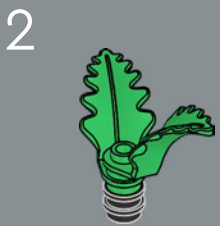
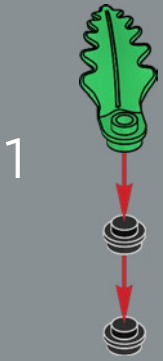





1x
6508151

2x
6258135

1x
6235083

1x
6050914

1x
6466380

1x
6157985

1x
6407746

2x
4159553

1x
6092587

1x
6284163

1x
6400766

1x
6406416

2x
302321

1x
371021

3x
306923

3x
614126

2x
300526

1x
9339

6x
302326

2x
306926

1x
302226

4x
6133722

3x
6066113

2x
243126

1x
346026

3x
416226

1x
4514845

3x
302926

3x
302926

3x
6411022

6x
6343326

2x
6335233

4x
6315782

1x
6507895

3x
6092601

1x
4168345

1x
6170268

2x
6278436

6x
6469462

2x
6391344

2x
6331867

1x
6153328

1x
6360079

1x
6258352

1x
6258353

1x
4164037

2x
6278442

3x
6109930

1x
6037658

1x
6092591

5x
4496699

3x
6328183

7x
4507045

1x
6126075

2x
4246957

1x
6325961

2x
6261546

1x
6420630

4x
6404033

2x
6167928

2x
6310366

3x
6380634

1x
6411587

1x
6102994

1x
6102995

4x
6381921

2x
6488001

1x
6133247

3x
6097303

1x
6325961

2x
6261546

12x
6403899

2x
4255413

1x
6135606

1x
4528488

1x
6214810

2x
6233955

1x
4264569

1x
6027625

2x
4539090

2x
6448315

3x
4539105

1x
4613761

1x
4585479

1x
6107758

2x
6236454

3x
6195266

1x
6061201

1x
6296492

5x
4211388

1x
6106283

8x
6314192

1x
4654128

2x
6488209

2x
6338242

2x
6328180

2x
6201911

1x
6385263

2x
4211220

2x
4211152

2x
4211189

2x
4216668

1x
6385262

2x
6172757

2x
4211149

4x
4211151

4x
6174856

8x
6226436

6x
6196221

2x
4211257

5x
6470170

2x
4211225

2x
4211190

6x
4211194

2x
6497747

4x
6307618

1x
4211186

3x
4211193

7x
4221590

4x
6326103

3x
4585337

2x
4211211

2x
4223683



 [LEGO.com/service](https://www.LEGO.com/service)



YOU COULD WIN



YOU COULD WIN

Your feedback will help shape the future development of this product series.

Visit:

DU KÖNNTTEST GEWINNEN

Dein Feedback trägt zur Weiterentwicklung dieser Produktreihe bei.

Geh auf:

VOUS POURRIEZ GAGNER

Vos commentaires nous aideront à concevoir les futurs produits de cette gamme.

Visitez :

POTRESTI VINCERE TU

La tua opinione ci aiuterà a migliorare la creazione futura di questa linea di prodotti.

Visita:

PUEDES GANAR

Tu opinión contribuirá al futuro de esta serie de productos.

Visita:

轻松获奖

您的反馈将有助于我们在今后改进本产品系列。

请访问：

LEGO.com/productfeedback

You also have the chance to win a LEGO® set.

Terms and conditions apply.*

Außerdem hast du die Chance, ein LEGO® Set zu gewinnen.

Es gelten die Teilnahmebedingungen.*

Vous pourriez également gagner un ensemble LEGO®.

Des conditions s'appliquent.*

Hai anche la possibilità di vincere un set LEGO®.

Termini e condizioni sono applicabili.*

También tienes la oportunidad de ganar un set LEGO®.

Aplican términos y condiciones.*

您还有机会赢取乐高® 套装。

条款和条件适用。*

*LEGO.com/productfeedback-terms

