



40696





Get excited about our new packaging!

We're switching from plastic to paper-based packaging. That's why you might find a mix of paper and plastic in our boxes!

Nos nouveaux emballages vous emballeront !

Nous passons des emballages en plastique aux emballages à base de papier. C'est pourquoi vous pourriez trouver un mélange de papier et de plastique dans nos boîtes !

¡Te presentamos nuestros nuevos empaques!

Estamos sustituyendo las bolsas de plástico por bolsas con base de papel. ¡Por eso, puedes encontrar una mezcla de papel y de plástico en nuestras cajas!

[LEGO.com/sustainable-packaging](https://www.lego.com/sustainable-packaging)

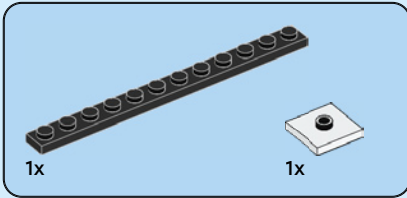

1

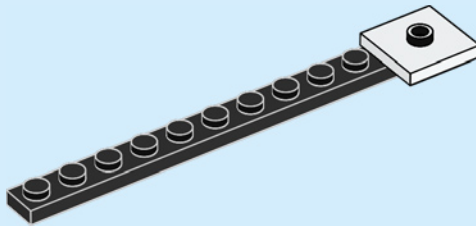



1x

2

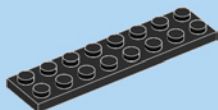
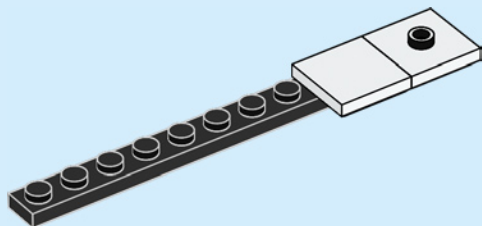

1x



1x



1x

3

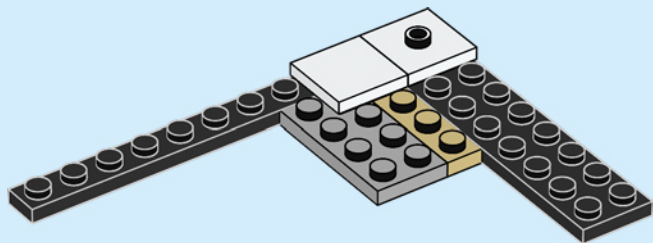

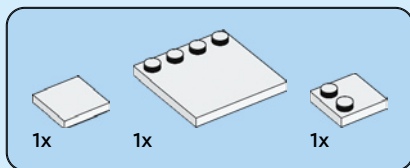

4

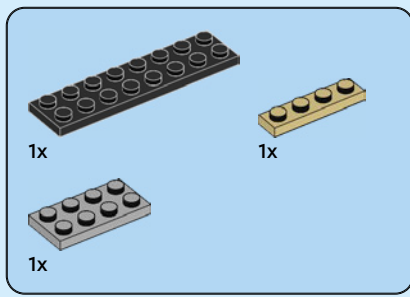
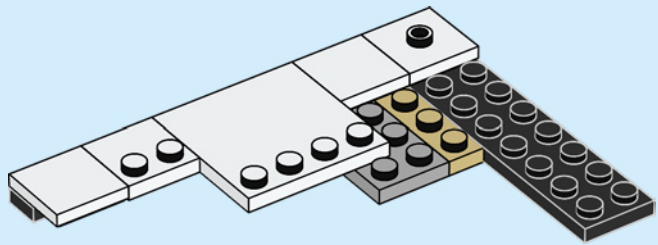

5

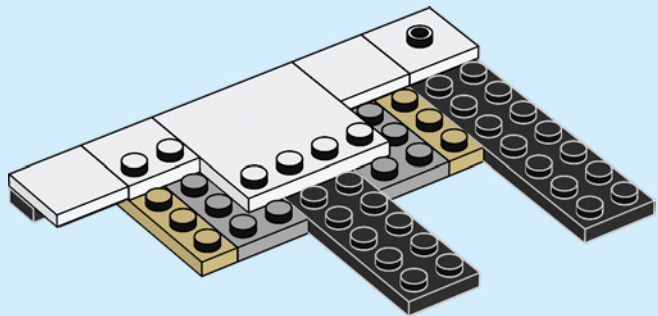

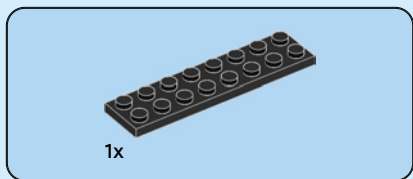

6

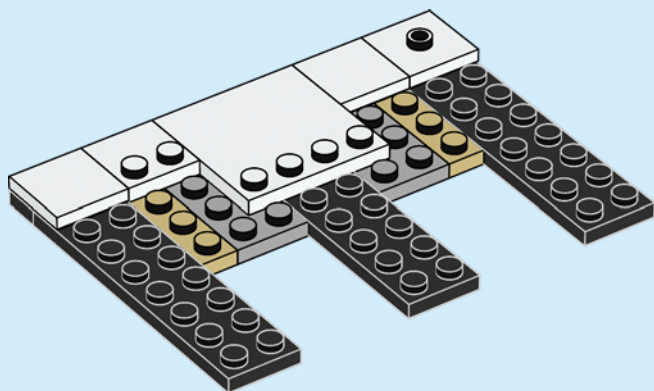

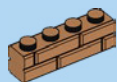

2x

7

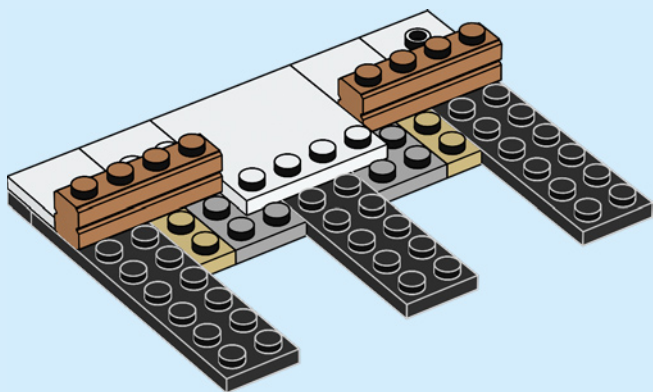



2x



4x

8

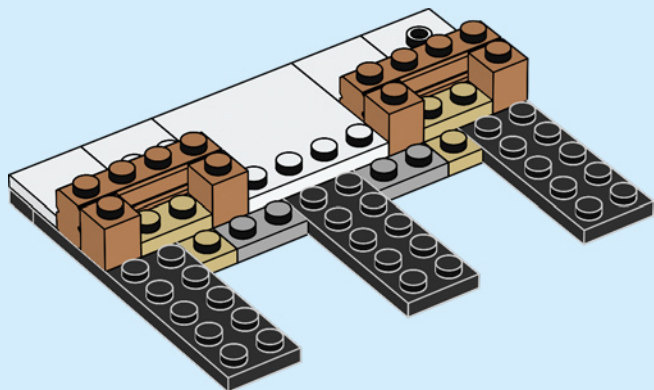

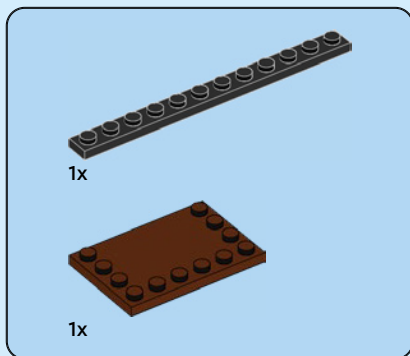

9

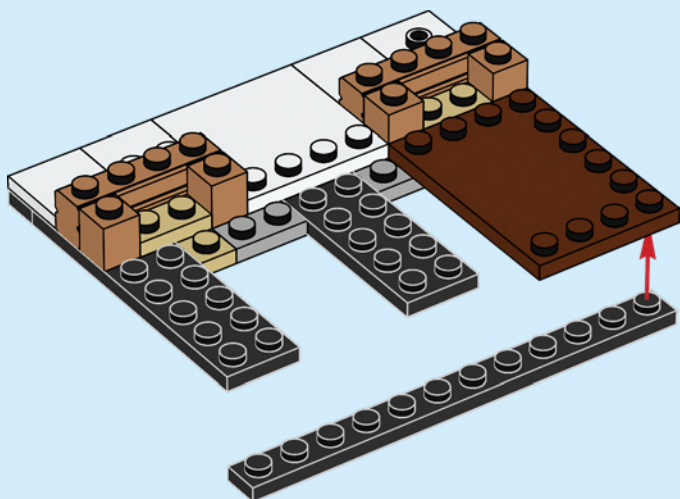

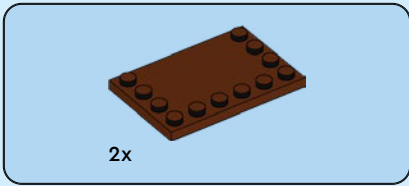

10

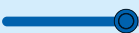
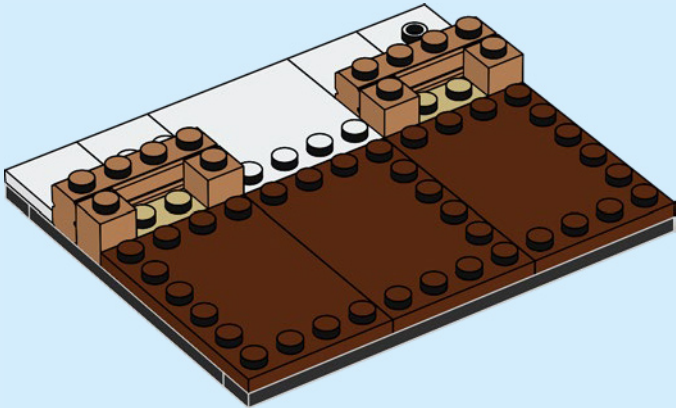



2x



4x



4x

11

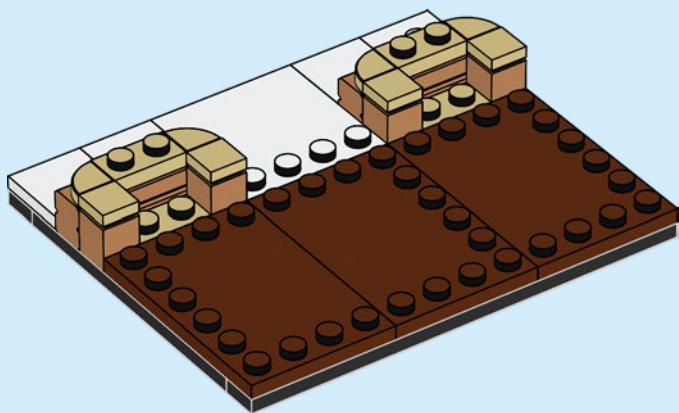

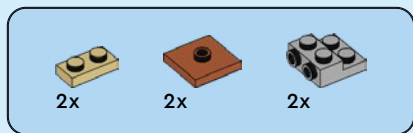

12

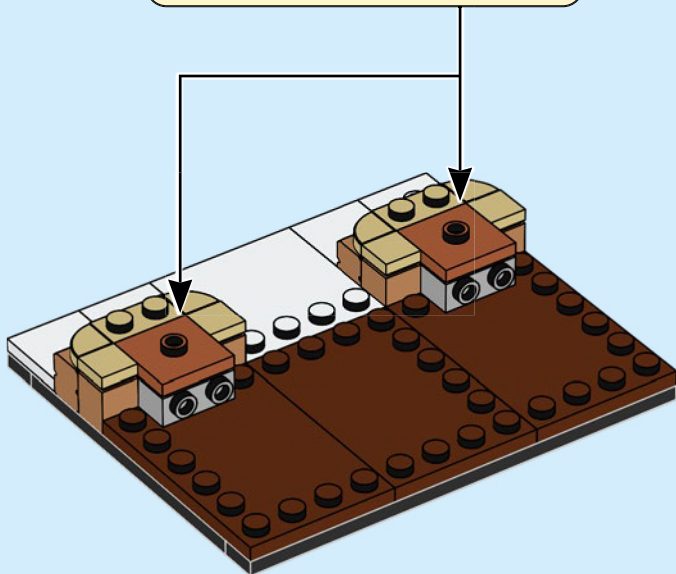
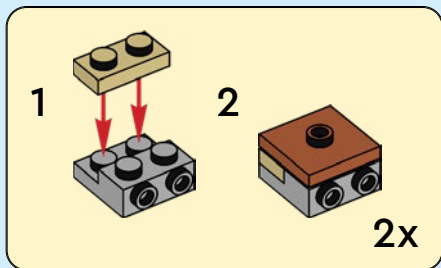

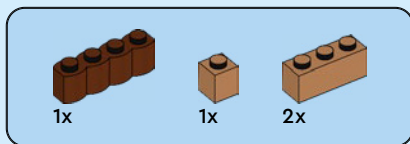

13

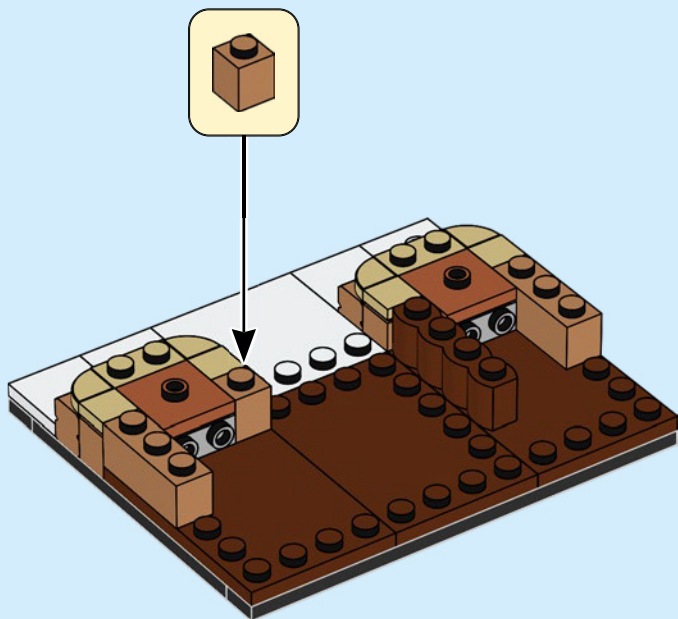



1x



1x

14

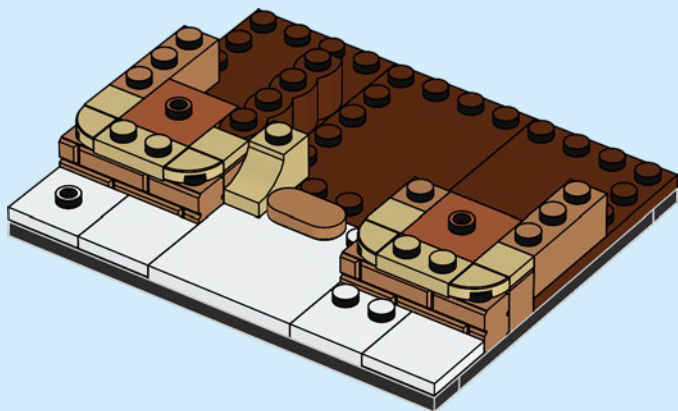
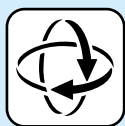

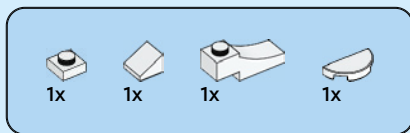

15

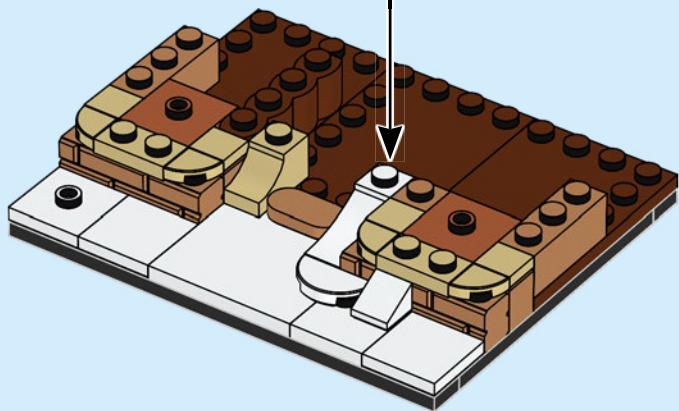
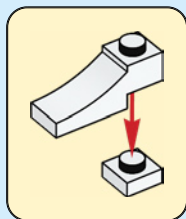



4x



8x



4x

16

1

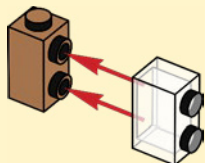

2

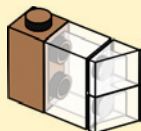

2x

1

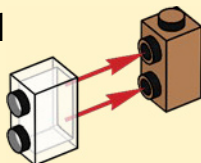

2

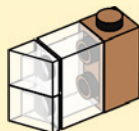

2x

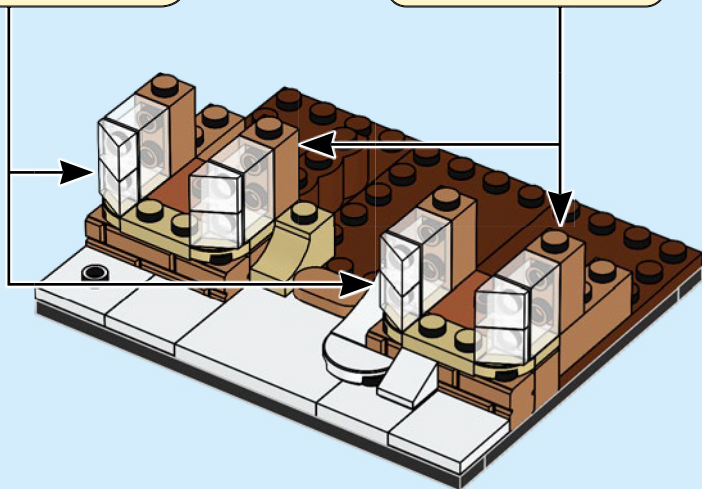



2x

17

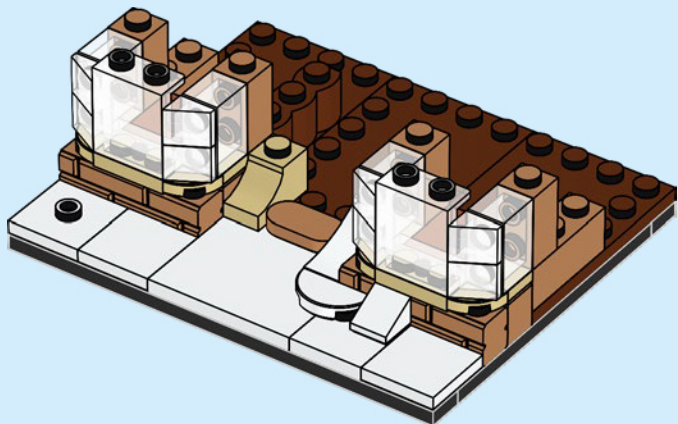



1x



1x



1x



1x



1x

18

1

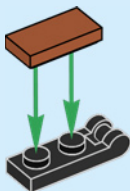

2



3

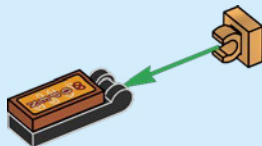

4

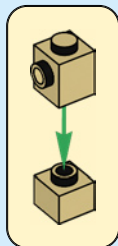
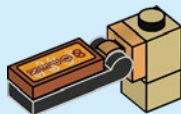

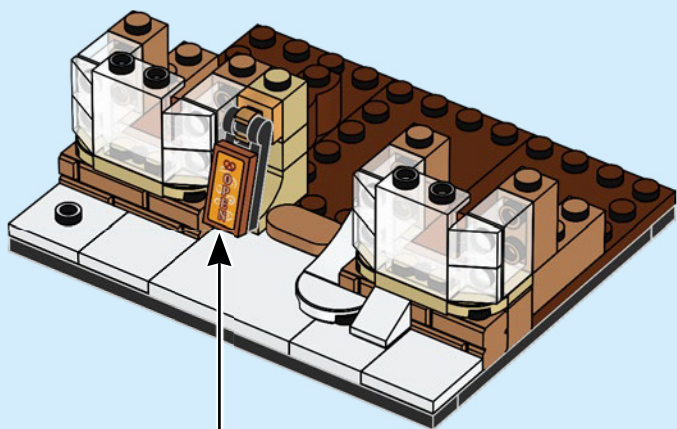

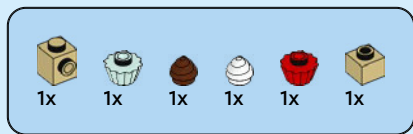

19

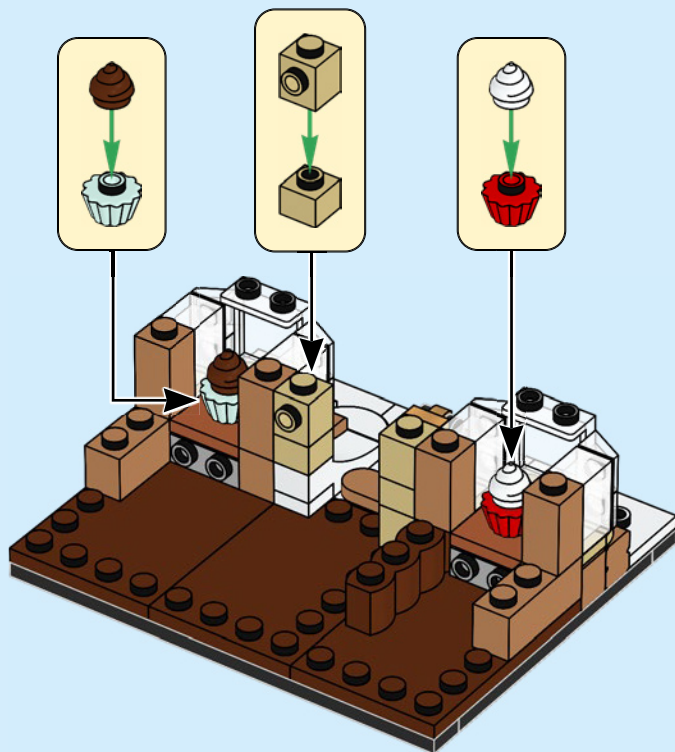

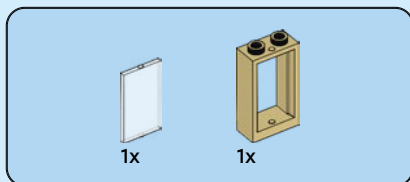

20

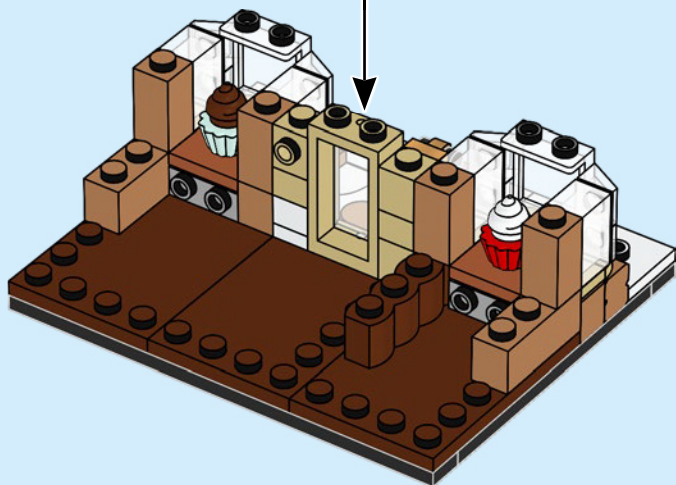
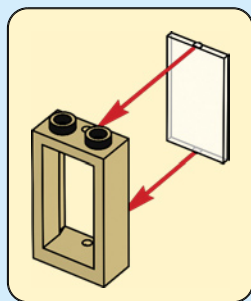

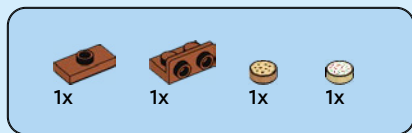

21

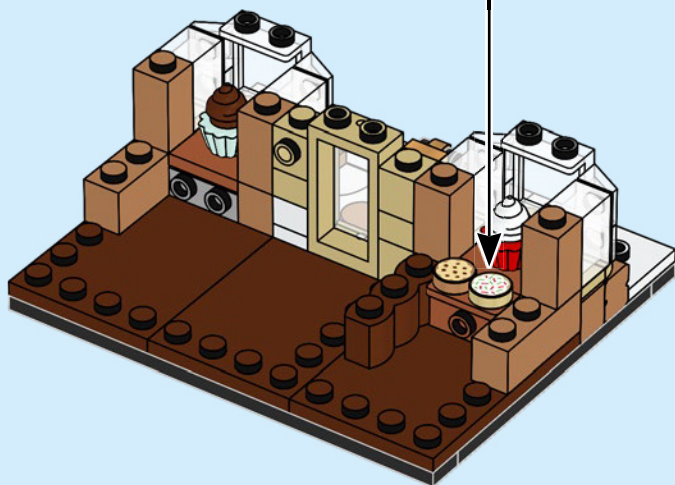
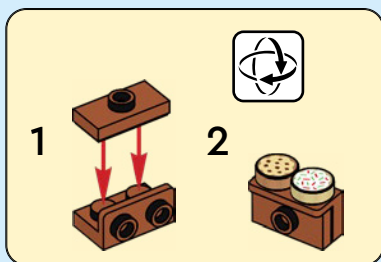

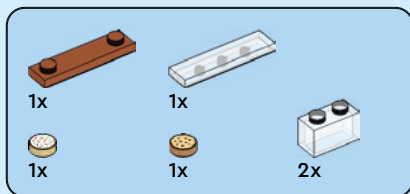

22

1

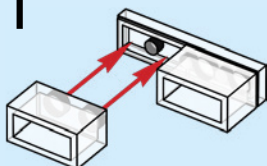

2

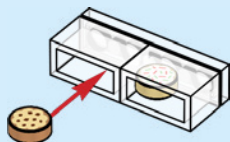

3

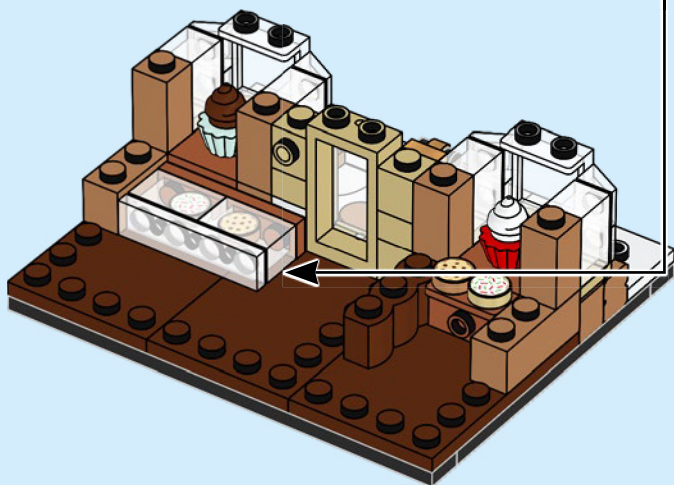

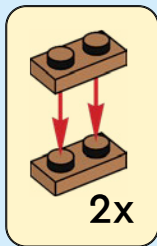
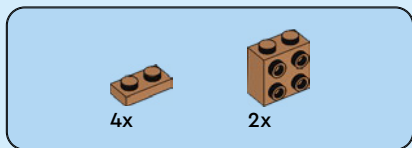

23

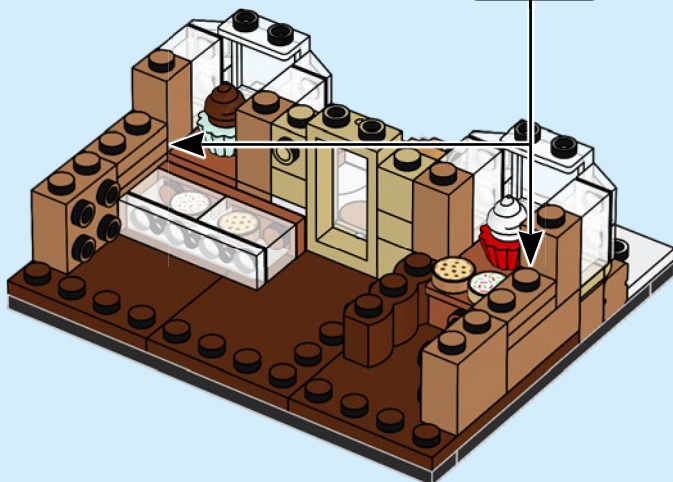

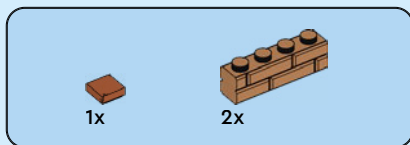

24

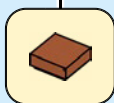
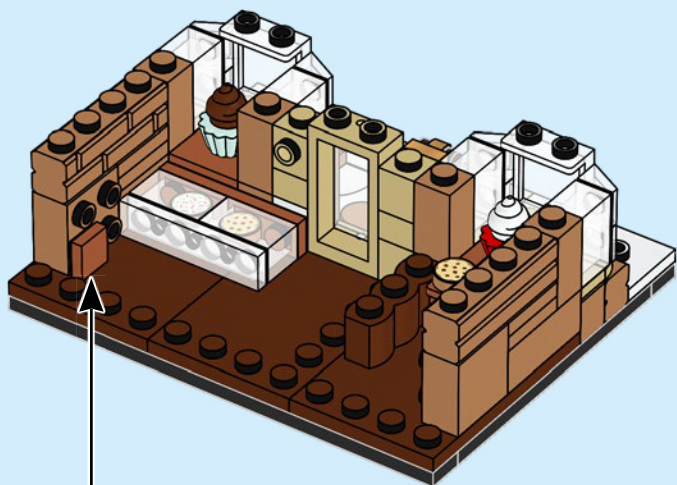



25

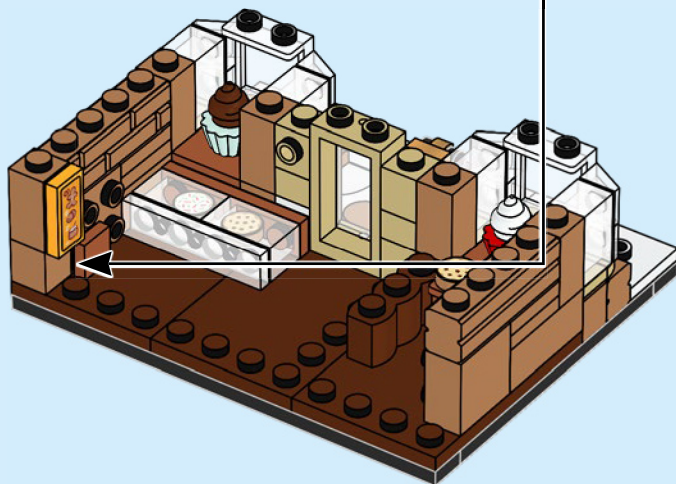
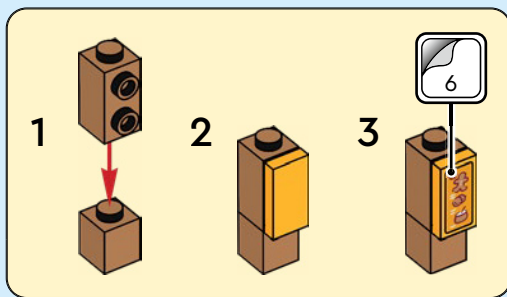

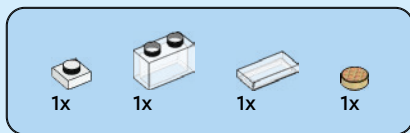

26

1

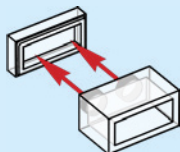

2



3

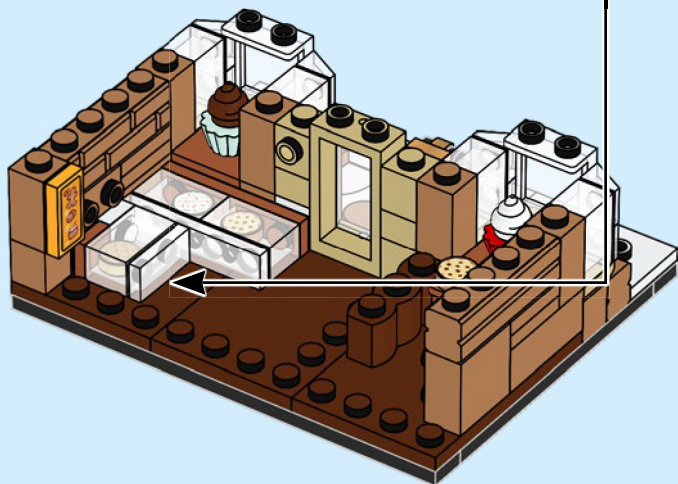



1x



1x



1x



1x

27

1

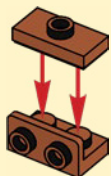

2

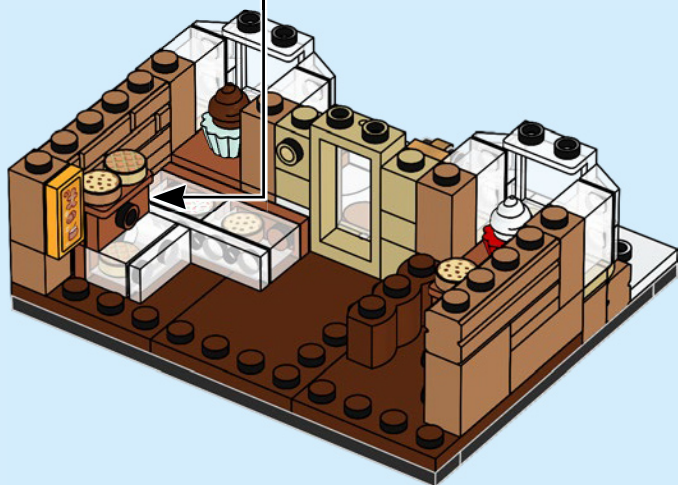

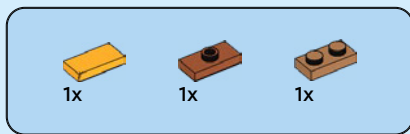

28

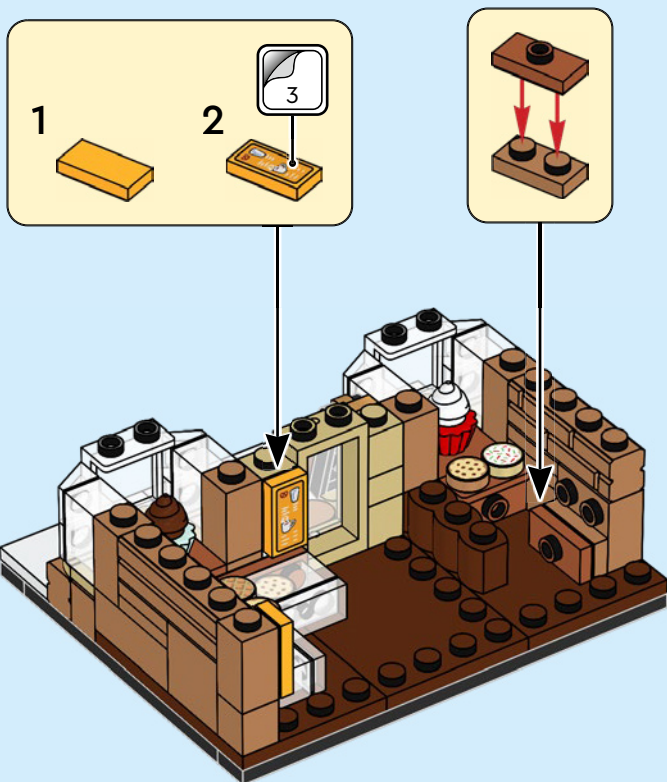

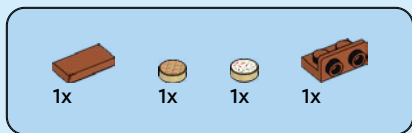

29



1

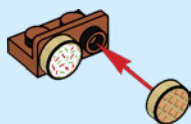

2



3

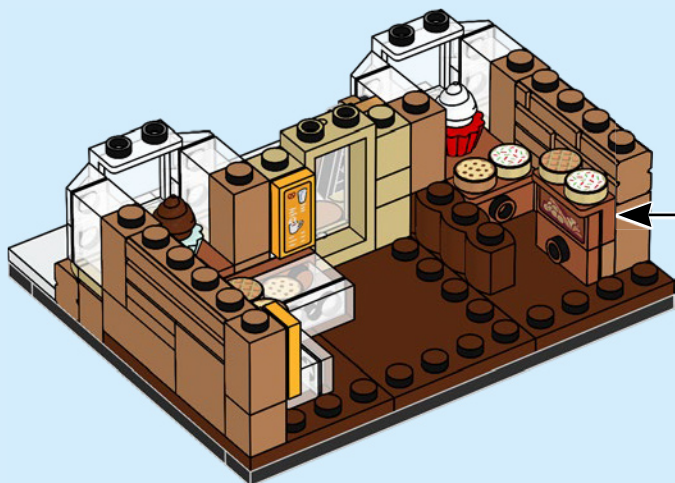

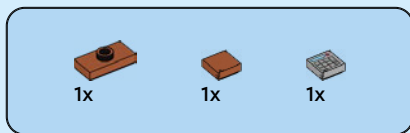

30

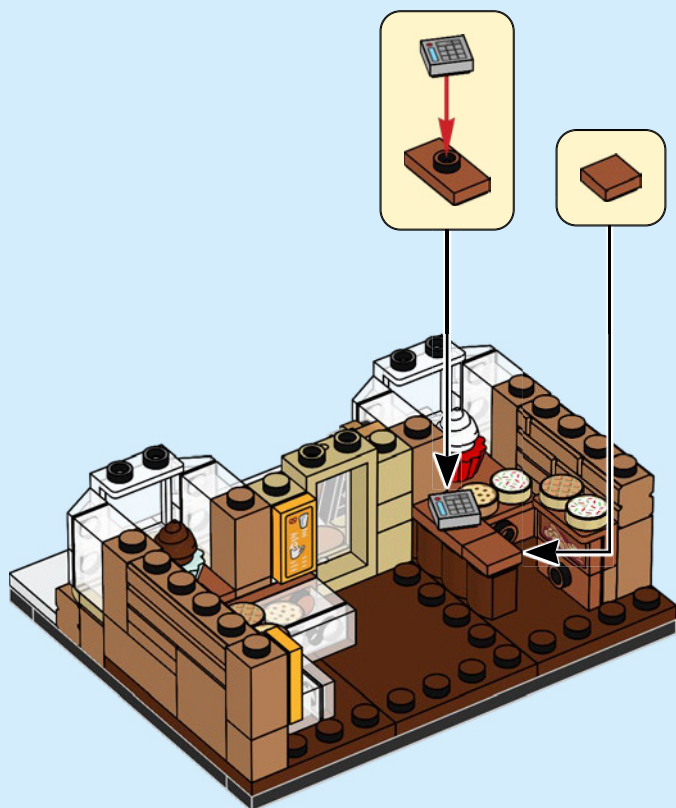



1x



1x



1x

31

1

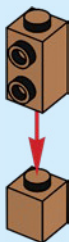

2



3



4

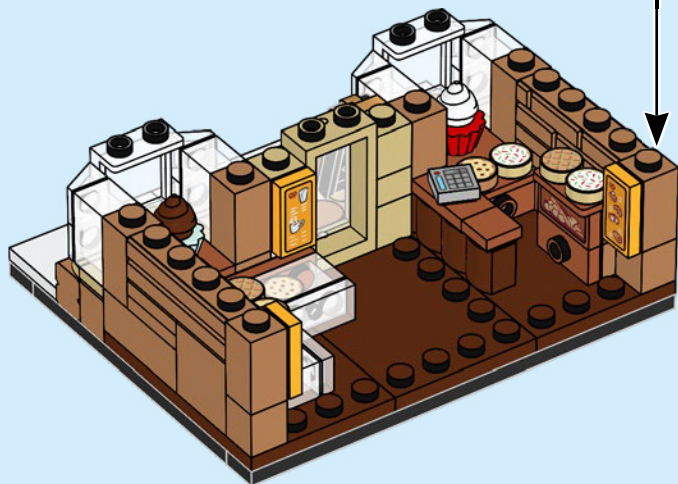



1x



2x

32



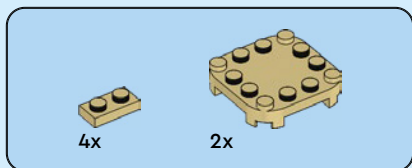

33

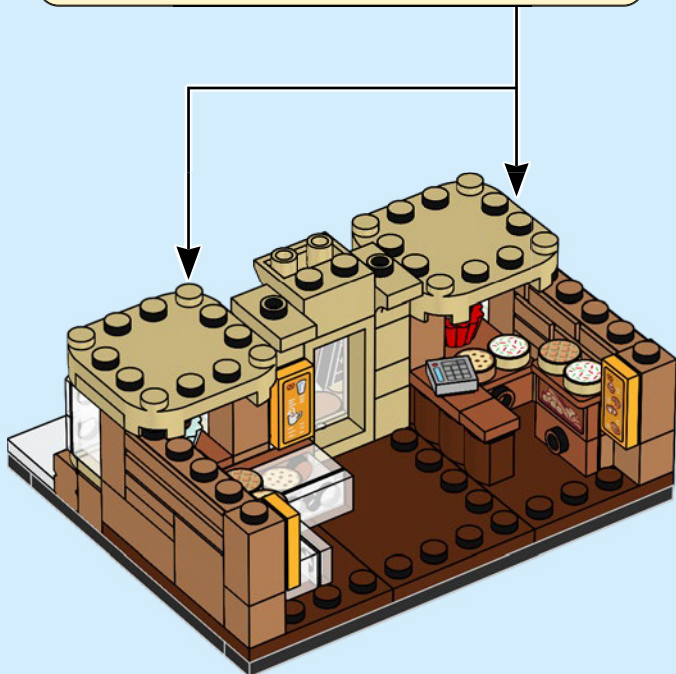
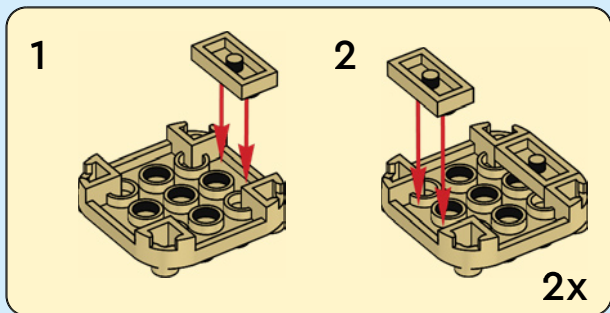



4x

34

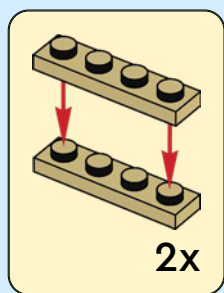

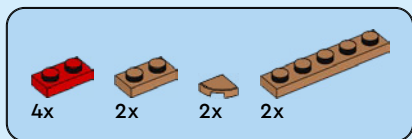

35



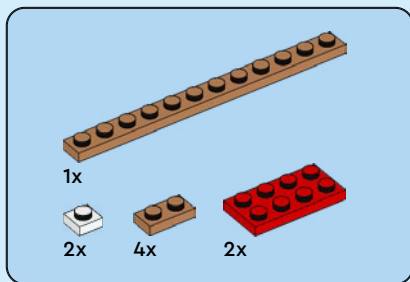

36

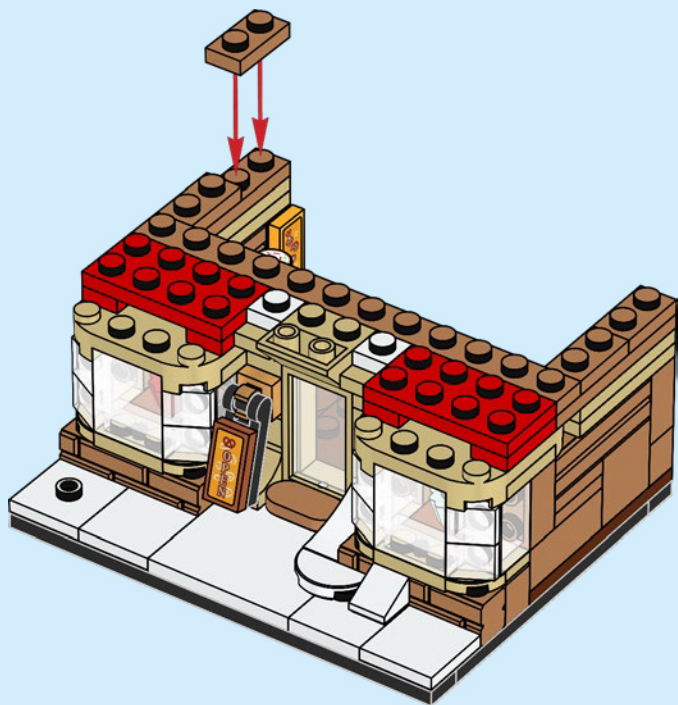

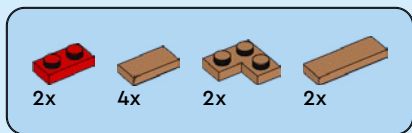

37

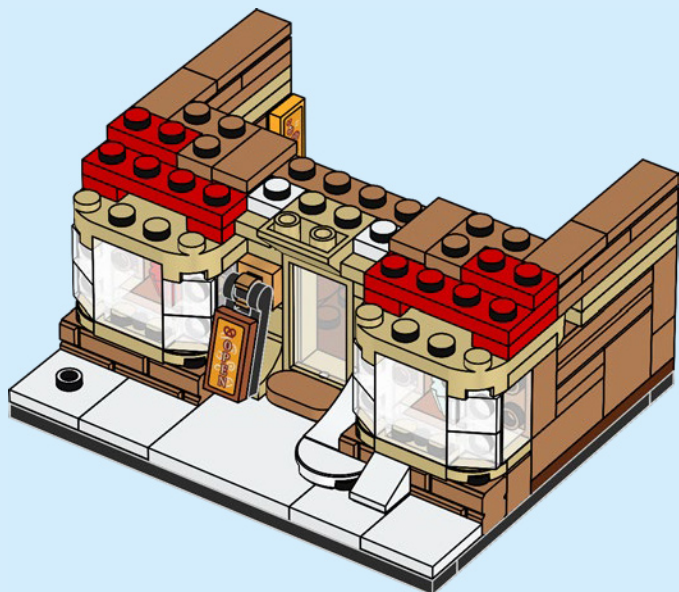

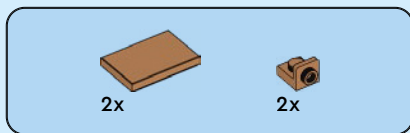

38

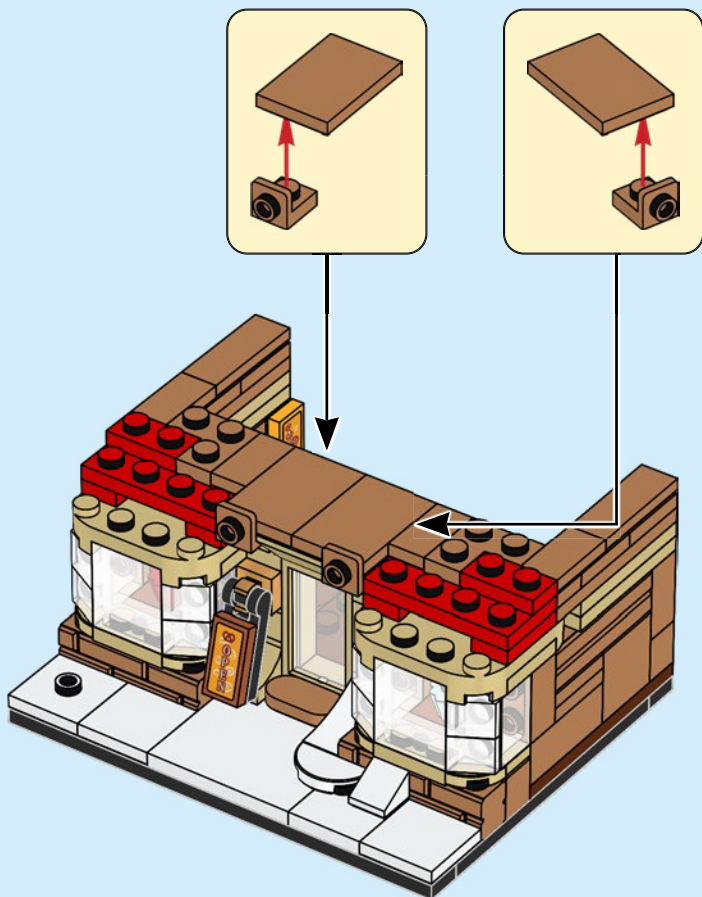



1x

39

1



2

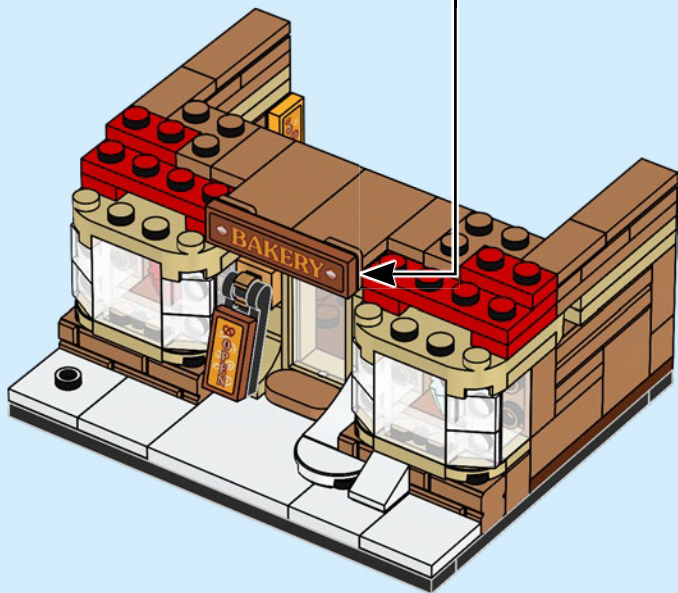



4x



4x

40

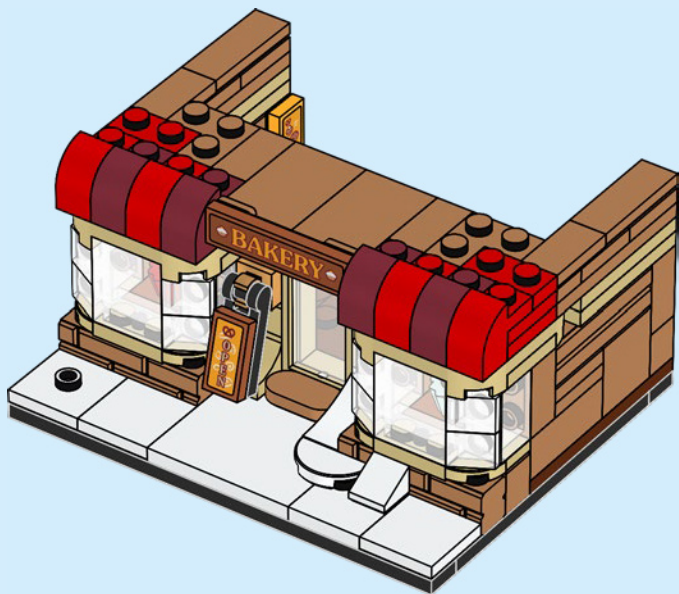



2x



2x



2x



2x

41

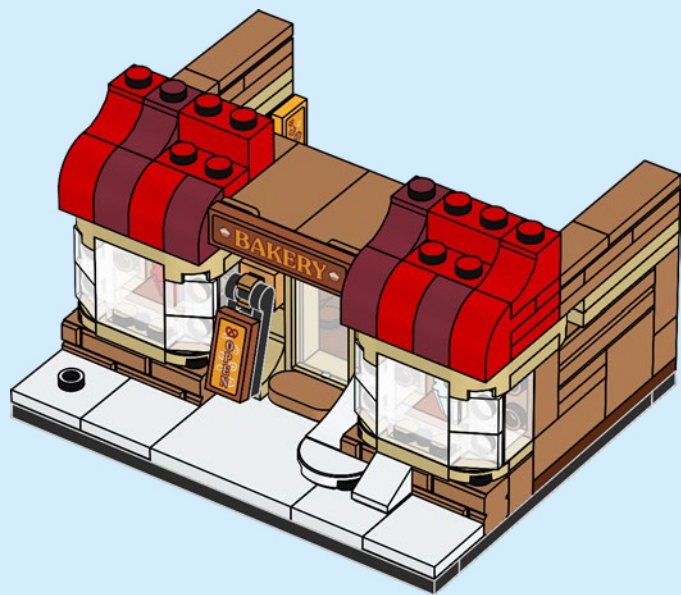



42

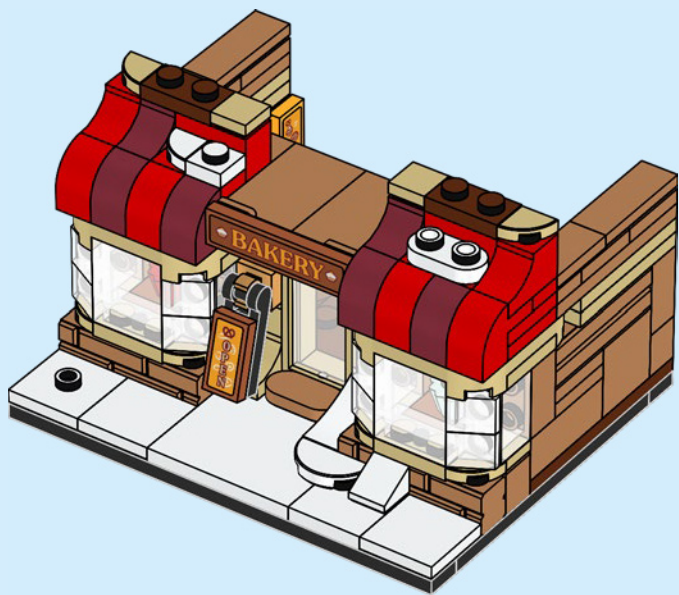



1x



2x



2x



1x

43

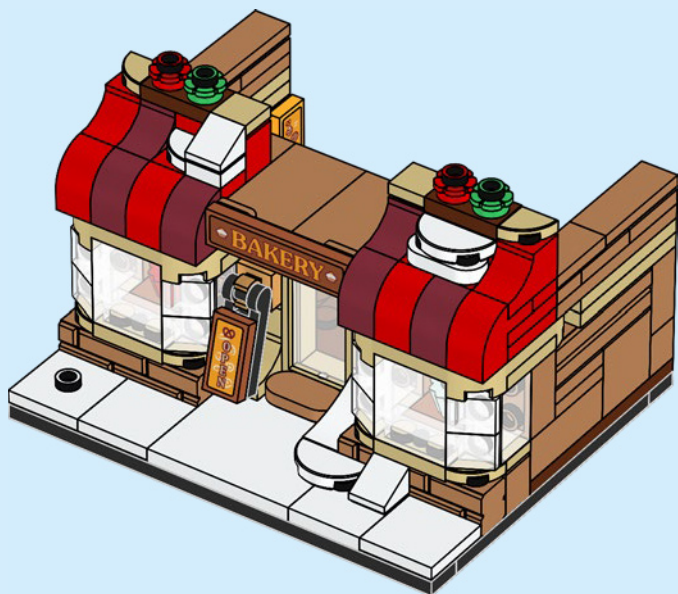



1x



1x



1x



1x



1x



1x



1x

44

1



2



3



4

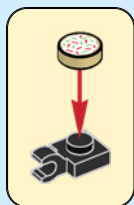

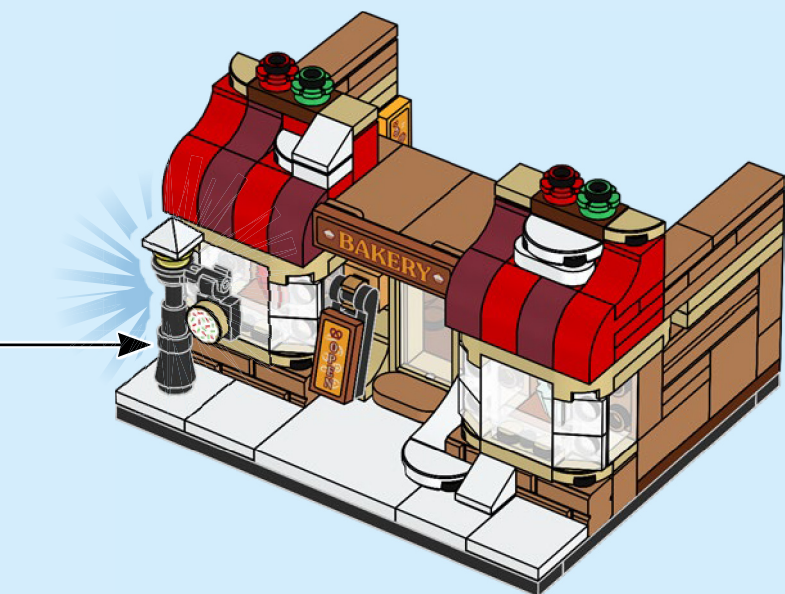



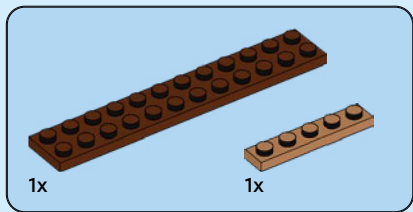
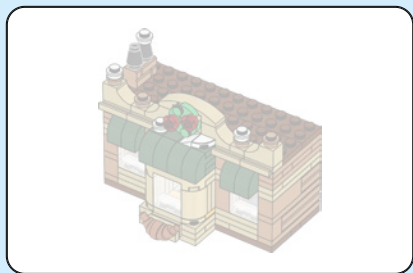

45

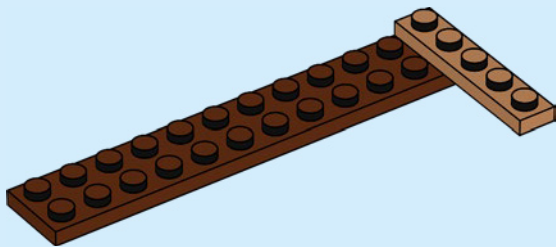

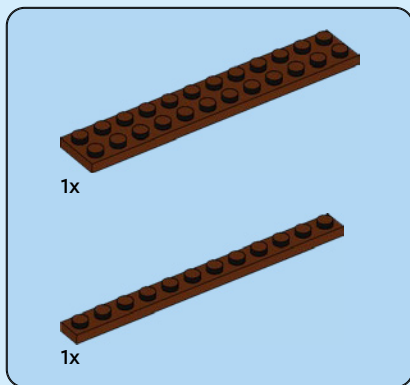

46

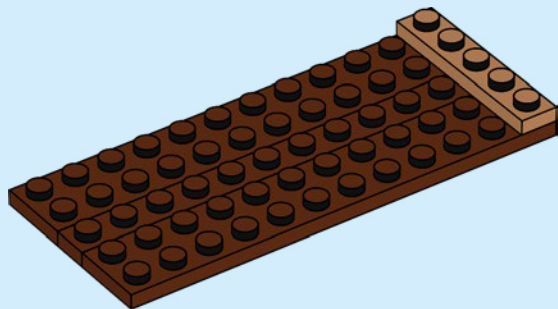

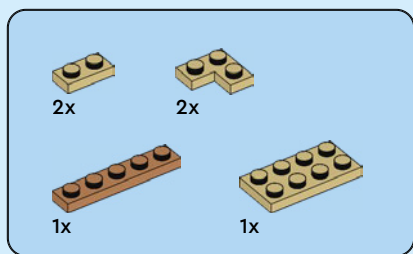

47

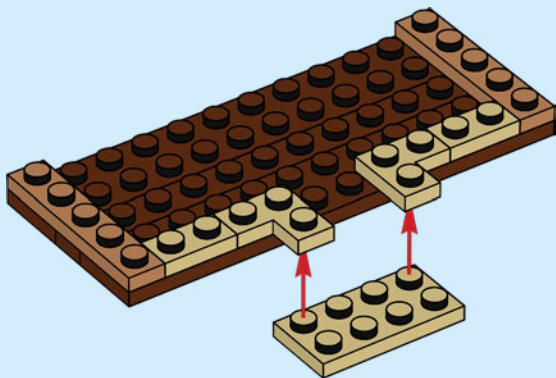



2x



2x

48

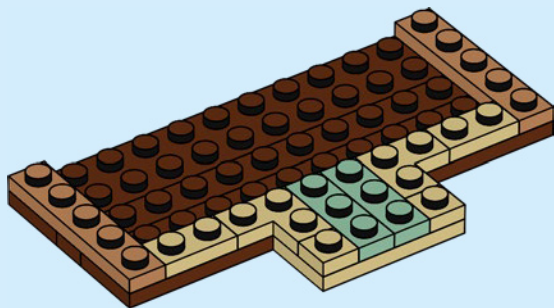

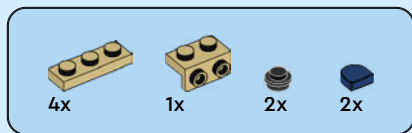

49

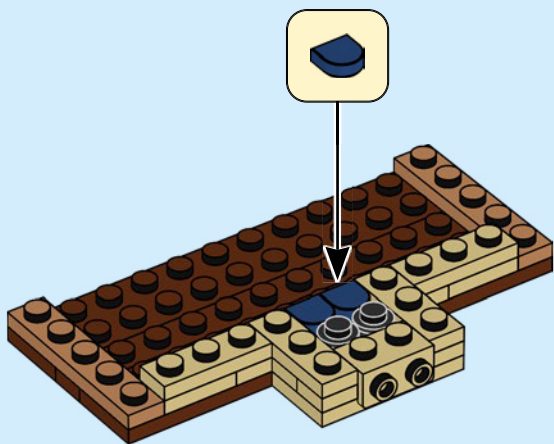

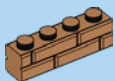

2x



2x

50

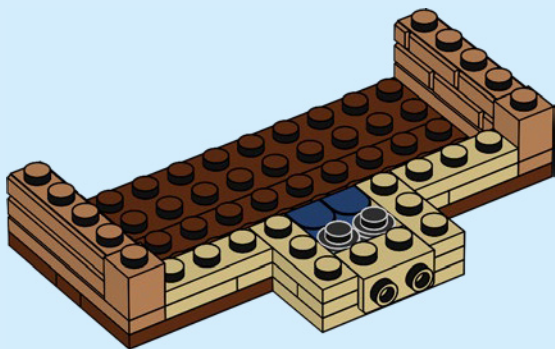

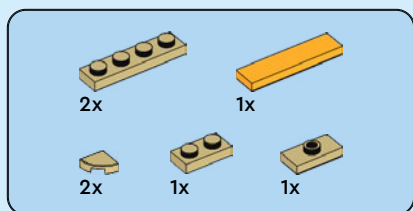

51

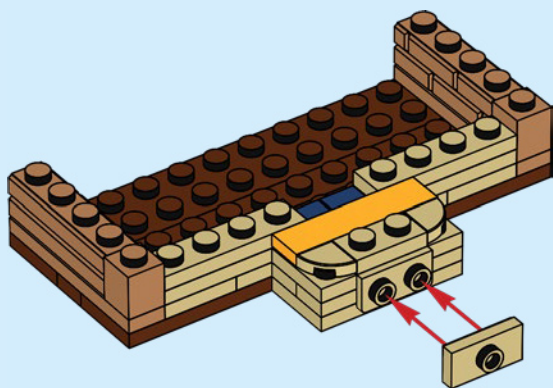



2x

52

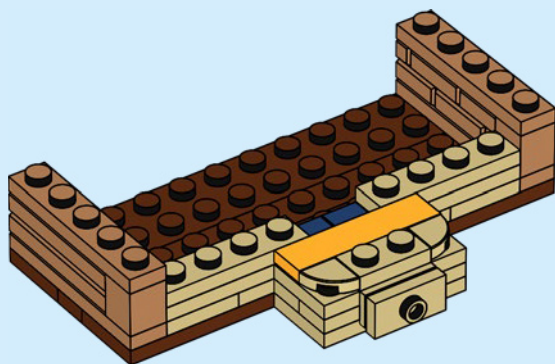

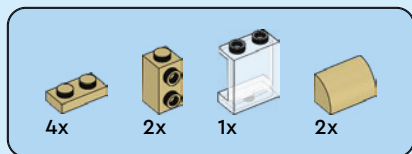

53

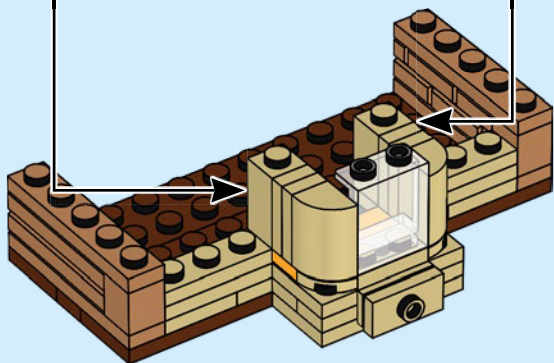
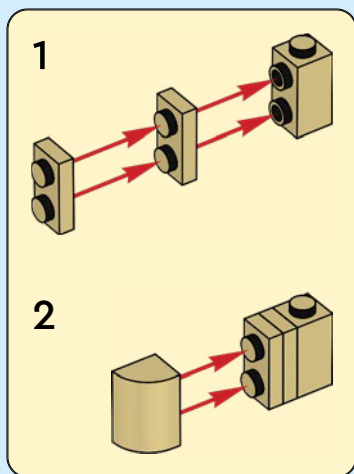
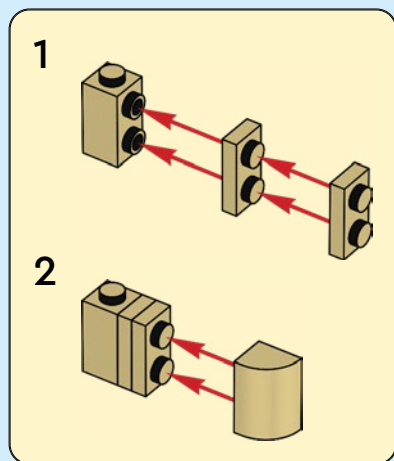

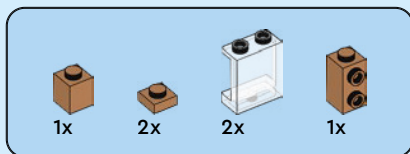

54

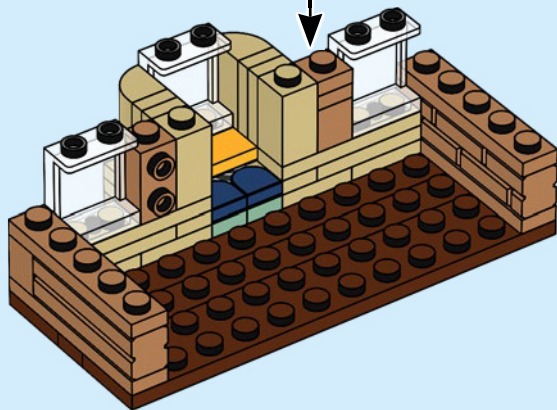
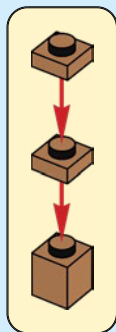

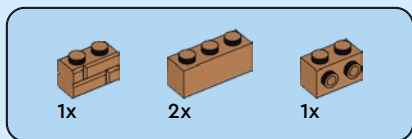

55

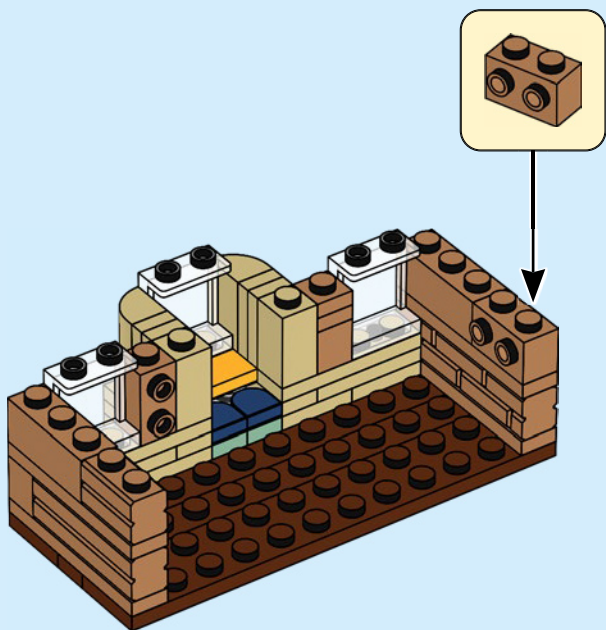



2x



2x



2x

56

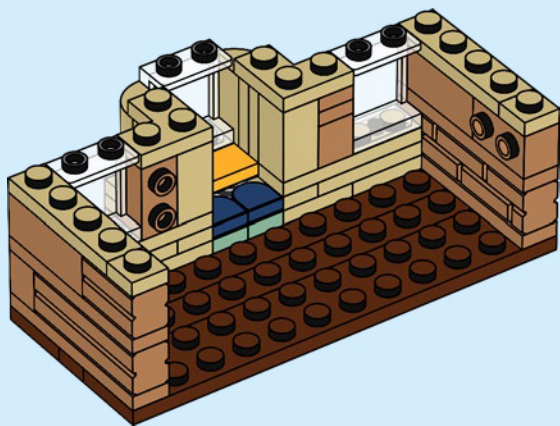

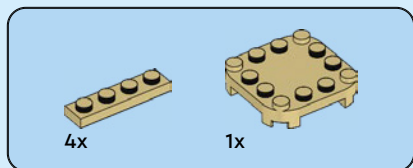

57

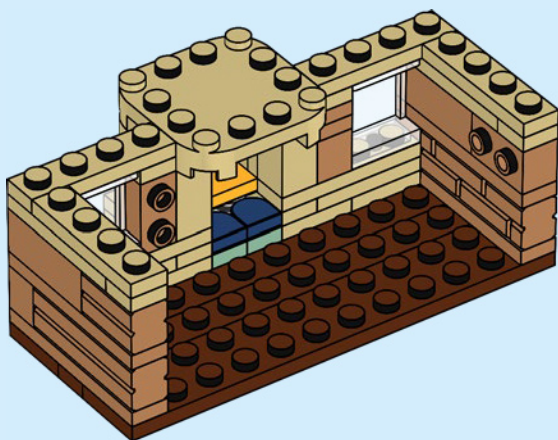

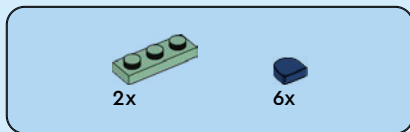

58

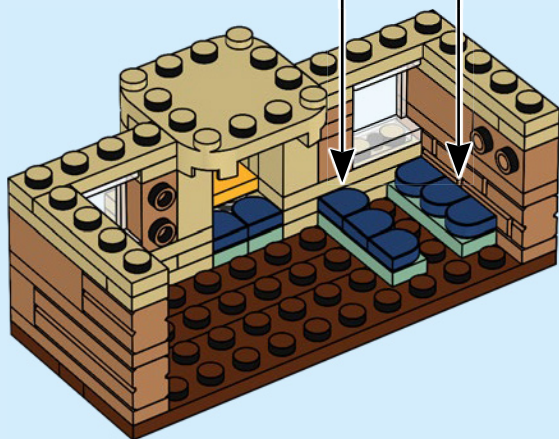
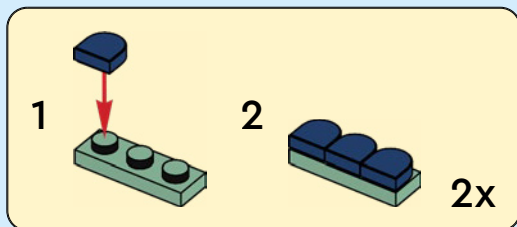



1x



2x

59

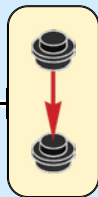
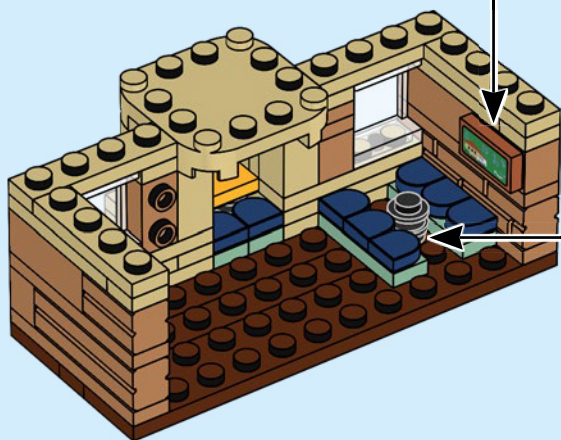
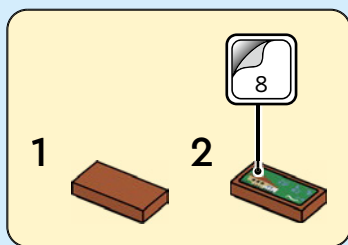

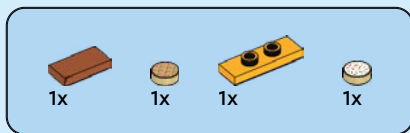

60

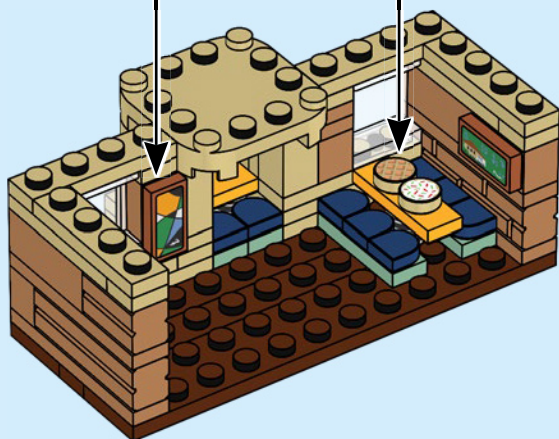
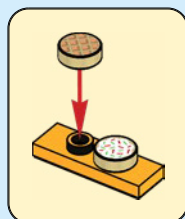
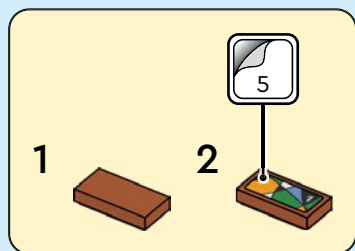

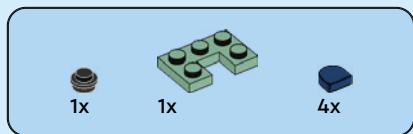

61

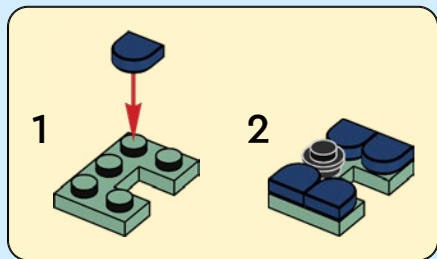

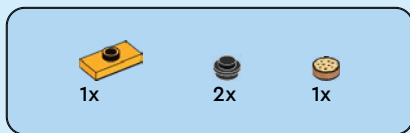

62

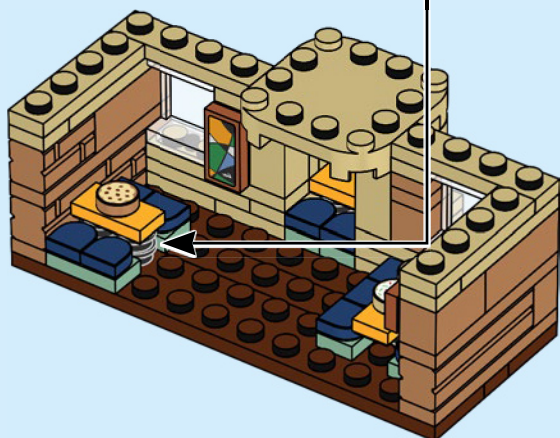
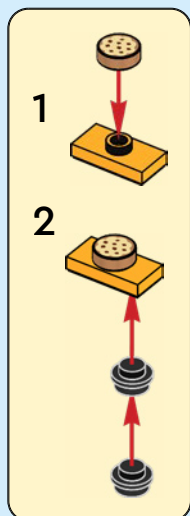



1x



2x



1x



1x

63

1

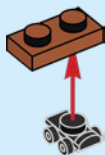

2



3

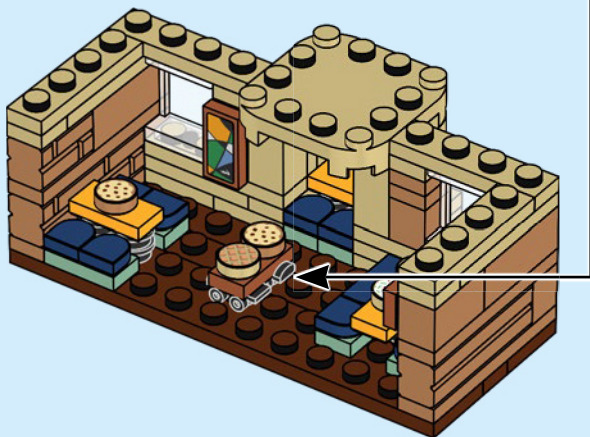



1x

64

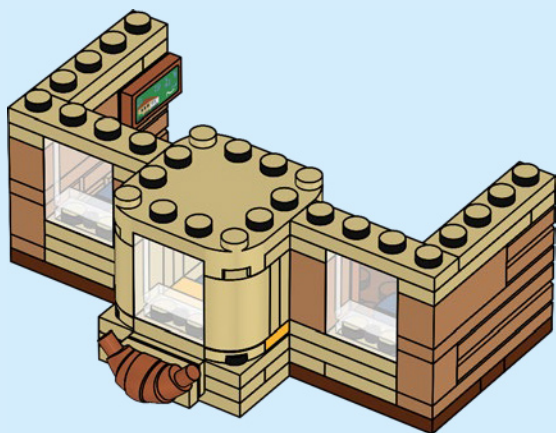

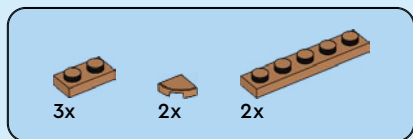

65

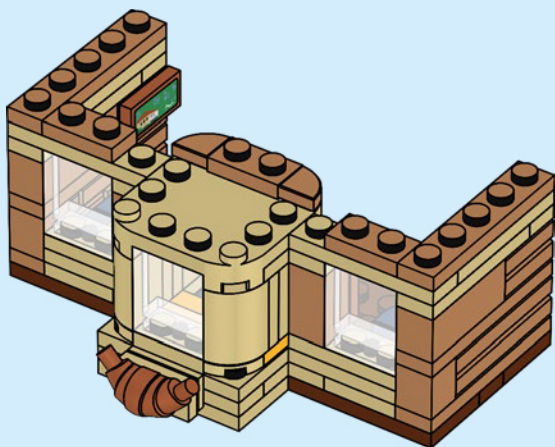

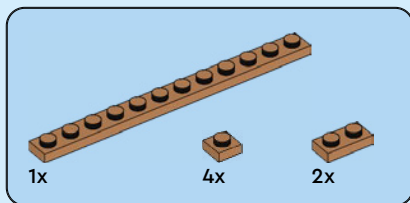

66

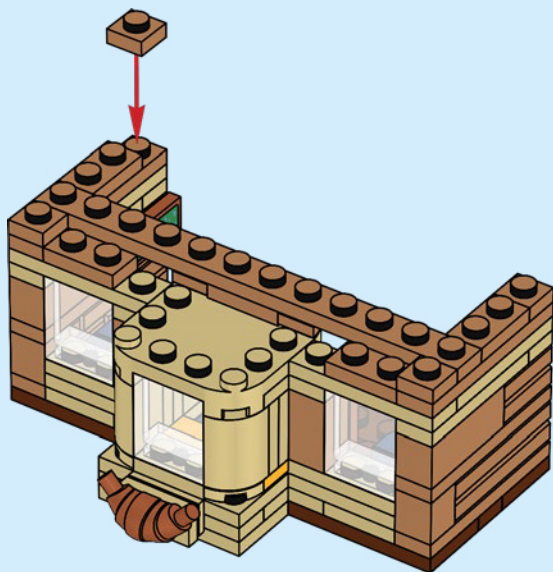



2x



4x

67

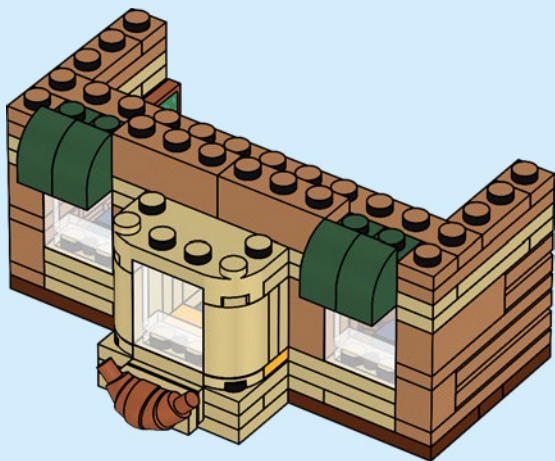

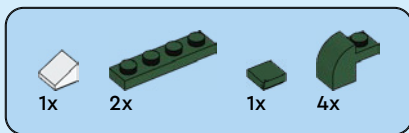

68

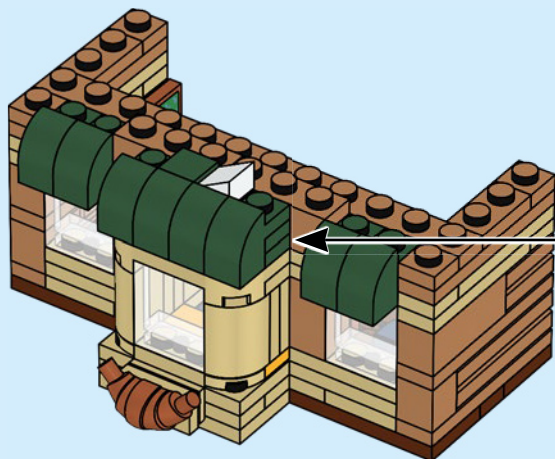
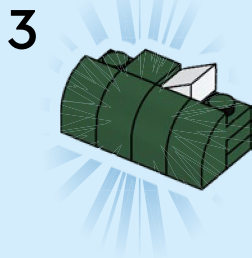
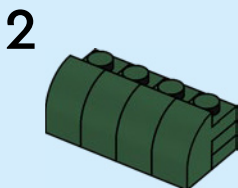
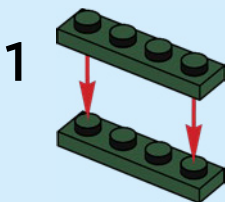

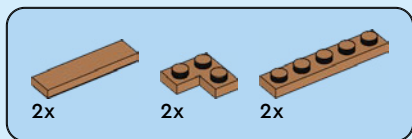

69

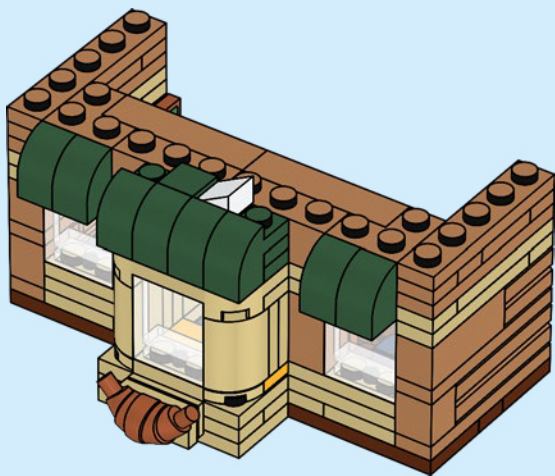

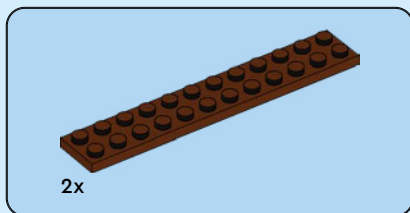

70

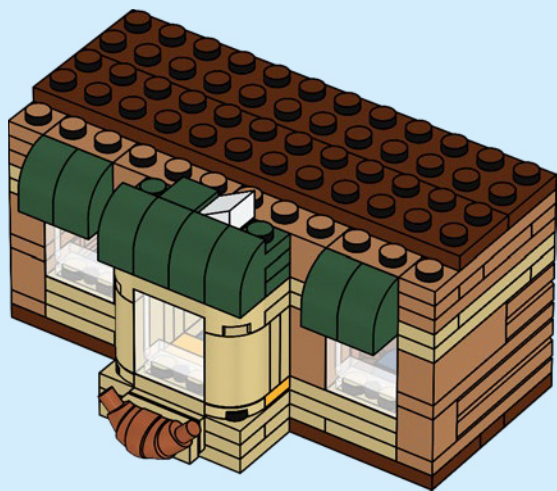



2x



4x



3x

71

1

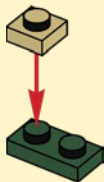

2

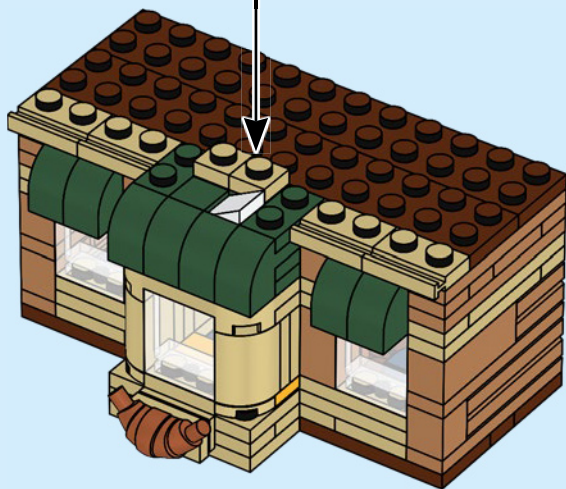
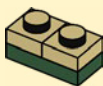

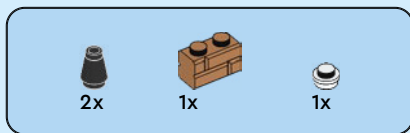

72

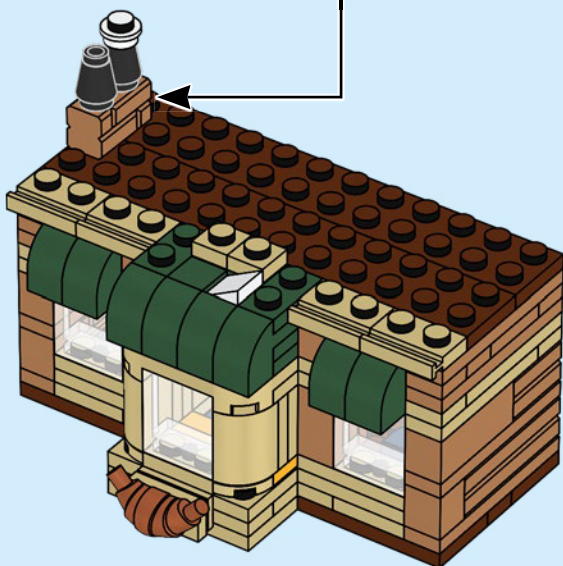
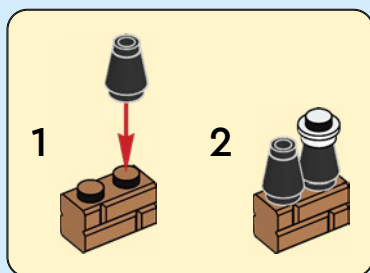



2x



4x



1x

73

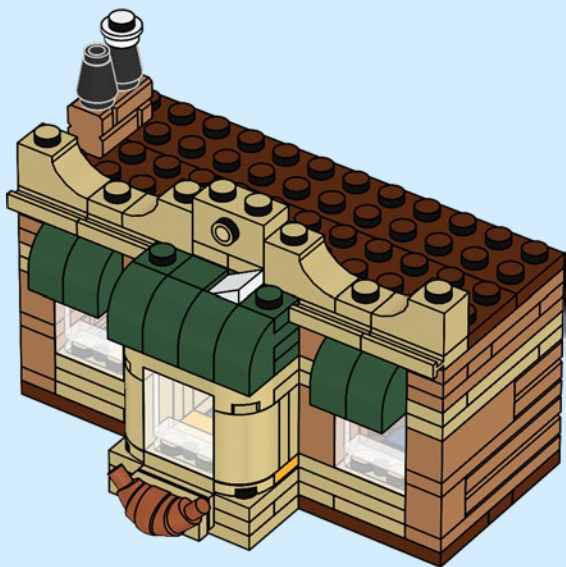

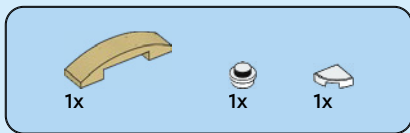

74

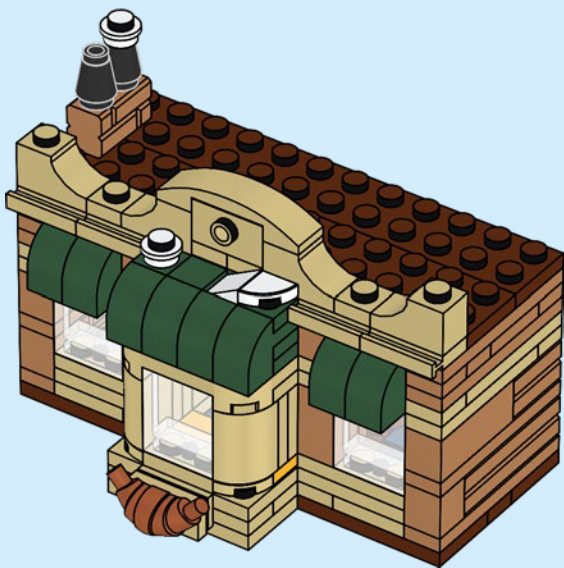



2x



4x

75

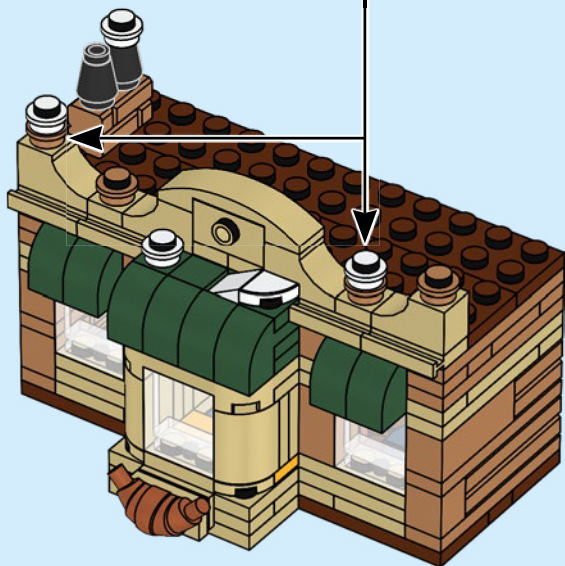
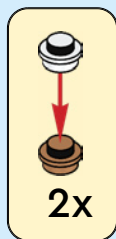



1x



2x

76

1



2



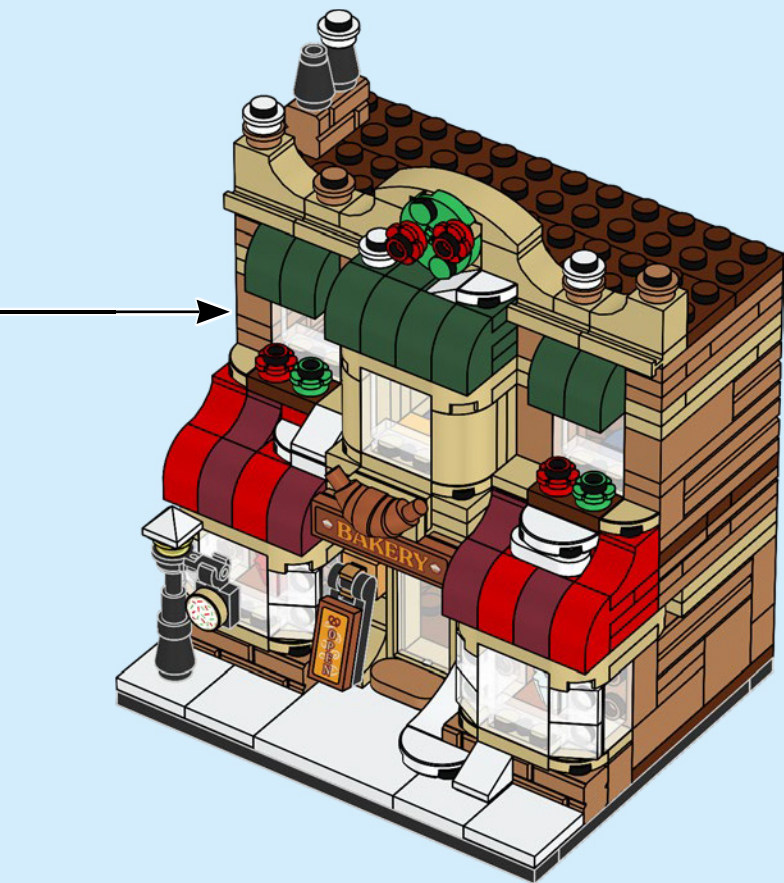





1x
6240216



12x
6444941



1x
6055171



3x
6013102



8x
6411352



2x
6020923



4x
6069257



1x
6432746



4x
6411330



2x
6364637



3x
4622062



1x
6122504



1x
6307254



1x
6072668



1x
6438899



2x
4211150



1x
4211181



3x
6370000



1x
6055145



4x
4225700



1x
6329583



2x
6469440



2x
4211395



1x
6262138



5x
6287854



4x
6167641



7x
6422082



10x
6057986



6x
6215606



4x
6248536



2x
6324205



1x
6507790



2x
4656783



16x
6218360



2x
6431328



1x
6411587



4x
6021997



4x
6177535



6x
6192922



2x
6365746



2x
6187006



6x
6055309



2x
6102998



10x
6343854



2x
6474197



1x
6361352

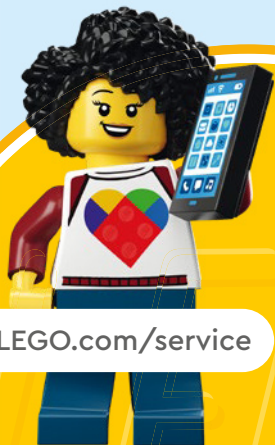

LEGO.com/service

YOU COULD

WIN



Scan this QR code or go to **LEGO.COM/PRODUCTFEEDBACK** and give us your short feedback about this LEGO® set for a chance to win a cool LEGO prize.

Terms and Conditions apply*

EN: YOU COULD WIN. Terms and Conditions apply* **DE: Du könntest GEWINNEN.** Es gelten die Teilnahmebedingungen* **FR: Tu pourrais GAGNER.** Des conditions s'appliquent* **IT: Potresti VINCERE tu.** Termini e condizioni sono applicabili* **ES: Puedes GANAR.** Aplican términos y condiciones* **PT: Poderá GANHAR.** Aplicam-se termos e condições* **ZH: 轻松获奖. 条款和条件适用*** **PL: Szansa na WYGRANĄ.** Obowiązują warunki korzystania* **CS: Máte šanci VYHRÁT.** Platí všeobecné smluvní podmínky* **SK: Máte šancu VYHRAŤ.** Platia všeobecné zmluvné podmienky* **HU: TE IS NYERHETSZ.** Felhasználási feltételek érvényesek* **RO: Ai putea CÂȘTIGA.** Se aplică termenii și condiții* **BG: Можете да СПЕЧЕЛИТЕ.** Има определени правила и условия* **LV: Tu vari LAIMĒT.** Ir spēkā noteikumi un nosacījumi.* **ET: Sul on võimalus VÕITA.** Kehtivad tingimused* **LT: Jūs galite LAIMĖTI.** Taikomos sąlygos*

*[LEGO.com/productfeedback-terms](https://www.lego.com/productfeedback-terms)

LEGO and the LEGO logo are trademarks of the/son des marques de commerce du/son marcas registradas de LEGO Group. ©2024 The LEGO Group.