



CREATOR™

40697





Get excited about our new packaging!

We're switching from plastic to paper-based packaging. That's why you might find a mix of paper and plastic in our boxes!

Nos nouveaux emballages vous emballeront !

Nous passons des emballages en plastique aux emballages à base de papier. C'est pourquoi vous pourriez trouver un mélange de papier et de plastique dans nos boîtes !

¡Te presentamos nuestros nuevos empaques!

Estamos sustituyendo las bolsas de plástico por bolsas con base de papel. ¡Por eso, puedes encontrar una mezcla de papel y de plástico en nuestras cajas!

[LEGO.com/sustainable-packaging](https://www.lego.com/sustainable-packaging)



Q LEGO® Builder

BUILDER



Apple and the Apple logo are trademarks of Apple Inc., registered in the U.S. and other countries and regions. App Store is a service mark of Apple Inc. Google Play and the Google Play logo are trademarks of Google LLC. Tencent and the Tencent logo are trademarks of Tencent Inc.

Q [LEGO.com/devicecheck](https://www.lego.com/devicecheck)

EN Ask parents' permission before going online | **DE** Eltern um Erlaubnis bitten, bevor du online gehst | **FR** Demande l'autorisation d'un parent avant d'aller en ligne | **IT** Chiedi il permesso ai tuoi genitori prima di andare online | **ES** Pídeles permiso a tus papás antes de conectarte a Internet | **PT** Pede autorização aos pais antes de acederes online | **ZH** 上网前应先征得父母的同意 | **PL** Poproś rodziców o zgodę, zanim wejdiesz do Internetu | **CS** Než půjdeš na internet, požádej rodiče o svolení | **SK** Skôr než pôjdeš na internet, vypýtaj si povolenie od rodičov | **HU** Kérj szülői engedélyt, mielőtt online csatlakoznál! | **RO** Cere permisiunea părinților înainte de a te conecta online | **BG** Поискайте разрешение от родител, преди да влезете онлайн | **LV** Pirms došanās tiešsaistē palūdz atļauju vecākiem | **ET** Enne Interneti kasutamist küsi vanematelt luba | **LT** Prieš prisijungdami prie interneto, atsiklauskite tėvų



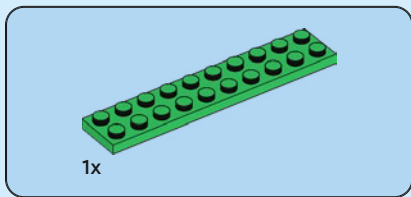

1

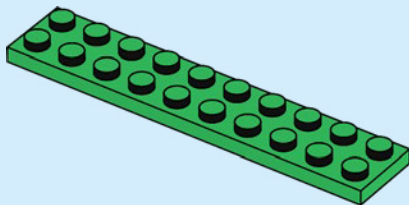

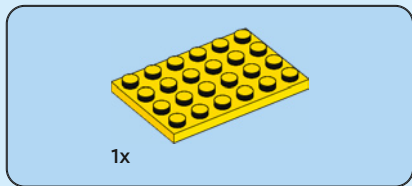

2

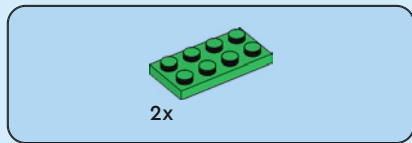
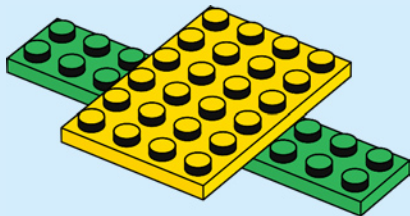

3

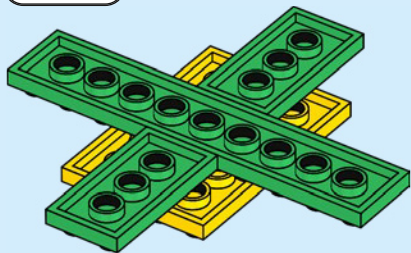



4x

4

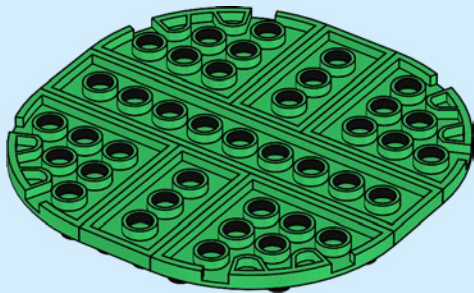

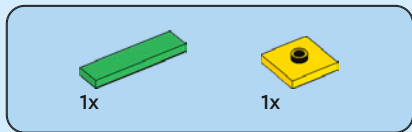

5

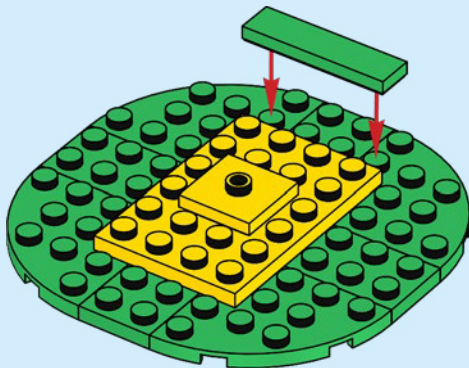

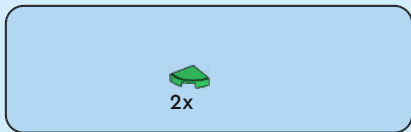

6

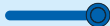
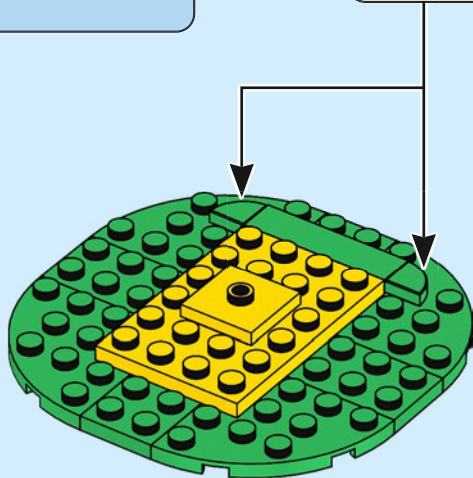

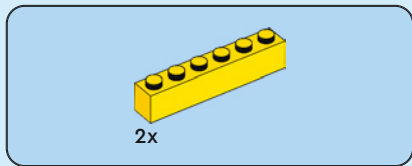

7

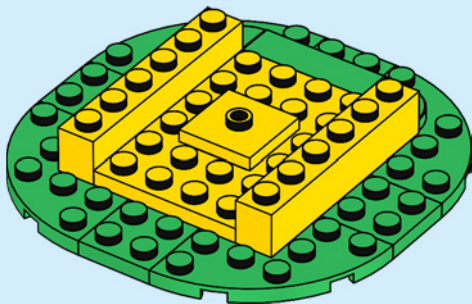



6x

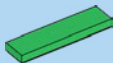

3x

8

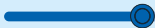
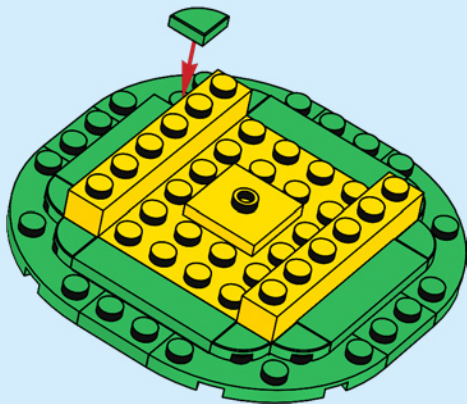

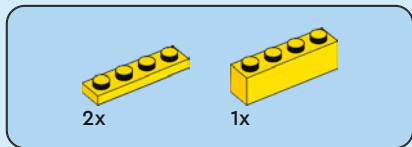

9

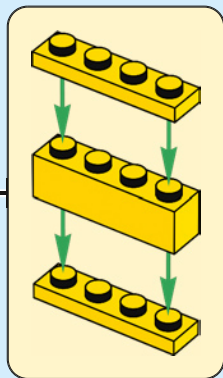
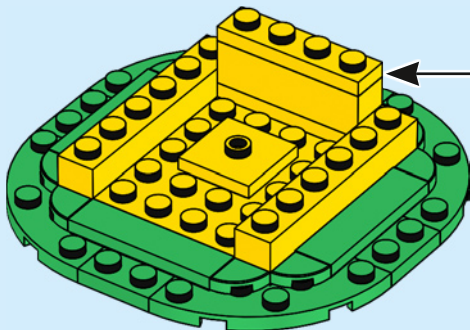

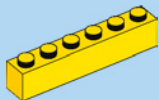

2x

10

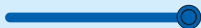
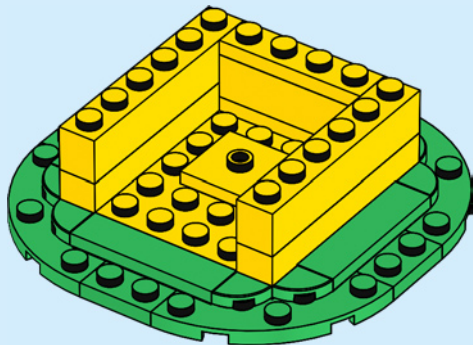



7x

11

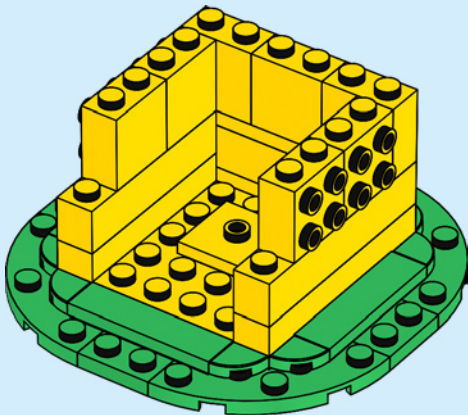



2x

12



2x

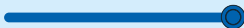
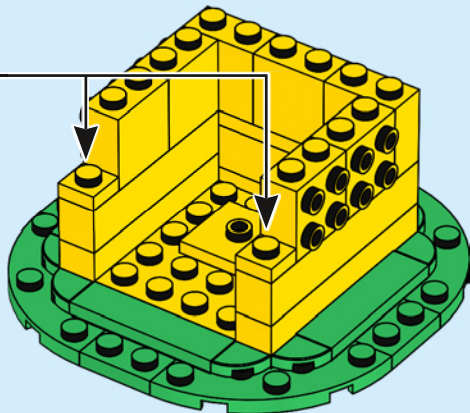

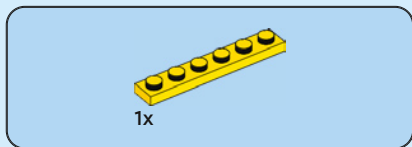

13

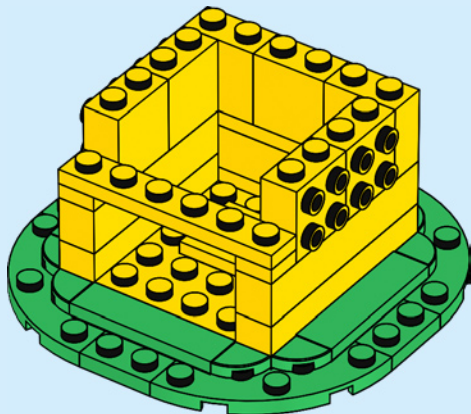



2x

14

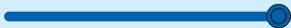
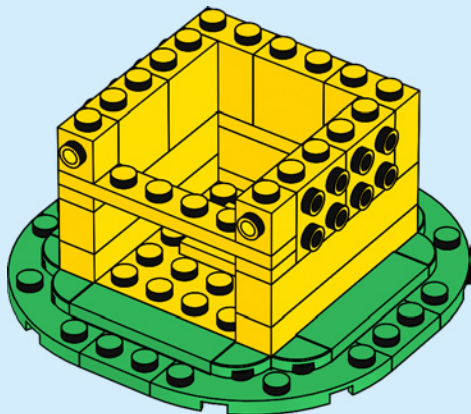



3x



2x

15

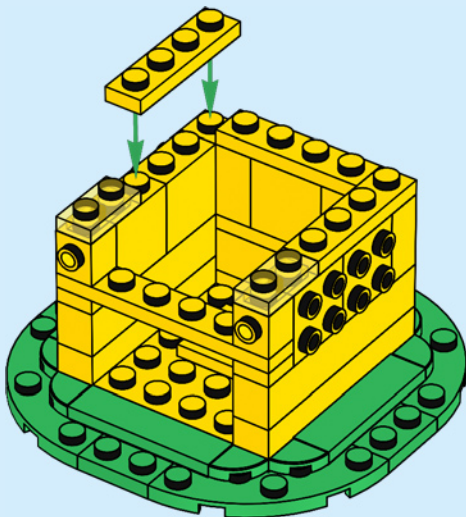



1x



1x

16

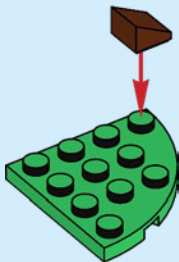



1x



1x



1x

17

1

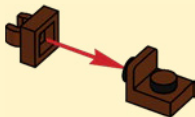

2

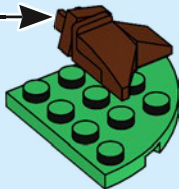



1x



1x

18



1x



1x

19

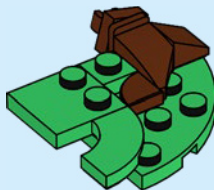



2x

20



21

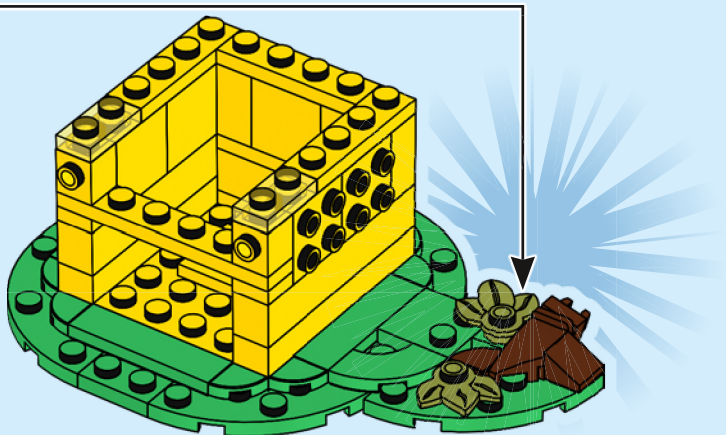



1x

22

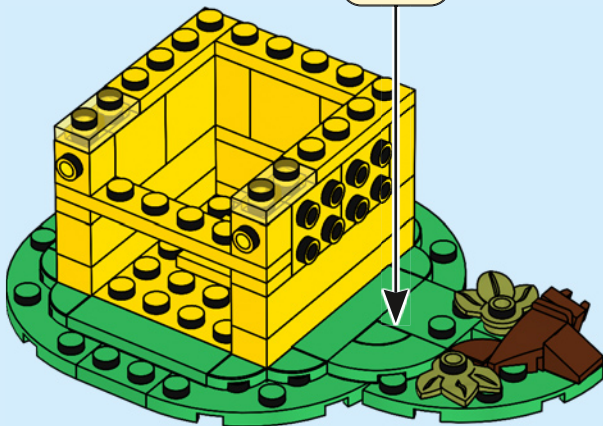



2x



1x

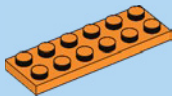

1x

23

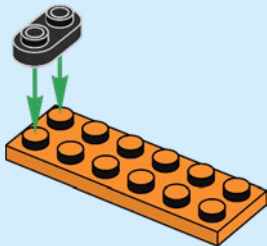

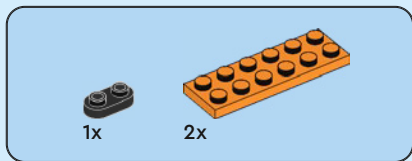

24

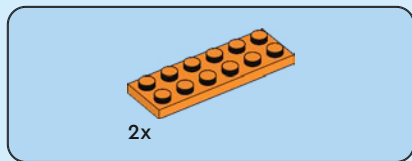
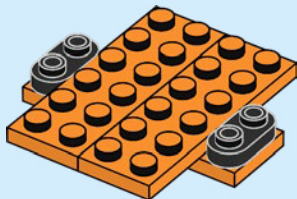

25

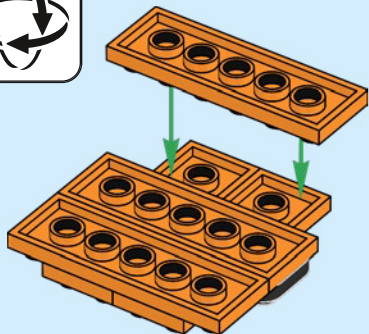
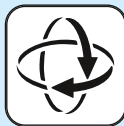



1x

26

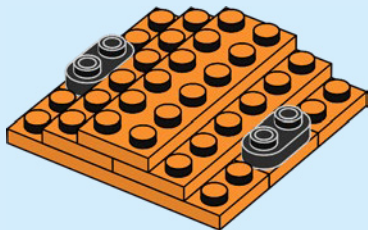

26



1x



2x

27

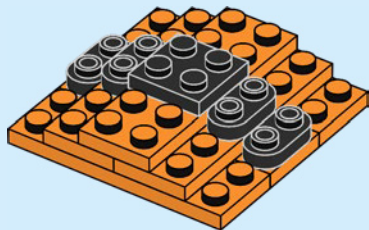



6x

28

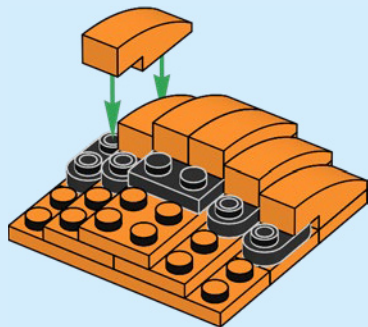

6x

29

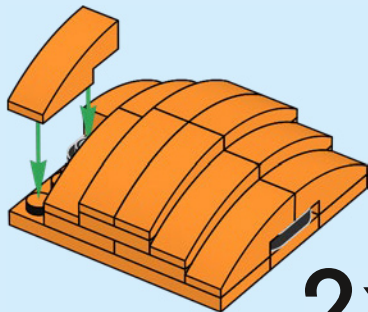

2x

30

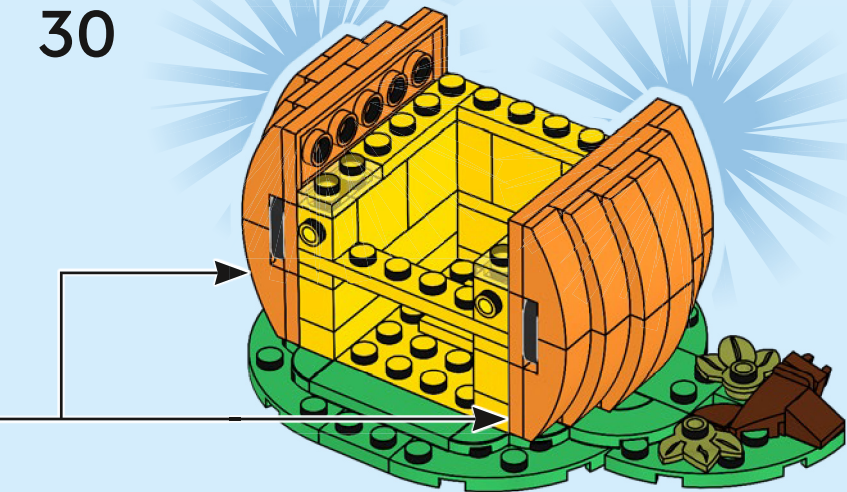

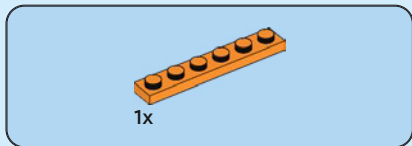
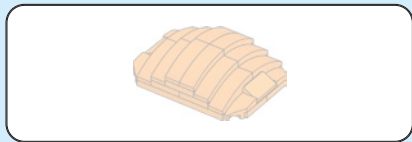

31

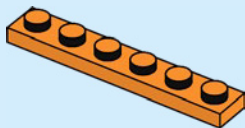

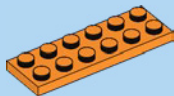

2x

32

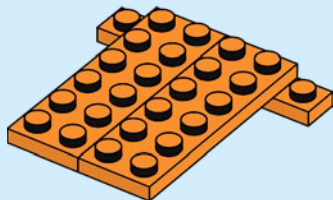

1x

33

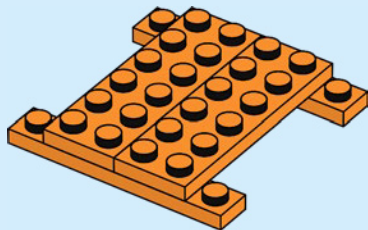

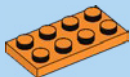

4x

34

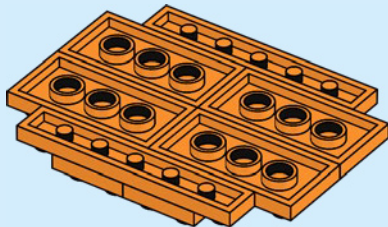

1x

35

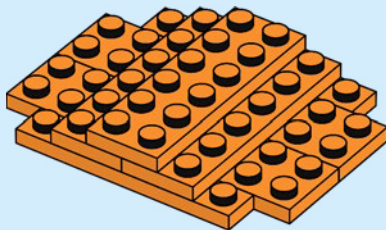
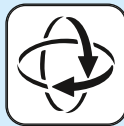



4x



1x

36

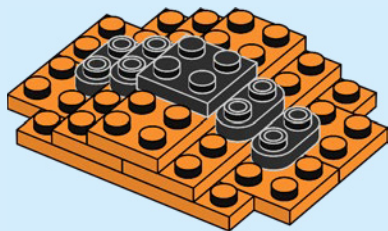

2x



2x



2x

37

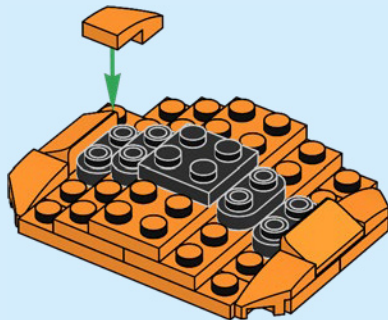



6x

38

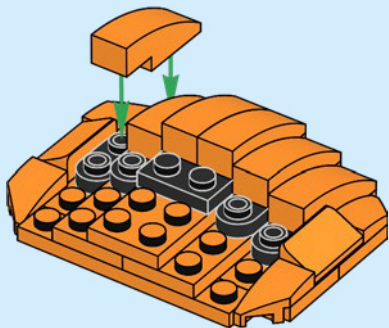

6x

39

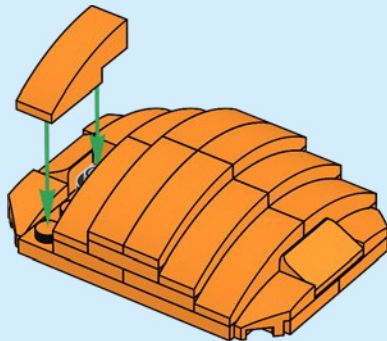

40

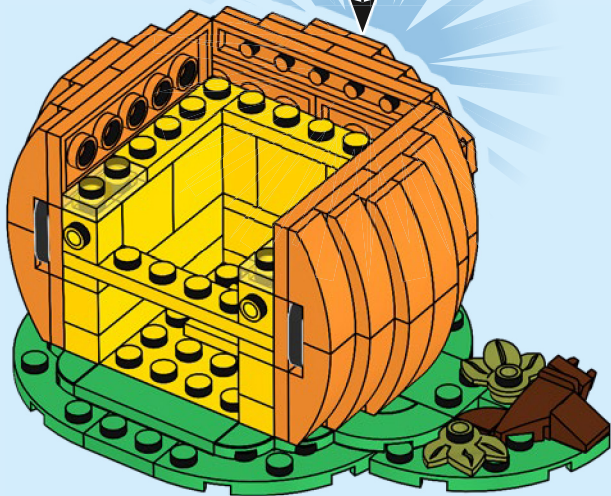

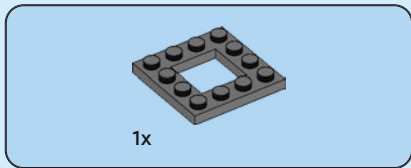
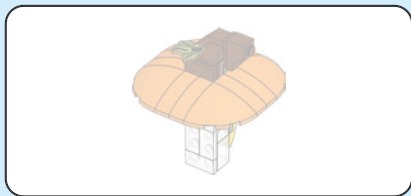

1x

41

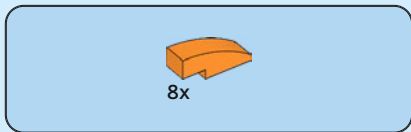
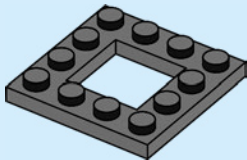

8x

42

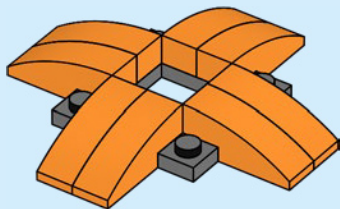



4x

43

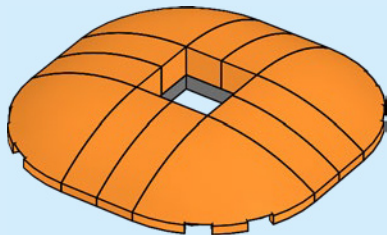

36



1x



2x

44

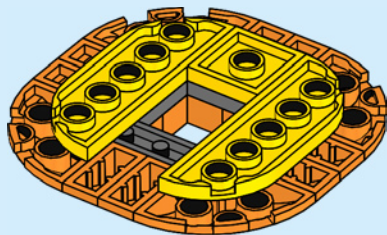

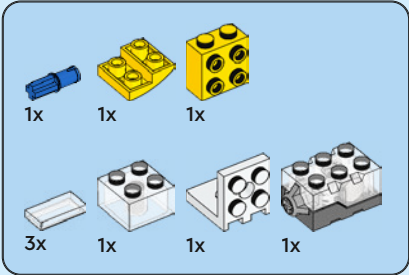
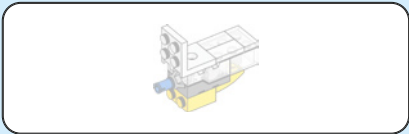

45

1

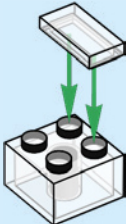

2

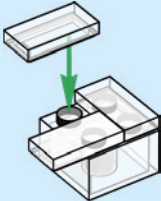

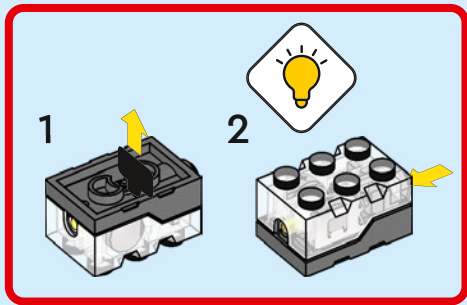

3

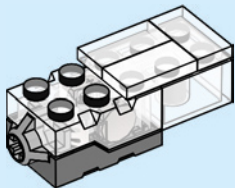

4

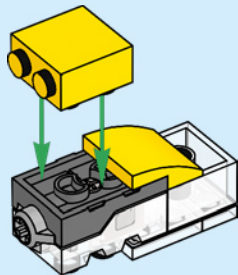

5

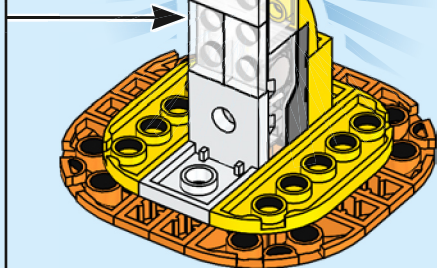
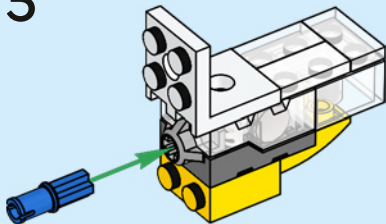



1x



1x

46

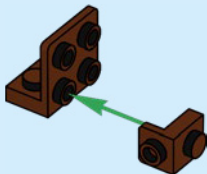

1x

47

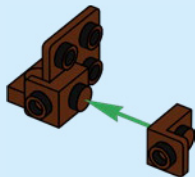



1x

48

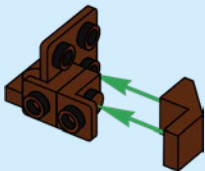

1x



1x

49





1x

50

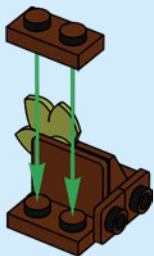

1x

51





1x

52



1x

53

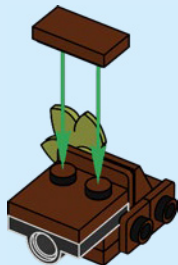



1x

54

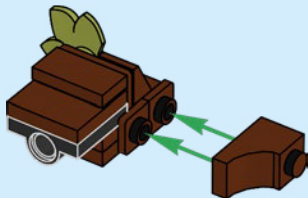

55

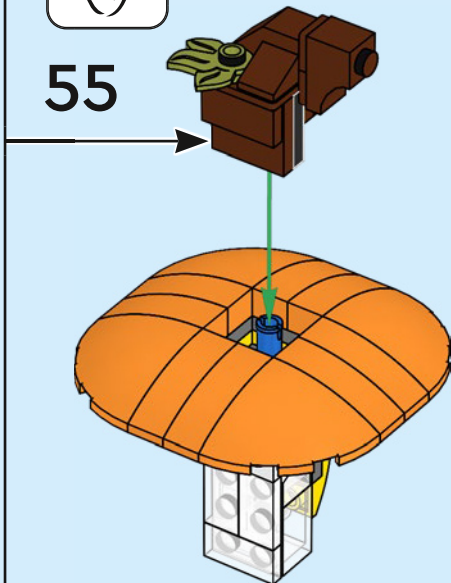

56

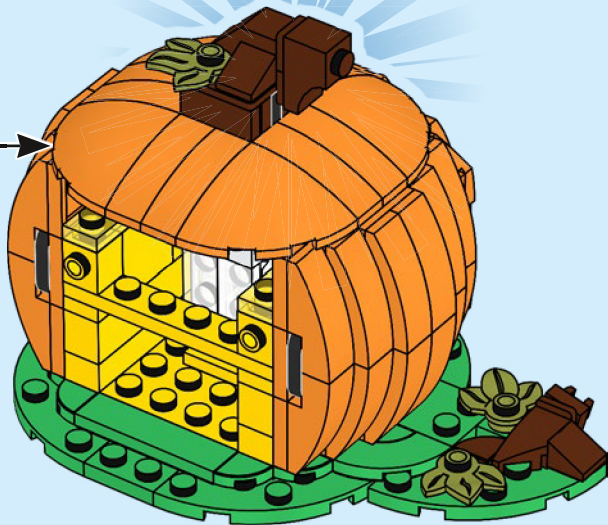



1x

57



2x

58





1x

59



2x



1x

60

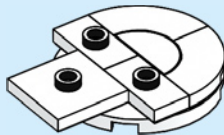



1x

61

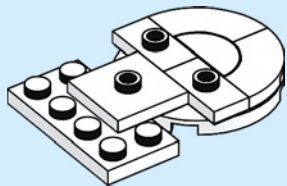

2x

62

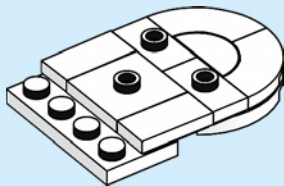



1x



1x



1x

63

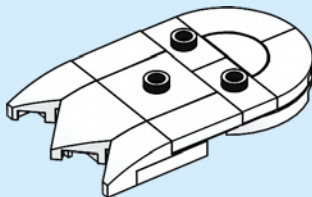

1x



2x

64

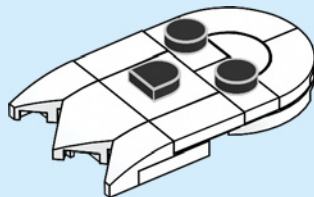

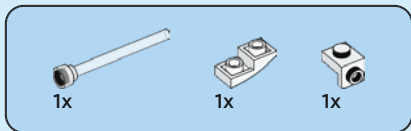

65

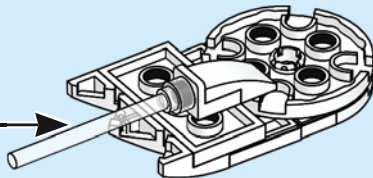
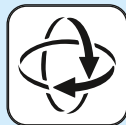
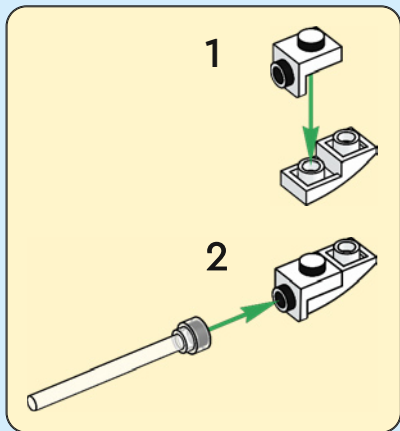

66

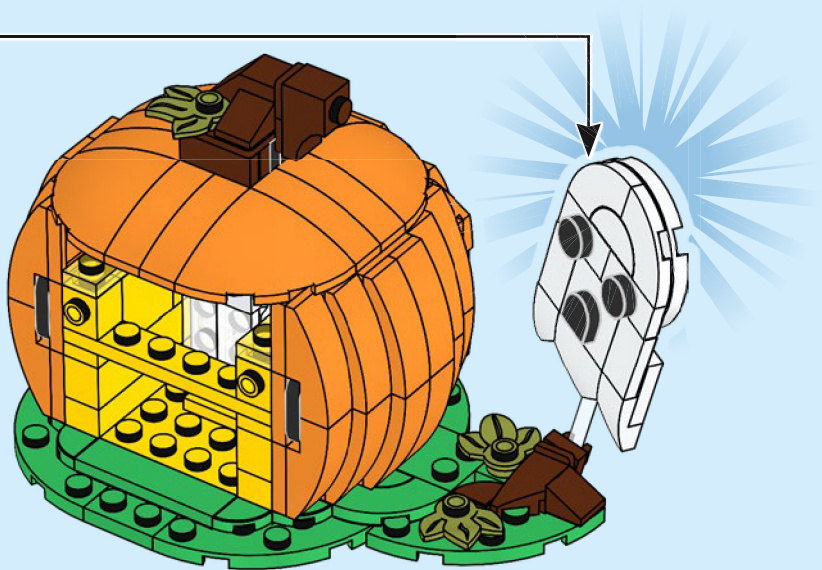



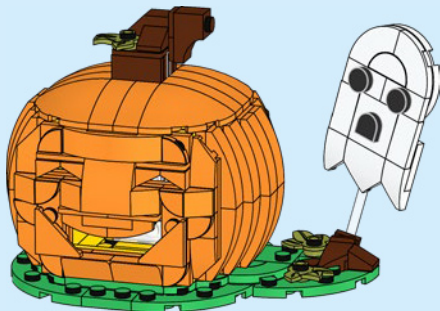
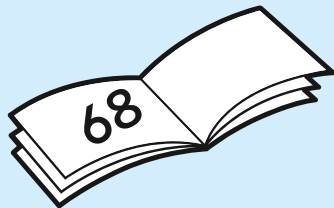
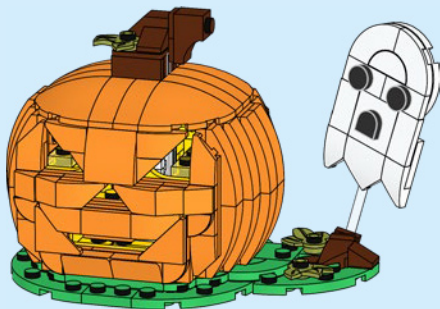

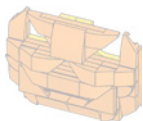

1x



1x

67

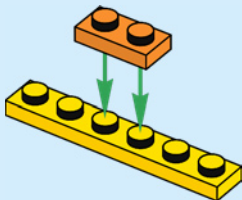

2x

68

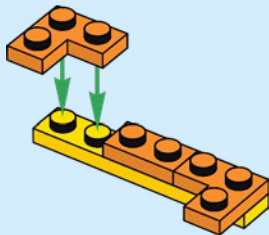



2x



2x

69

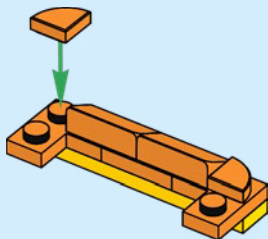

2x

70

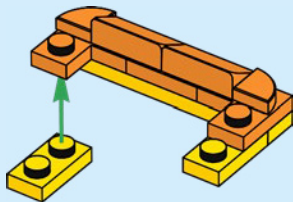

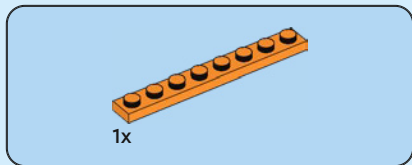

71

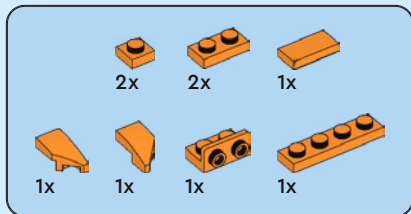
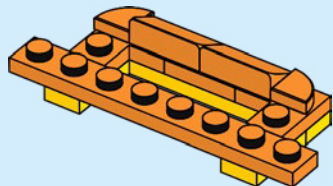

72

1

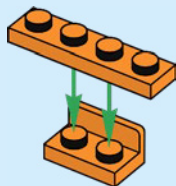

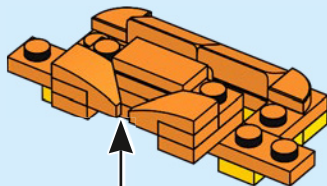
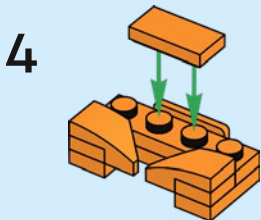
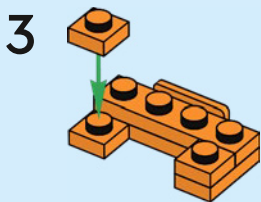
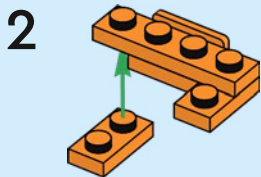



2x

73

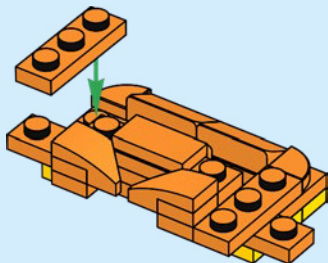

2x

74

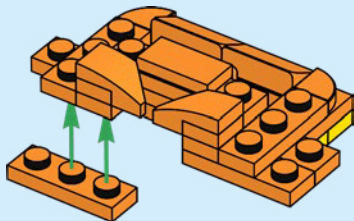



1x



1x

75

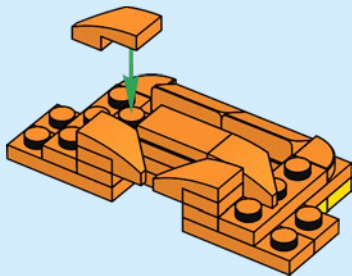

2x

76

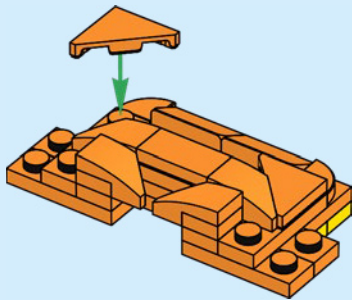



2x

77

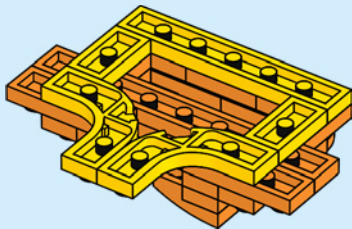

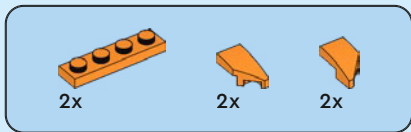

78

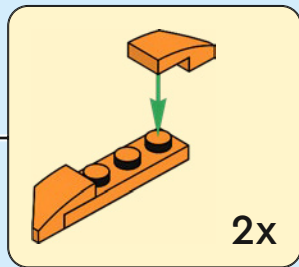
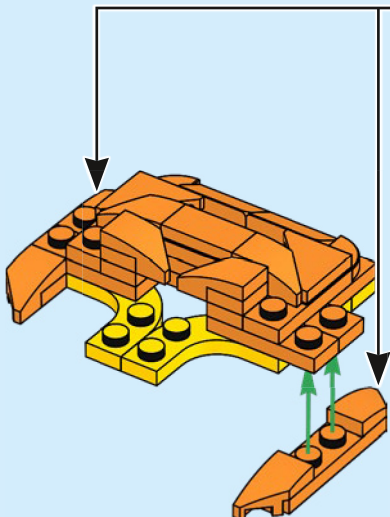



2x

79

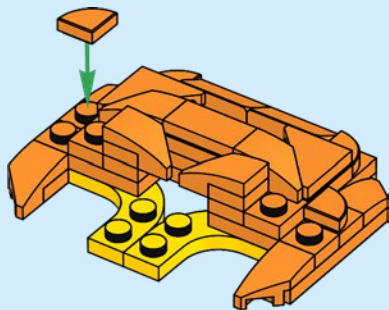

4x



1x

80

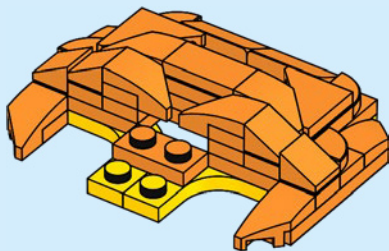



1x



1x

81

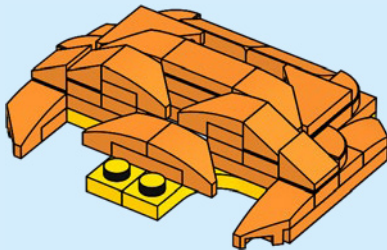



1x



1x



1x

82

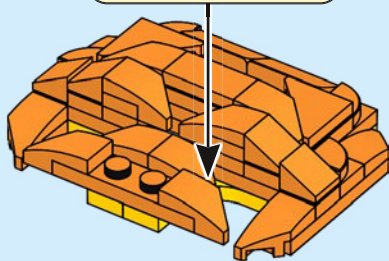
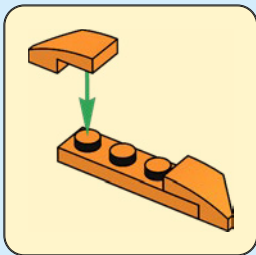

83



1x

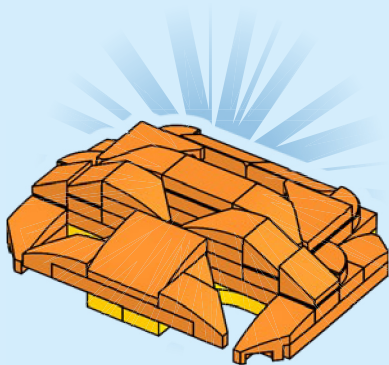

84

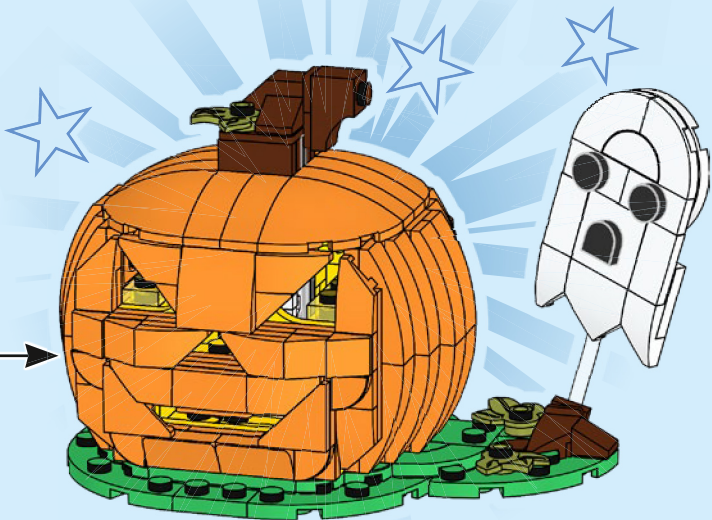

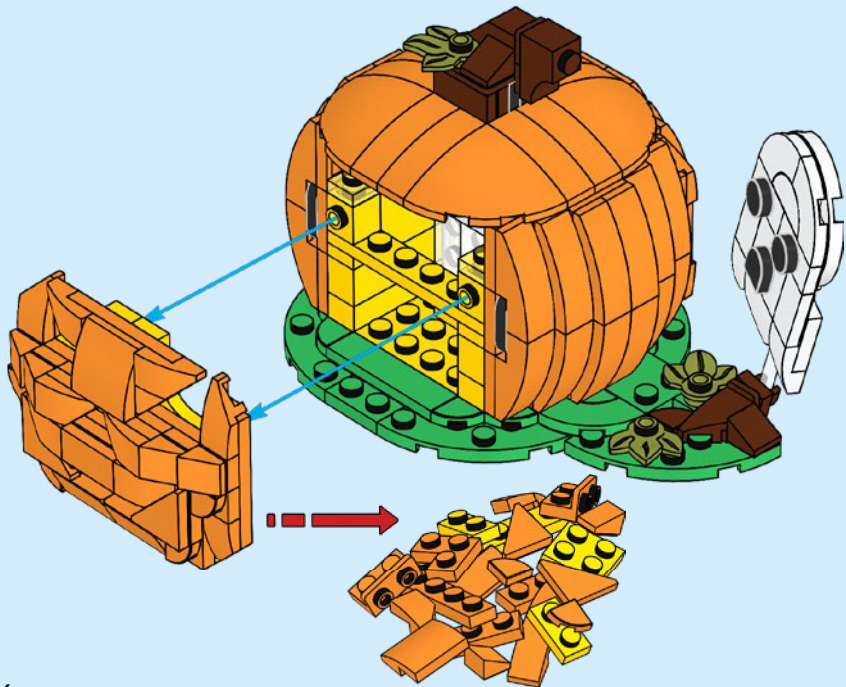

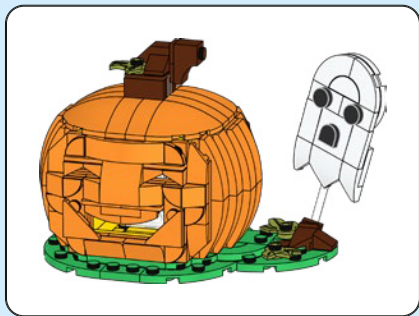

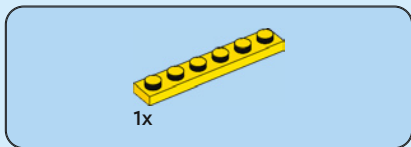

1

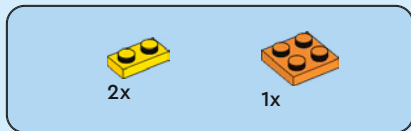
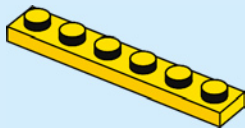

2

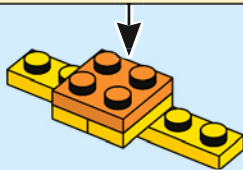
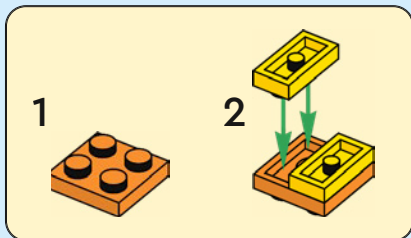



1x

3

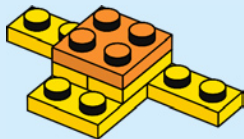

4x



2x

4

1



2



2x

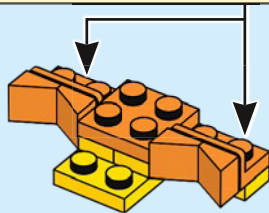



2x



1x

5

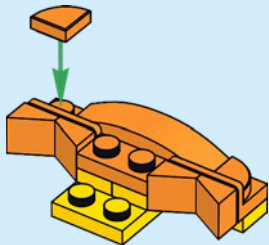

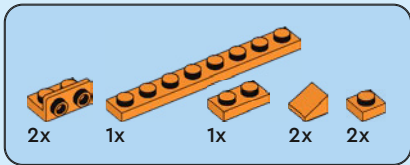
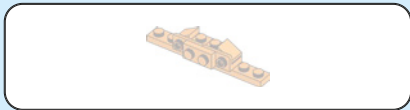

6

1

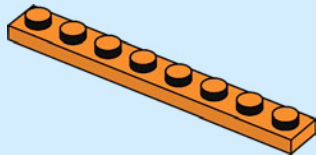

2

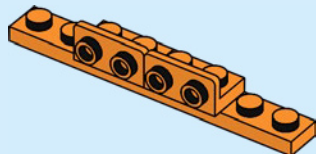

3

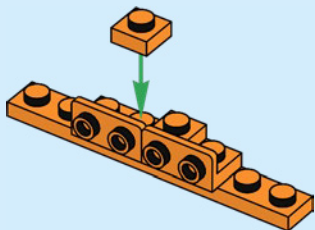

4

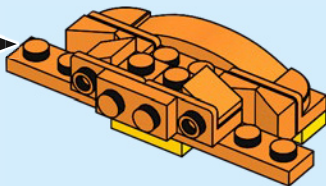
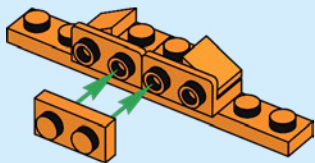



1x

7

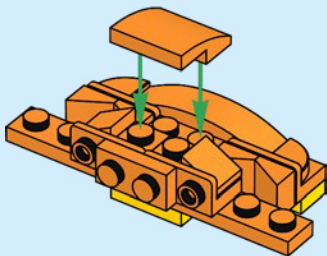

1x



1x

8

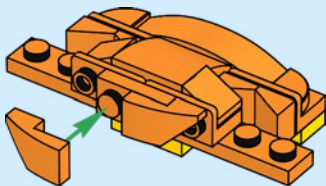

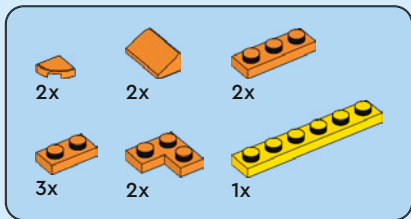

9

1

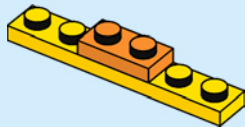

2

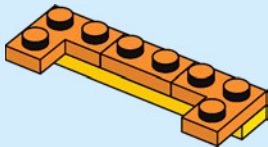

3

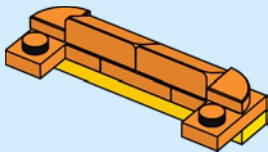

4

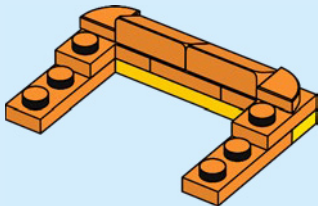

5

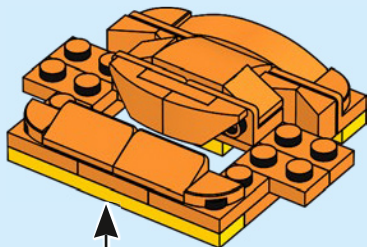
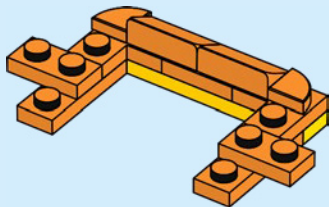



2x

10

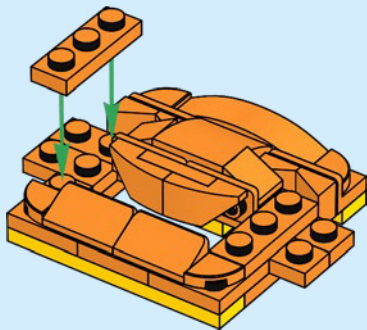



2x



2x

11

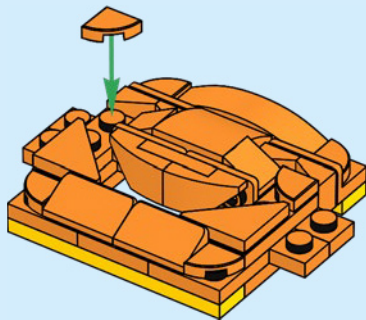



2x



2x



2x

12

1

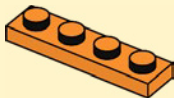

2

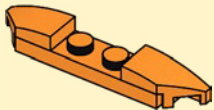

2x

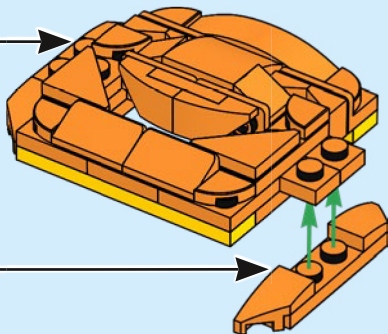



2x



2x

13

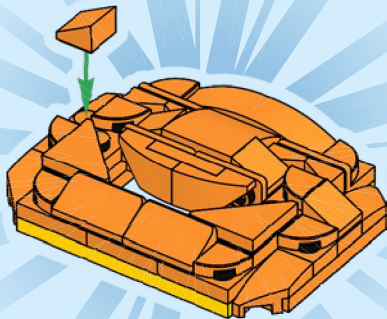

14

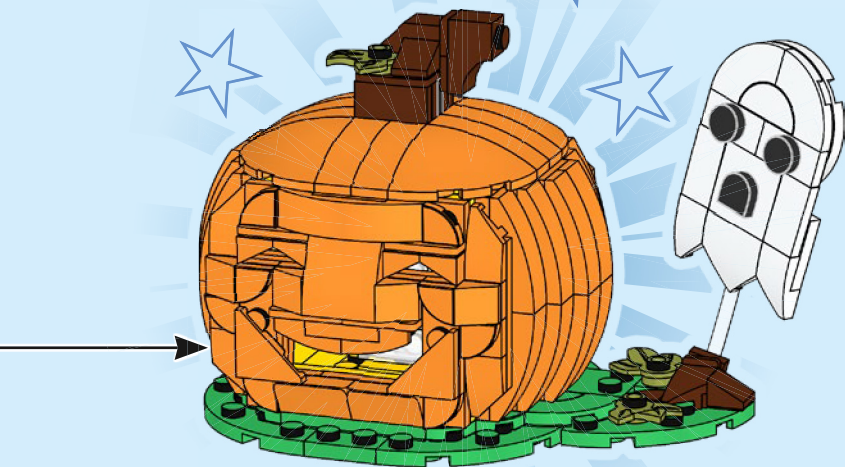

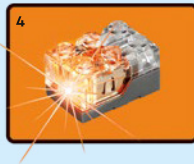

1:1
2x LR 41 1.5V



1x
6213880



1x
6296132



1x
6510068



1x
6213881



2x
6051511



1x
6301907



1x
6172927



2x
306901



2x
6172674



1x
6126046



1x
6313593



1x
4515347



1x
302001



1x
4206482



1x
6186825



2x
302324



8x
6313592



1x
6126050



2x
302224



1x
6411332



5x
371024



1x
301024



2x
4624985



2x
302424



2x
6308390



2x
6116475



3x
366624



4x
300924

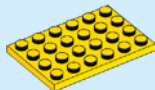

1x
303224



9x
6150607



1x
302428



1x
6505153



1x
6365611



4x
243128



2x
302028



5x
6038682

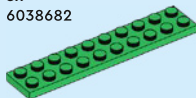

1x
383228



2x
6284070



1x
6256435



12x
6210270



3x
302226



1x
6061032



3x
6398008

8x
6173925



8x
6177499



8x
4504371



2x
4524929



8x
6177490



4x
6068996



1x
4188771



4x
4177932



4x
6218368

2x
6346092



2x
6106027



1x
6067913



1x
4159007



4x
6441091



4x
6147047



44x
4251969



4x
4118782

1x
4650977



4x
4158355



2x
4173332



15x
4121741



1x
6210229



1x
6149677



2x
4504376

1x
6290397



1x
6348057



2x
6238874



1x
6401027



1x
6365885



1x
6248854



1x
4211151



1x
4211150

1x
6226436



1x
6196221



2x
6240211



1x
6429472

3x
6251294



1x
6239418



1x
6166111



 [LEGO.com/service](https://www.lego.com/service)

YOU COULD
WIN



Scan this QR code or go to
LEGO.COM/PRODUCTFEEDBACK and give us
your short feedback about this LEGO® set
for a chance to win a cool LEGO prize.

Terms and Conditions apply*

EN: YOU COULD WIN. Terms and Conditions apply* **DE: Du könntest GEWINNEN.** Es gelten die Teilnahmebedingungen* **FR: Tu pourrais GAGNER.** Des conditions s'appliquent* **IT: Potresti VINCERE tu.** Termini e condizioni sono applicabili* **ES: Puedes GANAR.** Aplican términos y condiciones* **PT: Poderá GANHAR.** Aplicam-se termos e condições* **ZH: 轻松获奖.** 条款和条件适用* **PL: Szansa na WYGRANĄ.** Obowiązują warunki korzystania* **CS: Máte šanci VYHRÁT.** Platí všeobecné smluvní podmínky* **SK: Máte šancu VYHRÁT.** Platia všeobecné zmluvné podmienky* **HU: TE IS NYERHETSZ.** Felhasználási feltételek érvényesek* **RO: Ai putea CÂȘTIGA.** Se aplică termenii și condiții* **BG: Можете да СПЕЧЕЛИТЕ.** Има определени правила и условия* **LV: Tu vari LAIMĒT.** Ir spēkā noteikumi un nosacījumi.* **ET: Sul on võimalus VÕITA.** Kehtivad tingimused* **LT: Jūs galite LAIMĖTI.** Taikomos sąlygos*

*[LEGO.com/productfeedback-terms](https://www.lego.com/productfeedback-terms)

LEGO and the LEGO logo are trademarks of the/son des marques de commerce du/
son marcas registradas de LEGO Group. ©2024 The LEGO Group.

6535989