



CREATOR™

40697





[LEGO.com/sustainable-packaging](https://www.lego.com/sustainable-packaging)



**FR**  
**DONNEZ**  
OU  
**RECYCLEZ**

 OU  OU 

ASSOCIATION    MAGASIN    DÉCHÈTERIE

Adresses sur [quefairedemesdechets.fr](https://quefairedemesdechets.fr)



Q LEGO® Builder

# BUILDER



Apple and the Apple logo are trademarks of Apple Inc., registered in the U.S. and other countries and regions. App Store is a service mark of Apple Inc. Google Play and the Google Play logo are trademarks of Google LLC. Tencent and the Tencent logo are trademarks of Tencent Inc.

Q [LEGO.com/devicecheck](https://www.lego.com/devicecheck)

**EN** Ask parents' permission before going online | **DE** Eltern um Erlaubnis bitten, bevor du online gehst | **FR** Demande l'autorisation d'un parent avant d'aller en ligne | **IT** Chiedi il permesso ai tuoi genitori prima di andare online | **ES** Pídeles permiso a tus papás antes de conectarte a Internet | **PT** Pedir autorização aos pais antes de acederes online | **ZH** 上网前应先征得父母的同意 | **PL** Poproś rodziców o zgodę, zanim wejdiesz do Internetu | **CS** Než půjdeš na internet, požádej rodiče o svolení | **SK** Skôr než pôjdeš na internet, vypýtaj si povolenie od rodičov | **HU** Kérj szülői engedélyt, mielőtt online csatlakoznál! | **RO** Cere permisiunea părinților înainte de a te conecta online | **BG** Поискайте разрешение от родител, преди да влезете онлайн | **LV** Pirms došanās tiešsaistē palūdz atļauju vecākiem | **ET** Enne Interneti kasutamist küsi vanematelt luba | **LT** Prieš prisijungdami prie interneto, atsiklauskite tėvų



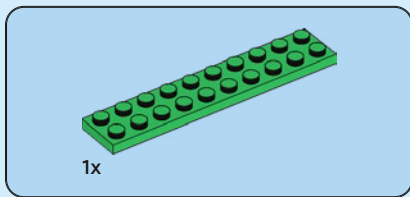

1

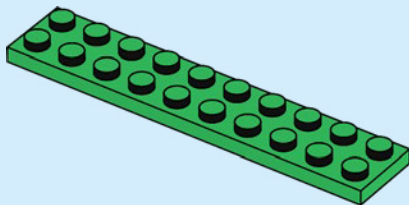



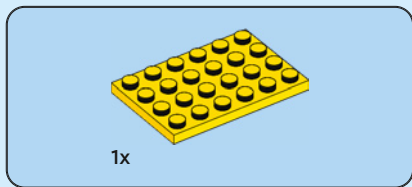

2

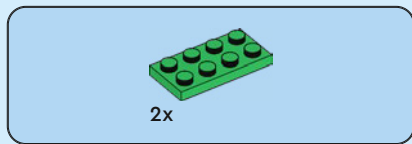
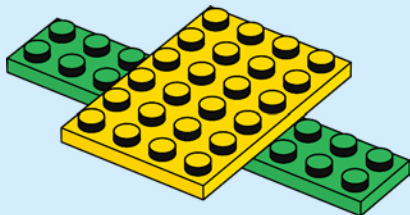

3

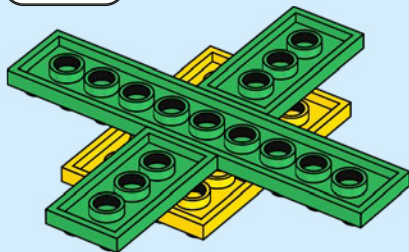



4x

4

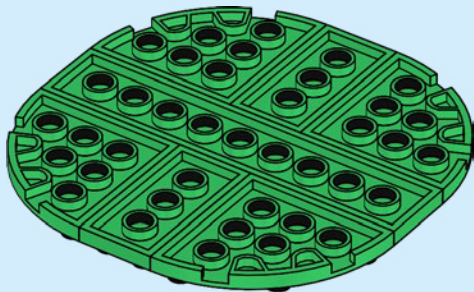

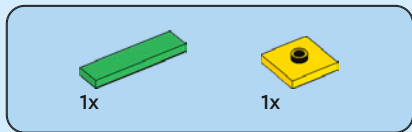

5

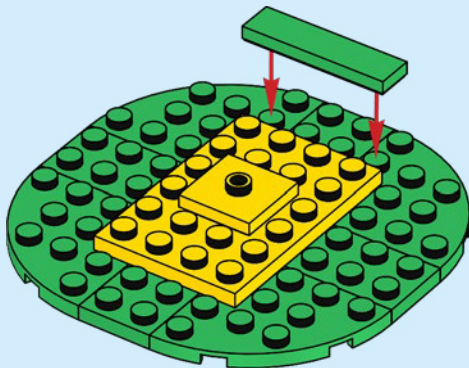

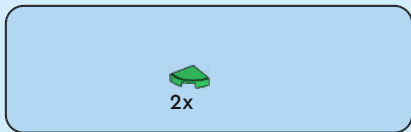

6

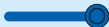
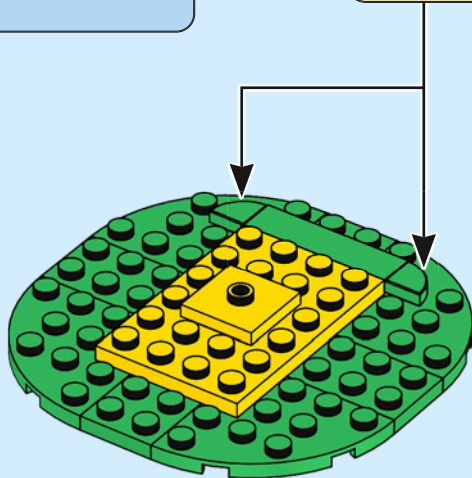

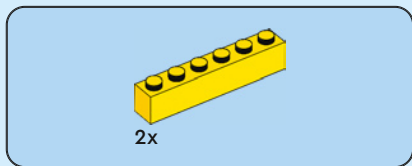

7

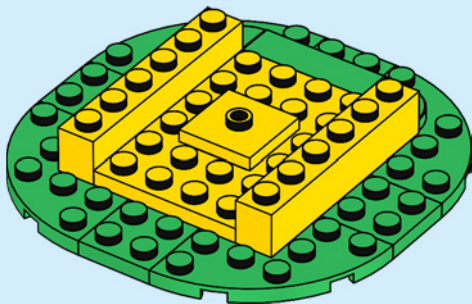



6x

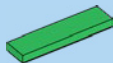

3x

8

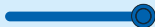
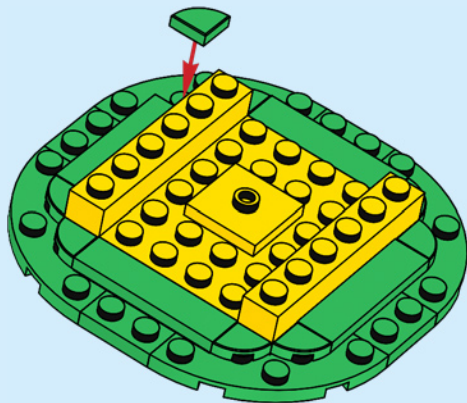

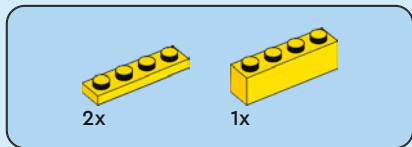

9

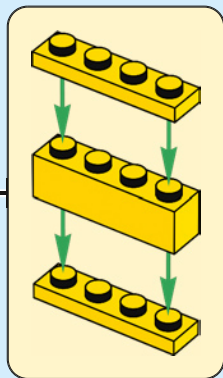
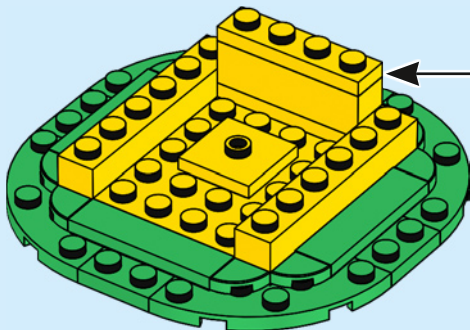

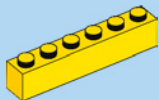

2x

10

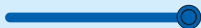
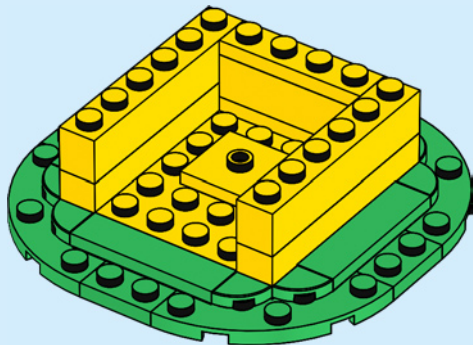





7x

11

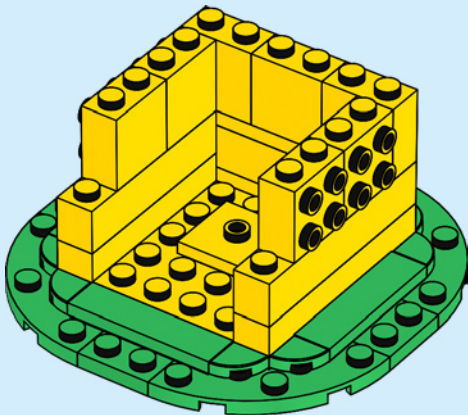



2x

# 12



2x

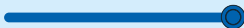
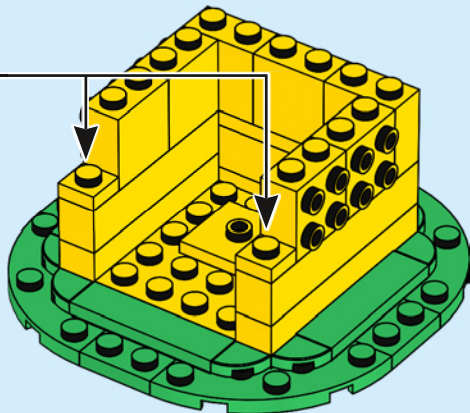

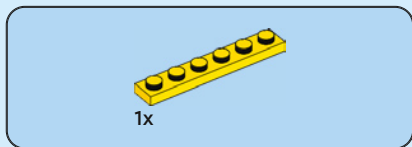

13

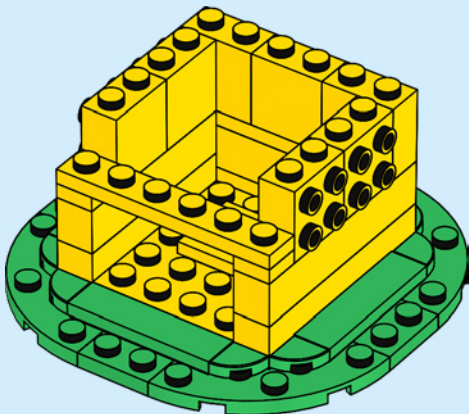



2x

14

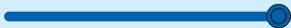
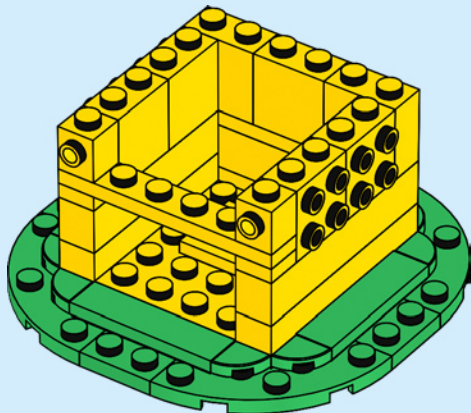



3x



2x

15

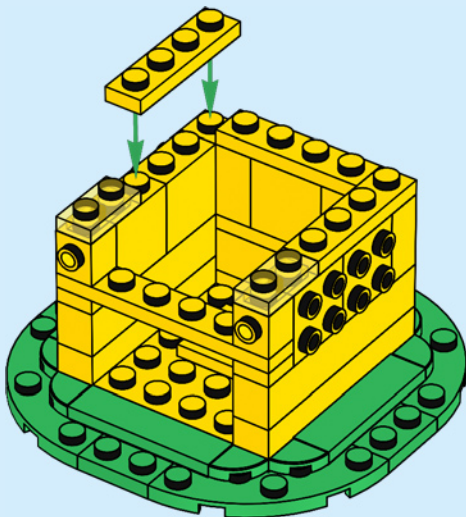



1x



1x

# 16

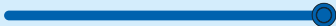
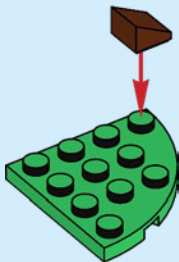



1x



1x



1x

# 17

1

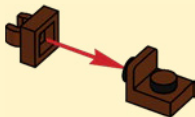

2

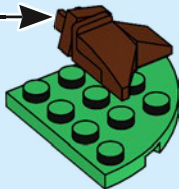



1x



1x

# 18



1x



1x

# 19

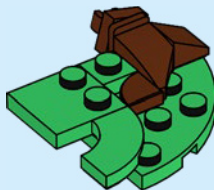





2x

20



21

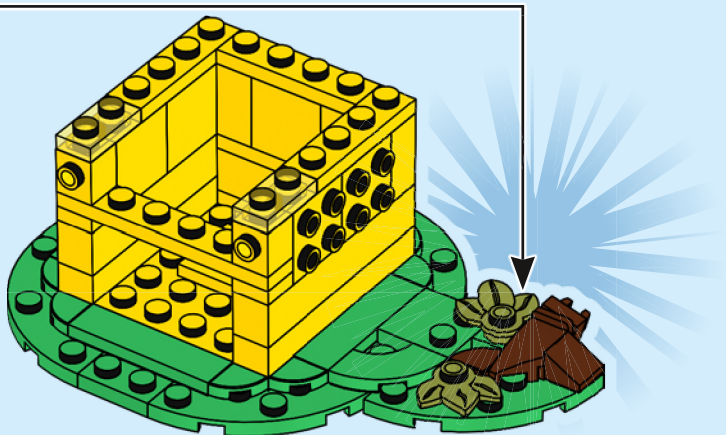



1x

22

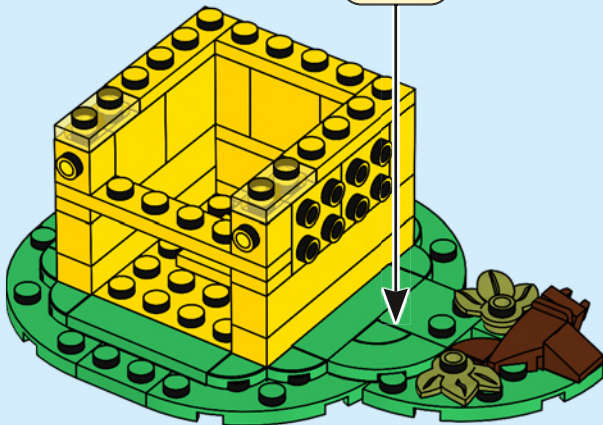



2x



1x

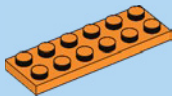

1x

23

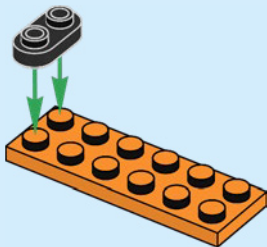

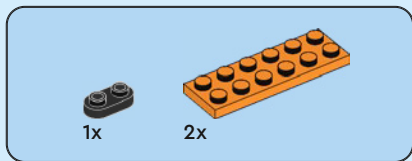

24

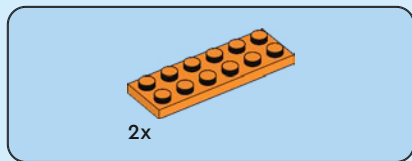
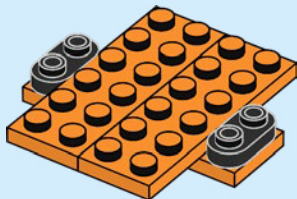

25

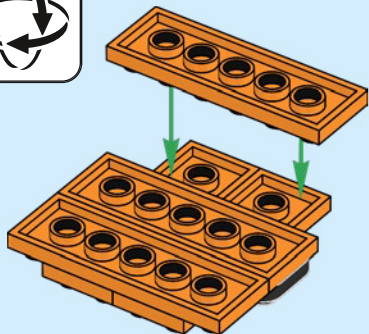



1x

26

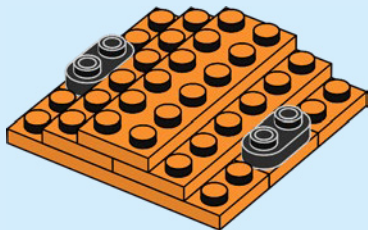

26



1x



2x

27

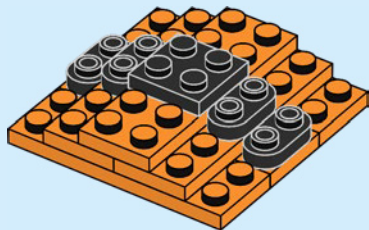



6x

28

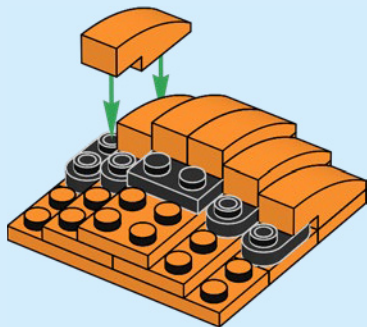

6x

29

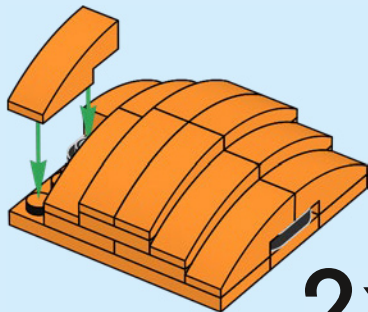

2x

30

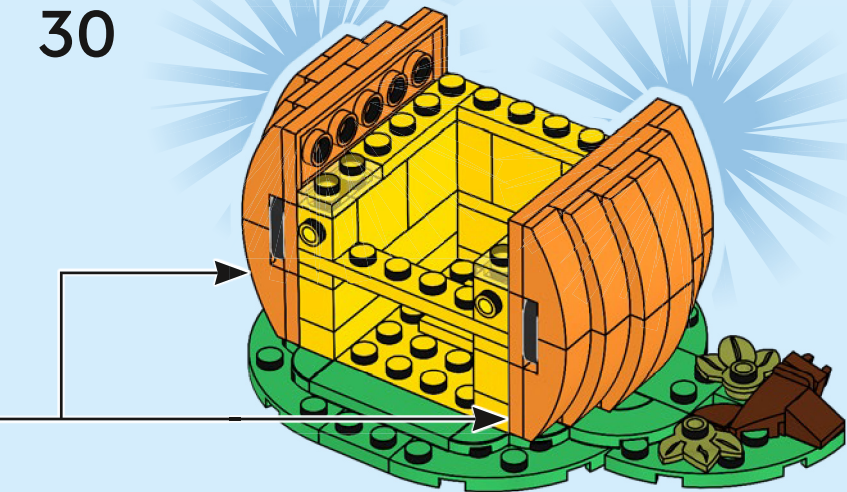



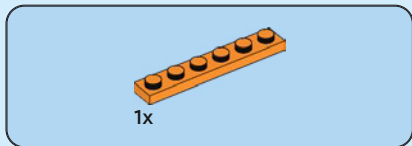
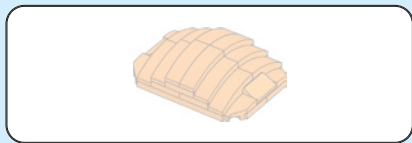

31

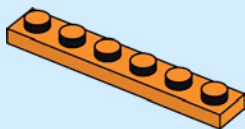

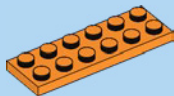

2x

32

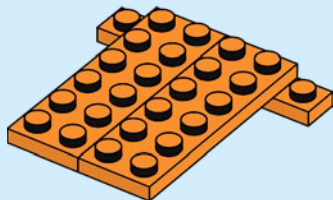

30



1x

33

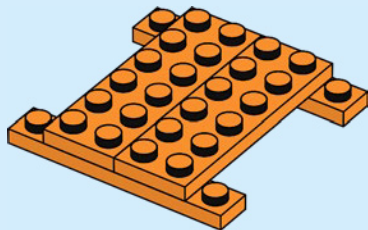

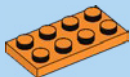

4x

34

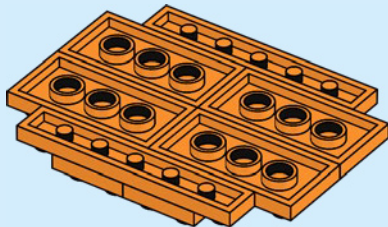

1x

35

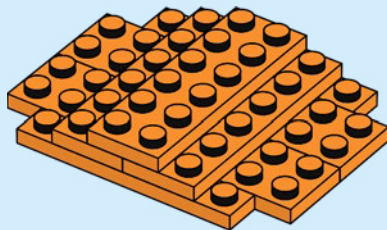



4x



1x

# 36

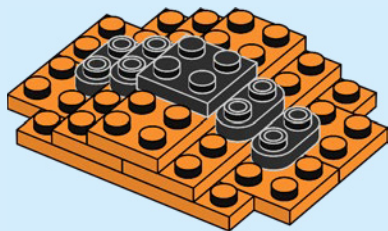

2x



2x



2x

# 37

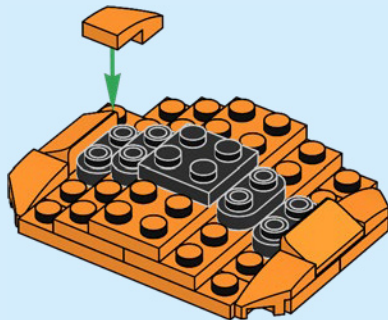



6x

38

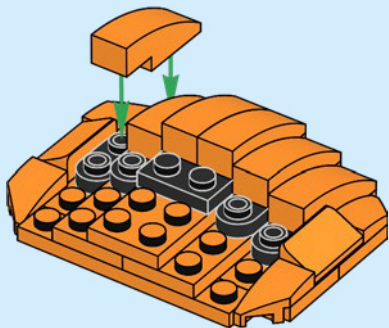

6x

39

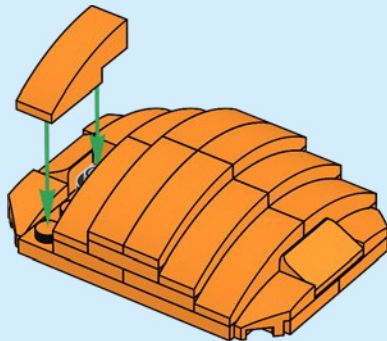

40

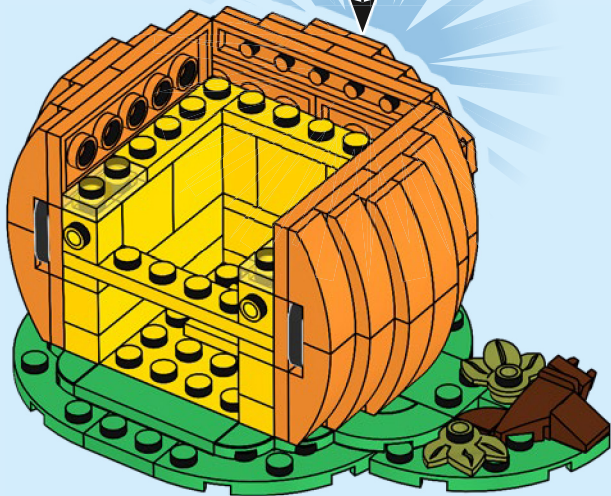

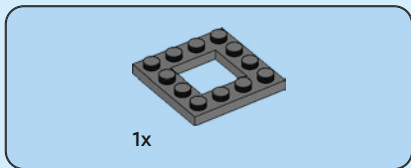
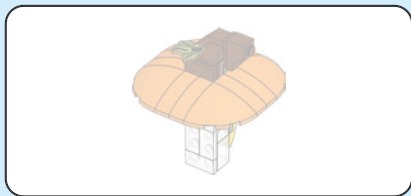

41

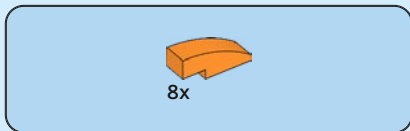
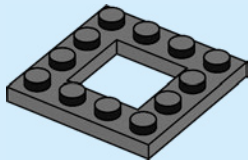

42

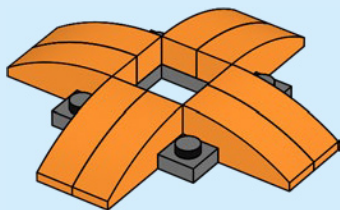



4x

43

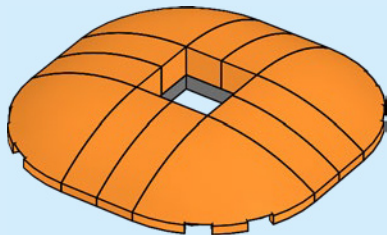

36



1x



2x

44

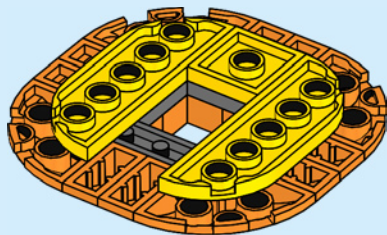



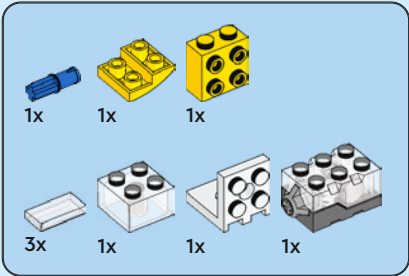
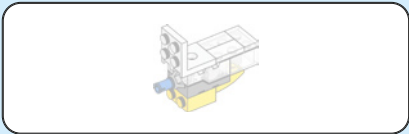

45

1

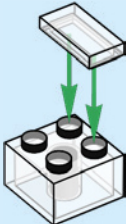

2

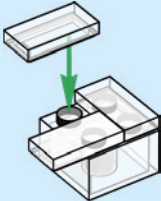

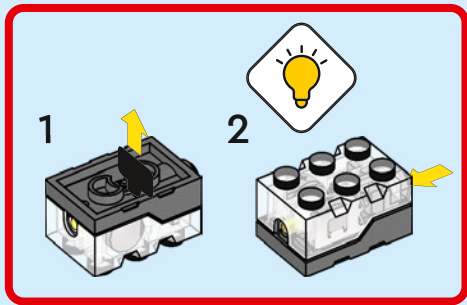

3

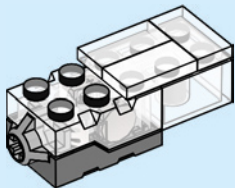

4

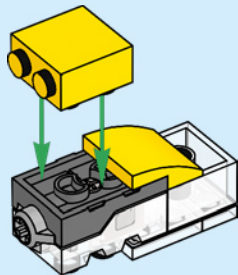

5

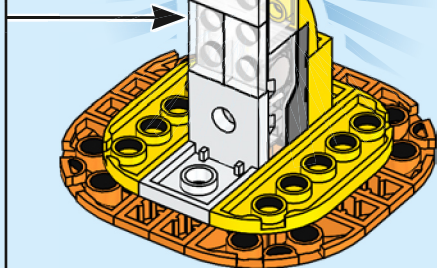
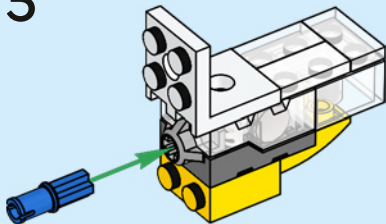



1x



1x

46

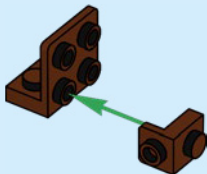

1x

47

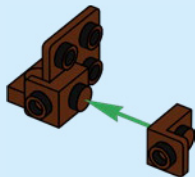



1x

48

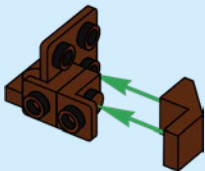

1x



1x

49





1x

50

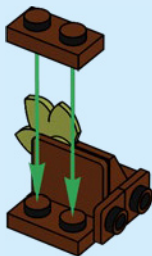

1x

51





1x

52



1x

53

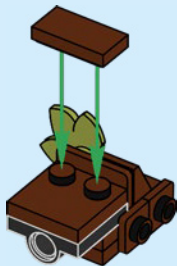



1x

54

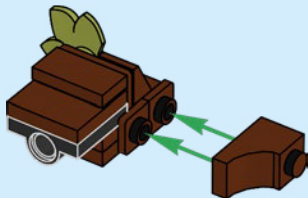

55

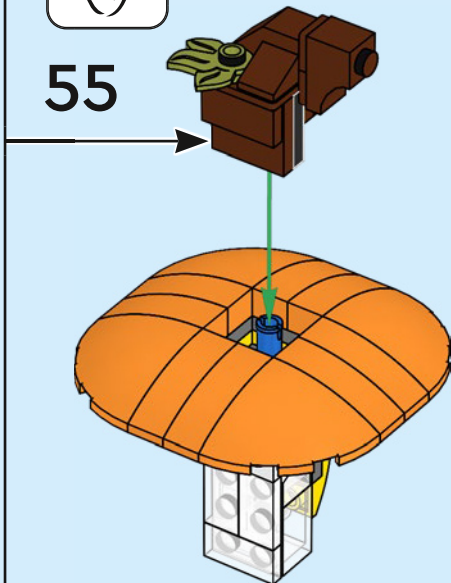



56

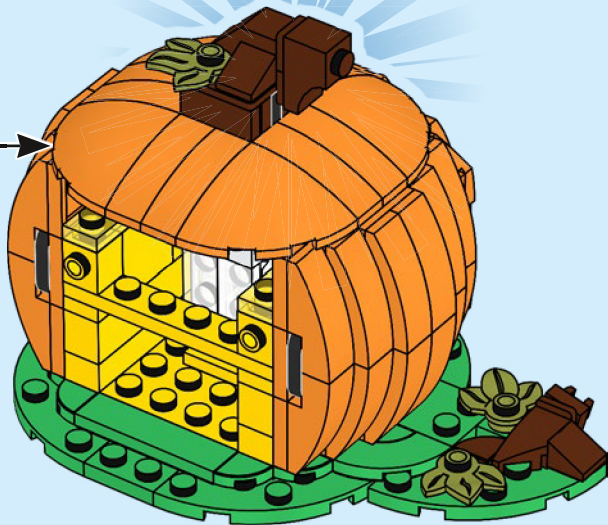



1x

57



2x

58





1x

59



2x



1x

60

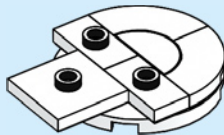



1x

61

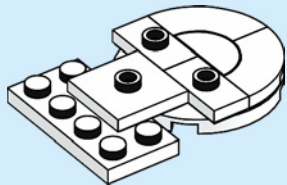

2x

62

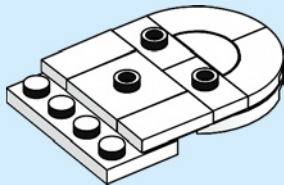



1x



1x



1x

# 63

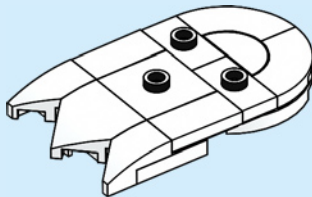

1x



2x

# 64

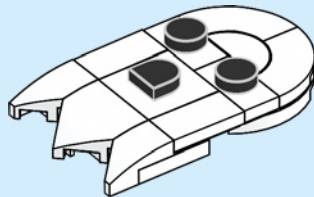

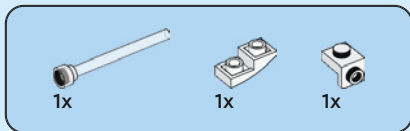

# 65

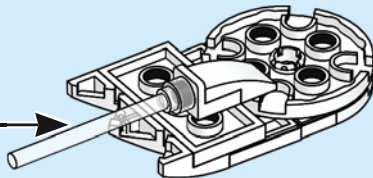
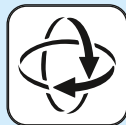
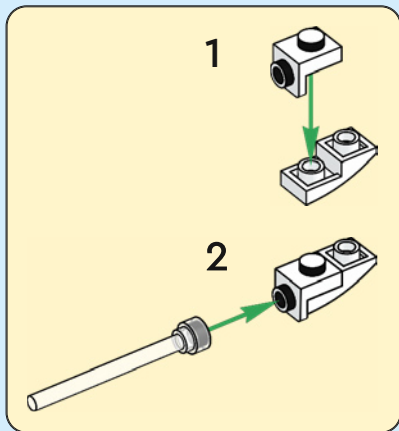

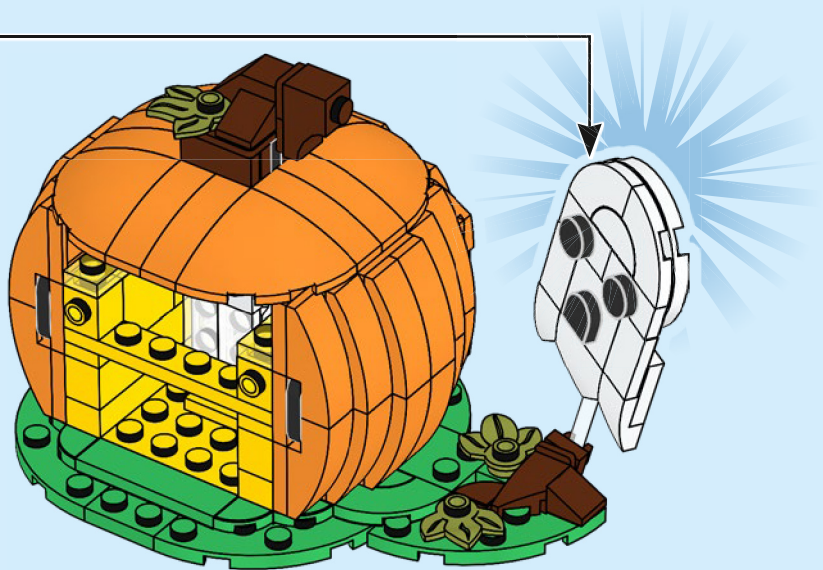





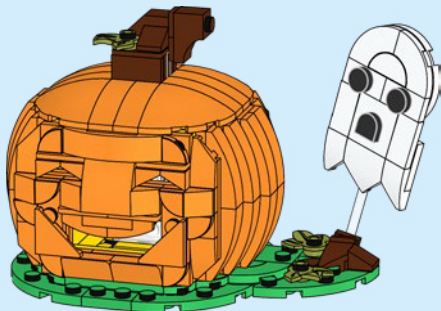
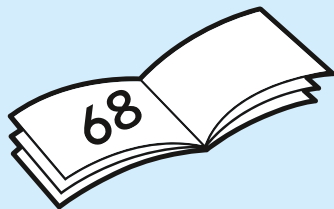
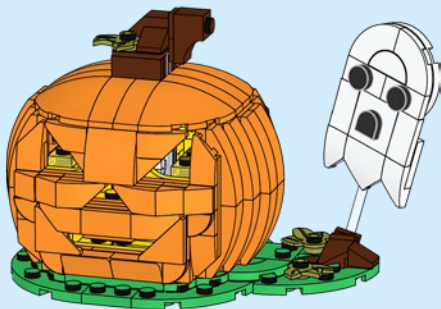

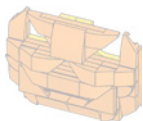

1x



1x

67

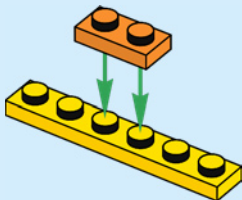

2x

68

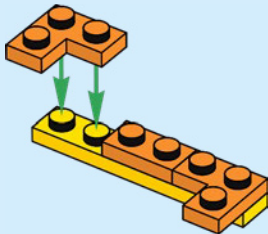



2x



2x

69

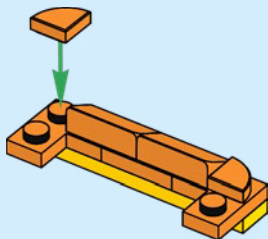

2x

70

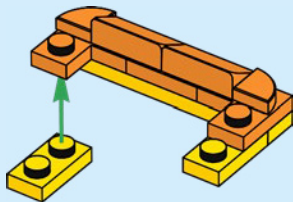

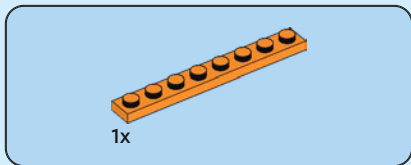

71

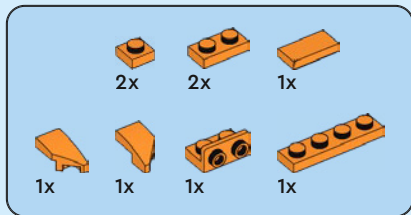
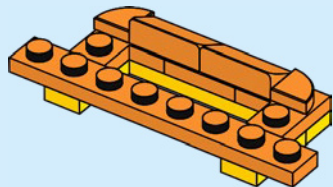

72

1

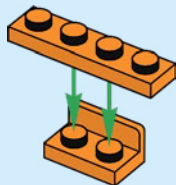

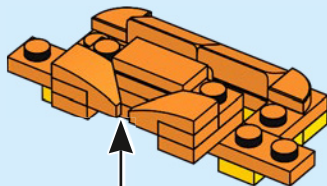
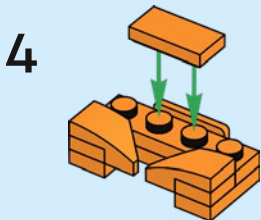
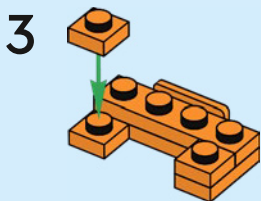
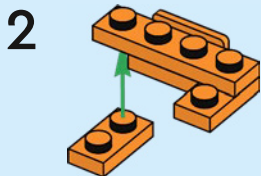



2x

73

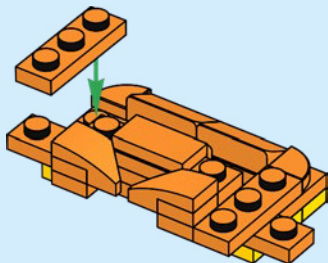

2x

74

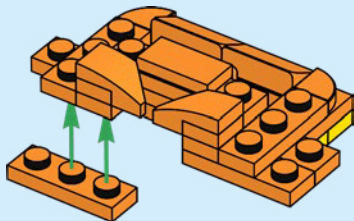



1x



1x

# 75

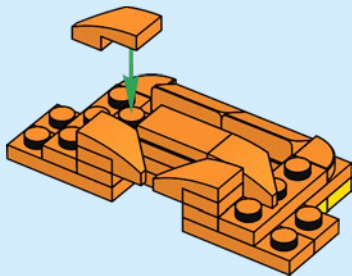

2x

# 76

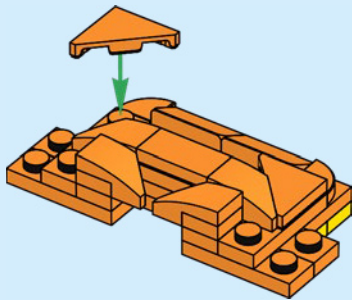



2x

77

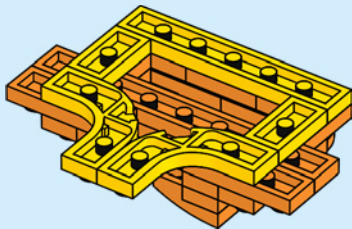



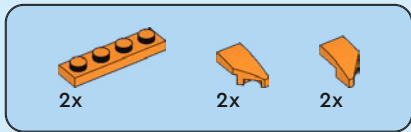

78

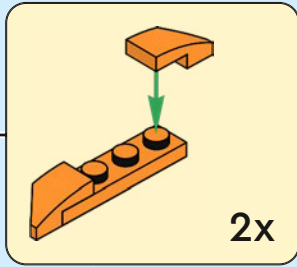
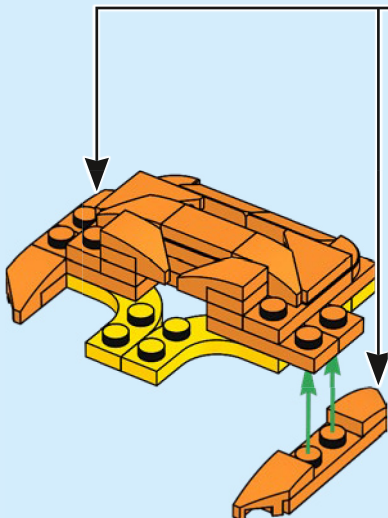



2x

79

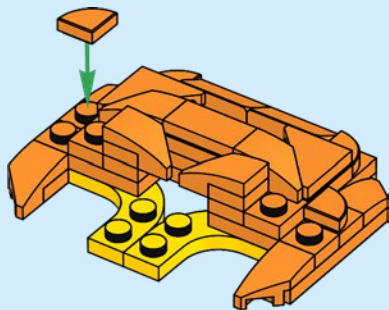

4x



1x

80

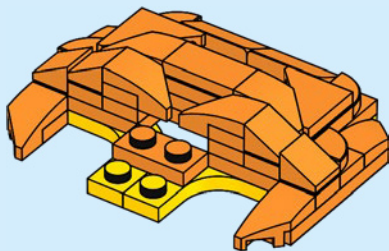



1x



1x

# 81

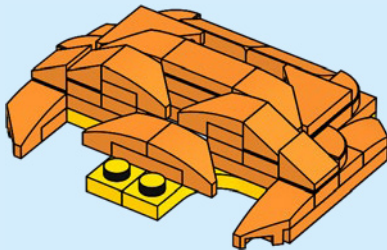



1x



1x



1x

82

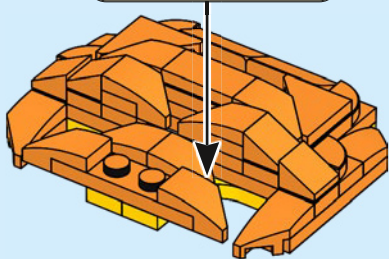
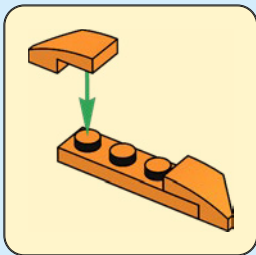

1x

83

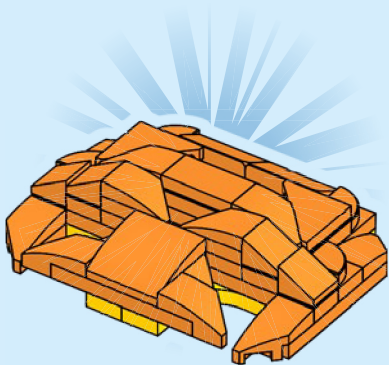

84

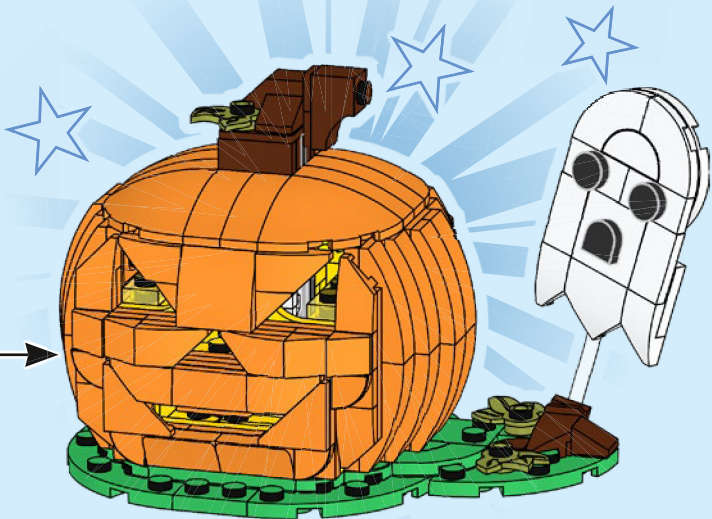

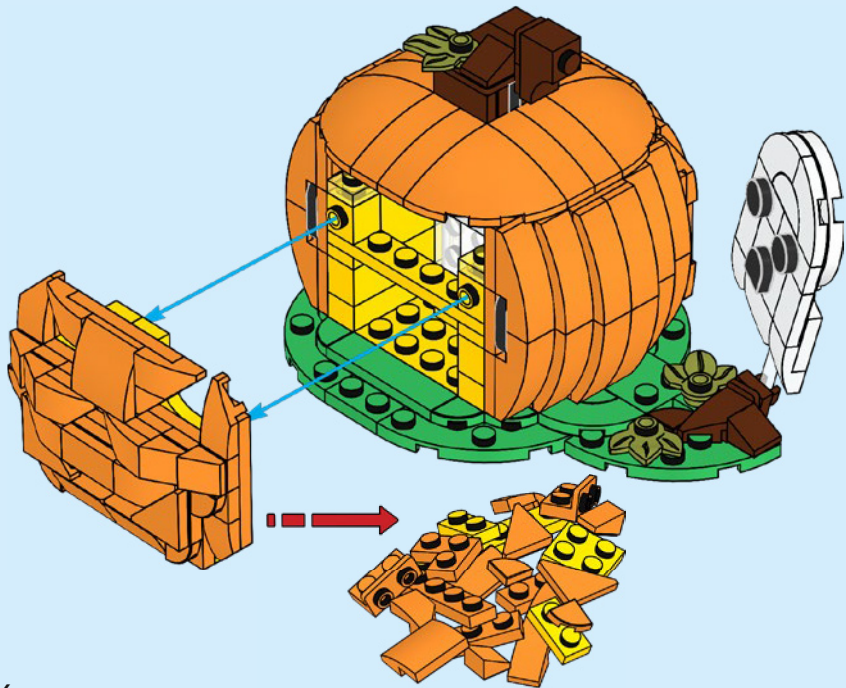

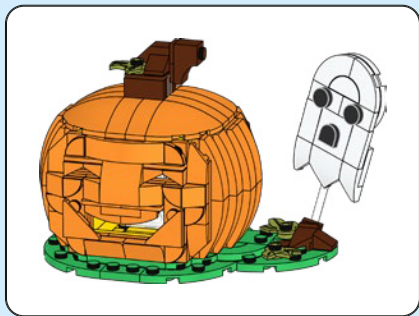

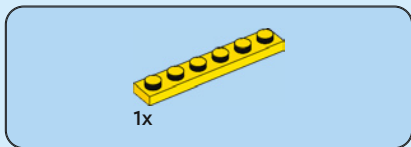

1

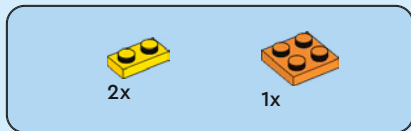
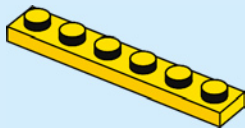

2

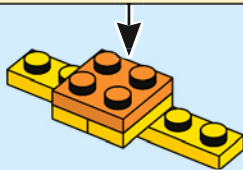
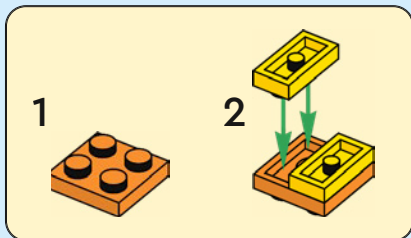





1x

3

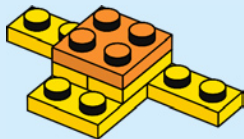

4x



2x

4

1



2



2x

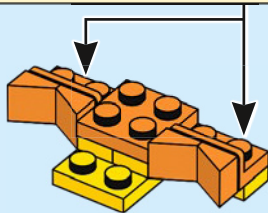



2x



1x

5

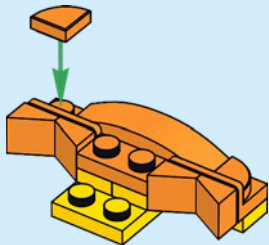

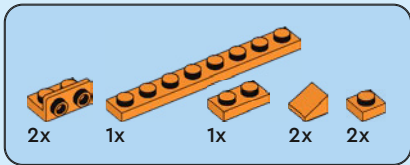
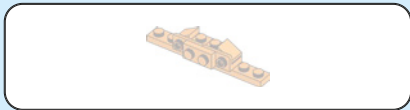

6

1

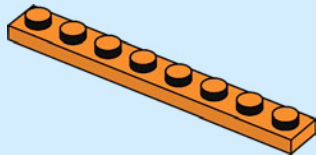

2

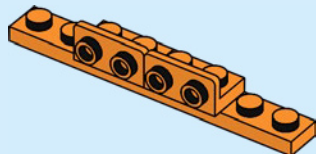

3

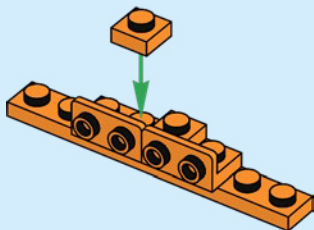

4

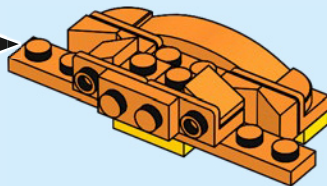
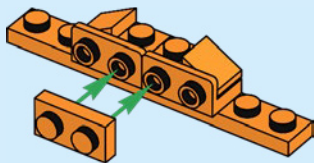



1x

7

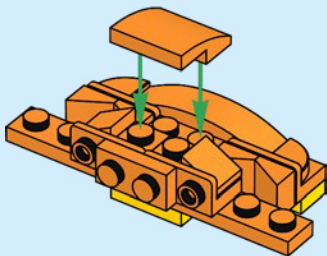

1x



1x

8

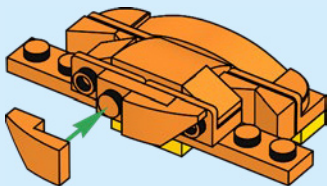

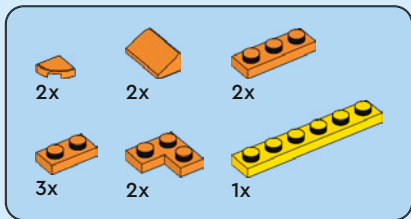

9

1

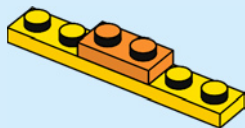

2

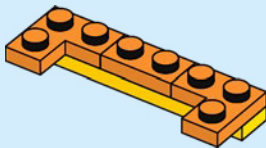

3

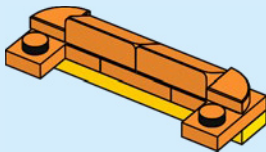

4

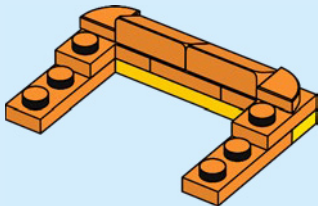

5

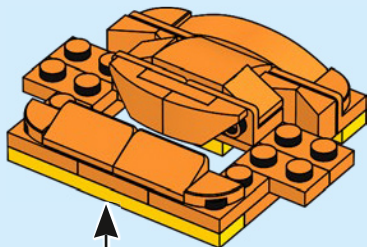
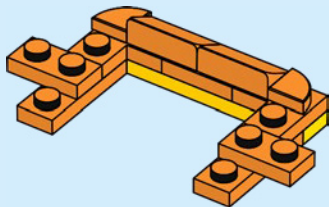



2x

10

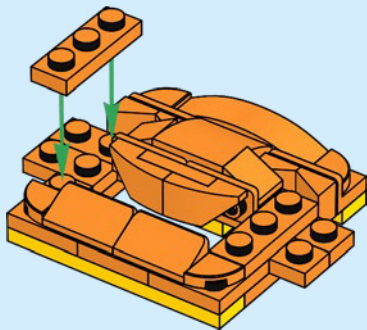





2x



2x

11

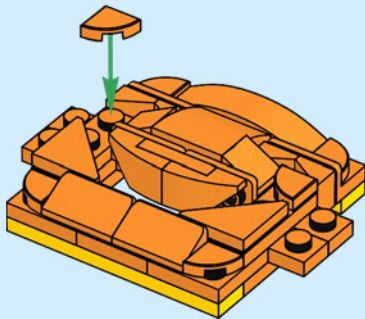



2x



2x



2x

# 12

1

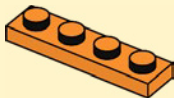

2

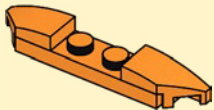

2x

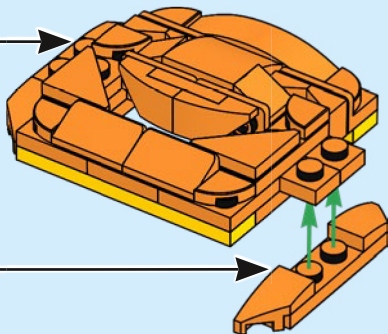



2x



2x

13

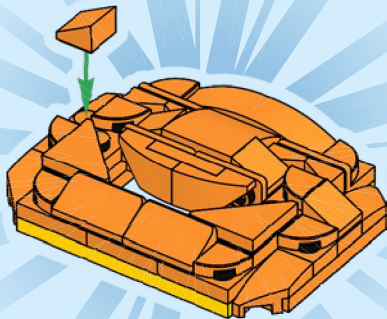

14

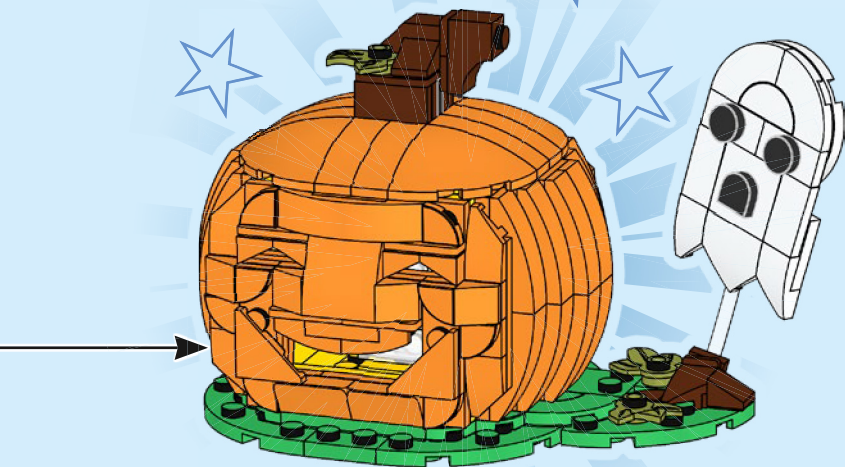

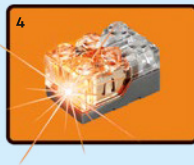

1:1  
2x LR 41 1.5V



1x  
6213880



1x  
6296132



1x  
6510068



1x  
6213881



2x  
6051511



1x  
6301907



1x  
6172927



2x  
306901



2x  
6172674



1x  
6126046



1x  
6313593



1x  
4515347



1x  
302001



1x  
4206482



1x  
6186825



2x  
302324



8x  
6313592



1x  
6126050



2x  
302224



1x  
6411332



5x  
371024



1x  
301024



2x  
4624985



2x  
302424



2x  
6308390



2x  
6116475



3x  
366624



4x  
300924

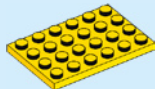

1x  
303224



9x  
6150607



1x  
302428



1x  
6505153



1x  
6365611



4x  
243128



2x  
302028



5x  
6038682

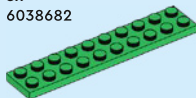

1x  
383228



2x  
6284070



1x  
6256435



12x  
6210270



3x  
302226



1x  
6061032



3x  
6398008

8x  
6173925



8x  
6177499



8x  
4504371



2x  
4524929



8x  
6177490



4x  
6068996



1x  
4188771



4x  
4177932



4x  
6218368

2x  
6346092



2x  
6106027



1x  
6067913



1x  
4159007



4x  
6441091



4x  
6147047



44x  
4251969



4x  
4118782

1x  
4650977



4x  
4158355



2x  
4173332



15x  
4121741



1x  
6210229



1x  
6149677



2x  
4504376

1x  
6290397



1x  
6348057



2x  
6238874



1x  
6401027



1x  
6365885



1x  
6248854



1x  
4211151



1x  
4211150

1x  
6226436



1x  
6196221



2x  
6240211



1x  
6429472

3x  
6251294



1x  
6239418



1x  
6166111

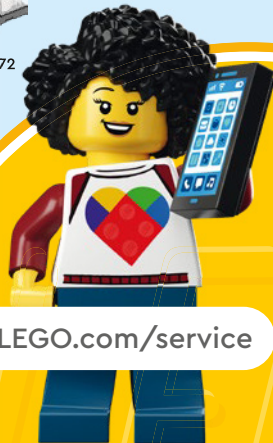

 [LEGO.com/service](https://www.LEGO.com/service)

YOU COULD  
**WIN**



Scan this QR code or go to  
**LEGO.COM/PRODUCTFEEDBACK** and give us  
your short feedback about this LEGO® set  
for a chance to win a cool LEGO prize.

Terms and Conditions apply\*

**EN: YOU COULD WIN.** Terms and Conditions apply\* **DE: Du könntest GEWINNEN.** Es gelten die Teilnahmebedingungen\* **FR: Tu pourrais GAGNER.** Des conditions s'appliquent\* **IT: Potresti VINCERE tu.** Termini e condizioni sono applicabili\* **ES: Puedes GANAR.** Aplican términos y condiciones\* **PT: Poderá GANHAR.** Aplicam-se termos e condições\* **ZH: 轻松获奖.** 条款和条件适用\* **PL: Szansa na WYGRANĄ.** Obowiązują warunki korzystania\* **CS: Máte šanci VYHRÁT.** Platí všeobecné smluvní podmínky\* **SK: Máte šancu VYHRÁT.** Platia všeobecné zmluvné podmienky\* **HU: TE IS NYERHETSZ.** Felhasználási feltételek érvényesek\* **RO: Ai putea CÂȘTIGA.** Se aplică termenii și condiții\* **BG: Можете да СПЕЧЕЛИТЕ.** Има определени правила и условия\* **LV: Tu vari LAIMĒT.** Ir spēkā noteikumi un nosacījumi.\* **ET: Sul on võimalus VÕITA.** Kehtivad tingimused\* **LT: Jūs galite LAIMĖTI.** Taikomos sąlygos\*

\*[LEGO.com/productfeedback-terms](https://www.lego.com/productfeedback-terms)