



76288



Q LEGO® Builder



Get excited about our new packaging!

We're switching from plastic to paper-based packaging. That's why you might find a mix of paper and plastic in our boxes!

Nos nouveaux emballages vous emballeront !

Nous passons des emballages en plastique aux emballages à base de papier. C'est pourquoi vous pourriez trouver un mélange de papier et de plastique dans nos boîtes !

¡Te presentamos nuestros nuevos empaques!

Estamos sustituyendo las bolsas de plástico por bolsas con base de papel. ¡Por eso, puedes encontrar una mezcla de papel y de plástico en nuestras cajas!

[LEGO.com/sustainable-packaging](https://www.lego.com/sustainable-packaging)



Q LEGO® Builder

BUILDER



Apple and the Apple logo are trademarks of Apple Inc., registered in the U.S. and other countries and regions. App Store is a service mark of Apple Inc. Google Play and the Google Play logo are trademarks of Google LLC. Tencent and the Tencent logo are trademarks of Tencent Inc.

Q LEGO.com/devicecheck

EN Ask parents' permission before going online | **DE** Eltern um Erlaubnis bitten, bevor du online gehst | **FR** Demande l'autorisation d'un parent avant d'aller en ligne | **IT** Chiedi il permesso ai tuoi genitori prima di andare online | **ES** Pídeles permiso a tus papás antes de conectarte a Internet | **PT** Pede autorização aos pais antes de acederes online | **ZH** 上网前应先征得父母的同意 | **PL** Poproś rodziców o zgodę, zanim wejdiesz do Internetu | **CS** Než půjdeš na internet, požádej rodiče o svolení | **SK** Skôr než pôjdeš na internet, vypýtaj si povolenie od rodičov | **HU** Kérj szülői engedélyt, mielőtt online csatlakoznál! | **RO** Cere permisiunea părinților înainte de a te conecta online | **BG** Поискайте разрешение от родител, преди да влезете онлайн | **LV** Pirms došanās tiešsaistē palūdz atļauju vecākiem | **ET** Enne Interneti kasutamist küsi vanematelt luba | **LT** Prieš prisijungdami prie interneto, atsiklauskite tėvų



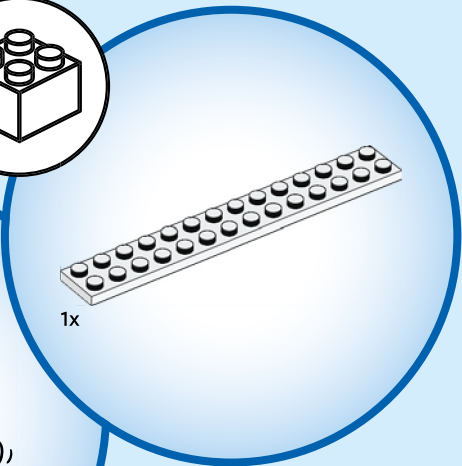
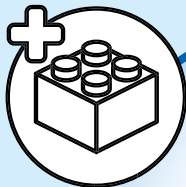

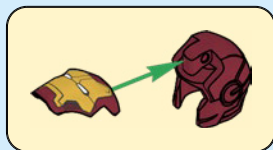
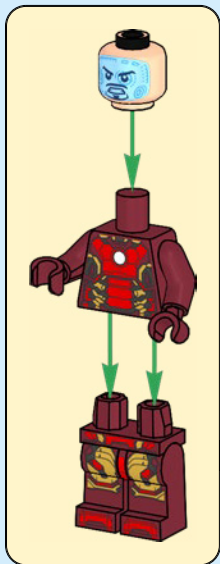



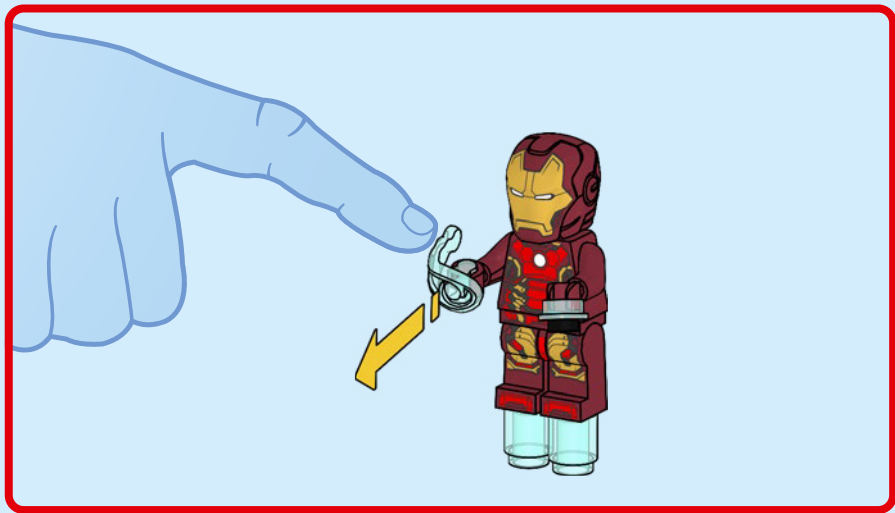

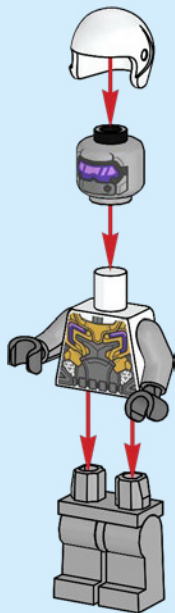

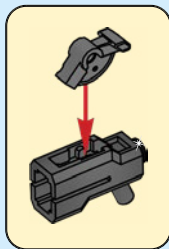



2x

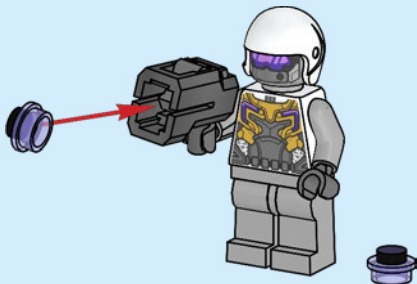

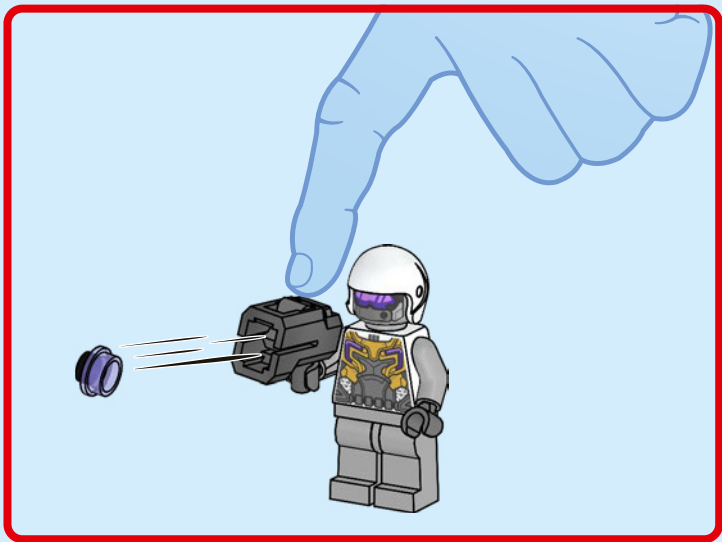

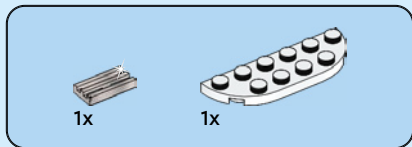

1

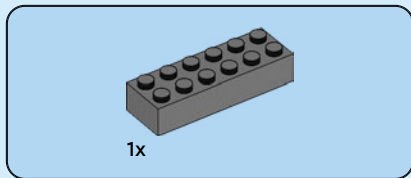
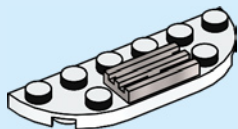

2

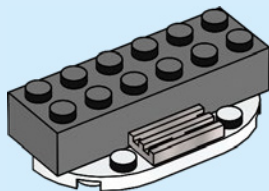

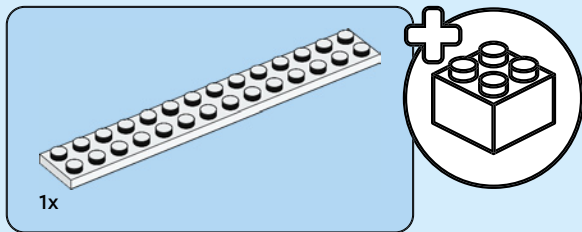

3

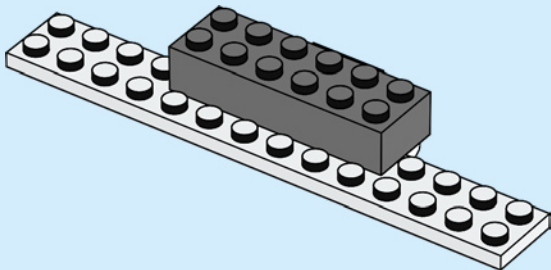
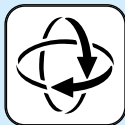



2x



1x

4



2x

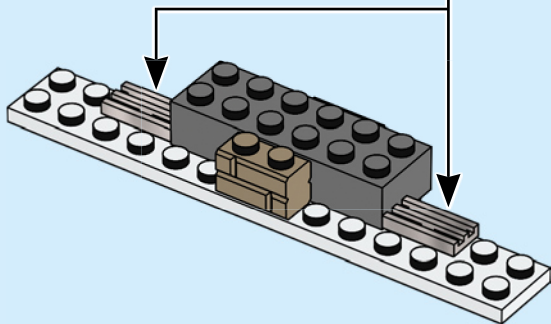



2x

5

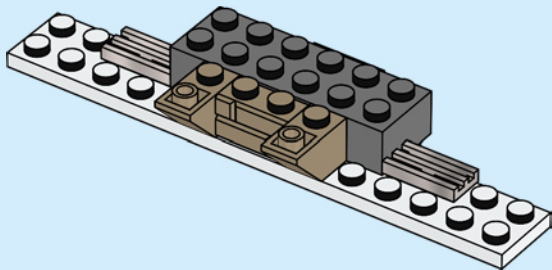

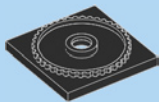

1x

6

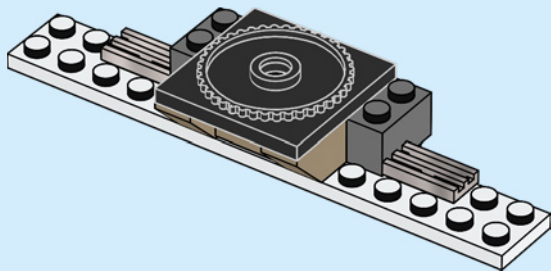



4x

7

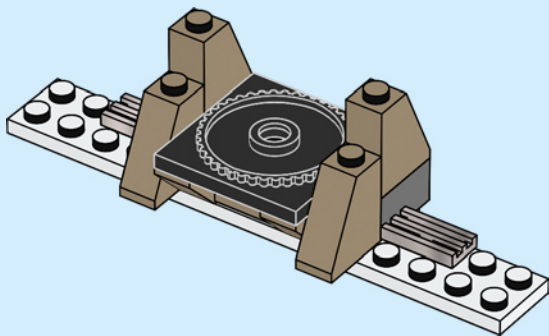



2x



2x

8

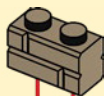
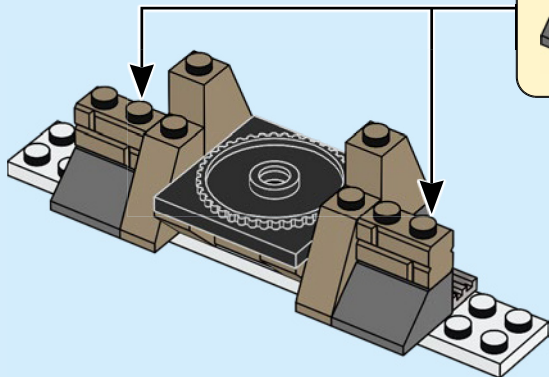

2x



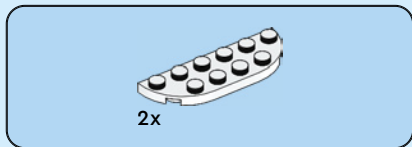

9

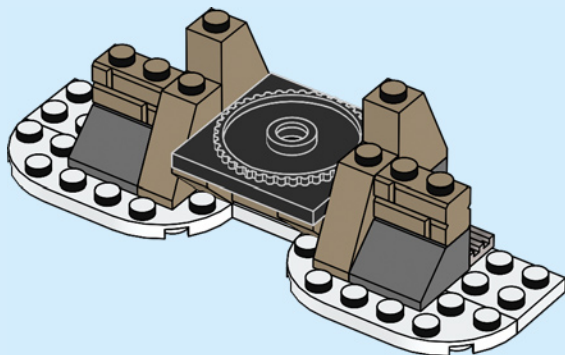



4x

10

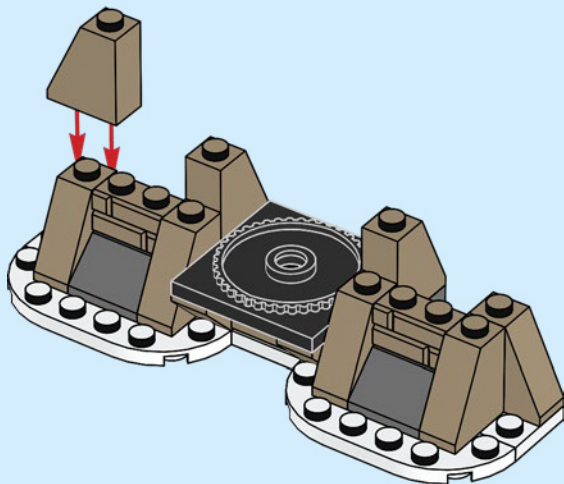



3x

11

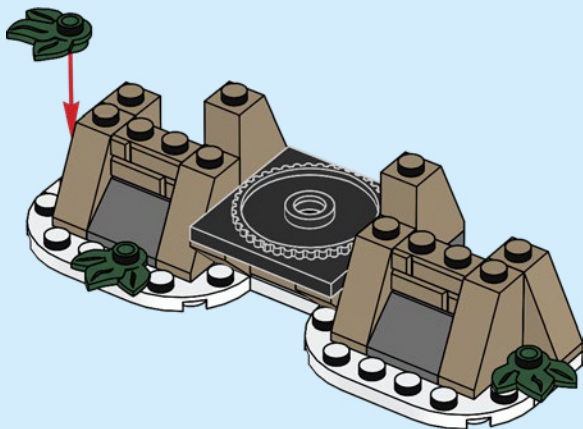



1x



12

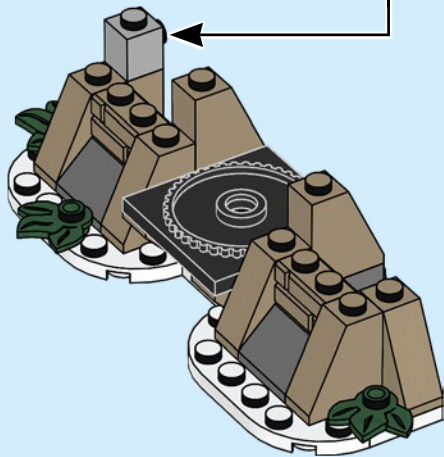



1x



1x

13

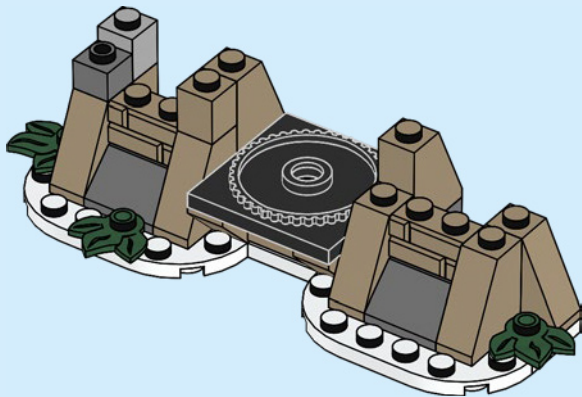



1x



1x

14

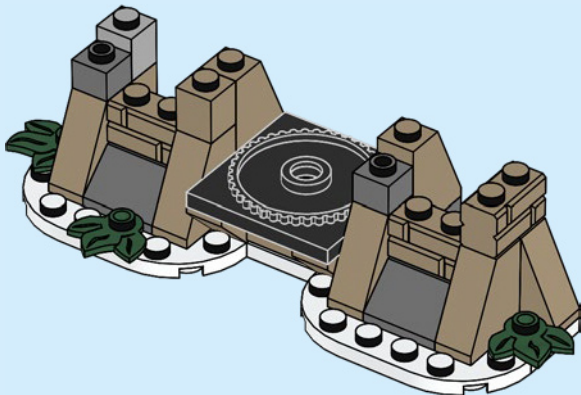



2x

15

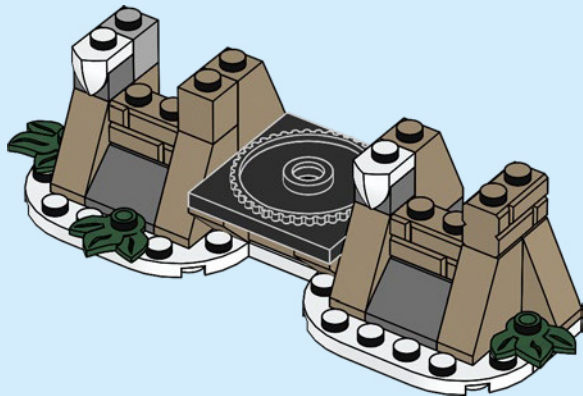



2x

16

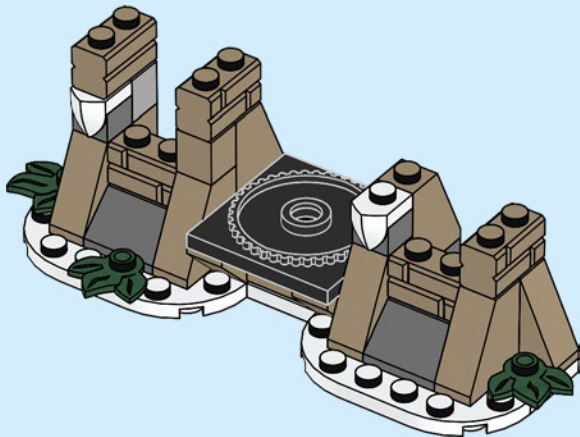



1x



1x



1x

17

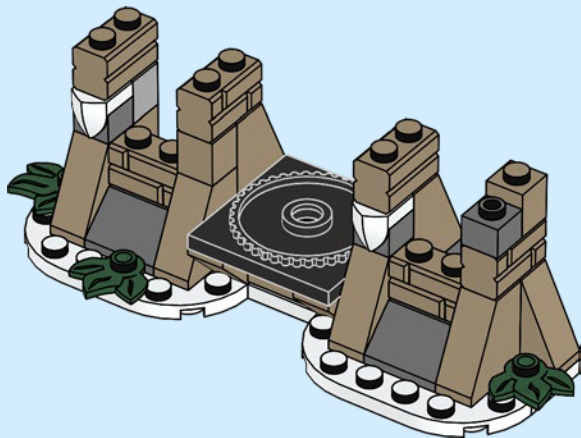



1x



2x

18

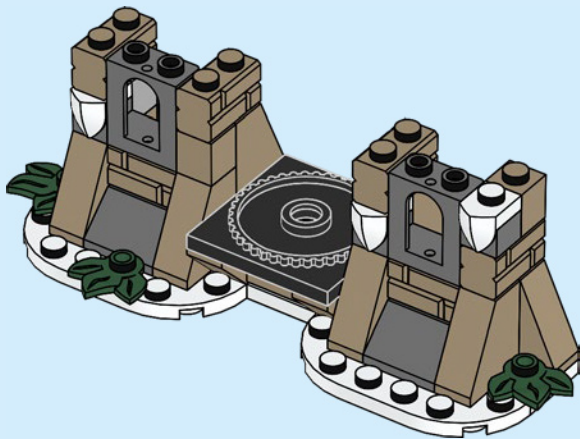



2x

19

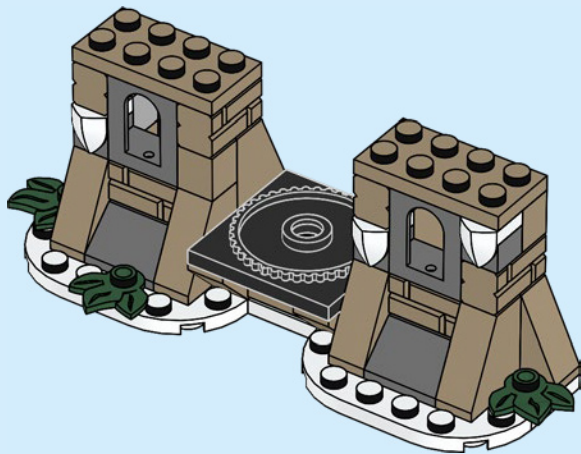



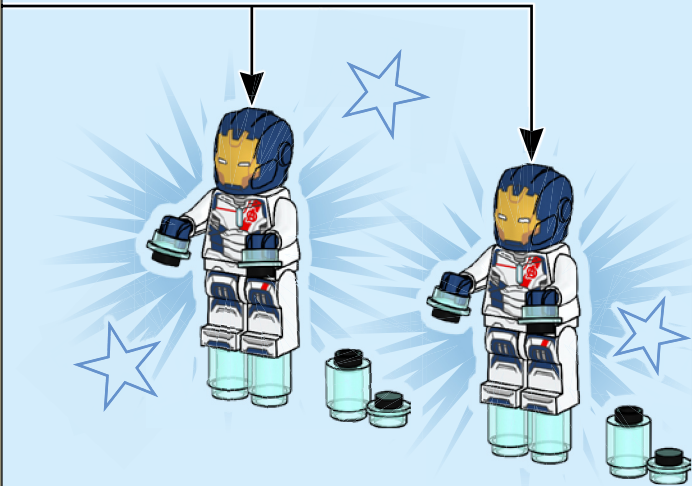
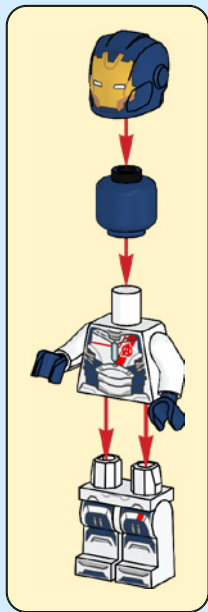

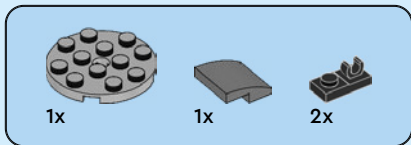

20

1

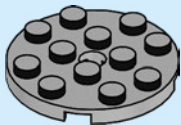

2



3

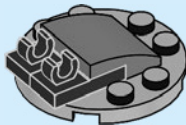

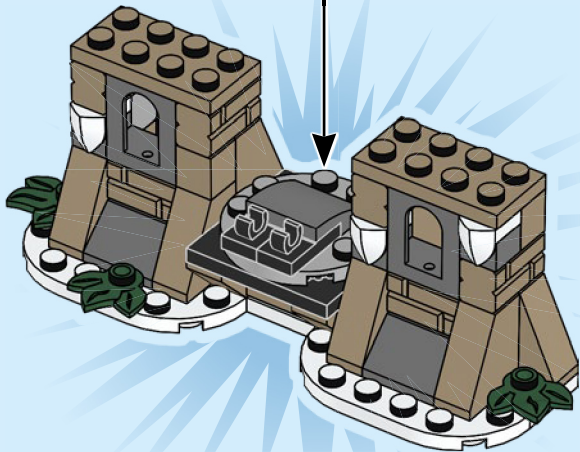

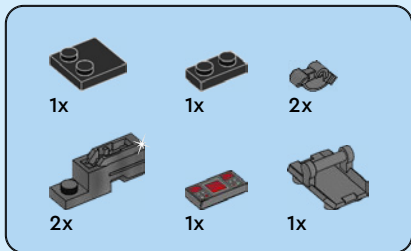

21

1

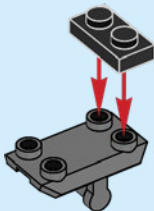

2



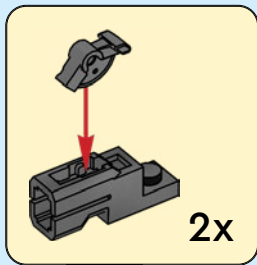

3

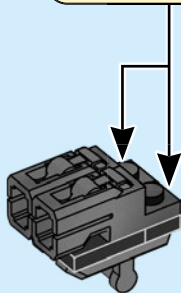

4

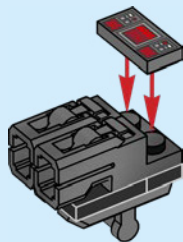

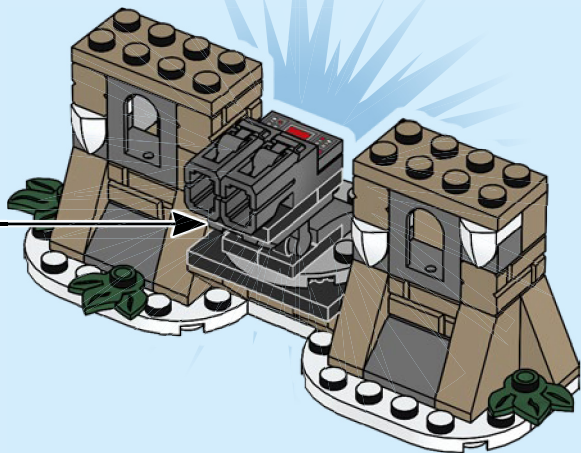



2x

22

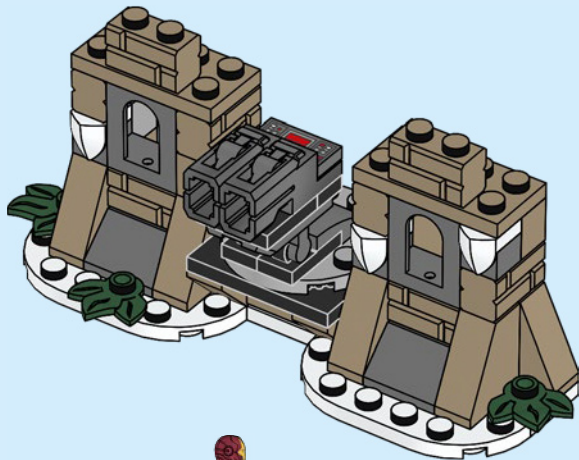



8x

23

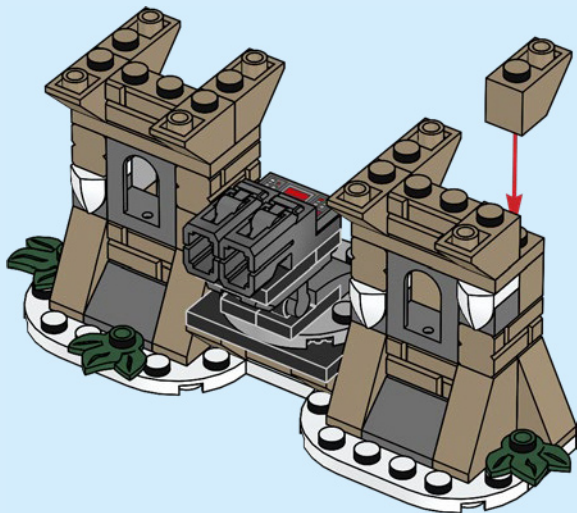

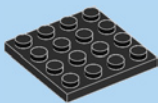

2x

24

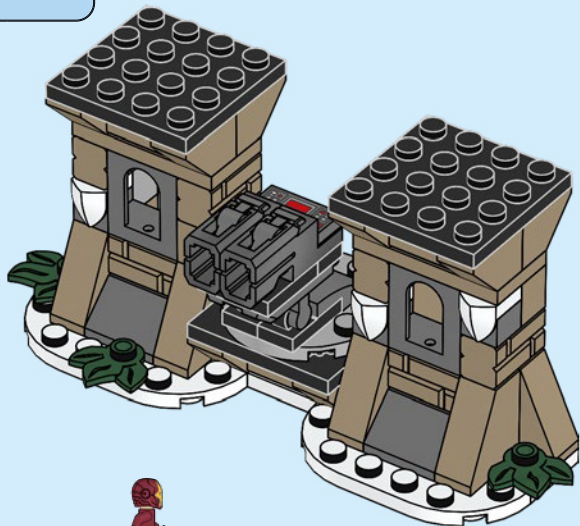



2x



2x

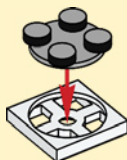

2x

25

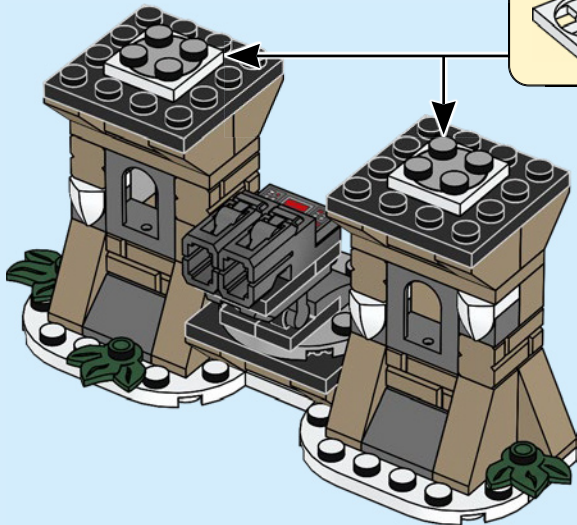



2x

26

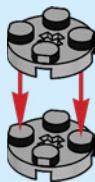



1x



1x

27

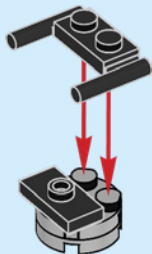



1x

28

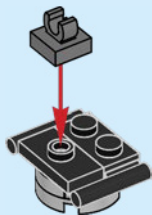



2x

29

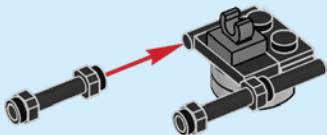



2x

30

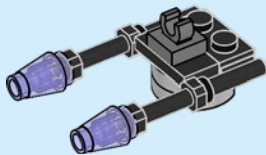

2x



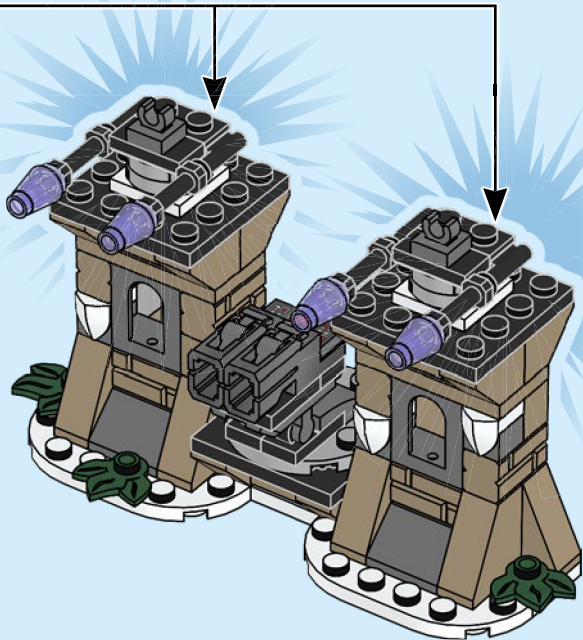



4x



31

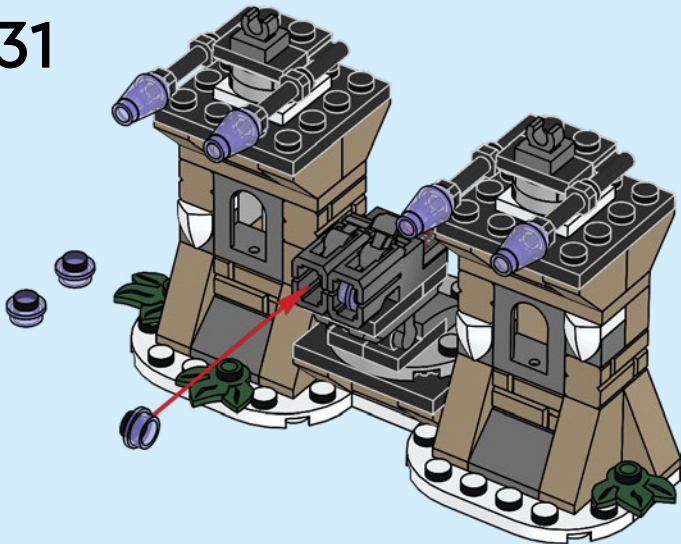

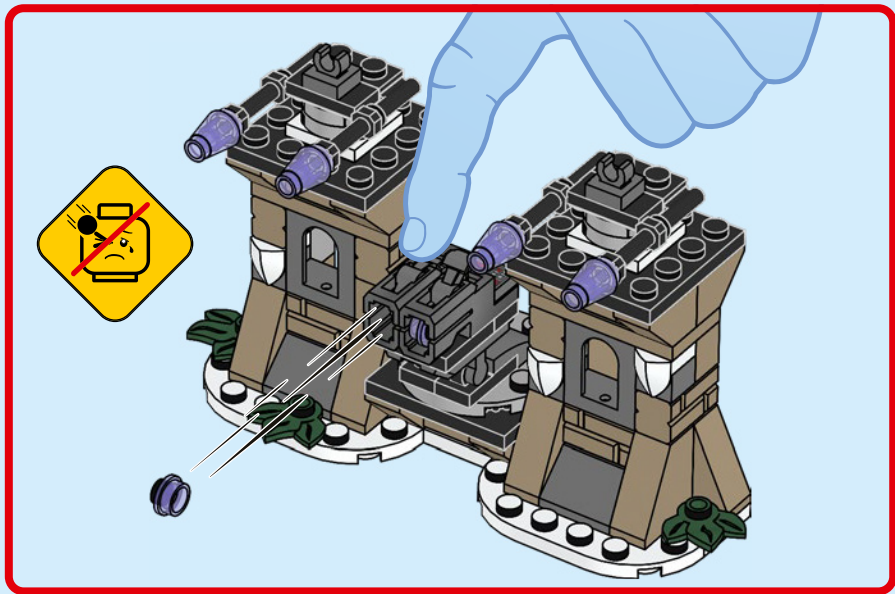

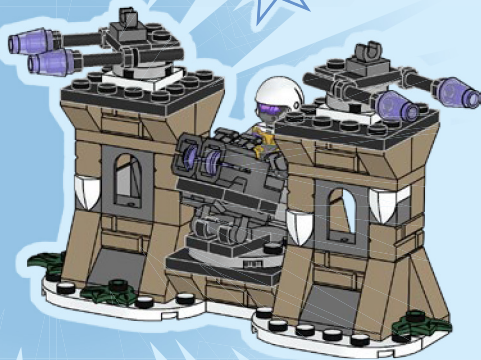



4x
6331084



2x
6092585



1x
302326



2x
6347310



1x
6192346



2x
383926



1x
4517986

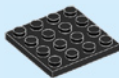

2x
4243819



9x
6240225



9x
6238677



2x
6353237



6x
6240210



4x
6337603



2x
6001824



9x
4646577



8x
6354068



10x
6121959



2x
4267874



2x
6454726



2x
6488201



3x
6400754



1x
6221340



1x
6488120



1x
4558953



4x
4211475



2x
4540203



1x
4227657



1x
4515351



3x
6388133



2x
6344022



2x
6181291



1x
6291791



2x
4211054



1x
6071261



1x
6258991



1x
4210875



3x
6360675



1x
6345880



2x
6345952



1x
6488204



1x
6398321



1x
6488206



1x
6501829



3x
4619636



2x
6501916



1x
6502815



2x
6488203



2x
368001



1x
6252744



3x
6046905



3x
6147792

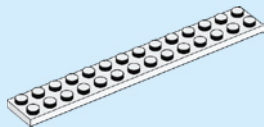

1x
6359065



[LEGO.com/service](https://www.LEGO.com/service)

YOU COULD
WIN



Scan this QR code or go to
LEGO.COM/PRODUCTFEEDBACK and give us
your short feedback about this LEGO® set
for a chance to win a cool LEGO prize.

Terms and Conditions apply*

EN: YOU COULD WIN. Terms and Conditions apply* **DE: Du könntest GEWINNEN.** Es gelten die Teilnahmebedingungen* **FR: Tu pourrais GAGNER.** Des conditions s'appliquent* **IT: Potresti VINCERE tu.** Termini e condizioni sono applicabili* **ES: Puedes GANAR.** Aplican términos y condiciones* **PT: Poderá GANHAR.** Aplicam-se termos e condições* **ZH: 轻松获奖.** 条款和条件适用* **PL: Szansa na WYGRANĄ.** Obowiązują warunki korzystania* **CS: Máte šanci VYHRÁT.** Platí všeobecné smluvní podmínky* **SK: Máte šancu VYHRÁT.** Platia všeobecné zmluvné podmienky* **HU: TE IS NYERHETSZ.** Felhasználási feltételek érvényesek* **RO: Ai putea CÂȘTIGA.** Se aplică termenii și condiții* **BG: Можете да СПЕЧЕЛИТЕ.** Има определени правила и условия* **LV: Tu vari LAIMĒT.** Ir spēkā noteikumi un nosacījumi.* **ET: Sul on võimalus VÕITA.** Kehtivad tingimused* **LT: Jūs galite LAIMĖTI.** Taikomos sąlygos*

*[LEGO.com/productfeedback-terms](https://www.lego.com/productfeedback-terms)

LEGO and the LEGO logo are trademarks of the/sont des marques de commerce du/
son marcas registradas de LEGO Group. ©2024 The LEGO Group.

© 2024 MARVEL

6534162