



PHARRELL WILLIAMS

OVER THE MOON

10391

Booklet available in English
Livret disponible en français
Folleto disponible en español

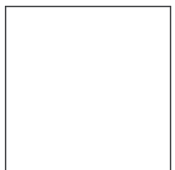



WE'RE MAKING OUR PACKAGING MORE SUSTAINABLE

We're transitioning from single-use plastic to paper-based packaging. As we progress, you may find a mix of paper and plastic in our boxes.

NOUS RENDONS NOS EMBALLAGES PLUS DURABLES

Nous passons des emballages en plastique à usage unique aux emballages à base de papier. Durant la transition, vous pourriez trouver un mélange de papier et de plastique dans nos boîtes.

QUEREMOS HACER MÁS SUSTENTABLES NUESTROS MATERIALES DE EMBALAJE

Estamos cambiando las bolsas de plástico desechables por bolsas con base de papel. Conforme avanzamos en este propósito, puedes encontrar una mezcla de papel y de plástico en nuestras cajas.

LEGO.com/sustainable-packaging



BUILDER



Apple and the Apple logo are trademarks of Apple Inc., registered in the U.S. and other countries and regions. App Store is a service mark of Apple Inc. Google Play and the Google Play logo are trademarks of Google LLC. Tencent and the Tencent logo are trademarks of Tencent Inc.

LEGO.com/devicecheck



LEGO® Builder

A SPARK OF IMAGINATION

Pharrell Williams is a visionary recording artist, producer, songwriter, philanthropist, fashion designer and entrepreneur; at his core, he is a multihyphenate creator. His foundations and social responsibility initiatives YELLOW and Black Ambition highlight our obligations as humans to support one another and act as a positive transformative force. Pharrell's influential music career has earned him 13 Grammy Awards and an Academy Award nomination in addition to countless other accolades. As one of the most

decorated and awarded artists in recent history, he has spurred the creative metamorphosis of modern musical culture. Simply looking up at the stars sparks his curiosity. As a child, Pharrell's creative optimism and his surroundings at Atlantis Apartments fueled his curiosity and provided the launchpad that helped him build the future he wanted for himself, and others like him. This inquisitive appreciation for the universe drives Pharrell's influential creativity.

UNE ÉTINCELLE D'IMAGINATION

Pharrell Williams est un créateur visionnaire, à la fois artiste de studio d'enregistrement, producteur, auteur-compositeur, philanthrope, dessinateur de mode et entrepreneur. Ses fondations et ses initiatives de responsabilité sociale, YELLOW et Black Ambition, soulignent notre obligation, en tant qu'êtres humains, de nous soutenir les uns les autres et d'agir comme une force de transformation positive. La carrière musicale influente de Pharrell lui a valu 13 Grammys et une nomination aux Oscars, ainsi que d'innombrables autres récompenses. Artiste parmi les plus décorés et récompensés de

l'histoire récente, il a favorisé la métamorphose créative de la culture musicale moderne. Le simple fait de regarder les étoiles éveille sa curiosité. Enfant, Pharrell a pu compter sur son optimisme créatif et sur son environnement à Atlantis Apartments pour alimenter sa curiosité et lui fournir le tremplin qui lui a permis de construire l'avenir qu'il souhaitait pour lui-même et pour d'autres comme lui. Cette appréciation curieuse de l'univers est au cœur de la créativité influente de Pharrell.

UNA CHISPA DE IMAGINACIÓN

Pharrell Williams es músico, productor, compositor, filántropo, diseñador de modas y empresario; en esencia, un creador visionario con múltiples talentos. Sus fundaciones e iniciativas de responsabilidad social YELLOW y Black Ambition ponen de relieve nuestra obligación como seres humanos de apoyarnos mutuamente y de actuar como una fuerza transformadora positiva. La prestigiosa carrera musical de Pharrell le ha hecho ganar 13 premios Grammy y una nominación a los premios de la Academia, además de incontables galardones. El artista, uno de los más condecorados y premiados

de nuestra historia reciente, ha propiciado la metamorfosis creativa de la cultura musical moderna. Solo mirar a las estrellas ya desata su curiosidad. Cuando era niño, el optimismo creativo de Pharrell y su entorno en el condominio Atlantis Apartments alimentaron su curiosidad y constituyeron una plataforma de lanzamiento que le permitió desarrollar el futuro que quería para sí mismo y otras personas como él. Esta inquisitiva apreciación del universo impulsa la influyente creatividad de Pharrell.



"CURIOSITY IS
THE LIFE FORCE
IN ALL OF US"

« LA CURIOSITÉ EST
LA FORCE VITALE QUI
RÉSIDE EN CHACUN
DE NOUS. »

"LA CURIOSIDAD ES
LA FUERZA VITAL QUE
TODOS LLEVAMOS
DENTRO".

- PHARRELL WILLIAMS





CREATIVITY IGNITED

This collaboration offers the unique opportunity to combine the creativity of LEGO® Play with the curiosity of Pharrell. Our LEGO design team worked with Pharrell closely over many months to co-create this final product, starting with hundreds of possible concepts then developing them down to one exciting idea: a space shuttle blasting over the moon on a colorful jet stream. The LEGO design team were inspired by Pharrell's love of space as a place where our imaginations can be untethered, resulting in striking features and inclusions like the all-black color scheme for the space shuttle and the inclusion of 49 additional minifigure heads so that anyone could come on the journey too.

LA CRÉATIVITÉ EN ÉVEIL

Cette collaboration offre l'occasion unique de combiner la créativité du jeu LEGO® avec la curiosité de Pharrell. Notre équipe de conception LEGO a travaillé en étroite collaboration avec Pharrell pendant de nombreux mois pour créer ce produit final, le fruit de centaines de concepts possibles qui ont par la suite été réduits à une seule idée exaltante : une navette spatiale survolant la lune sur un courant-jet coloré. L'équipe de conception LEGO s'est inspirée de l'amour de Pharrell pour l'espace, un lieu où l'imagination n'a aucune limite, avec pour résultat des caractéristiques et des ajouts frappants, comme la couleur noire de la navette spatiale et les 49 têtes de figurines supplémentaires pour que tout le monde puisse prendre part au voyage.

DESPEGUE CREATIVO

Esta colaboración ofrece una oportunidad única de combinar la creatividad del juego con LEGO® y la curiosidad de Pharrell. Nuestro equipo de diseño de LEGO trabajó hombro con hombro con Pharrell durante meses para cocrear este producto final. Partimos de cientos de conceptos posibles y, después, fuimos desarrollándolos hasta reducirlos a una emocionante idea: un transbordador espacial en pleno despegue hacia la Luna dejando detrás de sí una estela de vivos colores. El equipo de diseño de LEGO se inspiró en la pasión de Pharrell por el espacio, que lo concibe como un lugar donde nuestra imaginación puede volar sin ataduras. Se ha plasmado en atractivas características y complementos, como el color negro del transbordador espacial y la inclusión de 49 cabezas de minifigura adicionales para que cualquiera pueda unirse también al viaje.

POWERED BY CURIOSITY

This is your invitation – get ready to blast off to the moon! Whether you are proudly displaying the shuttle as a display piece or building this unique vehicle with your family to role play space adventures, we encourage you to follow wherever your creativity leads. The black shuttle represents your limitless potential taking you anywhere you can dream up, with no constraints or confines. The multicolored jet stream is your dazzling imagination, creativity

and joyful play that fuels a thrilling expedition. Remember, you're not alone on this journey, your loved ones can come along too: the expansive collection of Minifigure head options is the invitation extension to everyone. Whether you sit in the pilot seat or step into someone else's lived experience, the power of curious empathy and creative compassion will make the world a little brighter.

LA CURIOSITÉ COMME CARBURANT

Voici votre invitation : préparez-vous à décoller vers la lune ! Que vous désiriez exposer fièrement la navette ou construire ce véhicule unique avec votre famille pour vivre des aventures spatiales, nous vous encourageons à laisser libre cours à votre créativité. La navette noire représente votre potentiel illimité et peut vous transporter partout où vous le souhaitez, sans contraintes ni limites. Le courant-jet multicolore est le reflet de votre imagination et de votre créativité, le bonheur ludique qui

alimente une expédition palpitante. Vos proches peuvent vous accompagner dans ce voyage : la vaste collection d'options de têtes de figurines permet à tout le monde de partir à l'aventure. Que vous preniez place dans le siège du pilote ou que vous exploriez le vécu de quelqu'un d'autre, le pouvoir de l'empathie curieuse et de la compassion créative rendra le monde un peu plus radieux.

PROPULSADO POR LA CURIOSIDAD

¡Te invitamos a prepararte para despegar rumbo a la Luna! Ya sea que conviertas el transbordador en una pieza de exhibición o que construyas este exclusivo vehículo con tu familia para interpretar aventuras espaciales, te animamos a dejarte llevar por tu creatividad. El transbordador negro representa cómo tu ilimitado potencial será capaz de llevarte a cualquier lugar que puedas soñar, sin restricciones ni límites. La estela multicolor es tu deslumbrante imaginación y creatividad, y también el juego

alegre que alimenta una emocionante expedición. Recuerda que no tienes por qué hacer solo este viaje y que tus seres queridos pueden acompañarte: la amplia colección de cabezas de minifigura hace extensiva la invitación a todas esas personas especiales para ti. Tanto si ocupas el asiento del piloto como si ves la vida a través de los ojos de otro para comprender su experiencia, el poder de la empatía curiosa y la compasión creativa harán del mundo un lugar un poco más radiante.

Your limitless potential taking you anywhere you imagine.

Votre potentiel illimité vous mènera jusqu'au bout de votre pensée.

Tu ilimitado potencial será capaz de llevarte a cualquier lugar que imagines.

Imagination, creativity and play as fuel.

L'imagination, la créativité et le jeu vous serviront de carburant.

Imaginación, creatividad y juego como combustible.

Inviting everyone to put themselves in the pilot seat.

Chacun pourra prendre place dans le siège du pilote.

Invita a todos a ocupar el asiento del piloto.

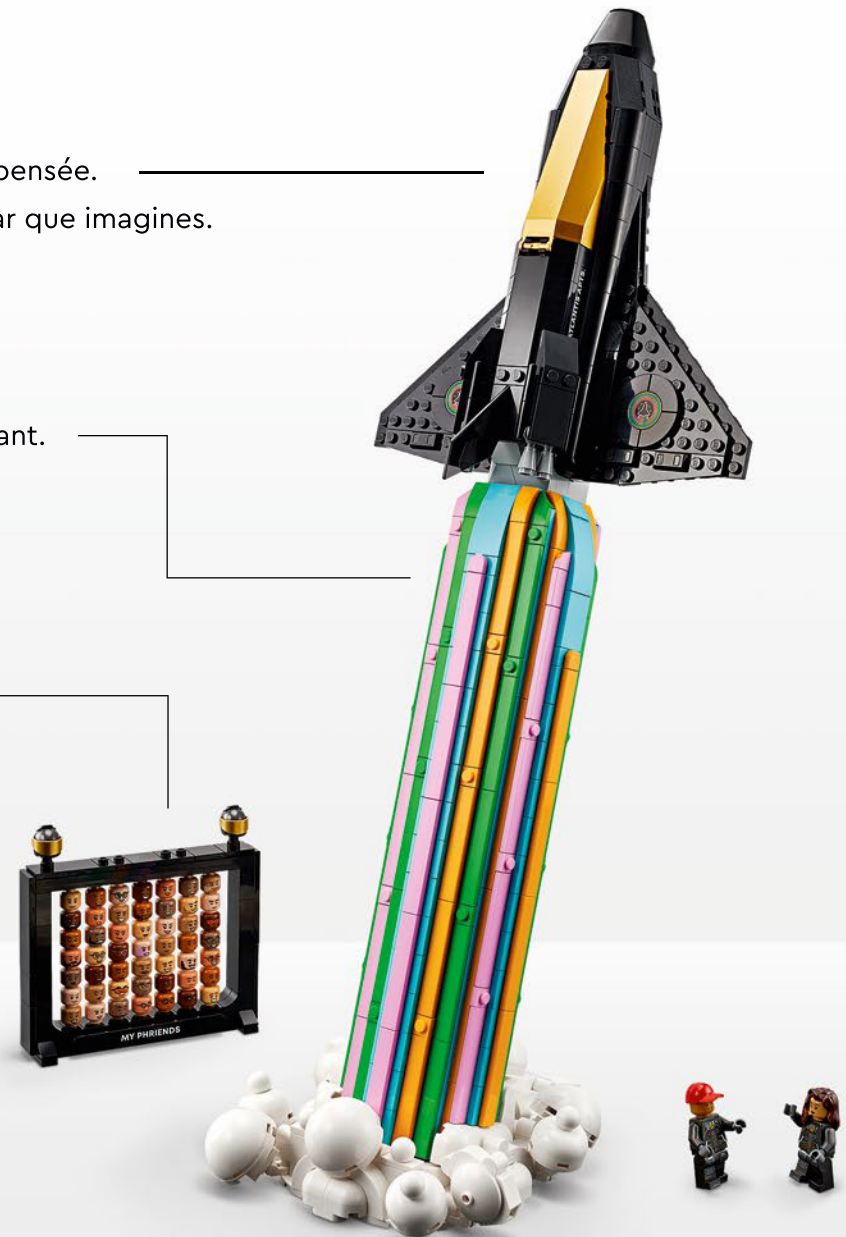

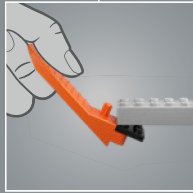
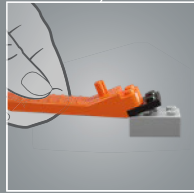
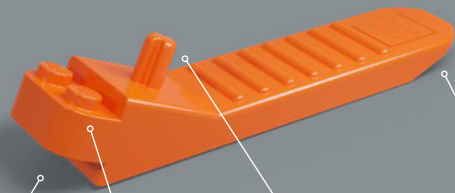

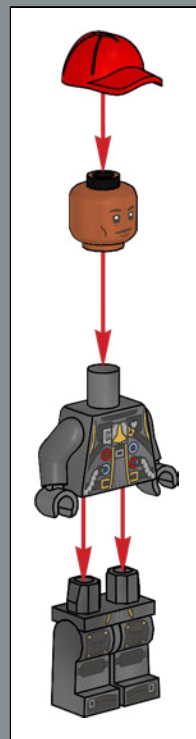
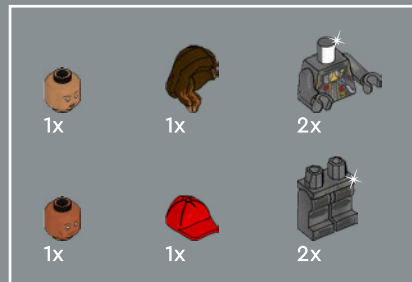

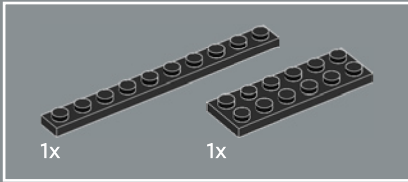
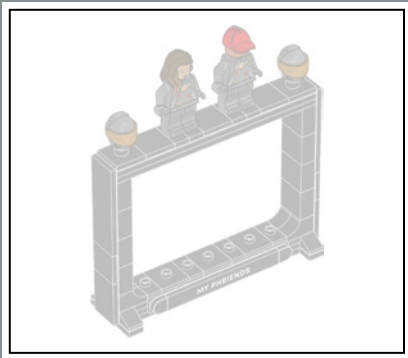

1

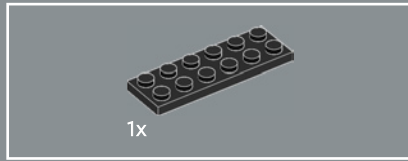
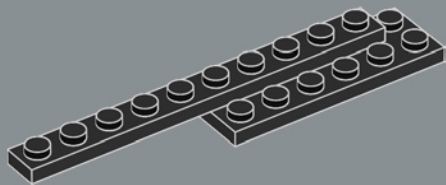

2

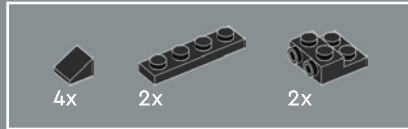
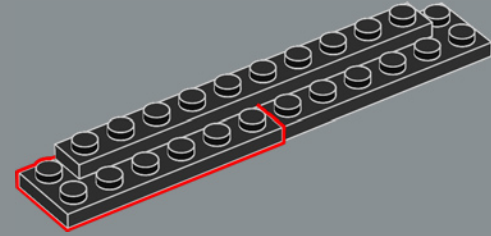

3

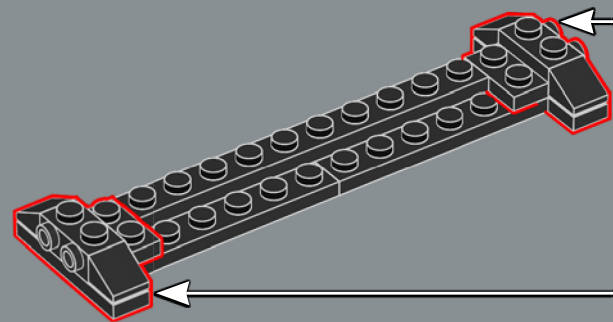
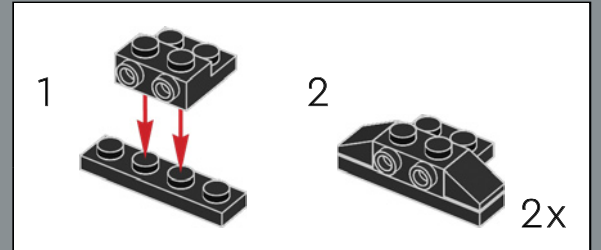



4

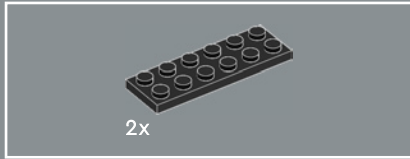
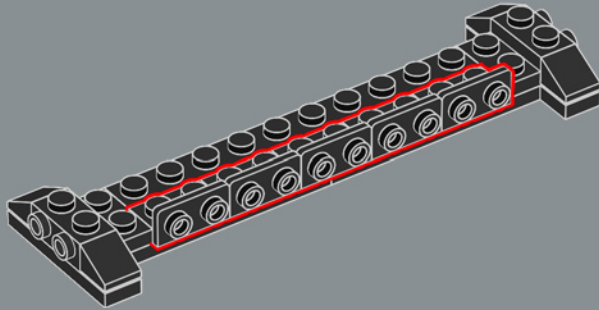

5

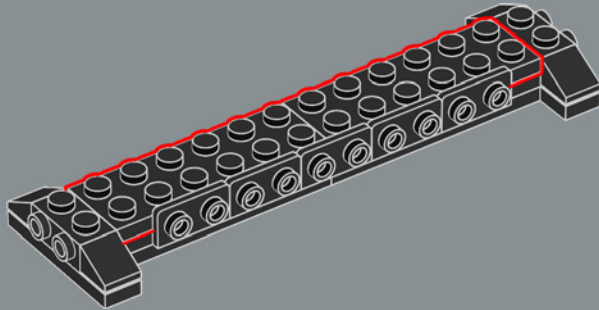

6

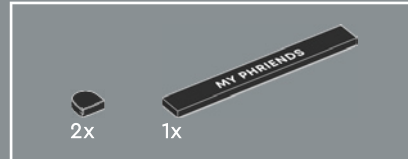
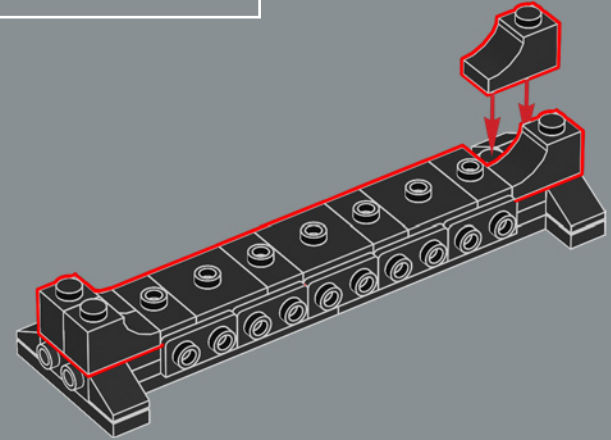

7

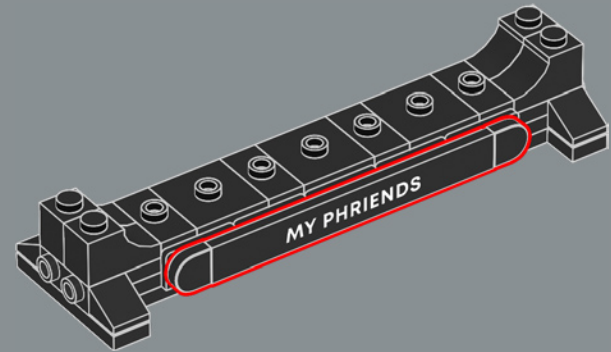



2x

8

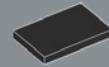
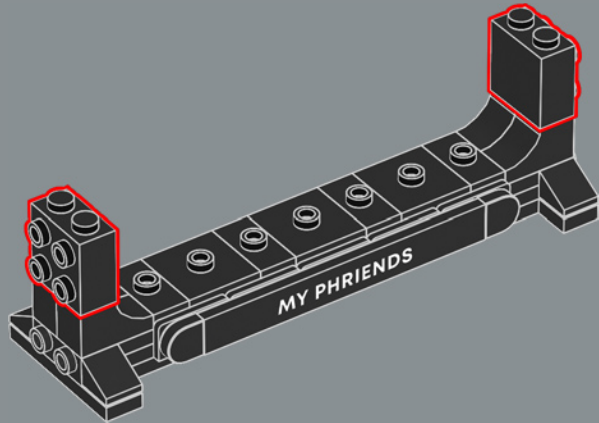

2x

9

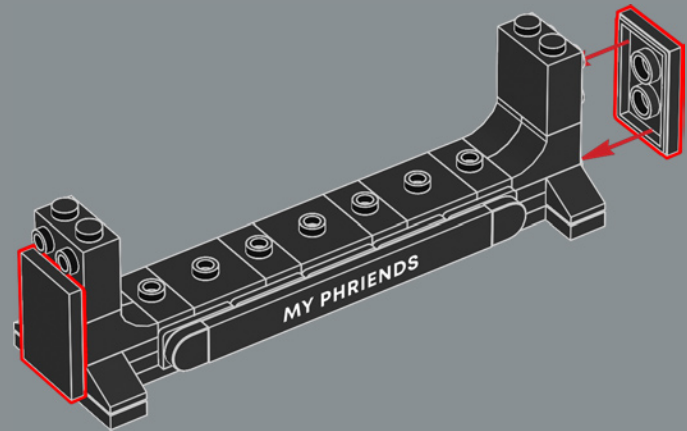

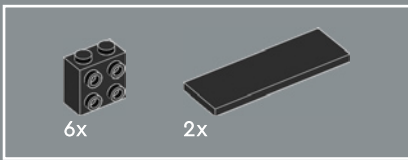

10

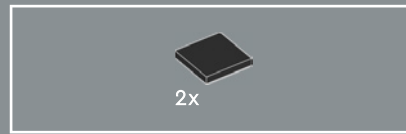
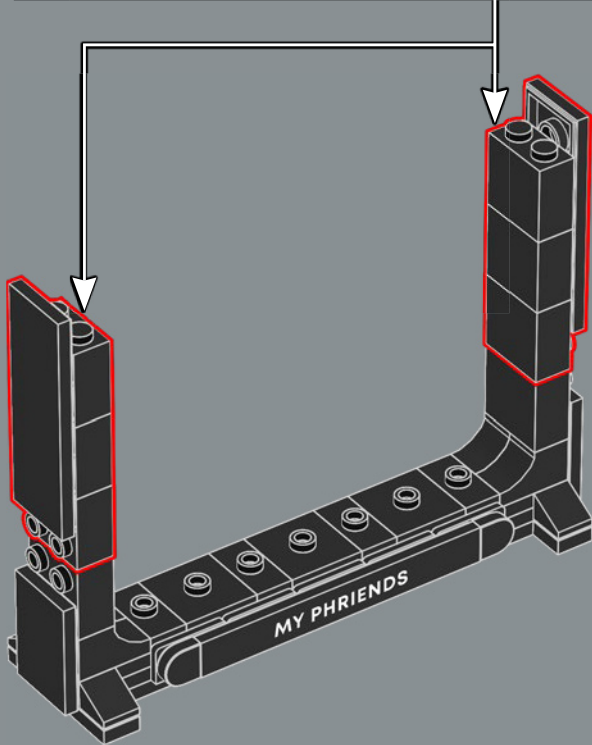
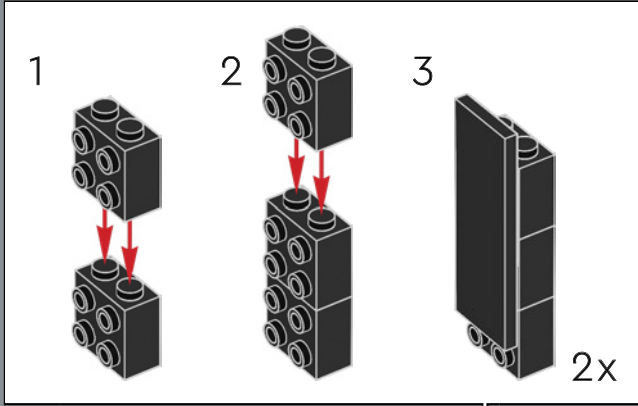

11

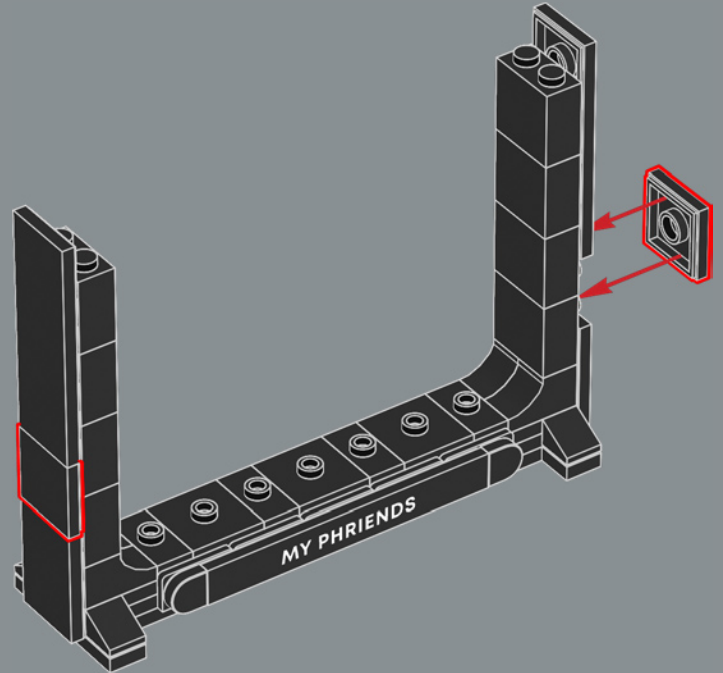

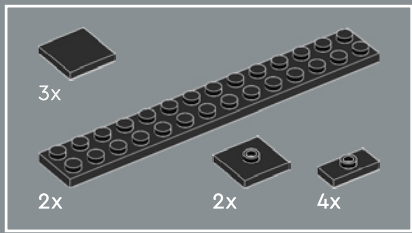

12

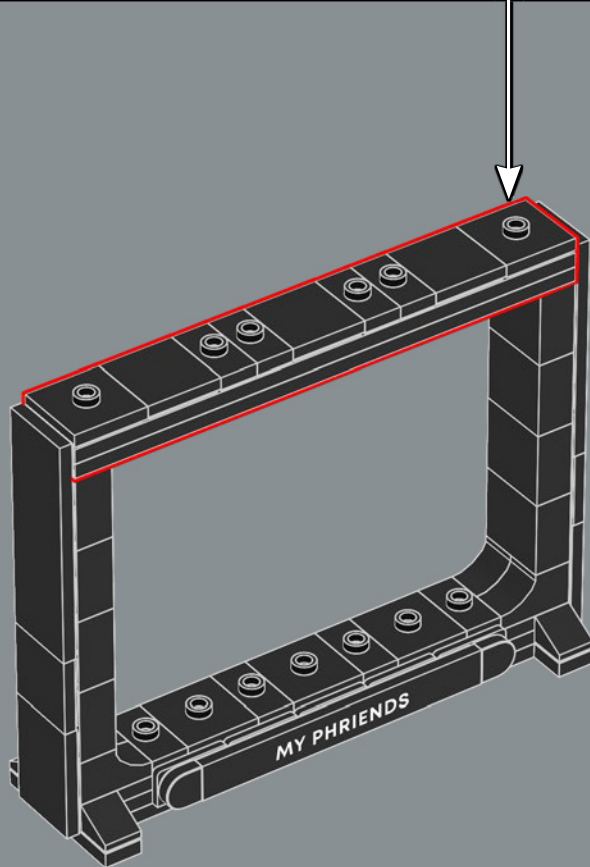
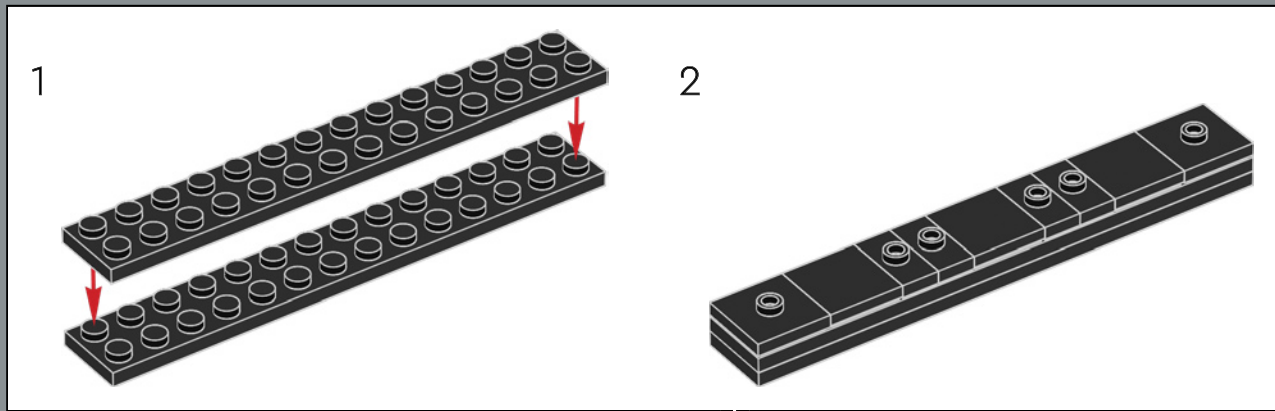



13

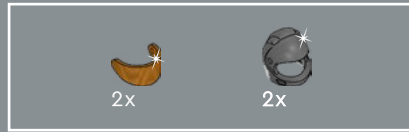
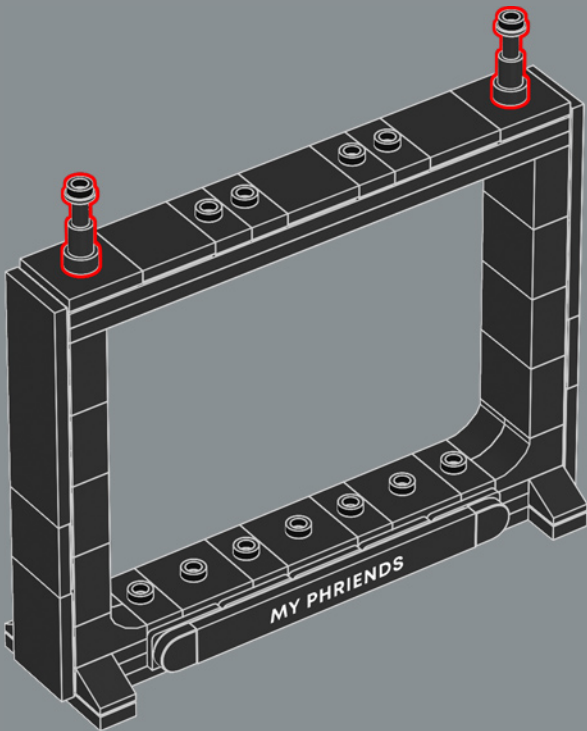

14

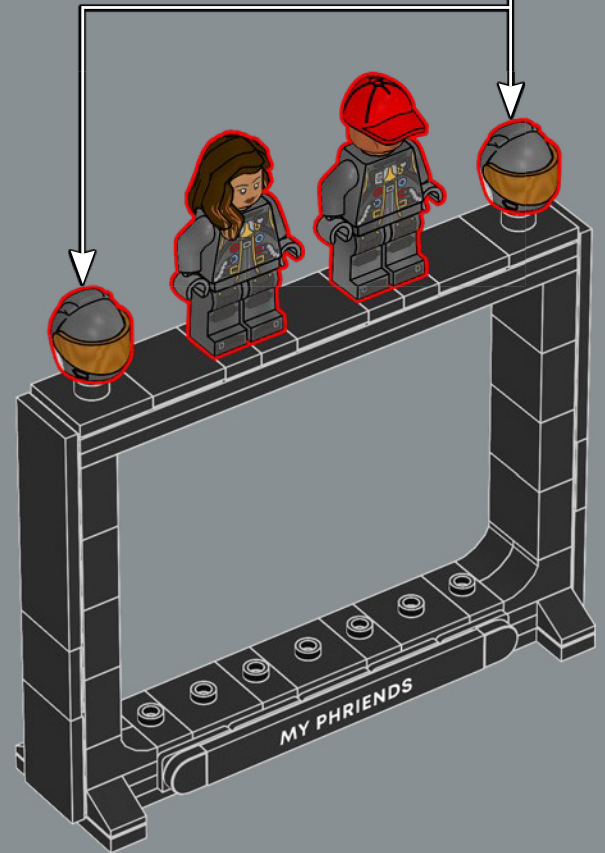
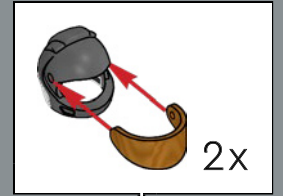

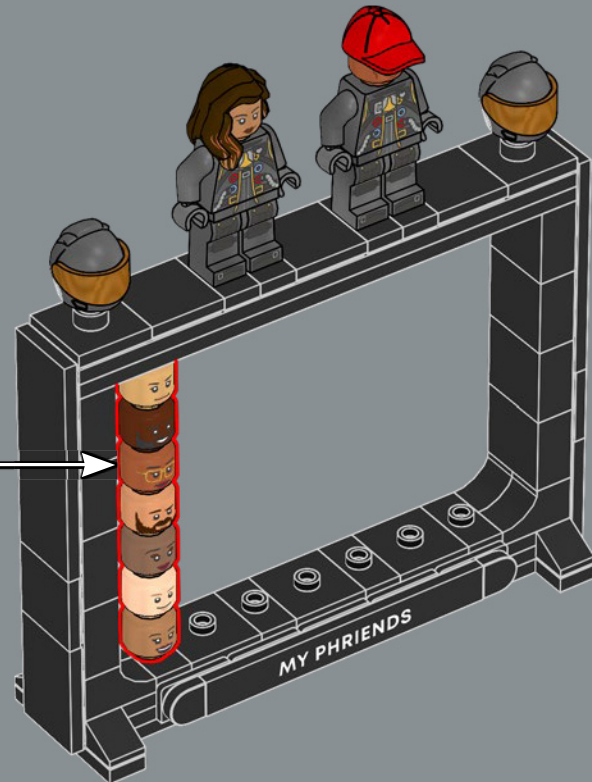
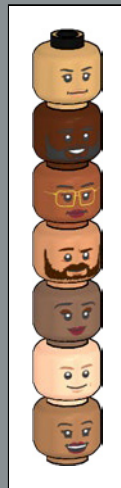
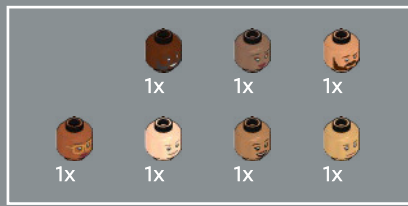

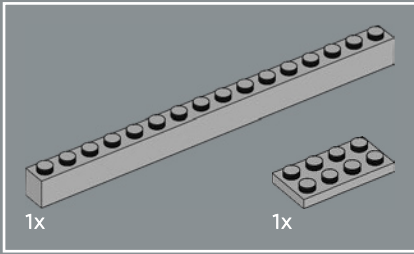
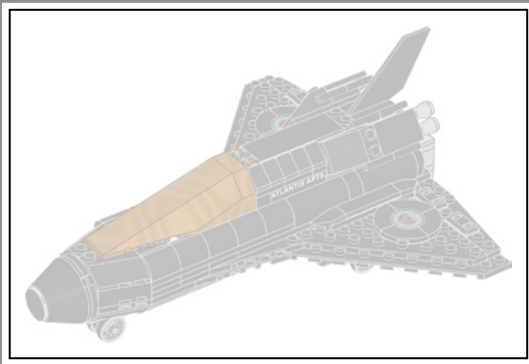

1

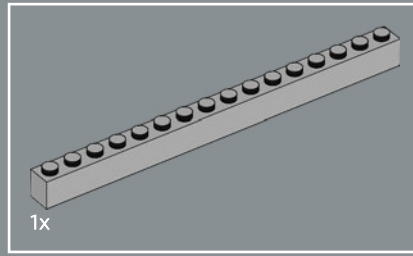
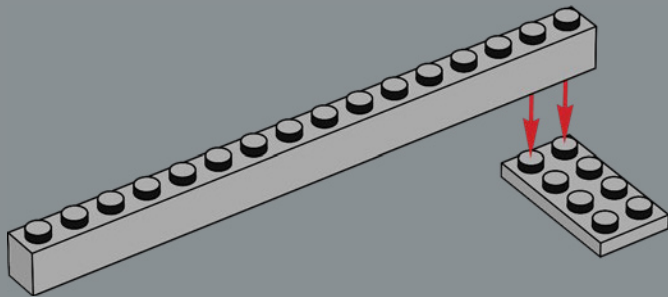

2

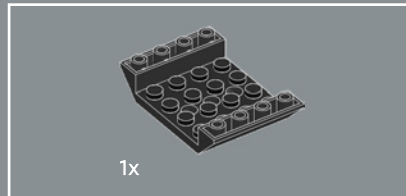
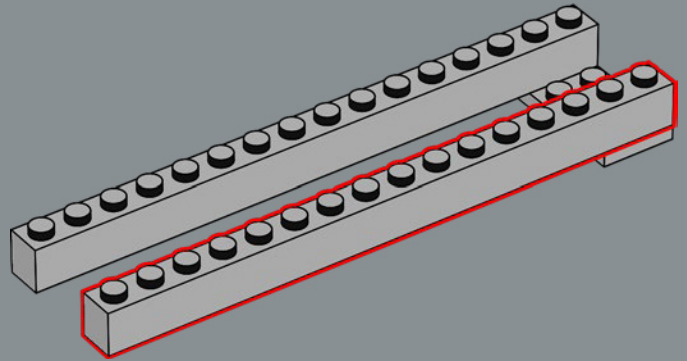

3

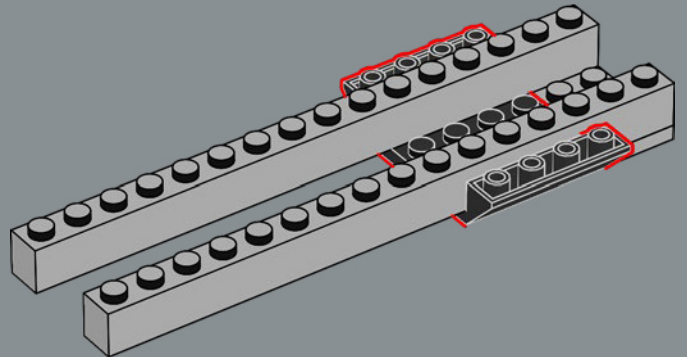

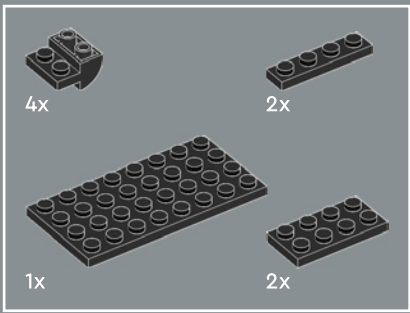

4

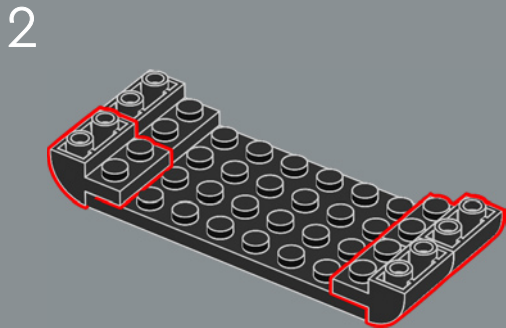
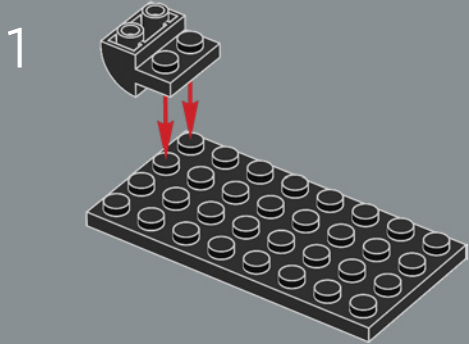

3

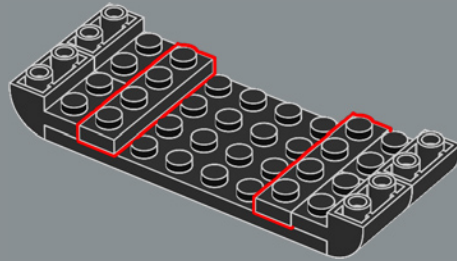

4

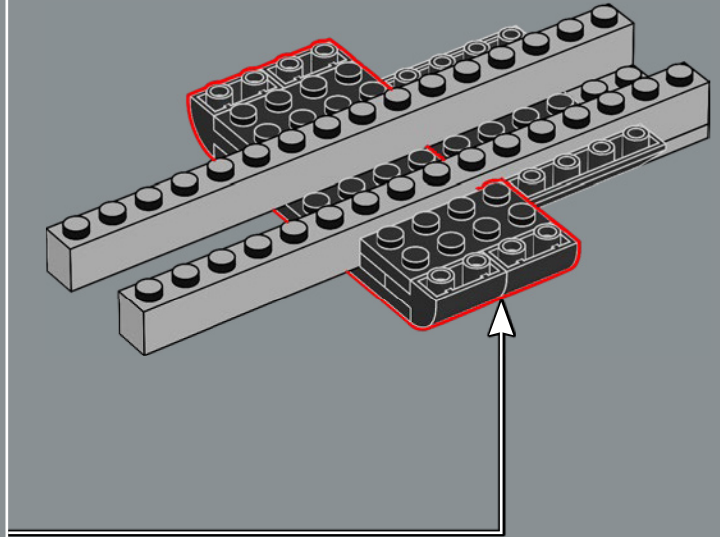
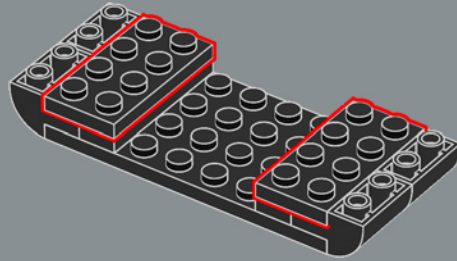

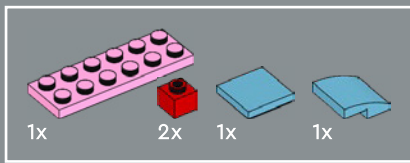

5

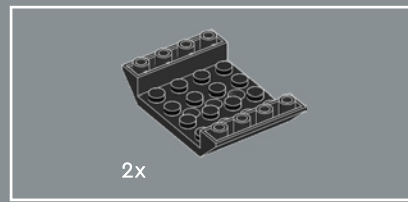
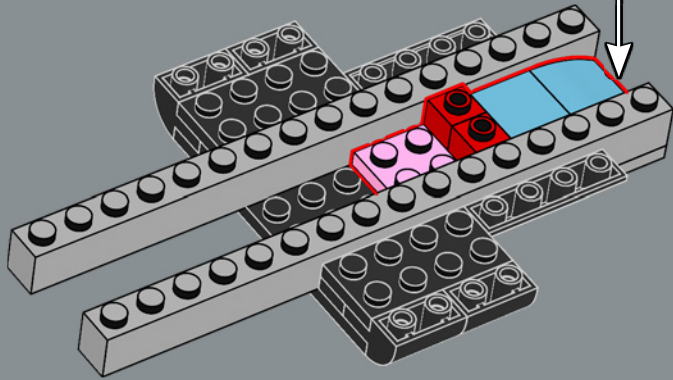
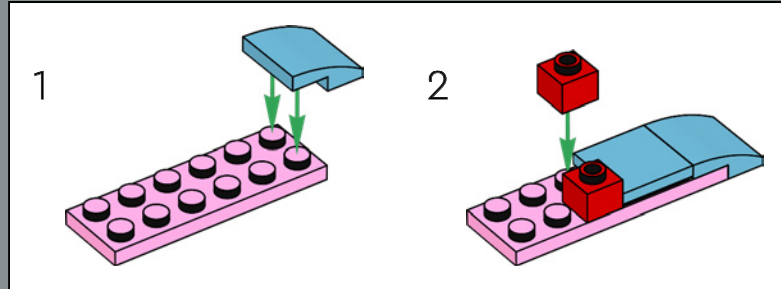

6

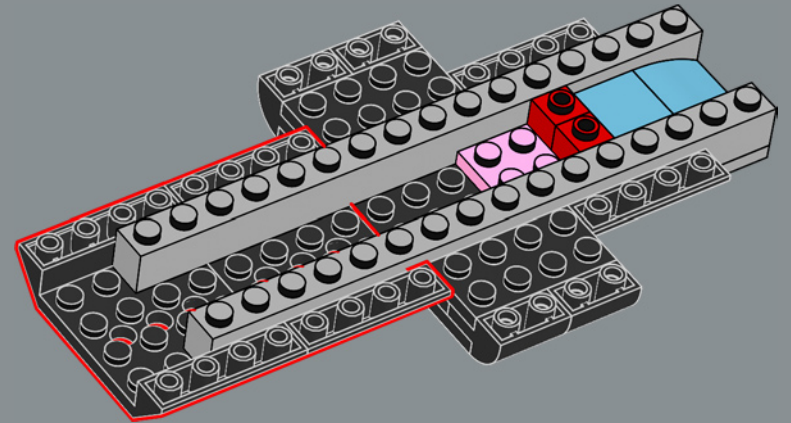

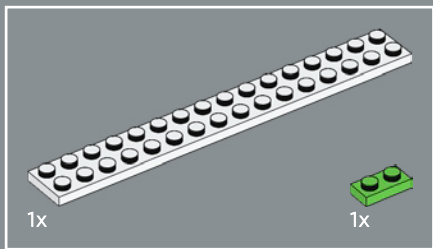

7

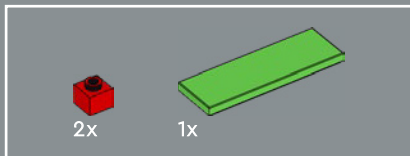
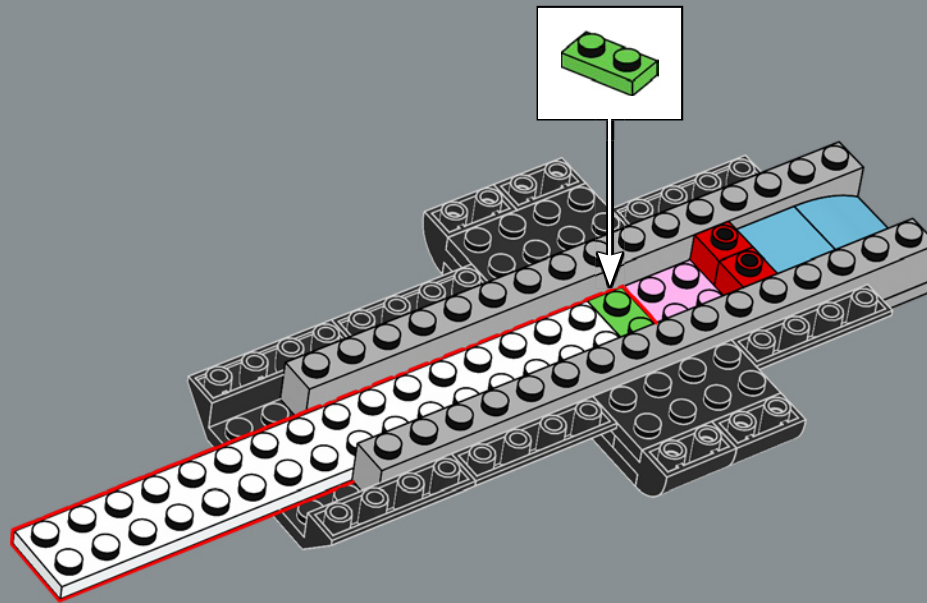

8

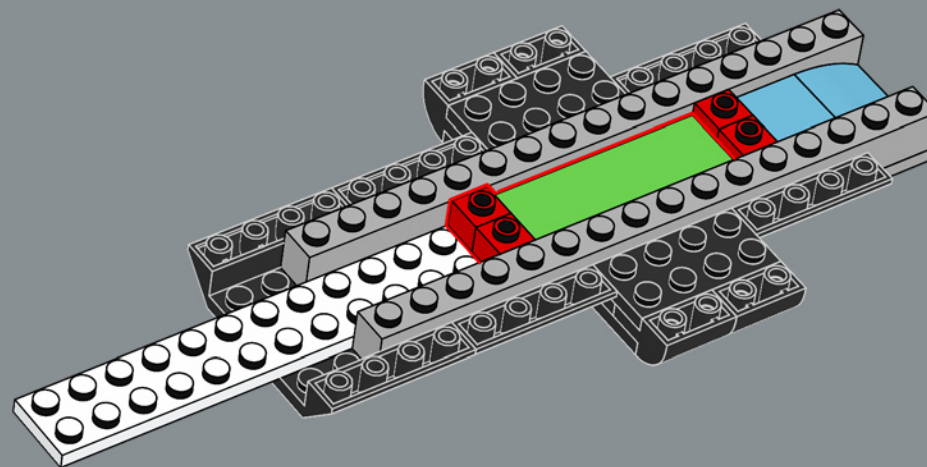

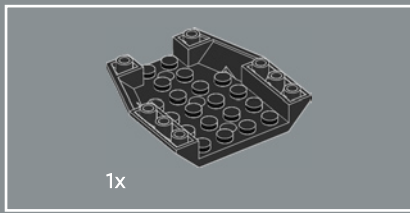

9

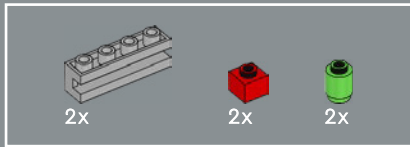
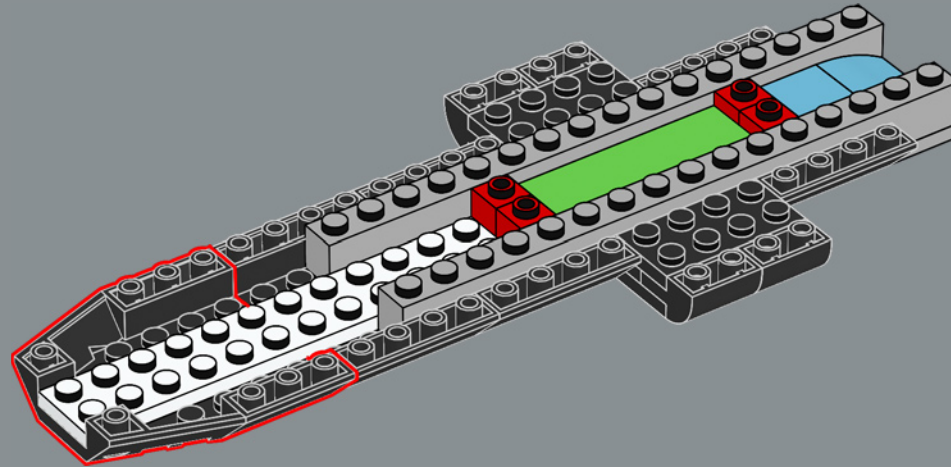

10

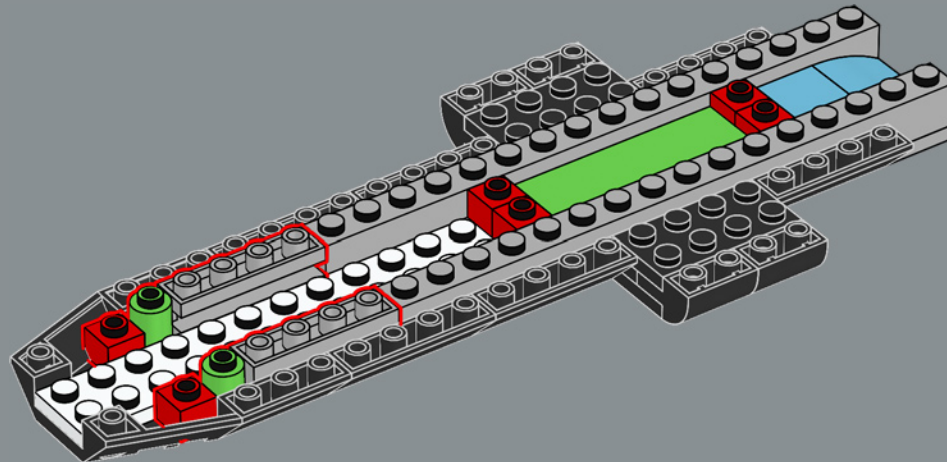

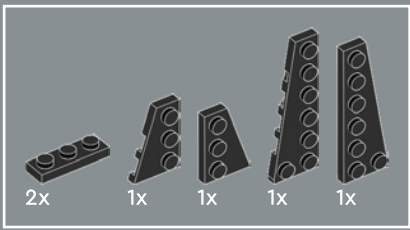

11

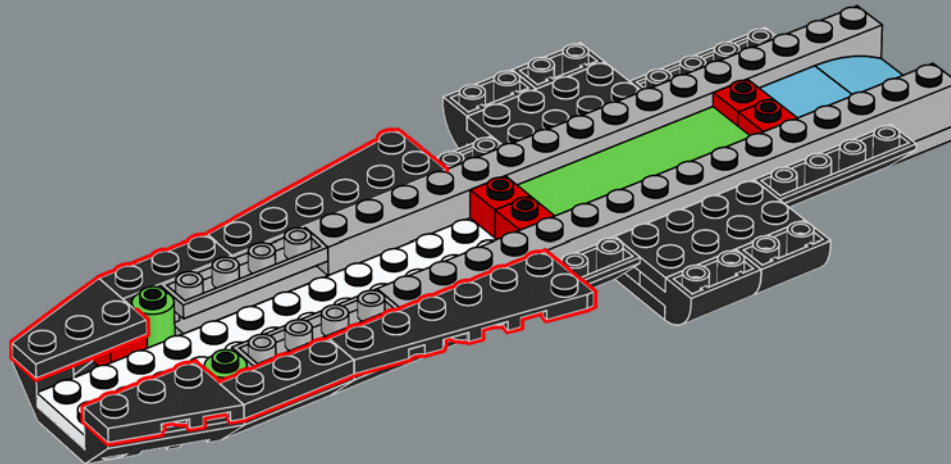

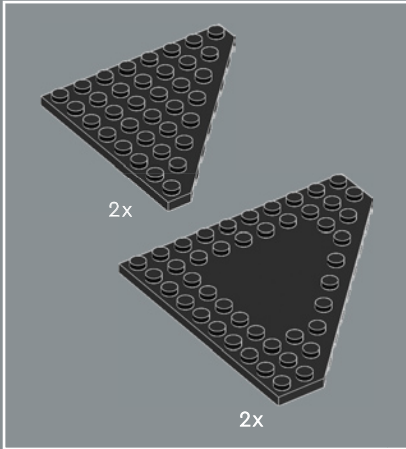
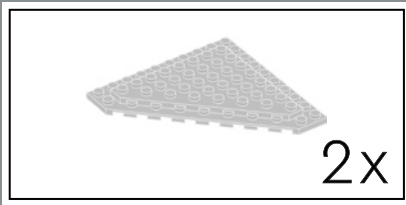

1

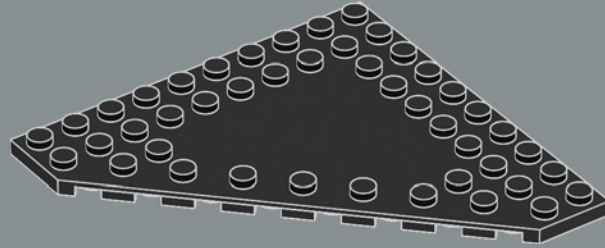

2

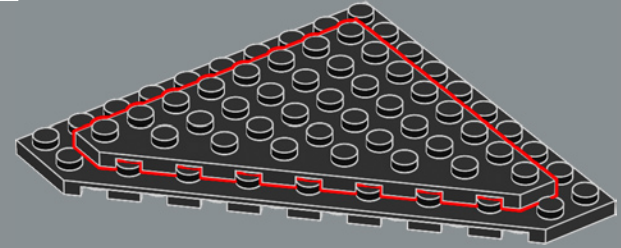

2x

12

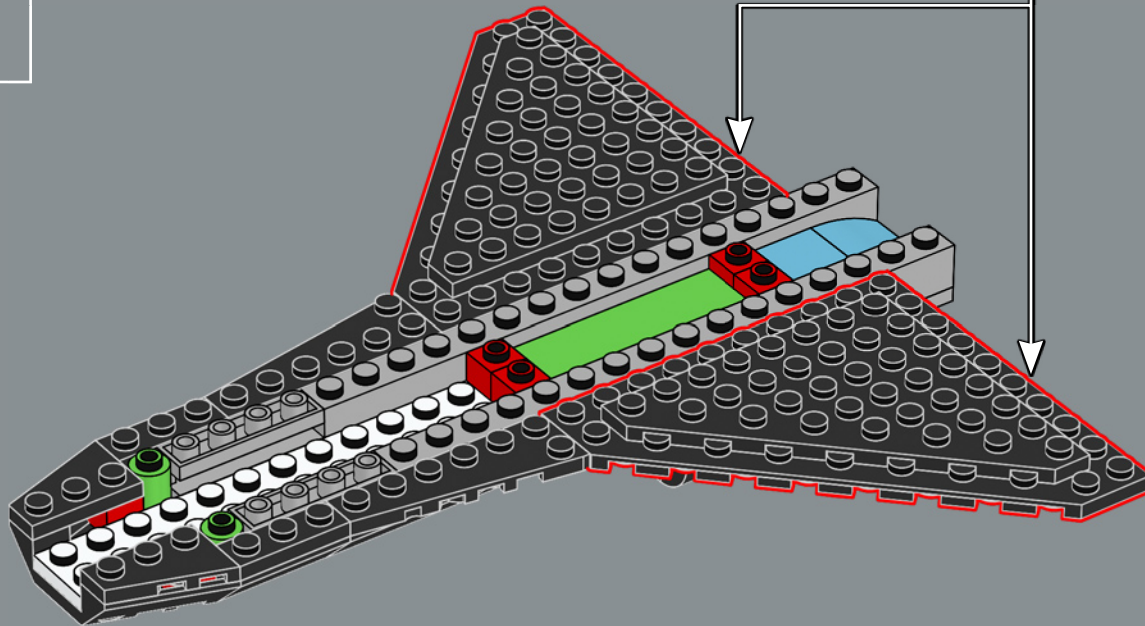

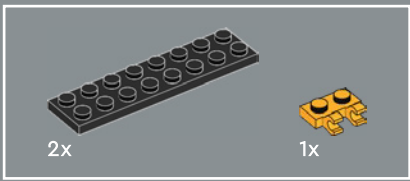

13

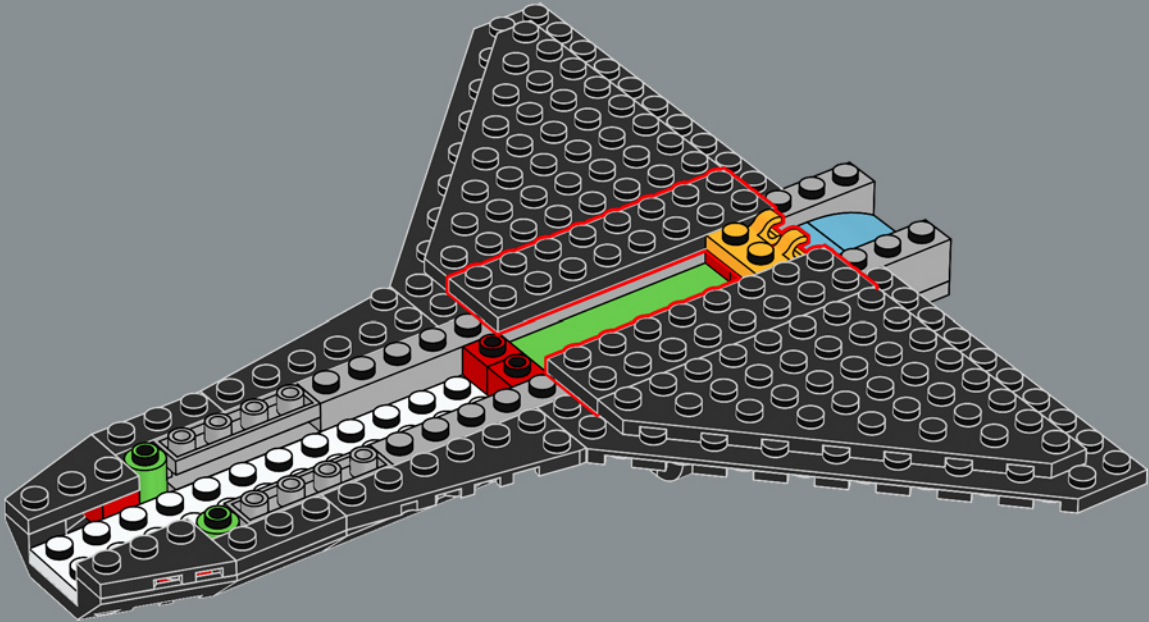

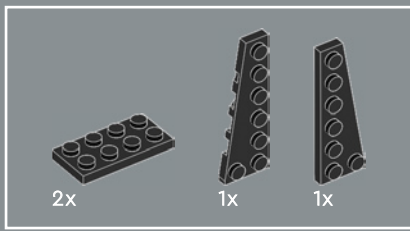

14

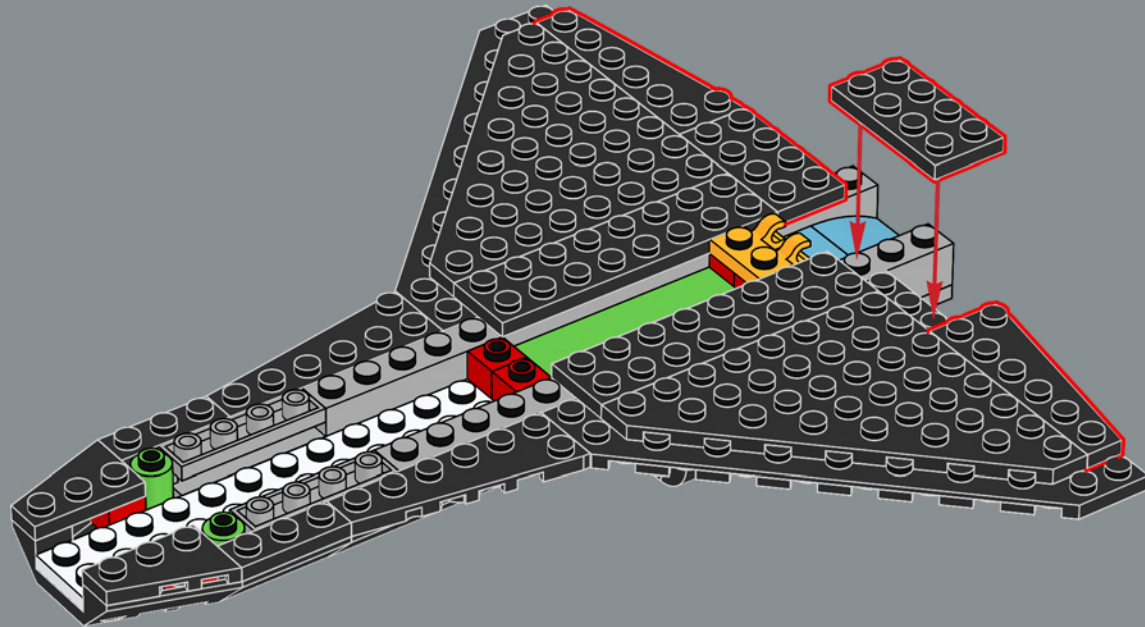

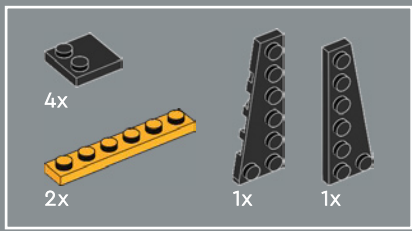

15

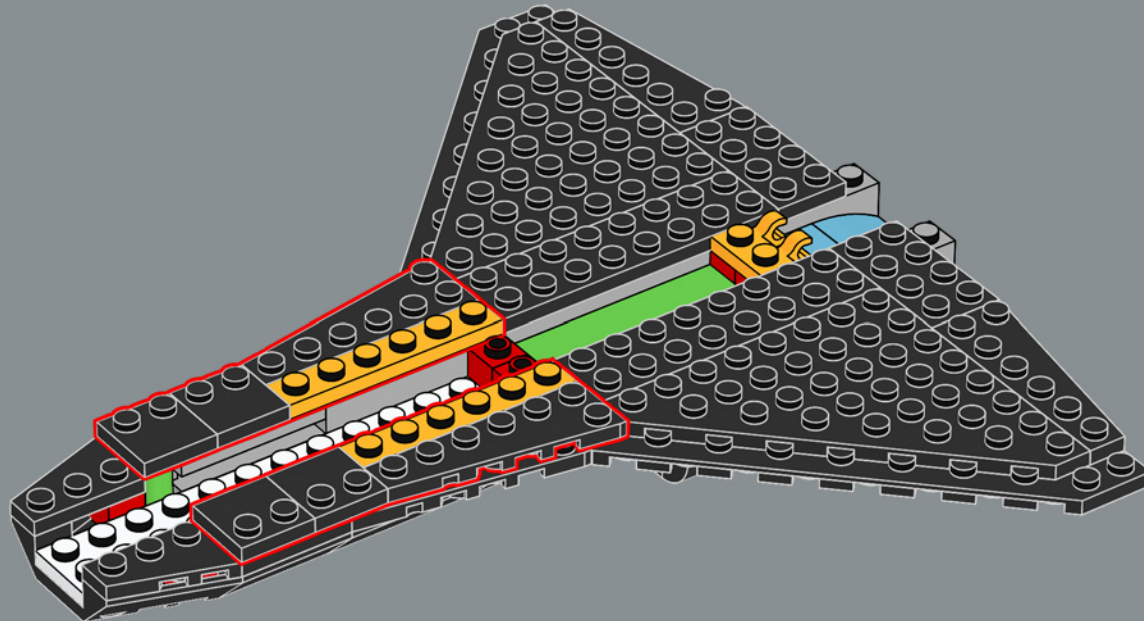

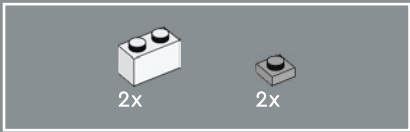

16

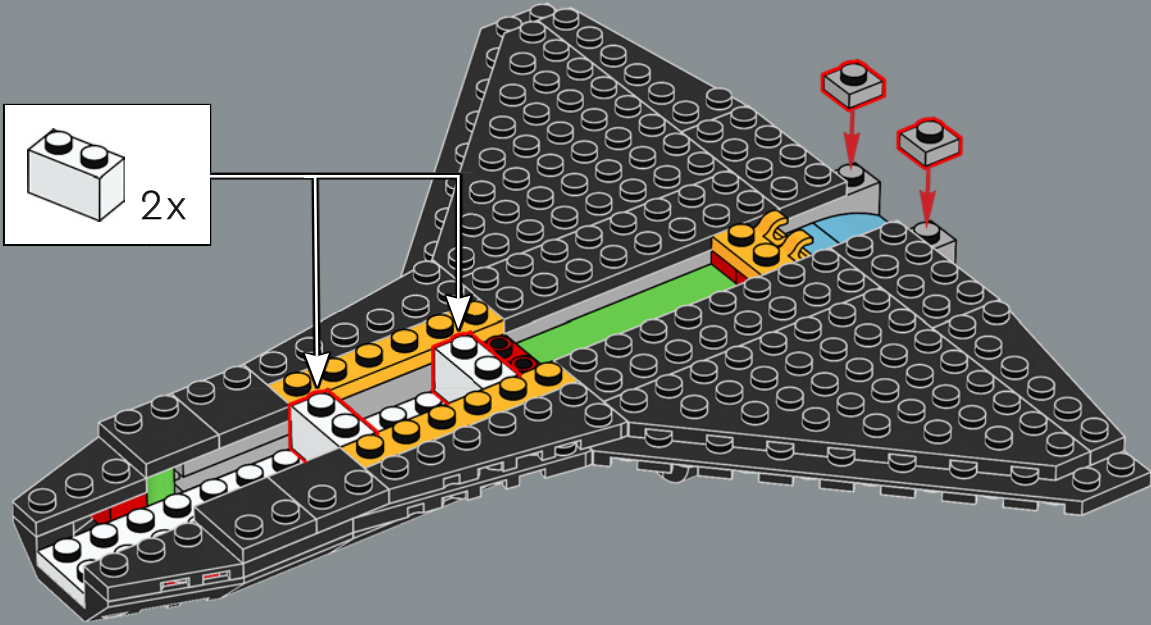

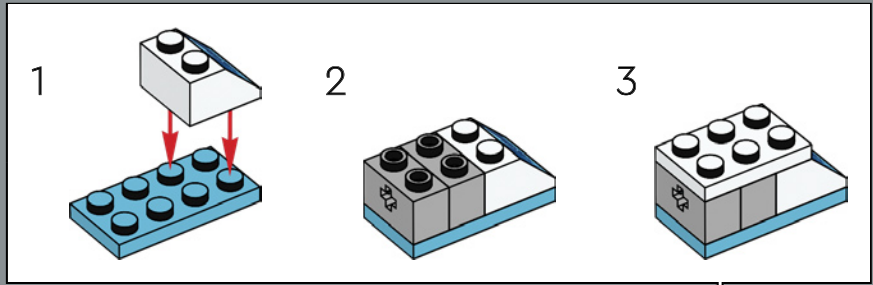
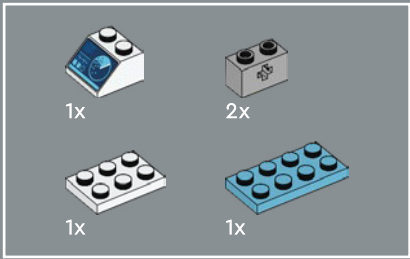

17

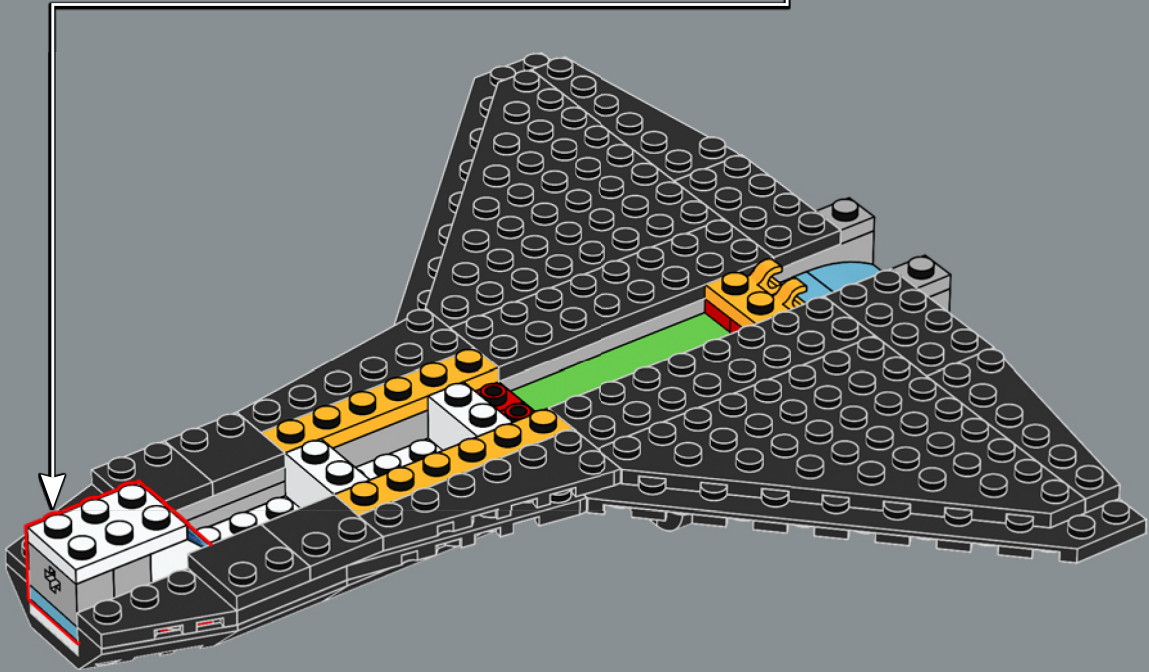

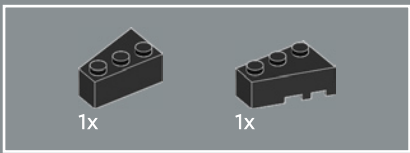

18

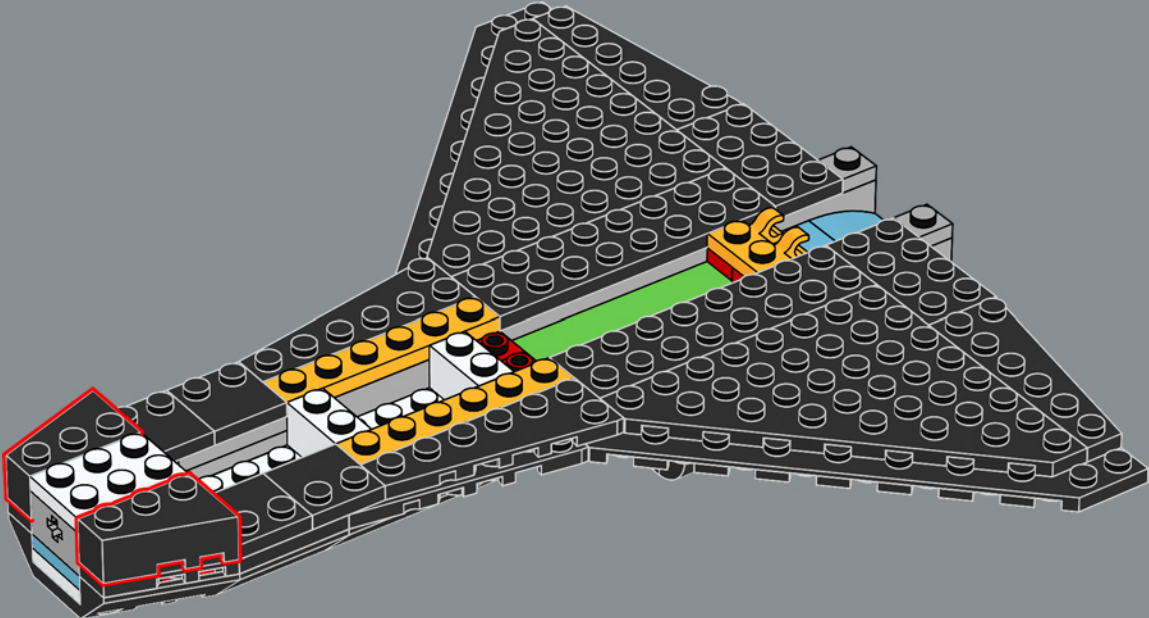

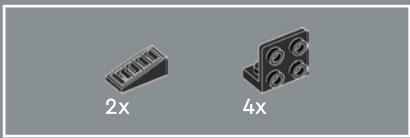

19

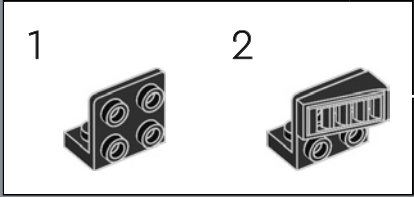
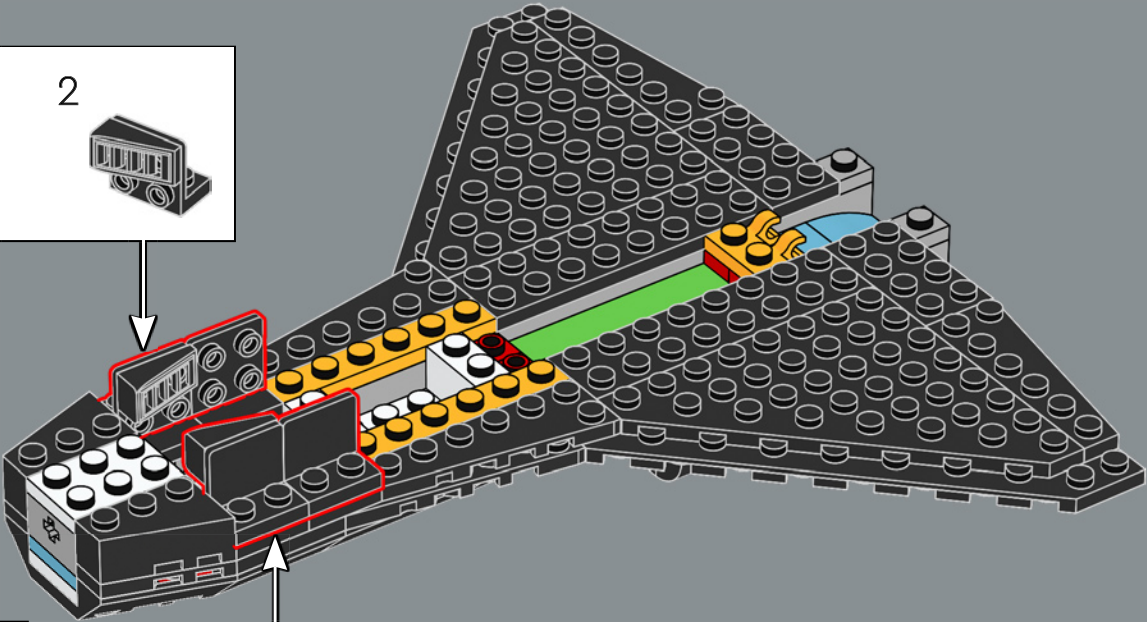
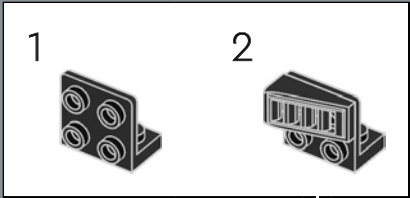

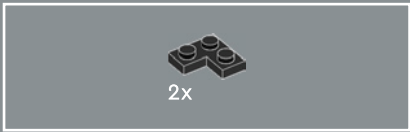

20

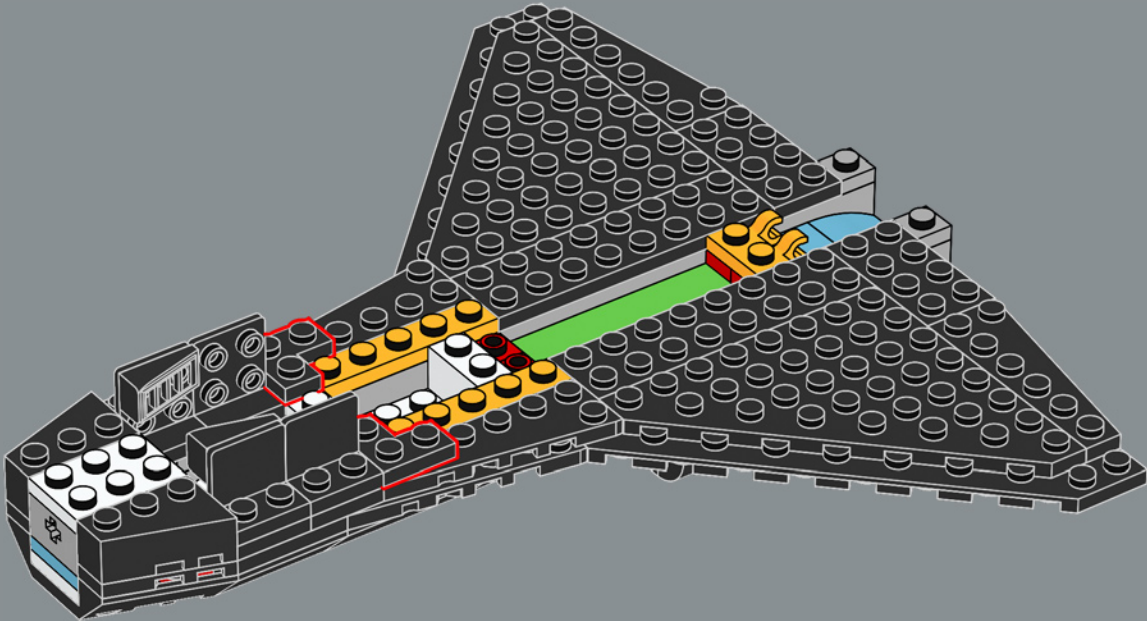

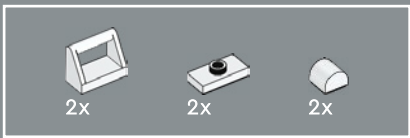

21

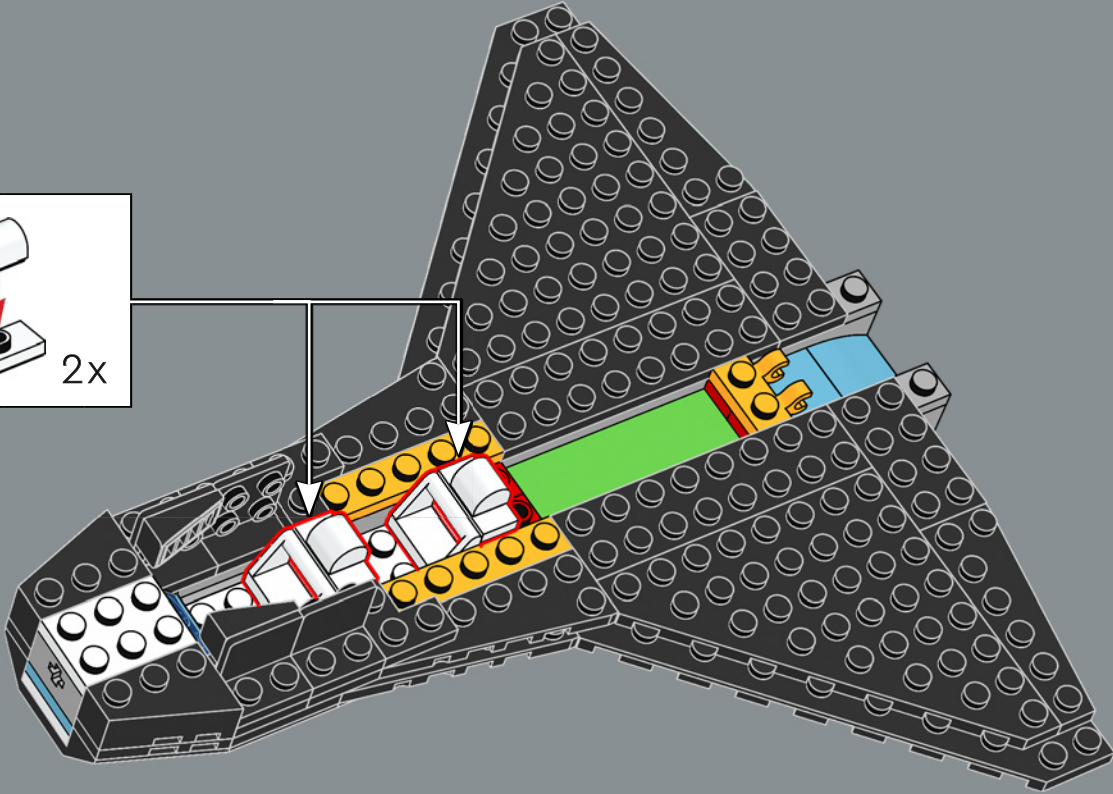
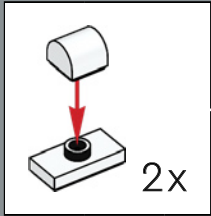

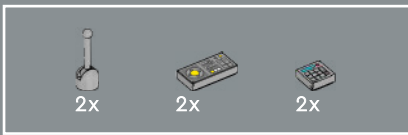

22

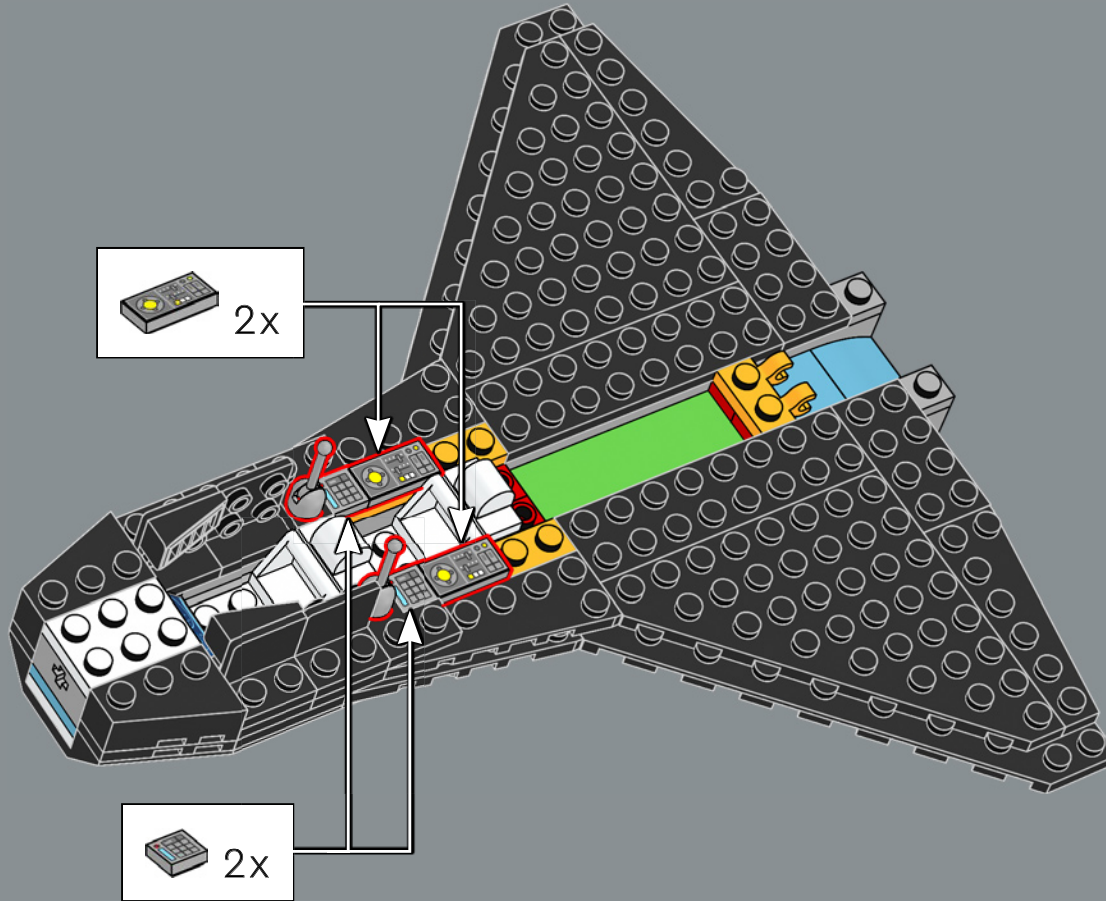

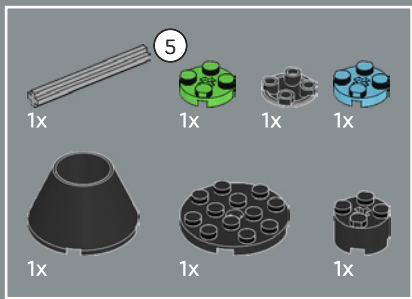

23

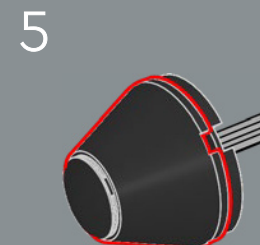
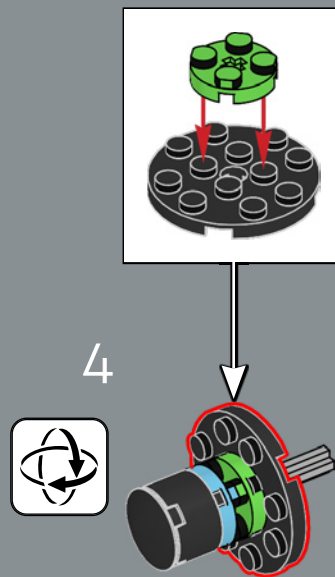
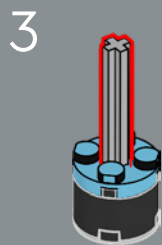
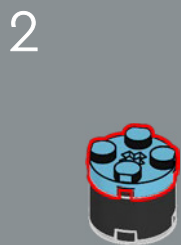
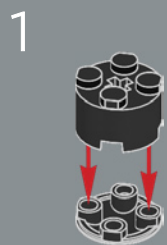

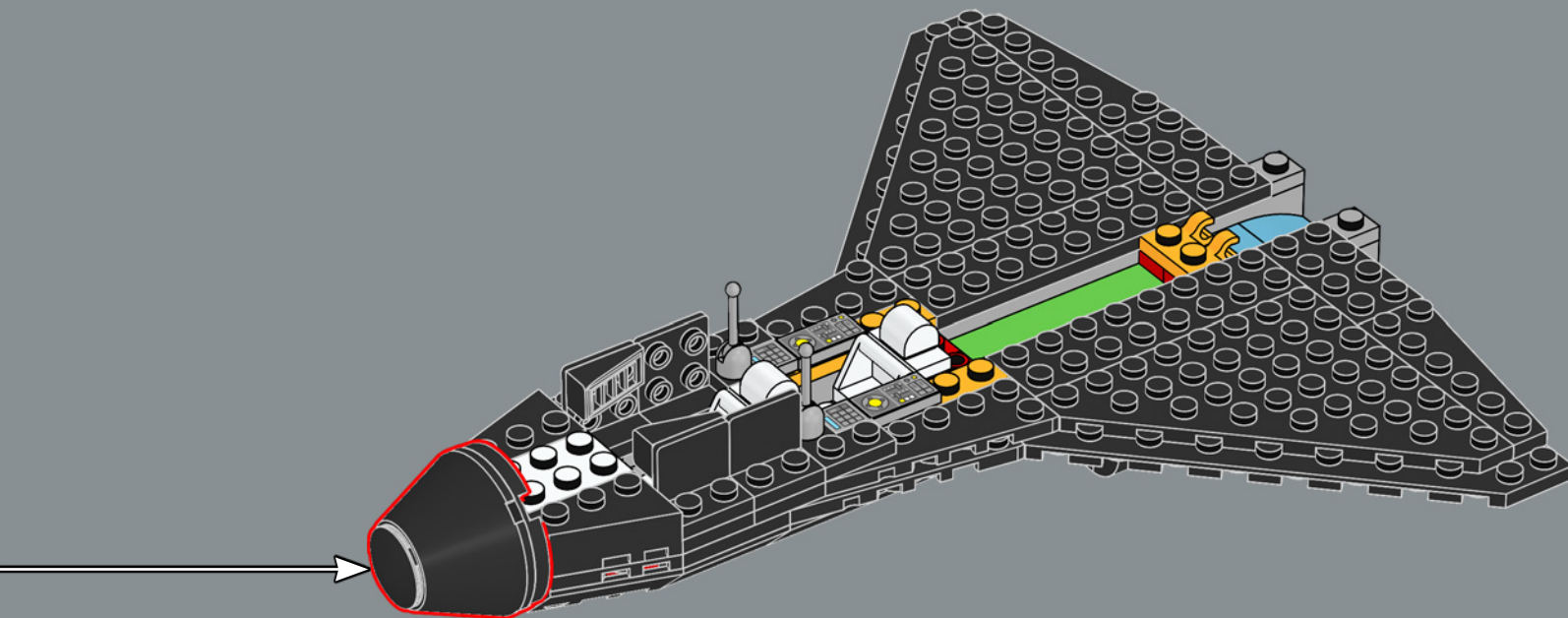

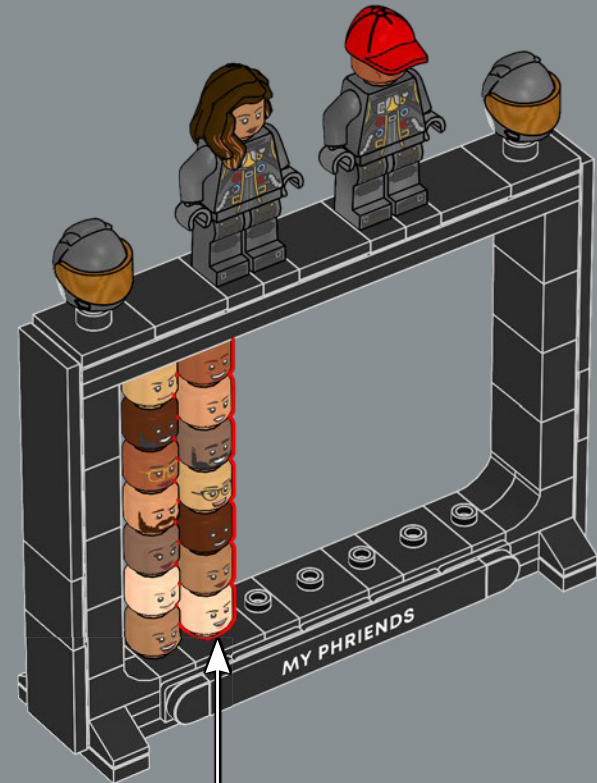
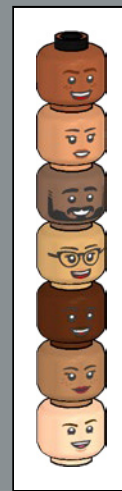
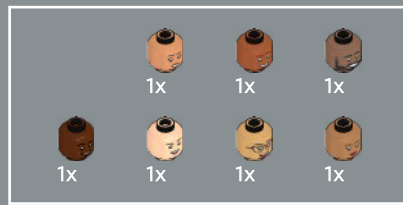
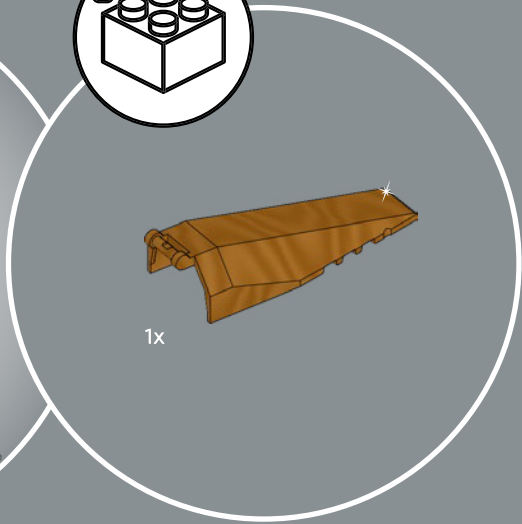
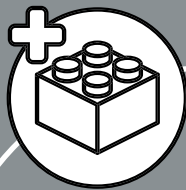

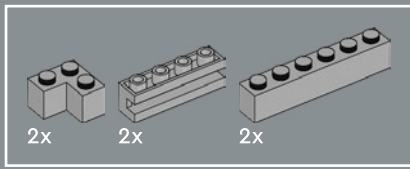

24

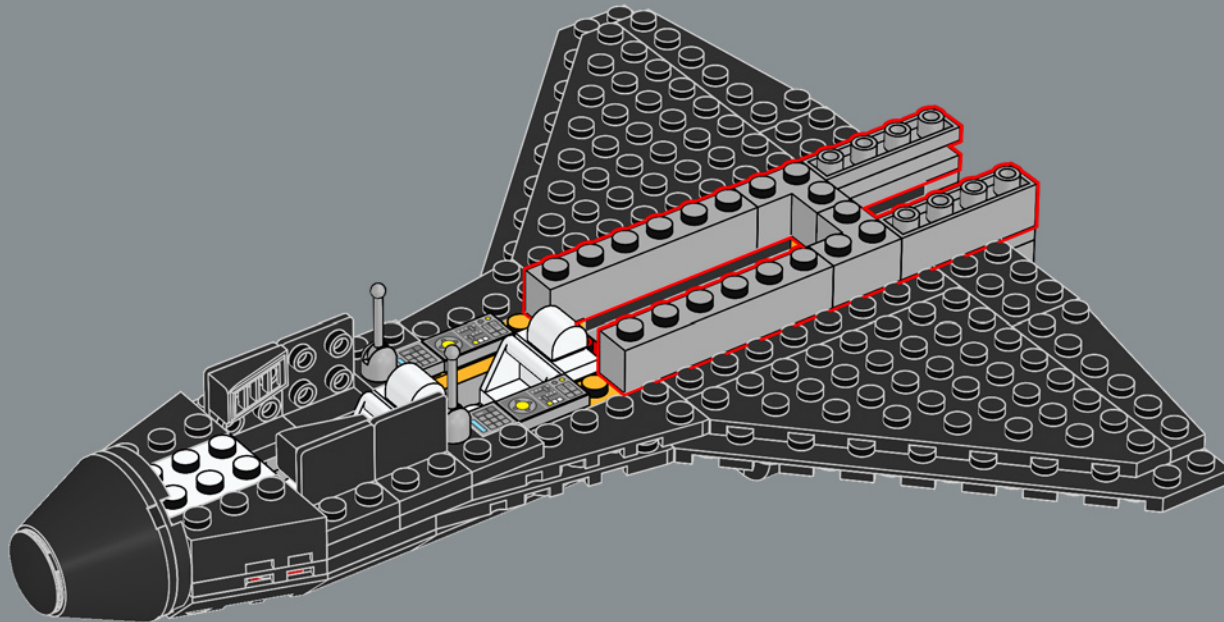

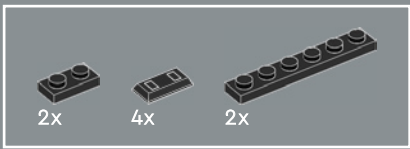

25

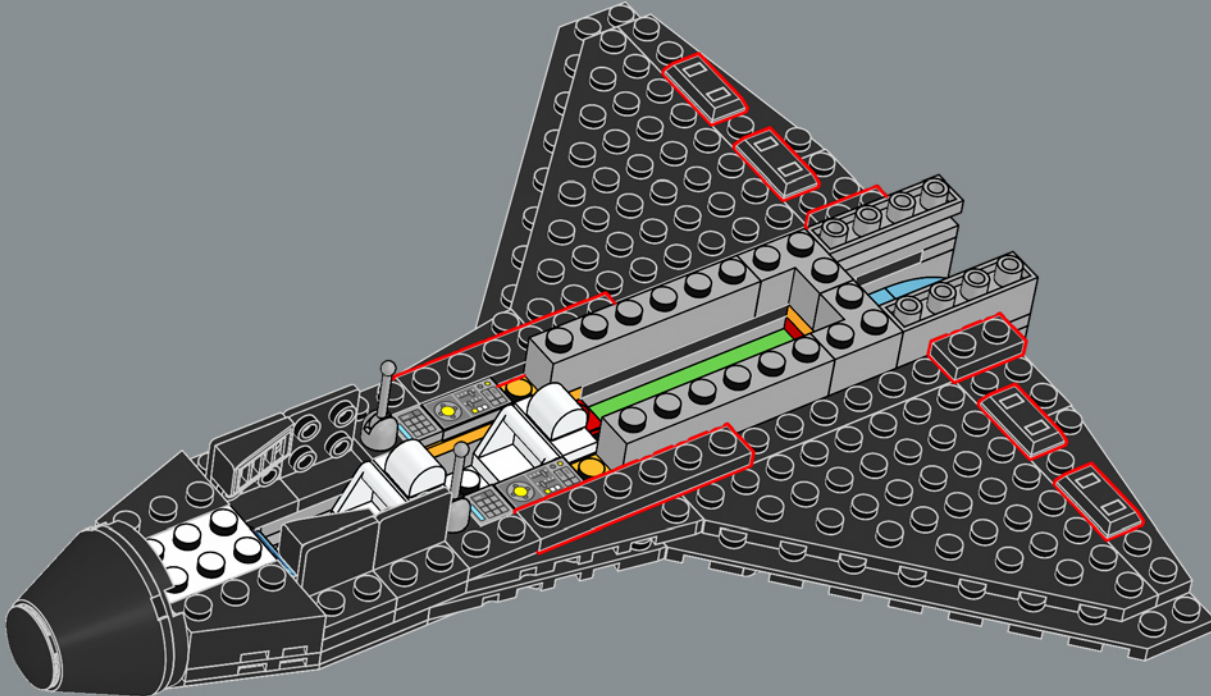

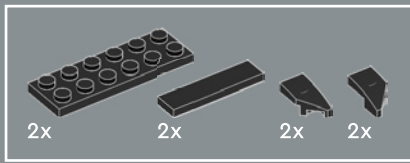

26

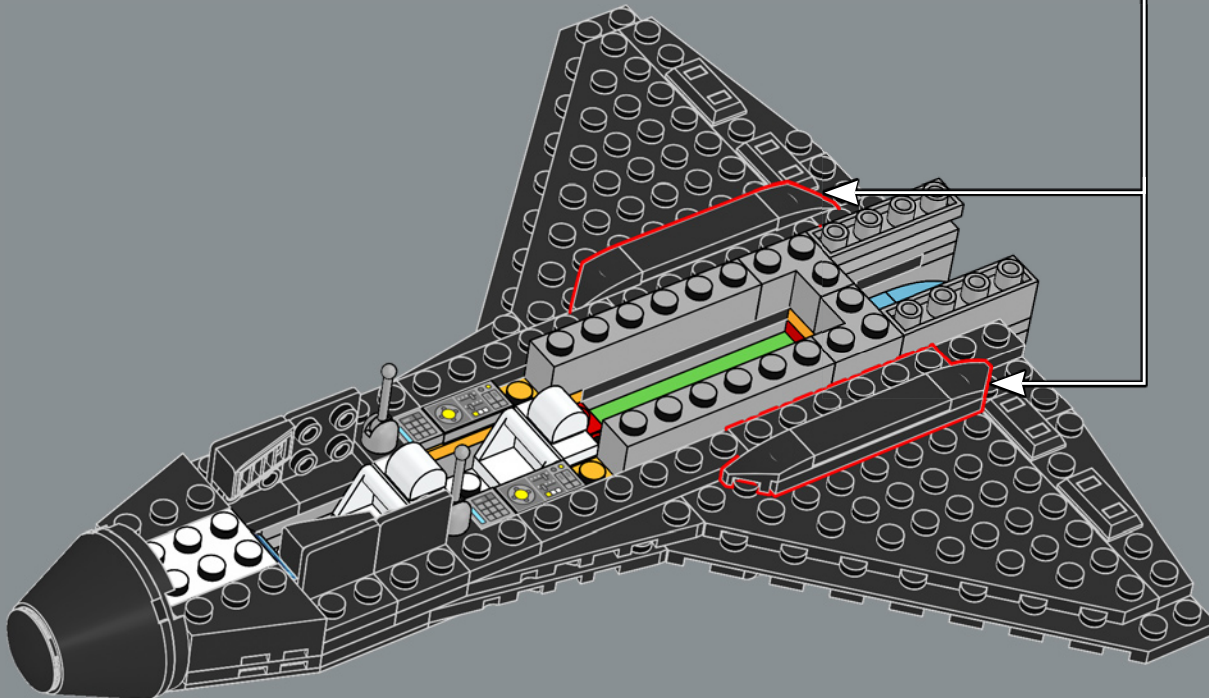
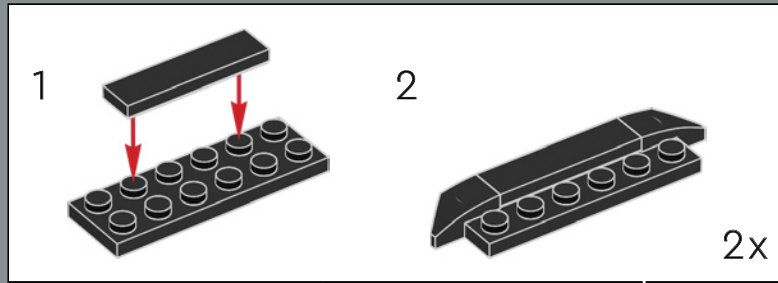



8x



2x

27

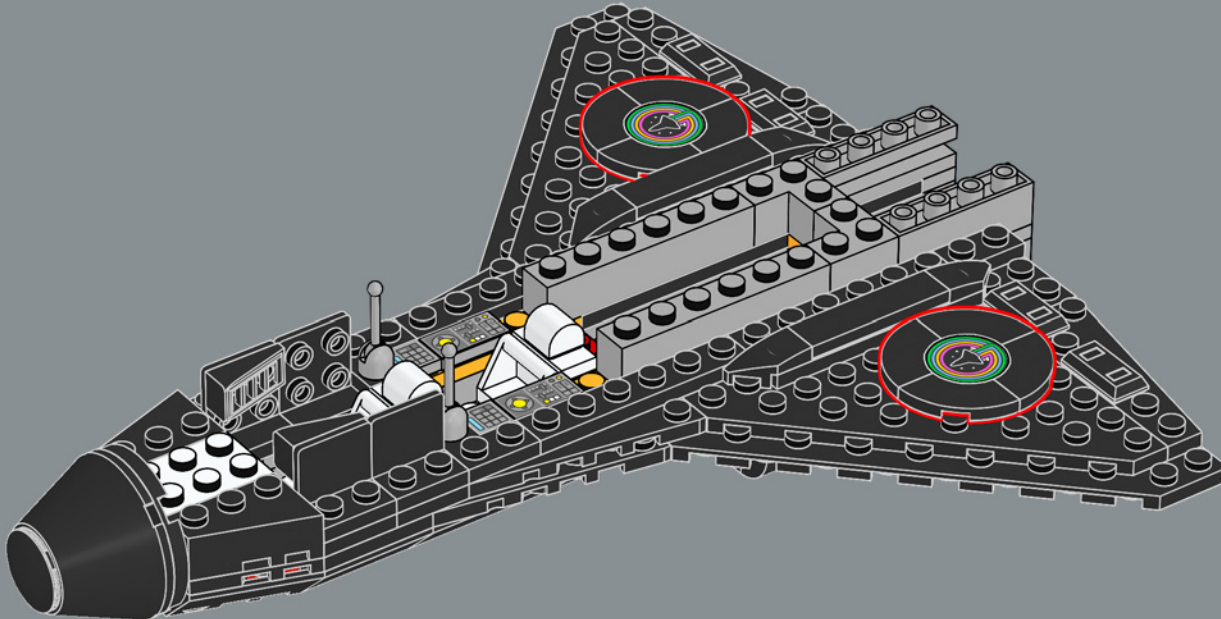

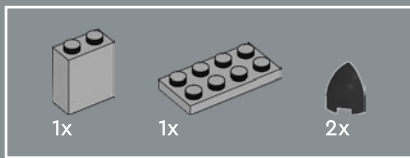

28

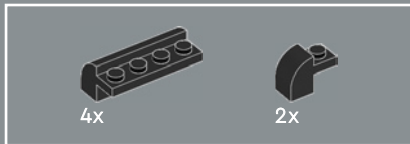
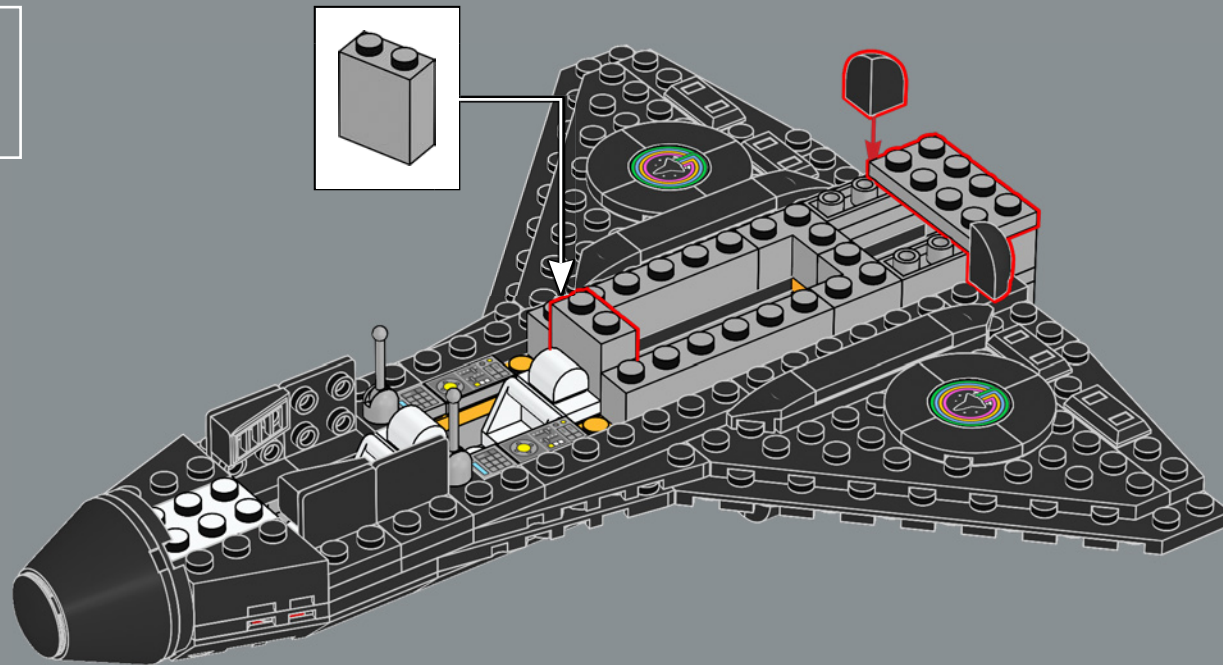

29

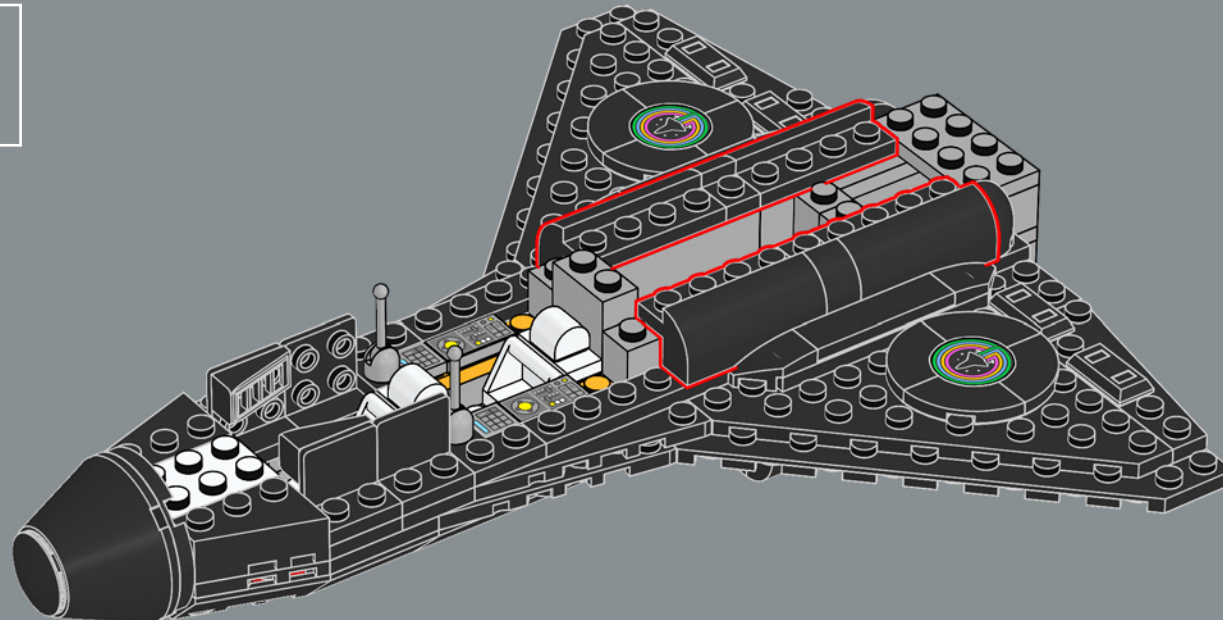

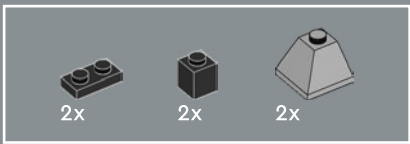

30

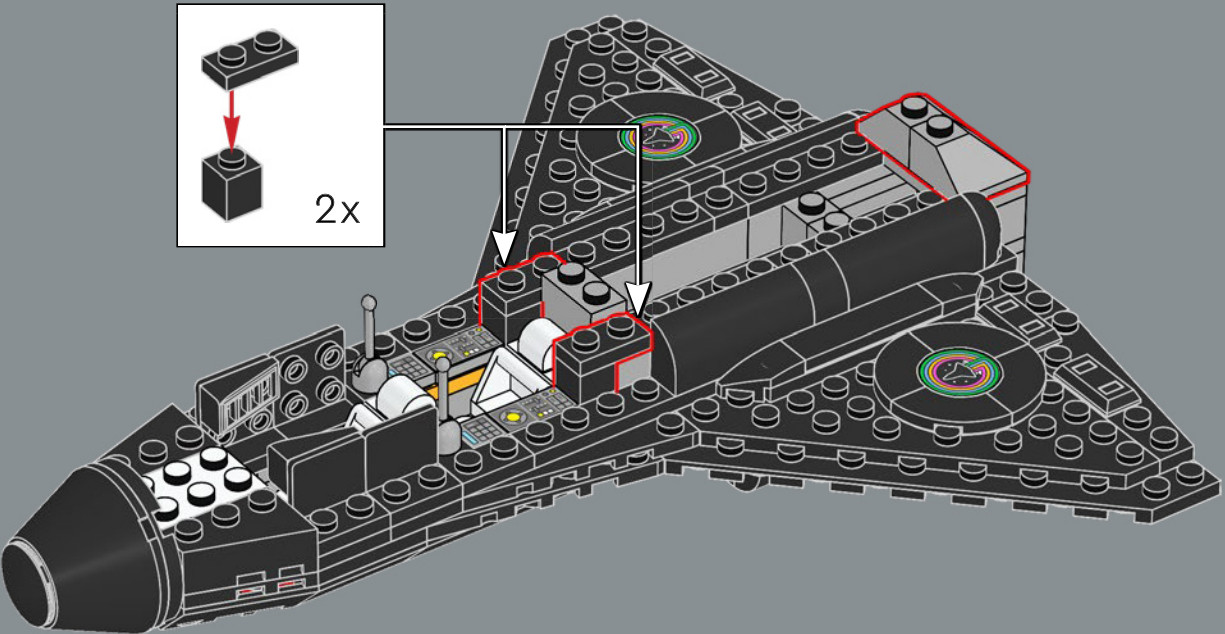

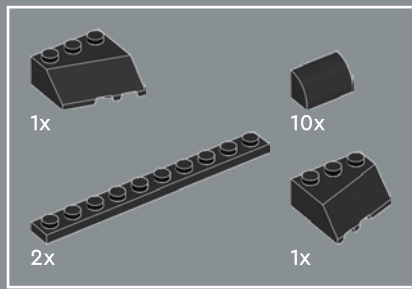

31

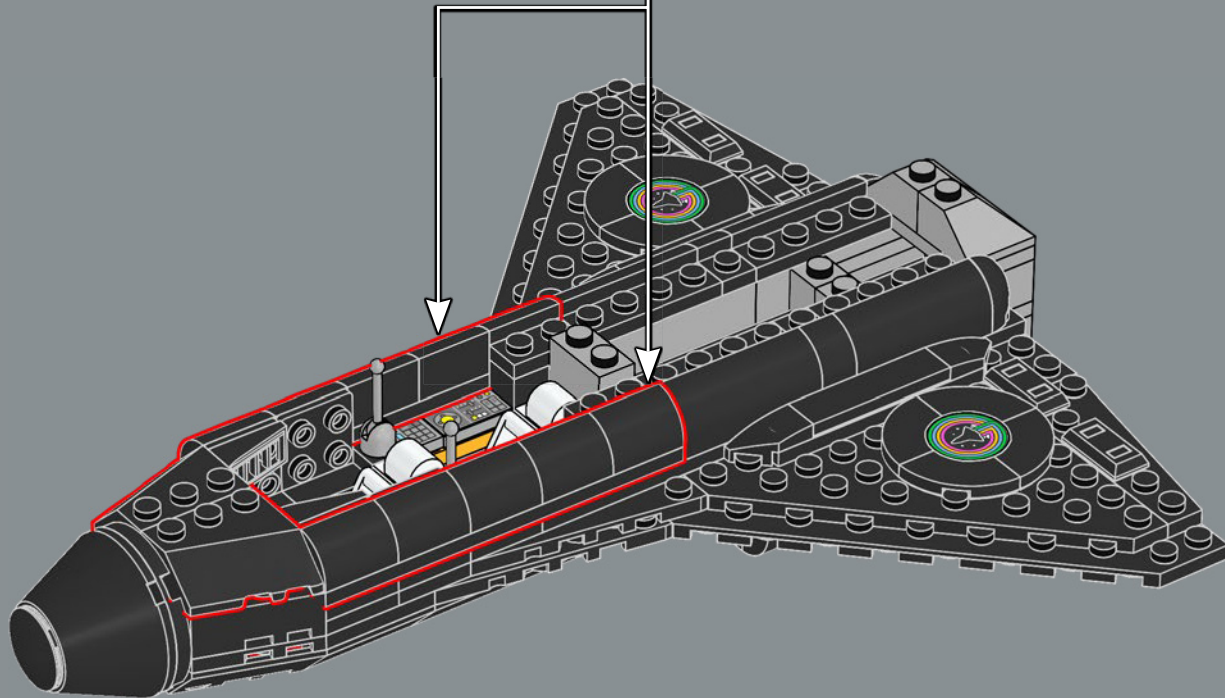
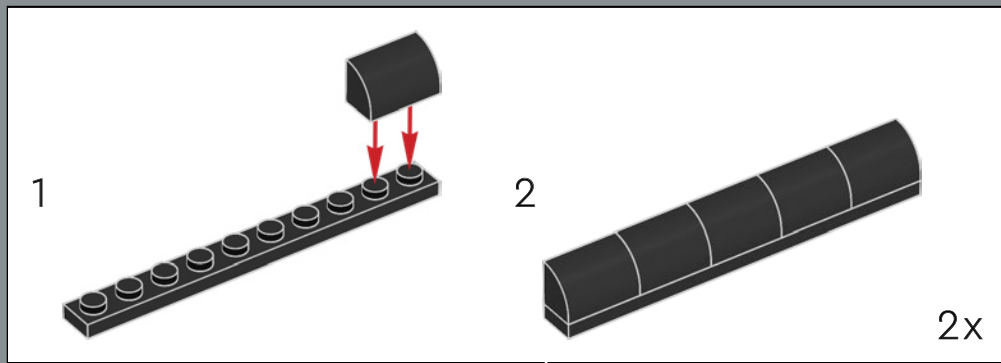

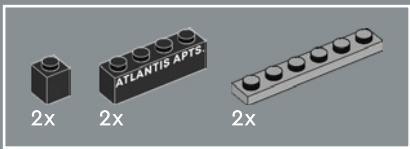

32

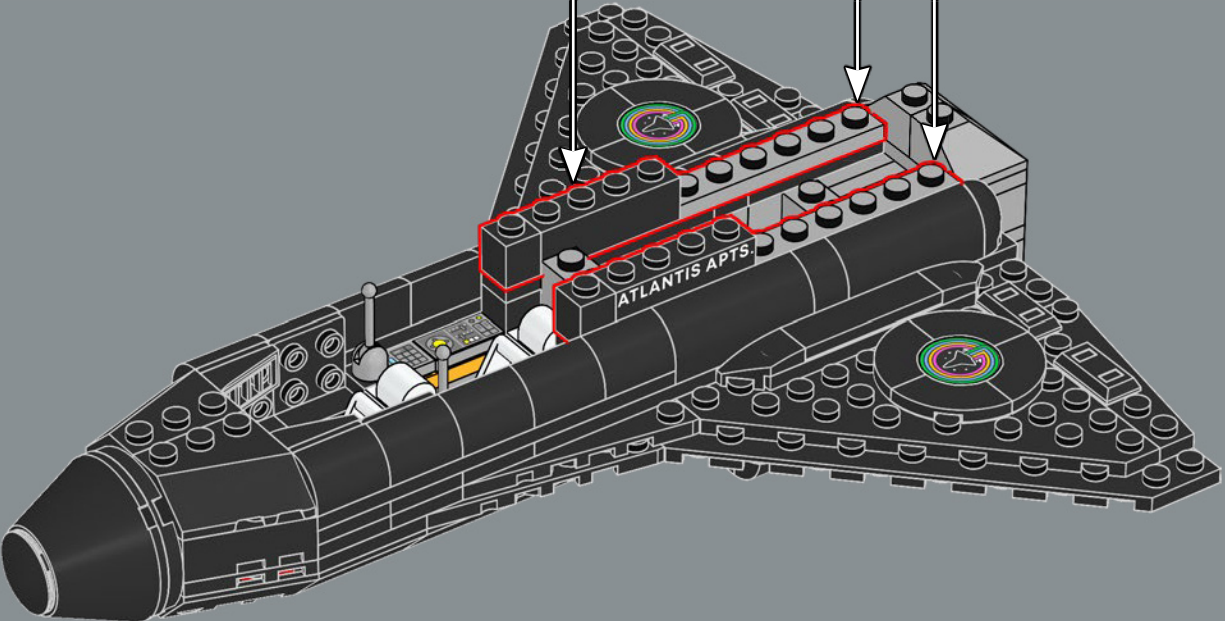
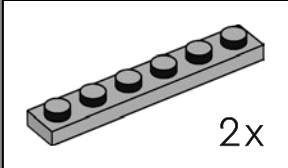

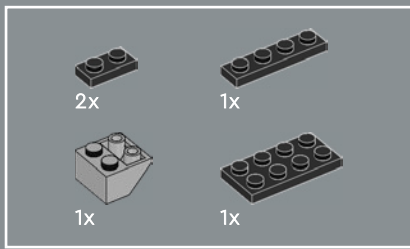

33

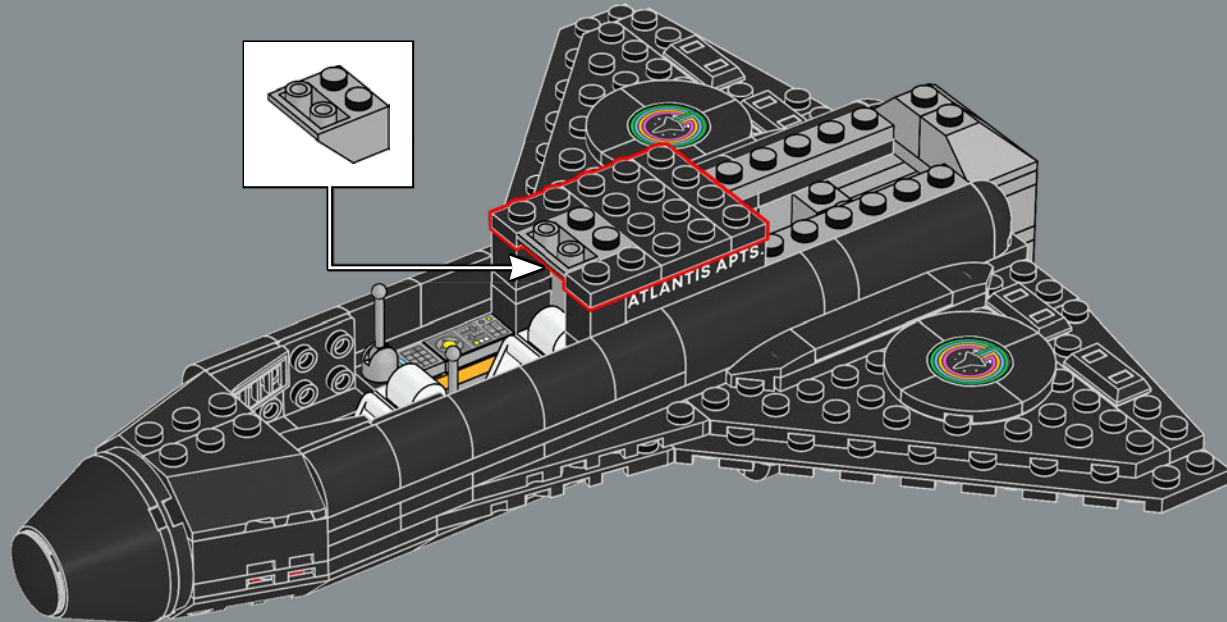

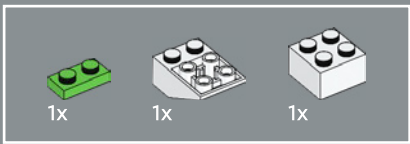

34

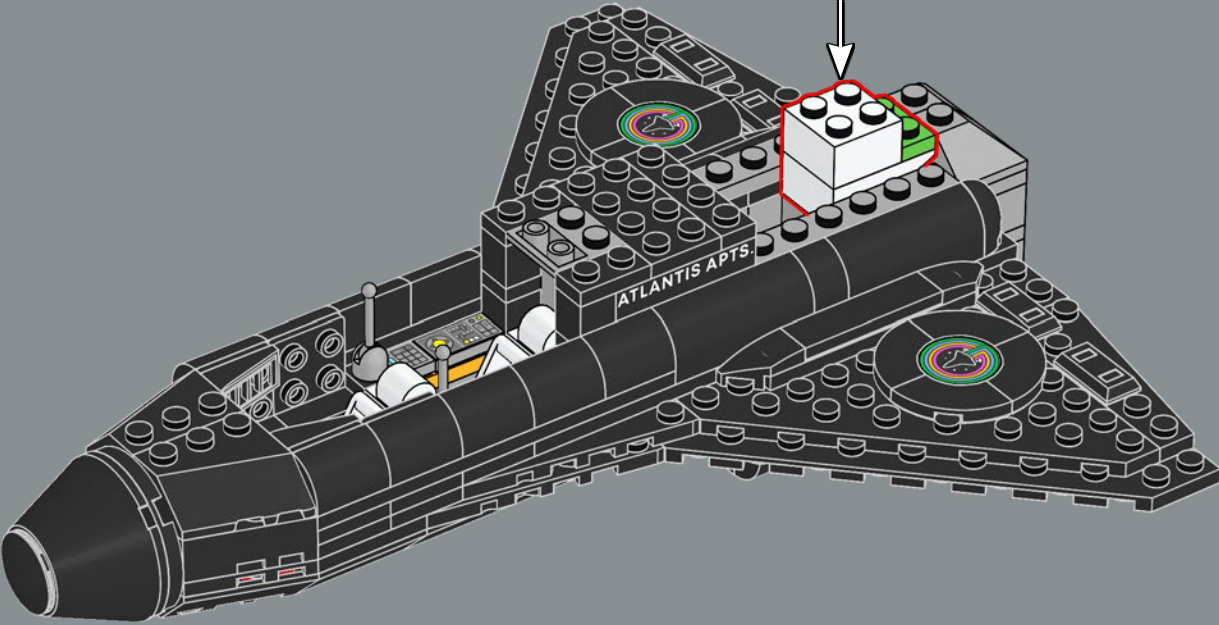
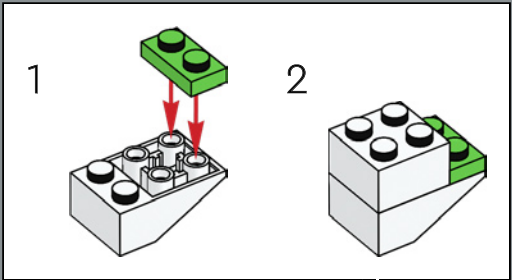



10x

35

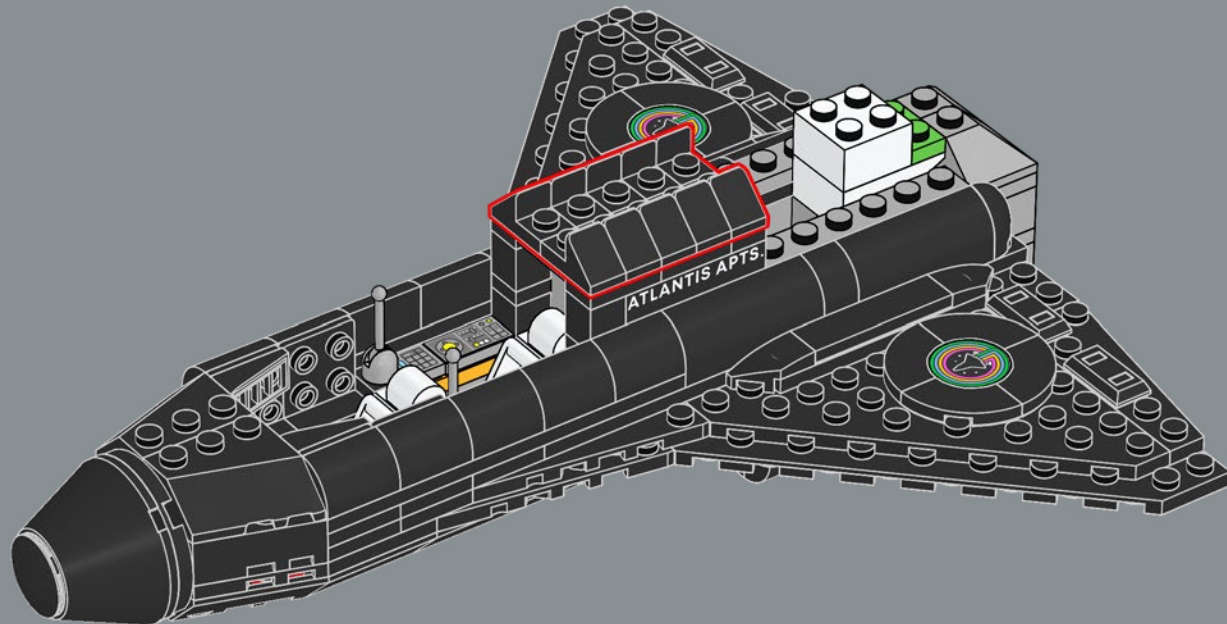

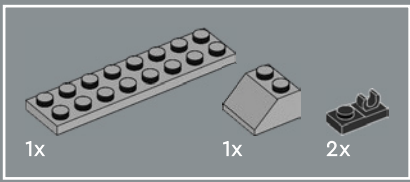

36

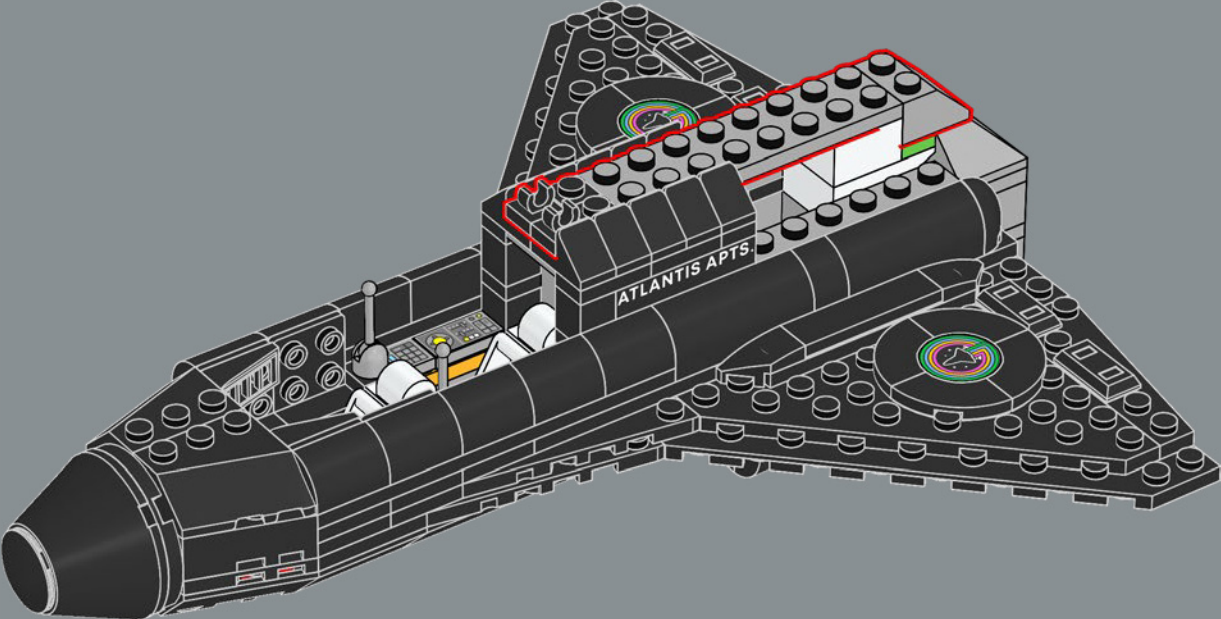

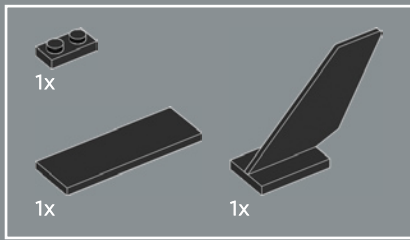

37

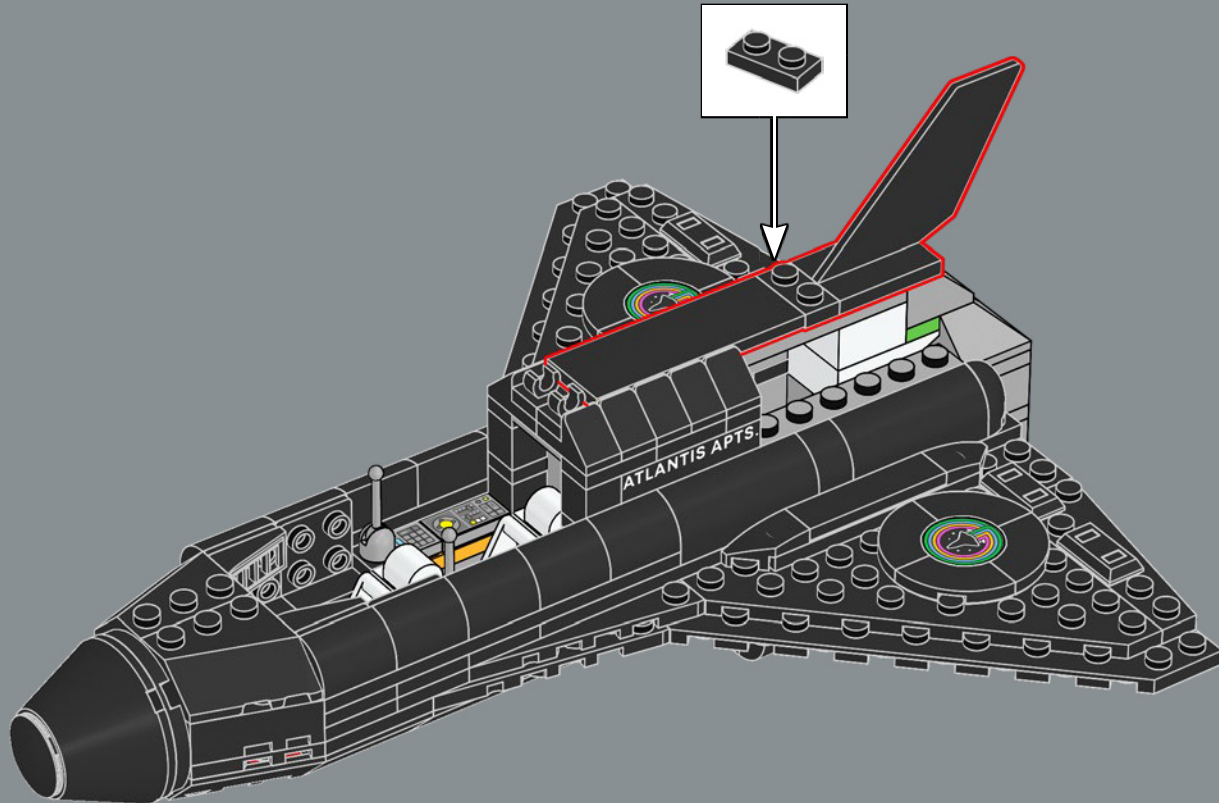

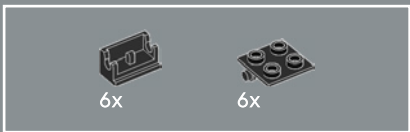

38

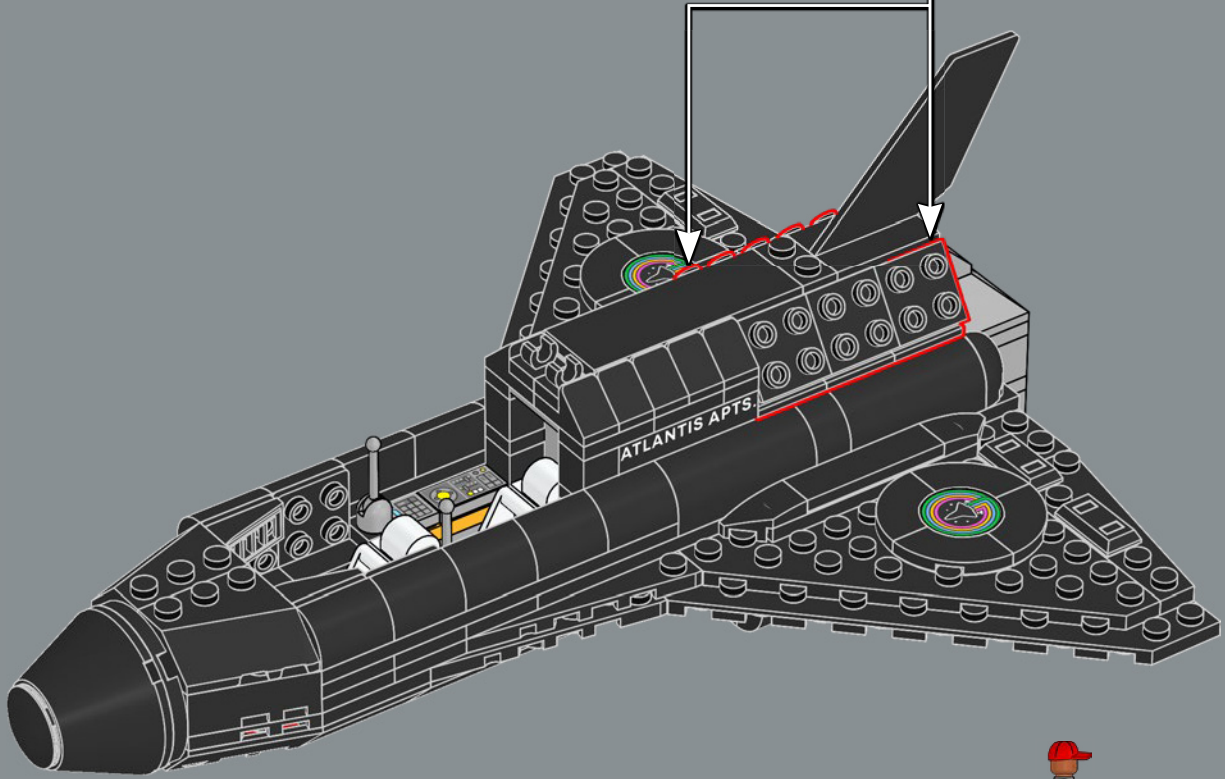
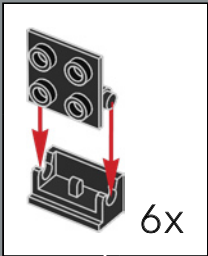

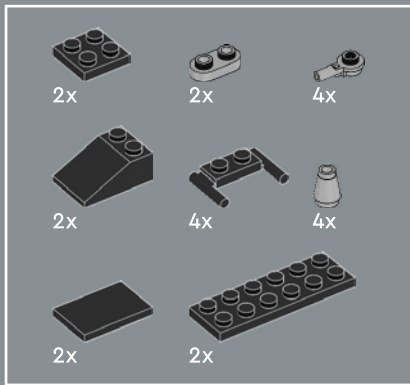

39

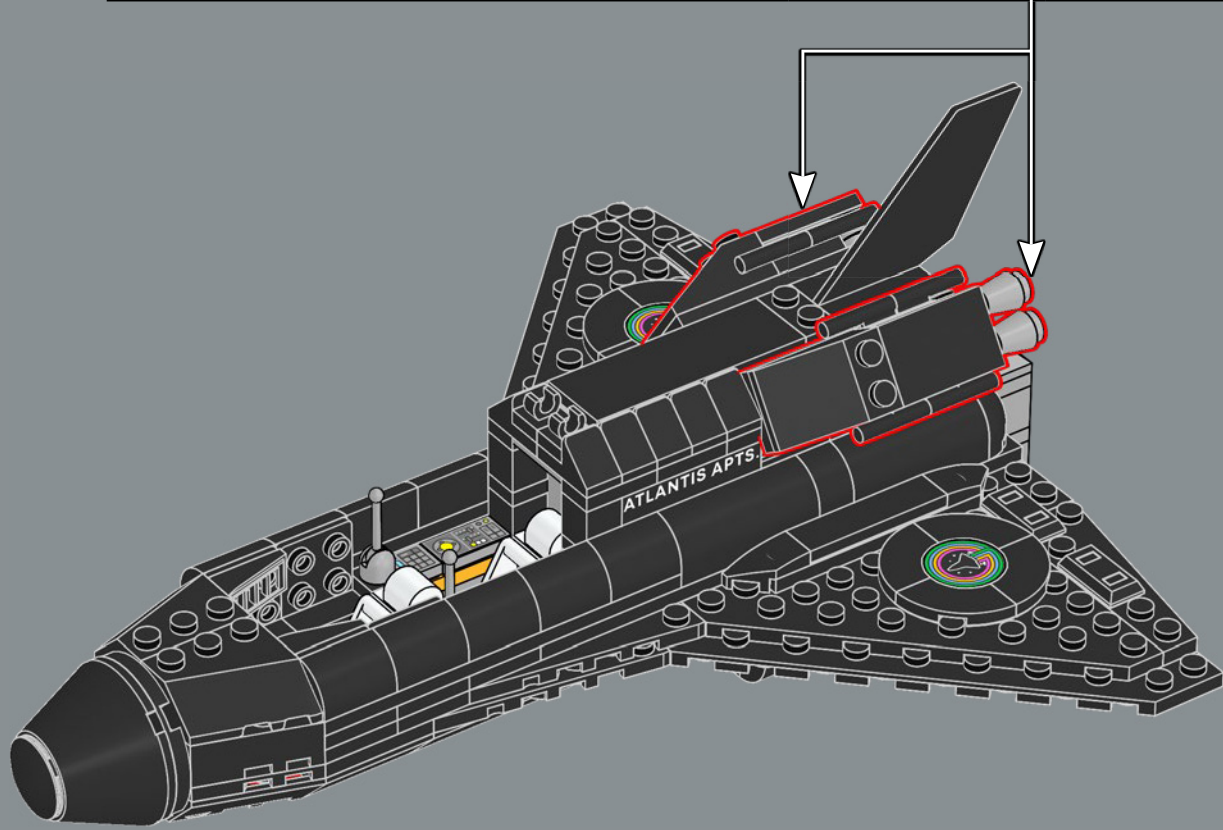
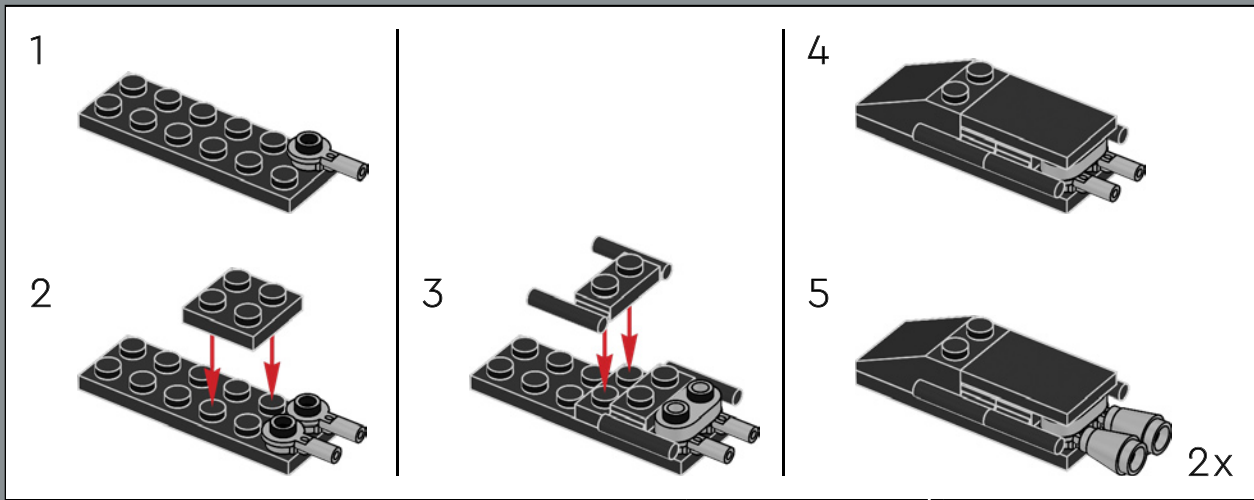



3x

6x

6x

3x

40

1

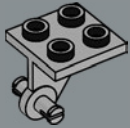

2

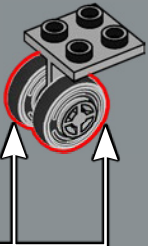

3x



2x

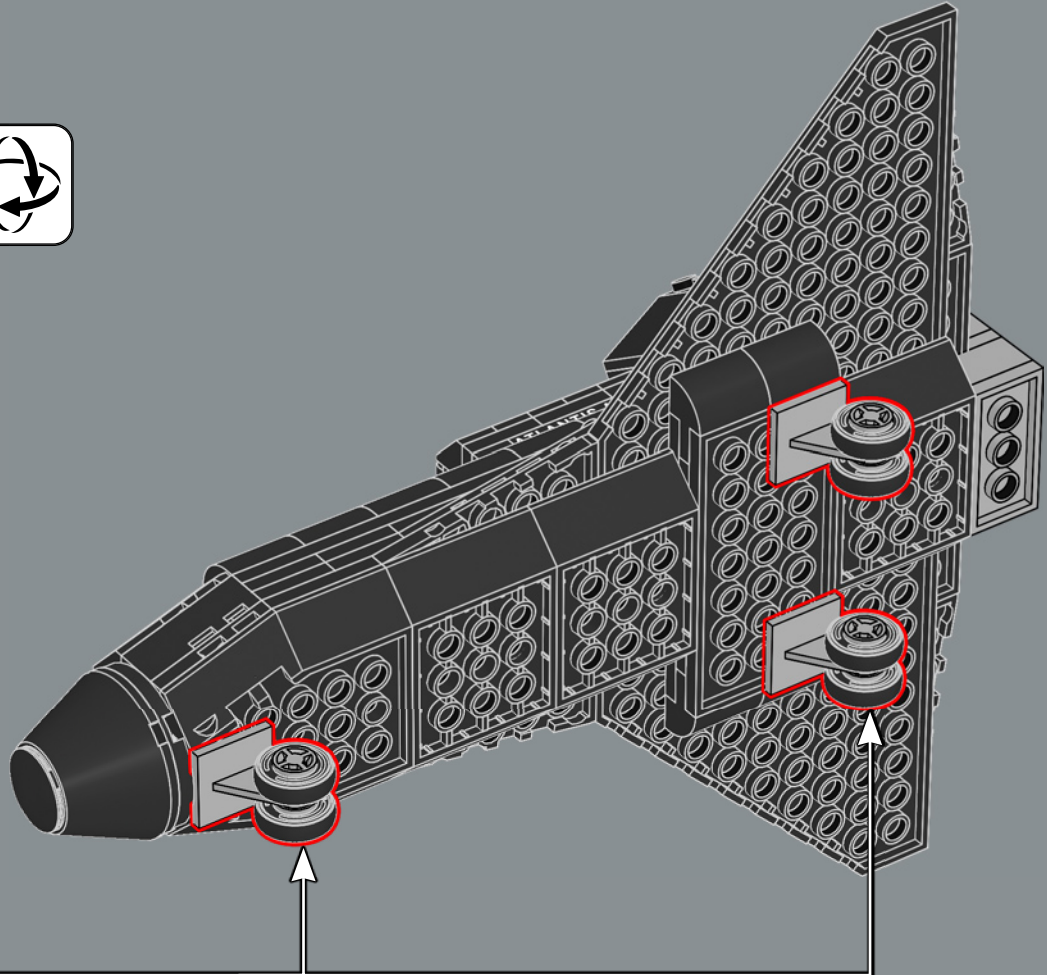

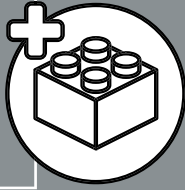
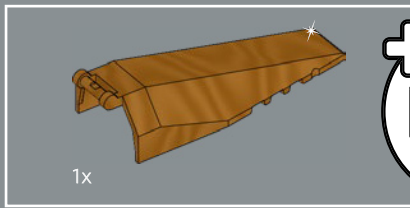

41

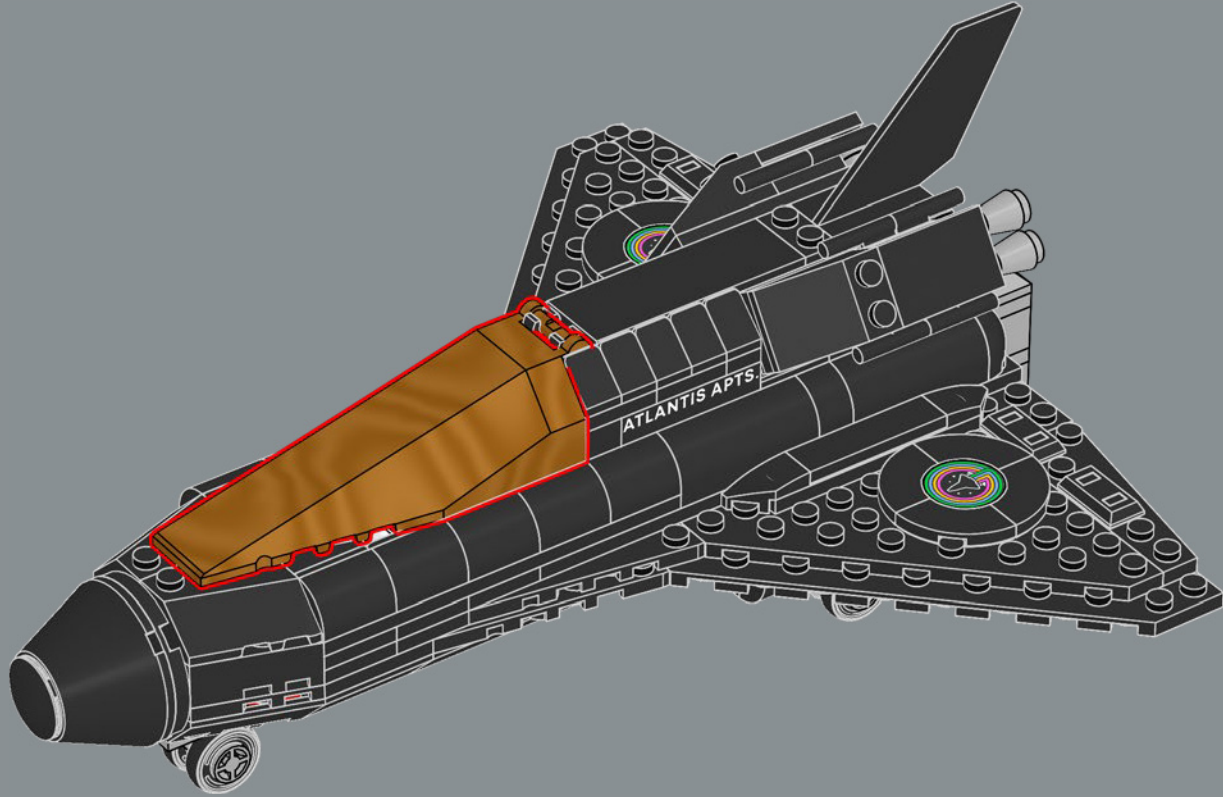

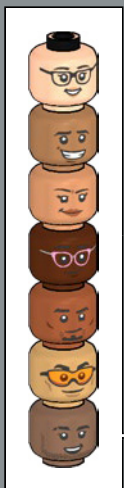
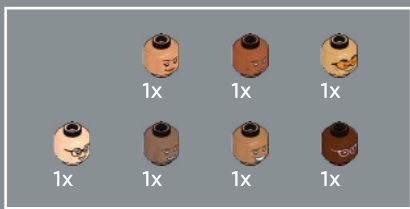

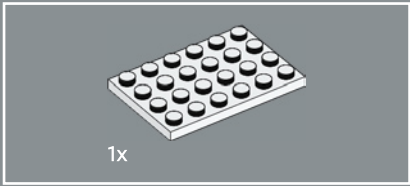
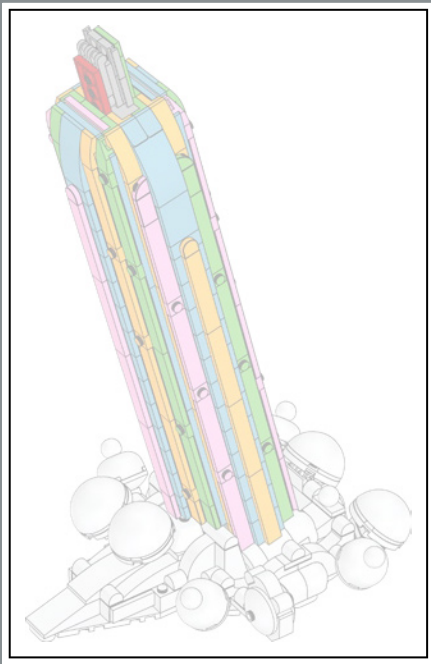

1x

42

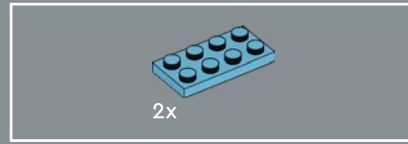
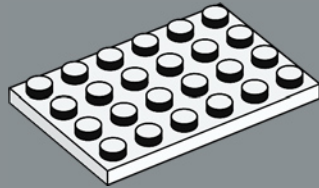

2x

43

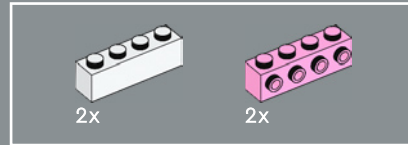
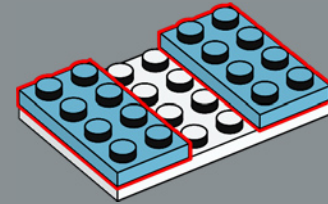

2x

2x

44

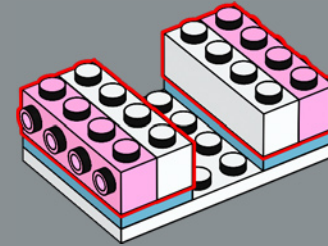

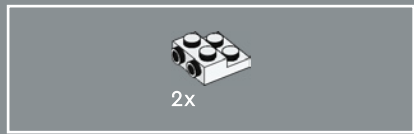

45

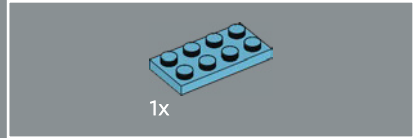
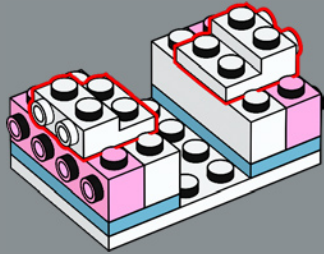

46

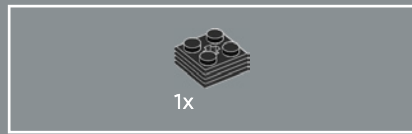
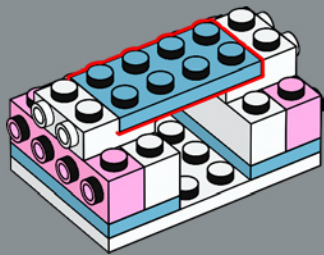

47

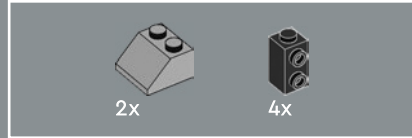
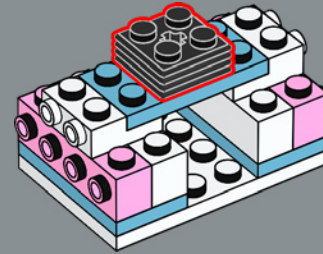

48

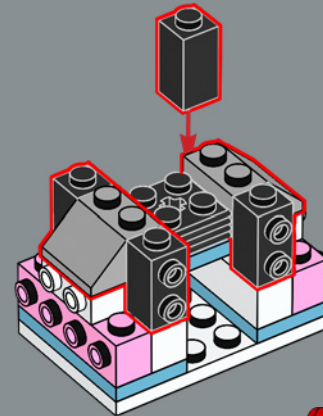



49

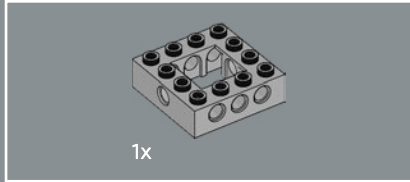
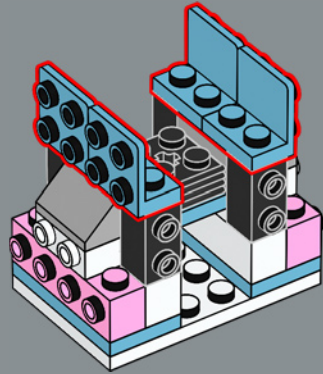

50

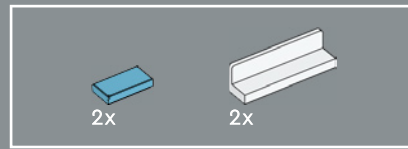
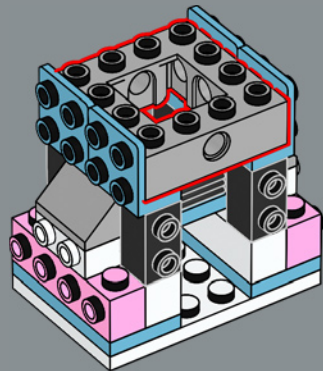

51

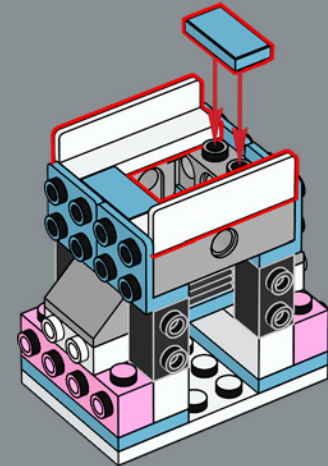

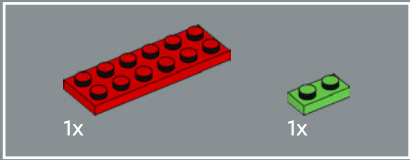
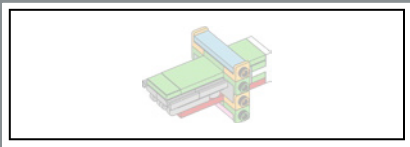

52

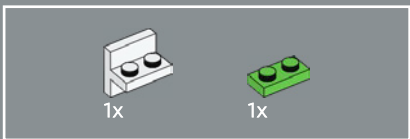
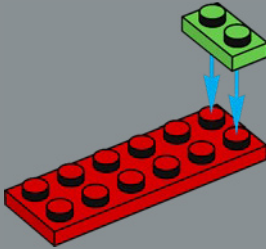

53

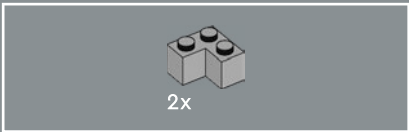
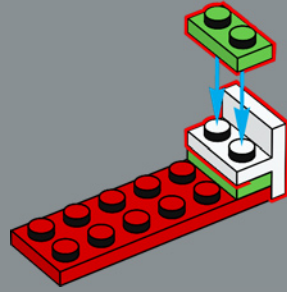

54

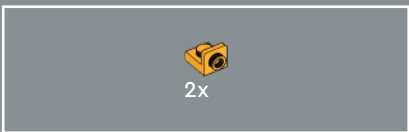
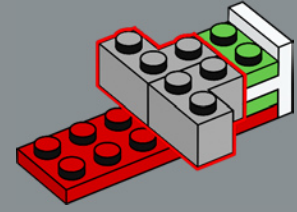

55

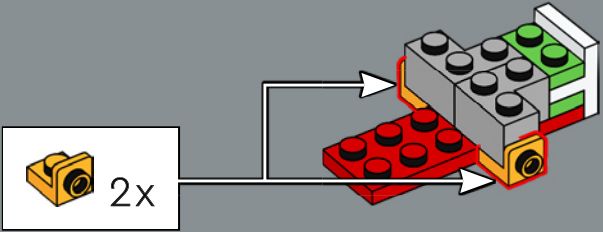

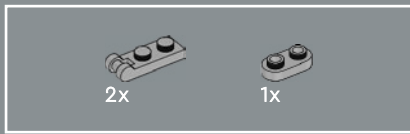

56

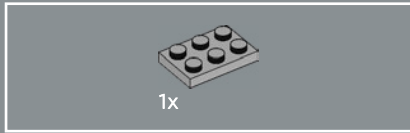
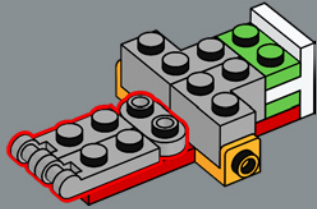

57

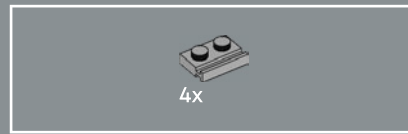
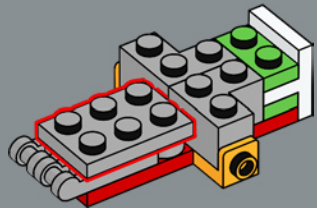

58

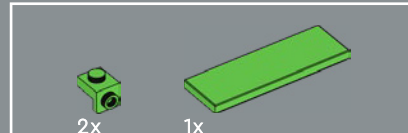
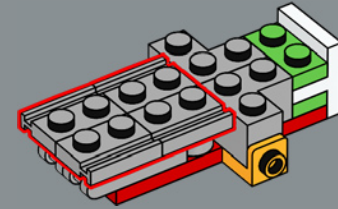

59

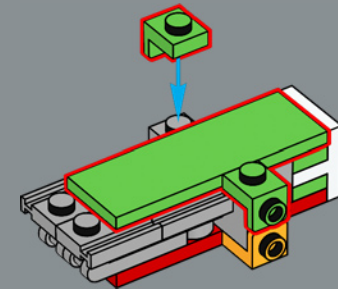

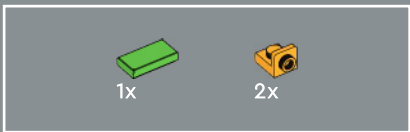

60

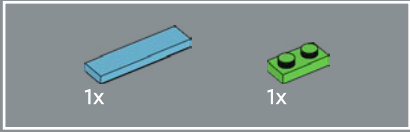
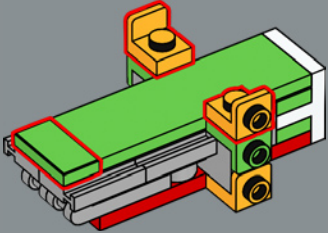

61

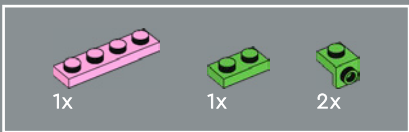
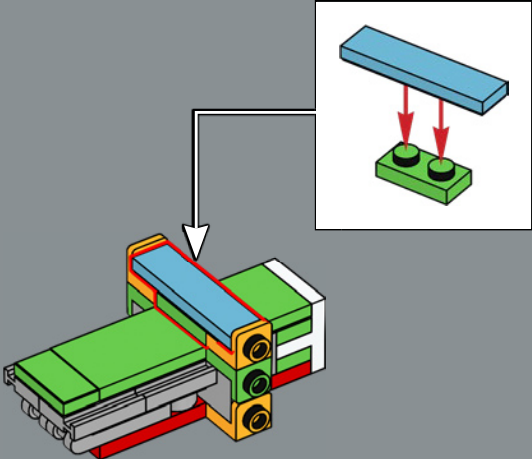

62

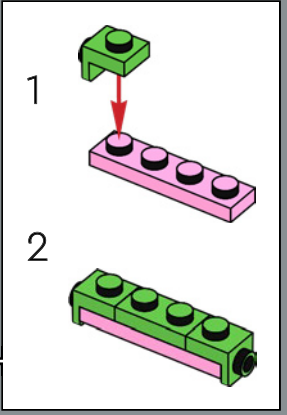
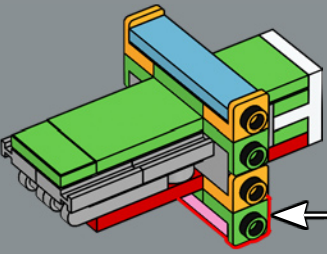

63

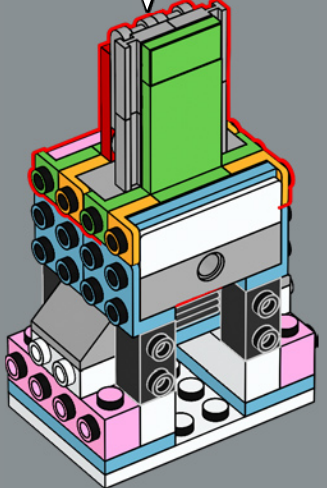

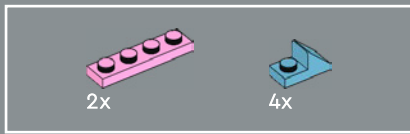

64

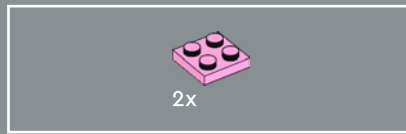
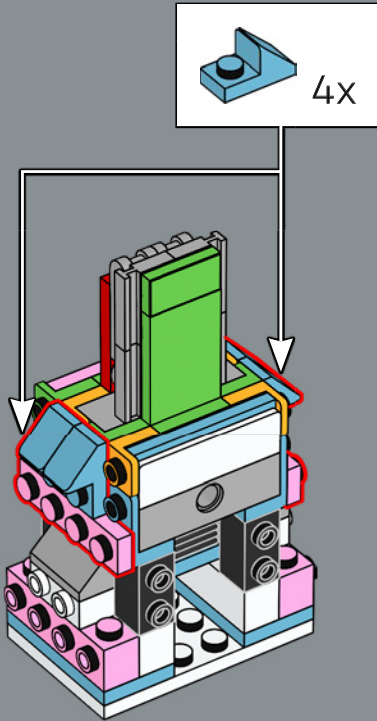

65

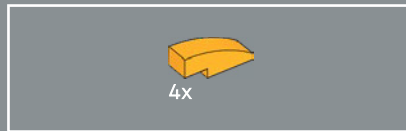
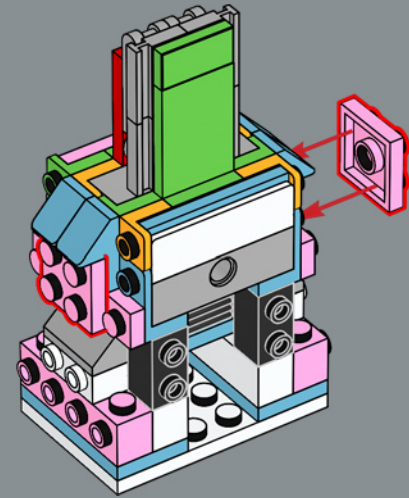

66

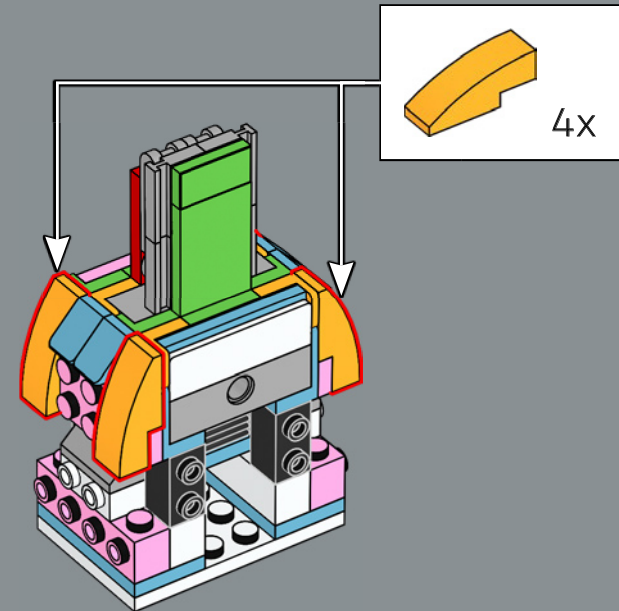

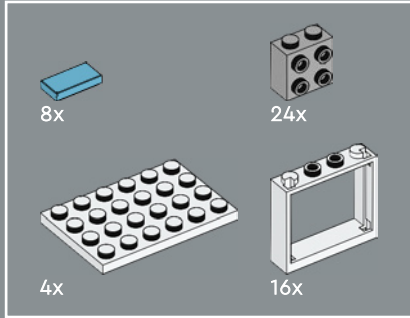
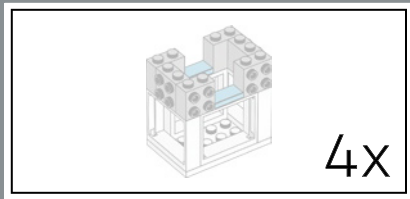

67

1

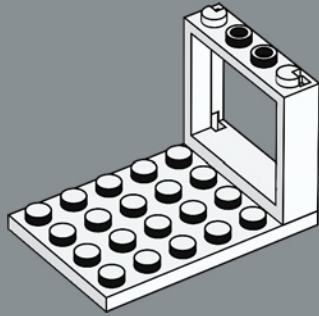

2

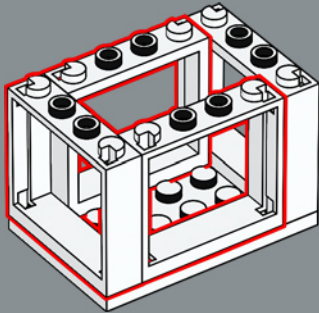

3

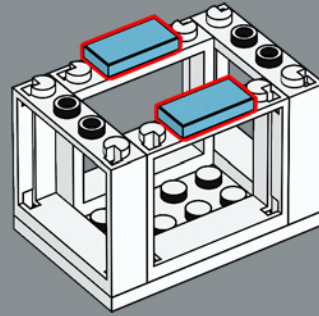

4

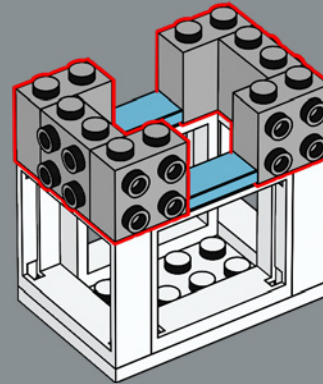

4x



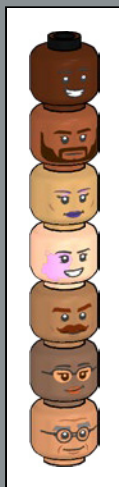
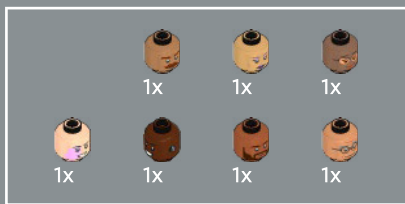

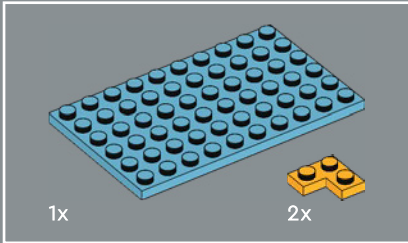
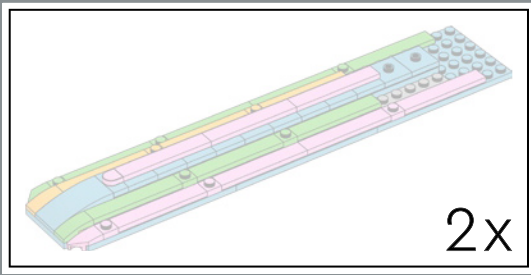

68

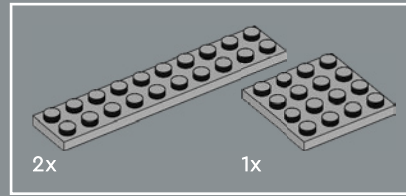
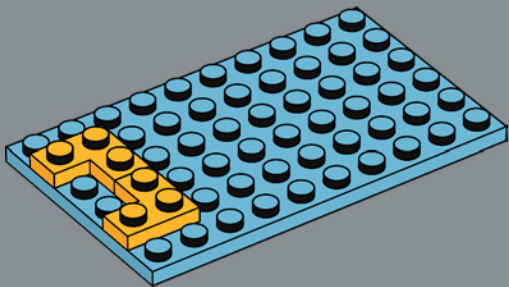

69

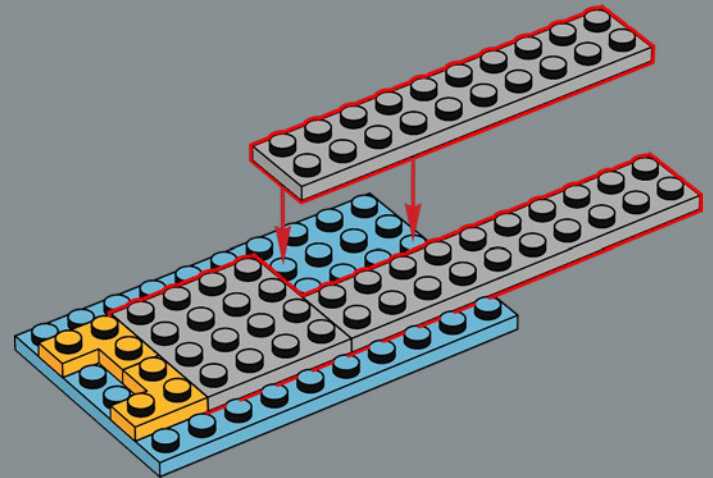

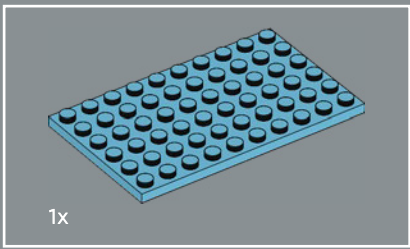

70

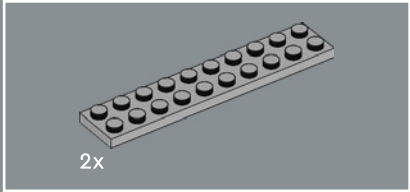
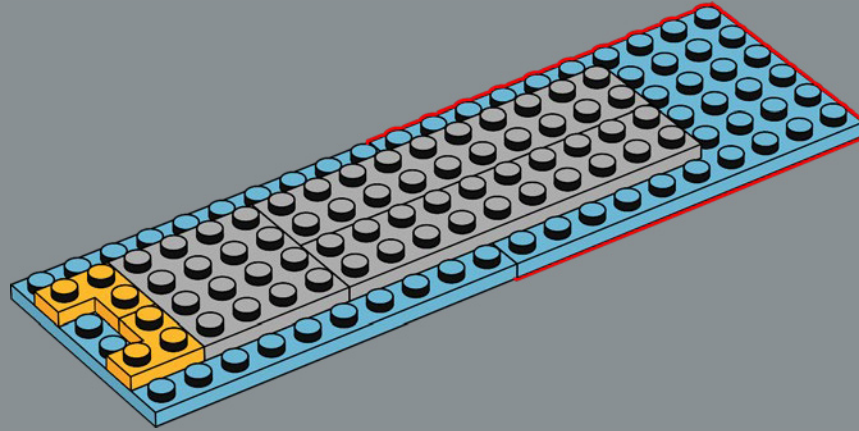

71

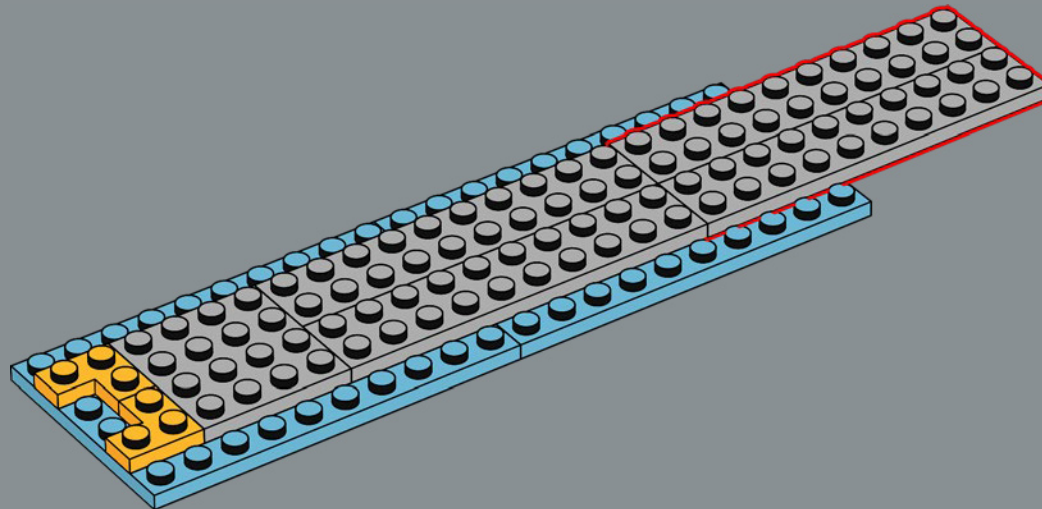

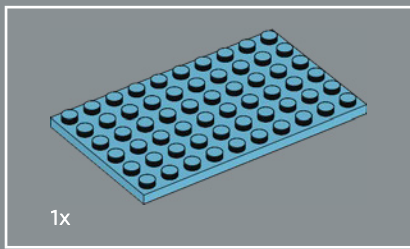

72

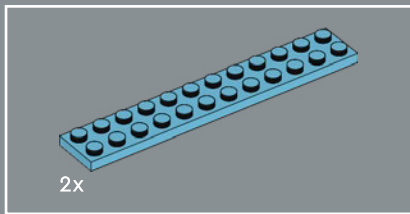
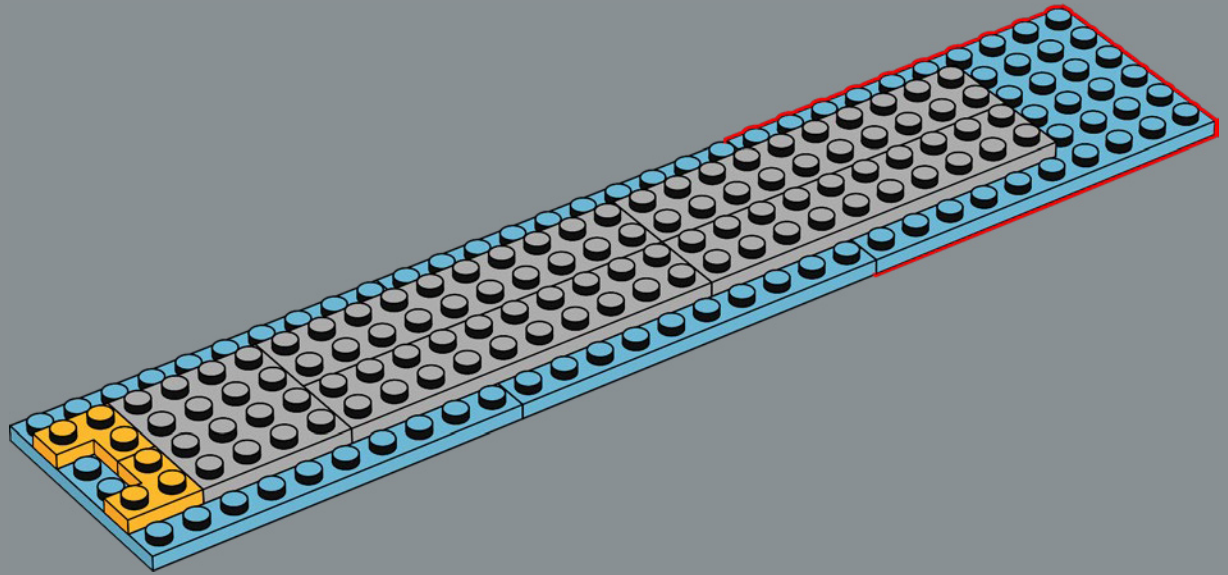

73

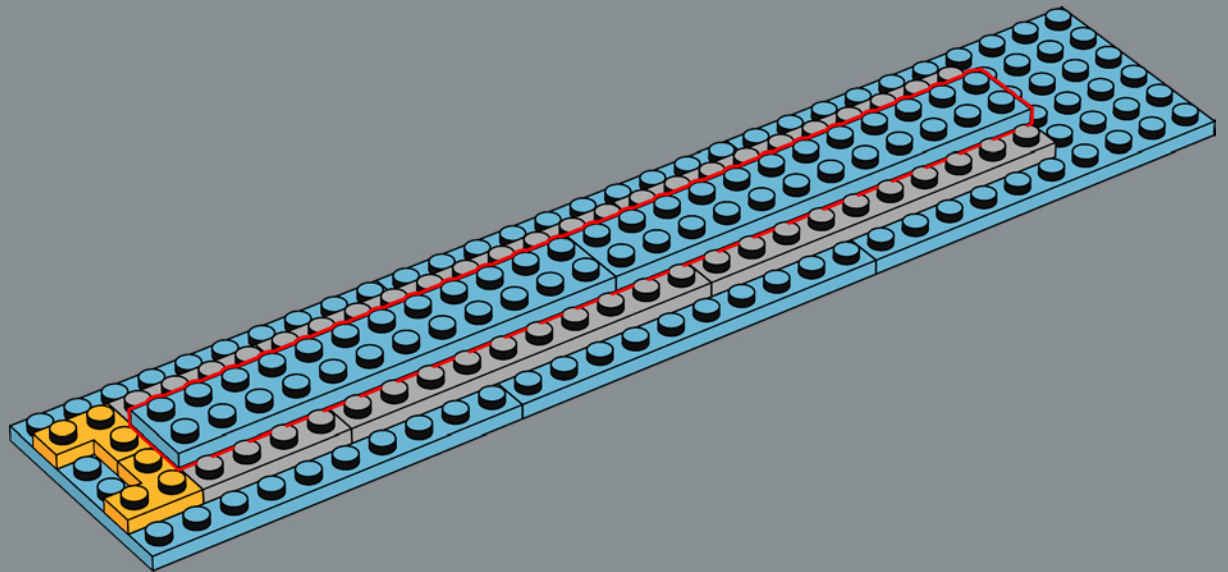

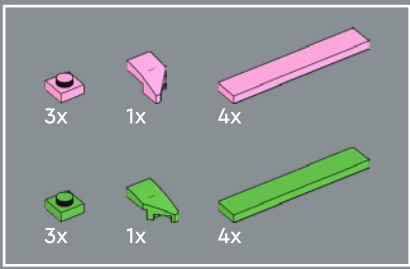

74

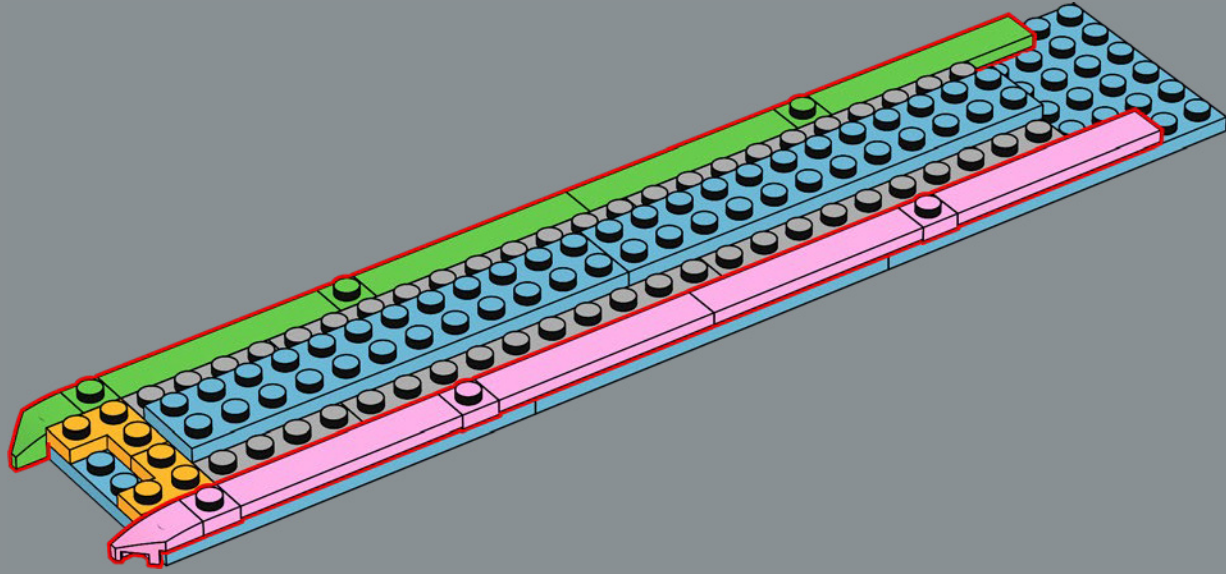

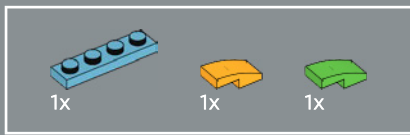

75

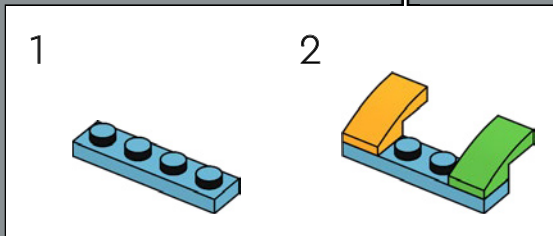
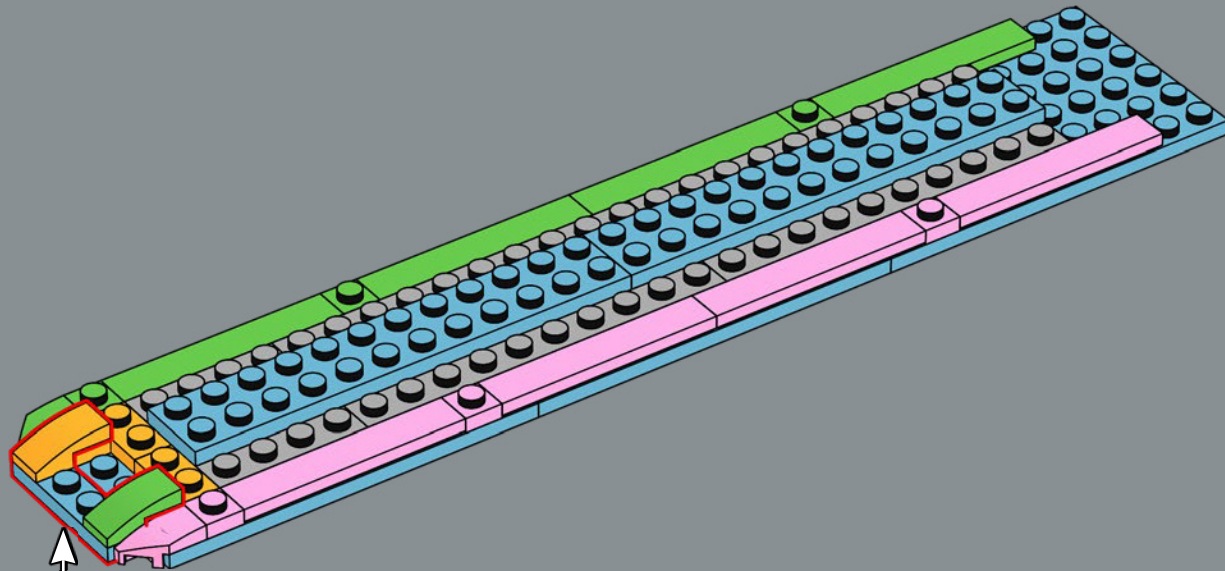

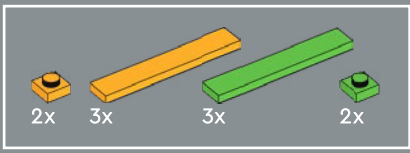

76

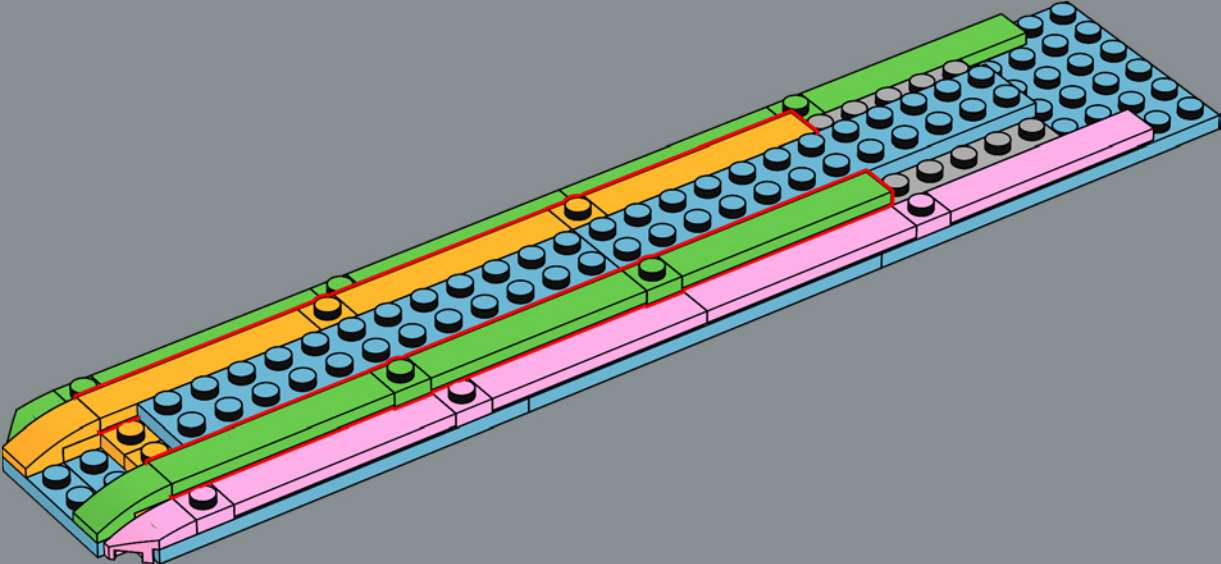

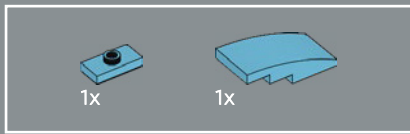

77

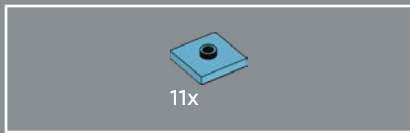
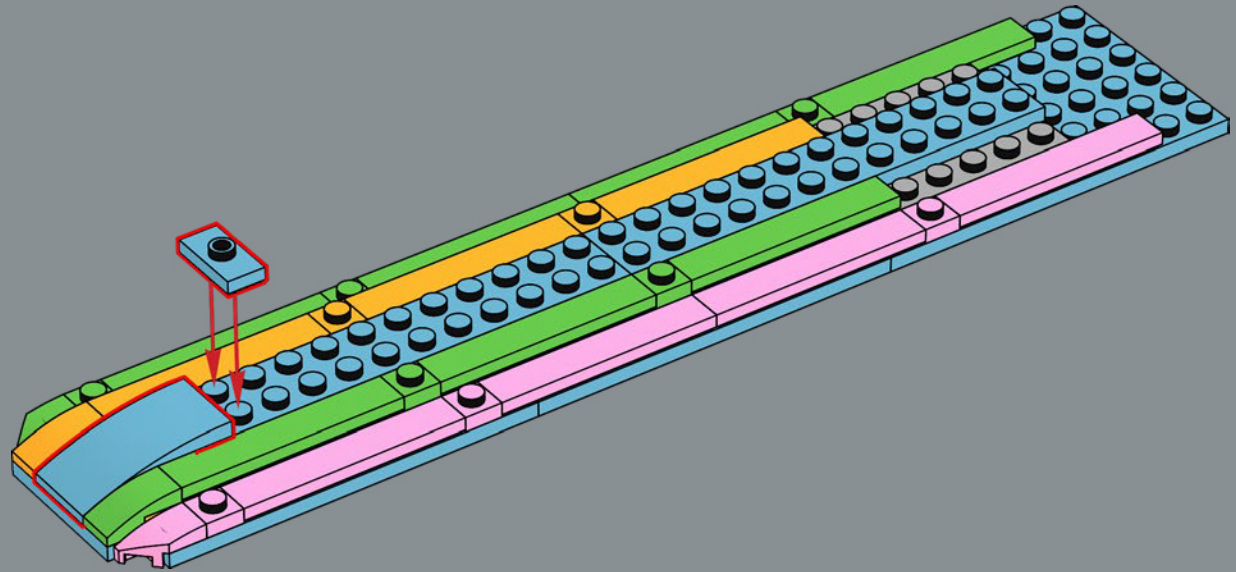

78

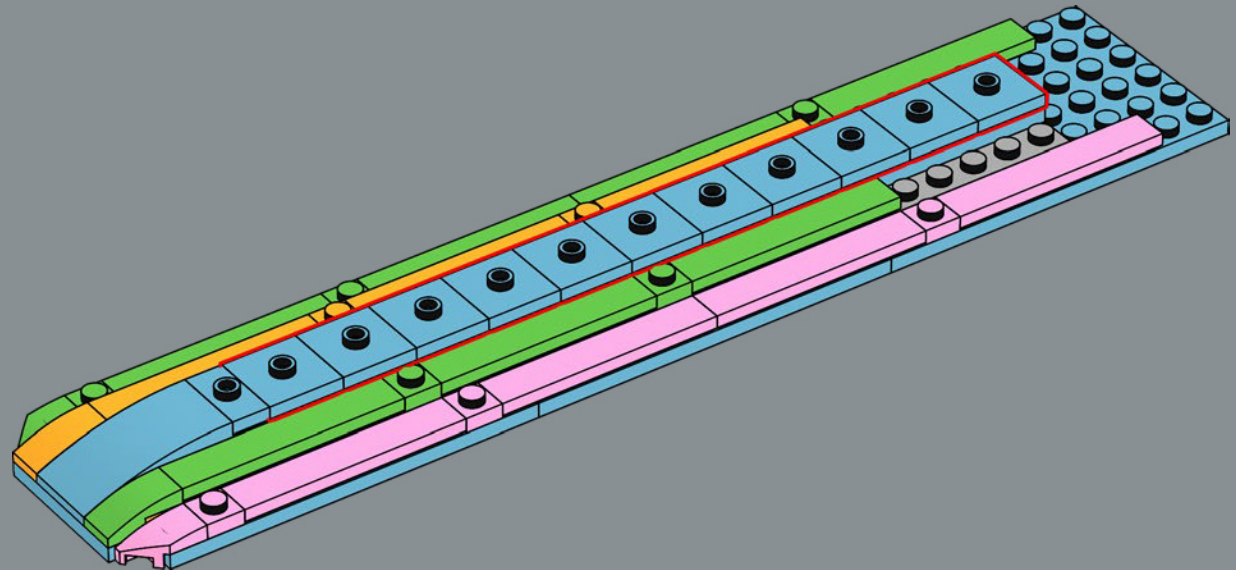

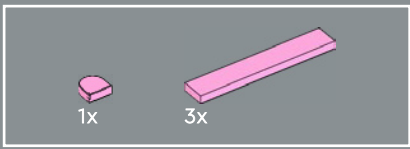

79

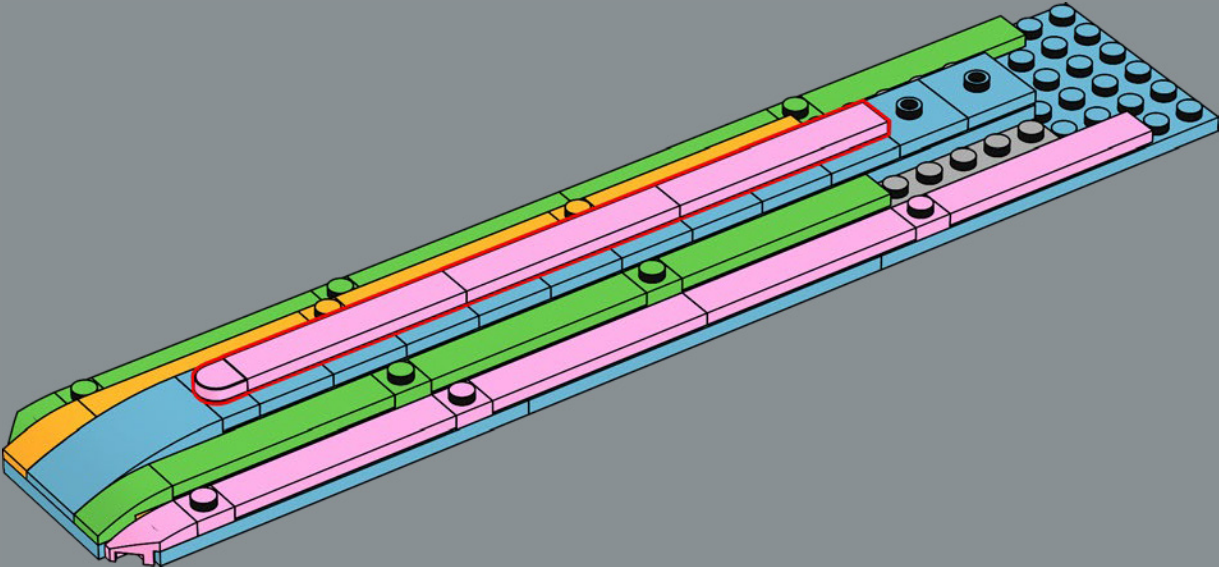

2x

80

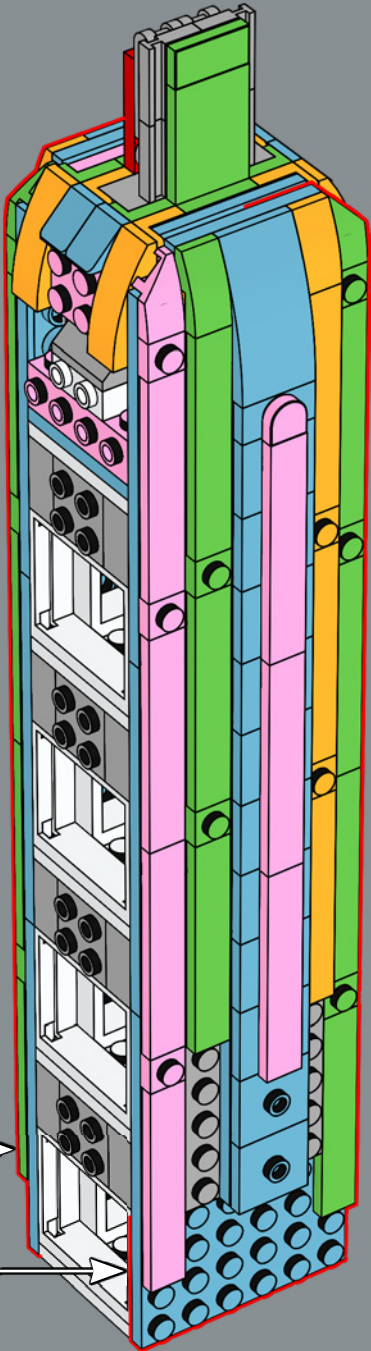

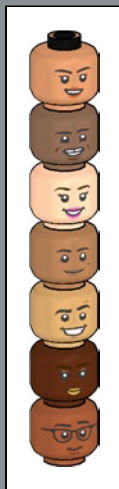
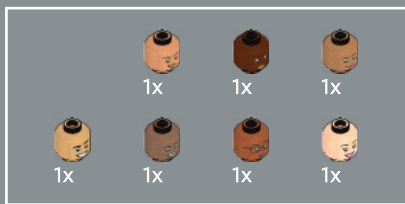

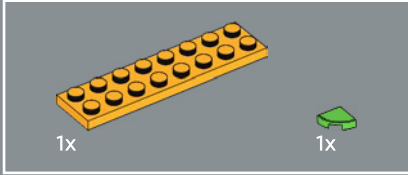
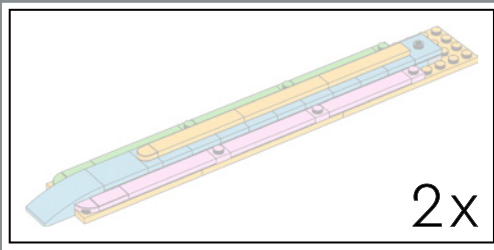

81

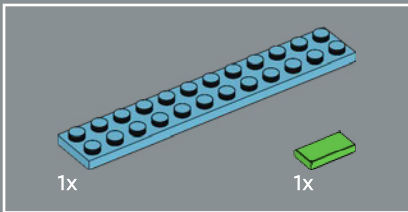
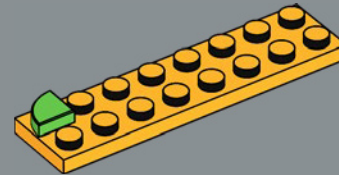

82

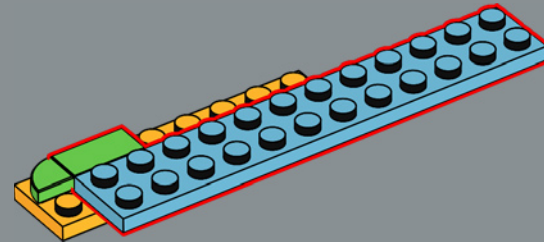

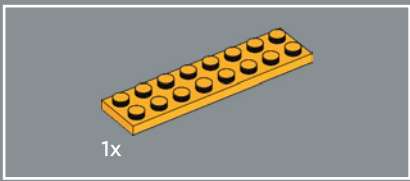

83

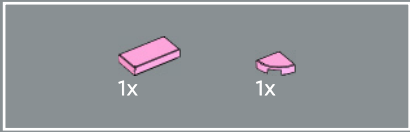
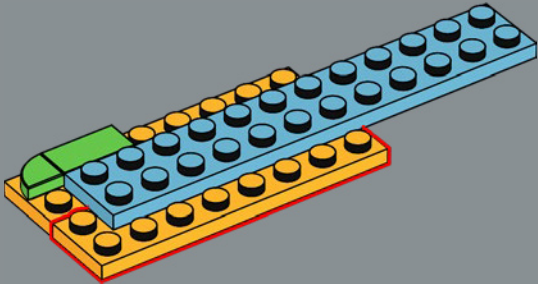

84

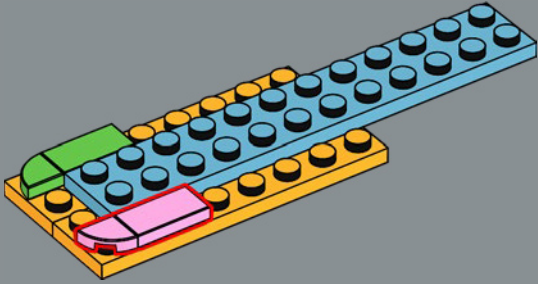

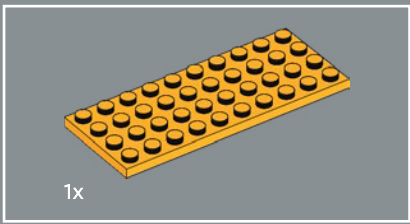

85

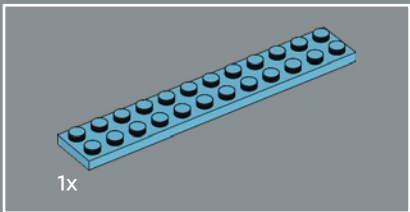
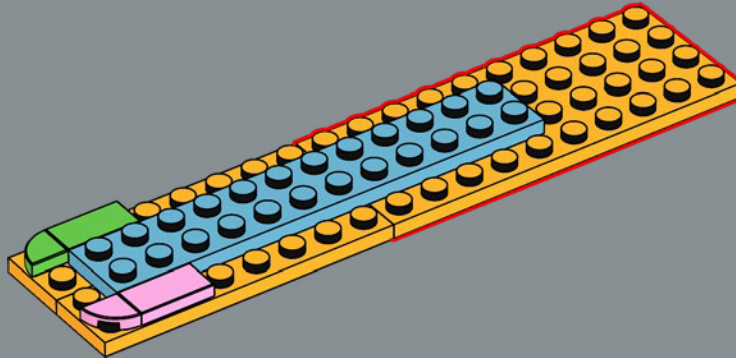

86

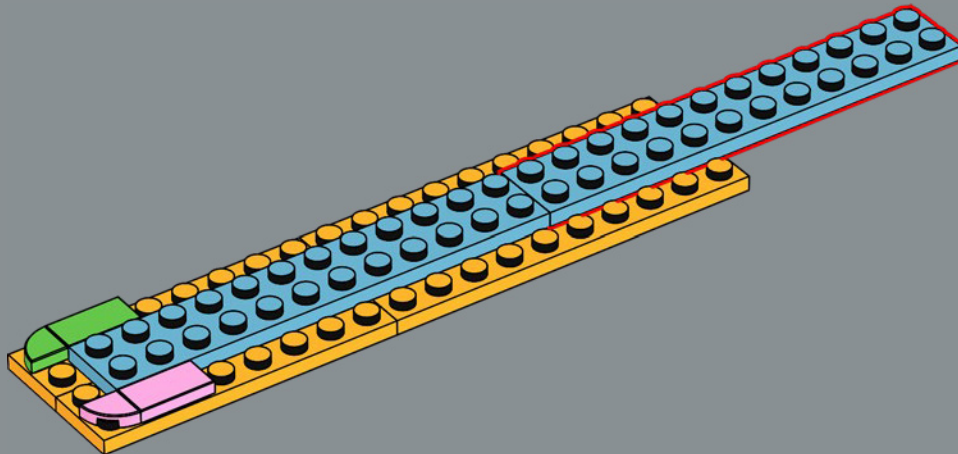

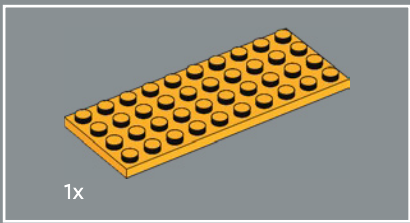

87

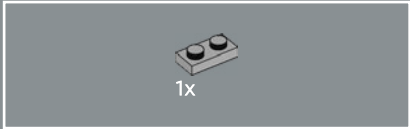
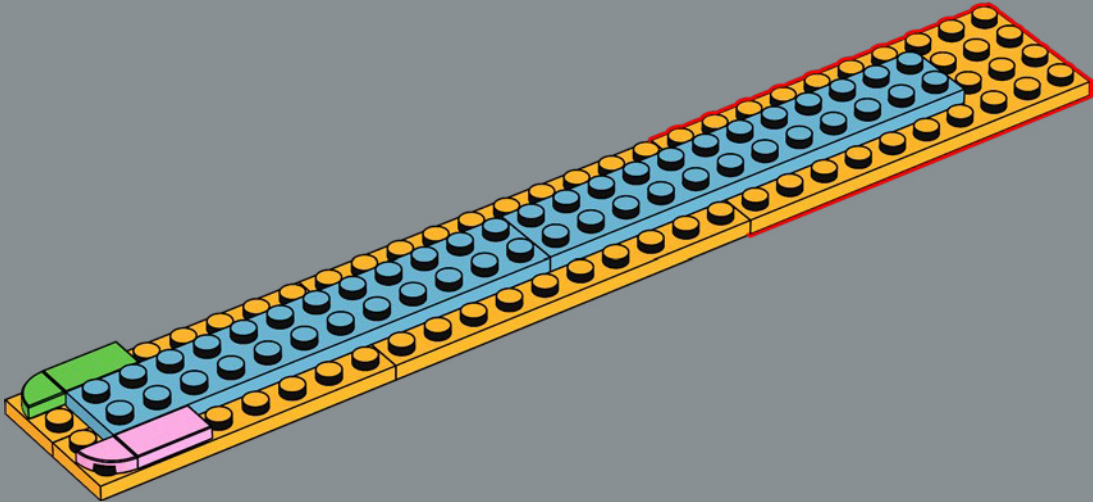

88

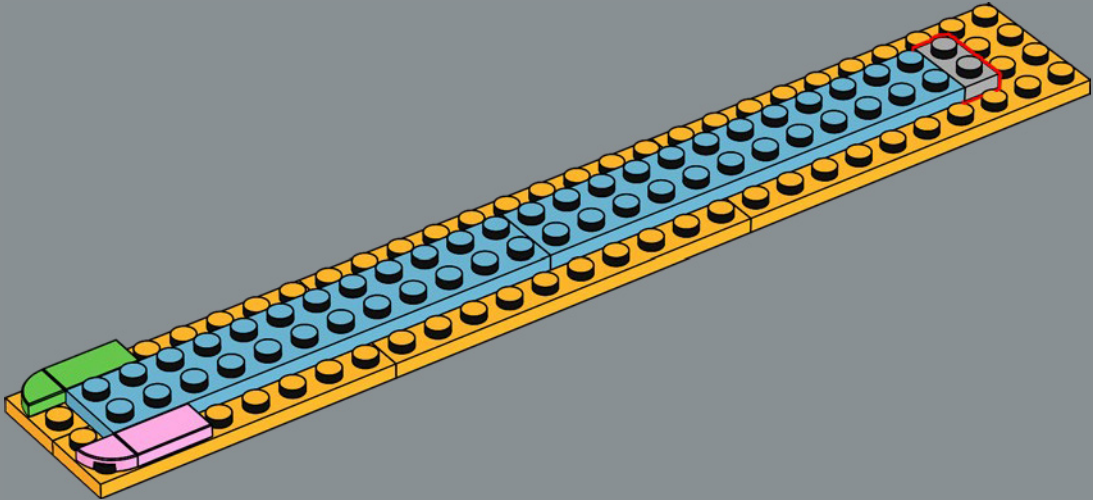

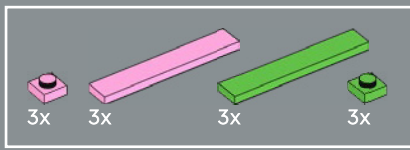

89

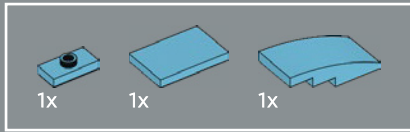
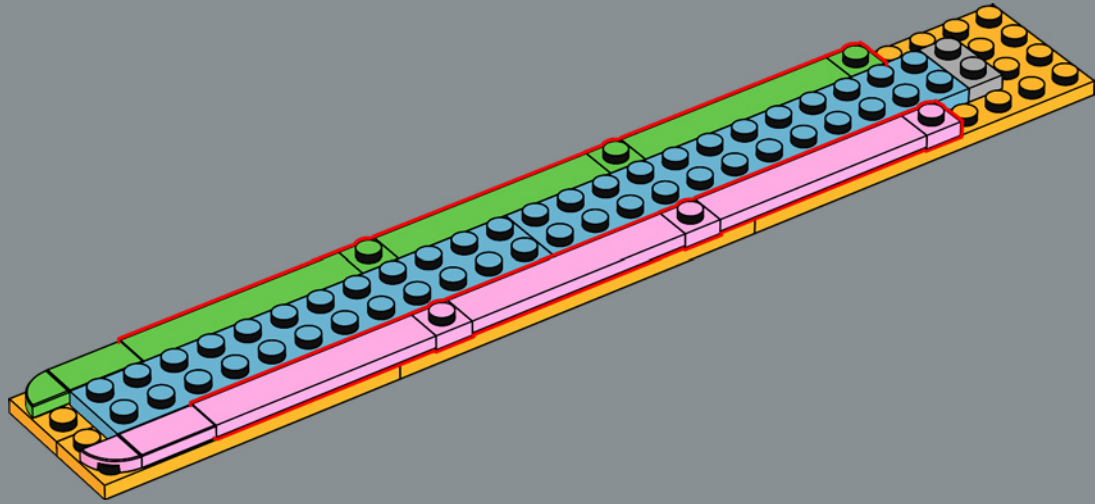

90

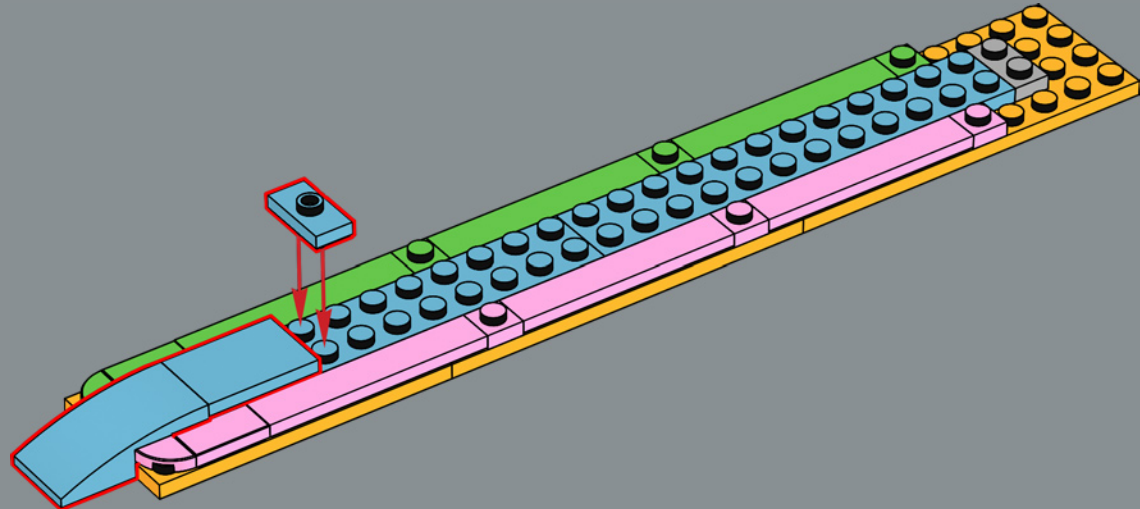

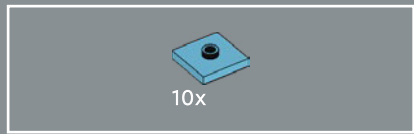

91

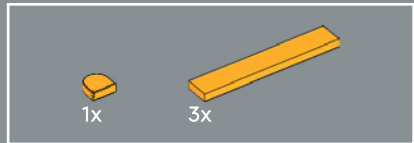
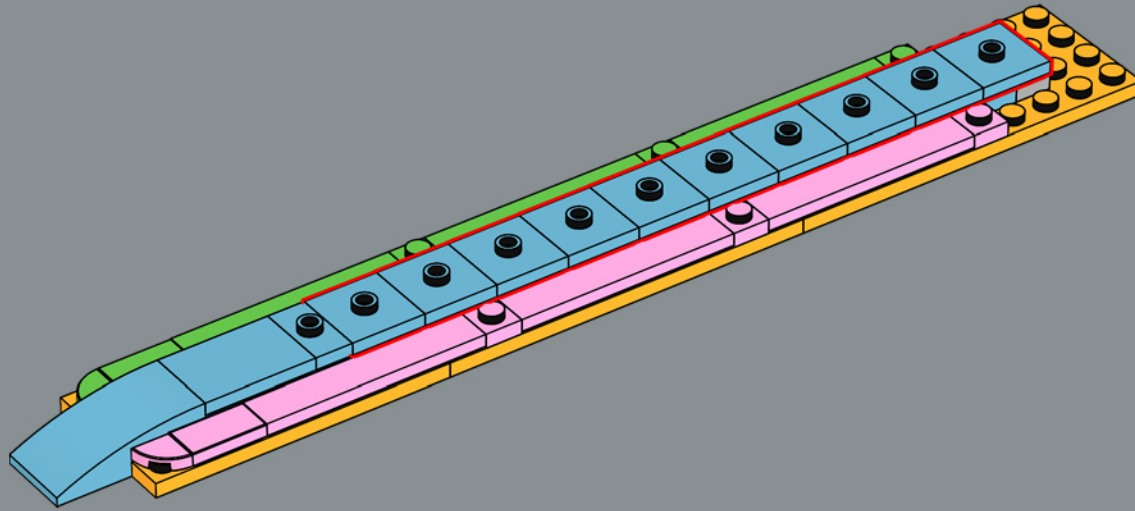

92

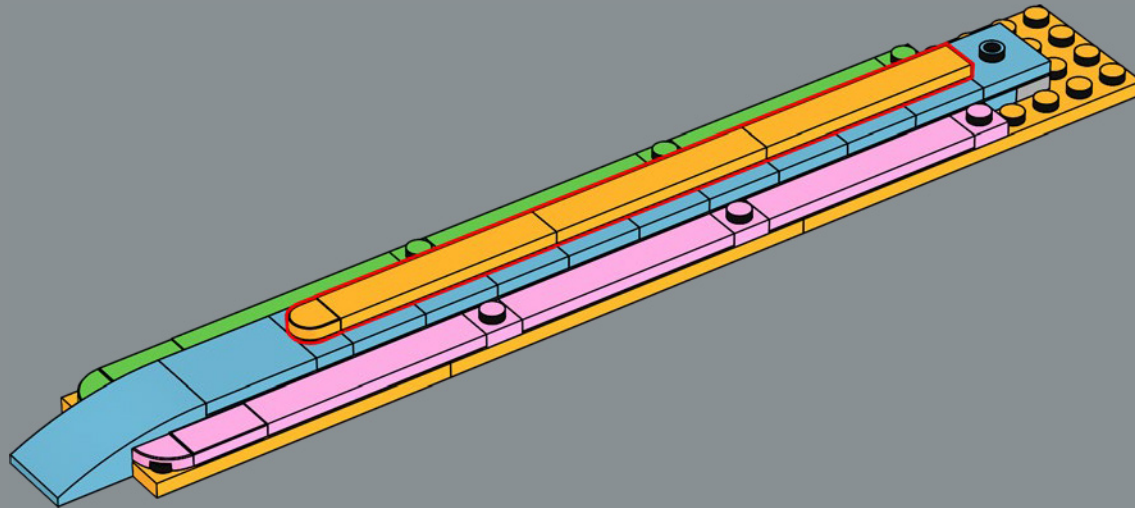

2x

93

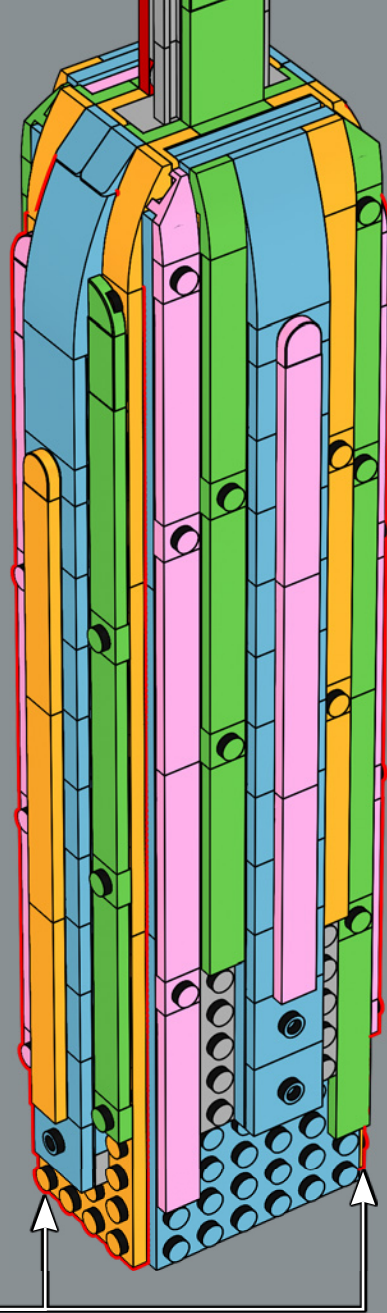

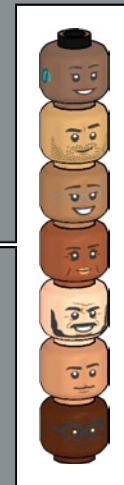
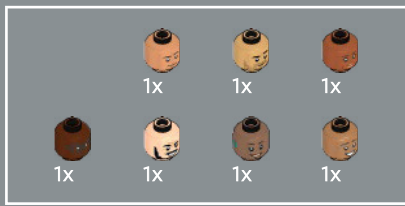

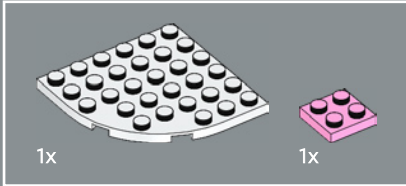
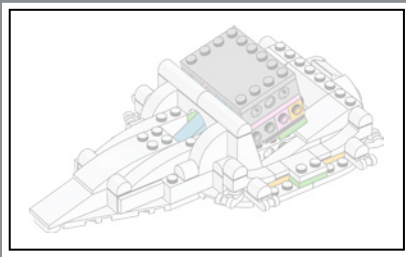

94

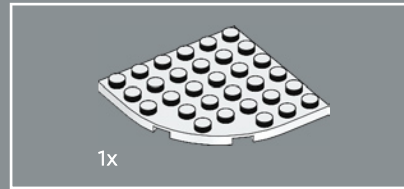
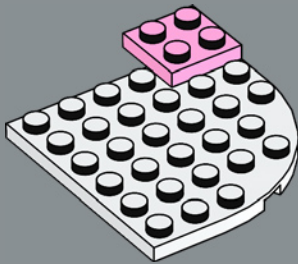

95

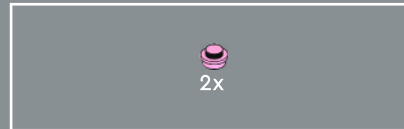
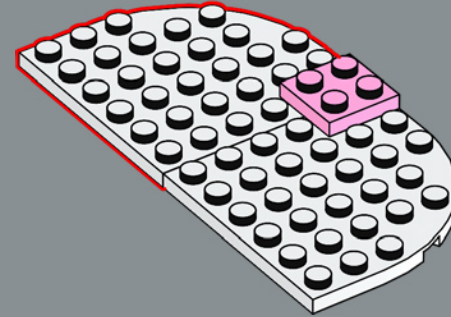

96

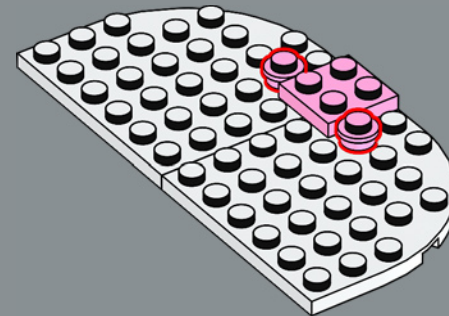



97

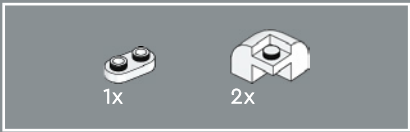
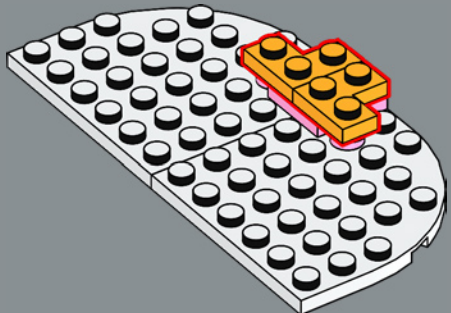

98

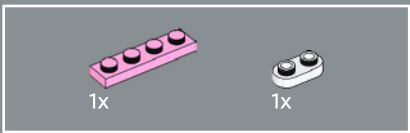
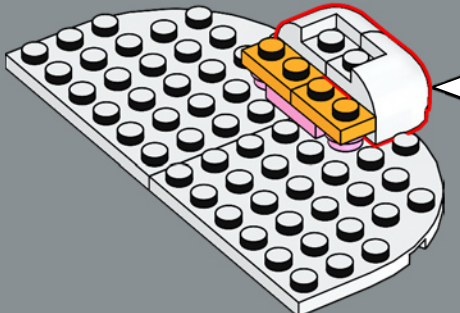
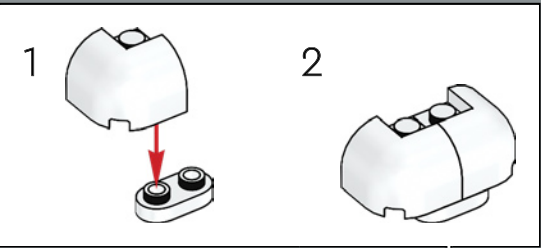

99

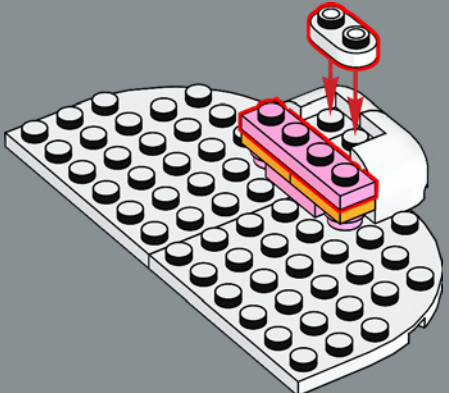



100

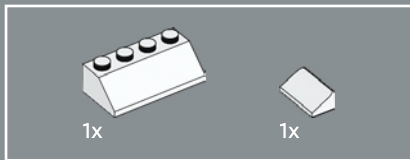
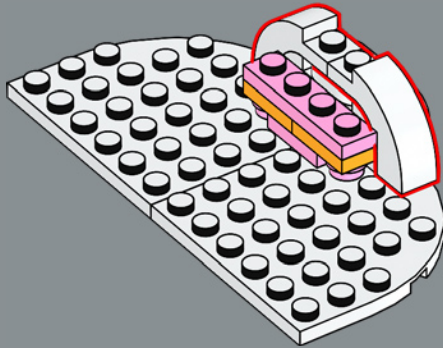

101

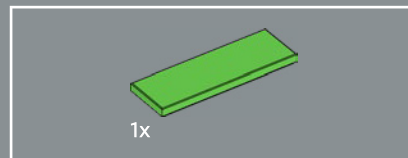
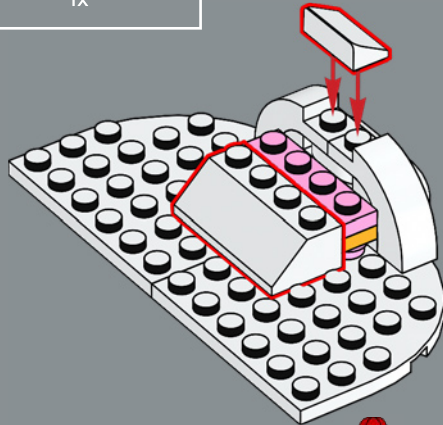

102

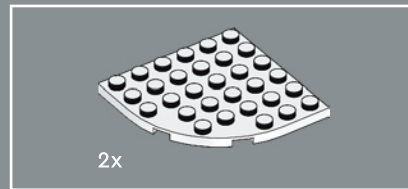
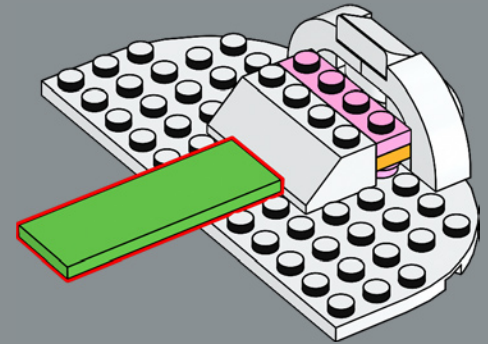

103

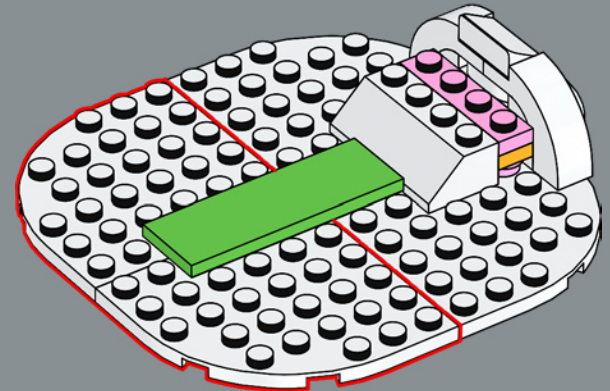

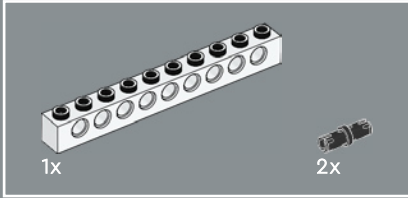
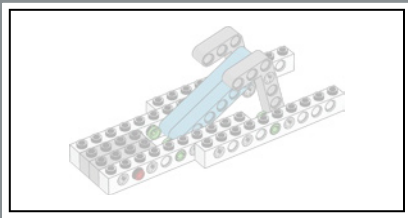

104

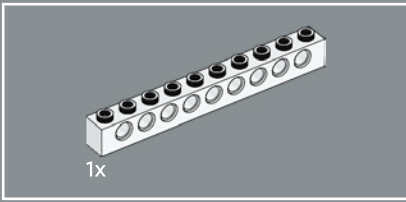
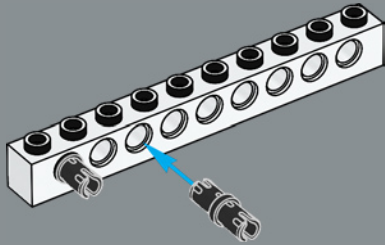

105

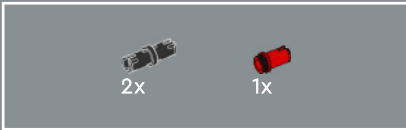
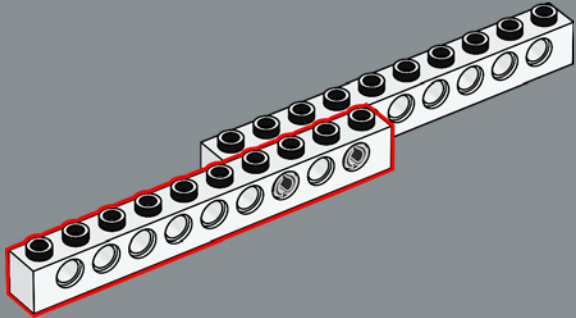

106

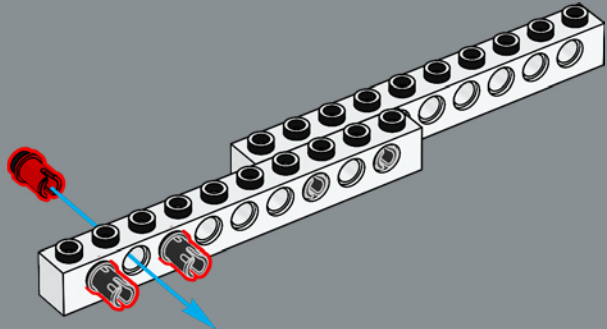

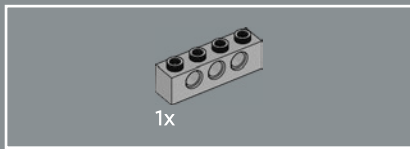

107

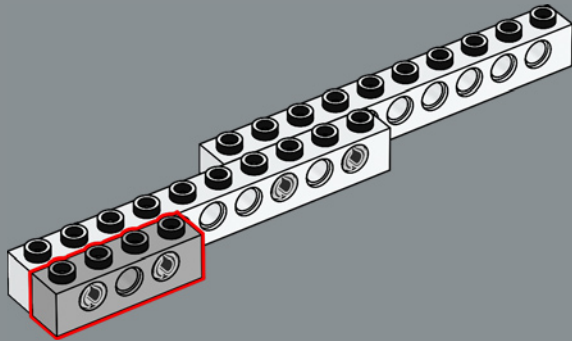

108

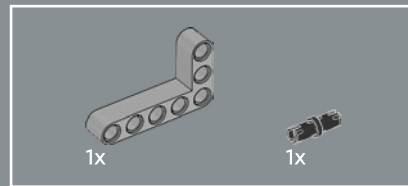
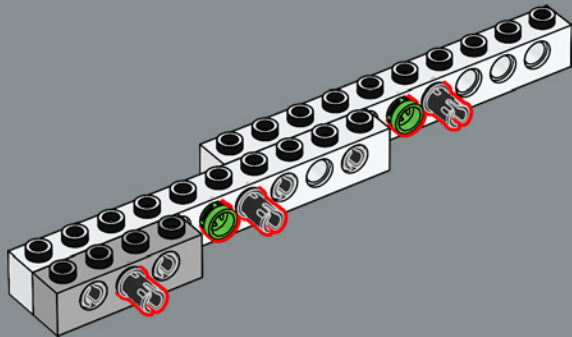

109

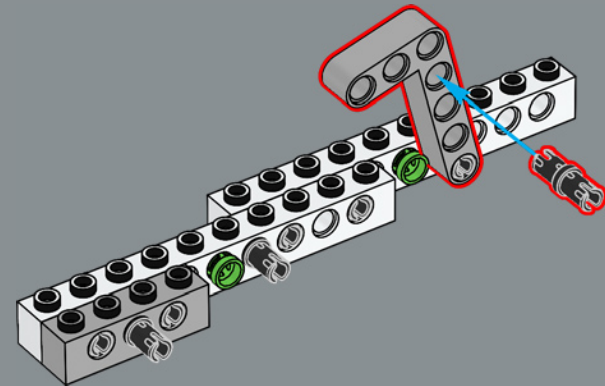

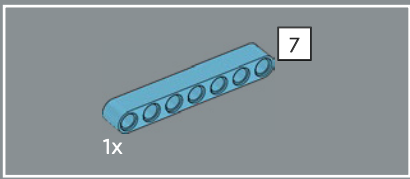

110

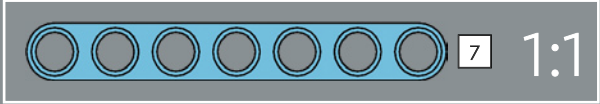
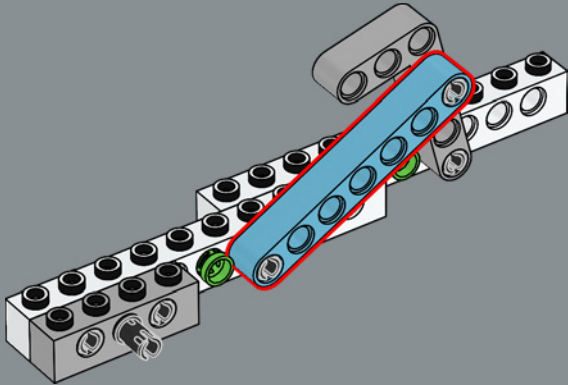

111

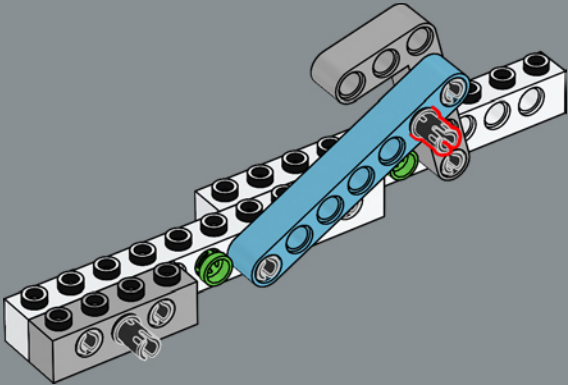

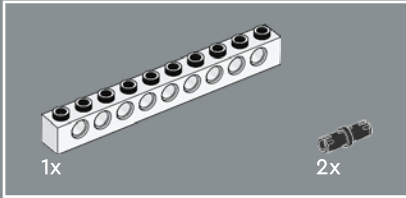
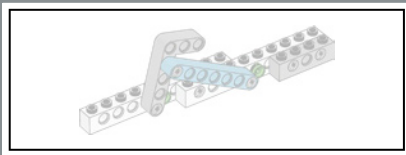

112

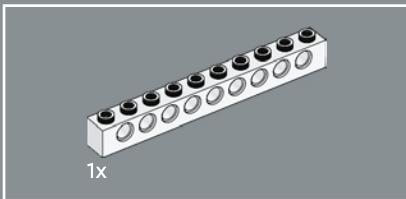
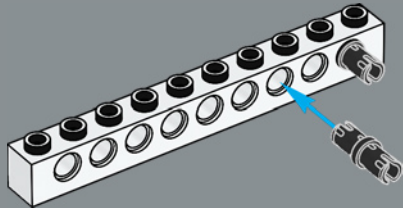

113

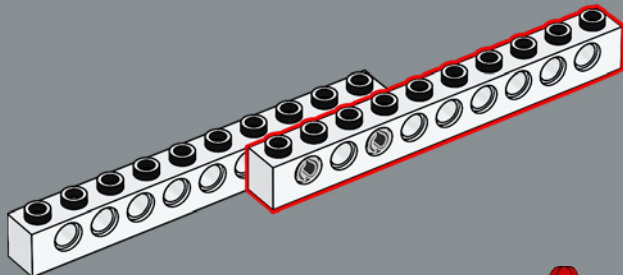

114

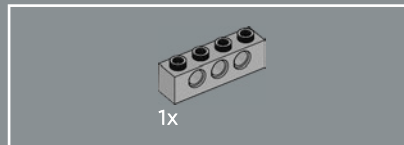
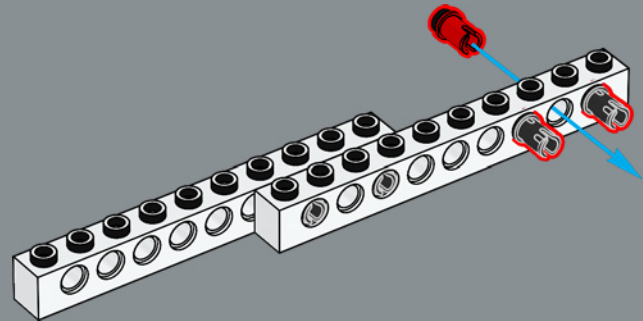

115

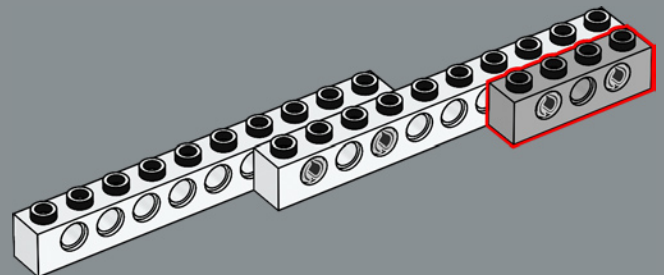



116

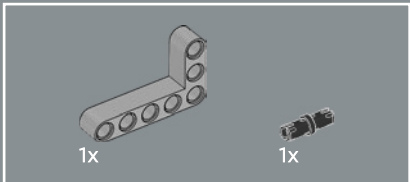
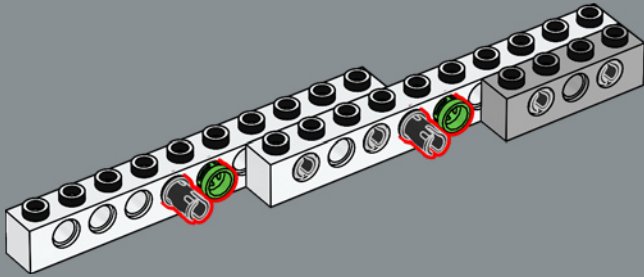

117

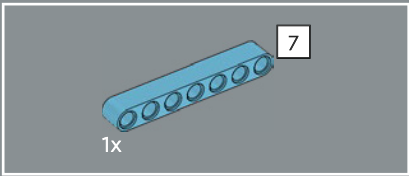
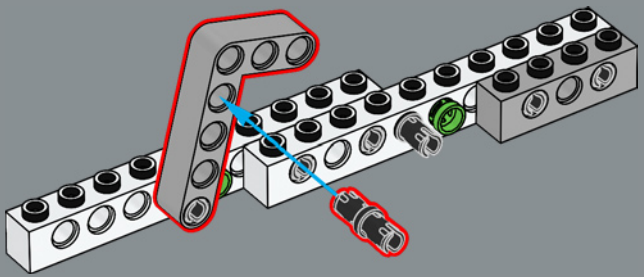

118

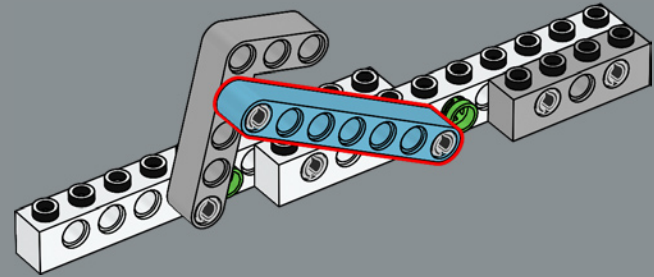

119

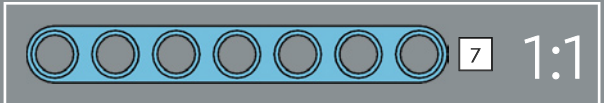
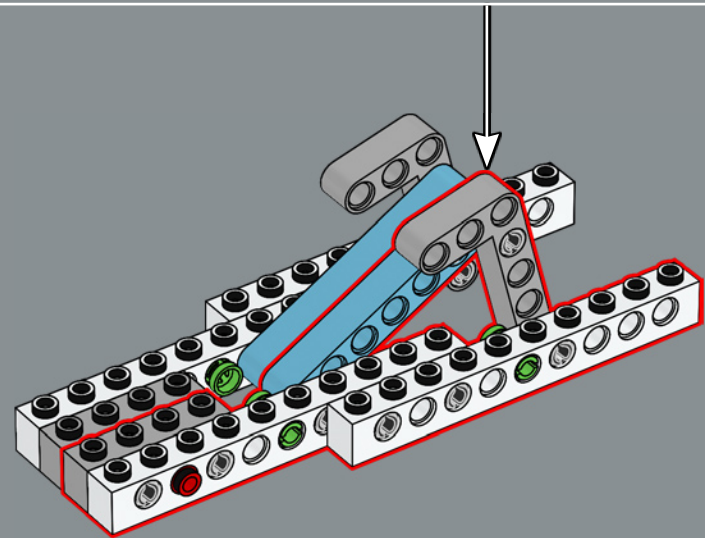

120

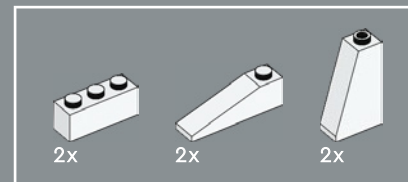
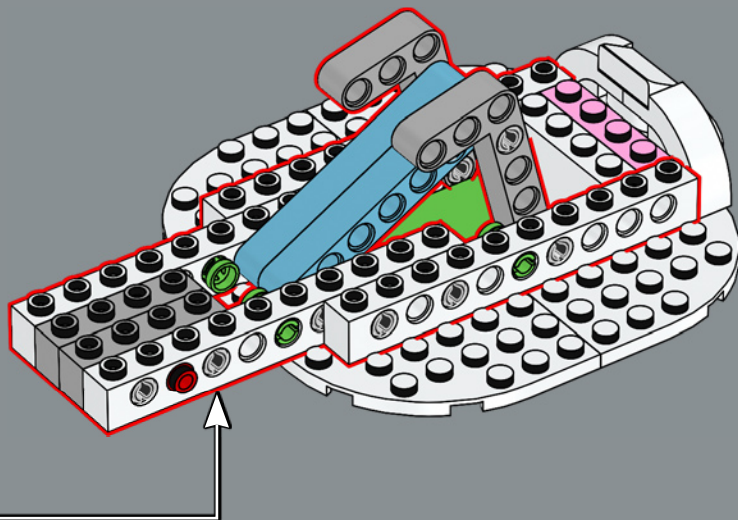

121

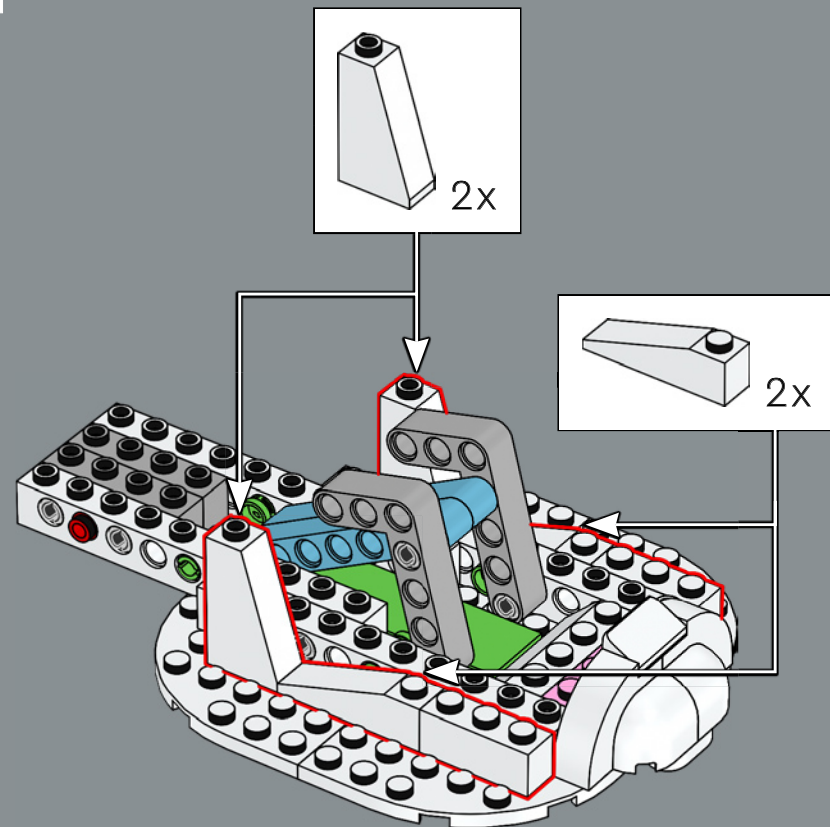

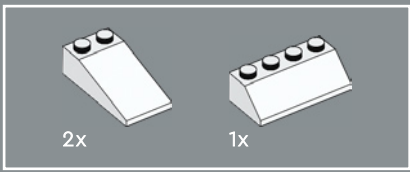

122

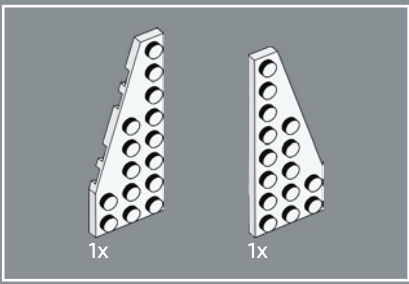
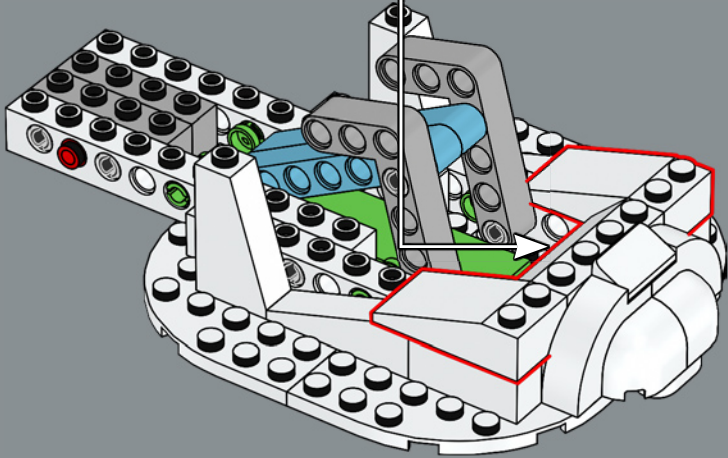
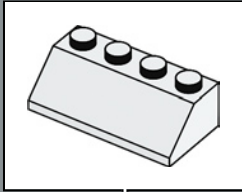

123

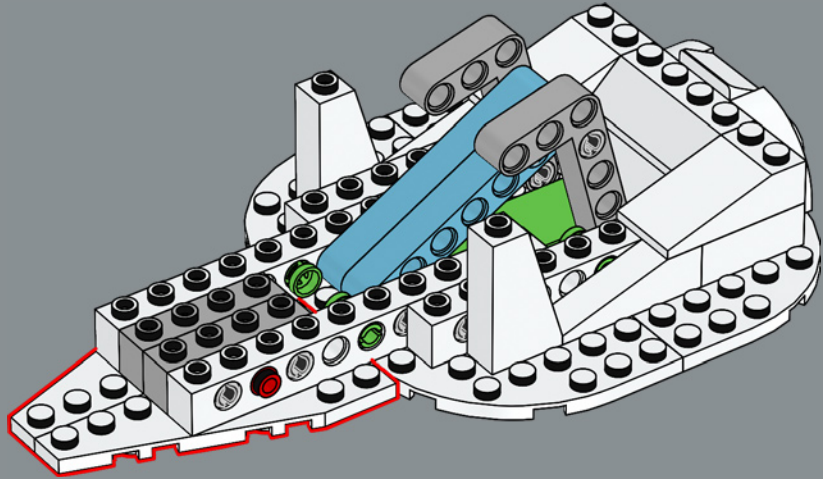

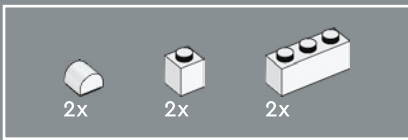

124

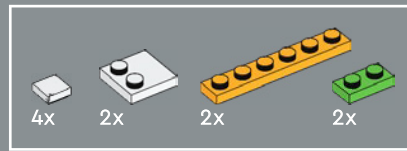
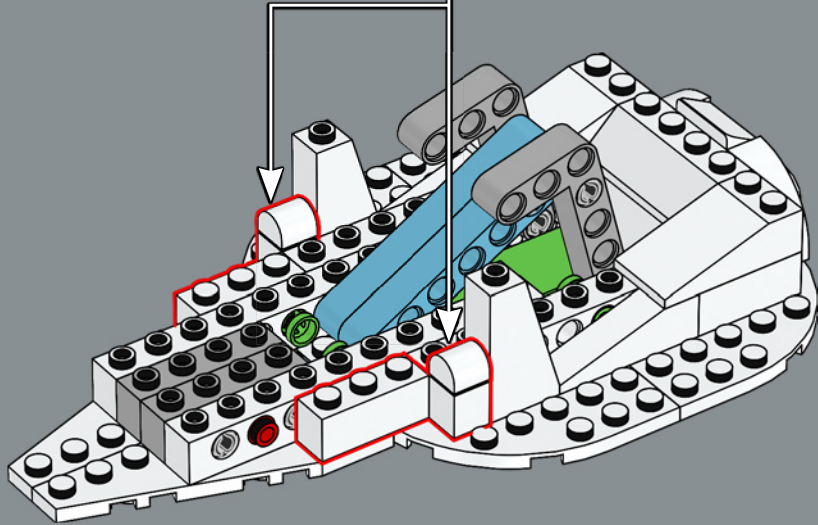
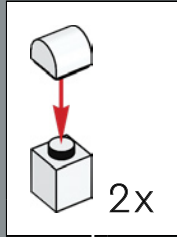

125

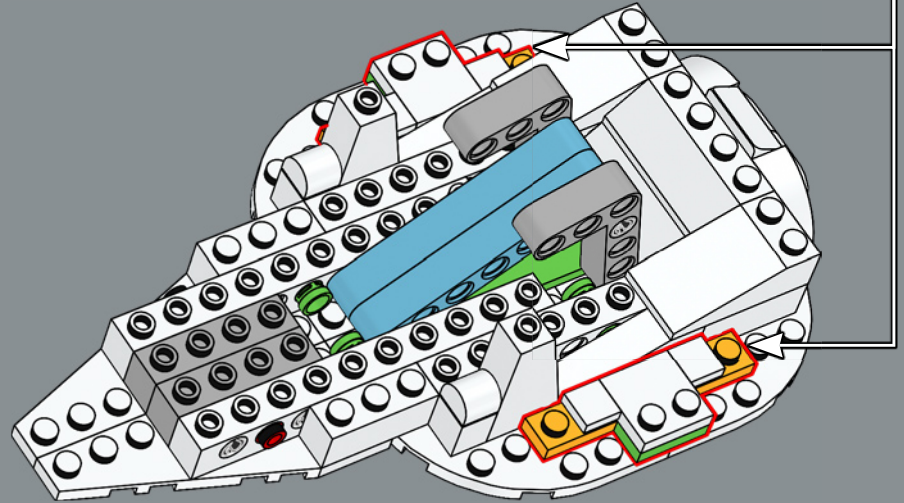
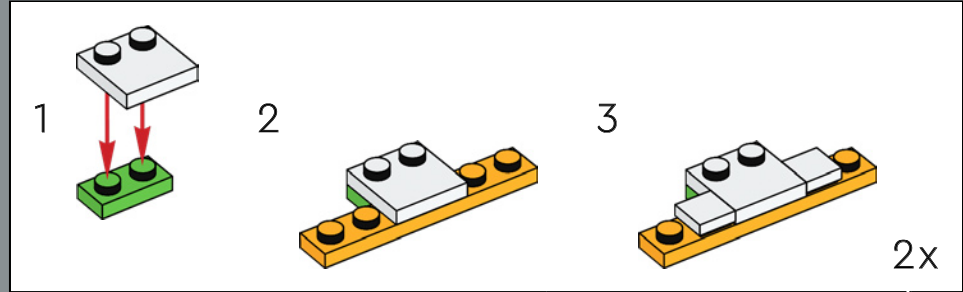



126

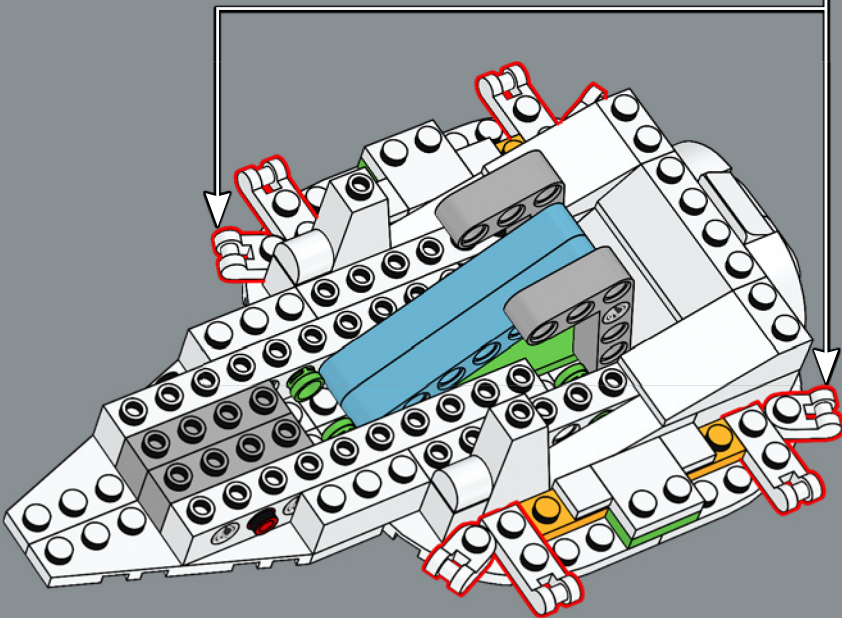

127

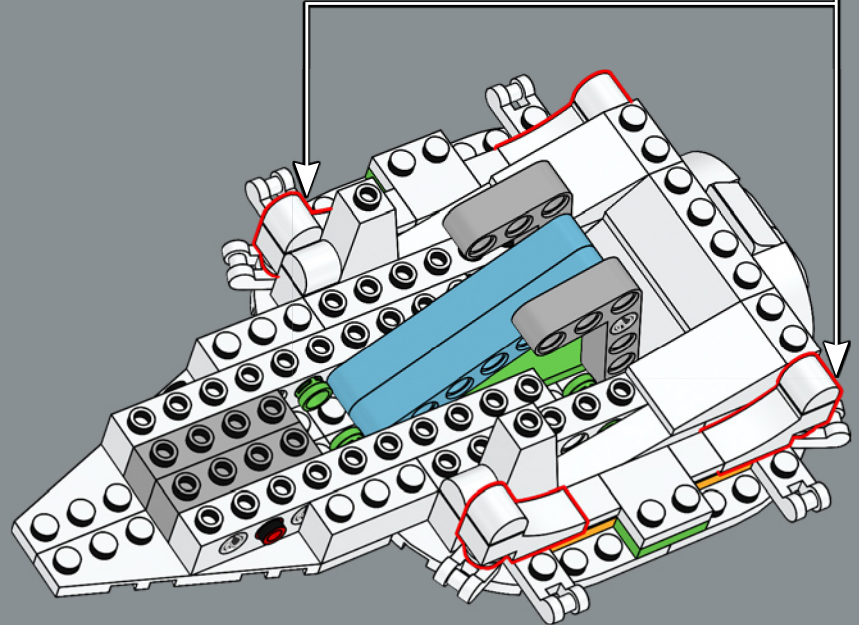
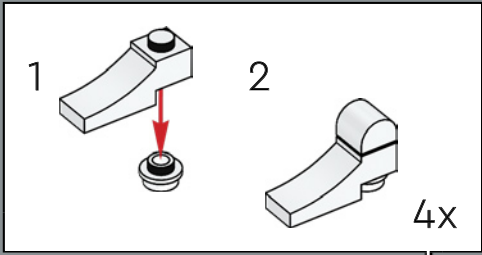



128



129

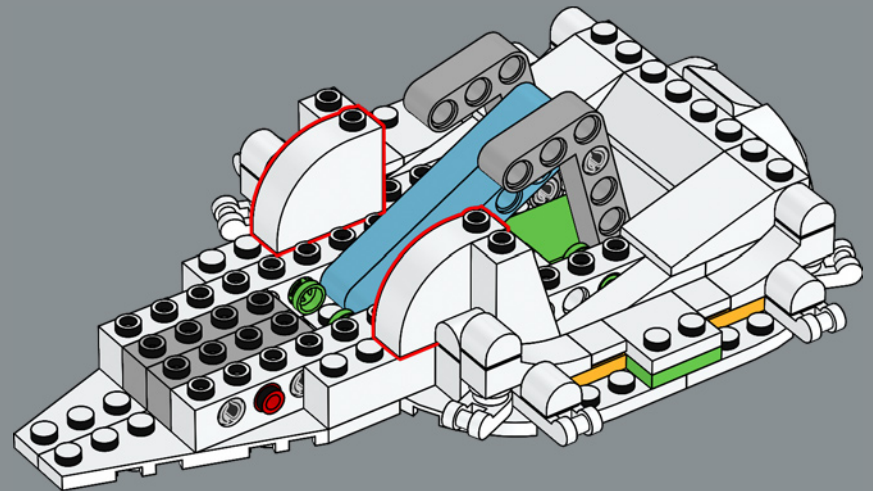
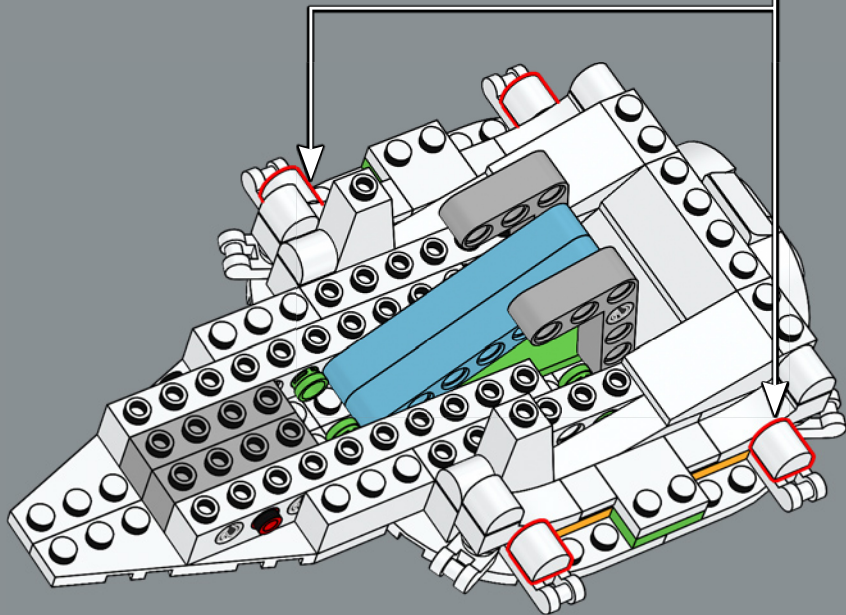
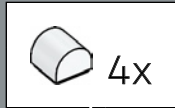

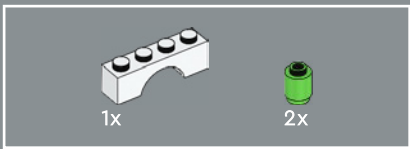

130

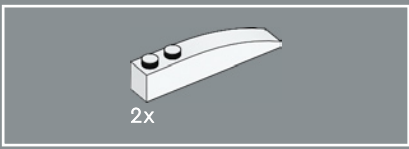
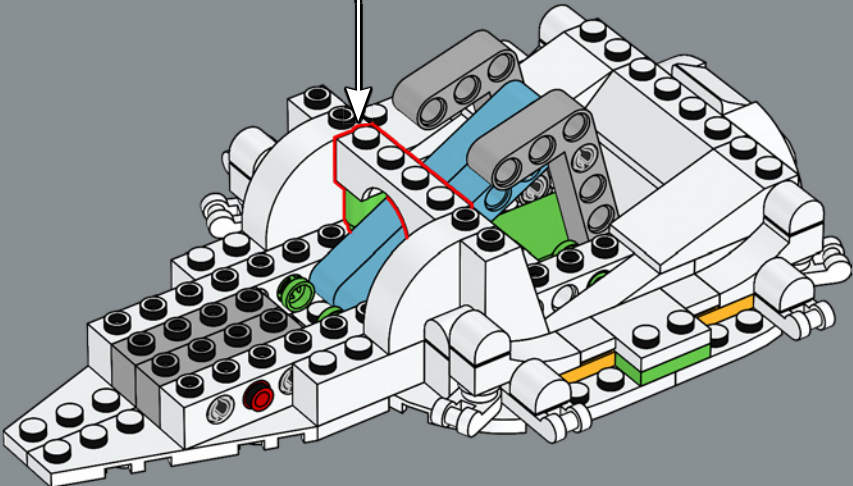
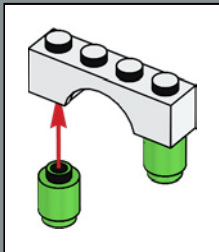

131

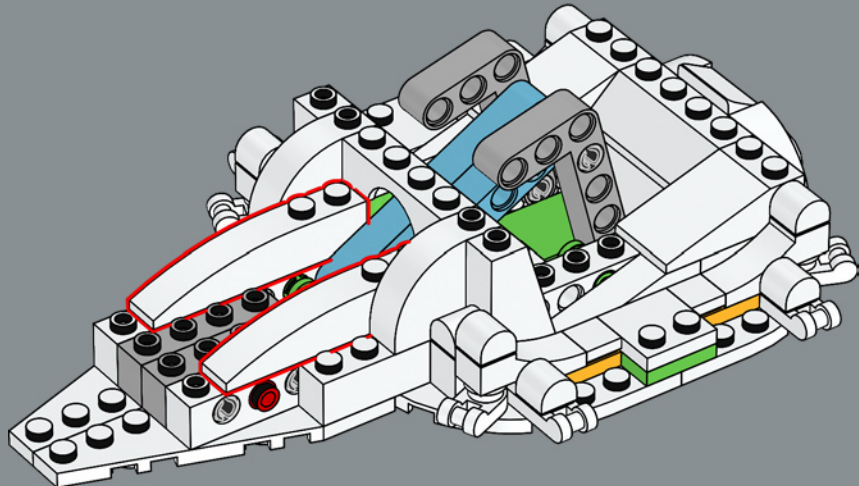

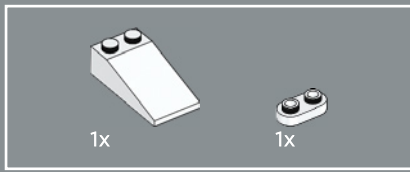

132

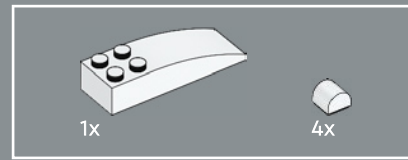
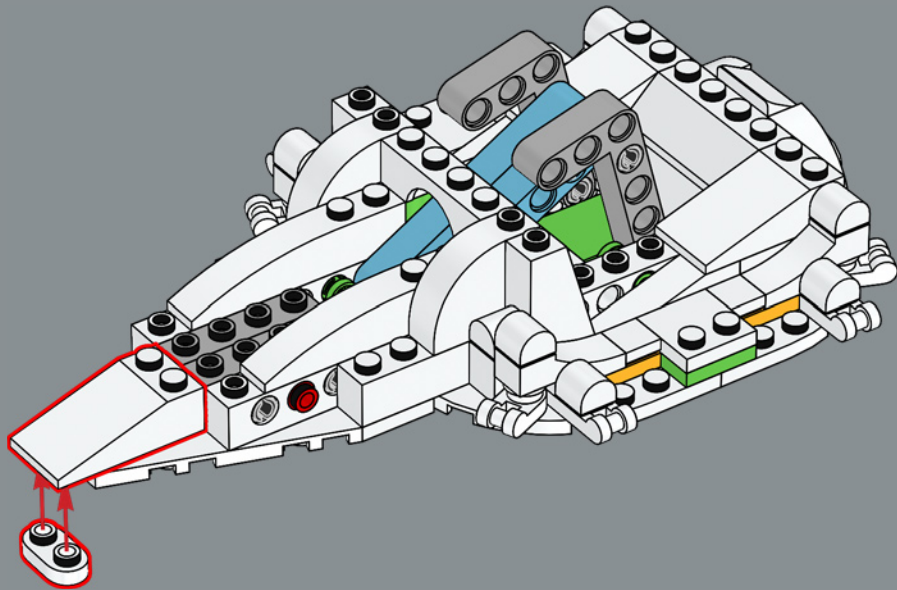

133

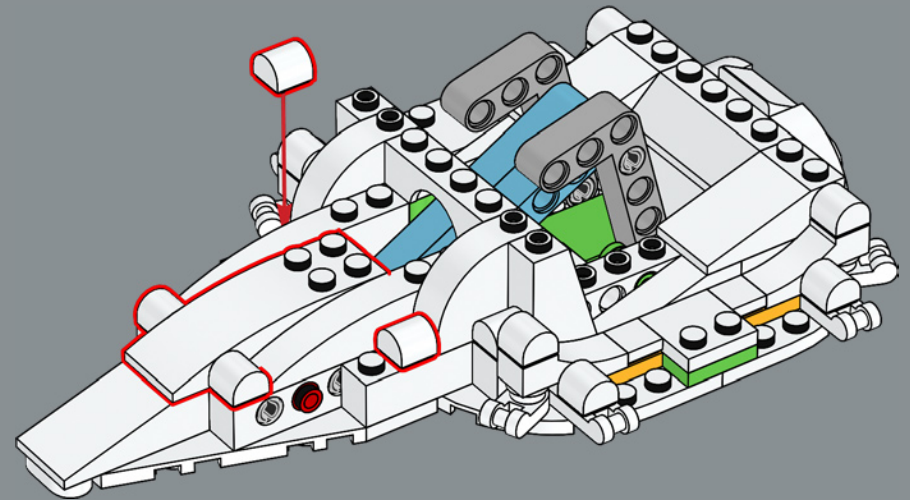

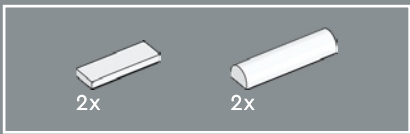

134

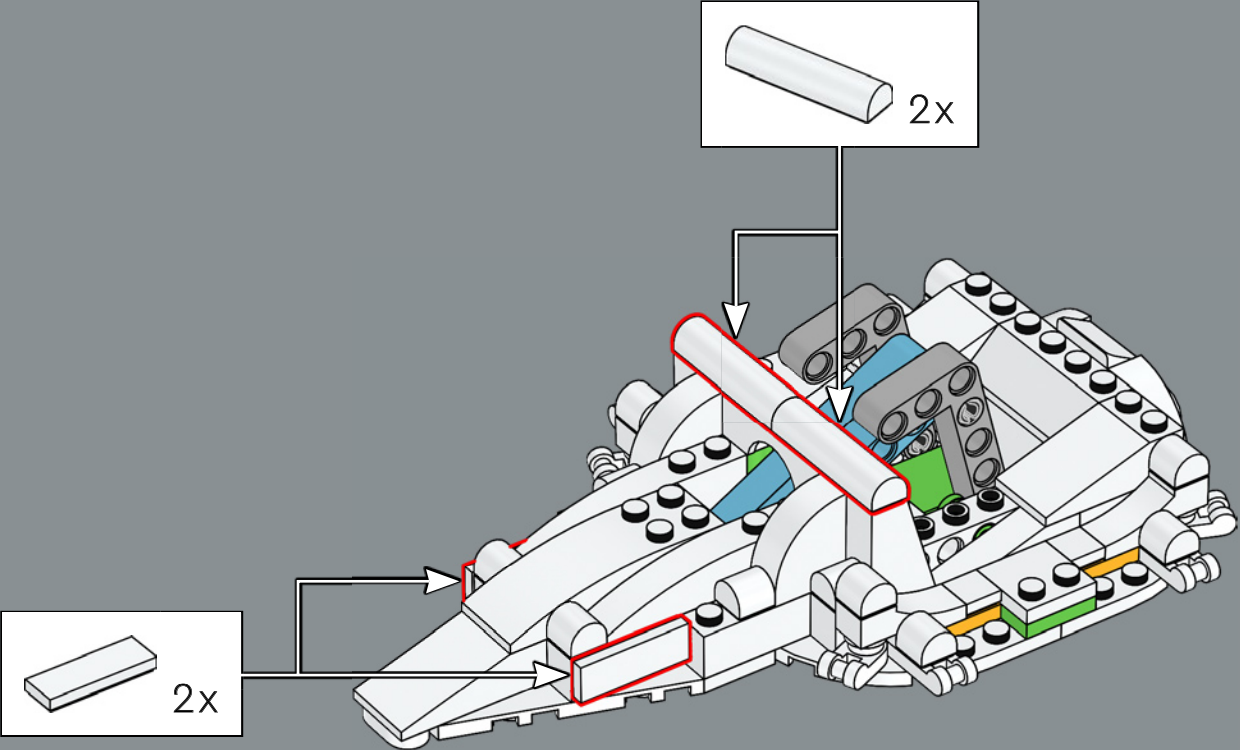

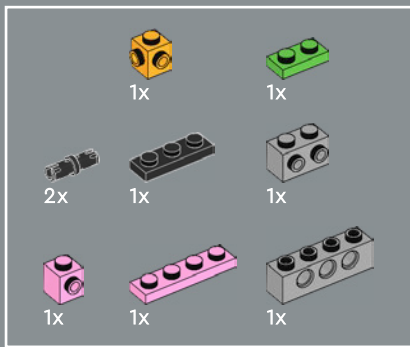

135

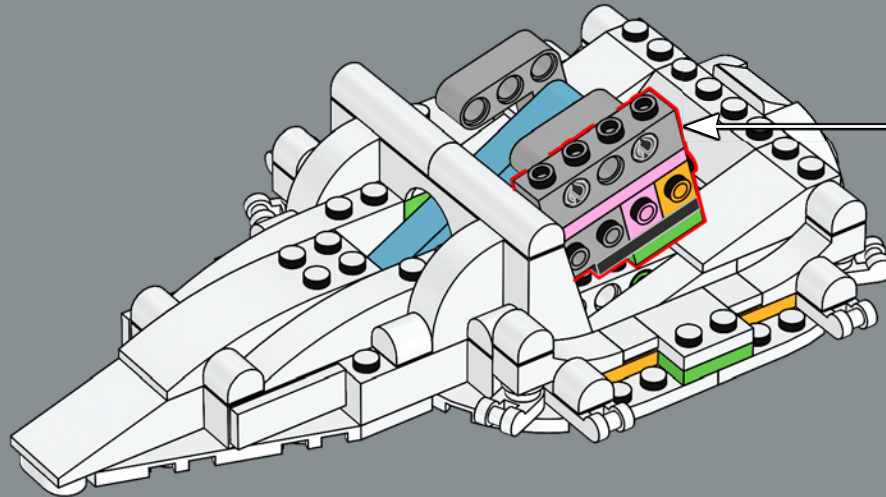
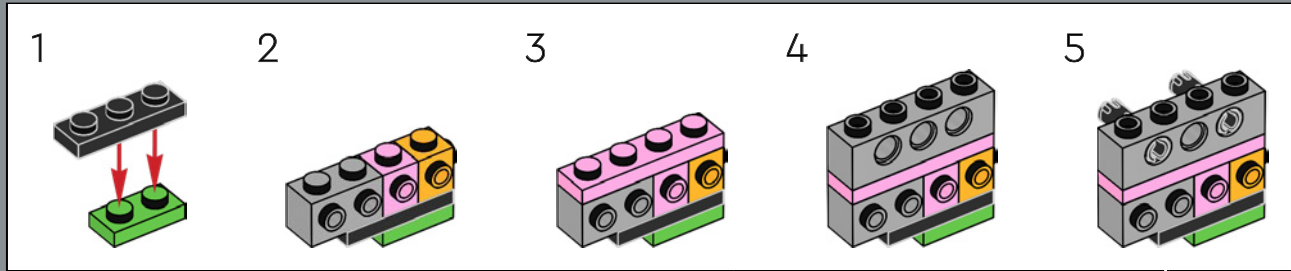

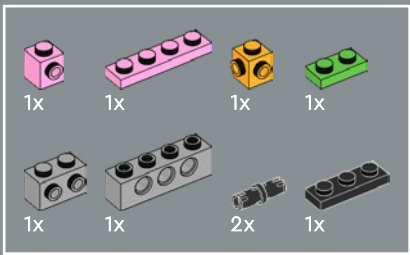

136

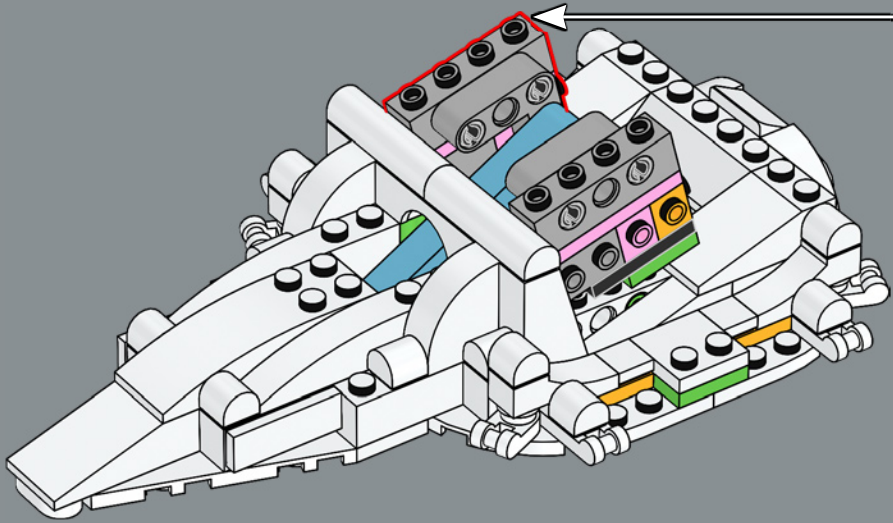
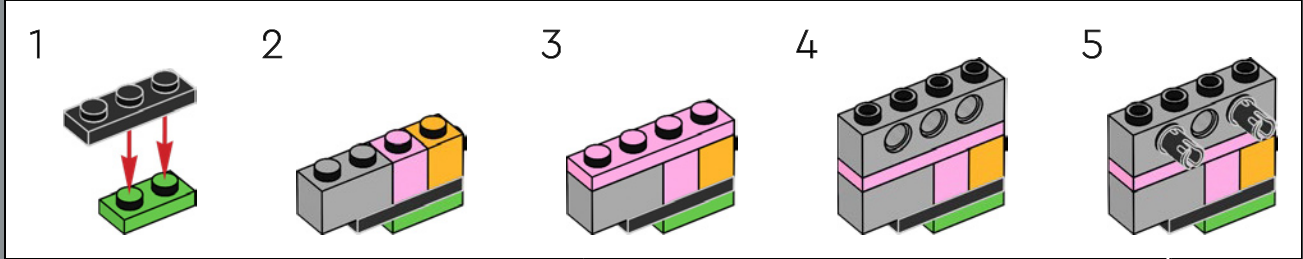

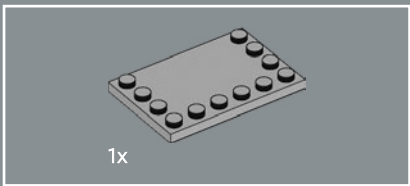

137

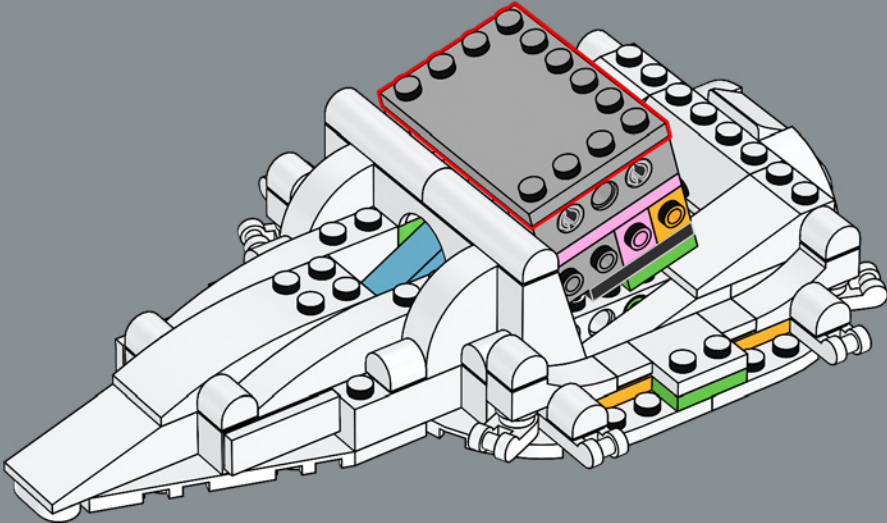

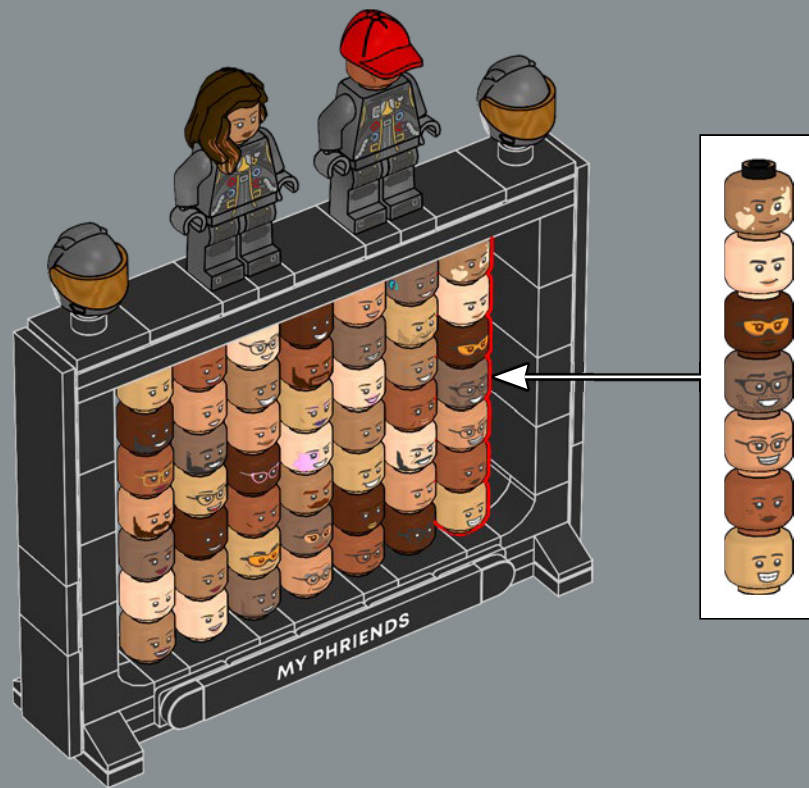
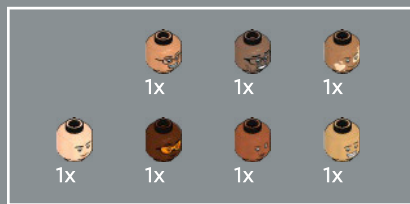

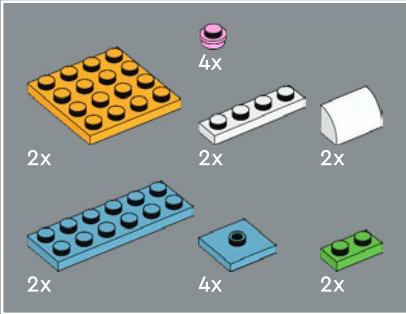
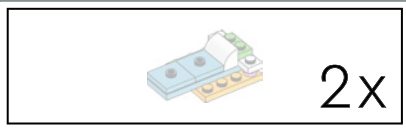

138

1

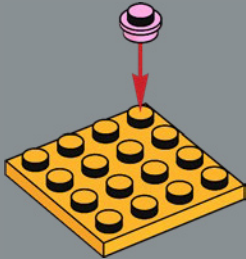

2

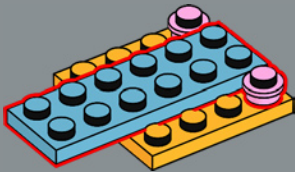

3

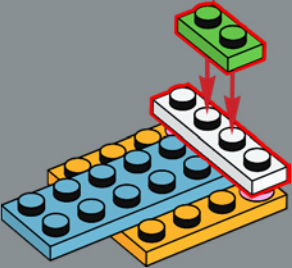

4

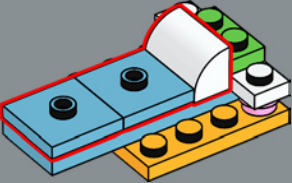

2x



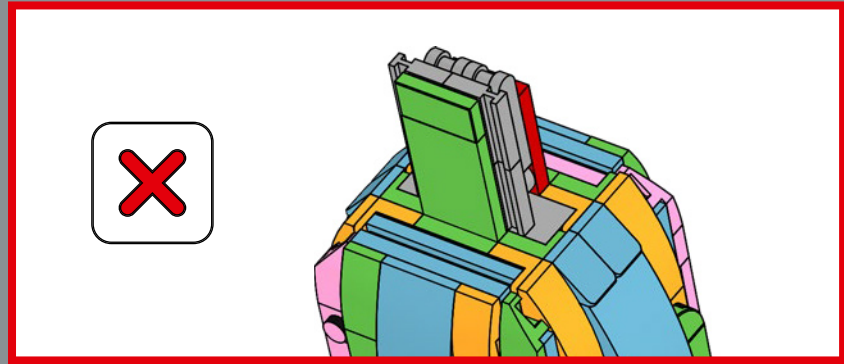
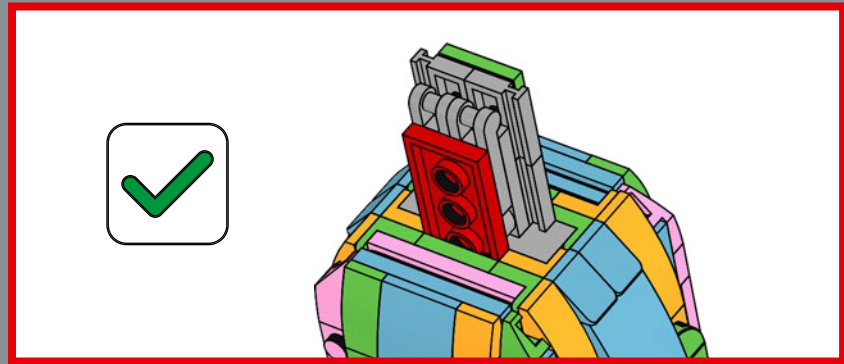
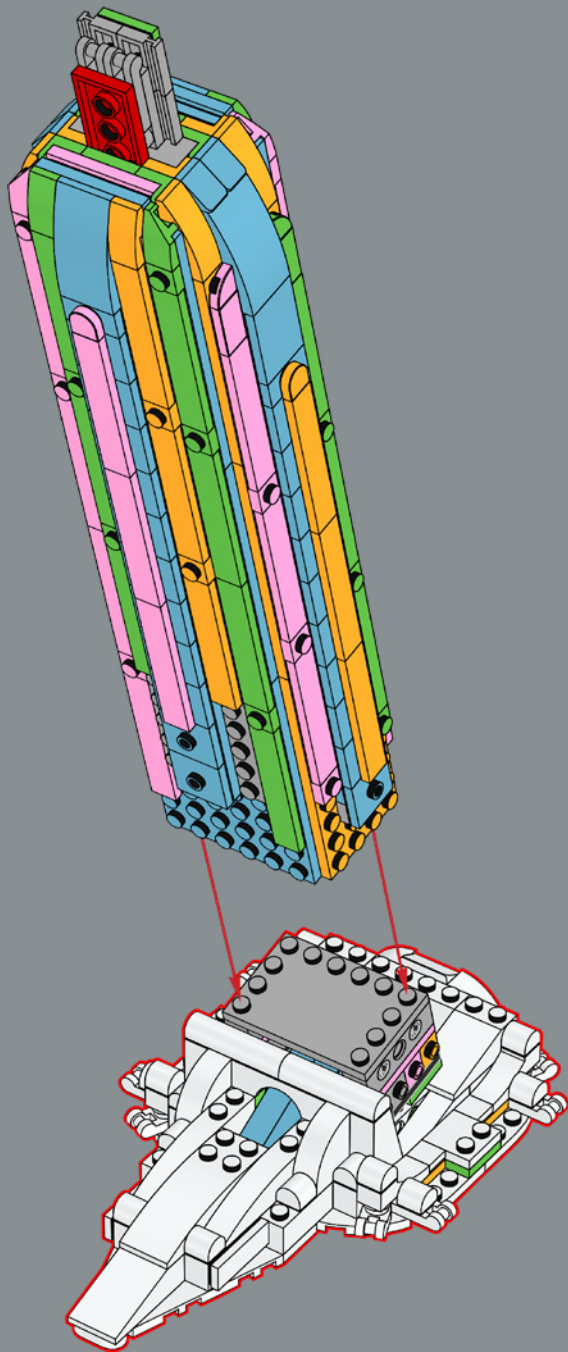

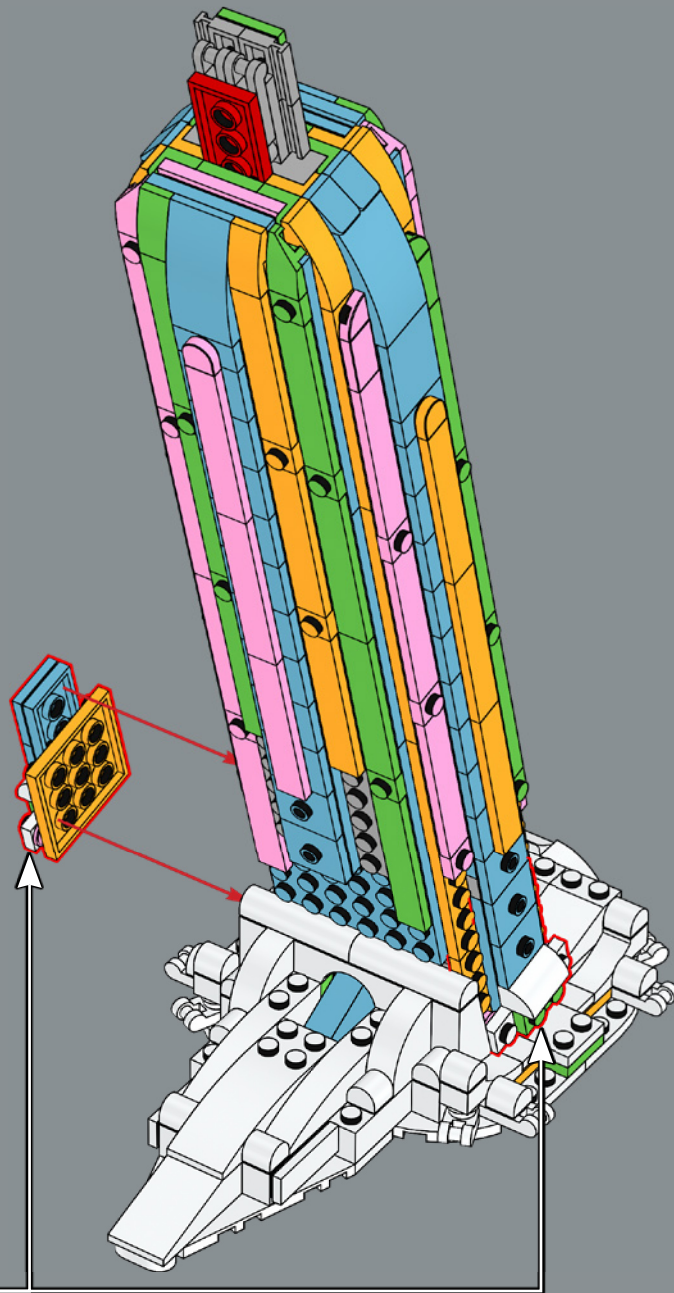

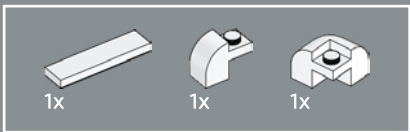

139

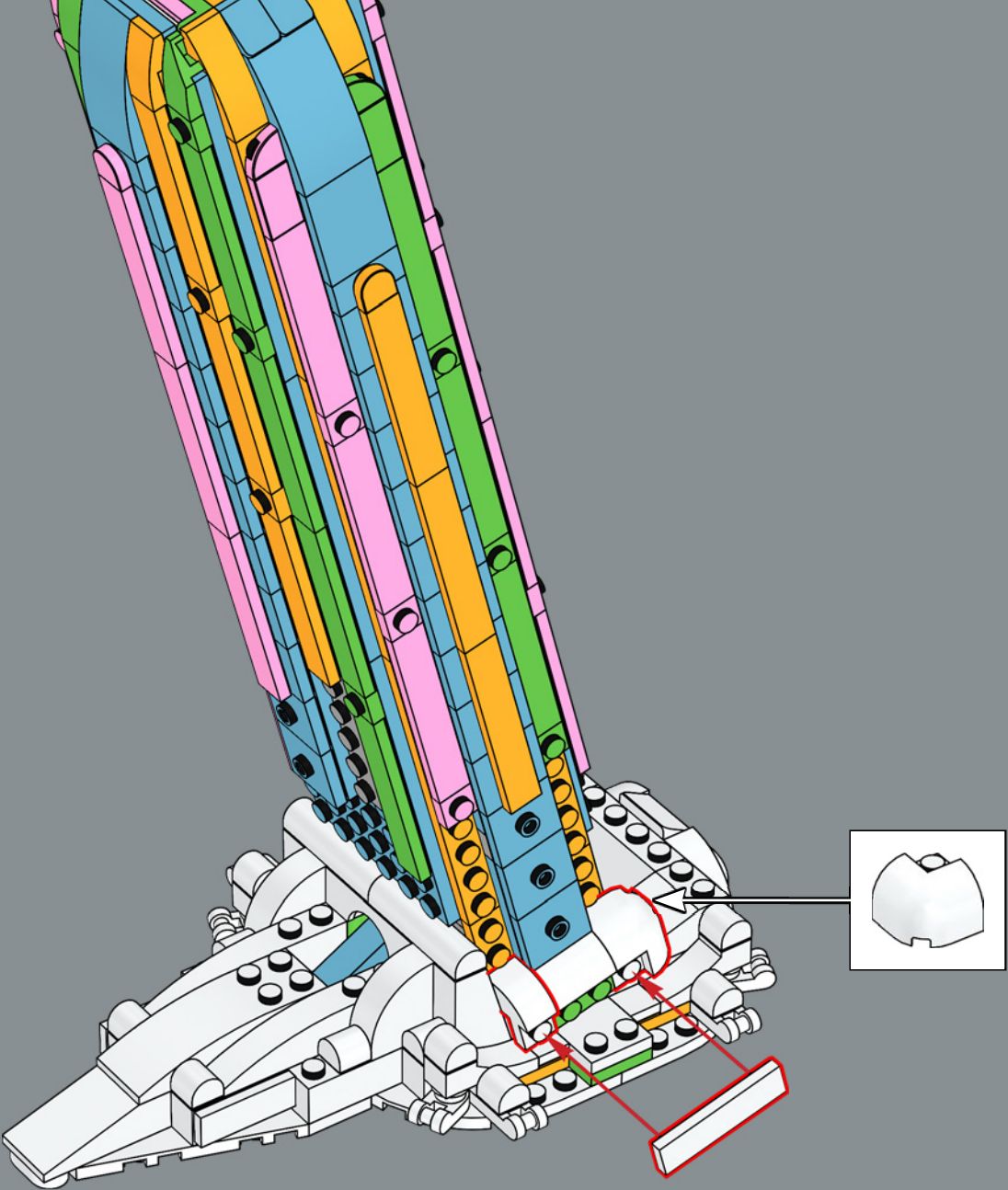

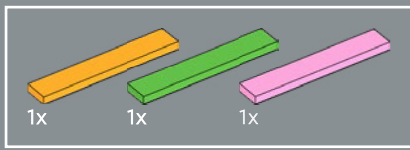

140

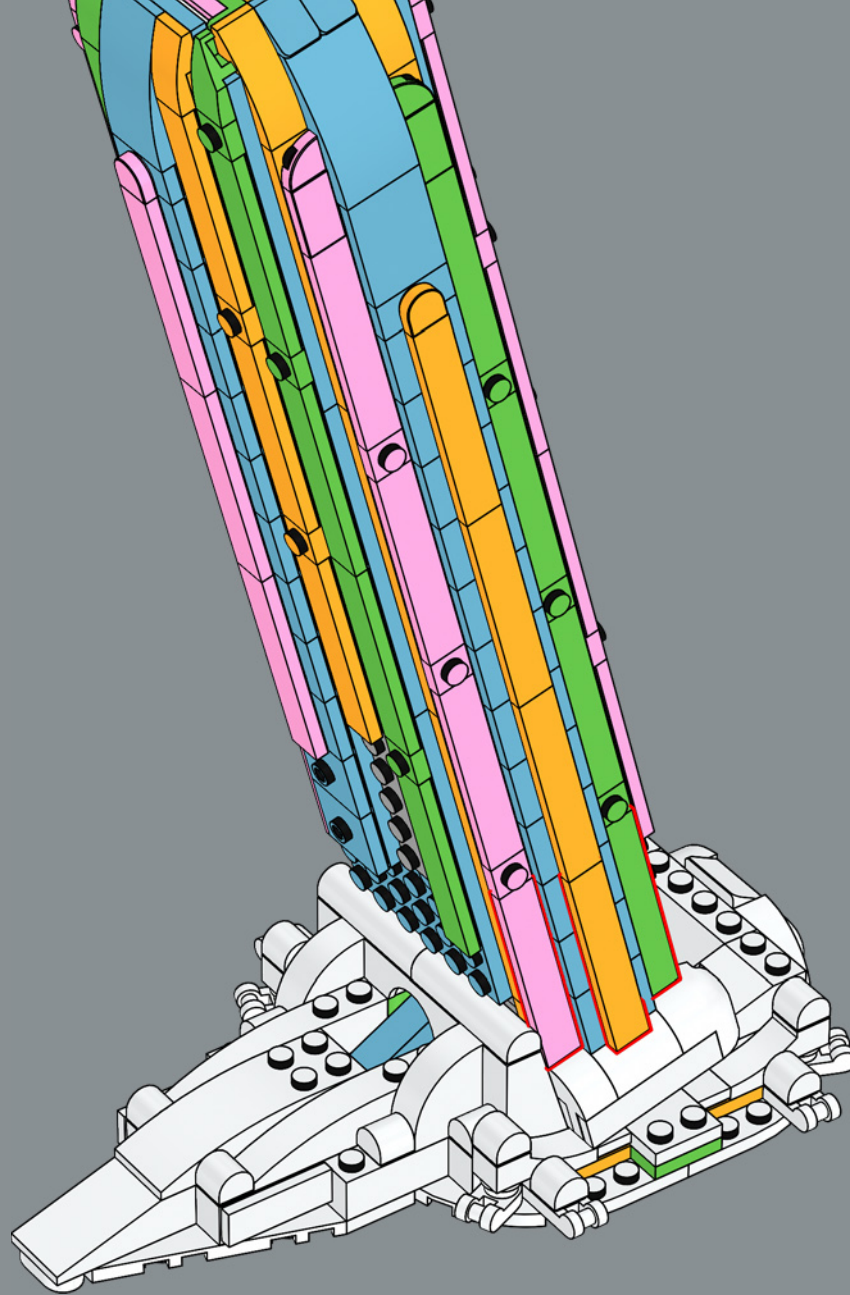

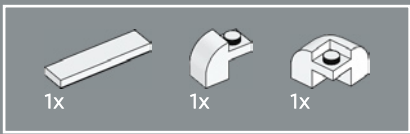

141

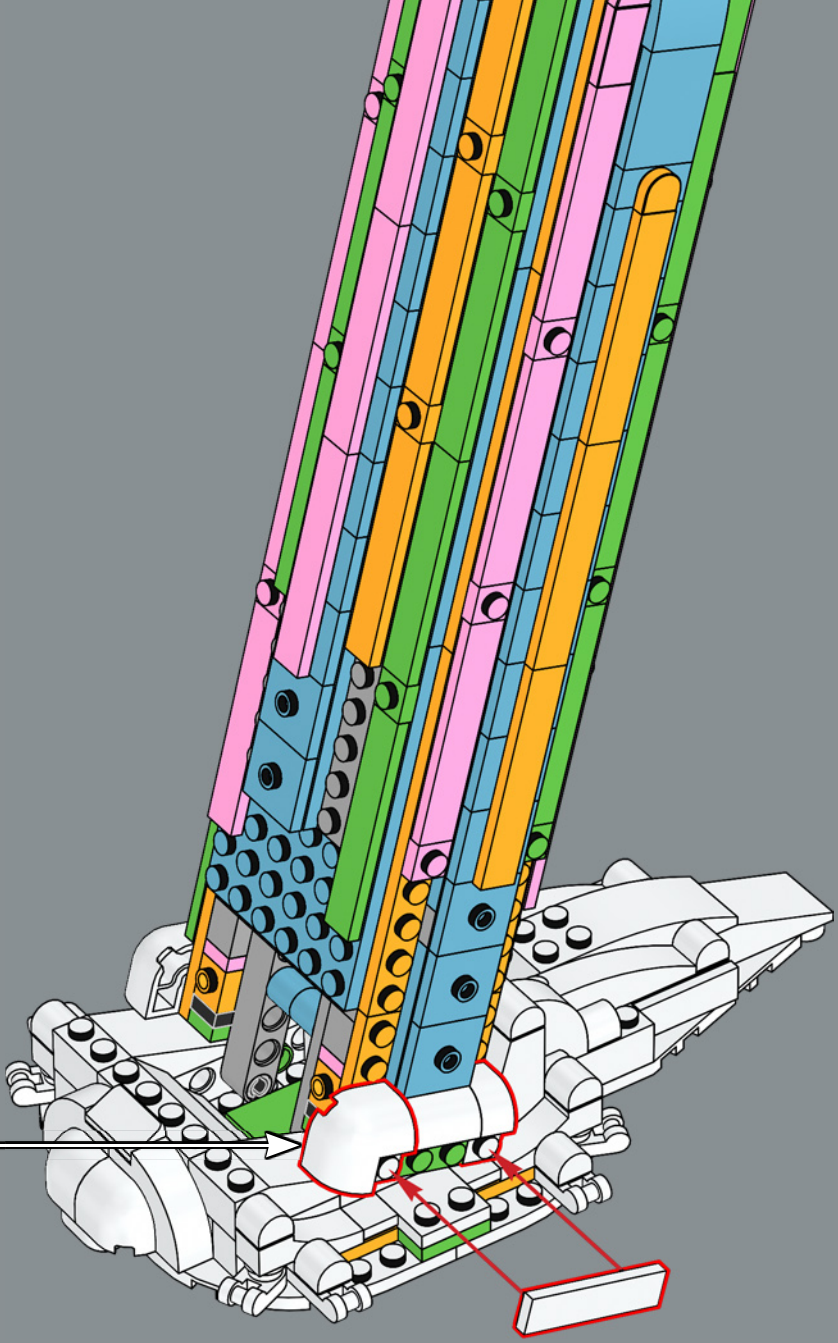
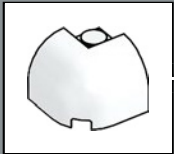

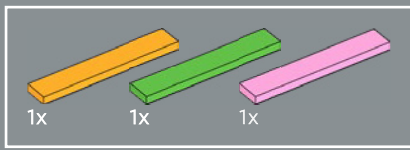

142

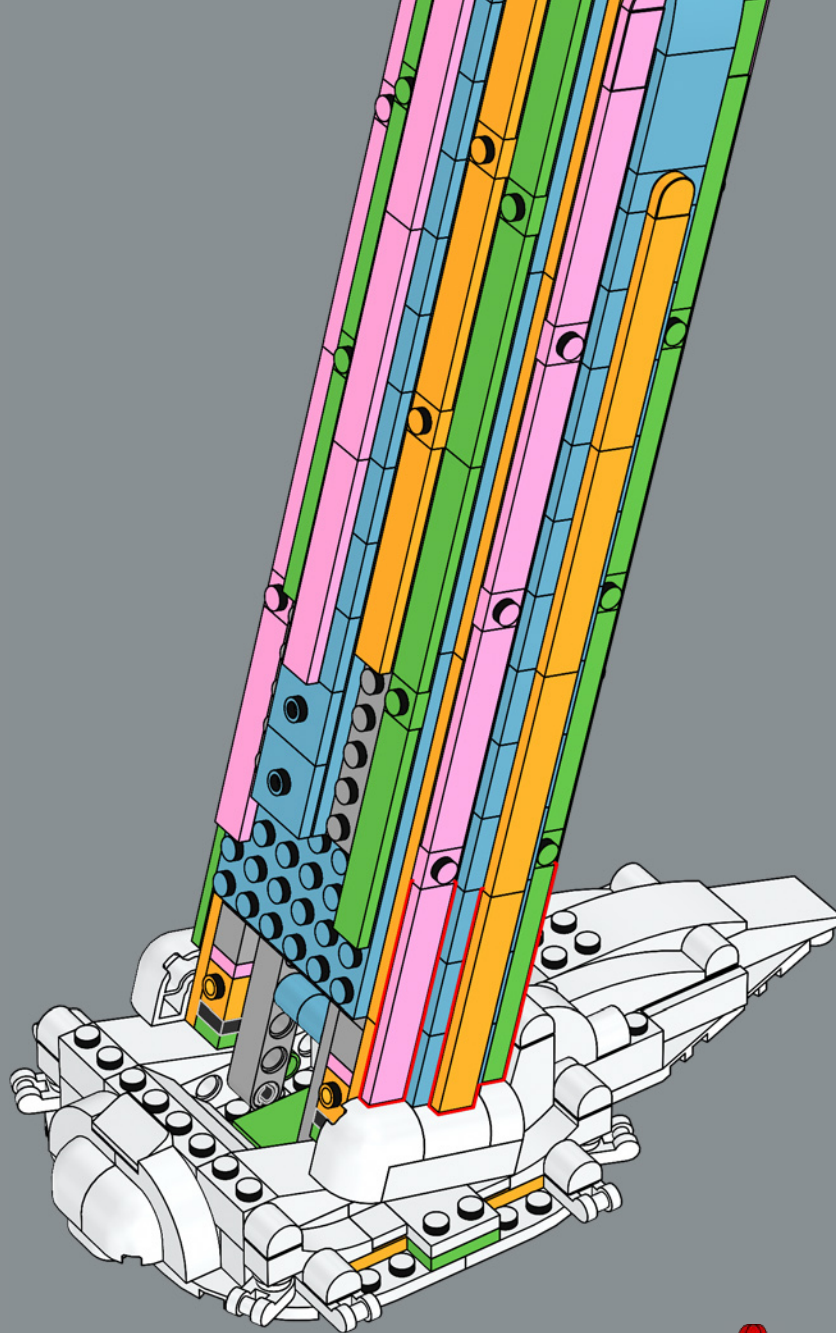

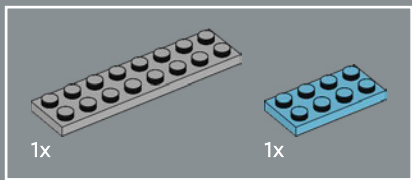

143

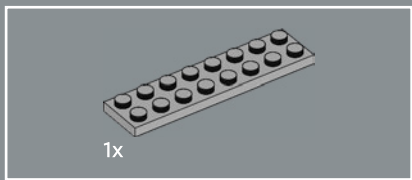
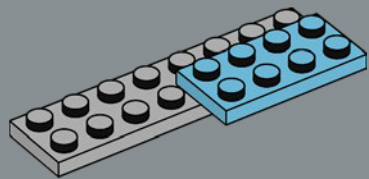

144

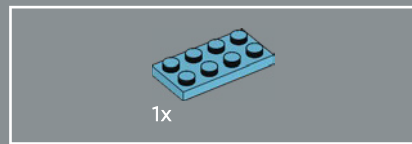
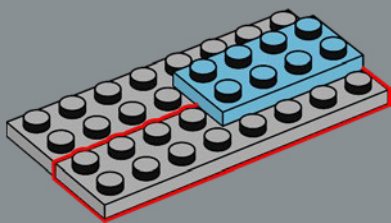

145

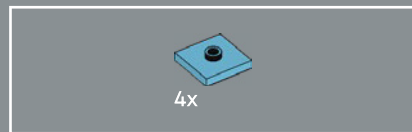
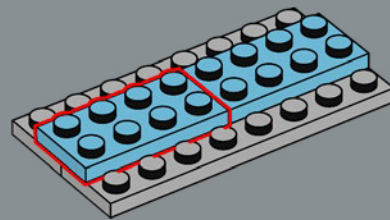

146

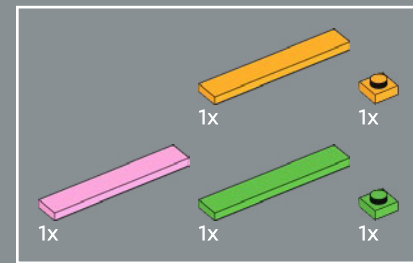
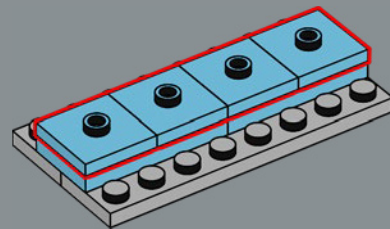

147

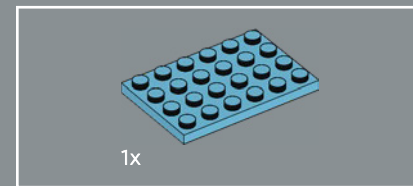
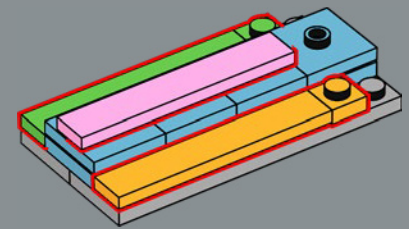

148

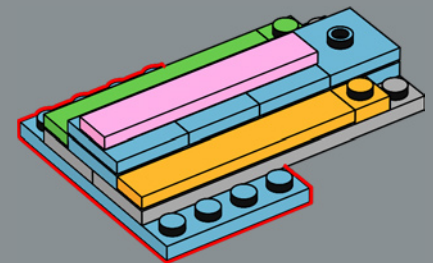

149

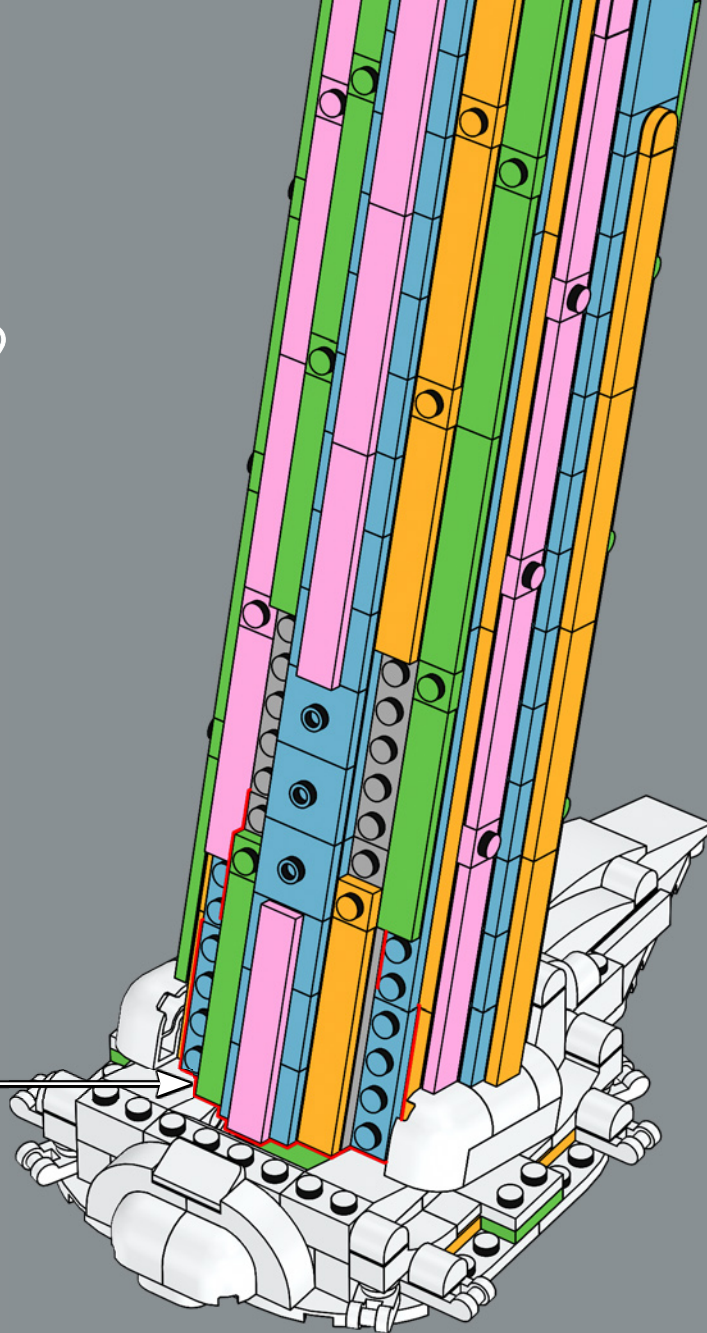

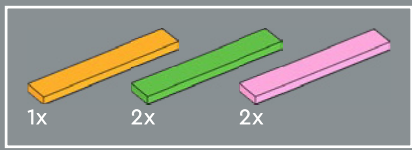

150

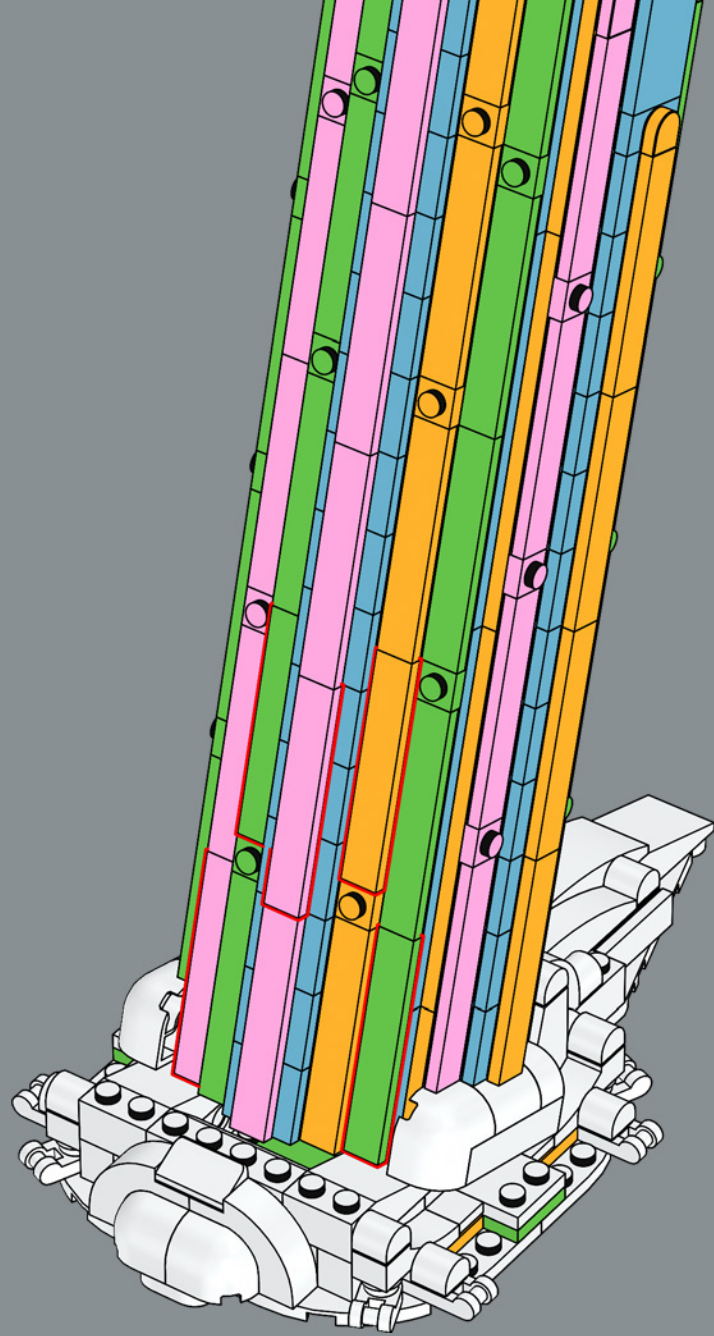

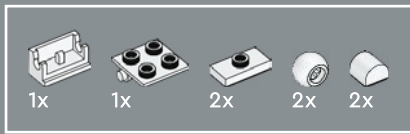

151

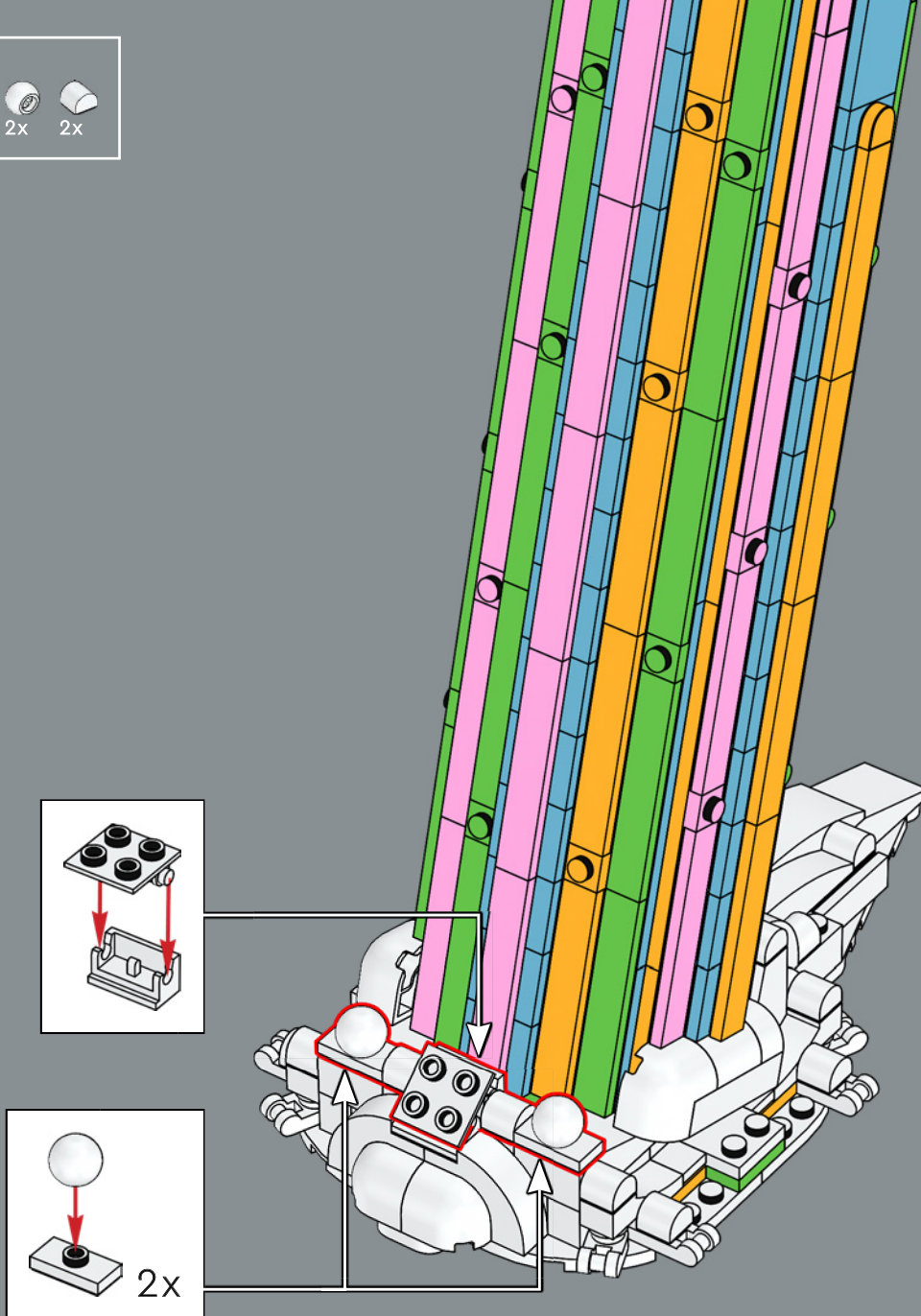

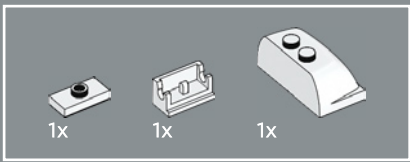

152

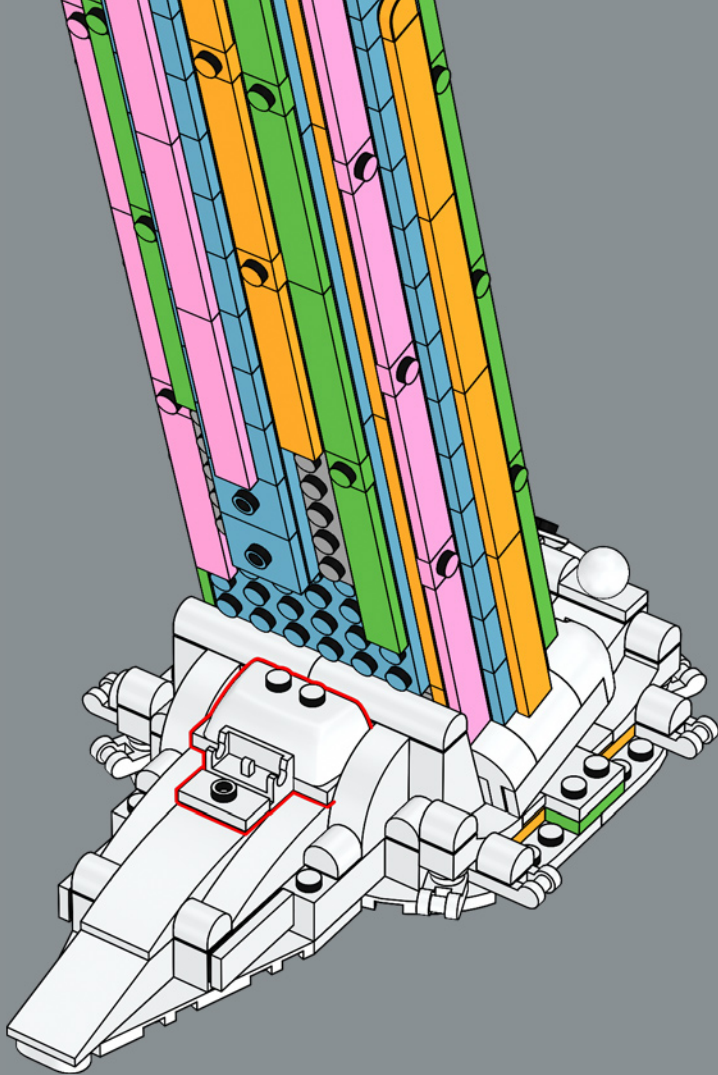

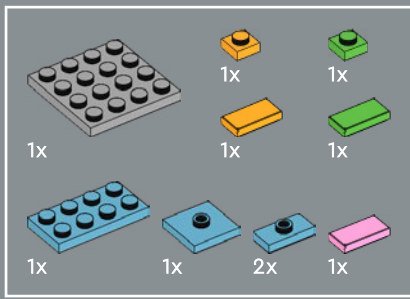

153

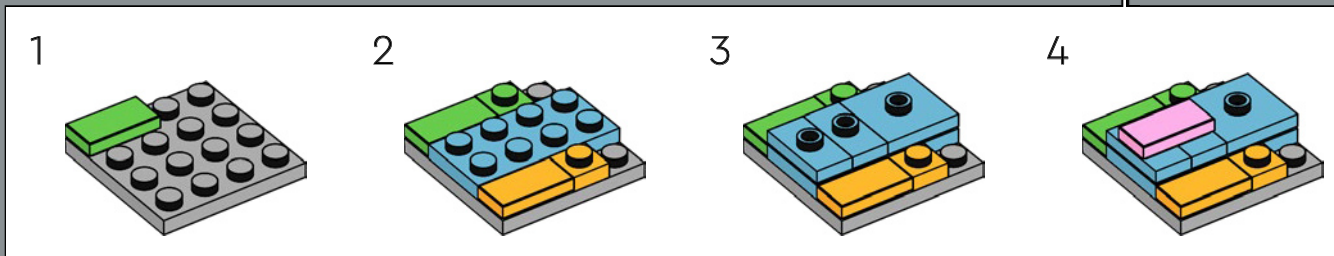
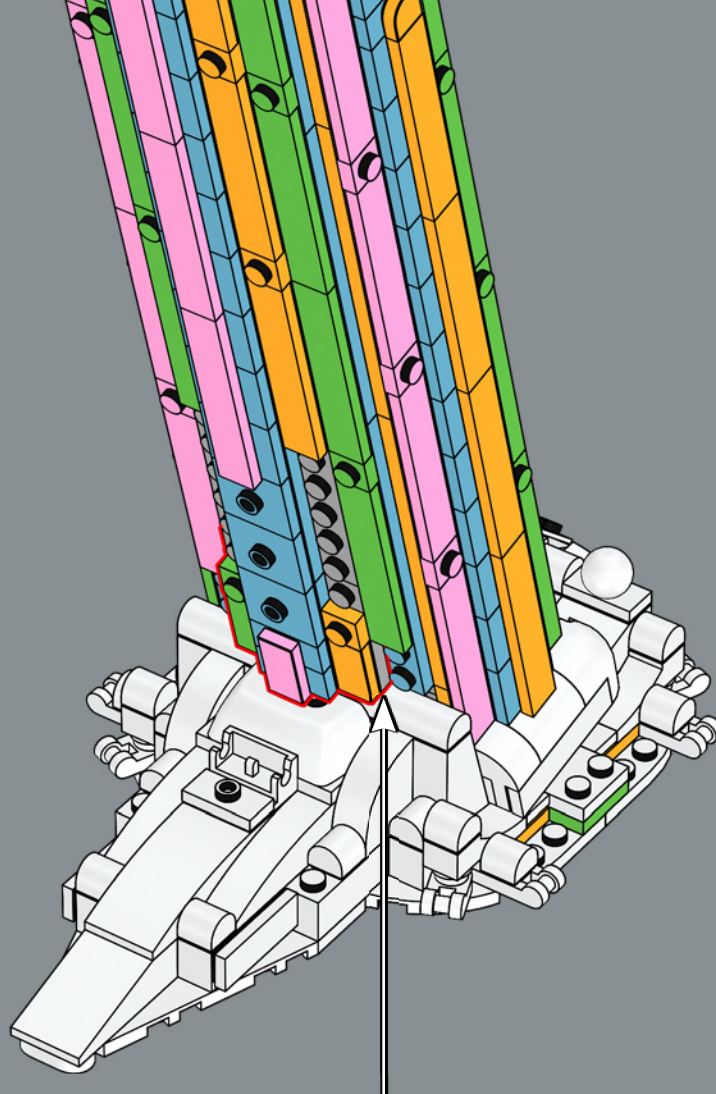

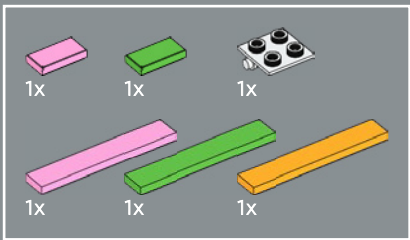

154

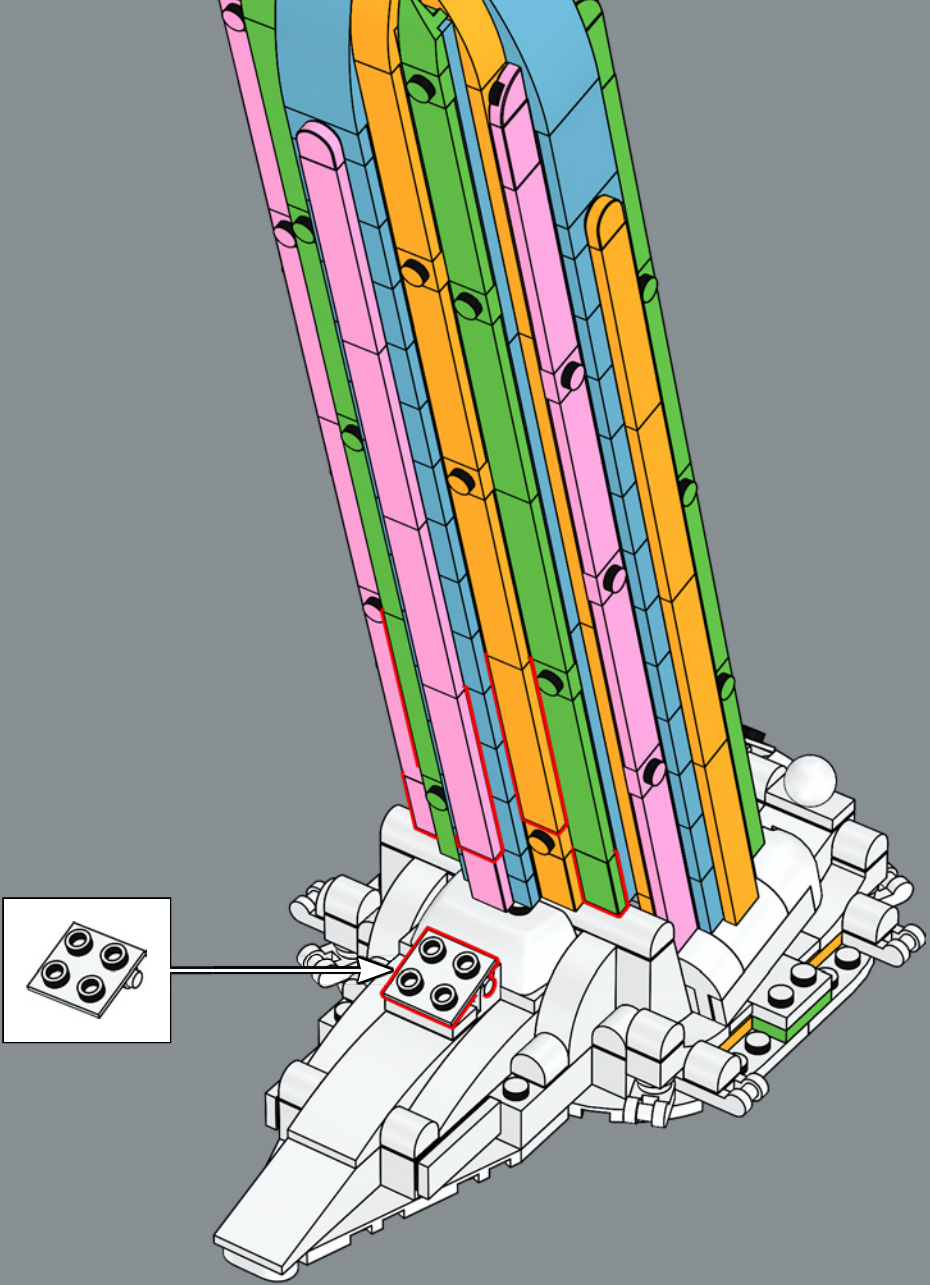

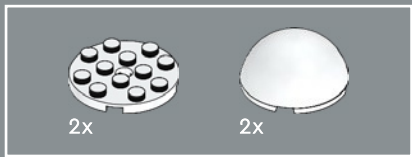

155

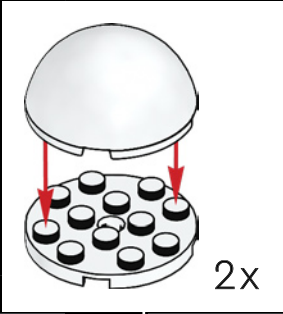
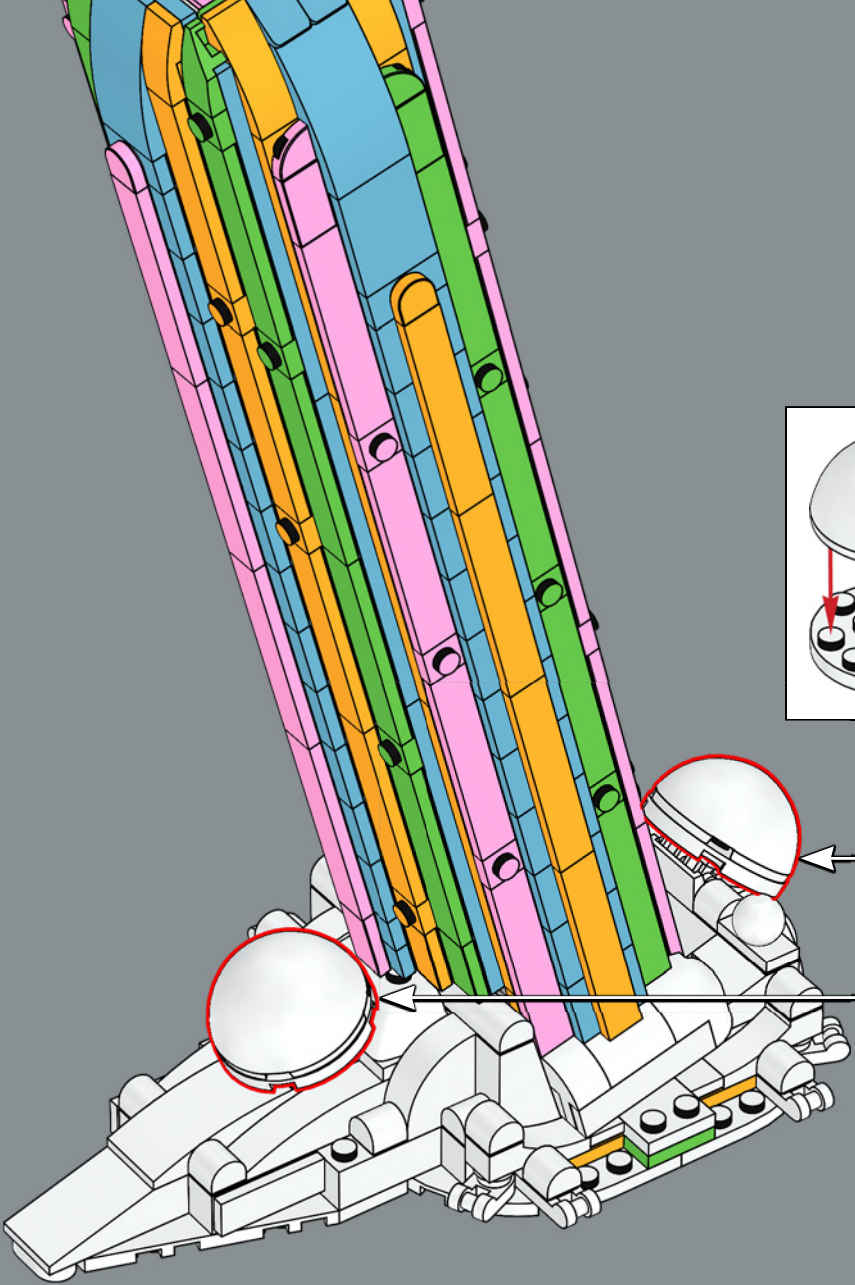

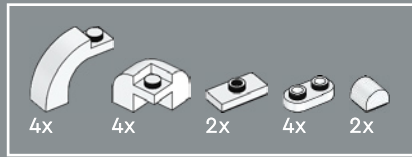

156

1

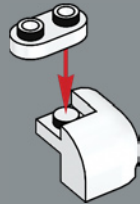

2



3

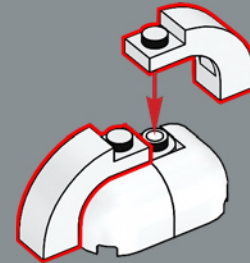

4

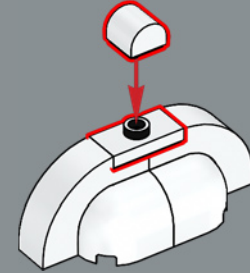

5

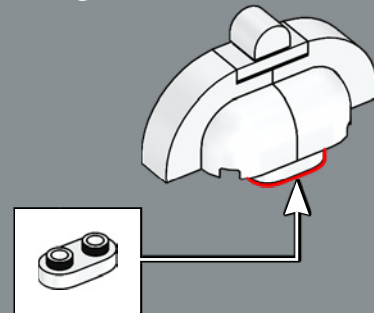

2x

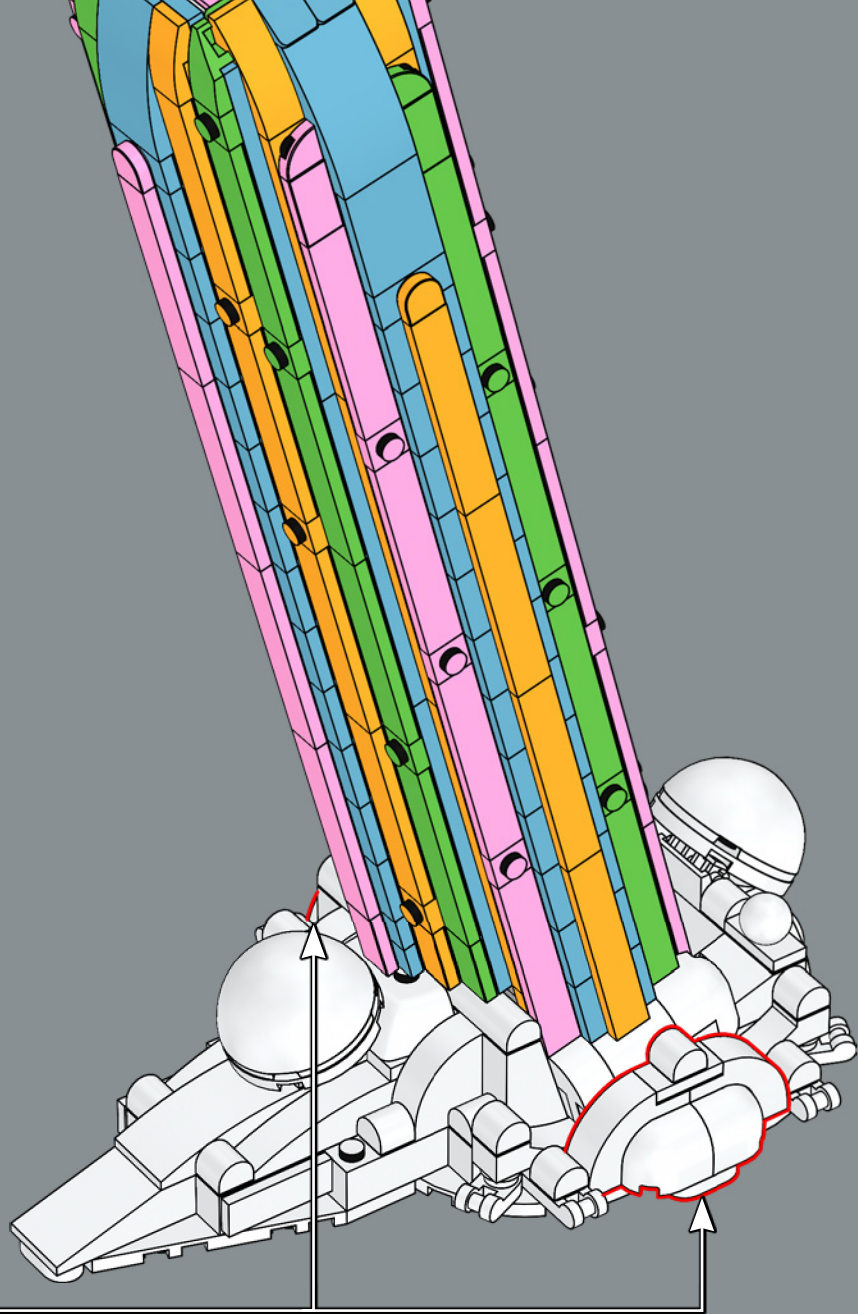

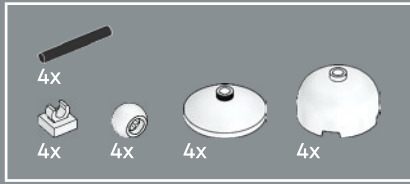

157

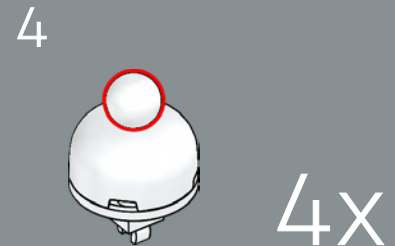
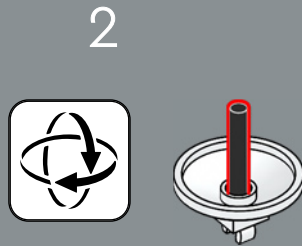
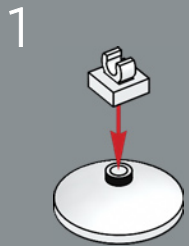

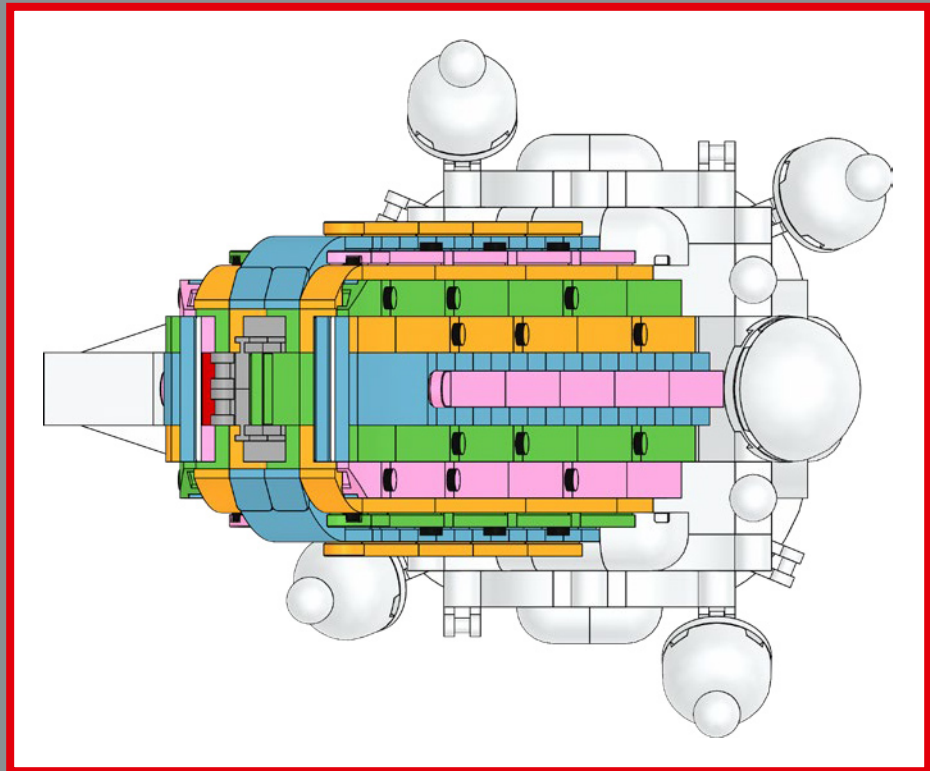
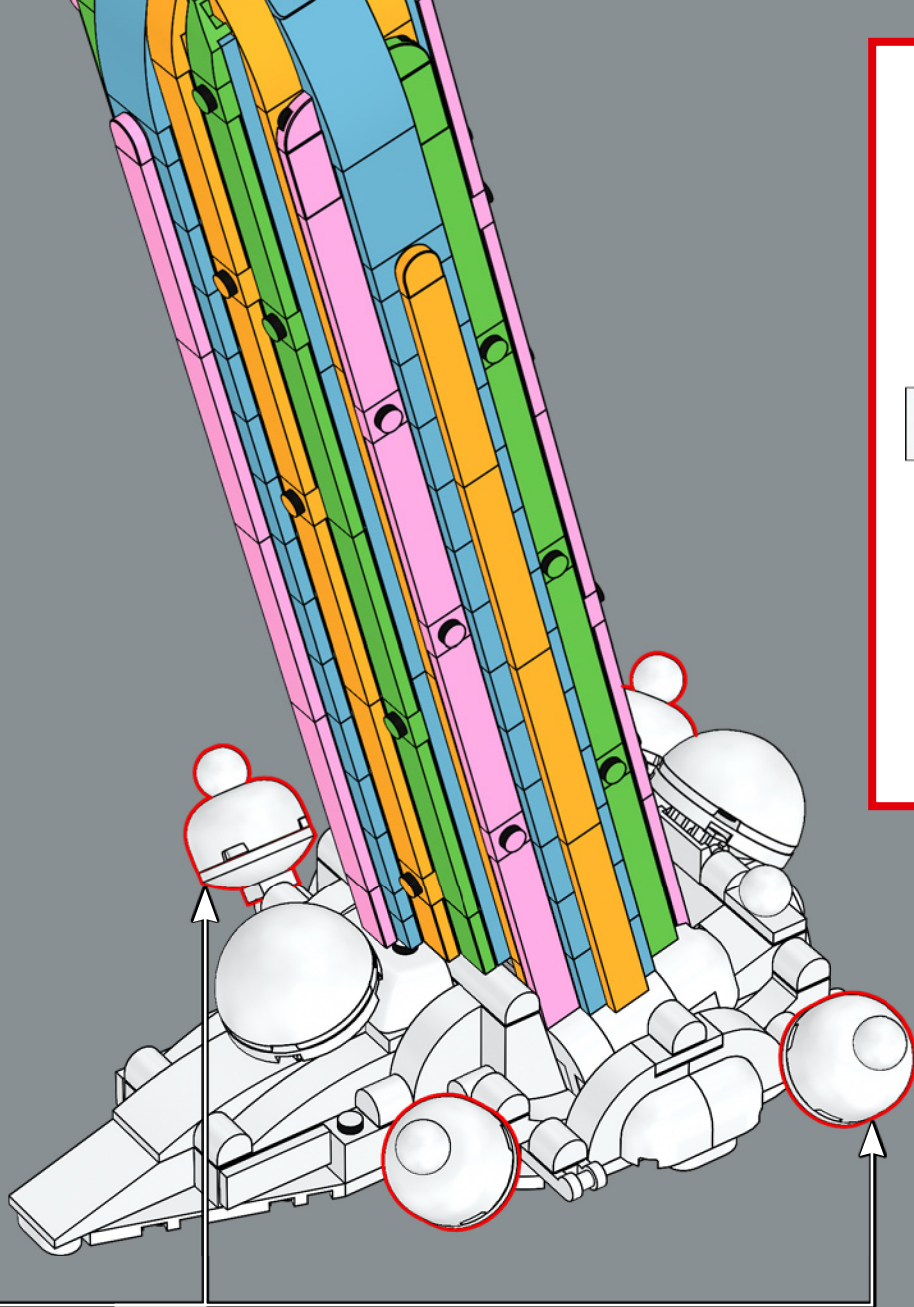

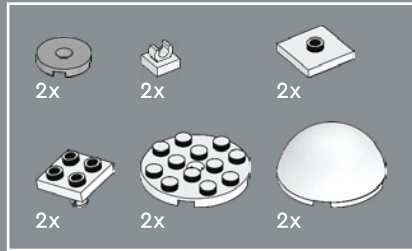

158

1



2

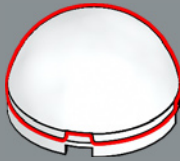

3

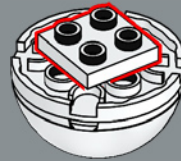

4

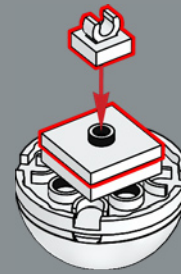

2x

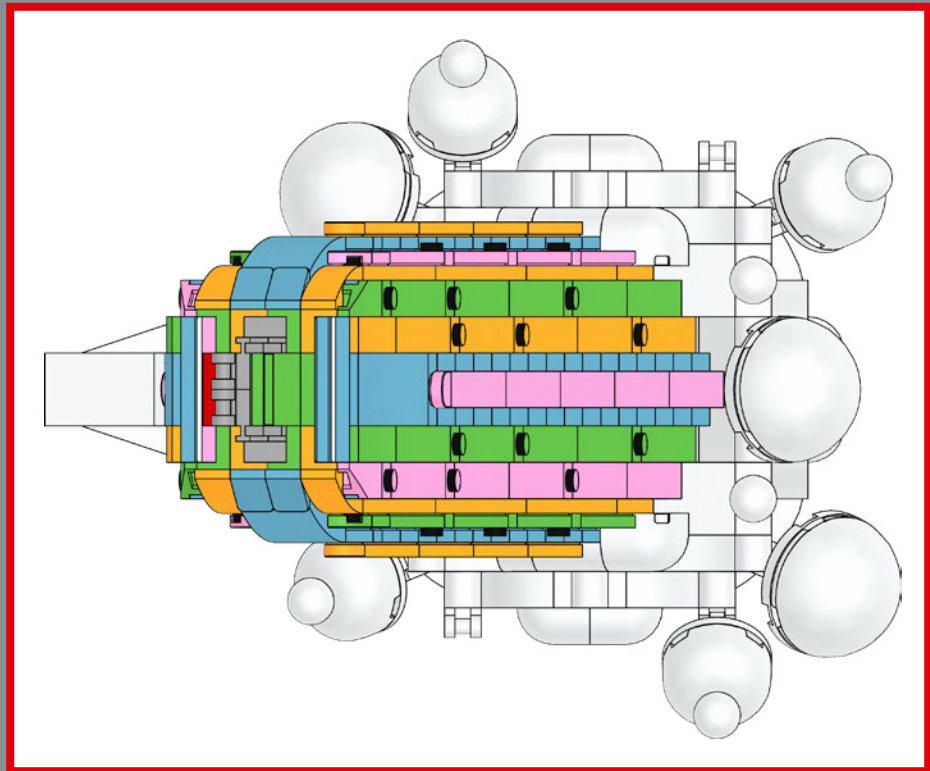

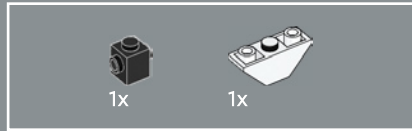
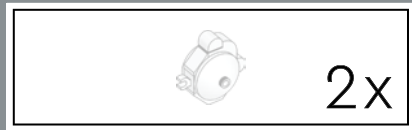

159

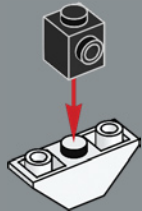

160

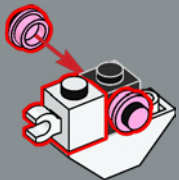

161

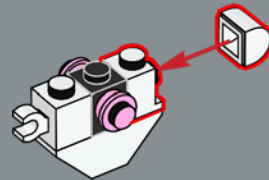

162

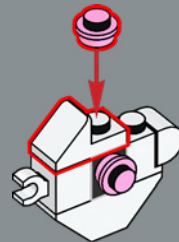

163

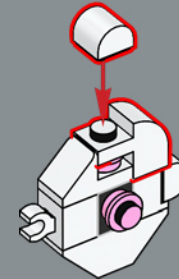

164

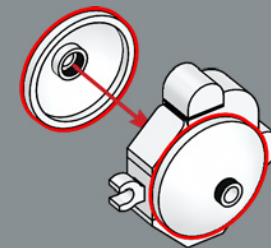

2x

165

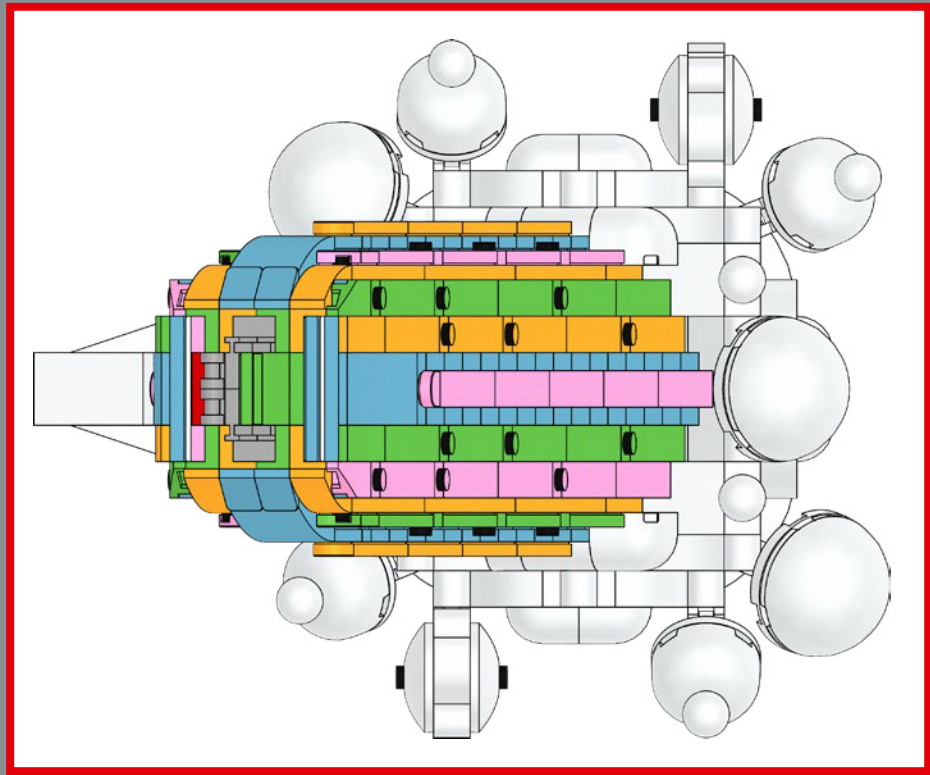
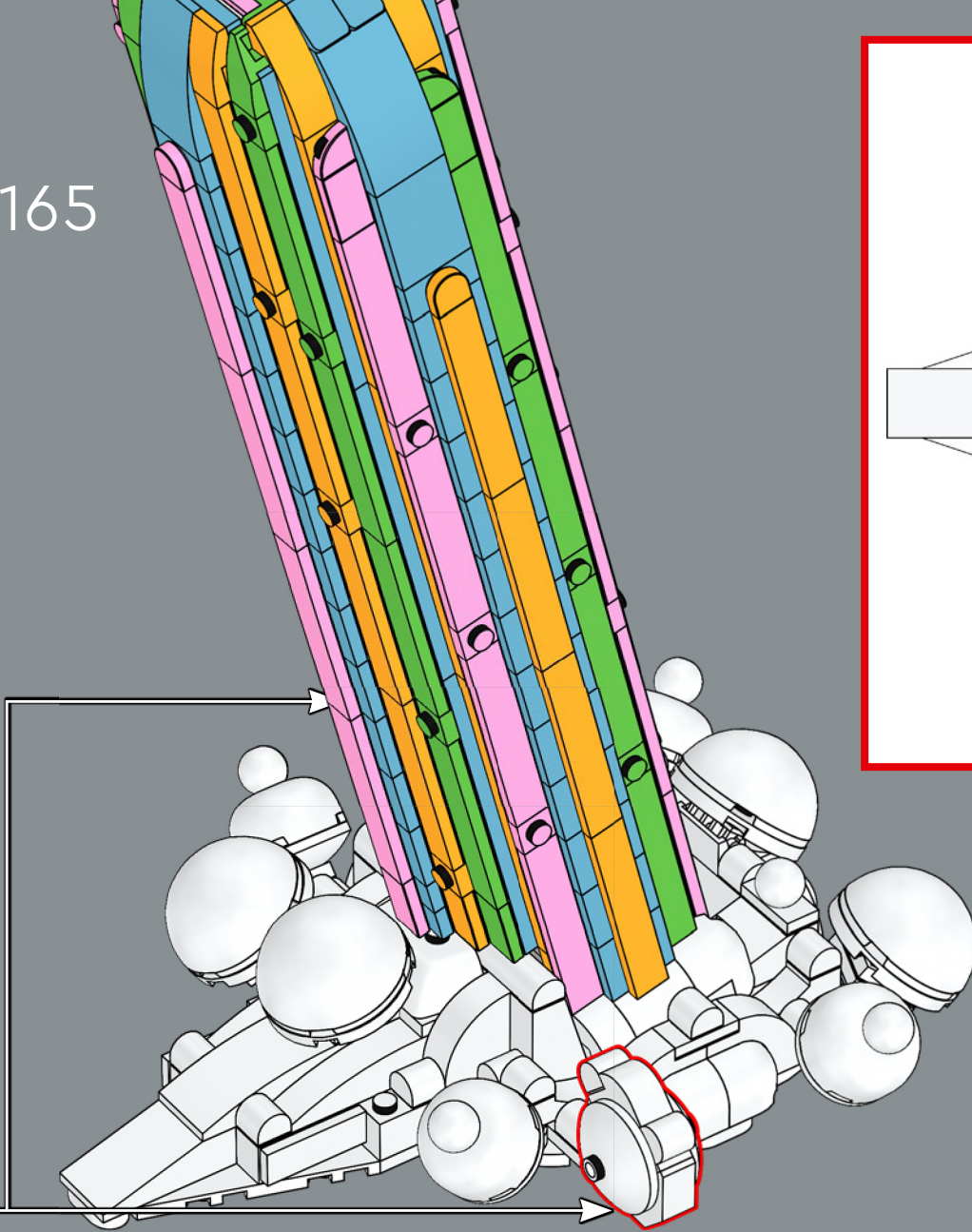

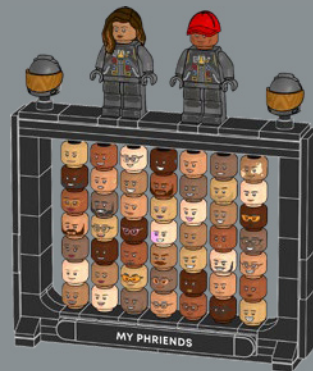
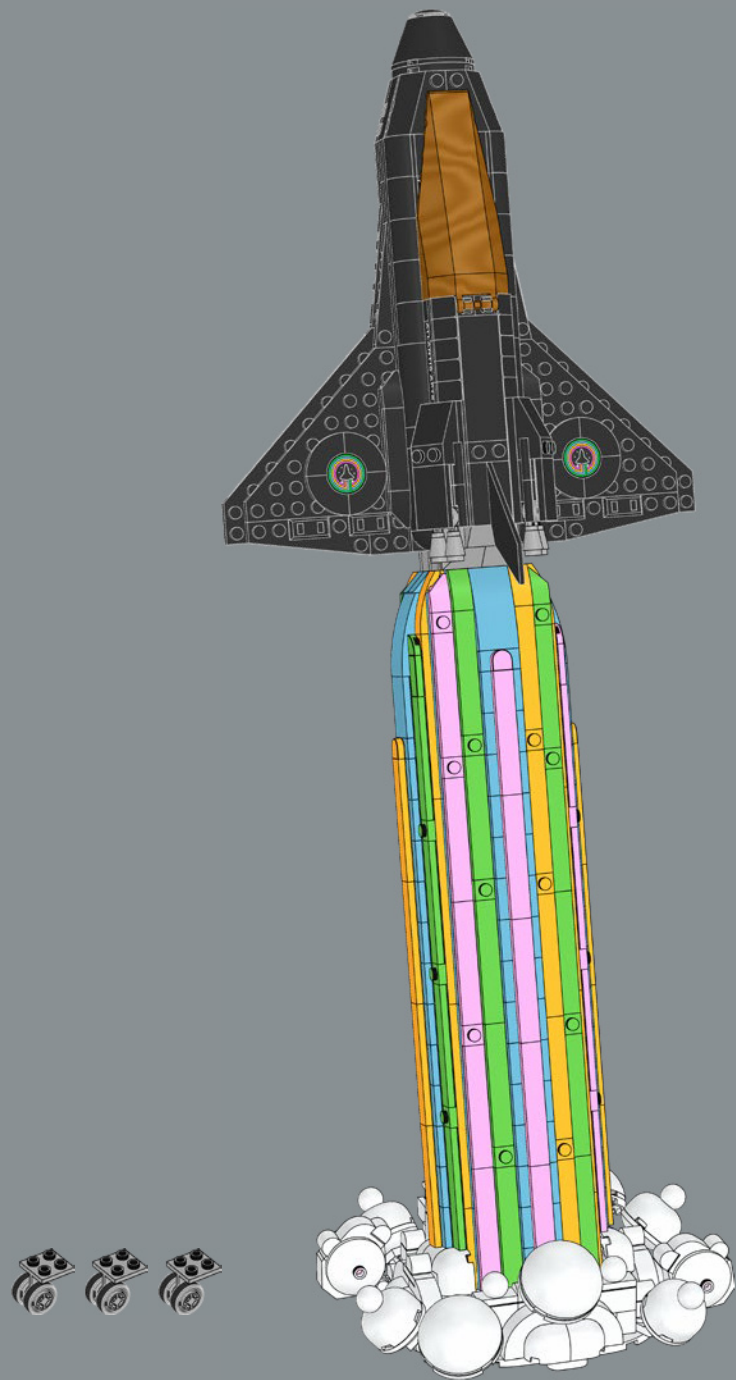

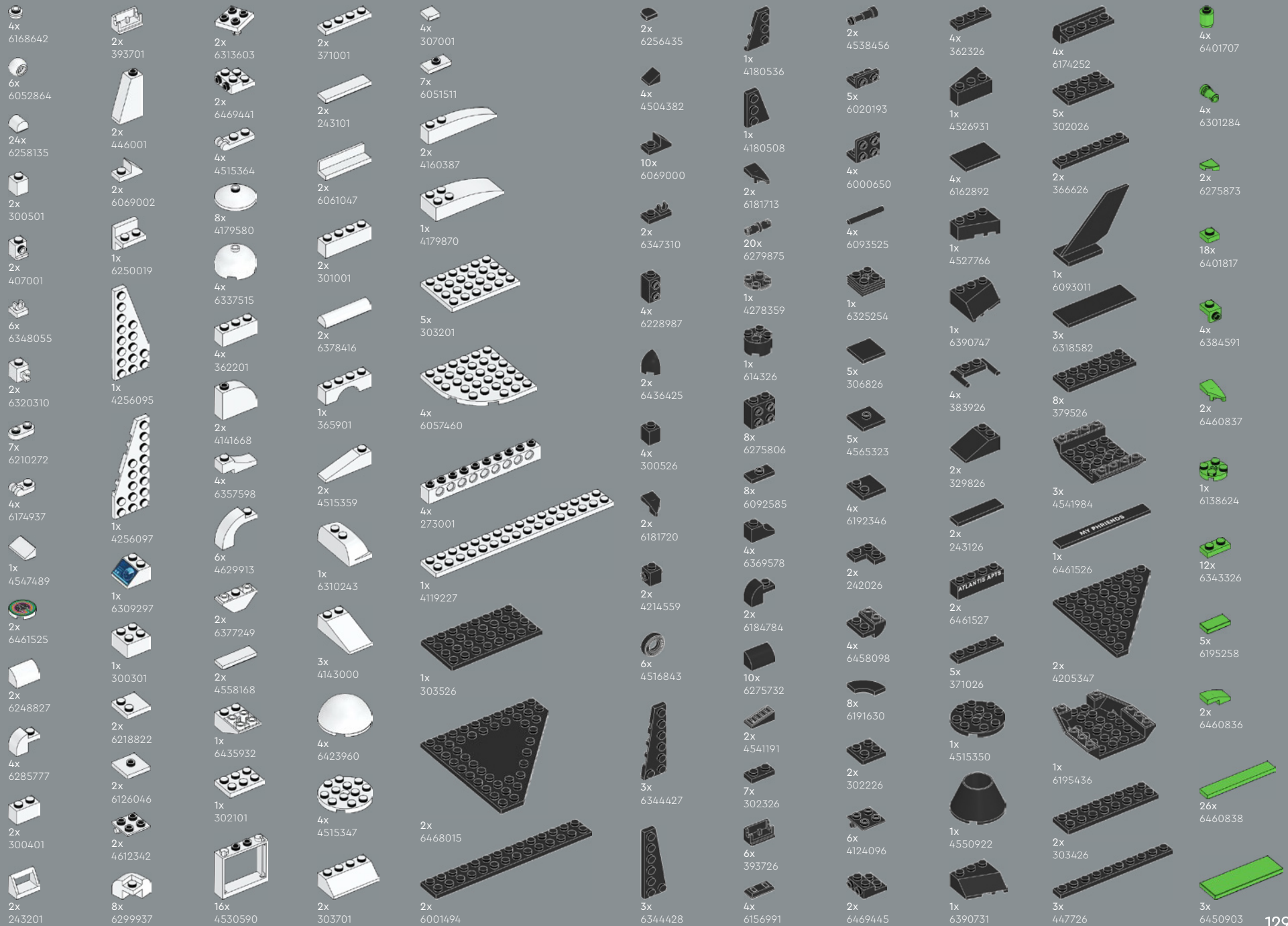

- 2x 6313554
- 6x 6073040
- 2x 6292415
- 4x 6249235
- 1x 4622062
- 2x 6099728
- 1x 6337271
- 6x 6099714
- 4x 6022064
- 17x 6365966
- 4x 6020074
- 2x 6267587
- 4x 4529241
- 6x 6194808
- 2x 6329583
- 2x 4211399
- 3x 6248890
- 4x 6227897
- 2x 6179186
- 24x 6123809
- 2x 6015344
- 2x 4211398
- 2x 6206249
- 1x 4211639
- 2x 4211393
- 3x 4243797
- 2x 6093272
- 4x 6133817
- 4x 6444094
- 1x 4211640
- 1x 4211838
- 3x 4211406
- 8x 4211462
- 2x 4211366
- 1x 4211564
- 4x 4211568
- 4x 4211349
- 3x 4211410
- 2x 4216250
- 1x 6435857
- 3x 6296797
- 2x 4515369
- 2x 6329662
- 4x 4211441
- 4x 4211613
- 1x 4211396
- 2x 4211395
- 2x 4211438
- 2x 4211713
- 12x 4517996
- 2x 6258972
- 2x 6240463
- 2x 4621554
- 12x 6031883
- 2x 6460839
- 4x 4580010
- 3x 6096589
- 6x 6002148
- 2x 6351893
- 26x 6403189
- 1x 4625633
- 1x 6461493
- 2x 6460835
- 2x 6461496
- 2x 6462355
- 1x 6109752
- 10x 4649741
- 6x 6331949
- 2x 6261638
- 8x 6344748
- 6x 6133692
- 2x 6461303
- 1x 6461280
- 4x 6188112
- 4x 6441006
- 51x 6126090
- 1x 6119126
- 1x 6060857
- 2x 6233166
- 2x 6070757
- 1x 4624705
- 4x 6441153
- 7x 4655256
- 2x 6146926
- 1x 4619515
- 1x 6447608
- 1x 6461522
- 1x 6412843
- 1x 6404026
- 1x 6461523
- 1x 6461524
- 1x 6414559
- 1x 6422563
- 1x 6461518
- 1x 6461520
- 1x 6461521
- 1x 6404031
- 1x 6461519
- 1x 6404027
- 1x 6422521
- 1x 6309258
- 1x 6461512
- 1x 6397858
- 1x 6440634
- 1x 6422511
- 1x 6461513
- 1x 6461504
- 1x 6461507
- 1x 6461497
- 1x 6461505
- 1x 6461502
- 1x 6461508
- 1x 6461506
- 1x 6461503
- 1x 6381611
- 1x 6414555
- 1x 6404021
- 1x 6345183
- 1x 6461510
- 1x 6461511
- 1x 6461509
- 1x 6403664
- 1x 6440647
- 1x 6461494
- 1x 6461517
- 1x 6404028
- 1x 6461515
- 1x 6461514
- 1x 6461516
- 1x 6461500
- 1x 6404018
- 1x 6461501
- 1x 6461499
- 1x 6461530
- 1x 6461511
- 1x 6461498
- 1x 6404015
- 2x 6378120
- 6x 6397571
- 1x 6032178
- 1x 379521
- 1x 6240515

7

5



[LEGO.com/service](https://www.LEGO.com/service)



YOU COULD WIN



YOU COULD WIN

Your feedback will help shape the future development of this product series.

Visit:

DU KÖNNTEST GEWINNEN

Dein Feedback trägt zur Weiterentwicklung dieser Produktreihe bei.

Geh auf:

VOUS POURRIEZ GAGNER

Vos commentaires nous aideront à concevoir les futurs produits de cette gamme.

Visitez :

POTRESTI VINCERE TU

La tua opinione ci aiuterà a migliorare la creazione futura di questa linea di prodotti.

Visita:

PUEDES GANAR

Tu opinión contribuirá al futuro de esta serie de productos.

Visita:

轻松获奖

您的反馈将有助于我们在今后改进本产品系列。

请访问:

[LEGO.com/productfeedback](https://www.lego.com/productfeedback)

You also have the chance to win a LEGO® set.

Terms and conditions apply.*

Außerdem hast du die Chance, ein LEGO® Set zu gewinnen.

Es gelten die Teilnahmebedingungen.*

Vous pourriez également gagner un ensemble LEGO®.

Des conditions s'appliquent.*

Hai anche la possibilità di vincere un set LEGO®.

Termini e condizioni sono applicabili.*

También tienes la oportunidad de ganar un set LEGO®.

Aplican términos y condiciones.*

您还有机会赢取乐高®套装。

条款和条件适用。*

*[LEGO.com/productfeedback-terms](https://www.lego.com/productfeedback-terms)



LEGO and the LEGO logo are trademarks of the/sont des marques de commerce du/son marcas registradas de LEGO Group.
©2024 The LEGO Group. 6533948

The image and name of Pharrell Williams are used with permission. All rights reserved.