



# STAR WARS™

75392



1



LEGO® Builder



[LEGO.com/sustainable-packaging](https://LEGO.com/sustainable-packaging)



 <sup>FR</sup> **DONNEZ**  
OU  
**RECYCLEZ**

 OU  OU 

ASSOCIATION MAGASIN DÉCHÈTERIE

Adresses sur [quefairedemesdechets.fr](https://quefairedemesdechets.fr)

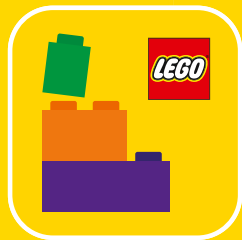

# BUILDER



Apple and the Apple logo are trademarks of Apple Inc., registered in the U.S. and other countries and regions. App Store is a service mark of Apple Inc. Google Play and the Google Play logo are trademarks of Google LLC. Tencent and the Tencent logo are trademarks of Tencent Inc.

Q [LEGO.com/devicecheck](https://LEGO.com/devicecheck)

EN Ask parents' permission before going online | DE Eltern um Erlaubnis bitten, bevor du online gehst | FR Demande l'autorisation d'un parent avant d'aller en ligne | IT Chiedi il permesso ai tuoi genitori prima di andare online | ES Pídeles permiso a tus papás antes de conectarte a Internet | PT Pede autorização aos pais antes de acederes online | ZH 上网前应先征得父母的同意 | PL Poproś rodziców o zgodę, zanim wejdziesz do Internetu | CS Než půjdeš na internet, požádej rodiče o svolení | SK Skôr než pôjdeš na internet, vypýtaj si povolenie od rodičov | HU Kérj szülői engedélyt, mielőtt online csatlakoznál! | RO Cere permisiunea părinților înainte de a te conecta online | BG Поискайте разрешение от родител, преди да влезете онлайн | LV Pirms došanās tiešsaistē palūdz atļauju vecākiem | ET Enne Interneti kasutamist küsi vanematelt luba | LT Prieš prisijungdami prie interneto, atsiklauskite tėvų



# STAR WARS™



## Join the 25<sup>th</sup> Anniversary at [LEGO.com/SW-25](http://LEGO.com/SW-25)

Join the 25<sup>th</sup> Anniversary at [LEGO.com/SW-25](http://LEGO.com/SW-25)  
 Feiere mit uns das 25-jährige Jubiläum auf [LEGO.com/SW-25](http://LEGO.com/SW-25)  
 Venez célébrer notre 25<sup>e</sup> anniversaire sur [LEGO.com/SW-25](http://LEGO.com/SW-25)  
 Festeggia con noi il 25<sup>o</sup> anniversario su [LEGO.it/SW-25](http://LEGO.it/SW-25)  
 ParticIPA en el 25 aniversario en [LEGO.com/SW-25](http://LEGO.com/SW-25)  
 Junte-se ao 25.º Aniversário em [LEGO.com/SW-25](http://LEGO.com/SW-25)  
 访问 [LEGO.com/SW-25](http://LEGO.com/SW-25), 参加 25 周年庆典  
 Świątuj z nami 25. rocznicę na stronie [LEGO.pl/SW-25](http://LEGO.pl/SW-25)  
 Oslavte s námi 25. výročí na [LEGO.com/SW-25](http://LEGO.com/SW-25)  
 Oslávte s nami 25. výročie na [LEGO.com/SW-25](http://LEGO.com/SW-25)  
 Csatlakozz a 25. évfordulóhoz a [LEGO.hu/SW-25](http://LEGO.hu/SW-25) oldalon!  
 Alătură-te celei de-a 25-a aniversării pe [LEGO.com/SW-25](http://LEGO.com/SW-25)  
 Присъединете се към 25тата годишнина на [LEGO.com/SW-25](http://LEGO.com/SW-25)  
 Pievienojies 25. jubilejai vietnē [LEGO.com/SW-25](http://LEGO.com/SW-25)  
 Liitu 25.th aastapäevaga aadressil [LEGO.com/SW-25](http://LEGO.com/SW-25)  
 Śwęskime 25-ąją sukątj drauge svetainėje [LEGO.com/SW-25](http://LEGO.com/SW-25)

25 years of LEGO® Star Wars™  
 25 Jahre LEGO® Star Wars™  
 25 ans de LEGO® Star Wars™  
 25 anni di LEGO® Star Wars™  
 25 años de LEGO® Star Wars™  
 25 anos de LEGO® Star Wars™

乐高® 星球大战™ 25 周年  
 25 lat LEGO® Star Wars™  
 25 let LEGO® Star Wars™  
 25 rokov LEGO® Star Wars™  
 25 évnyi LEGO® Star Wars™

25 de ani de LEGO® Star Wars™  
 25 години LEGO® Star Wars™  
 LEGO® Star Wars™ 25 gadi  
 25 aastat LEGO® Star Wars™  
 25 metai LEGO® Star Wars™

© & ™ Lucasfilm Ltd.



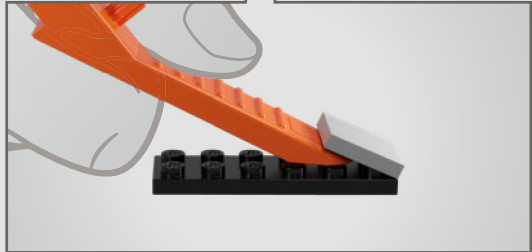
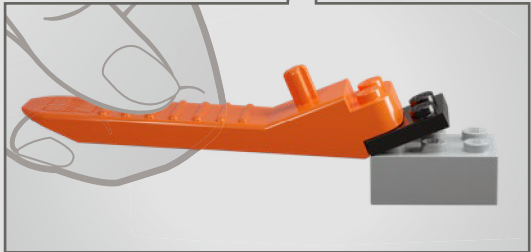
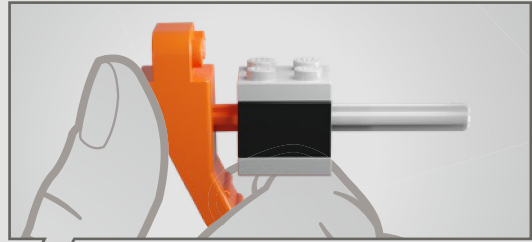
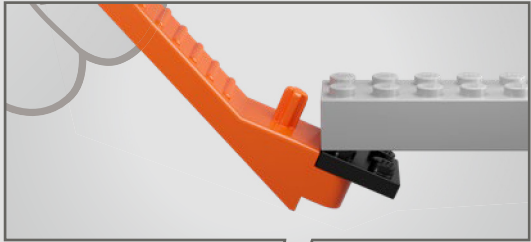

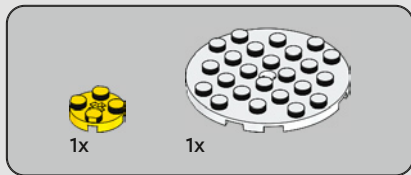

1

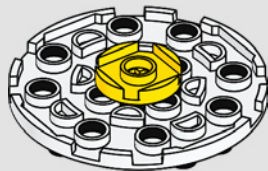

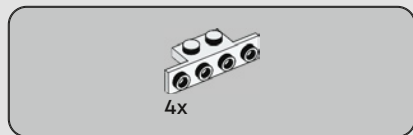

2

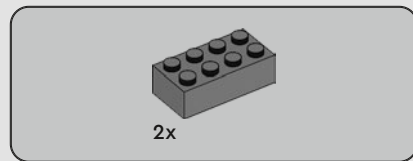
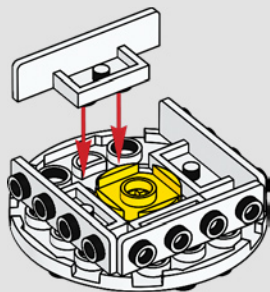

3

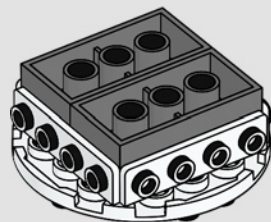



6x

4

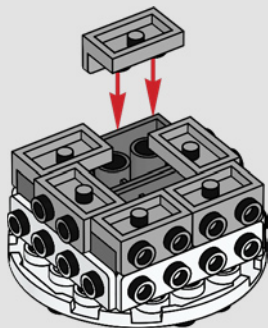

8

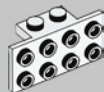

2x

5

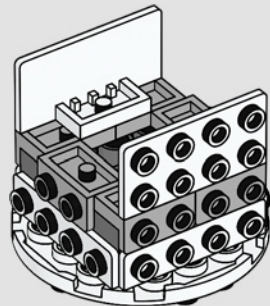



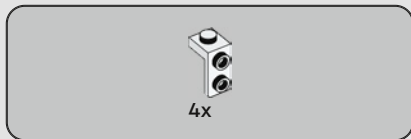

6

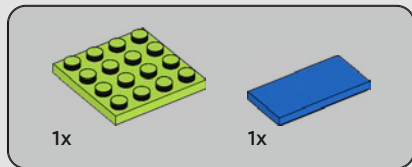
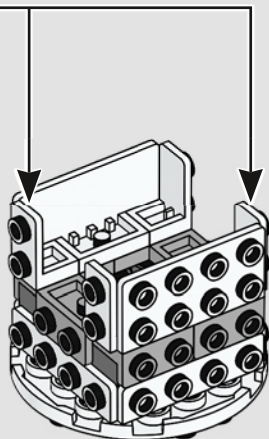
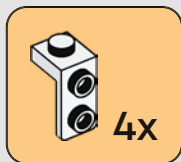

7

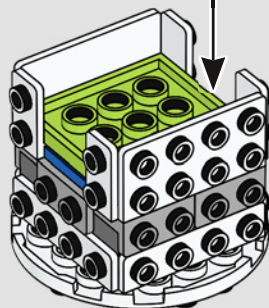
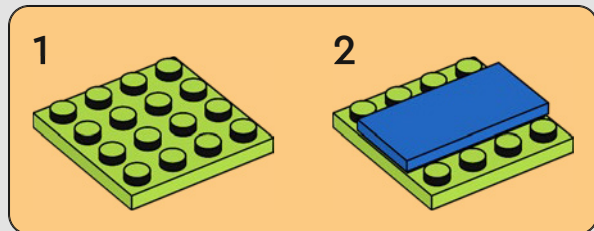

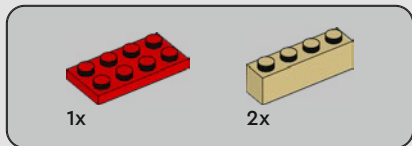

8

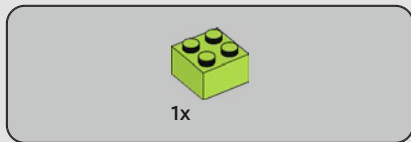
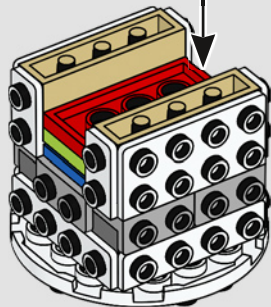
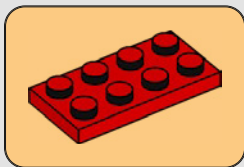

9

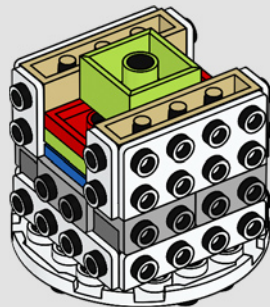

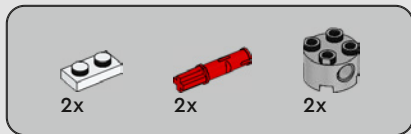

10

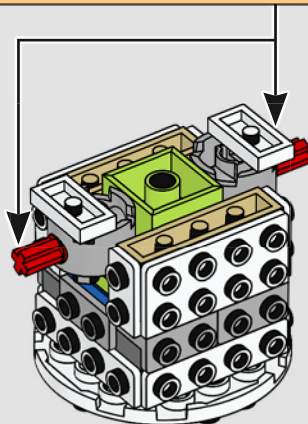
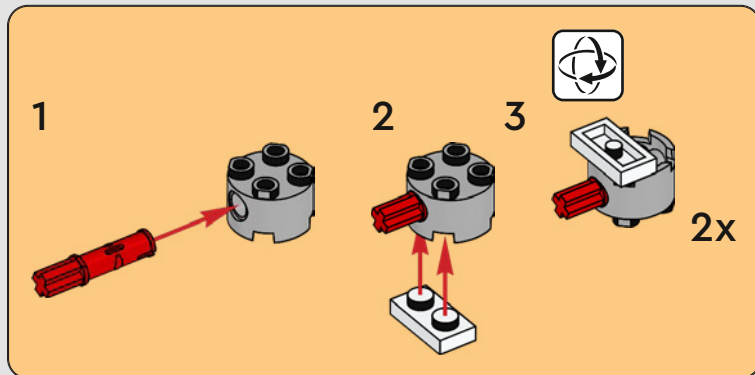



4x

11

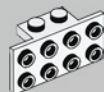
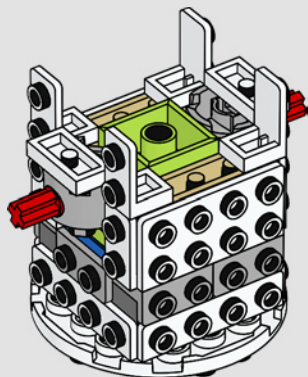

2x

12

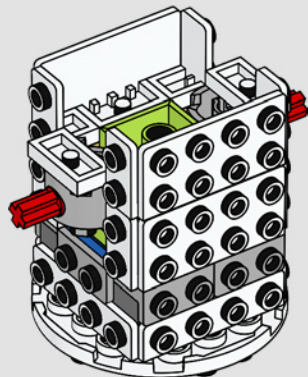

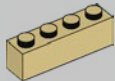

1x

13

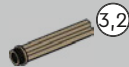
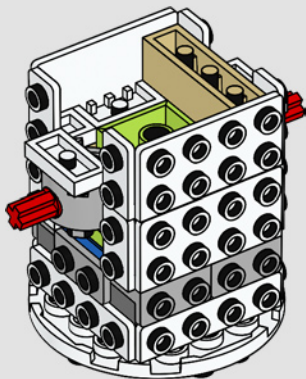

1x

14

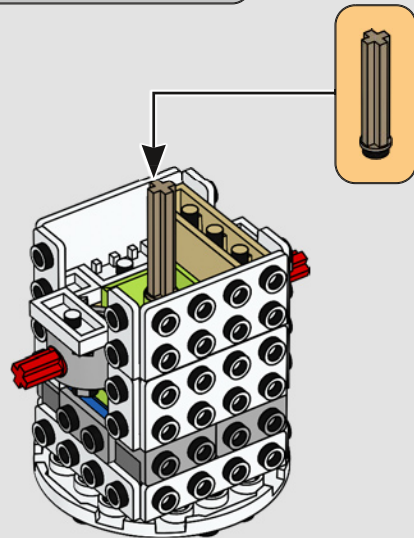

3,2

1:1

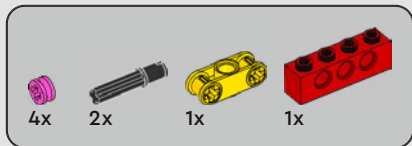

15

1

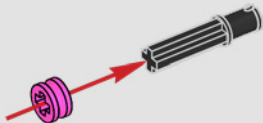

2

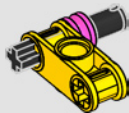

3

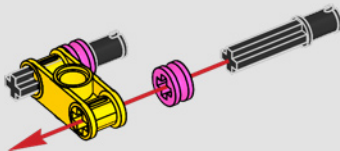

4

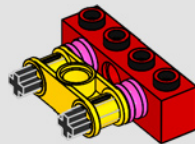

5

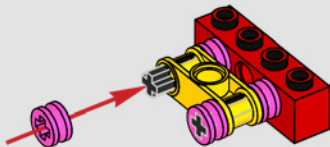

6

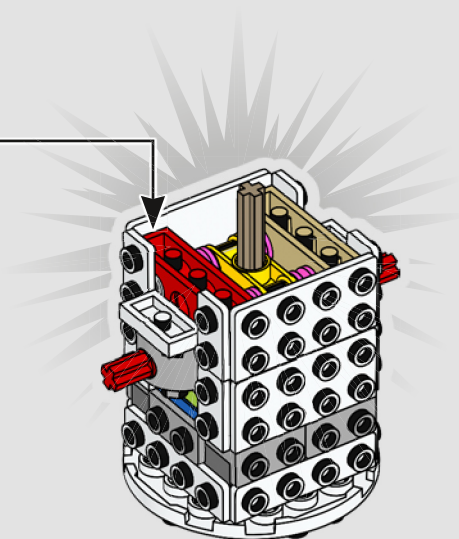
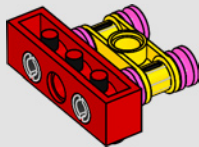

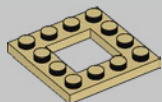

1x

16

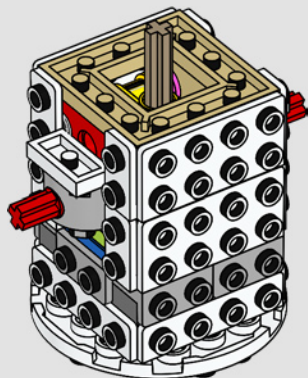

1x

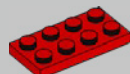

1x

17

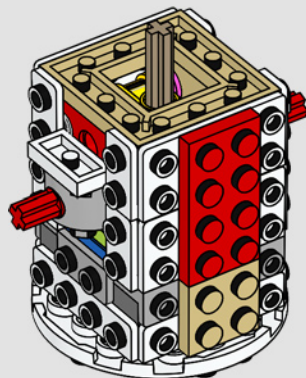



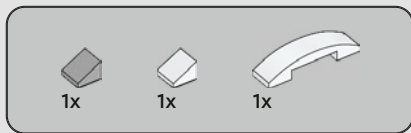

18

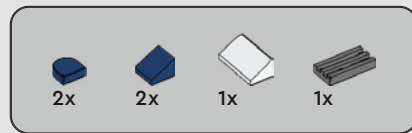
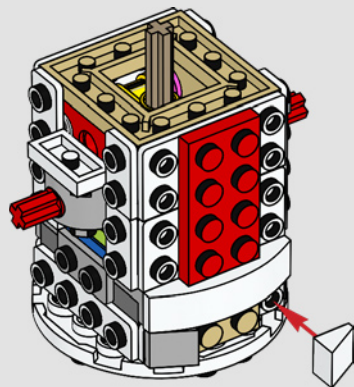

19

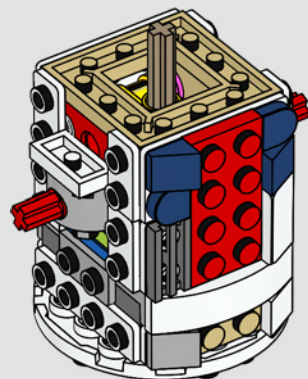

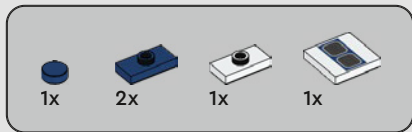

20

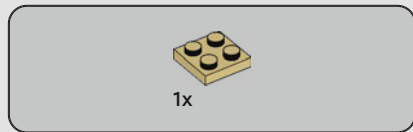
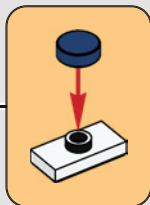
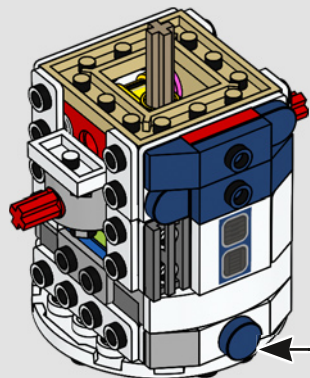

21

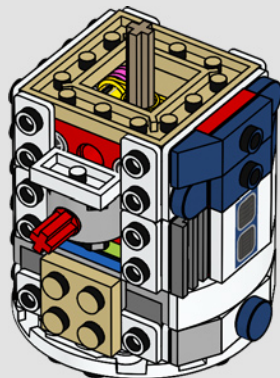



2x



4x

# 22

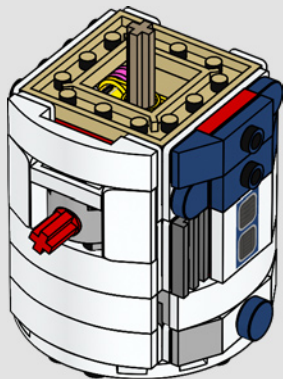

1x

# 23

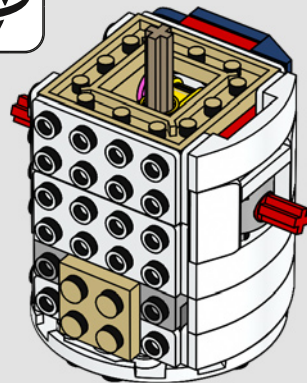

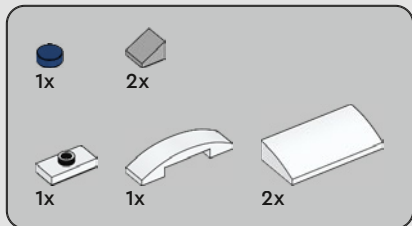

24

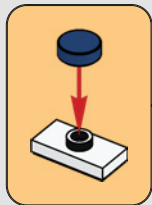
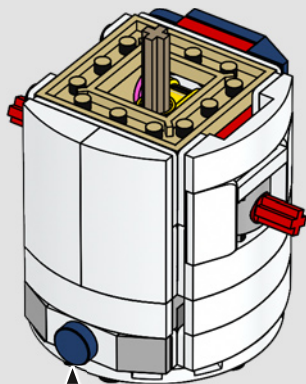

20

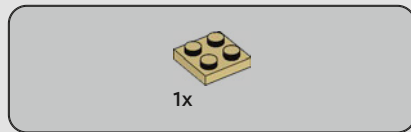

25

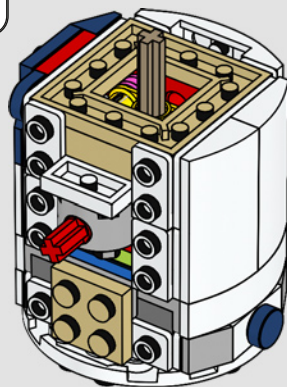



2x



4x

26

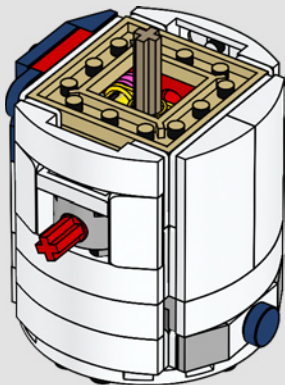

4x



1x

27

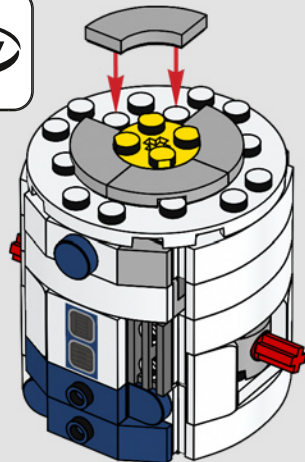

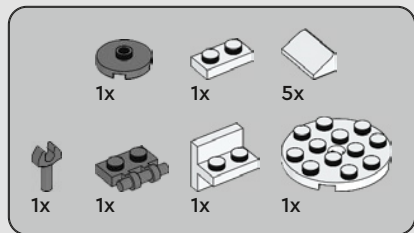

# 28

1



2

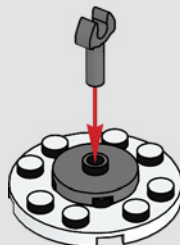

3

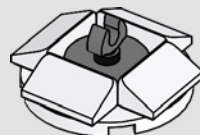

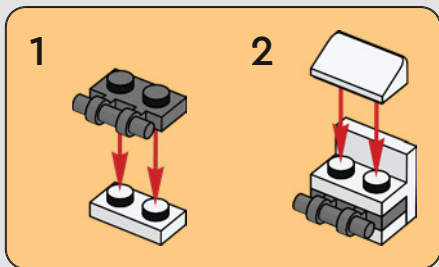

4

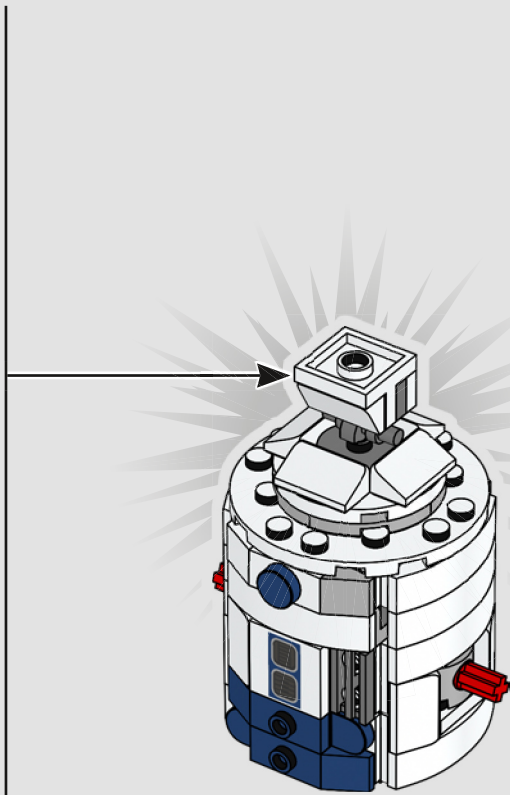
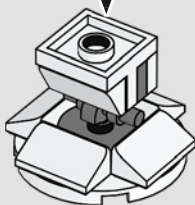





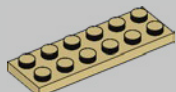

1x

30

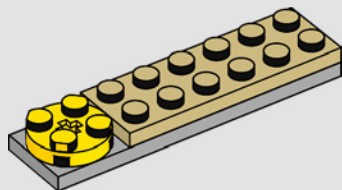

1x

31

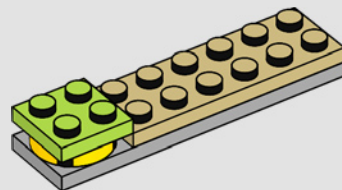

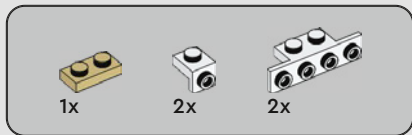

32

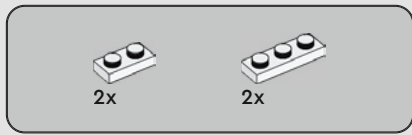
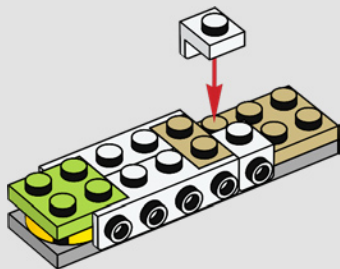

33

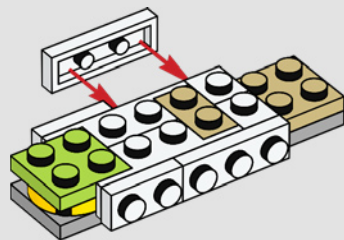



34

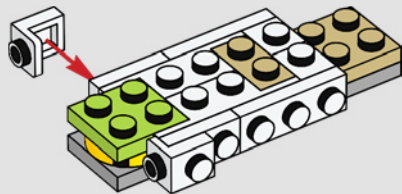

35

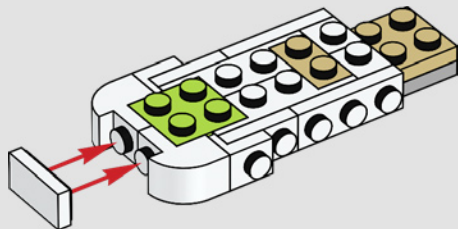

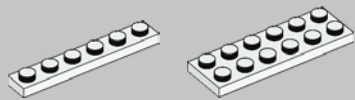
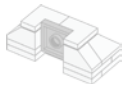

1x

1x

36

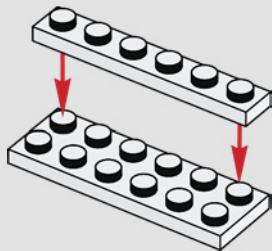

1x



2x

37

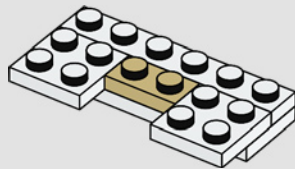



2x

38

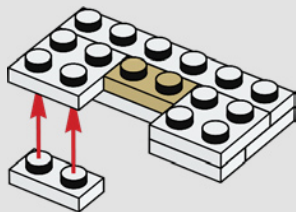

2x

39

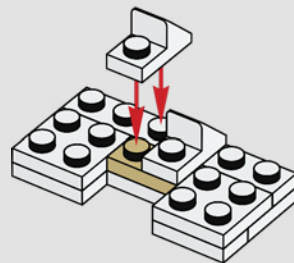

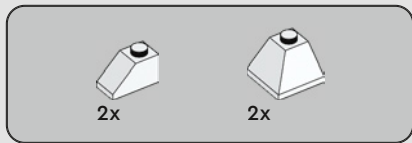

40

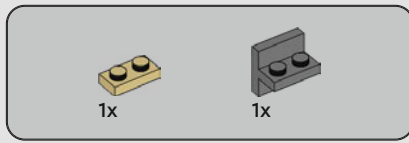
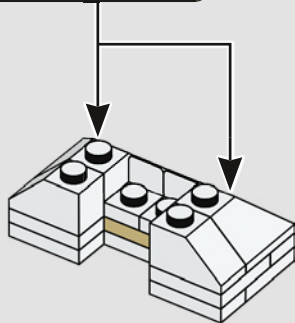
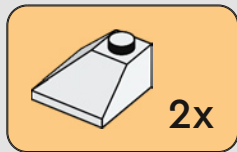

41

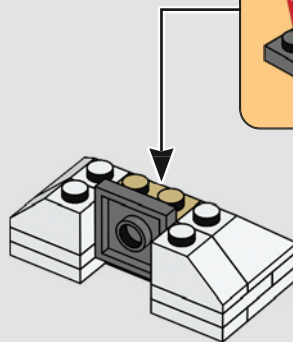
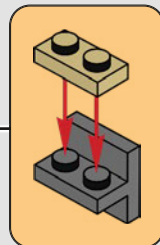



2x

42

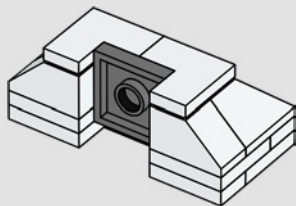

43

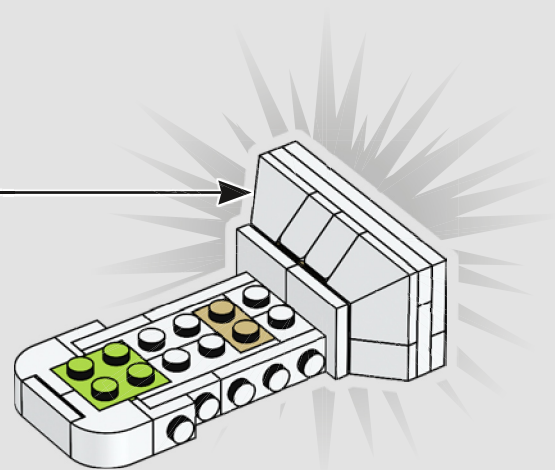

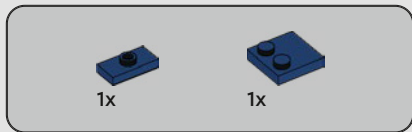

44

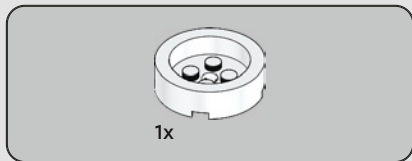
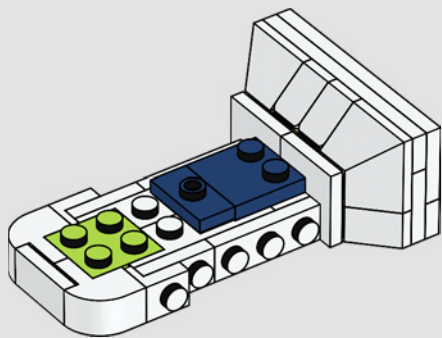

45

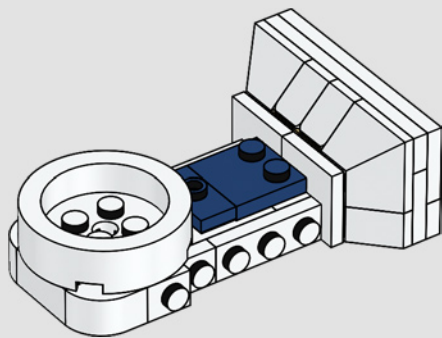



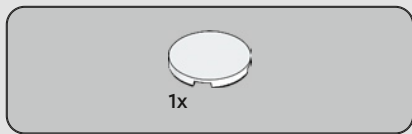

46

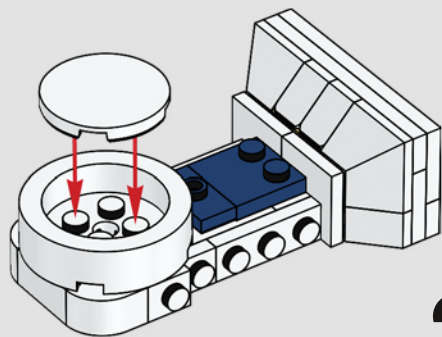

2x

47

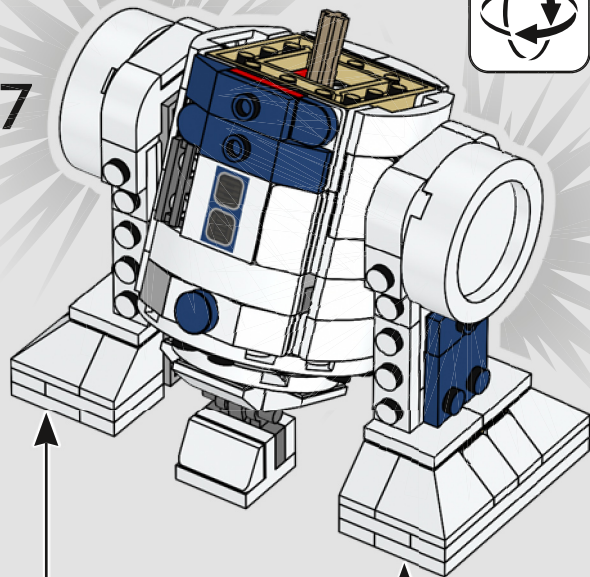

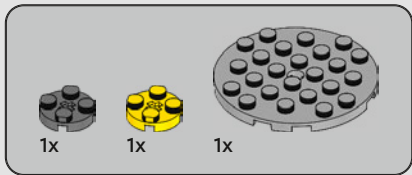

48

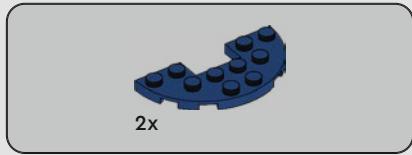
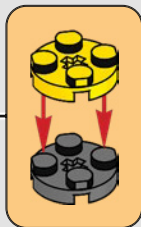
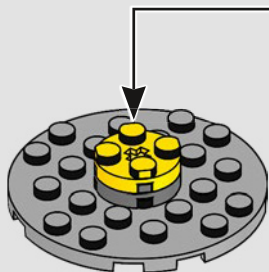

49



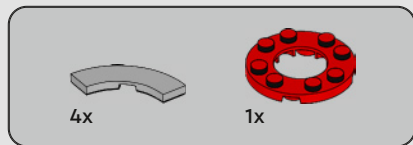

50

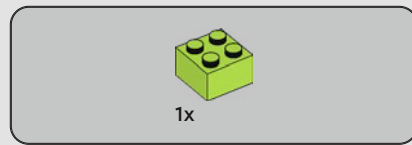
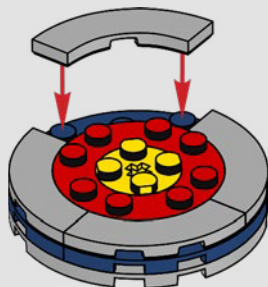

51

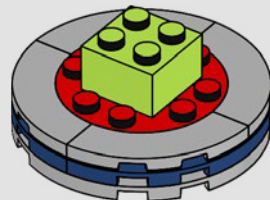

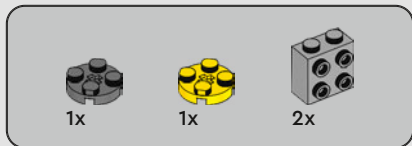

52

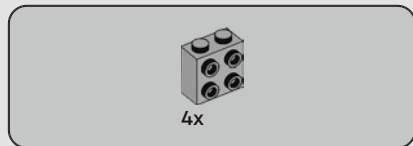
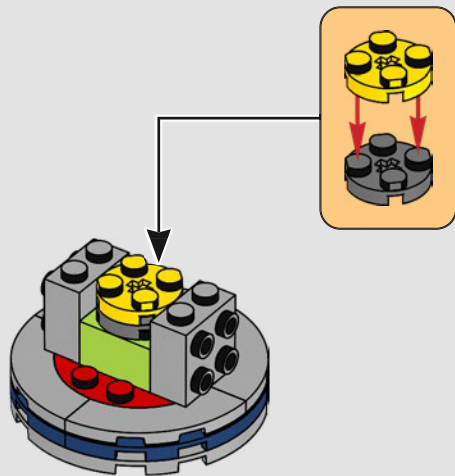

53

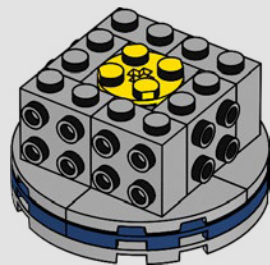

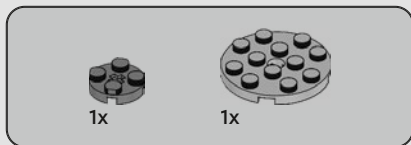

54

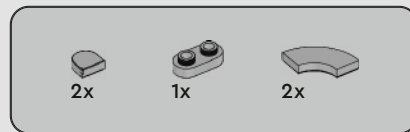
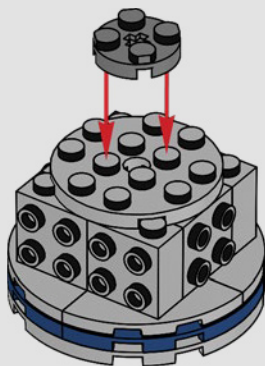

55

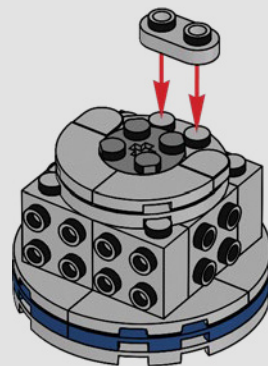



1x

56

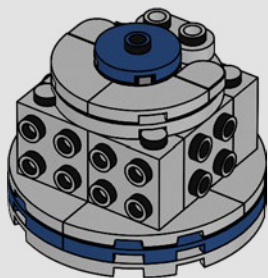

2x



1x



1x



1x

57

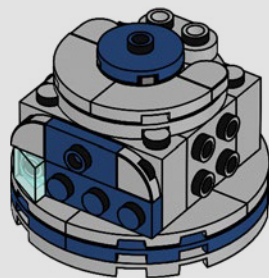



1x



1x



1x

# 58

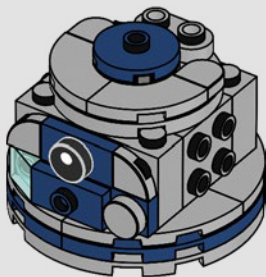

2x



1x

# 59

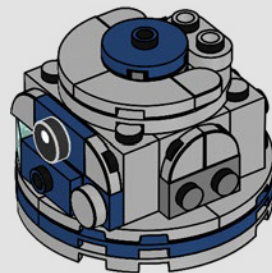



1x



1x

60

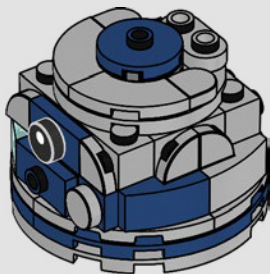

2x



1x



1x

61

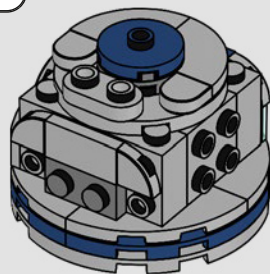





1x



1x



1x

# 62

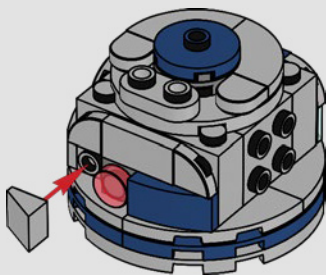

2x



1x

# 63

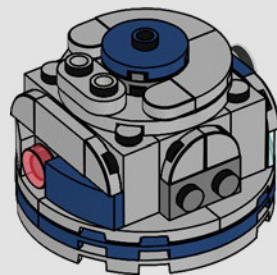



2x

64

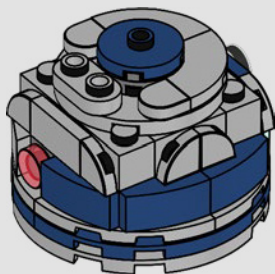

65

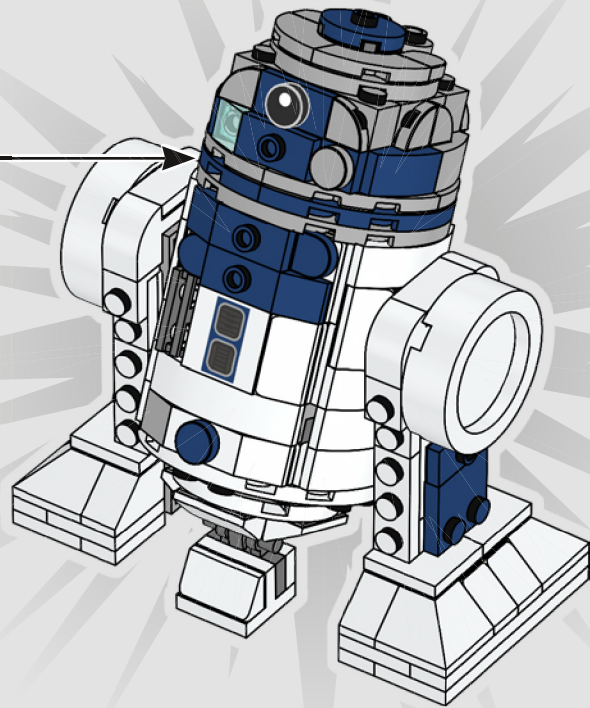



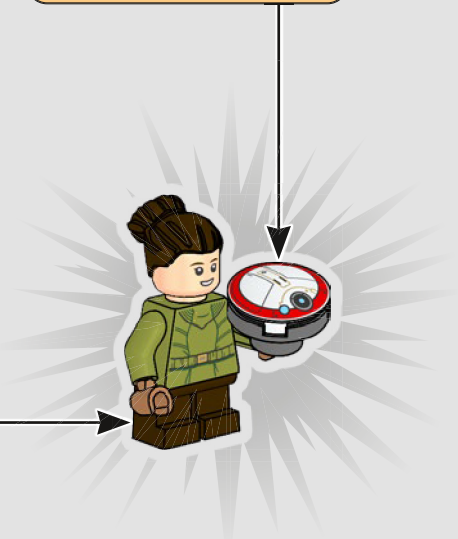
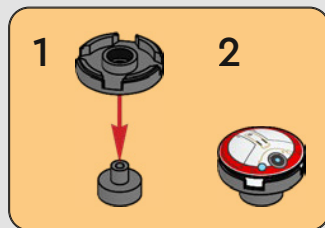
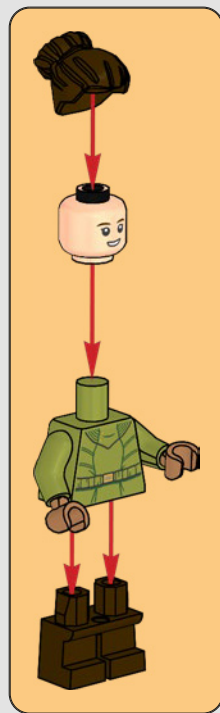

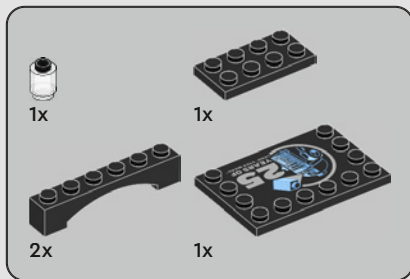

1

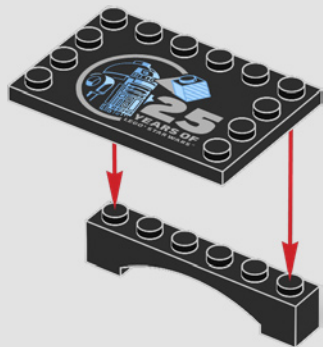

2

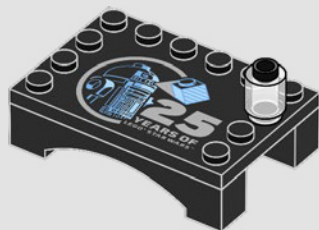





2x



2x



2x



2x



2x



2x



2x



2x

66

1

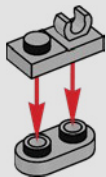

2

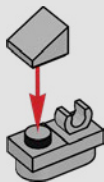

3

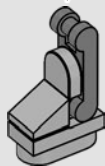

4

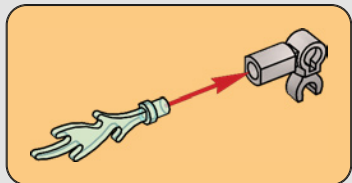
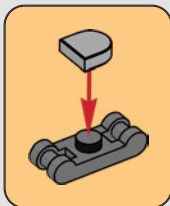
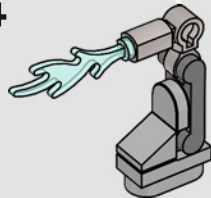



5

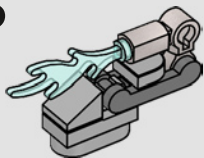

2x

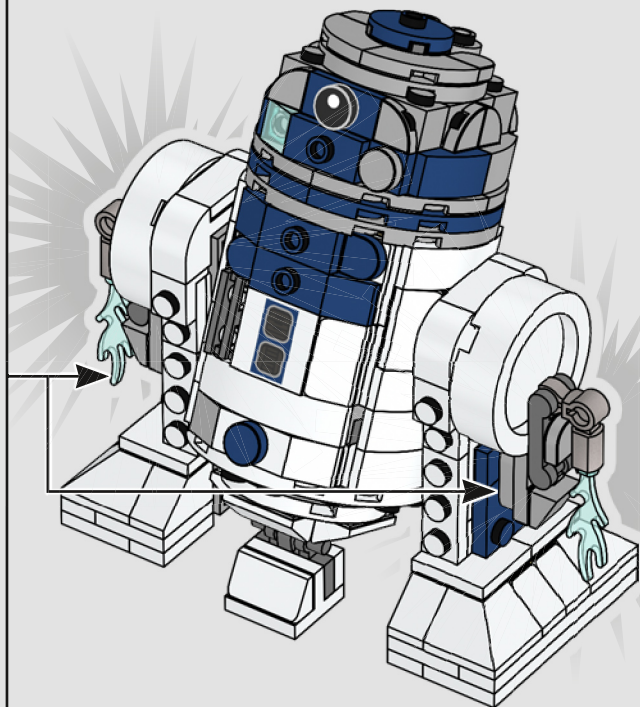

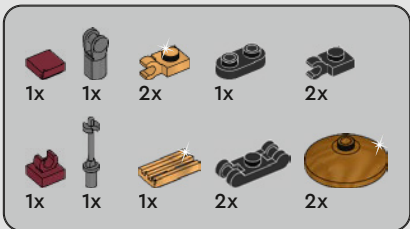
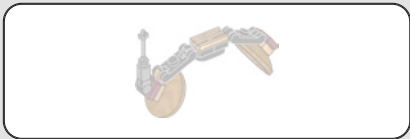

67

1



2

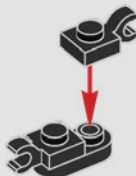

3



4

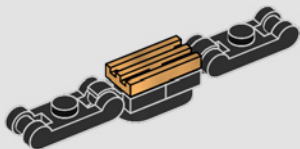

5

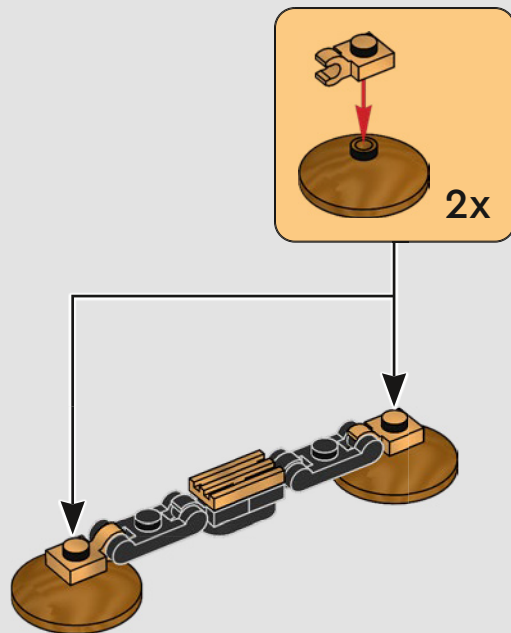

6

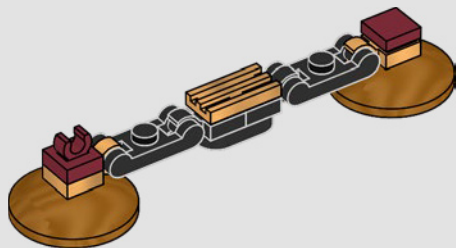

7

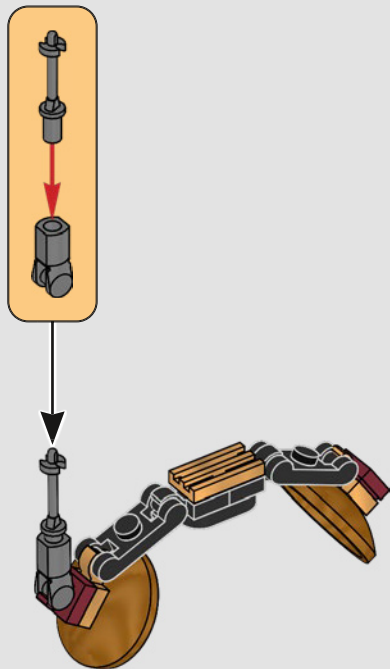

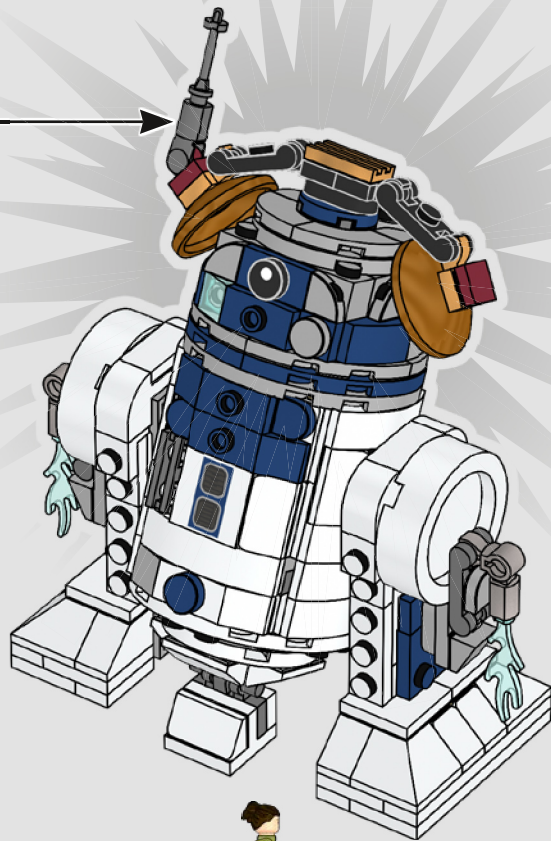

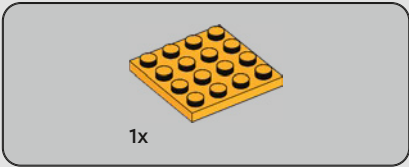
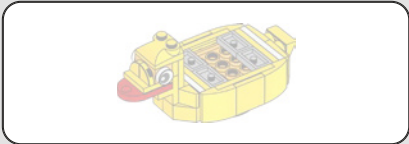

68

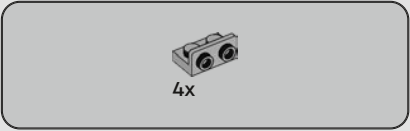
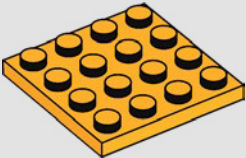

69

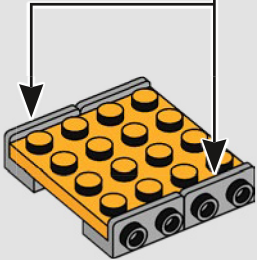

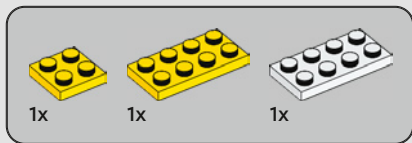

70

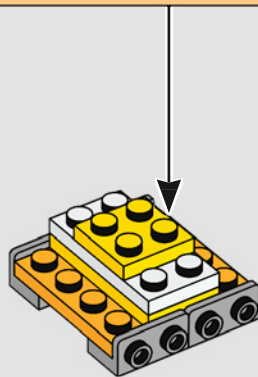
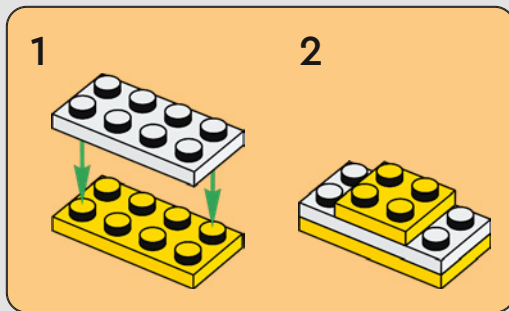

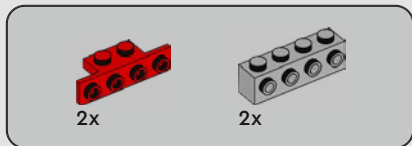

71

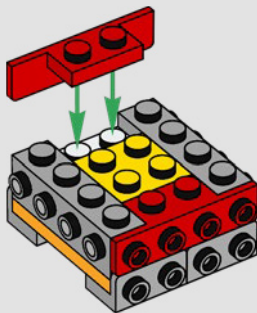



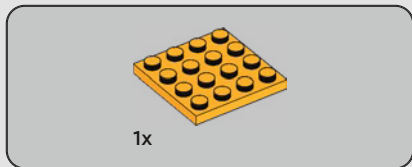

72

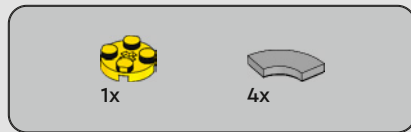
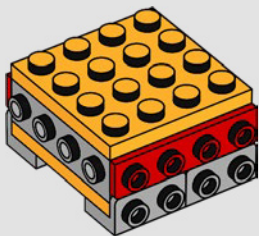

73

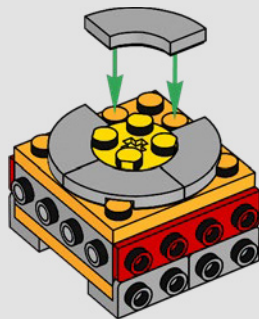

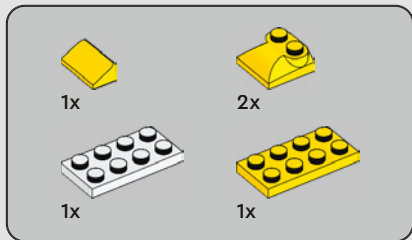

74

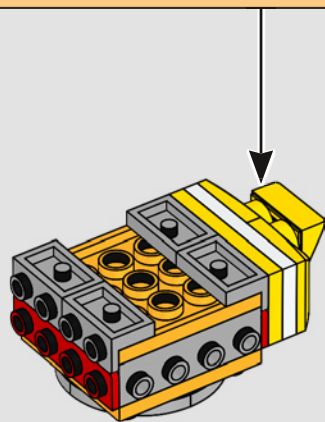



1x



1x

# 75

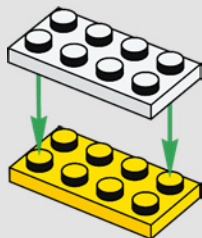

2x



1x

# 76

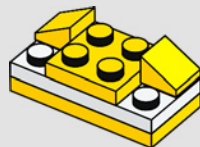



1x

77

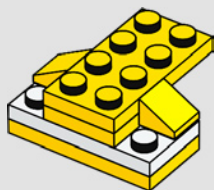

2x

78

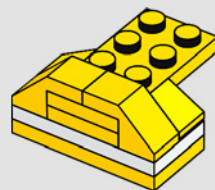

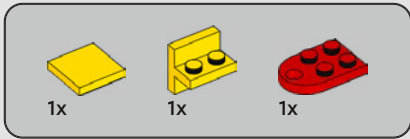

79

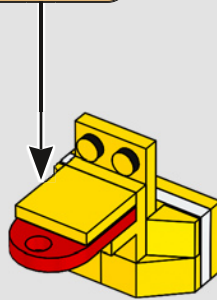
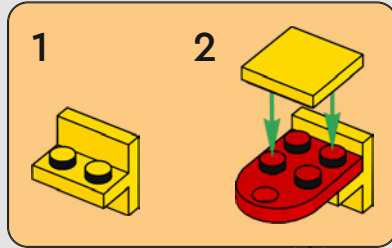



80

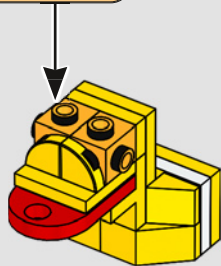
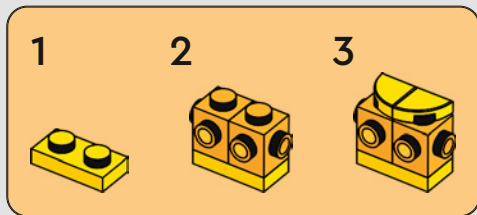



2x



1x

81

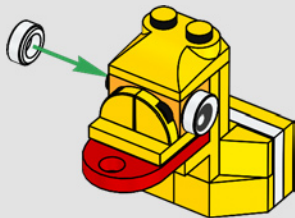

82

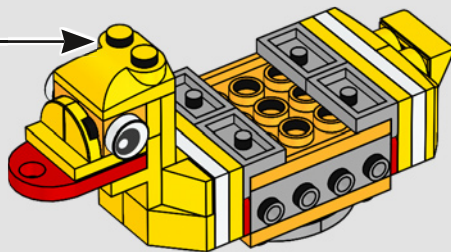

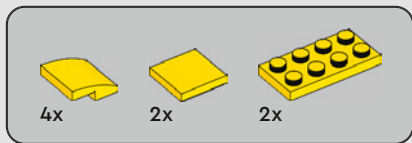

# 83

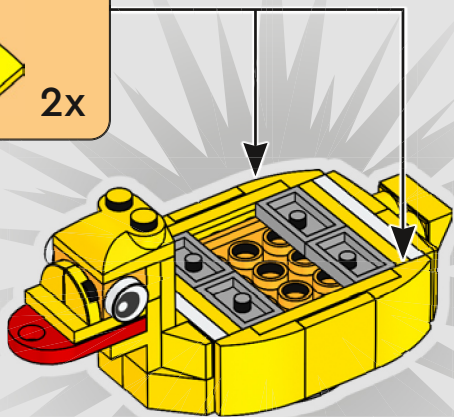
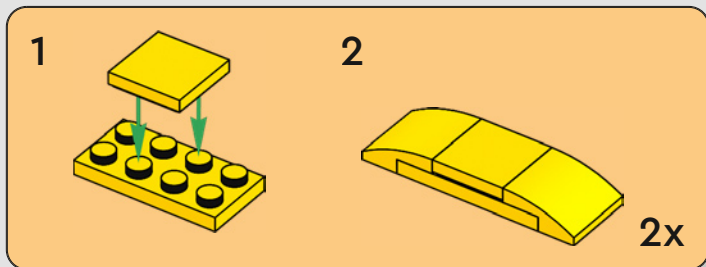



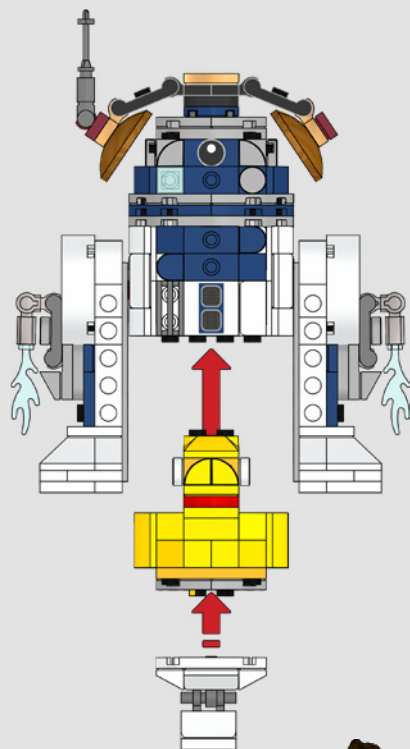
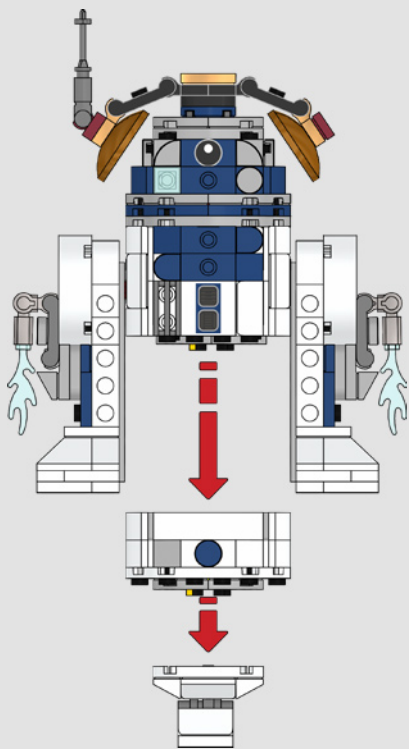

84

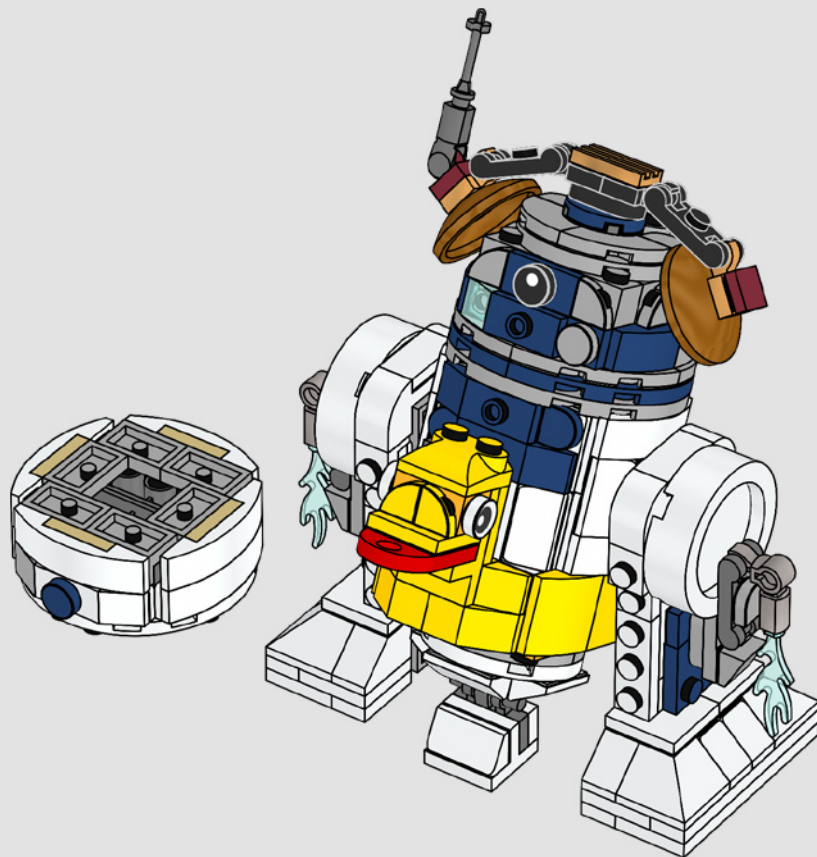

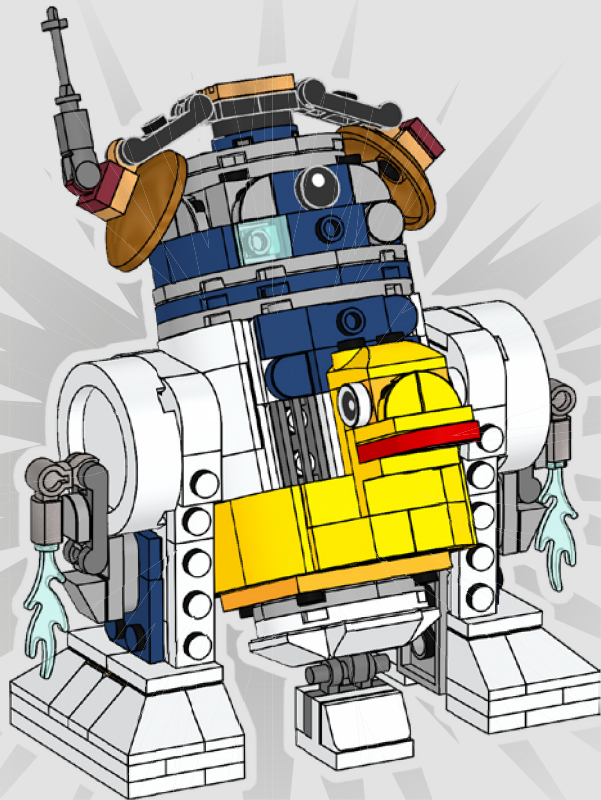

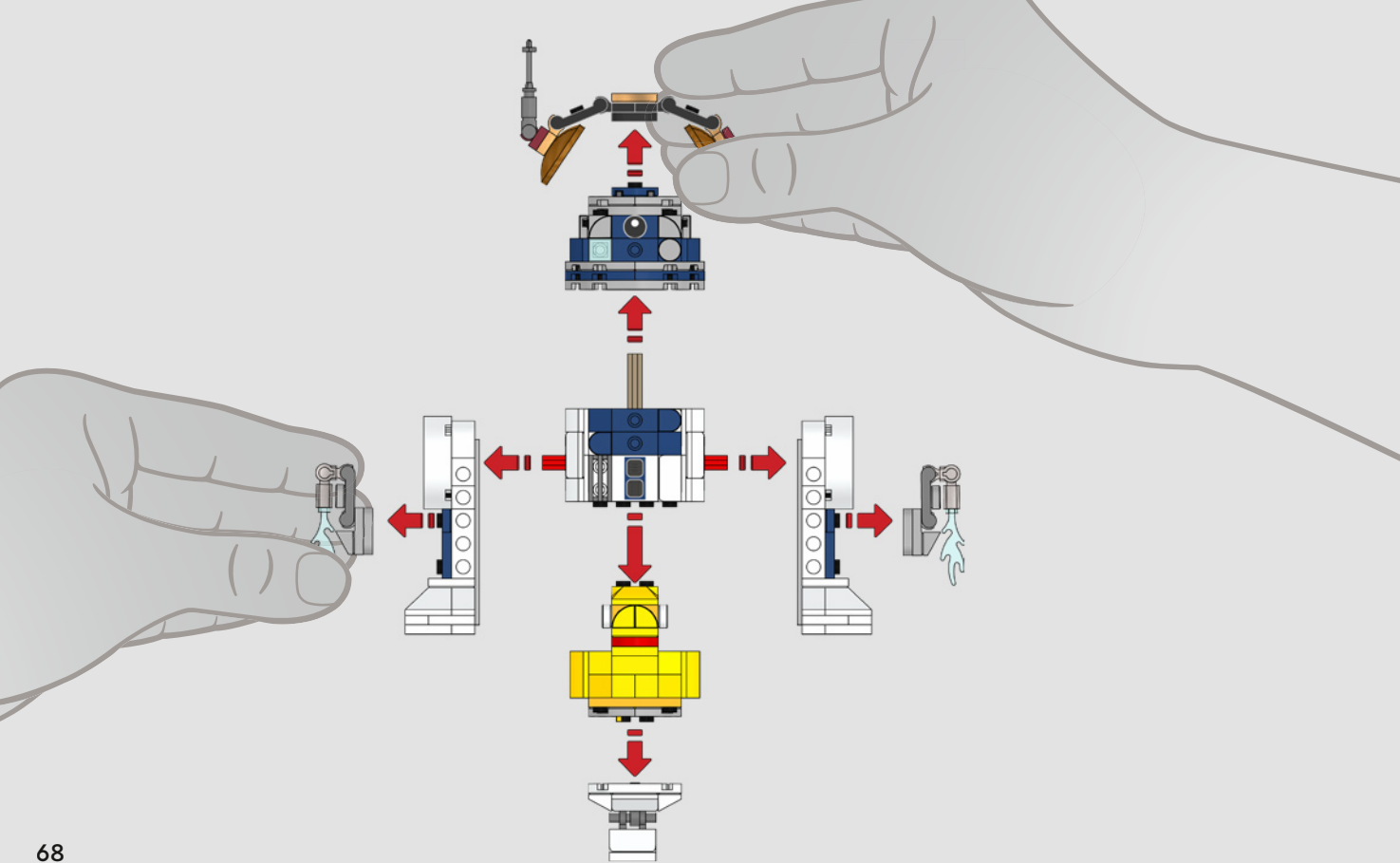

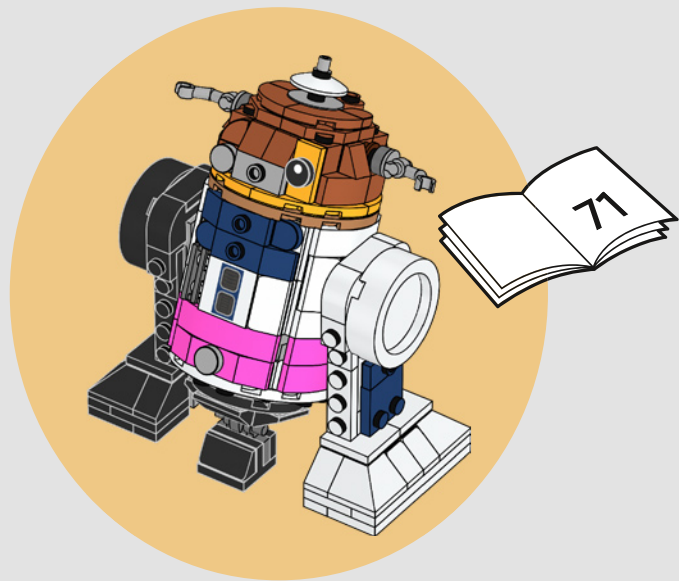
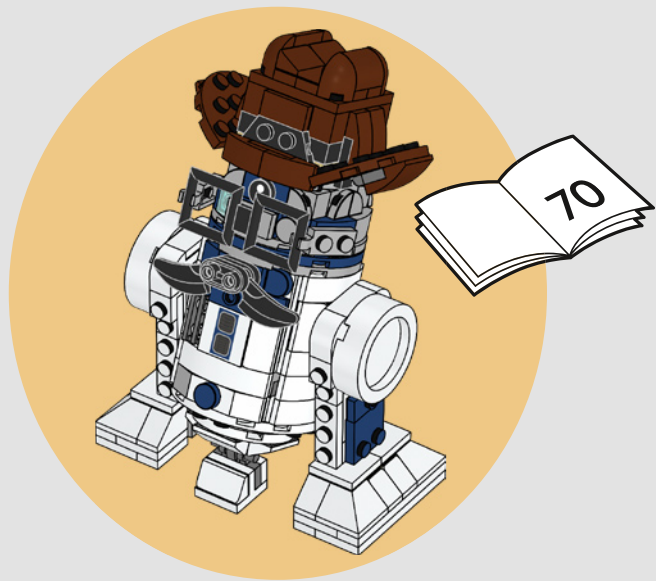

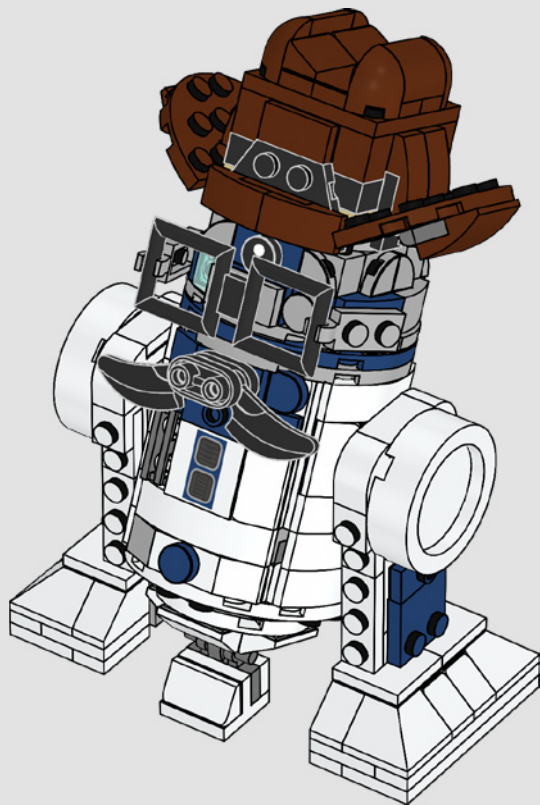
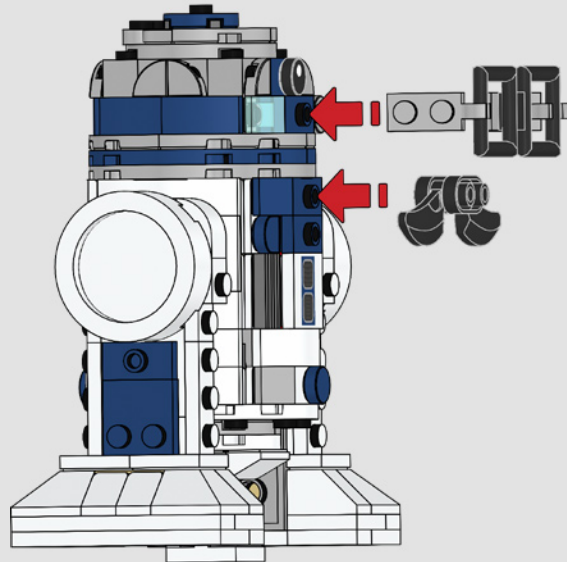
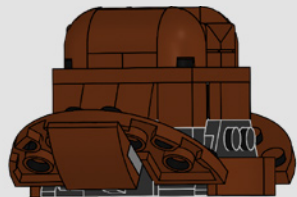

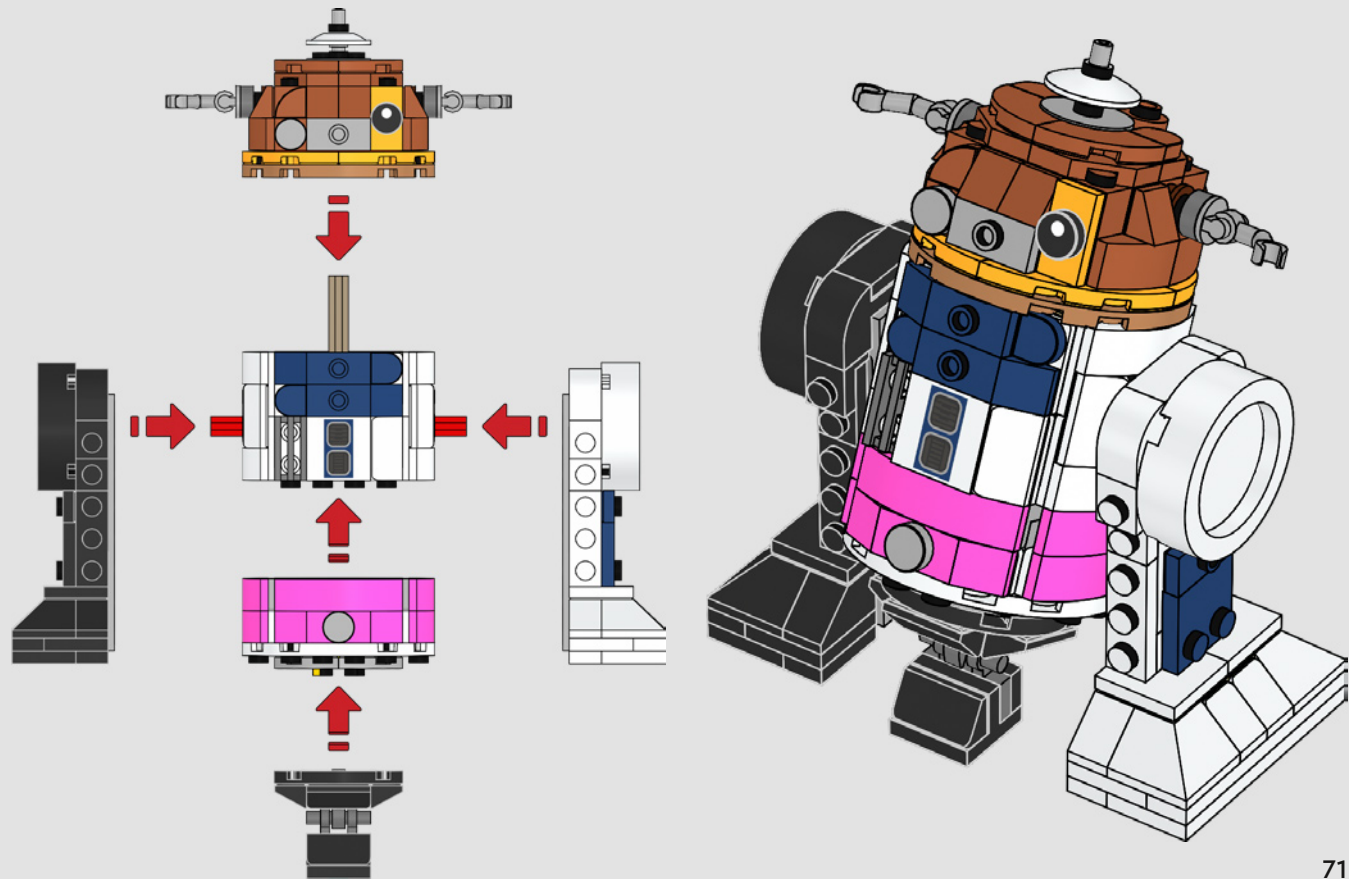



# Rebuild the World™



LEGO and the LEGO logo are trademarks of the LEGO Group.  
©2024 The LEGO Group. 6533867

© & ™ Lucasfilm Ltd.