

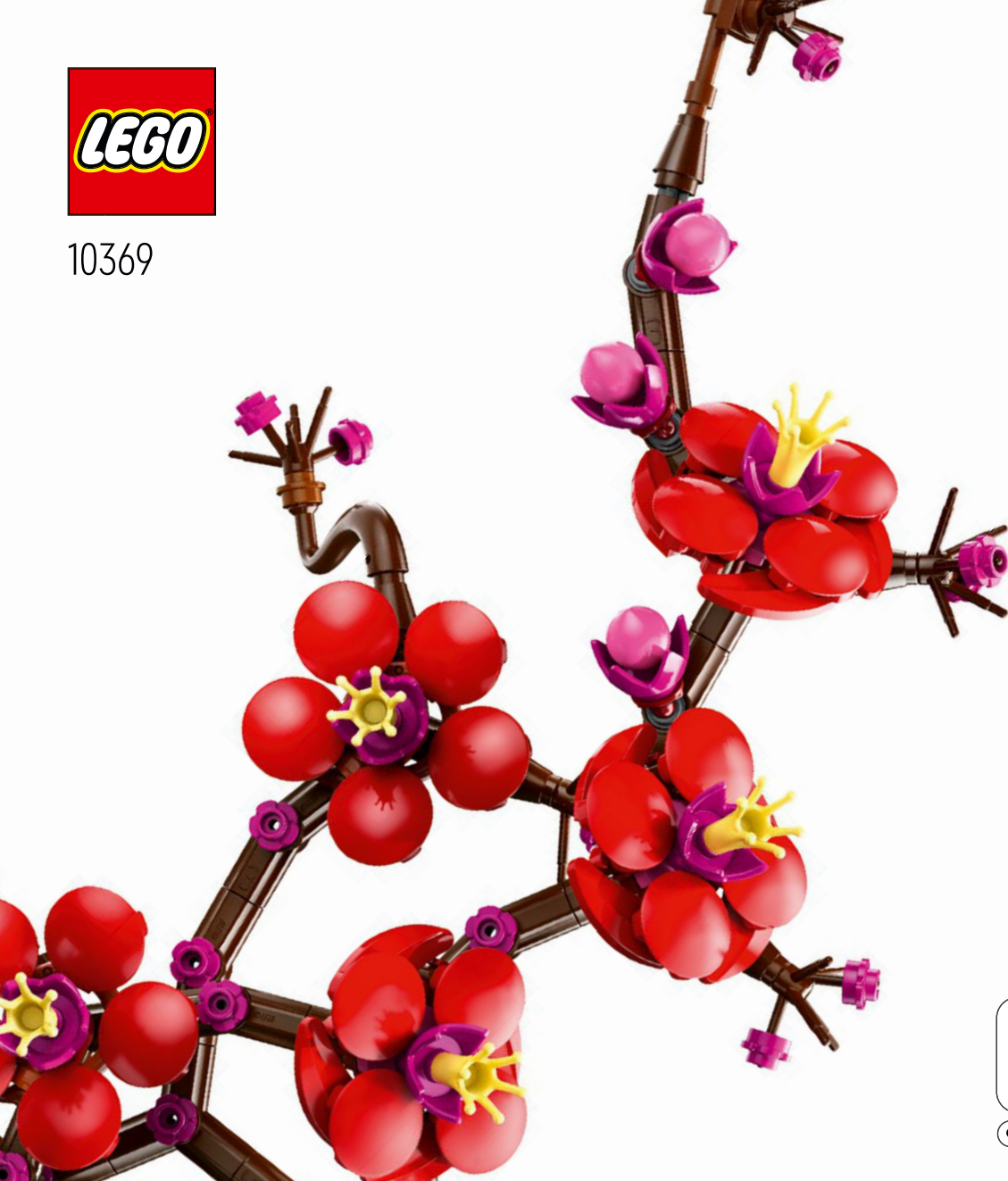

10369

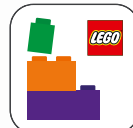

Booklet available in English
Livret disponible en français
Folleto disponible en español



LEGO® Builder

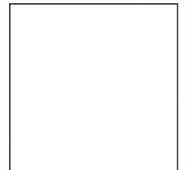

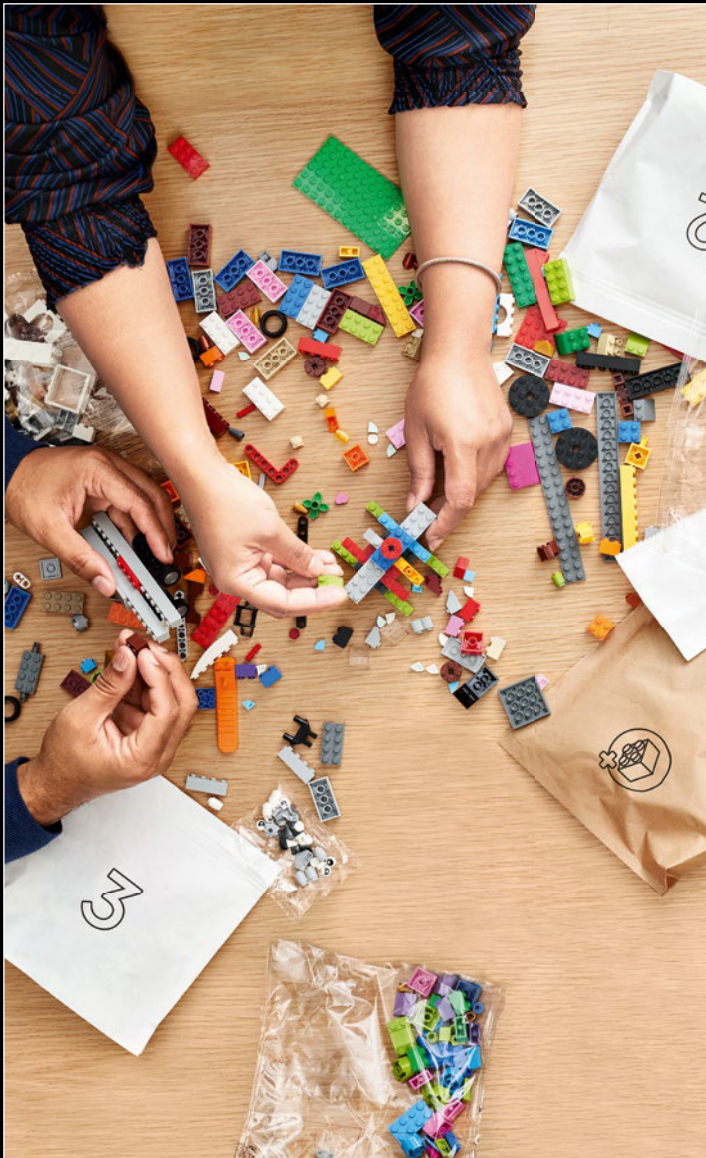

WE'RE MAKING OUR PACKAGING MORE SUSTAINABLE

We're transitioning from single-use plastic to paper-based packaging. As we progress, you may find a mix of paper and plastic in our boxes.

NOUS RENDONS NOS EMBALLAGES PLUS DURABLES

Nous passons des emballages en plastique à usage unique aux emballages à base de papier. Durant la transition, vous pourriez trouver un mélange de papier et de plastique dans nos boîtes.

QUEREMOS HACER MÁS SUSTENTABLES NUESTROS MATERIALES DE EMBALAJE

Estamos cambiando las bolsas de plástico desechables por bolsas con base de papel. Conforme avanzamos en este propósito, puedes encontrar una mezcla de papel y de plástico en nuestras cajas.

LEGO.com/sustainable-packaging



BUILDER



Apple and the Apple logo are trademarks of Apple Inc., registered in the U.S. and other countries and regions. App Store is a service mark of Apple Inc. Google Play and the Google Play logo are trademarks of Google LLC. Tencent and the Tencent logo are trademarks of Tencent Inc.

LEGO.com/devicecheck



LEGO® Builder



THE FOUR GENTLEMEN
LES QUATRE GENTILSHOMMES
LOS CUATRO CABALLEROS



PLUM BLOSSOM

The plum tree flower has long been a popular motif in traditional art. In a tradition that spans more than a thousand years, it is often portrayed in ink and wash paintings amidst a classic quartet of beautiful plants known as The Four Gentlemen, or the Four Noble Ones. Together, they represent the virtues and continuous circle of the four seasons: The plum tree (winter), the orchid (spring), the bamboo (summer) and the chrysanthemum (autumn). Sprouting its vibrant, crimson blossoms in the coldest months, the plum tree reminds us of our inner beauty and grace in times of adversity.

LA FLEUR DE PRUNIER

La fleur de prunier est depuis longtemps un motif populaire dans l'art traditionnel. Dans une tradition qui remonte à plus de mille ans, elle est souvent représentée dans des peintures à l'encre et au lavis comme faisant partie d'un quatuor classique de belles plantes connu sous le nom des « quatre gentilshommes » ou des « quatre nobles plantes ». Ensemble, elles représentent les vertus et le cercle continu des quatre saisons : le prunier (l'hiver), l'orchidée (le printemps), le bambou (l'été) et le chrysanthème (l'automne). Avec ses fleurs cramoisies et éclatantes qui poussent pendant les mois les plus froids, le prunier nous rappelle notre beauté intérieure et notre grâce dans les moments d'adversité.

FLOR DE CIRUELO

Por un largo tiempo, la flor del ciruelo ha sido un motivo popular en el arte tradicional. En una tradición que abarca más de mil años, con frecuencia la encontramos representada en pinturas de tinta y aguada como parte integral de un cuarteto clásico de bellas plantas conocido como *los cuatro caballeros* o *los cuatro nobles*. Juntas, representan las virtudes y el ciclo continuo de las cuatro estaciones: el ciruelo (invierno), la orquídea (primavera), el bambú (verano) y el crisantemo (otoño). Con el brote de sus vibrantes flores carmesí durante los meses más fríos, el ciruelo nos recuerda nuestra belleza interior y nuestros dones en tiempos de adversidad.



CREATIVITY OF NATURE

Creating decor that draws inspiration from nature is a relaxing and rewarding way to set your imagination free. As you build your plum tree blossoms in this vase, you can play with symmetry and seemingly random variants and organic shapes developing in perfect balance. From buds to blossoms, you can study the stages of this magnificent, resilient flower. You can follow the building instructions to create the curated display, but you also have the creative freedom to rearrange the flowers to grow in new directions in the grid of branches. It's the nature of creativity, fueled by the creativity of nature.

THEO BONNER,
LEGO® Model Designer

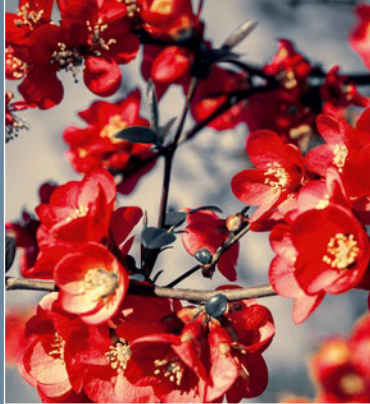

LA CRÉATIVITÉ DE LA NATURE

La création de décors inspirés de la nature est un moyen relaxant et gratifiant de laisser libre cours à notre imagination. En créant vos fleurs de prunier dans ce vase, vous pouvez jouer avec la symétrie, les variantes apparemment aléatoires et les formes organiques qui se développent en parfait équilibre. Des bourgeons aux fleurs, vous pouvez étudier les étapes de cette magnifique fleur robuste. Vous pouvez suivre les instructions de montage pour créer la décoration, mais vous avez aussi la liberté créative de réarranger les fleurs pour qu'elles poussent dans de nouvelles directions dans la grille de branches. C'est la nature de la créativité, alimentée par la créativité de la nature.

THEO BONNER,
concepteur de modèles LEGO®

LA CREATIVIDAD DE LA NATURALEZA

Crear un elemento decorativo inspirado en la naturaleza es una manera relajante y satisfactoria de dar rienda suelta a nuestra imaginación. Al construir las flores del ciruelo y su florero, puedes jugar con el elemento de simetría y las variantes aparentemente aleatorias, así como con formas orgánicas que se desarrollan en perfecto equilibrio. Además, este proyecto te permite mirar de cerca las distintas etapas de la flor de esta magnífica y resiliente especie vegetal, desde los capullos hasta la floración plena. Puedes seguir las instrucciones de construcción para crear una exhibición perfectamente curada, aunque también tienes la libertad creativa de reorganizar las flores para que su retícula de ramas se desarrolle en nuevas direcciones. Esa es la mejor expresión de la naturaleza de la creatividad alimentada por la creatividad de la naturaleza.

THEO BONNER,
modelista de LEGO®

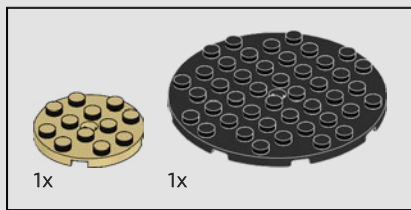

1

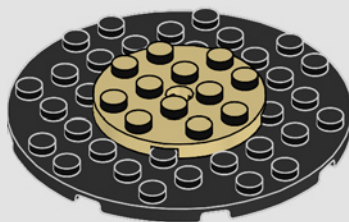

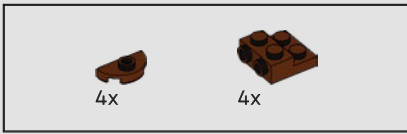

2

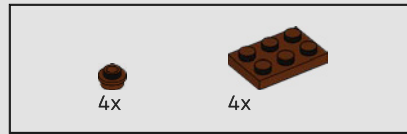
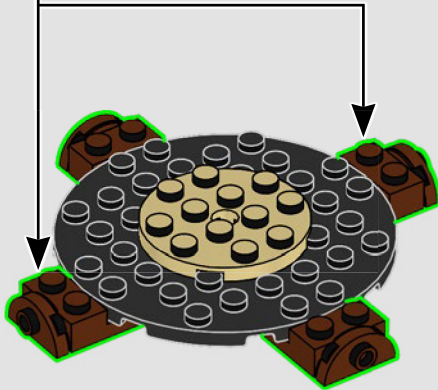
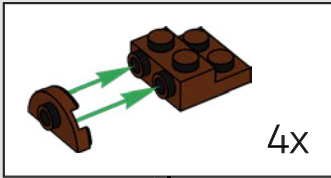

3

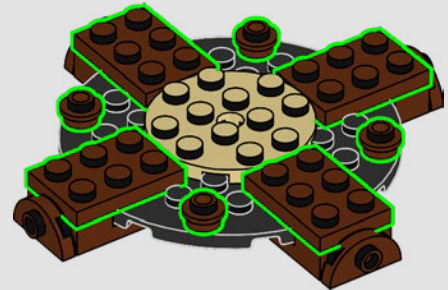



4

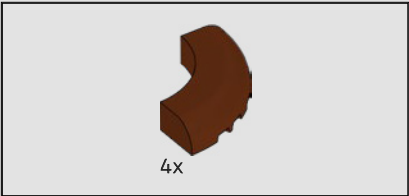
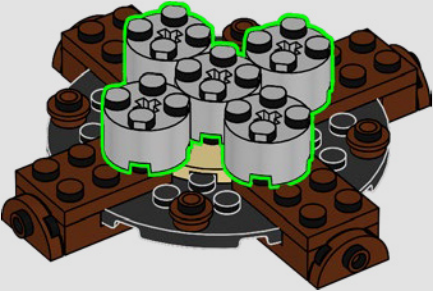

5

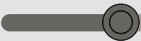
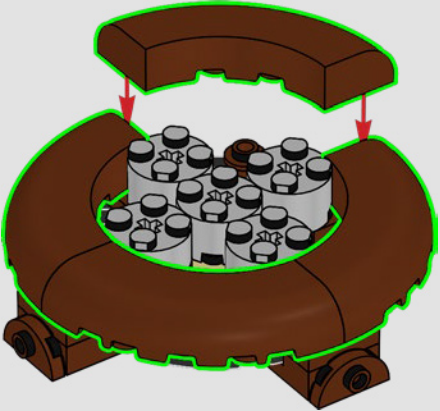



6

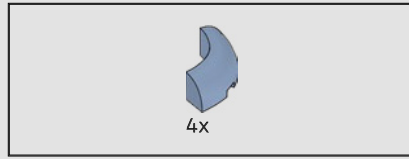
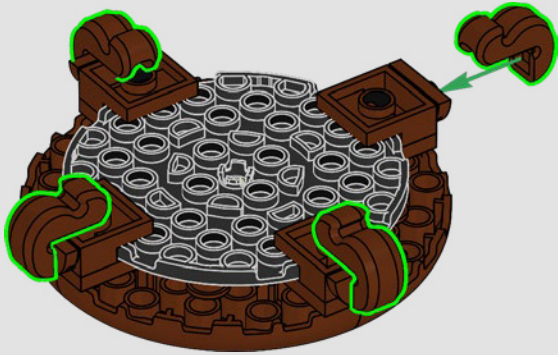

7

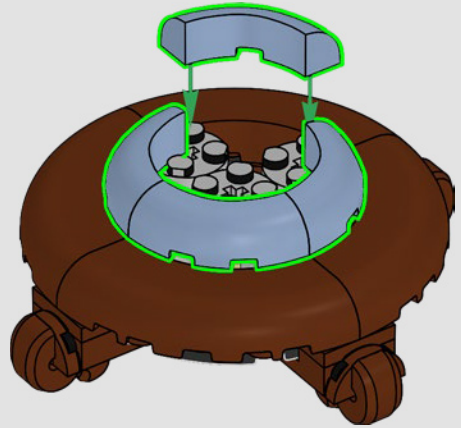

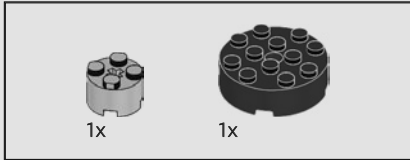
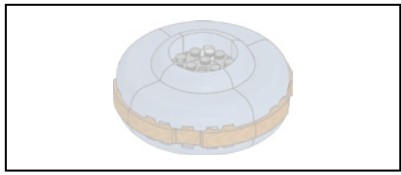

8

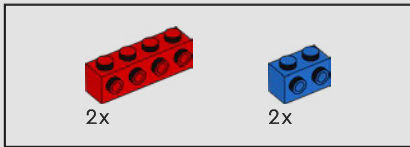
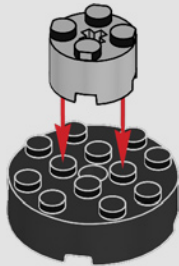

9

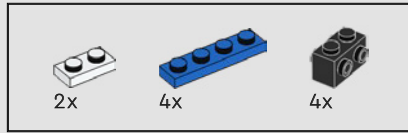
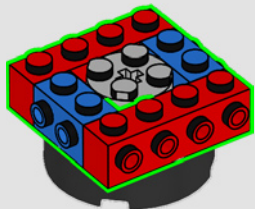

10

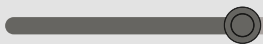
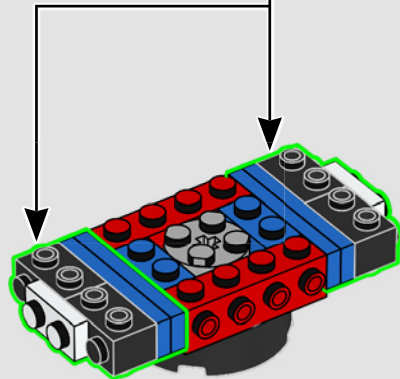
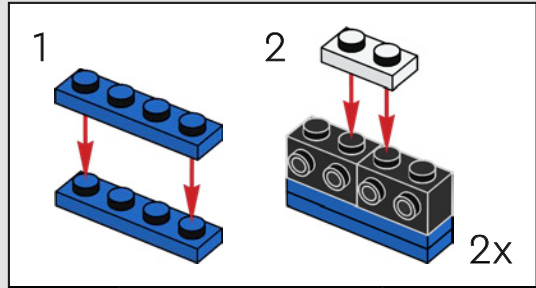

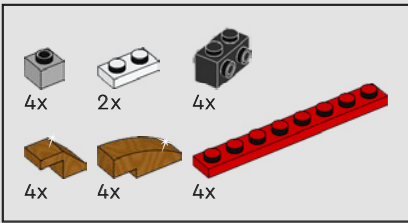

11

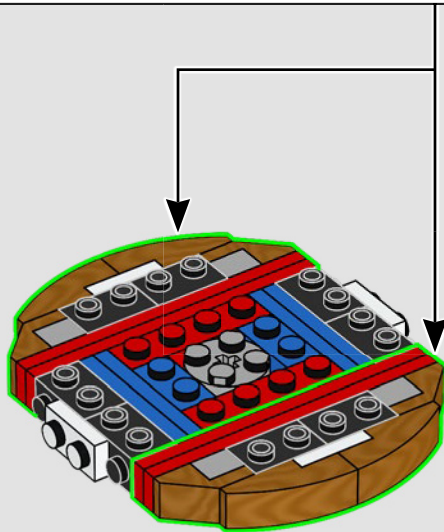
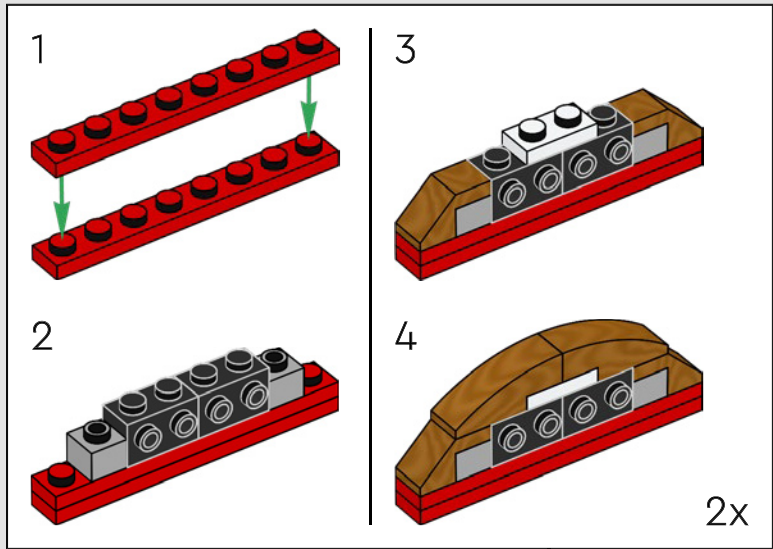

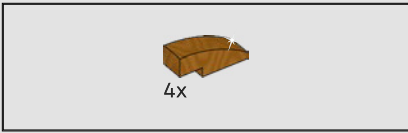

12

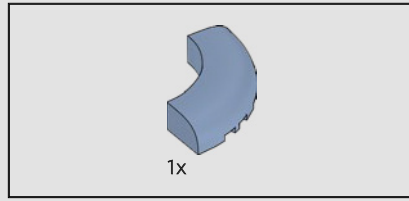
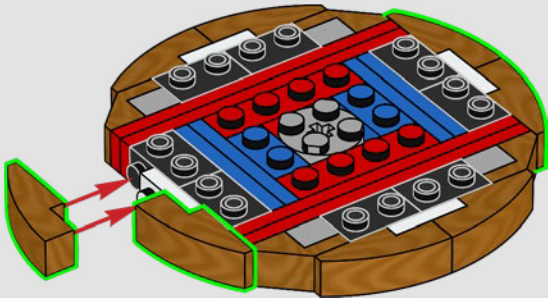

13

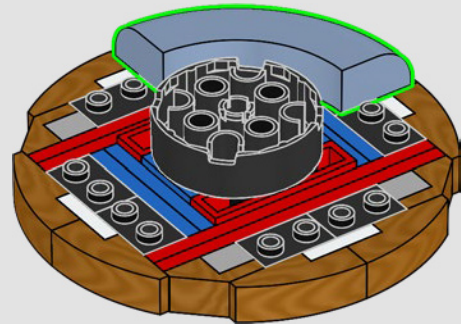

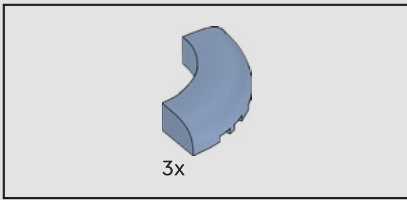

14

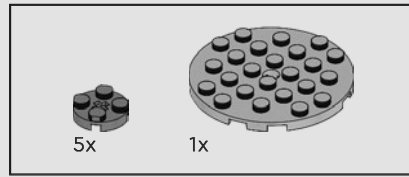
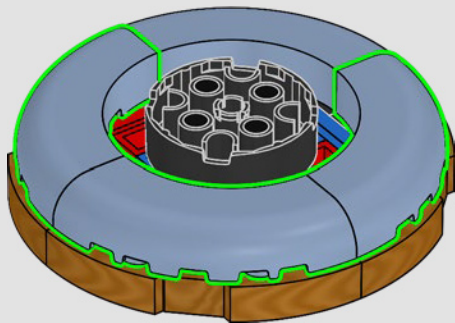

15

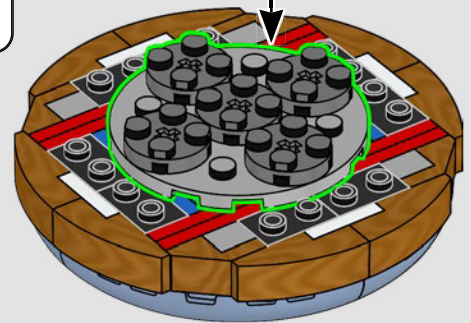
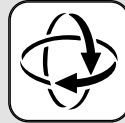
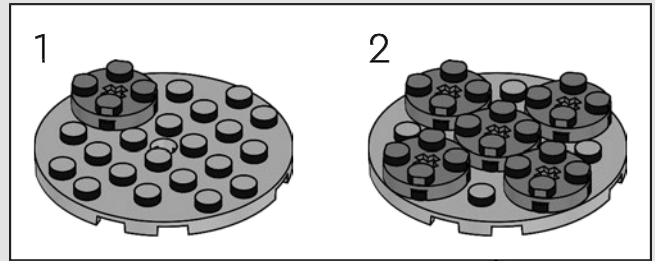

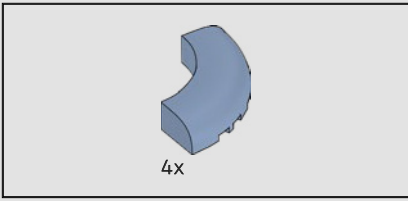

16

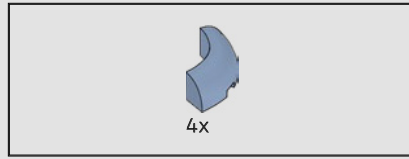
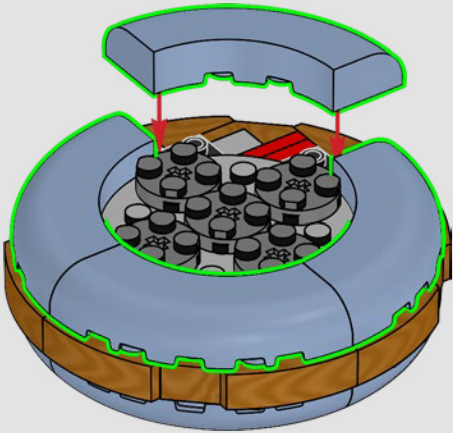

17

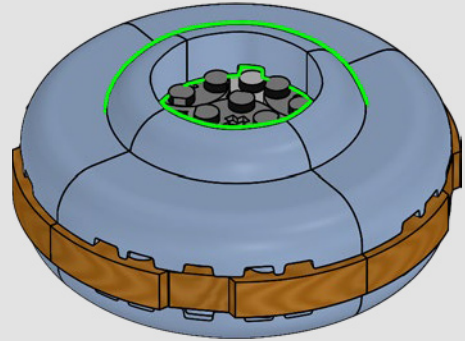

18

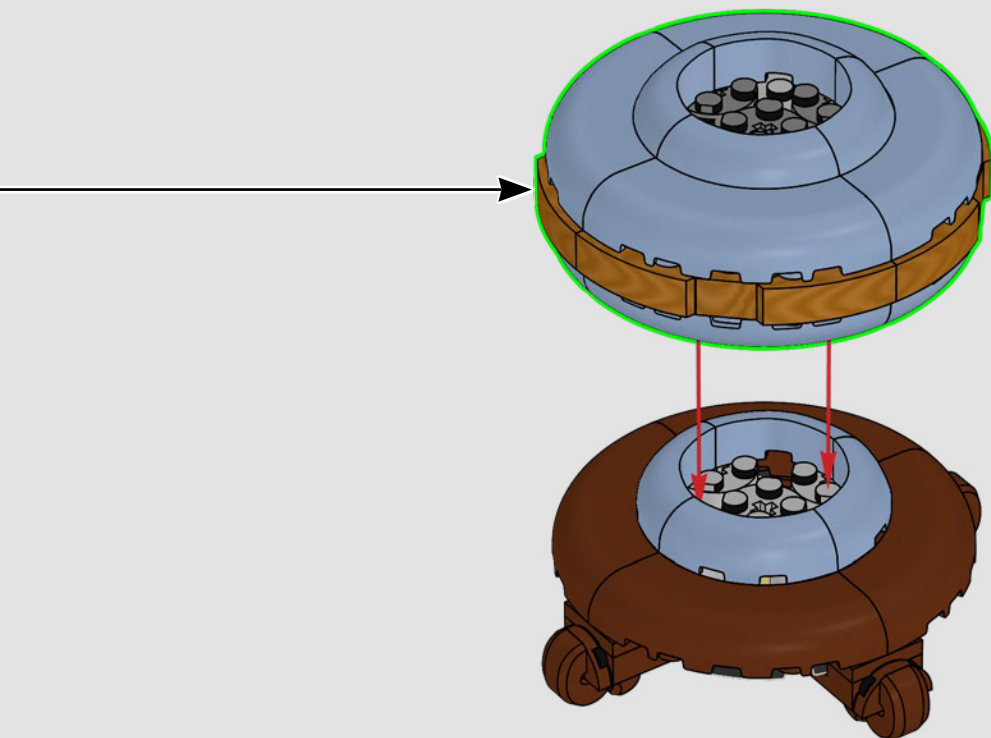

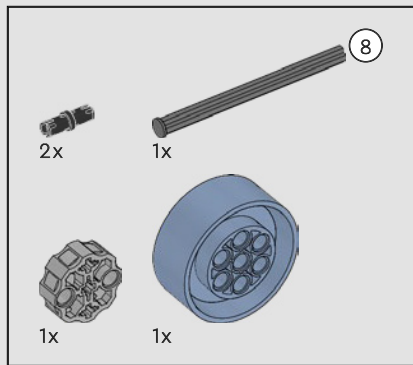

19

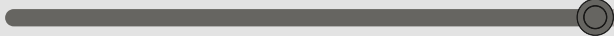
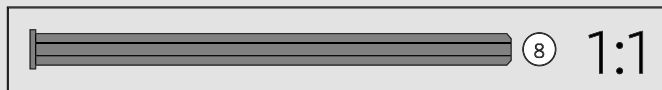
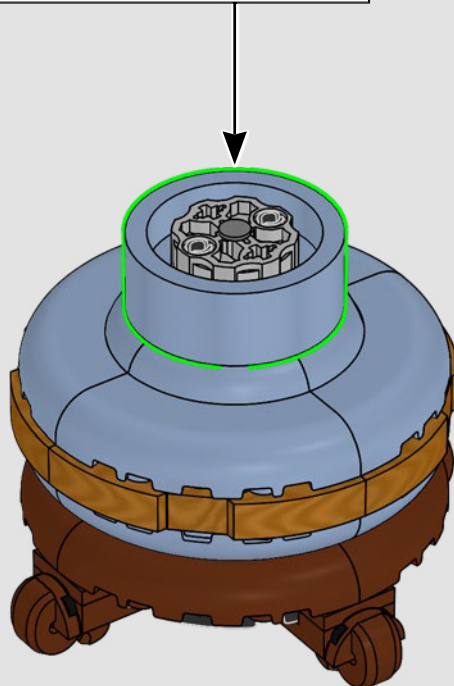
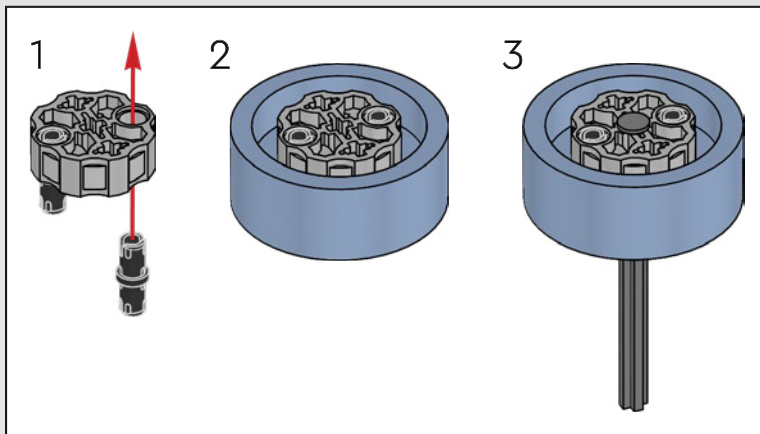

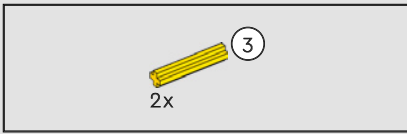

20

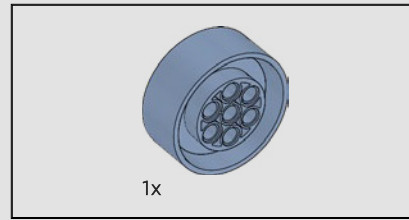
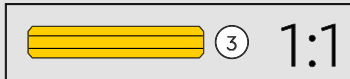
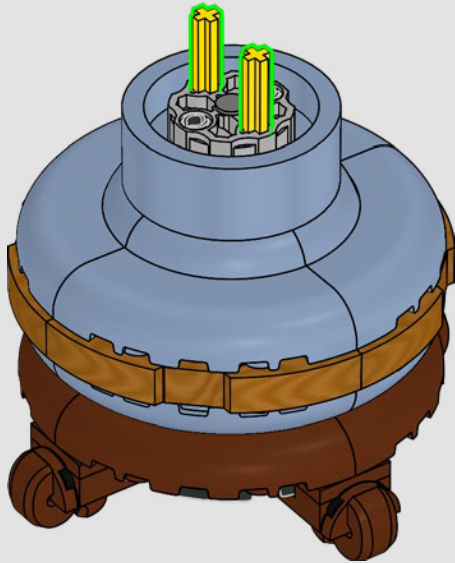

21

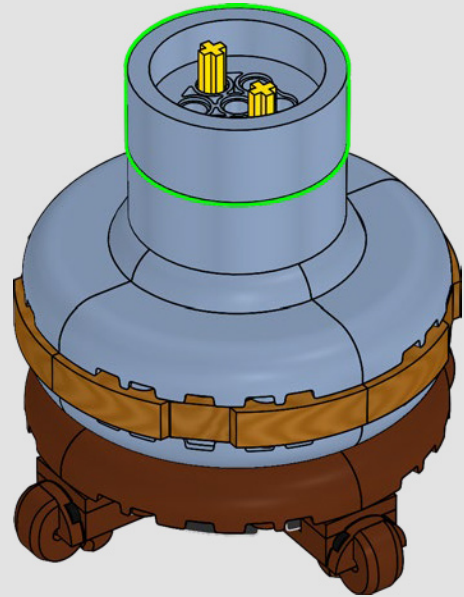

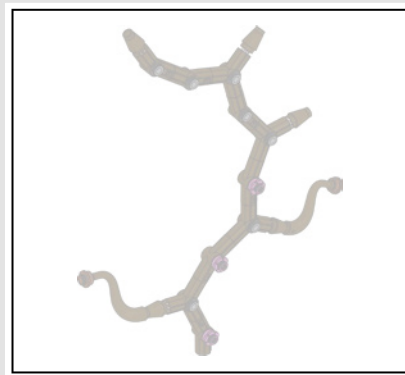

22

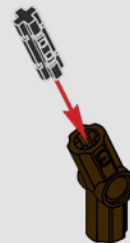

23

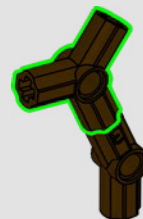

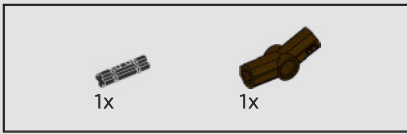

24

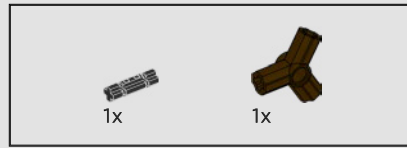
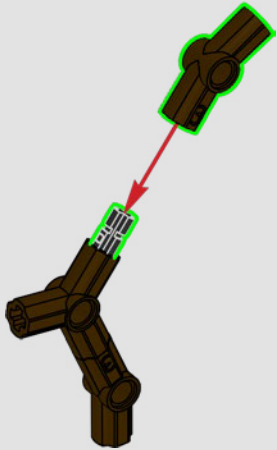

25

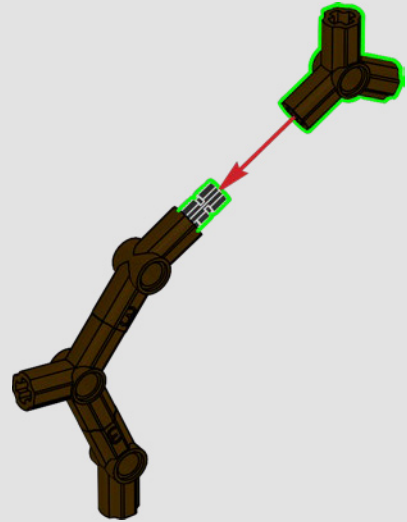



26

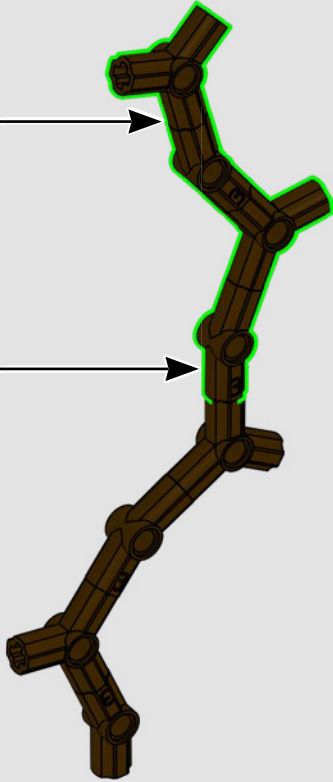
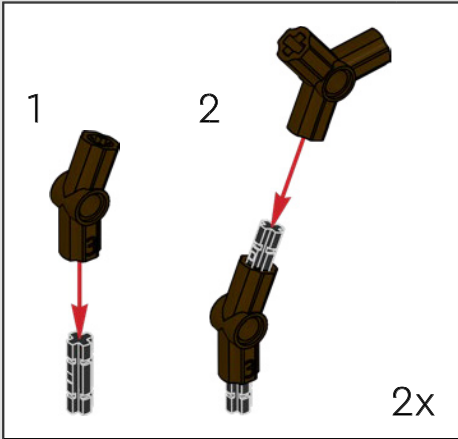

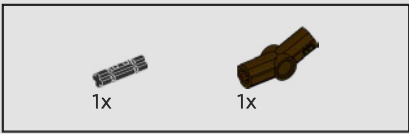

27

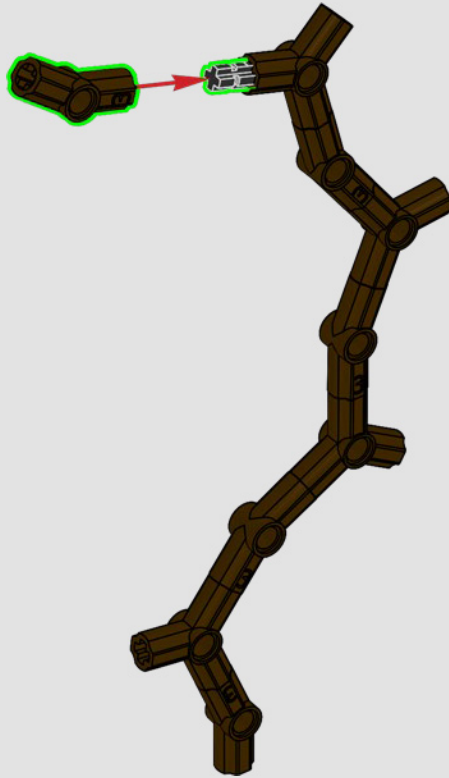

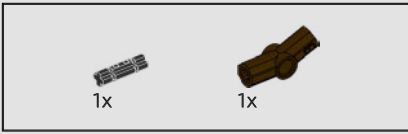

28

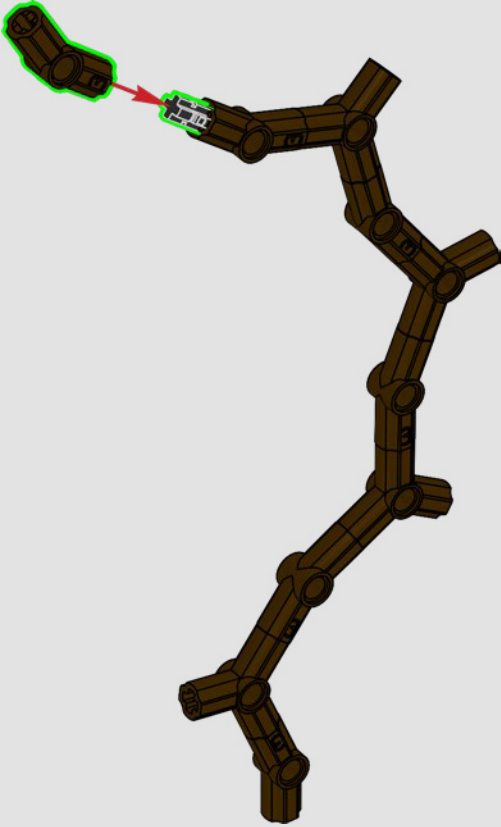

29

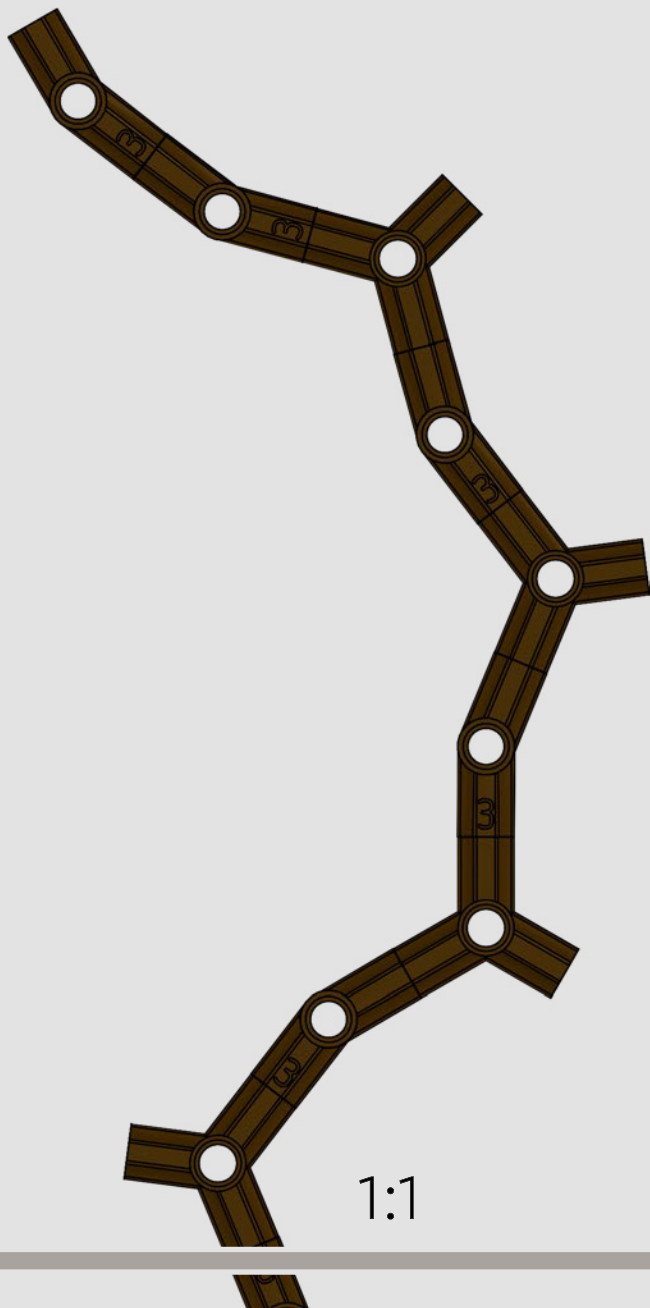

1:1

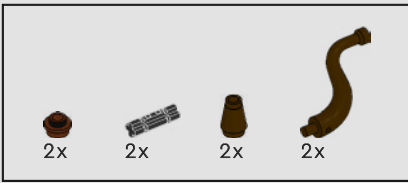

30

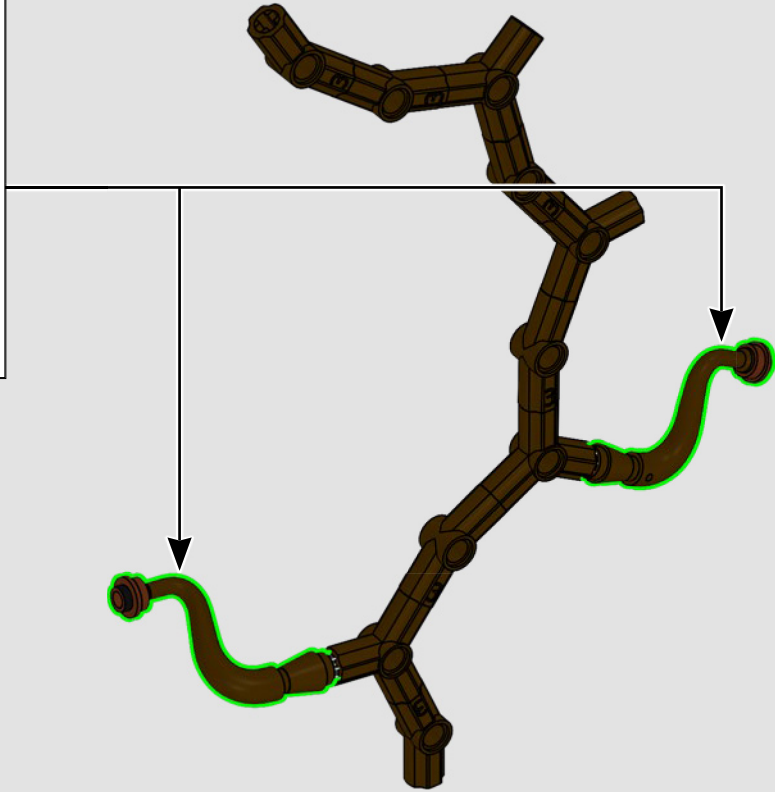
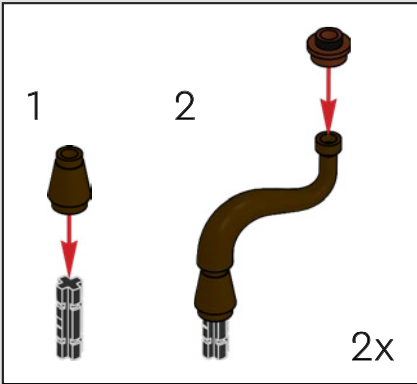



10x

31

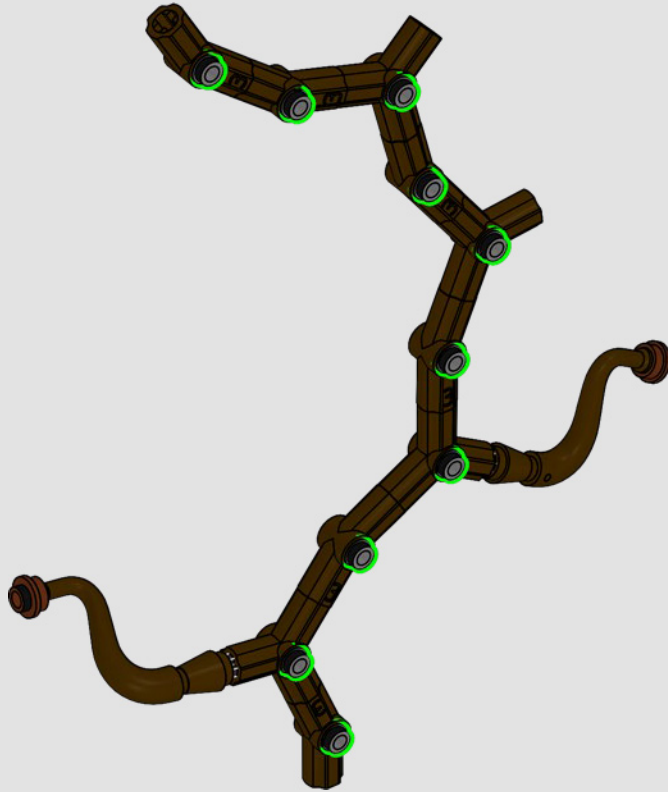



3x

32



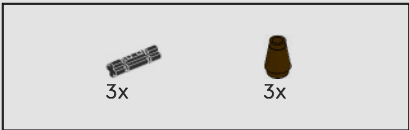

33

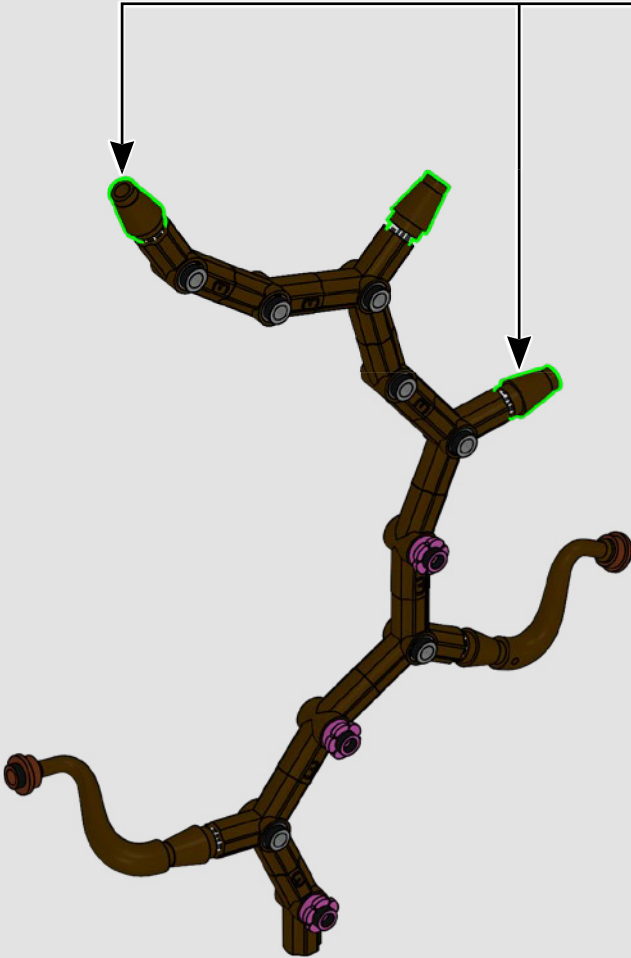
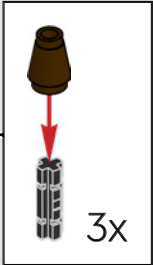

34

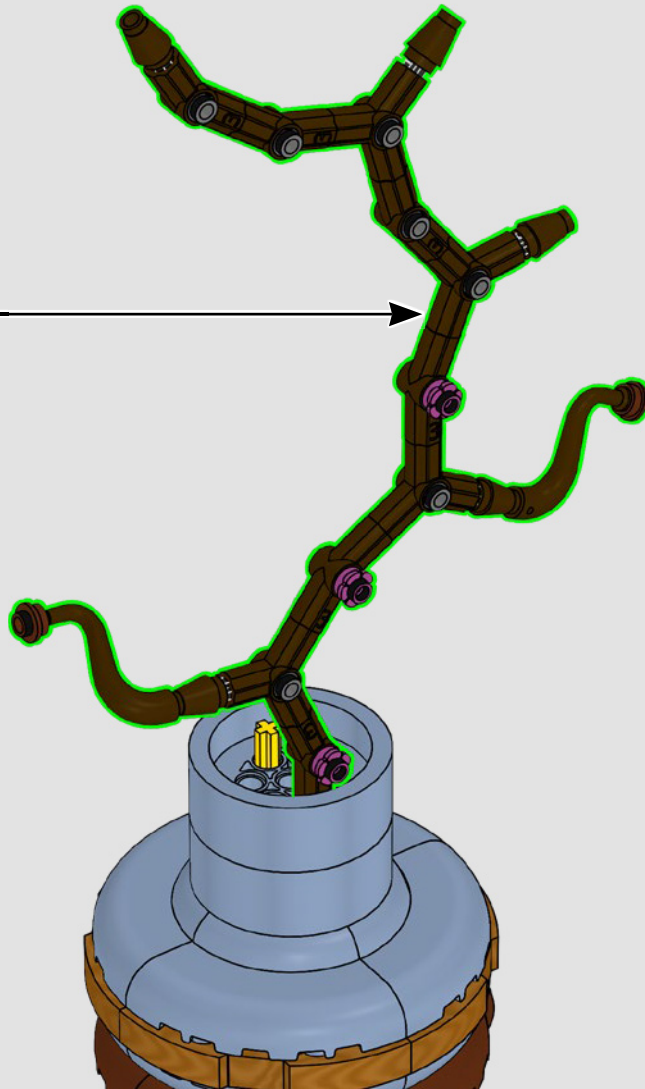

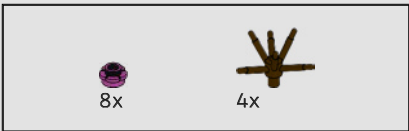

35

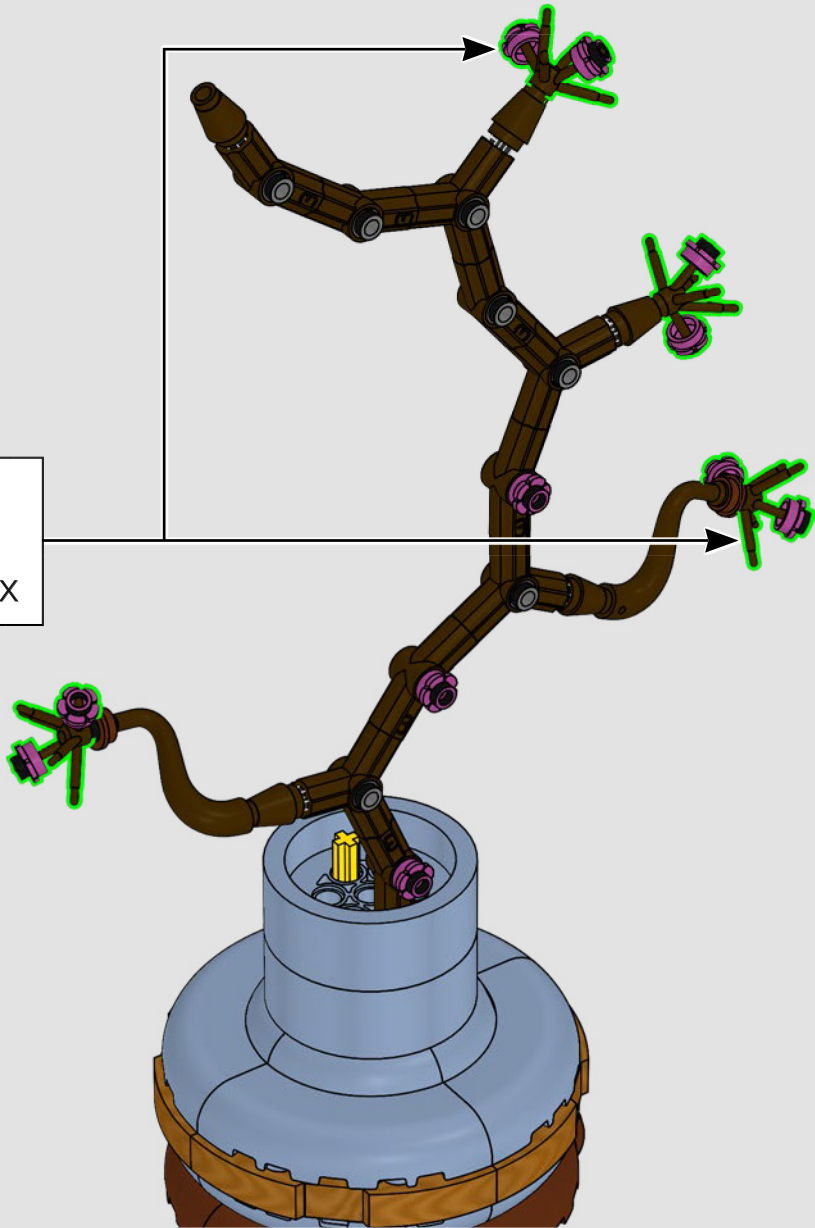
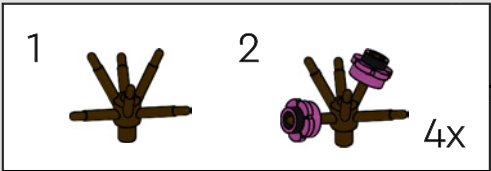

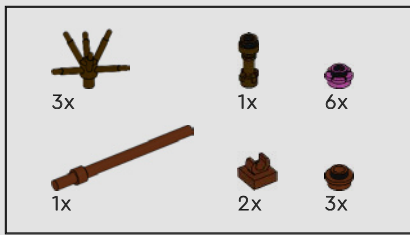

36

1



2



3



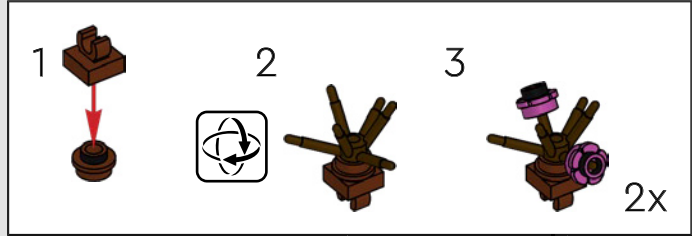

4



5

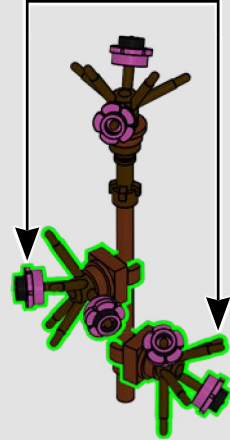

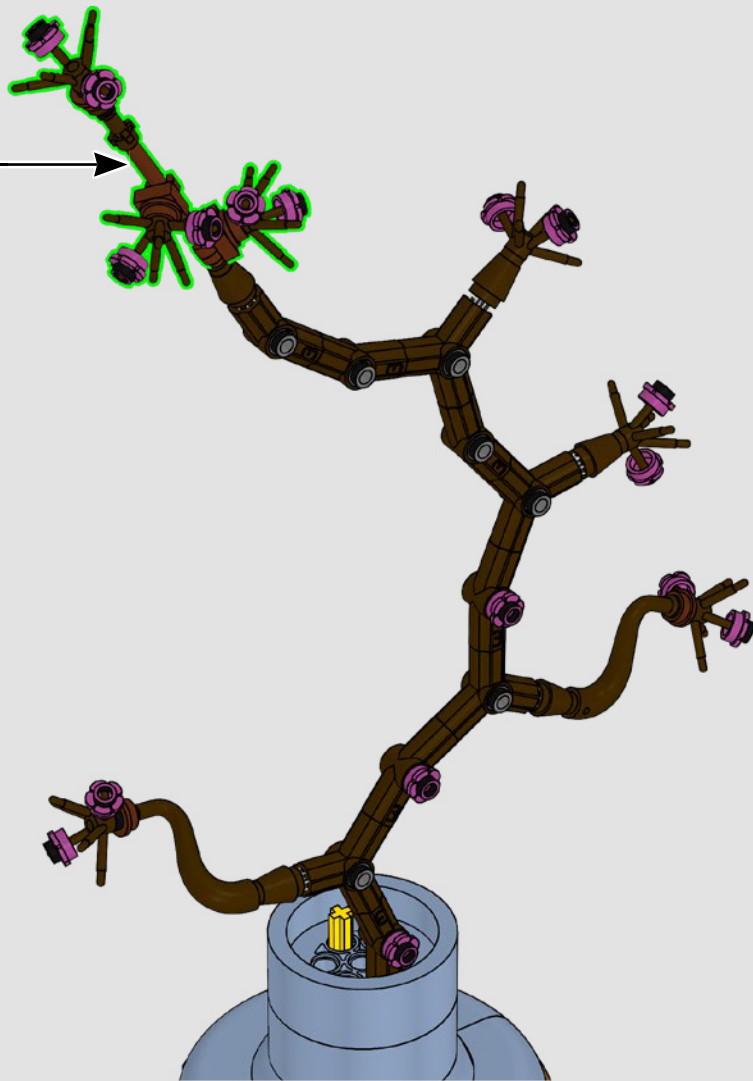



37

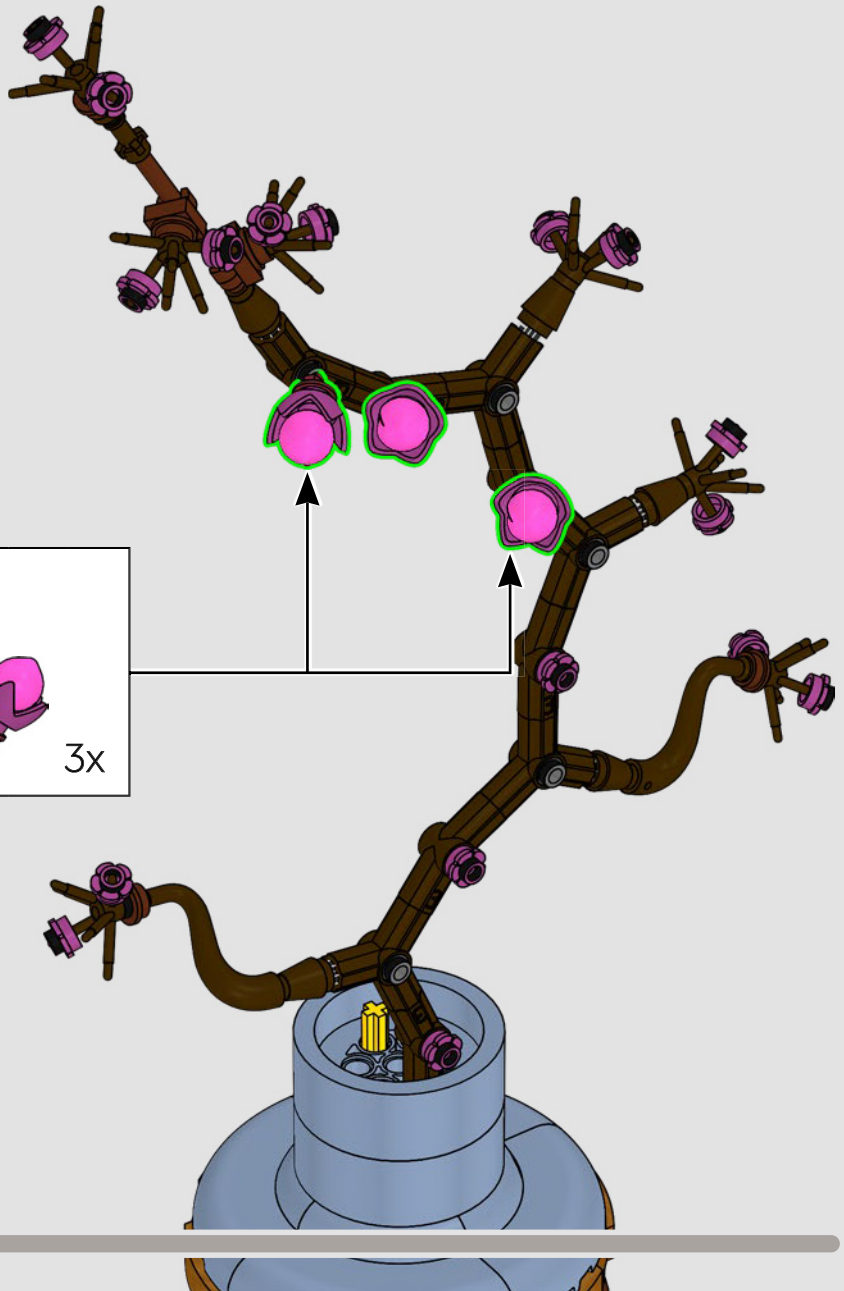
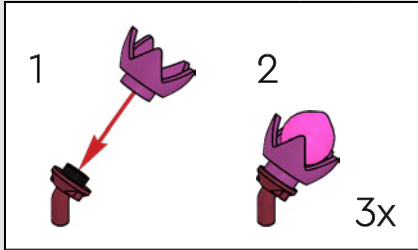

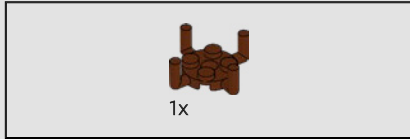

38

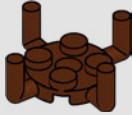

39

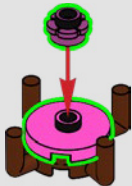

40

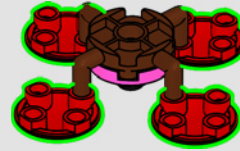

41



42

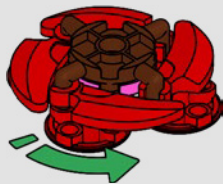

43

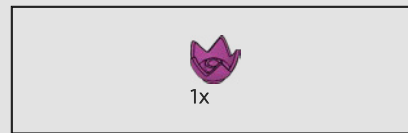

44

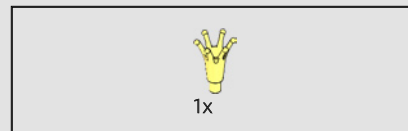
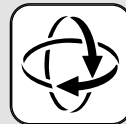

45

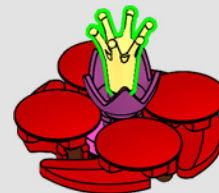

3x

46

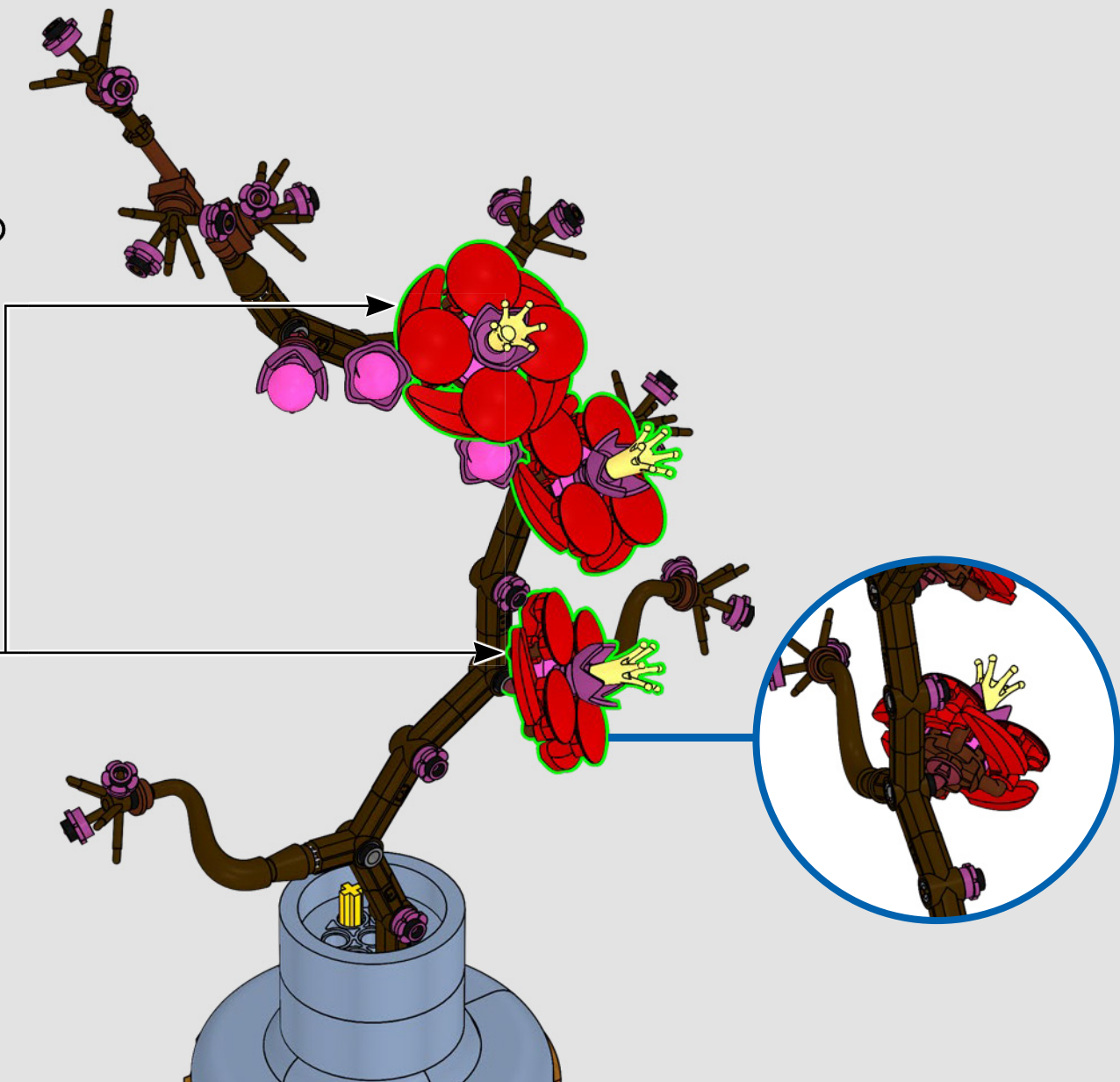



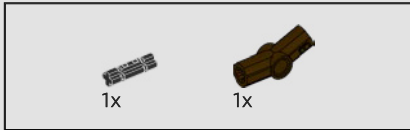
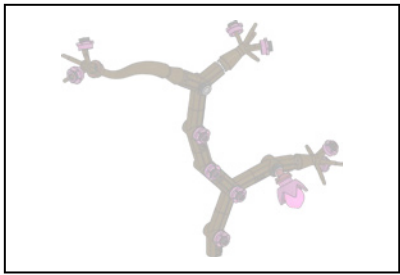

47

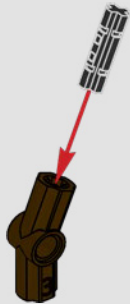

48



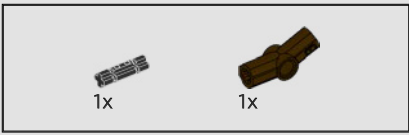

49

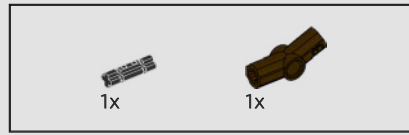
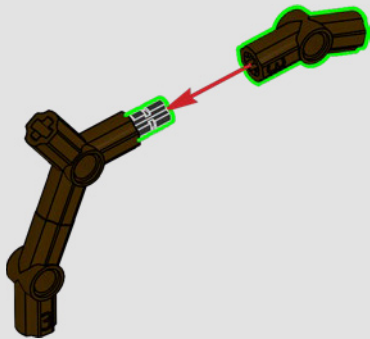

50

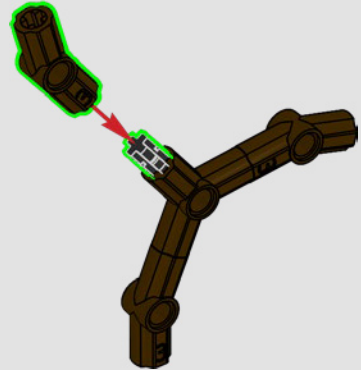

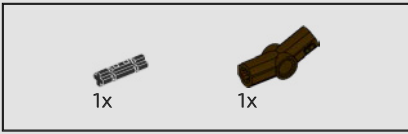

51

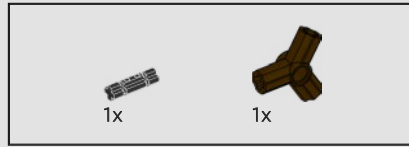
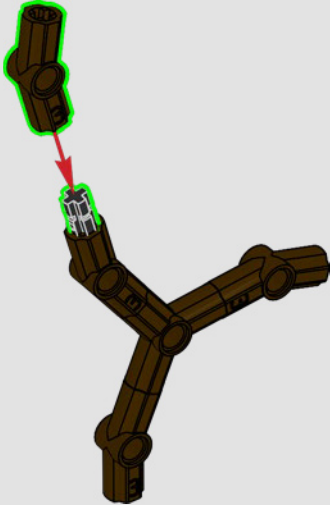

52

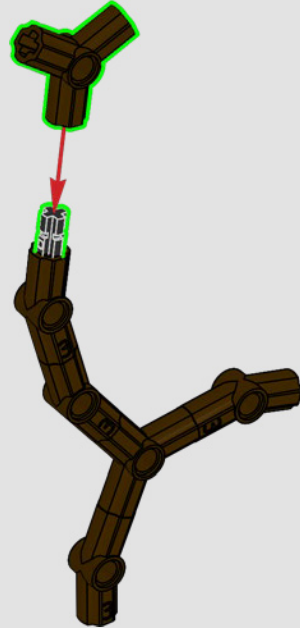

53

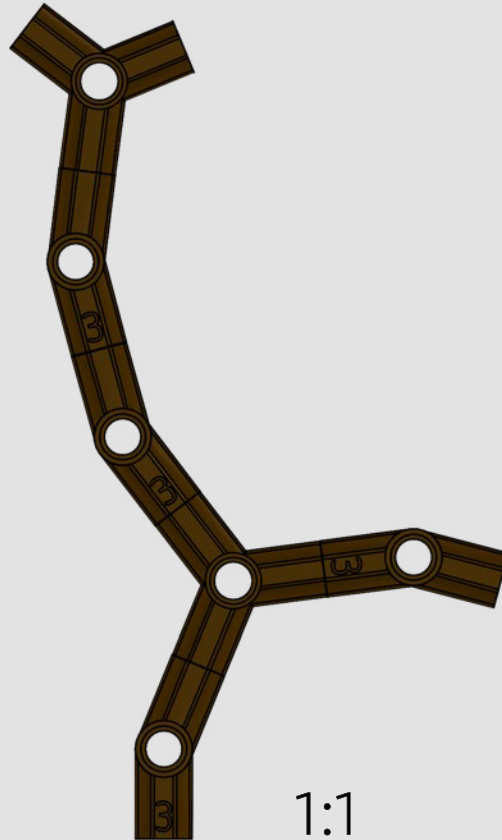

1:1





54

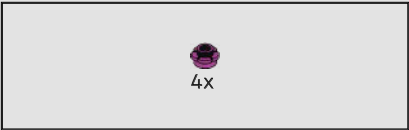
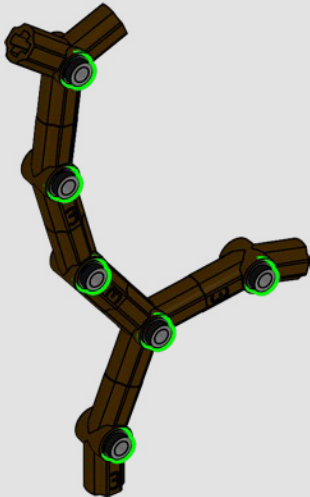

55

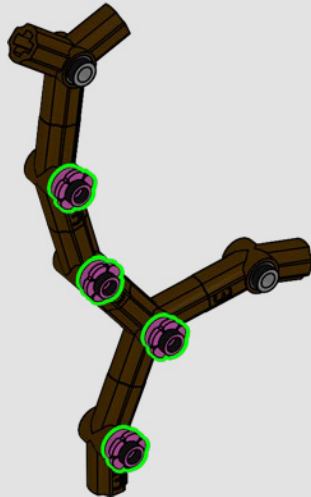

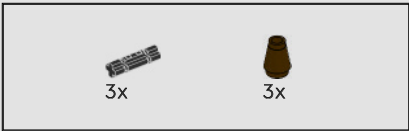

56

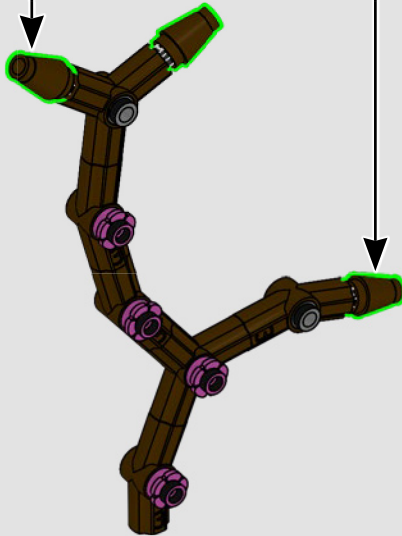
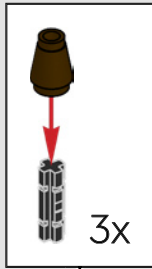

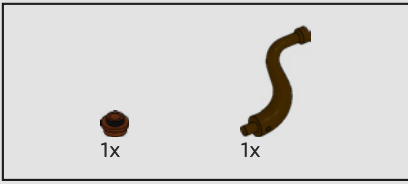

57

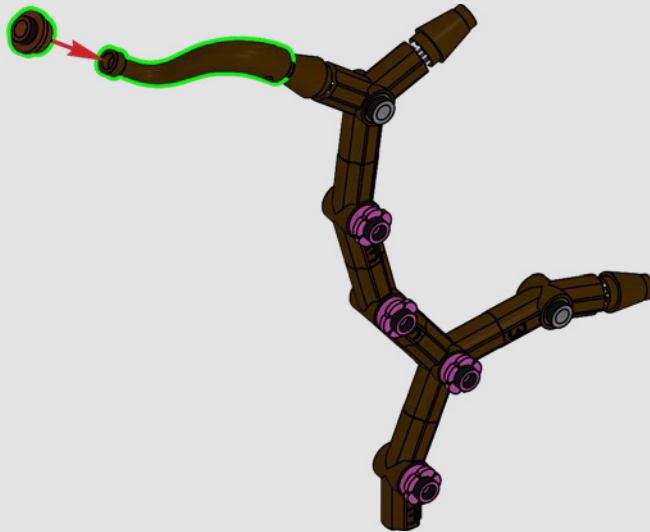

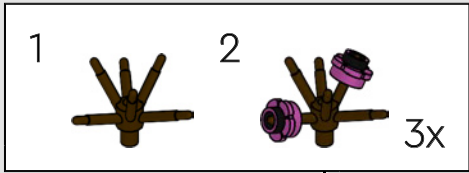

58

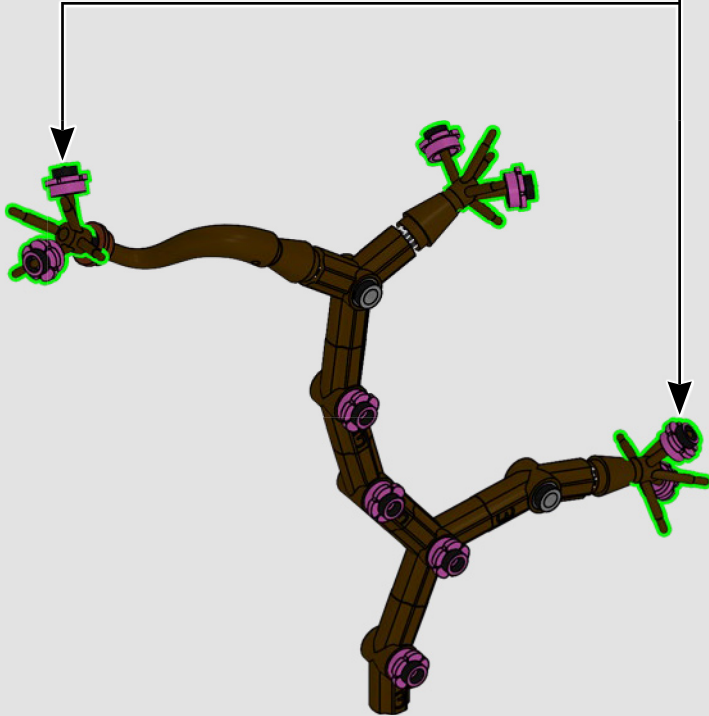



59

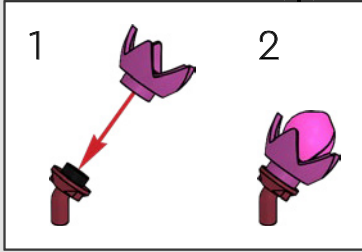
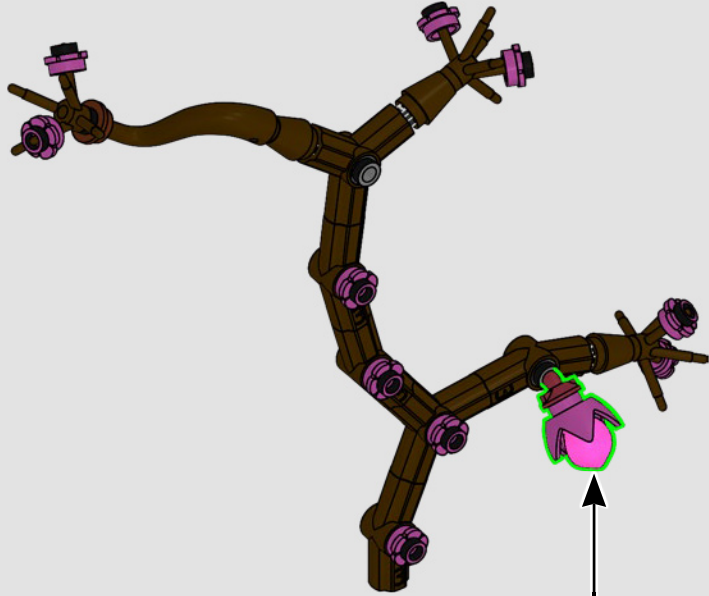

60

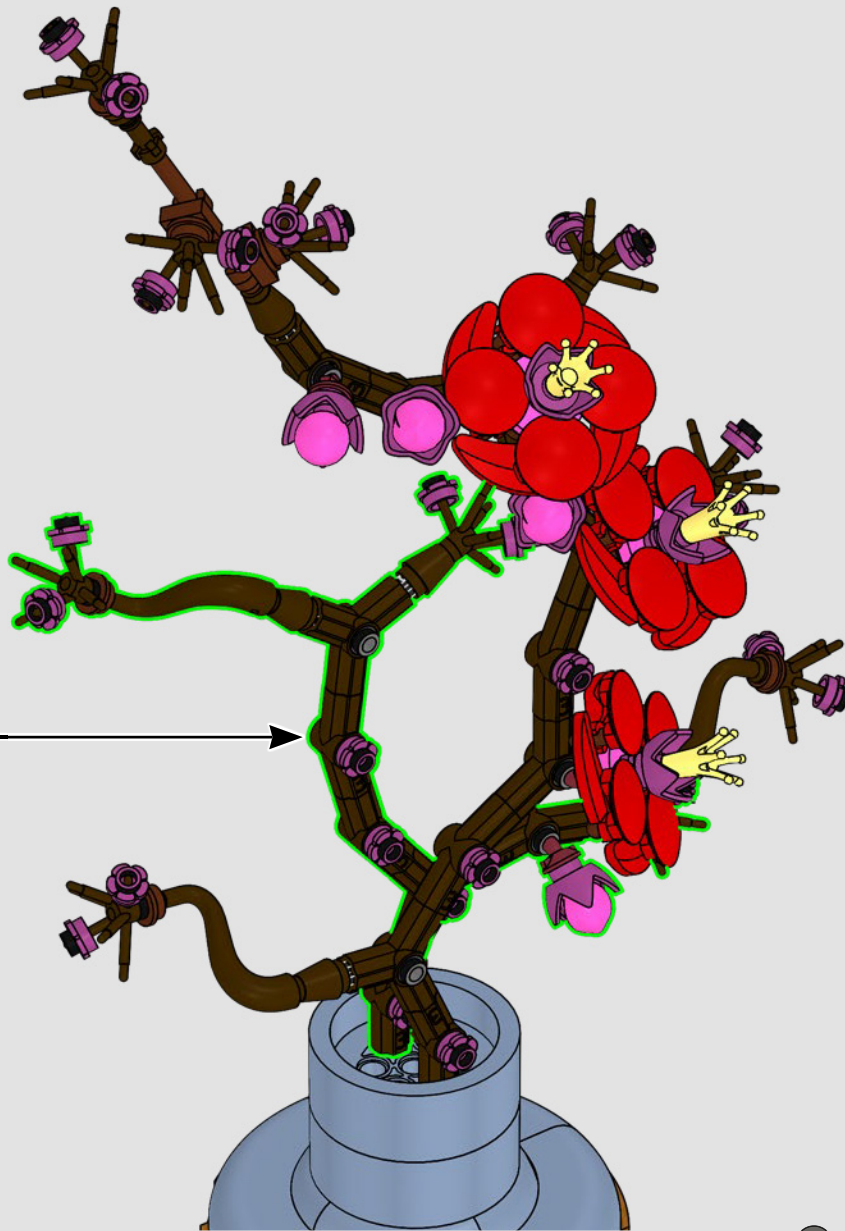

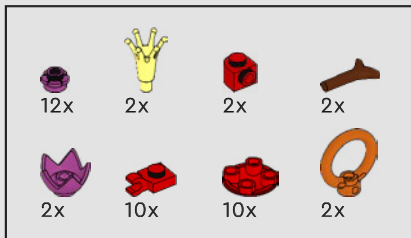

61

1



2

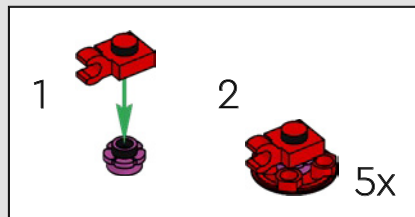
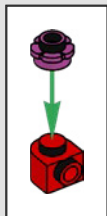

3

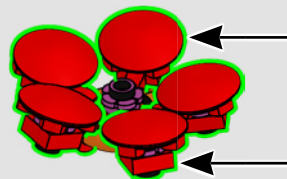

4



5



2x

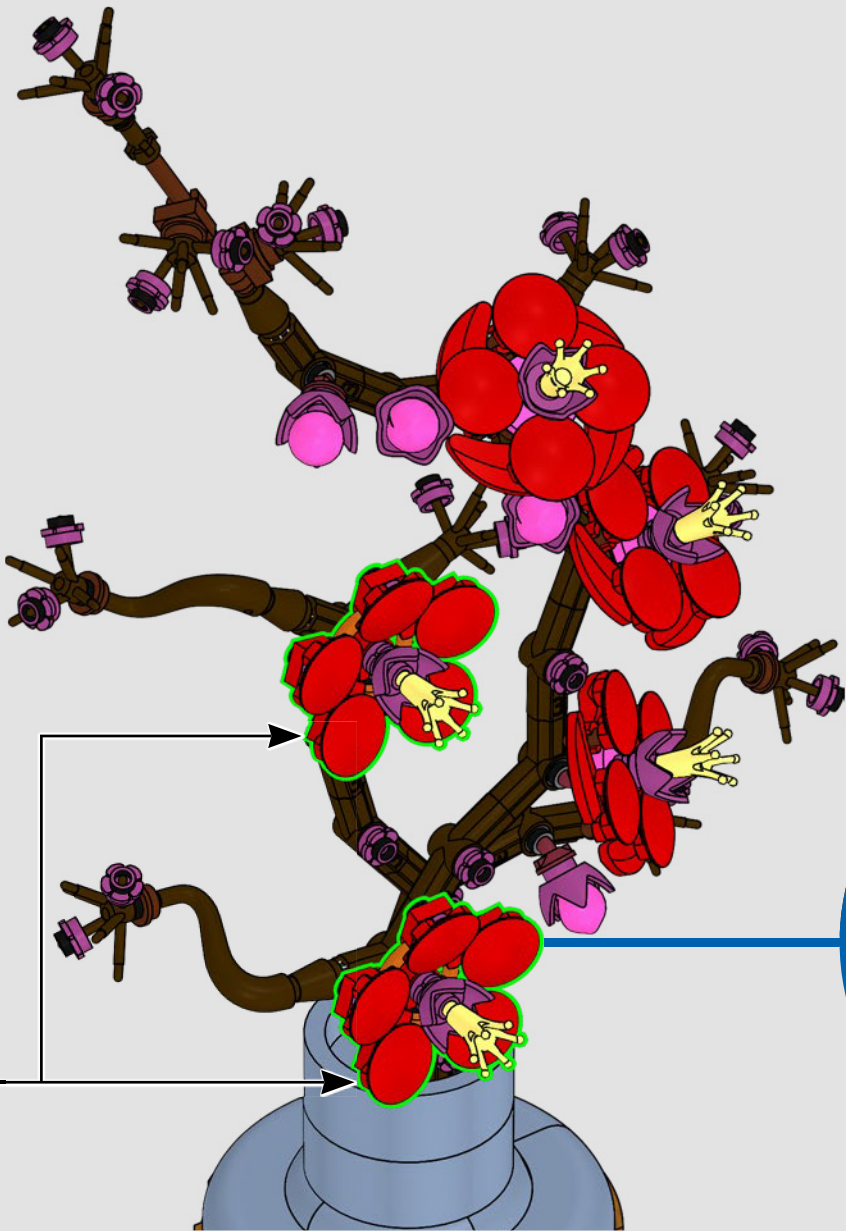

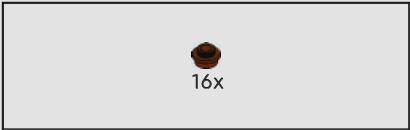

62

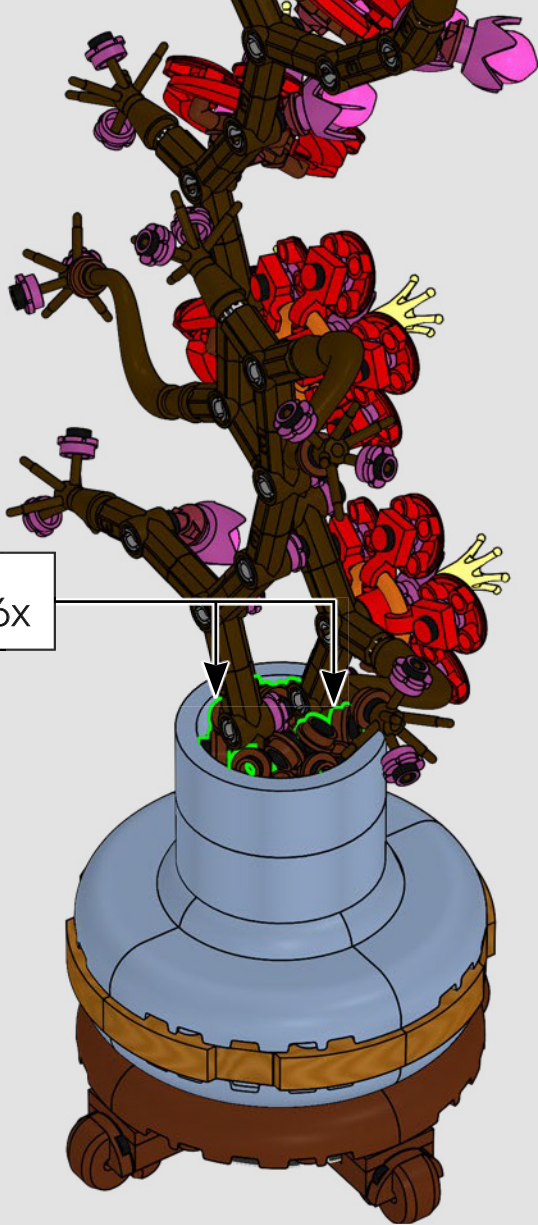

63



2x
6130007

4x
6514696

3x
6223767

2x
6508326

4x
6404402

8x
6516372

2x
6189191

4x
371023



4x
302301

1x
6302268

2x
6494496

10x
6335377

22x
4278275

12x
6253274

2x
4157223

4x
346021

42x
6209682

9x
6510519

5x
6510517

8x
6514697

8x
6529138

2x
6512545

4x
6401023

6x
4211526

1x
6186129

1x
6015349

7x
6510194

26x
6215659

2x
6348057

4x
6510060

4x
6528152

2x
6078605

1x
6170468

4x
6470170

3x
6313506

4x
4211189

4x
6522392

16x
6395635

5x
4211042

1x
4499858

1x
6133832

8x
6512546

10x
6452882

10x
6510518

6x
6273219

3x
6378109

22x
4109810

2x
6279875

8x
4253815

1x
4558957

1x
6393938

 [LEGO.com/service](https://www.LEGO.com/service)

8



YOU COULD WIN



YOU COULD WIN

Your feedback will help shape the future development of this product series.

Visit:

DU KÖNNTEST GEWINNEN

Dein Feedback trägt zur Weiterentwicklung dieser Produktreihe bei.

Geh auf:

VOUS POURRIEZ GAGNER

Vos commentaires nous aideront à concevoir les futurs produits de cette gamme.

Visitez :

POTRESTI VINCERE TU

La tua opinione ci aiuterà a migliorare la creazione futura di questa linea di prodotti.

Visita:

PUEDES GANAR

Tu opinión contribuirá al futuro de esta serie de productos.

Visita:

轻松获奖

您的反馈将有助于我们在今后改进本产品系列。

请访问：

LEGO.com/productfeedback

You also have the chance to win a LEGO® set.

Terms and conditions apply.*

Außerdem hast du die Chance, ein LEGO® Set zu gewinnen.

Es gelten die Teilnahmebedingungen.*

Vous pourriez également gagner un ensemble LEGO®.

Des conditions s'appliquent.*

Hai anche la possibilità di vincere un set LEGO®.

Termini e condizioni sono applicabili.*

También tienes la oportunidad de ganar un set LEGO®.

Aplican términos y condiciones.*

您还有机会赢取乐高®套装。

条款和条件适用。*

*LEGO.com/productfeedback-terms



LEGO and the LEGO logo are trademarks of the/sont des marques de commerce du/son marcas registradas de LEGO Group.
©2024 The LEGO Group. 6533549