

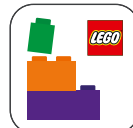

10368



Booklet available in English
Livret disponible en français
Folleto disponible en español



LEGO® Builder

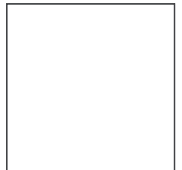

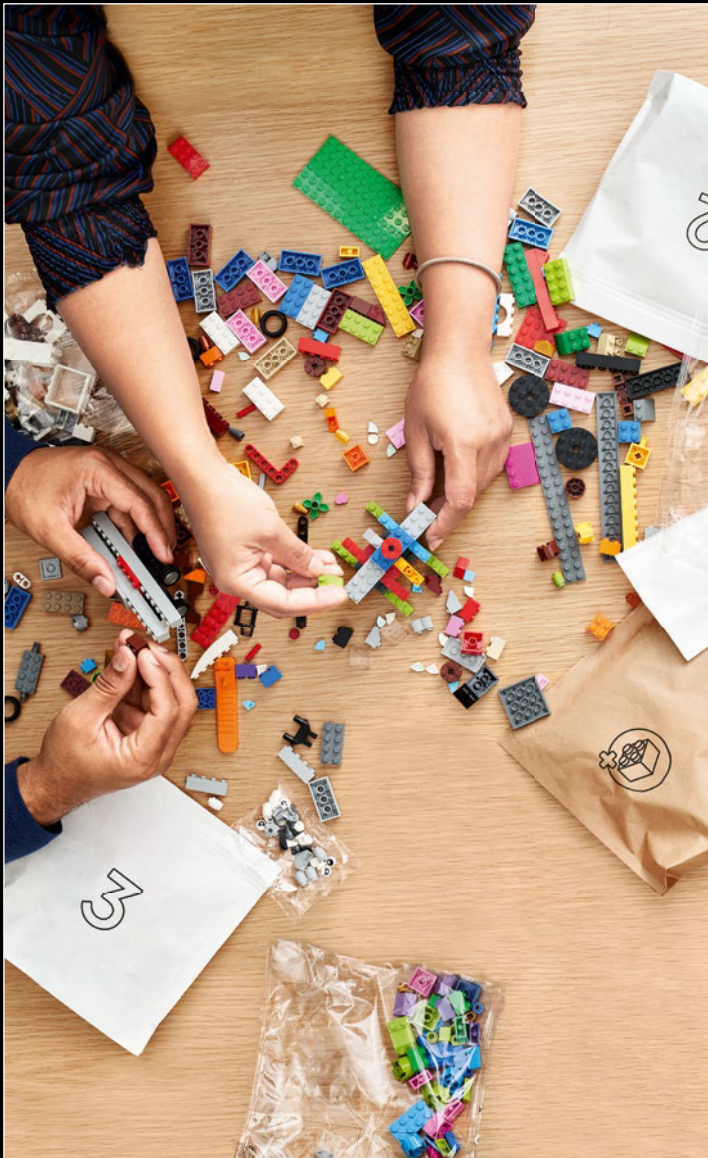

WE'RE MAKING OUR PACKAGING MORE SUSTAINABLE

We're transitioning from single-use plastic to paper-based packaging. As we progress, you may find a mix of paper and plastic in our boxes.

NOUS RENDONS NOS EMBALLAGES PLUS DURABLES

Nous passons des emballages en plastique à usage unique aux emballages à base de papier. Durant la transition, vous pourriez trouver un mélange de papier et de plastique dans nos boîtes.

QUEREMOS HACER MÁS SUSTENTABLES NUESTROS MATERIALES DE EMBALAJE

Estamos cambiando las bolsas de plástico desechables por bolsas con base de papel. Conforme avanzamos en este propósito, puedes encontrar una mezcla de papel y de plástico en nuestras cajas.

LEGO.com/sustainable-packaging



BUILDER



Apple and the Apple logo are trademarks of Apple Inc., registered in the U.S. and other countries and regions. App Store is a service mark of Apple Inc. Google Play and the Google Play logo are trademarks of Google LLC. Tencent and the Tencent logo are trademarks of Tencent Inc.

Q [LEGO.com/devicecheck](https://www.lego.com/devicecheck)



Q LEGO® Builder



THE FOUR GENTLEMEN
LES QUATRE GENTILSHOMMES
LOS CUATRO CABALLEROS



CHRYSANTHEMUM

The delicate yet vibrant chrysanthemum is often seen as a popular motif in traditional art. In a tradition that spans more than a thousand years, it is often portrayed in ink and wash paintings as part of a classic quartet of beautiful plants known as The Four Gentlemen, or the Four Noble Ones. Together, they represent the virtues and continuous circle of the seasons: The chrysanthemum (autumn), the plum (winter), the orchid (spring) and the bamboo (summer). Just as the chrysanthemum thrives in the face of winter, it gently inspires us to share joy and withstand adversity.

LE CHRYSANTHÈME

Le chrysanthème, à la fois délicat et éclatant, est un motif populaire dans l'art traditionnel. Dans une tradition qui remonte à plus de mille ans, il est souvent représenté dans des peintures à l'encre et au lavis comme faisant partie d'un quatuor classique de belles plantes connu sous le nom des « quatre gentilshommes » ou des « quatre nobles plantes ». Ensemble, elles représentent les vertus et le cercle continu des saisons : le chrysanthème (l'automne), le prunier (l'hiver), l'orchidée (le printemps) et le bambou (l'été). Comme le chrysanthème pousse en dépit du temps froid, il nous inspire chaleureusement à partager la joie et à résister à l'adversité.

CRISANTEMO

El delicado pero vibrante crisantemo suele ser un motivo popular en el arte tradicional. En una tradición que abarca más de mil años, con frecuencia lo vemos representado en pinturas de tinta y aguada como parte de un cuarteto clásico de bellas plantas conocido como *los cuatro caballeros* o *los cuatro nobles*. Juntas, representan las virtudes y el ciclo continuo de las estaciones: el crisantemo (otoño), el ciruelo (invierno), la orquídea (primavera) y el bambú (verano). El hecho de que el crisantemo salga adelante frente al embate del invierno nos inspira sutilmente a compartir la alegría y a resistir la adversidad.



ART IMITATES NATURE

Creating decor that draws inspiration from nature is a relaxing and rewarding way to set our imagination free. Plants are particularly interesting to study and replicate. You can find symmetry and seemingly random variants and organic shapes developing in perfect balance. It's no wonder artists in every culture are drawn to these motifs. This chrysanthemum bouquet in its vase shows the different stages of the flower, from buds to full bloom. It brings a refreshing pop of color to your favorite space, and with poseable leaves and petals, you can rearrange your bouquet to change the expression of your display.

THEO BONNER,
LEGO® Model Designer





L'ART IMITE LA NATURE

La création de décors inspirés de la nature est un moyen relaxant et gratifiant de laisser libre cours à notre imagination. Les plantes sont particulièrement intéressantes à étudier et à reproduire. On y trouve des symétries, des variantes apparemment aléatoires et des formes organiques qui se développent en parfait équilibre. Il n'est pas étonnant que les artistes de toutes les cultures soient attirés par ces motifs. Ce bouquet de chrysanthèmes dans son vase montre les différents stades de la fleur, des bourgeons à la pleine floraison. Il apportera une touche de couleur rafraîchissante à votre espace préféré, et grâce aux feuilles et aux pétales mobiles, vous pouvez réarranger votre bouquet pour changer l'expression de votre décoration.

THEO BONNER,
concepteur de modèles LEGO®

EL ARTE IMITA A LA NATURALEZA

Crear un elemento decorativo inspirado en la naturaleza es una manera relajante y satisfactoria de dar rienda suelta a nuestra imaginación. Las plantas son un tema especialmente interesante para estudiar y reproducir. En ellas puedes encontrar tanto simetría como variantes aparentemente aleatorias y formas orgánicas que se desarrollan en perfecto equilibrio. No es de extrañar que artistas de todas las culturas se sientan atraídos por estos motivos. Este ramo de crisantemos en su florero muestra las distintas etapas de la flor, desde los capullos hasta la floración plena. Aporta un refrescante toque de color a tu espacio favorito, y sus hojas y pétalos articulados te ofrecen la posibilidad de reorganizar el ramo para cambiar la expresión de lo que exhibes.

THEO BONNER,
modelista de LEGO®

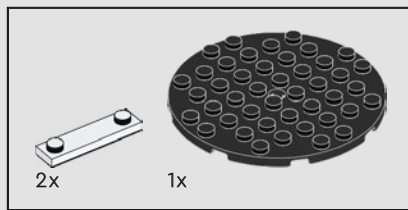

1

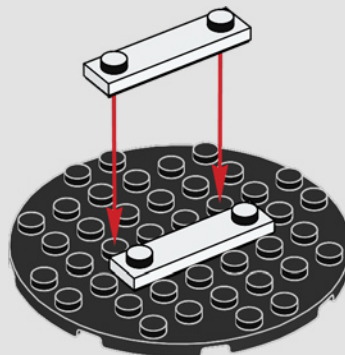

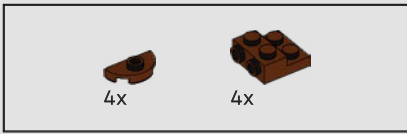

2

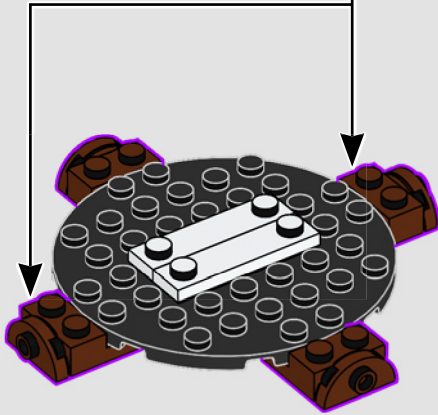
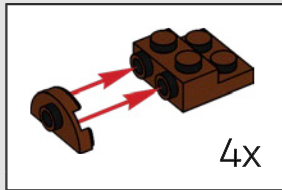

3

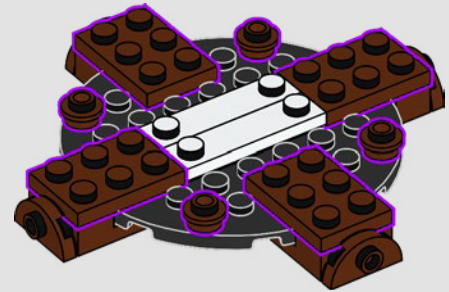

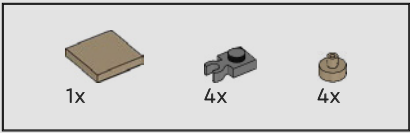

4

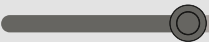
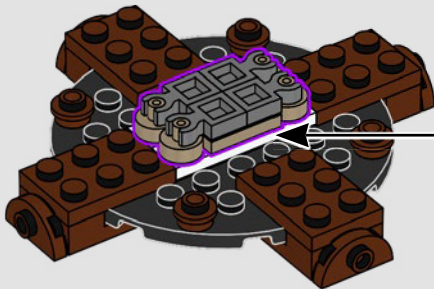
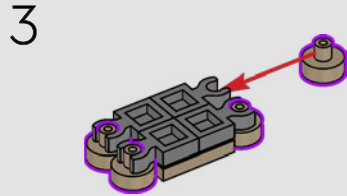
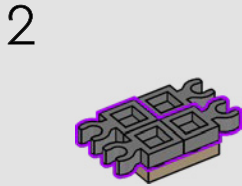
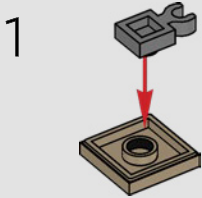

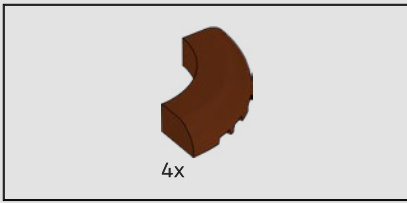

5

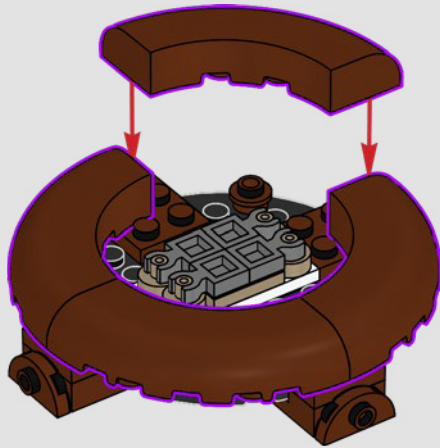

6

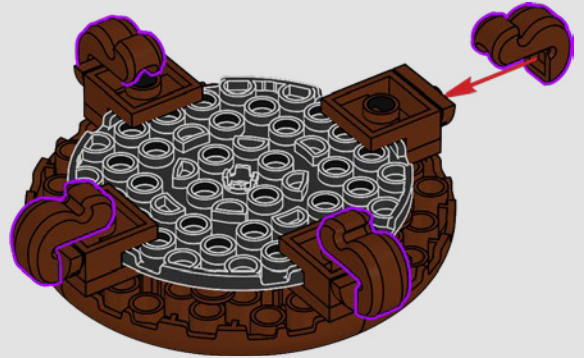
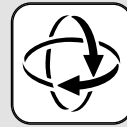

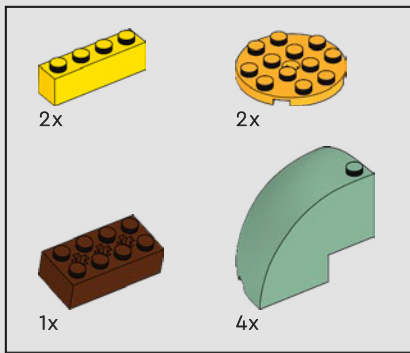

7

1

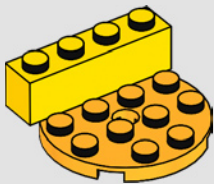

2

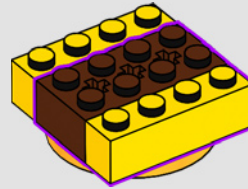

3

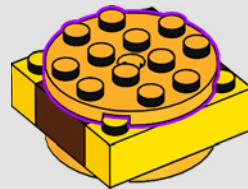

4

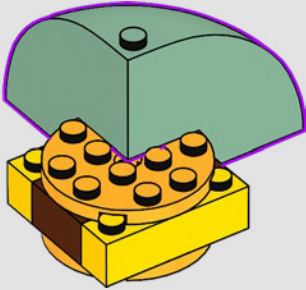

5

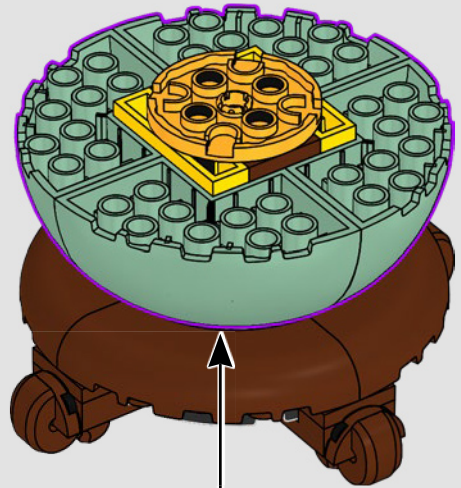
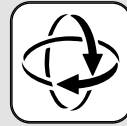
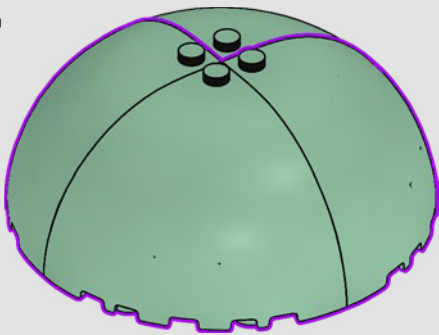

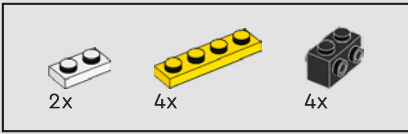

8

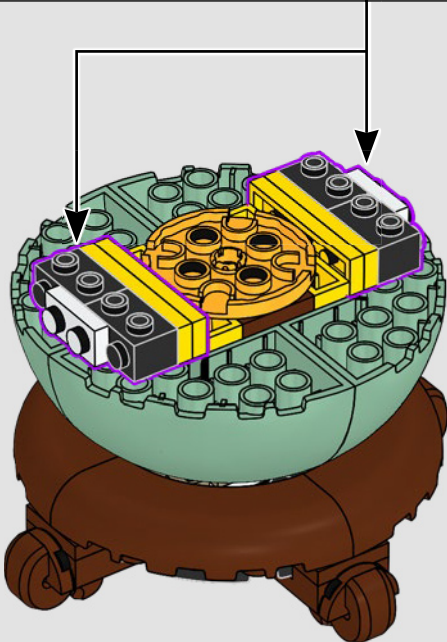
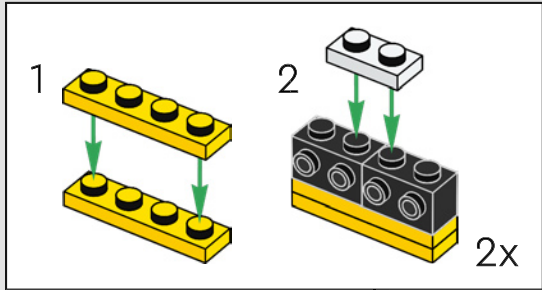

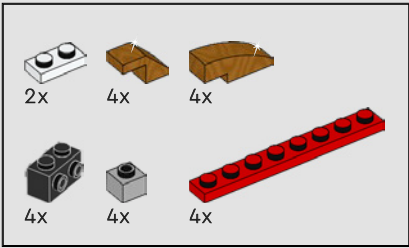

9

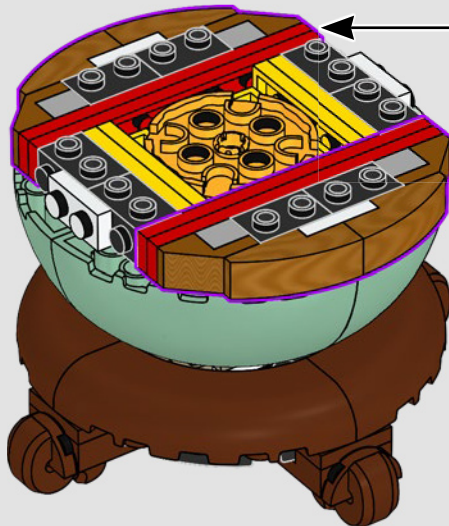
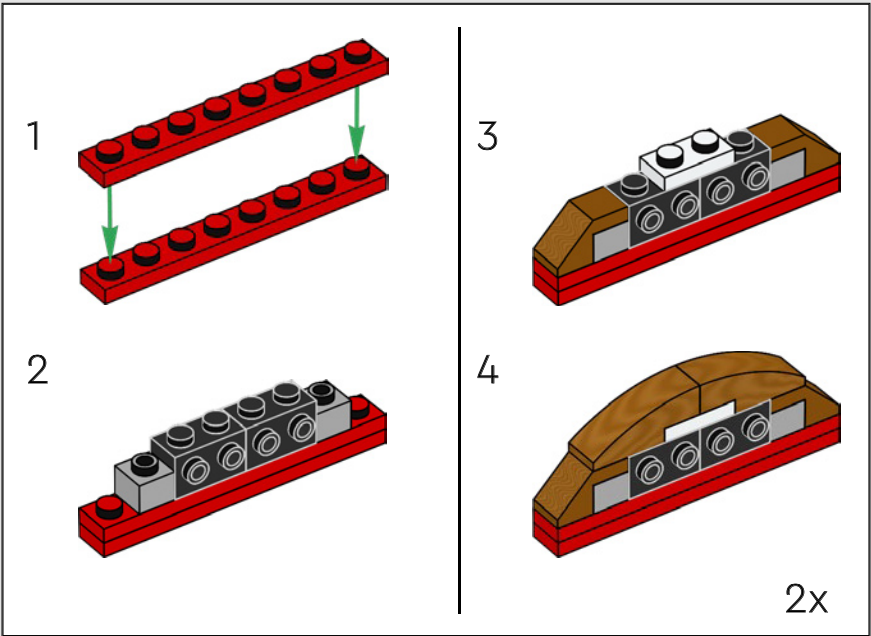

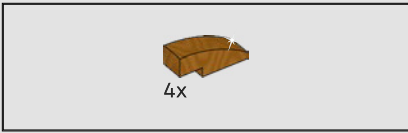

10

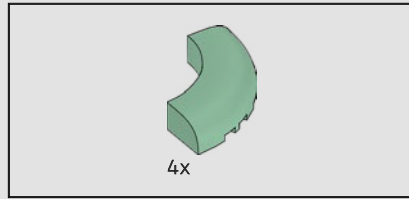
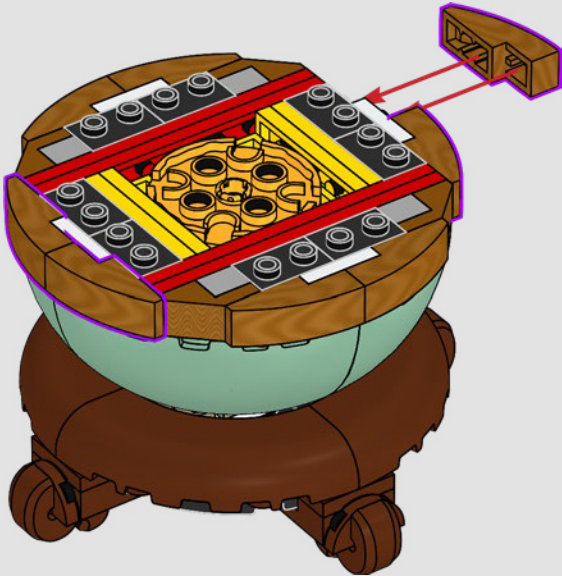

11

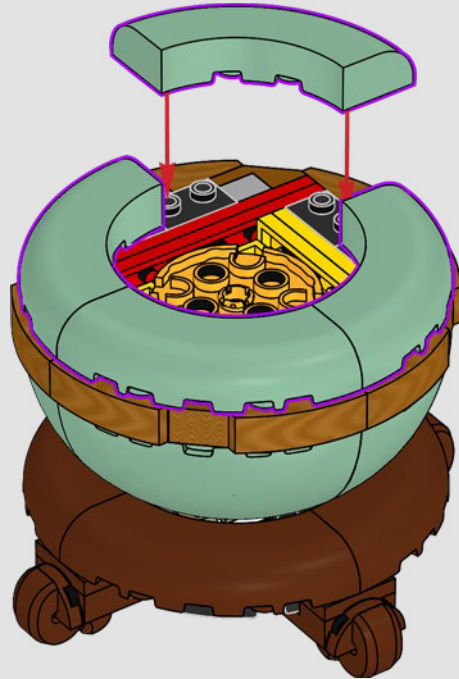

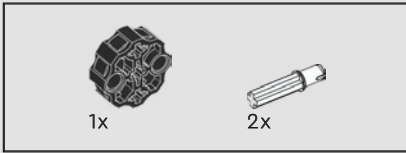
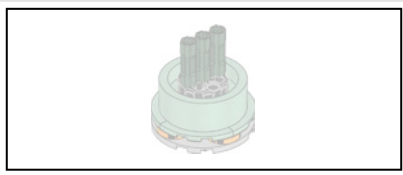

12

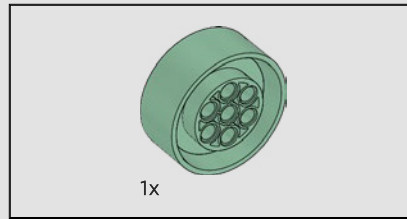
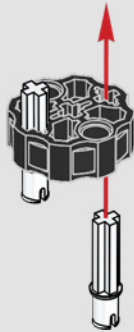

13

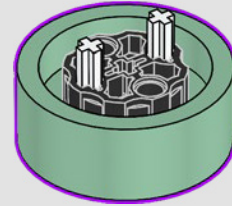

14

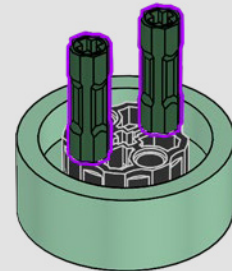

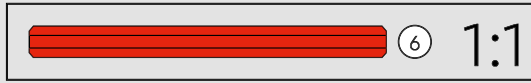
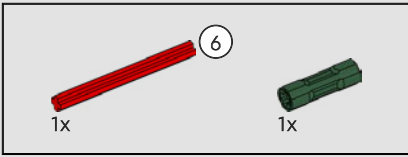

15

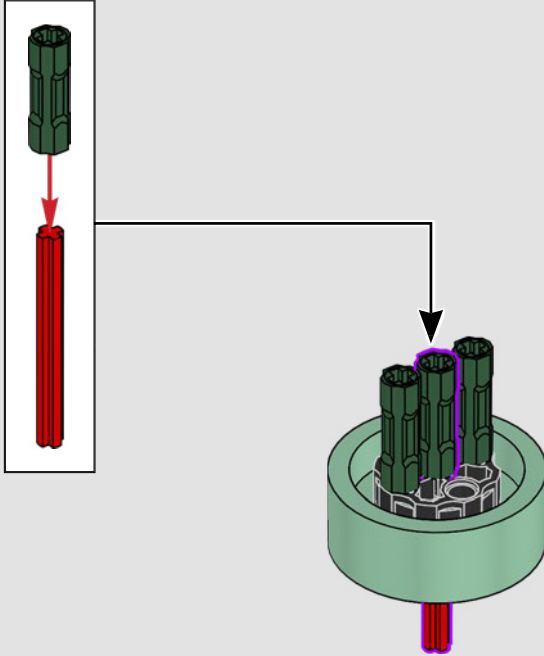

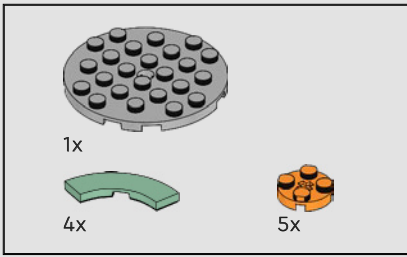

16

1

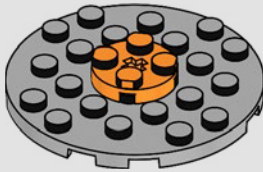

2

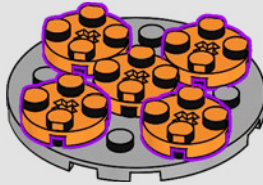

3

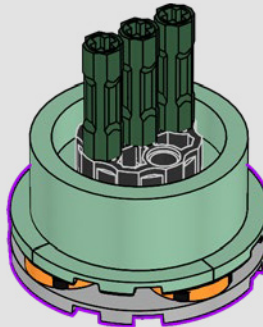
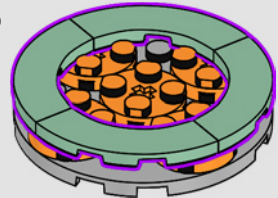

17

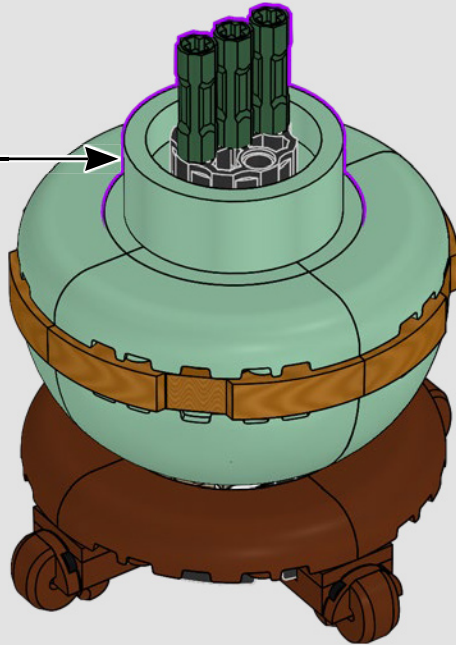

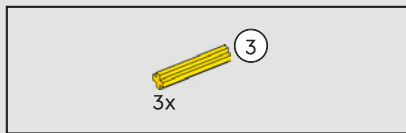

18

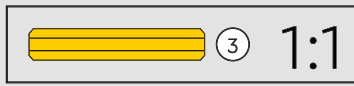
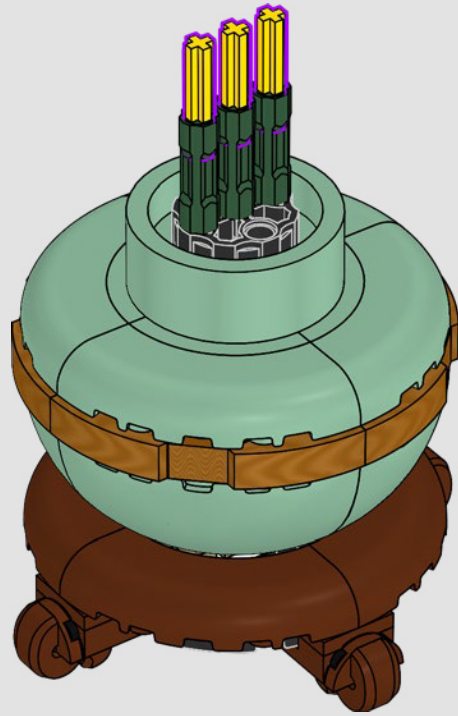



19

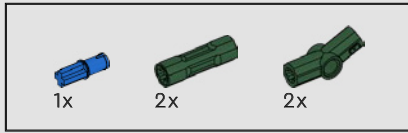
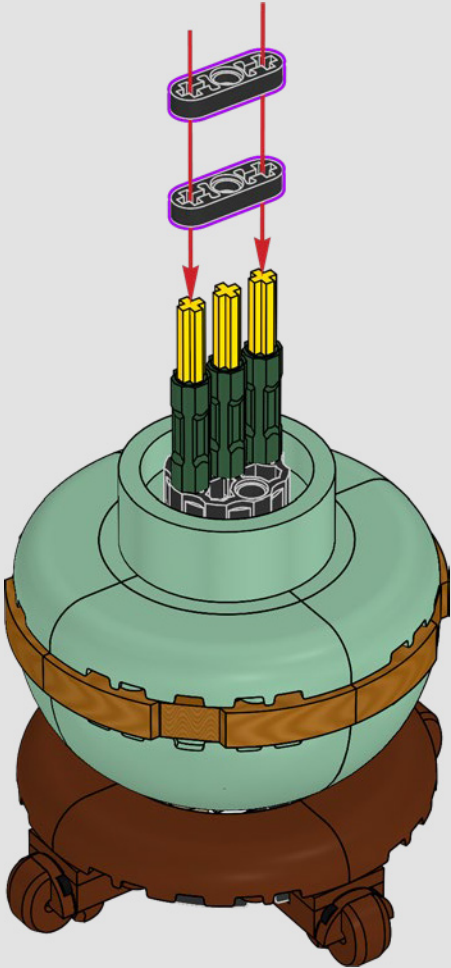

20

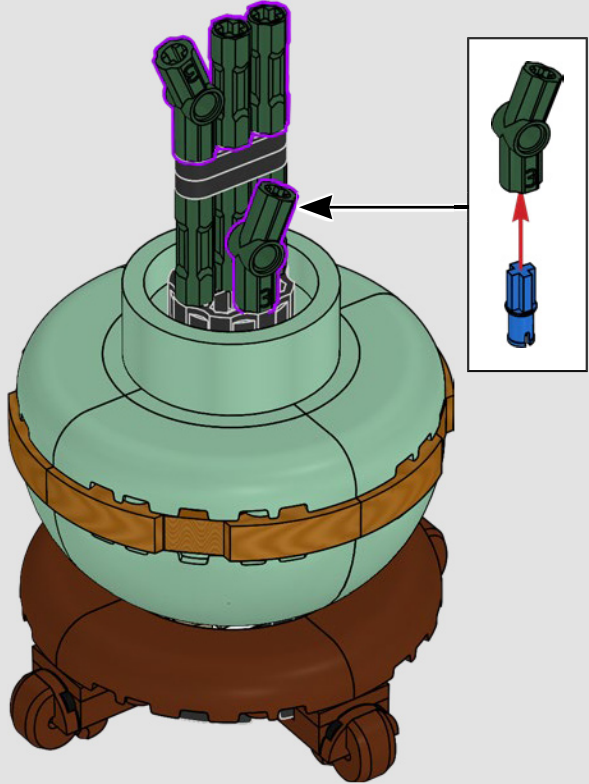

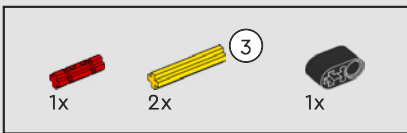

21

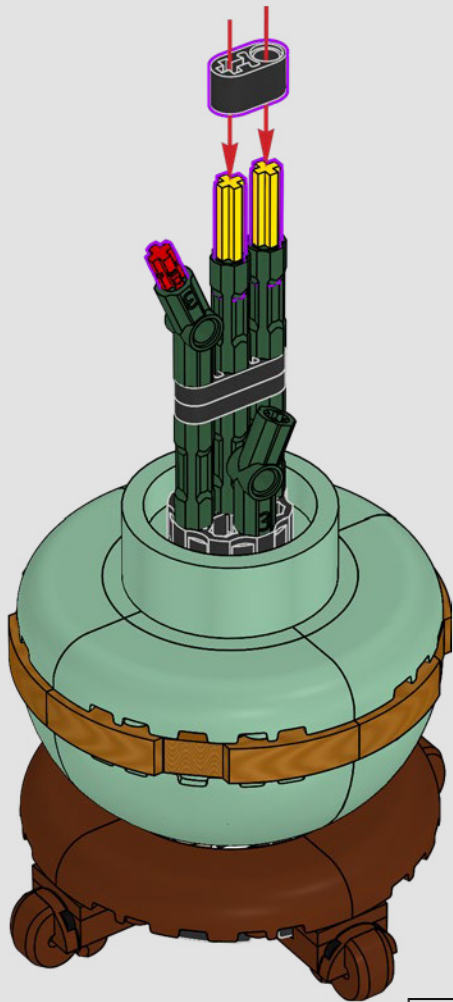

22

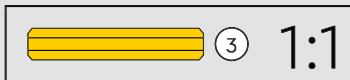
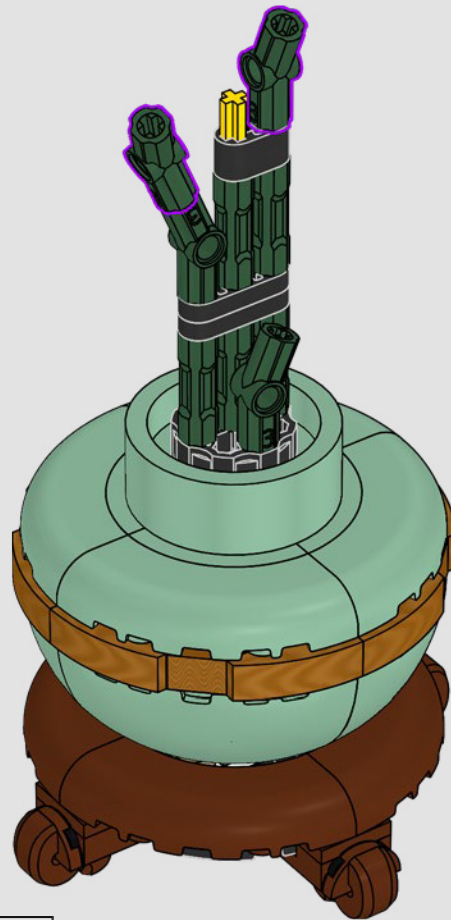

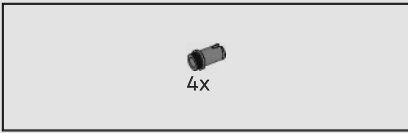

23

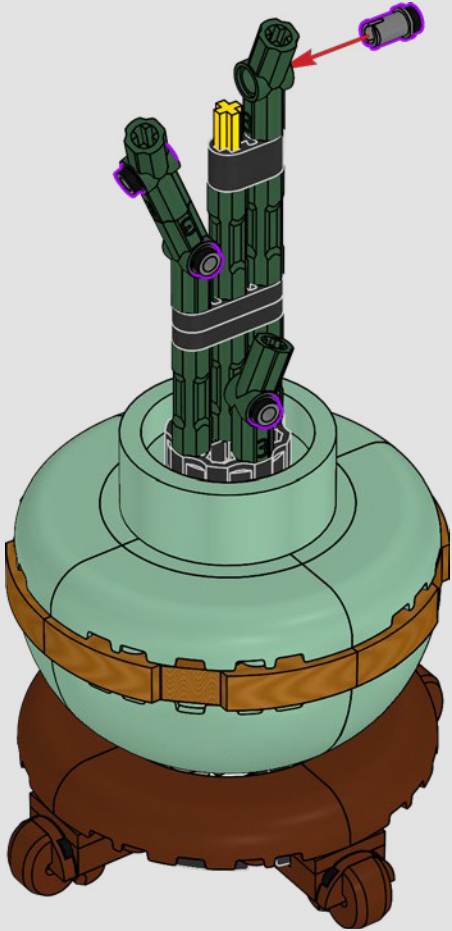

24

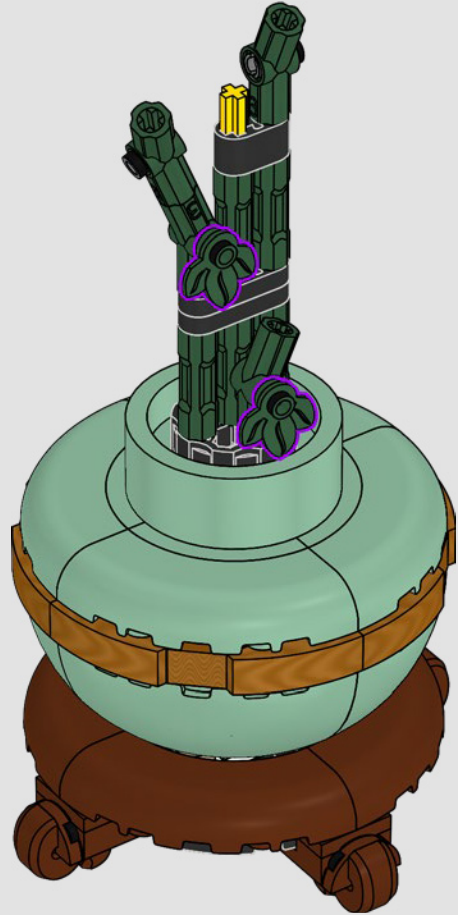

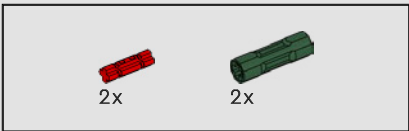

25

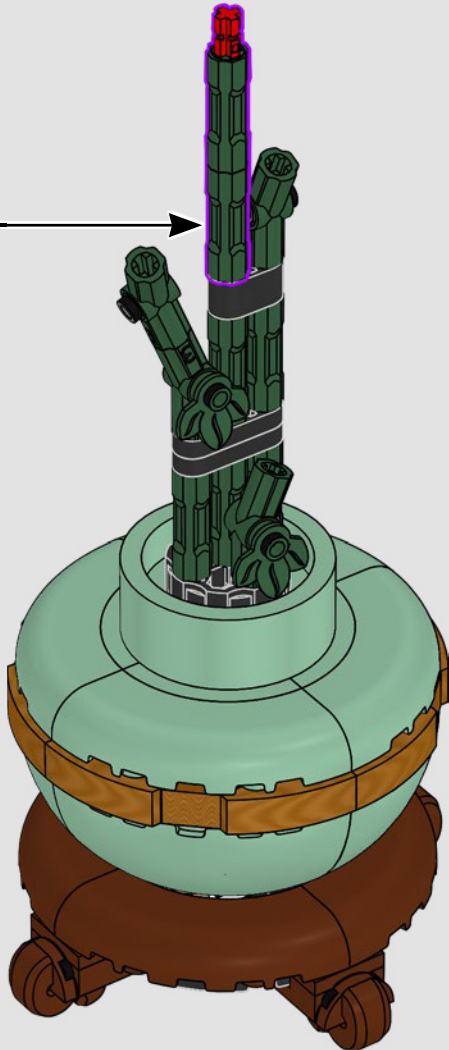
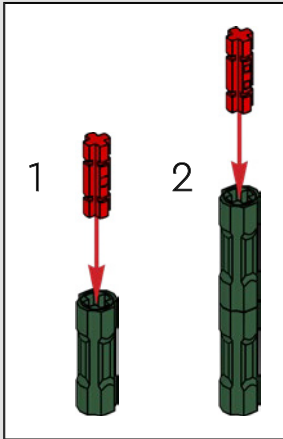

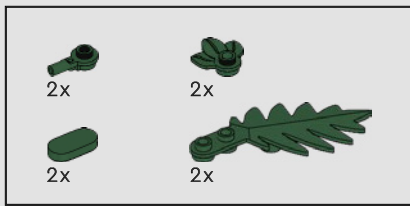

26

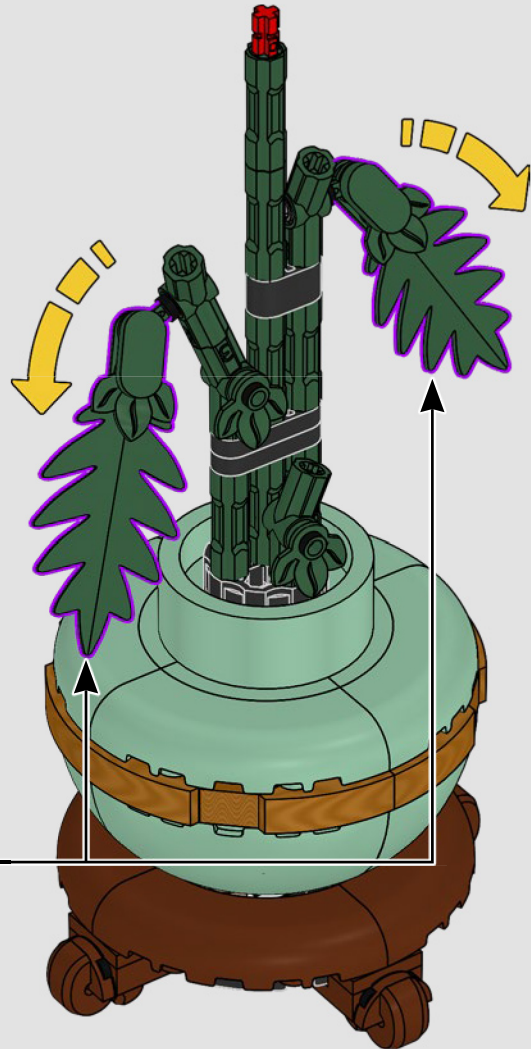
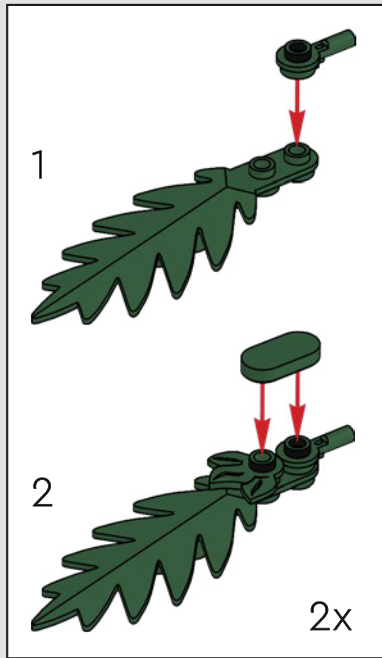

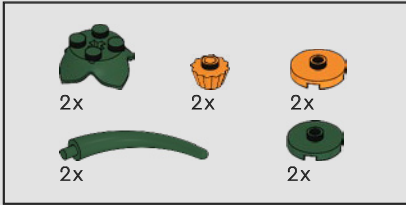
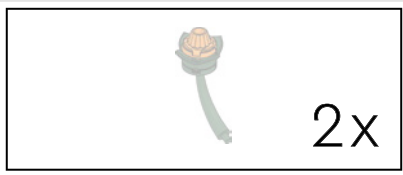

27

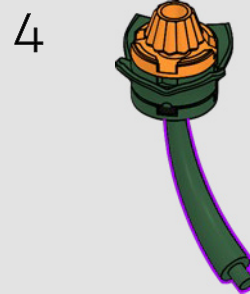
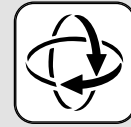
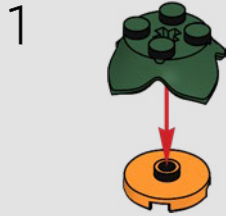

2x

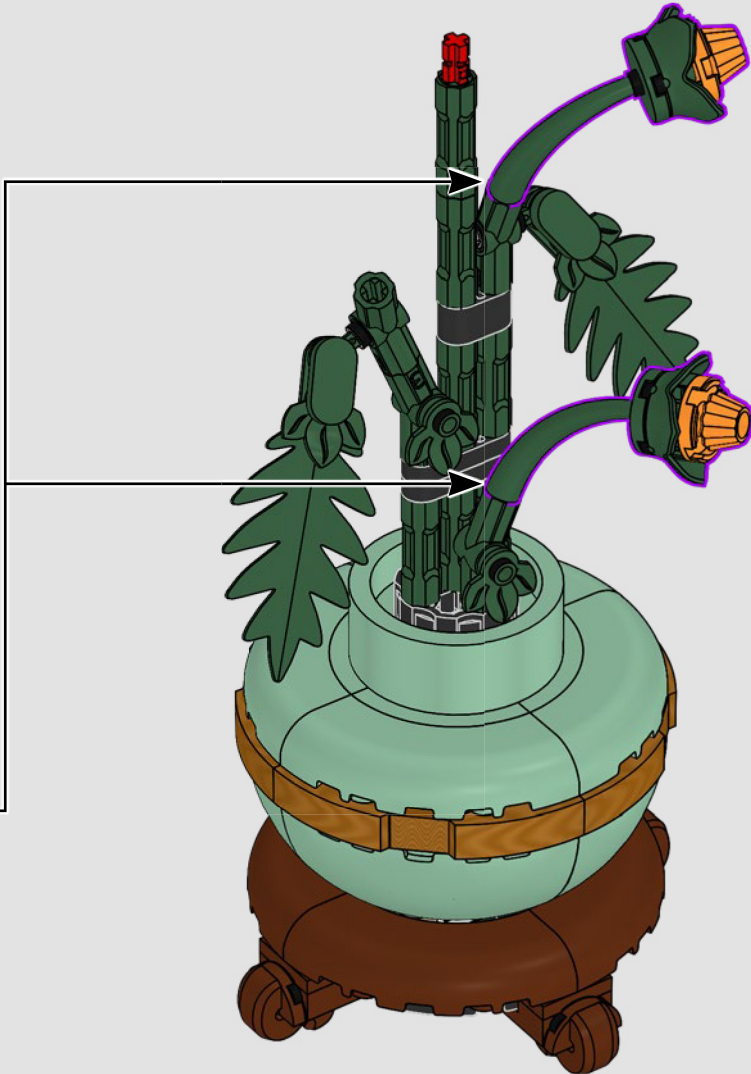

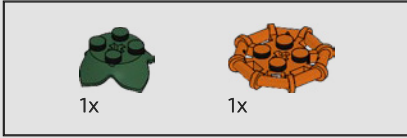

28

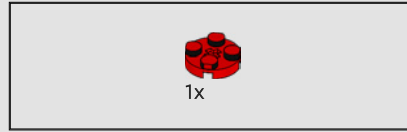
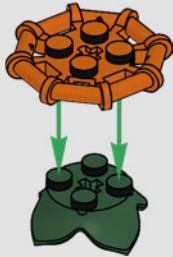

29

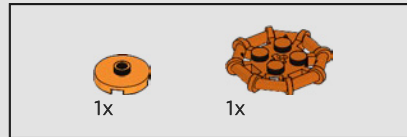
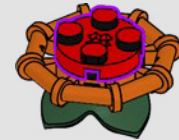

30

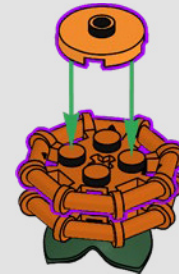



31

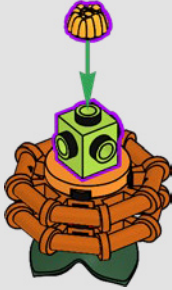

32

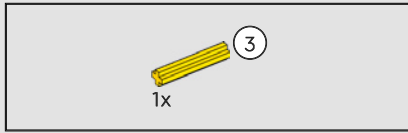
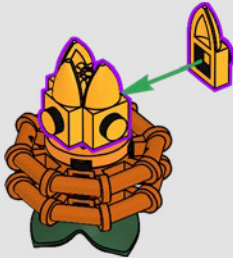

33

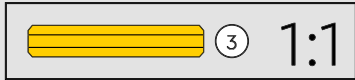
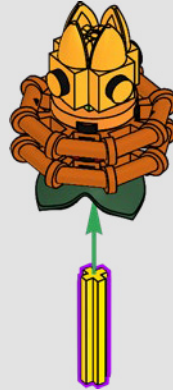



34



35



36





37

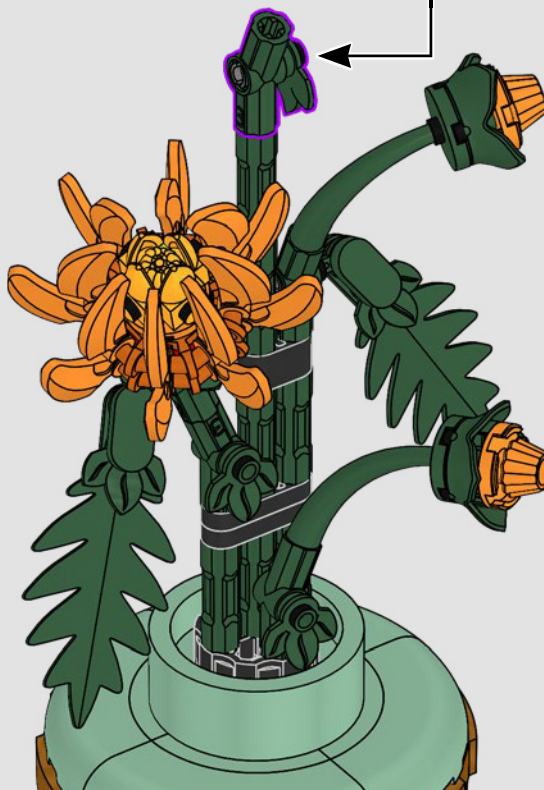
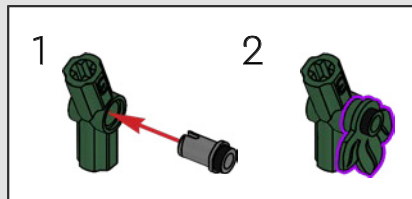

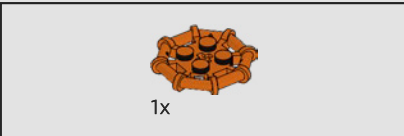

38

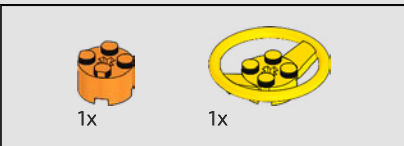

39

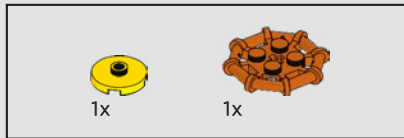
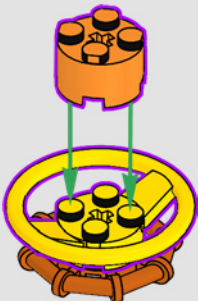

40

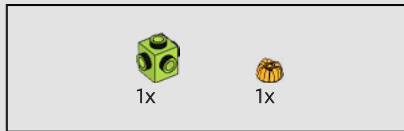

41

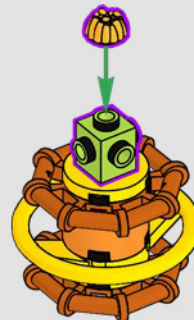



42

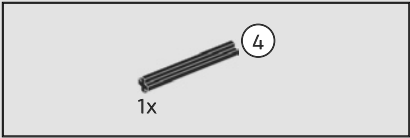
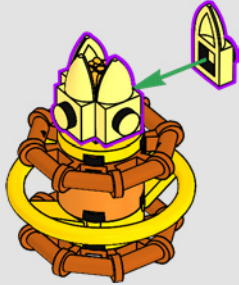

43

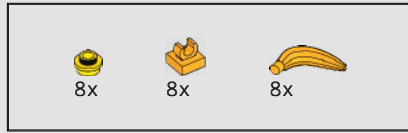
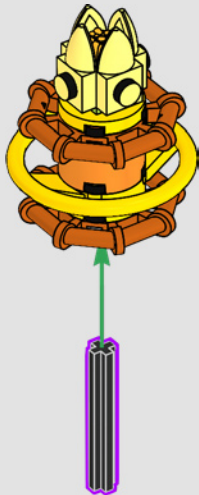

44

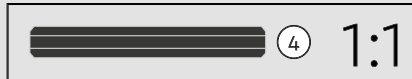
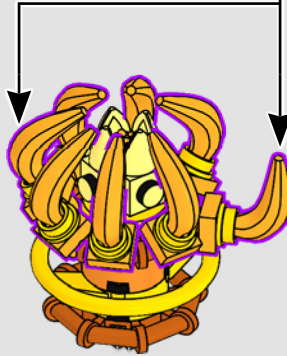
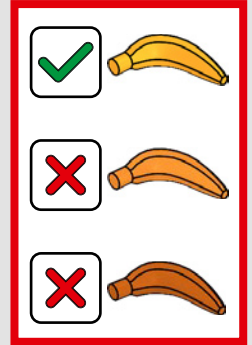
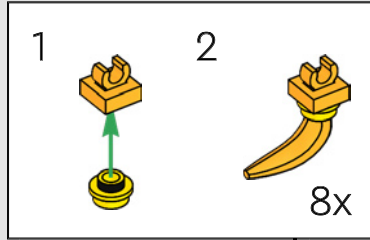



45

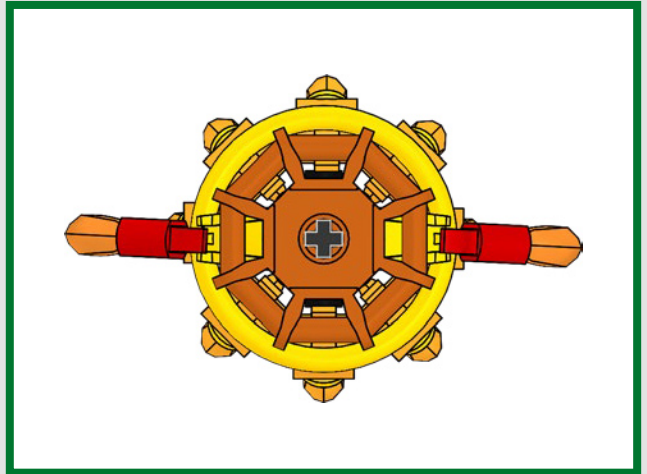
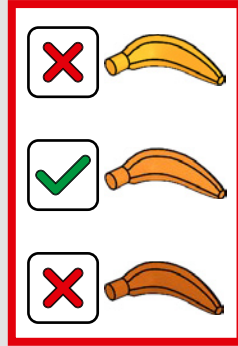
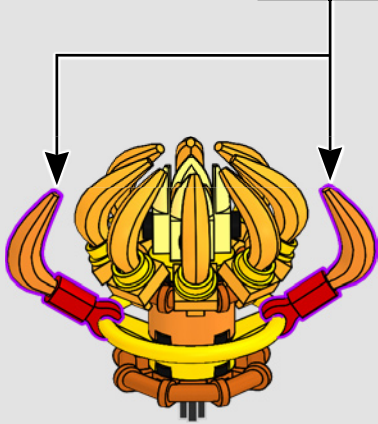
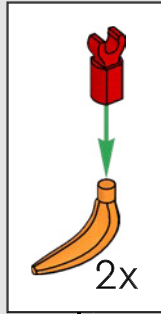



46

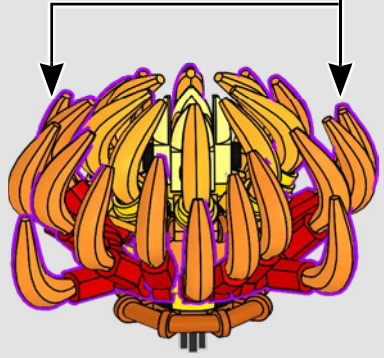
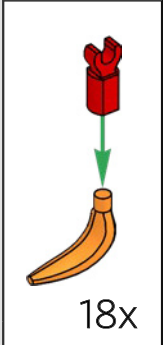
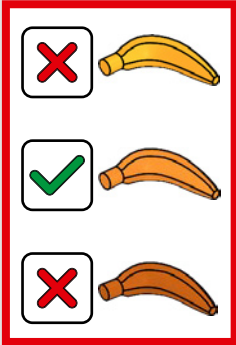

47

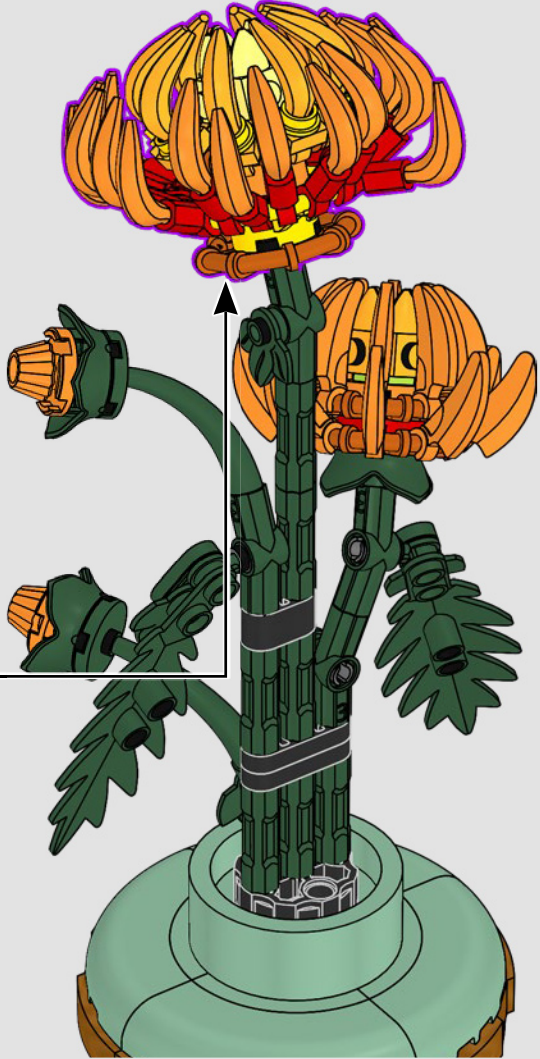
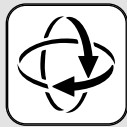

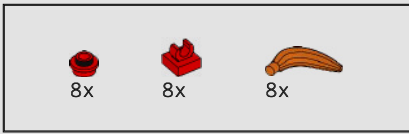

48

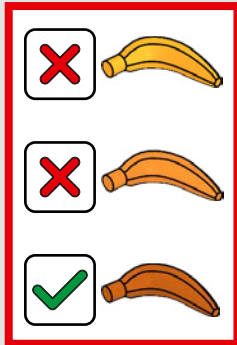
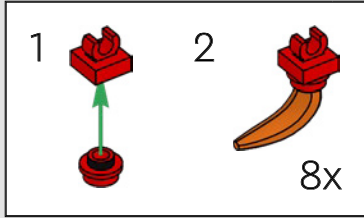



4x
302301



2x
6289797



2x
6249091



20x
6341972



8x
6223427



8x
6348058



3x
4142865



1x
403221

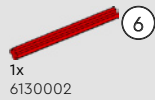

1x
6130002



4x
346021



1x
4206482



8x
6168644



2x
301024



1x
6389951



1x
6299764



6x
6130007



4x
371024



8x
4253815



1x
6265091



2x
6331723



1x
6186133

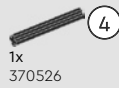

1x
370526



1x
6393938



3x
6109909



16x
6515186



2x
6510513



5x
6030521



1x
4141089



20x
6510516



2x
6174006



4x
6300320



1x
4507045



2x
6423382



2x
6392974



5x
6400754



2x
6512536



3x
6426730



5x
6344177



7x
6330196



2x
6512537



2x
6420219



4x
6522393



4x
6516370



4x
6441283

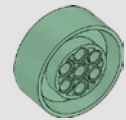

1x
6516369



2x
6456642



8x
6262140



4x
4282860



8x
6512533

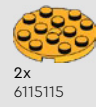

2x
6115115



4x
6215659



4x
6510060



4x
6528152



4x
6470170



4x
6522392



4x
4211189



1x
6365882



4x
6401023



1x
6015349



5x
6395635



4x
6296892



4x
6463587



4x
6404402



8x
6516372



8x
6512538



4x
6510511

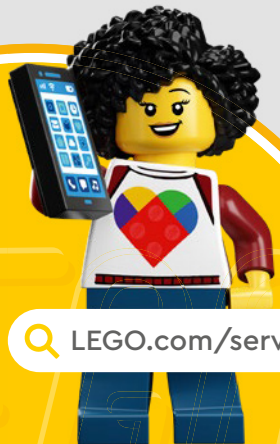

 [LEGO.com/service](https://www.LEGO.com/service)



FEEDBACK & REWARD



FEEDBACK AND REWARD

Your feedback will help shape the future development of this product series.

Visit:

FEEDBACK MIT BONUS

Dein Feedback trägt zur Weiterentwicklung dieser Produktreihe bei.

Geh auf:

AVIS ET RÉCOMPENSE

Vos commentaires nous aideront à concevoir les futurs produits de cette gamme.

Visitez :

DAI LA TUA OPINIONE E VINCI

La tua opinione ci aiuterà a migliorare la creazione futura di questa linea di prodotti.

Visita:

RECOMPENSAMOS TU OPINIÓN

Tu opinión contribuirá al futuro de esta serie de productos.

Visita:

反馈有奖

您的反馈将有助于我们在今后改进本产品系列。

请访问：

LEGO.COM/PRODUCTSURVEY

Share your feedback and receive a free digital reward.

Teile dein Feedback und erhalte einen digitalen Bonus geschenkt.

Donnez votre avis et recevez une récompense numérique gratuite.

Condividi il tuo feedback e ricevi un premio digitale gratuito.

Comparte tu opinión y recibe una recompensa digital gratis.

分享您的反馈意见，获取免费数字奖励。



LEGO and the LEGO logo are trademarks of the/sont des marques de commerce du/son marcas registradas de LEGO Group.
©2024 The LEGO Group. 6533547