



41839

6532678



I

1

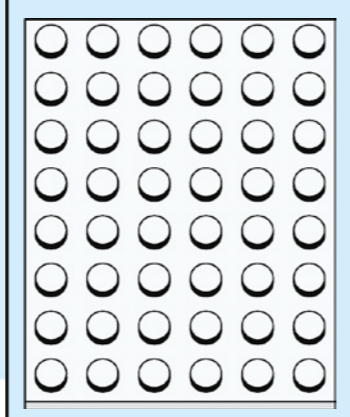

2

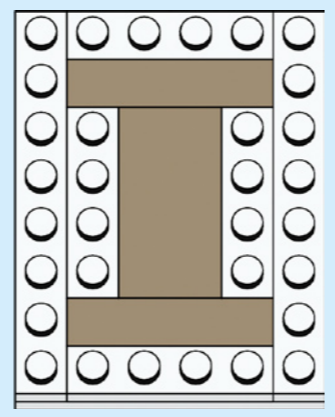

3

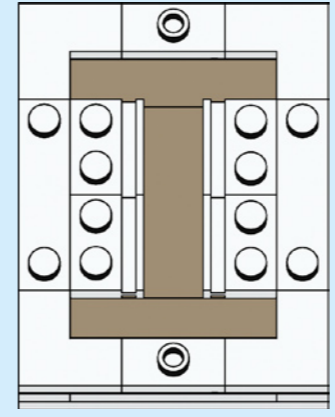

J

1

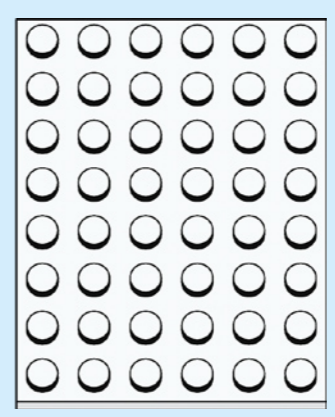

2

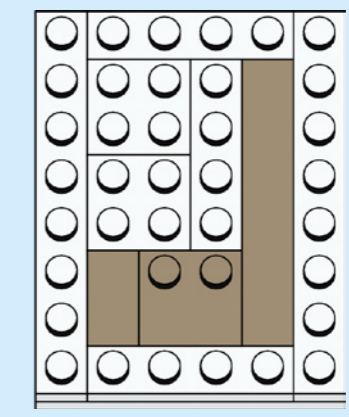

3

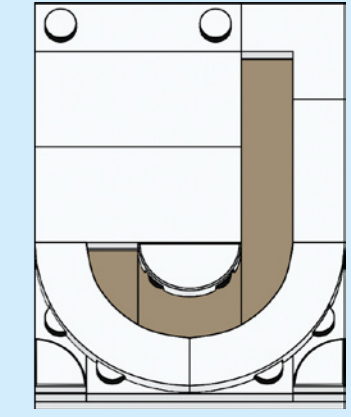

K

1

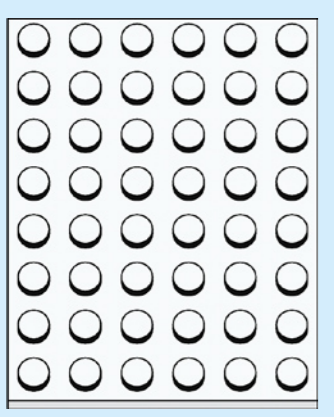

2

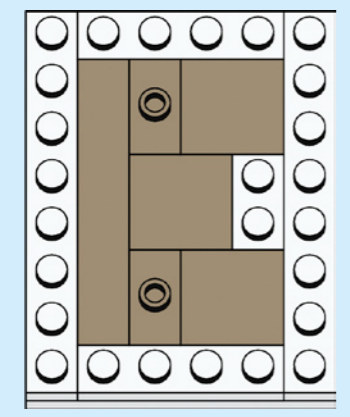

3

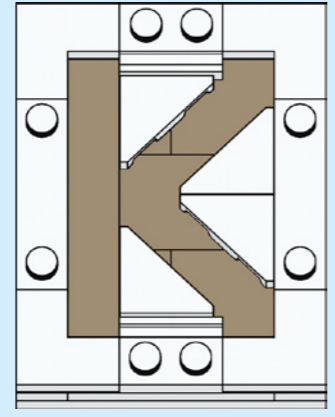

L

1

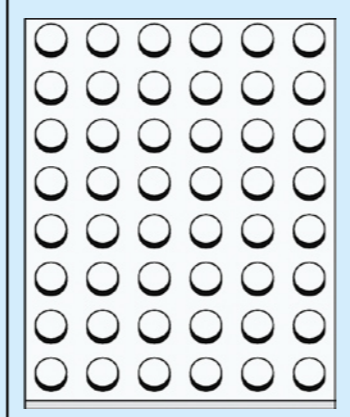

2

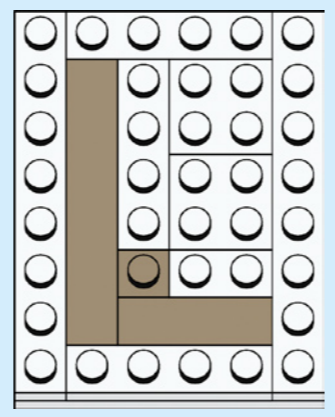

3

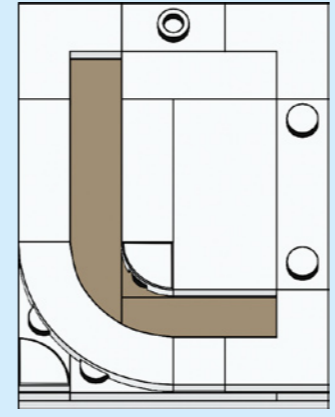

M

1

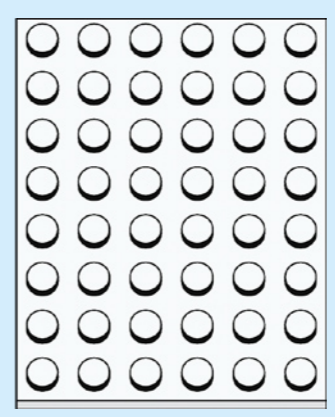

2

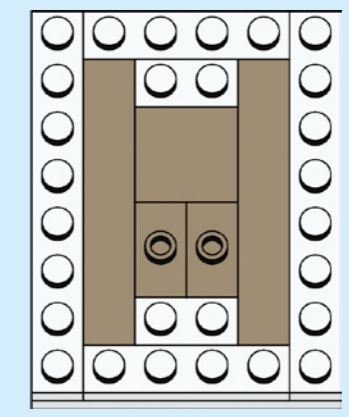

3

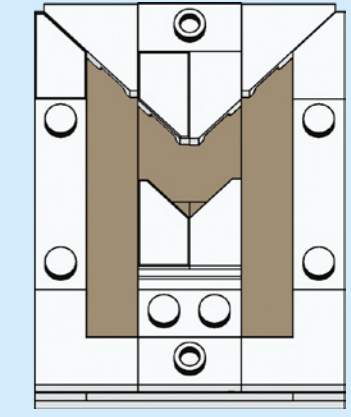

N

1

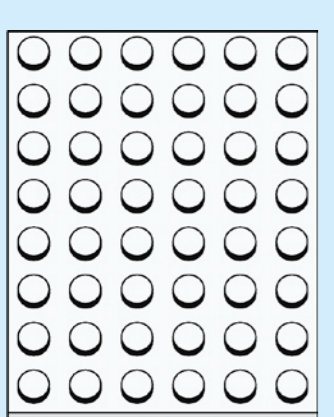

2

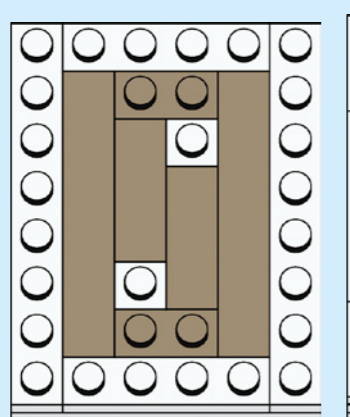

3

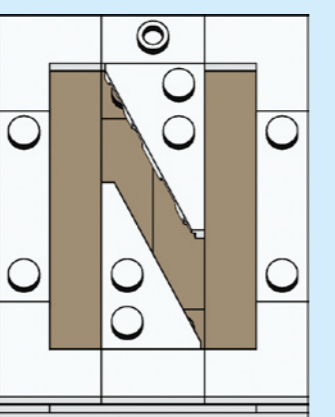

O

1

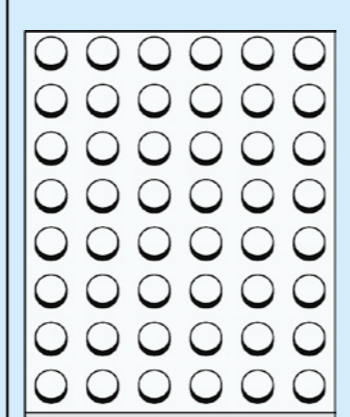

2

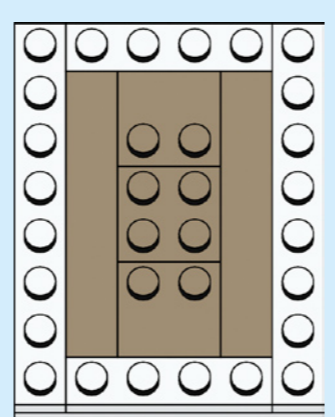

3

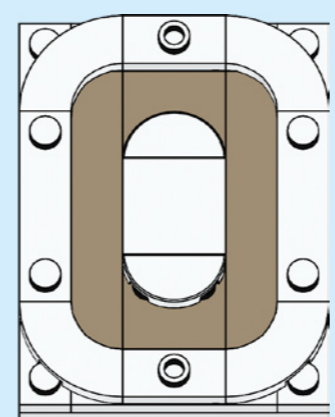

P

1

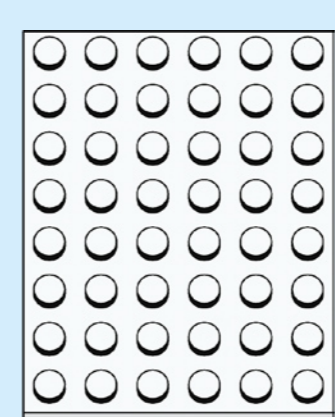

2

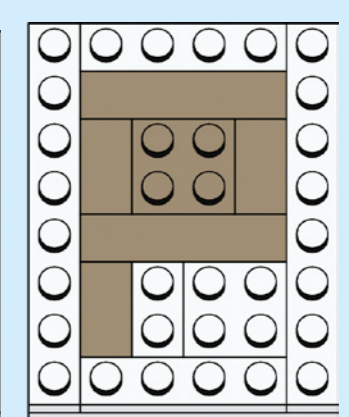

3

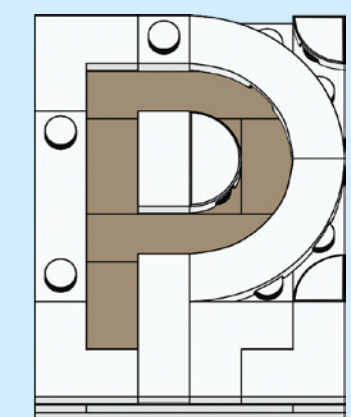



1

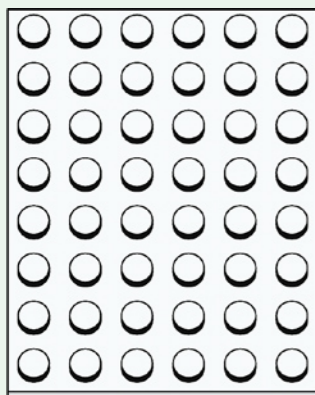

2

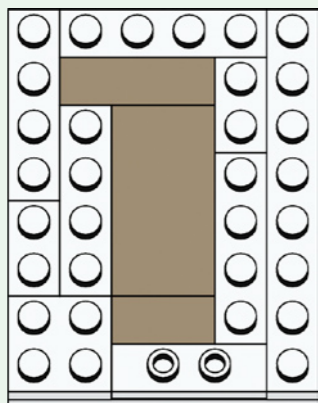

3

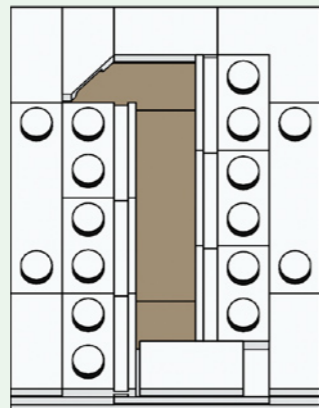

2

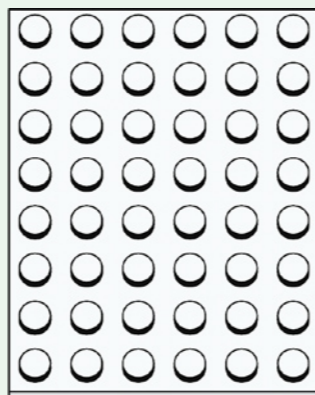

2

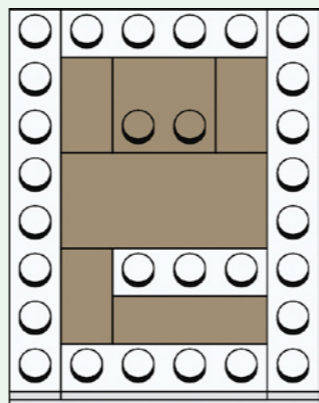

3

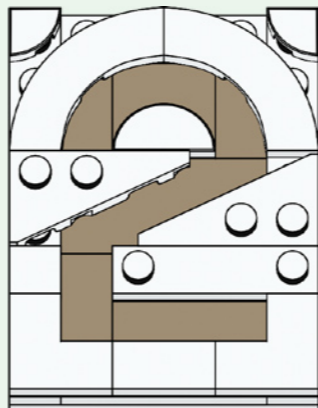

3

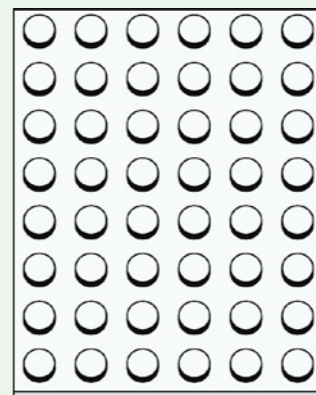

2

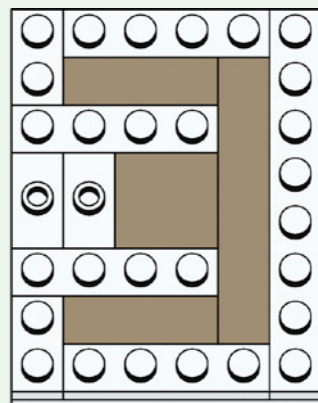

3

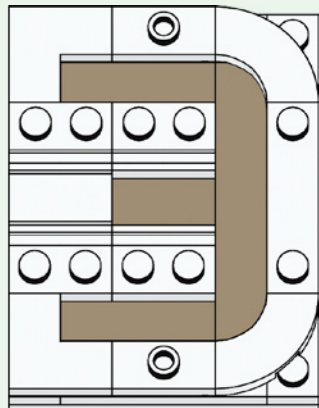

4

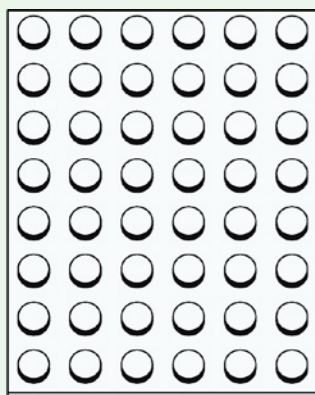

2

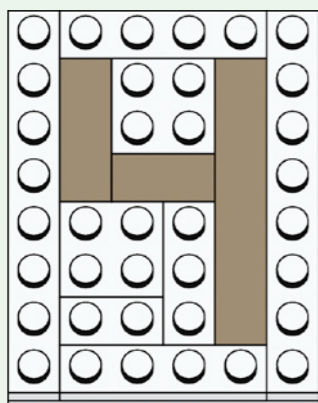

3

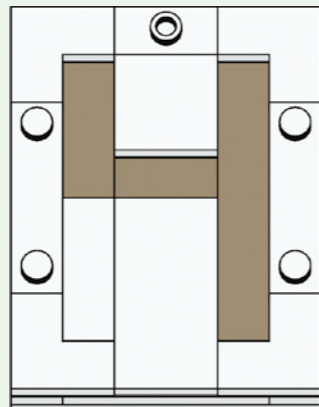

5

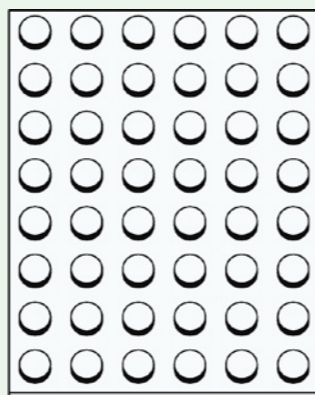

2

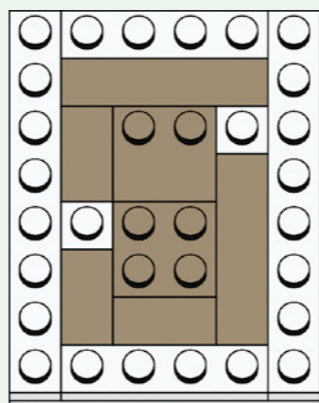

3

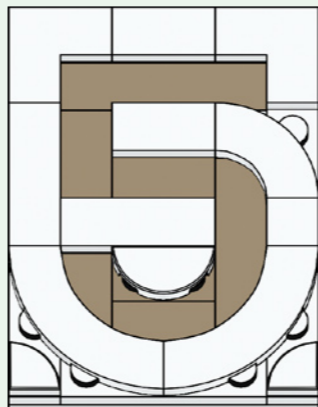

6

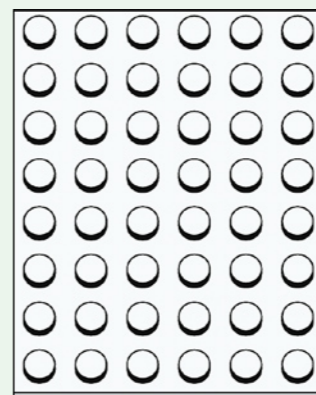

2

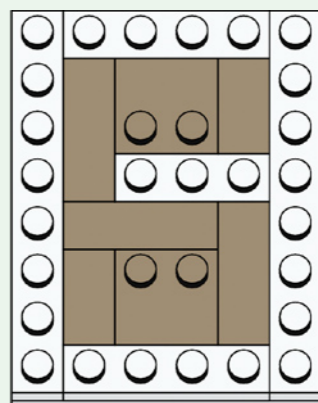

3

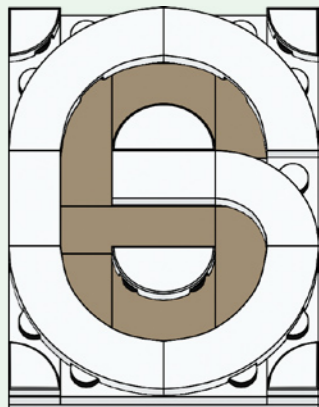

7

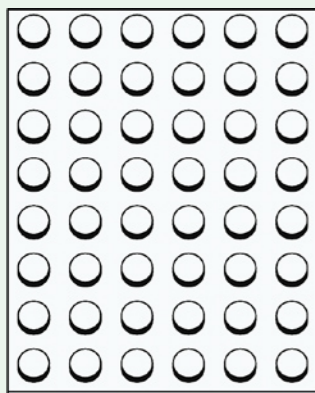

2

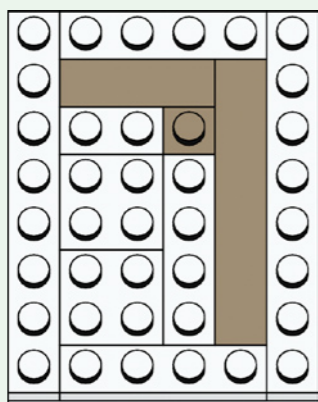

3

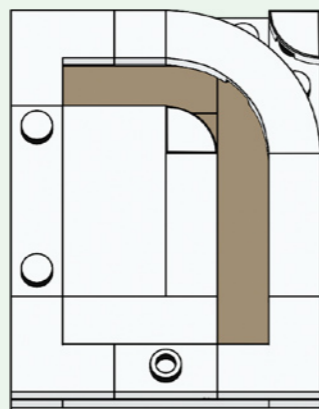

8

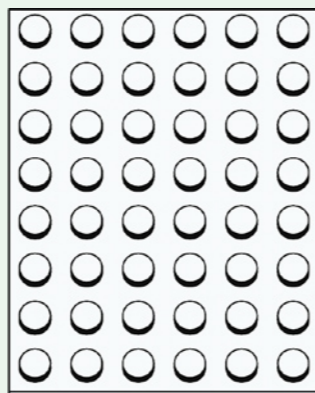

2

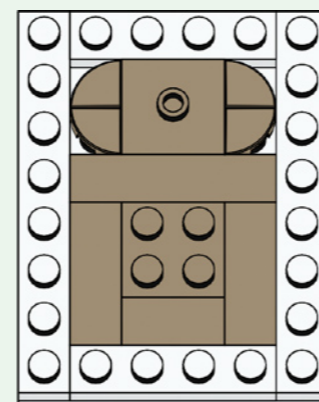

3

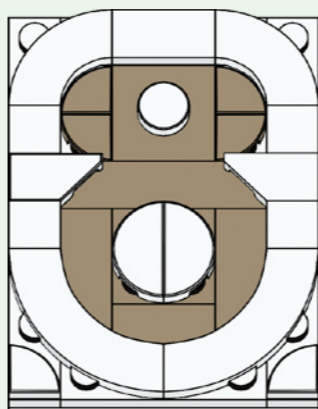

9

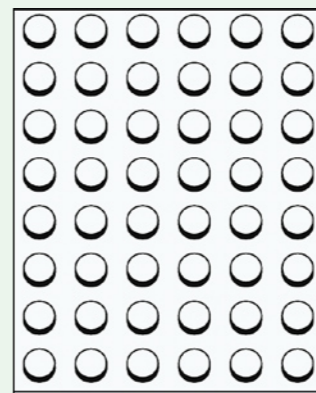

2

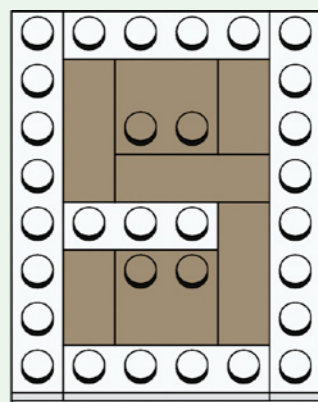

3

