



41838



14

15



### **Get excited about our new packaging!**

We're switching from plastic to paper-based packaging. That's why you might find a mix of paper and plastic in our boxes!

### **Nos nouveaux emballages vous emballeront !**

Nous passons des emballages en plastique aux emballages à base de papier. C'est pourquoi vous pourriez trouver un mélange de papier et de plastique dans nos boîtes !

### **¡Te presentamos nuestros nuevos empaques!**

Estamos sustituyendo las bolsas de plástico por bolsas con base de papel. ¡Por eso, puedes encontrar una mezcla de papel y de plástico en nuestras cajas!

**[LEGO.com/sustainable-packaging](https://www.lego.com/sustainable-packaging)**

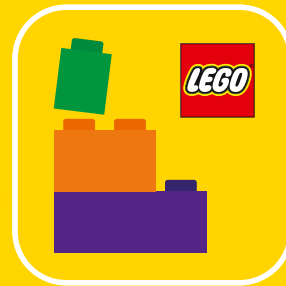

# BUILDER



Apple and the Apple logo are trademarks of Apple Inc., registered in the U.S. and other countries and regions. App Store is a service mark of Apple Inc. Google Play and the Google Play logo are trademarks of Google LLC. Tencent and the Tencent logo are trademarks of Tencent Inc.

LEGO.com/devicecheck

EN Ask parents' permission before going online | DE Eltern um Erlaubnis bitten, bevor du online gehst | FR Demande l'autorisation d'un parent avant d'aller en ligne | IT Chiedi il permesso ai tuoi genitori prima di andare online | ES Pídeles permiso a tus papás antes de conectarte a Internet | PT Peça autorização aos pais antes de acederes online | ZH 上网前应先征得父母的同意 | PL Poproś rodziców o zgodę, zanim wejdiesz do Internetu | CS Než půjdeš na internet, požádej rodiče o svolení | SK Skôr než pôjdeš na internet, vypýtaj si povolenie od rodičov | HU Kérj szülői engedélyt, mielőtt online csatlakoznál! | RO Cere permisiunea părinților înainte de a te conecta online | BG Поискайте разрешение от родител, преди да влезете онлайн | LV Pirms došanās tiešsaistē palūdz atļauju vecākiem | ET Enne Interneti kasutamist küsi vanematelt luba | LT Prieš prisijungdami prie interneto, atsklauskite tėvų



# Let the family fun take flight!

When you open up this LEGO® set, everyone is invited to create and play. So, gather your family, friends, partners, cousins, or neighbors, and fly off to new corners of your imagination together onboard your own World Wonderliner!



# Le plaisir en famille prend son envol !

Cet ensemble LEGO® invite tout le monde à créer et à jouer. Alors, réunissez votre famille, vos amis, vos cousins ou vos voisins, et envolez-vous vers de nouveaux recoins de votre imagination à bord de votre World Wonderliner !

# ¡Haz que la diversión familiar emprenda el vuelo!

Abrir este set LEGO® es sinónimo de una invitación a crear y jugar para todos. Así que reúne a tus familiares, amigos, pareja, primos o vecinos, ¡y vuelen juntos hacia nuevos rincones de la fantasía a bordo de su propio World Wonderliner!



## COMBINE AND CONQUER

*With five engaging builds, five intuitive building instructions booklets and five brick separators, this set is made to be social. Have even more builders? Try building in teams. Here, your combined creativity knows no borders, and everyone can play a part in creating a shared world.*

## COMBINEZ ET CONQUÉREZ

*Avec ses cinq constructions captivantes, ses cinq livrets d'instructions de construction intuitifs et ses cinq séparateurs de briques, cet ensemble est fait pour être partagé. Vous avez plus de constructeurs ? Essayez de construire en équipes. Ici, votre créativité combinée ne connaît pas de frontières, et chacun peut jouer un rôle dans la création d'un monde commun.*

## COMBINA Y CONQUISTA

*Con cinco atractivos modelos, cinco intuitivos folletos de instrucciones de construcción y cinco separadores de bricks, este set está diseñado como una experiencia social. ¿Hay aún más constructores? La posibilidad de participar por equipos siempre está sobre la mesa. No existen los límites para la creatividad combinada, ¡y así todos tienen algo que aportar a la creación de un mundo compartido!*

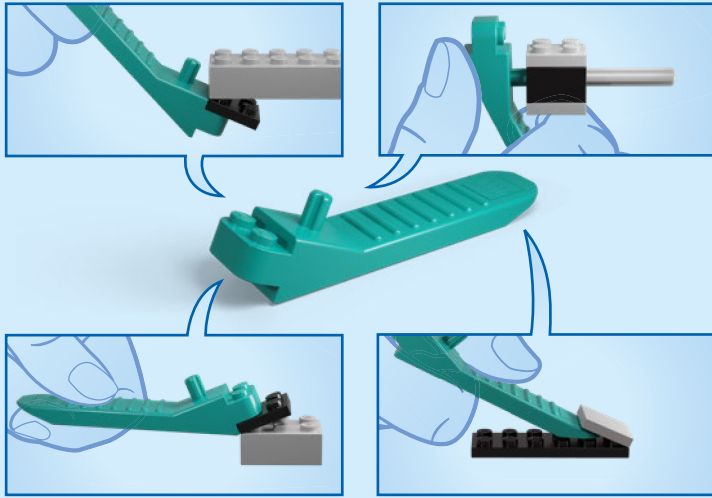

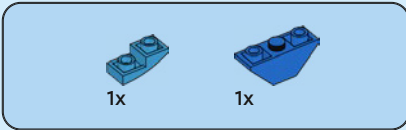
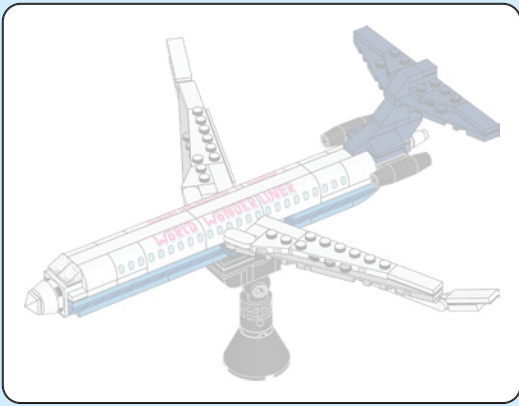

1

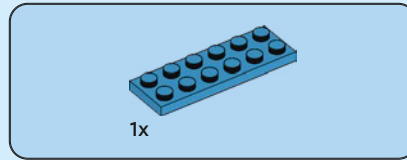
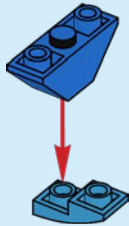

2

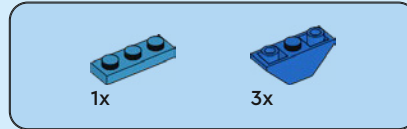
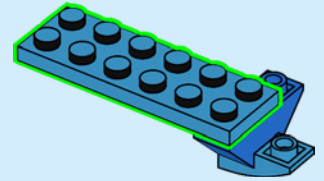

3

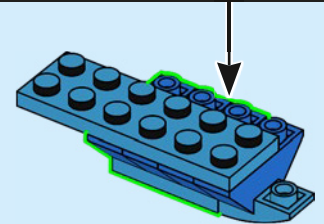
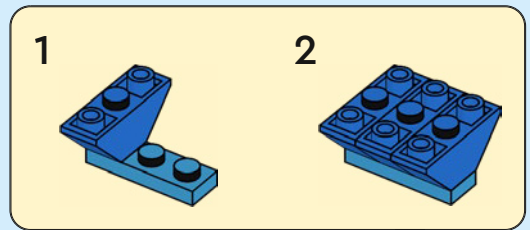

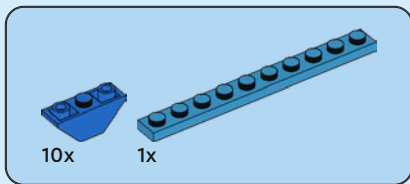

4

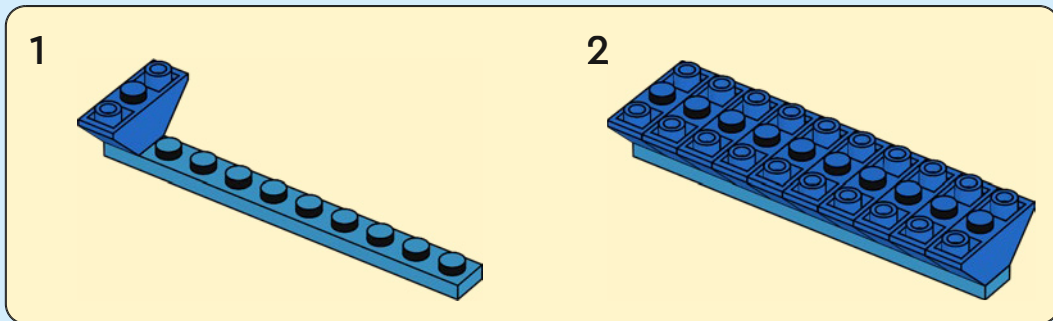

2

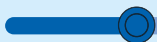
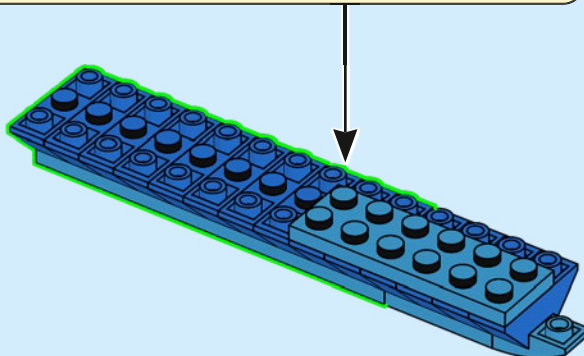
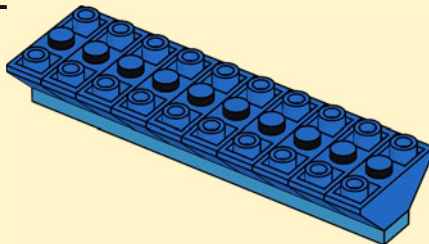



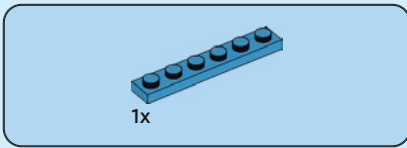

5

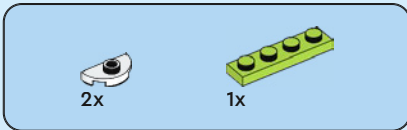
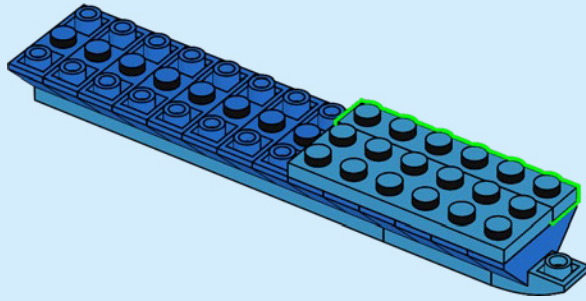

6

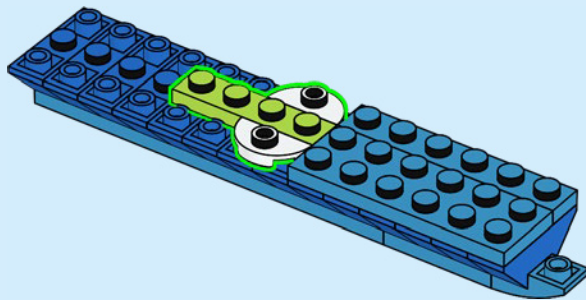

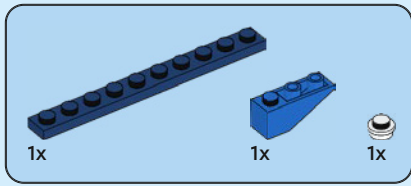

7

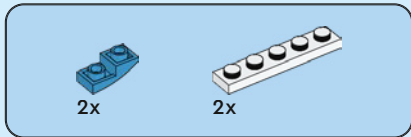
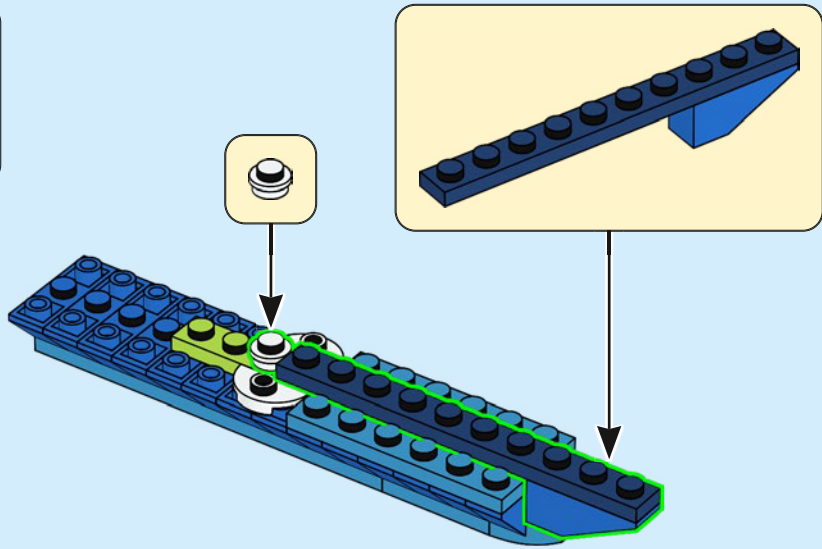

8

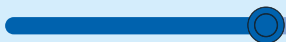
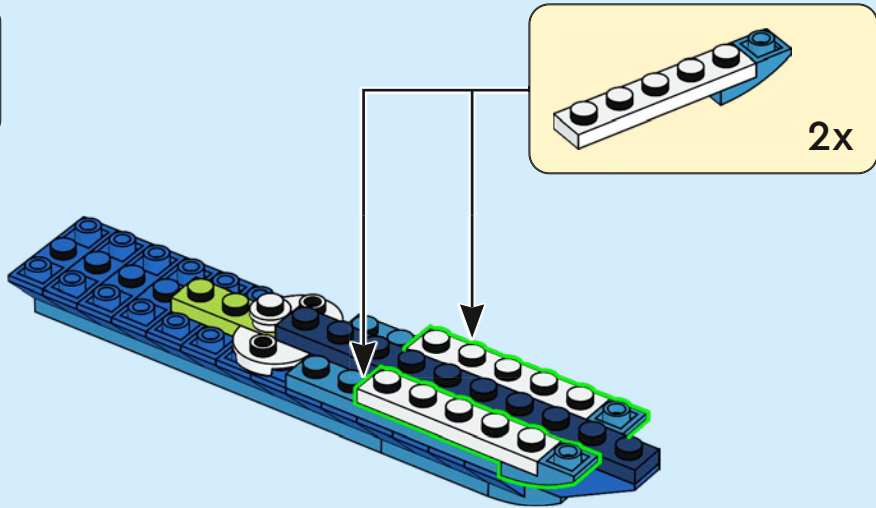

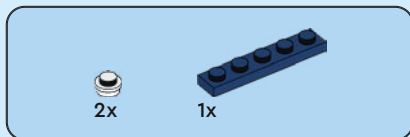

9

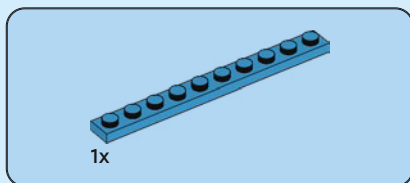
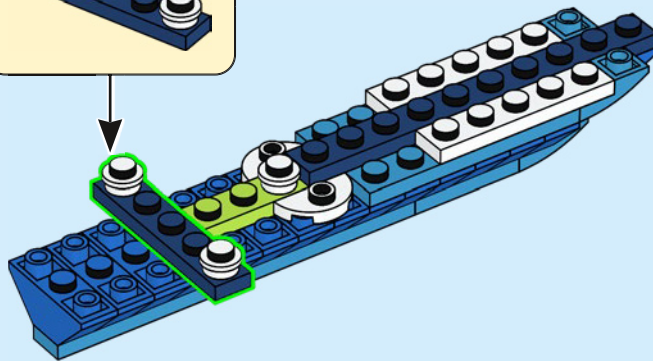
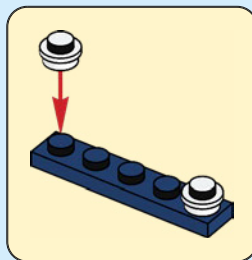

10

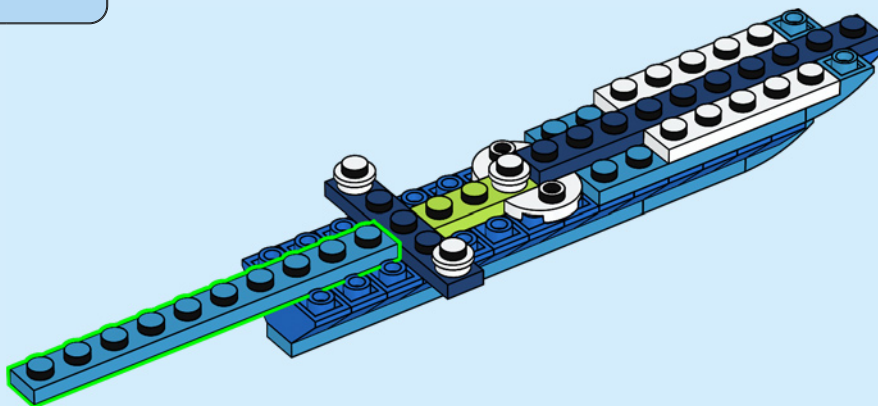

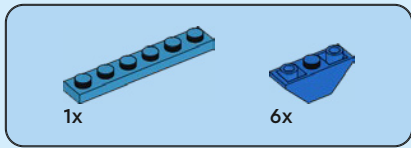

11

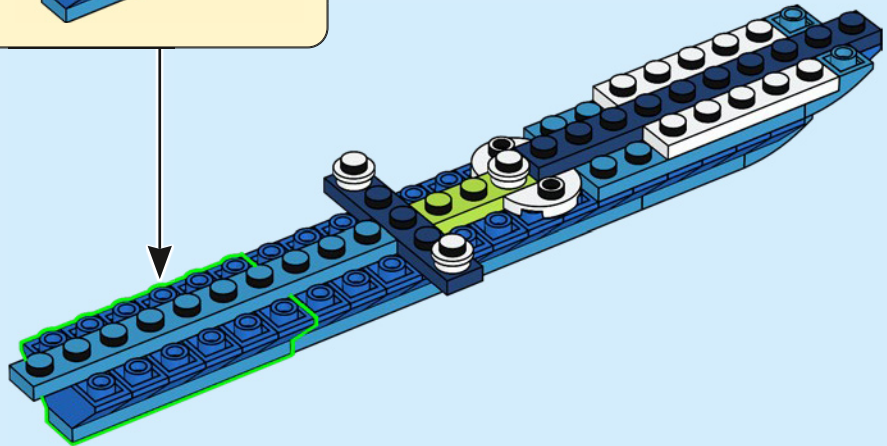
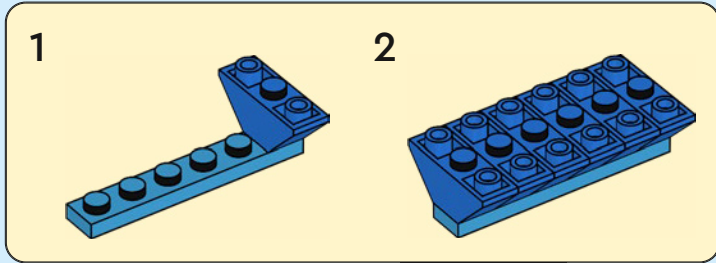

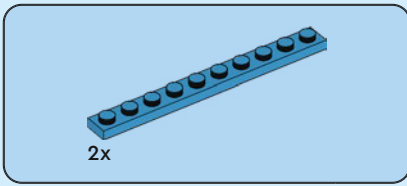

12

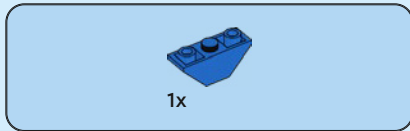
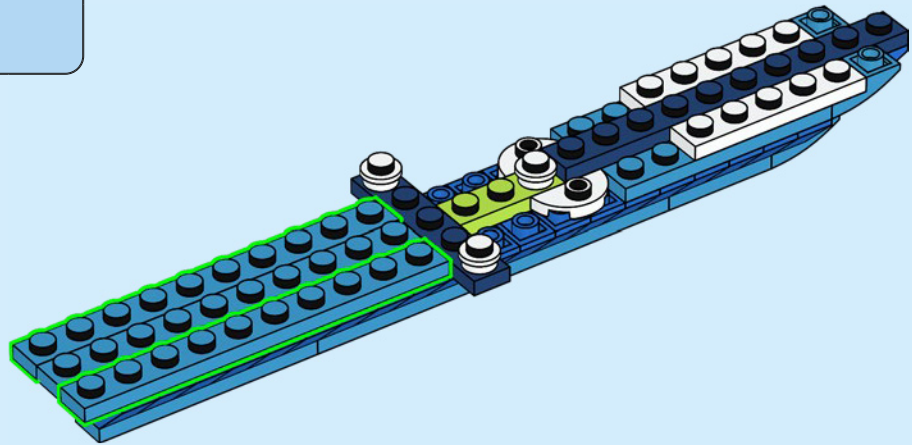

13

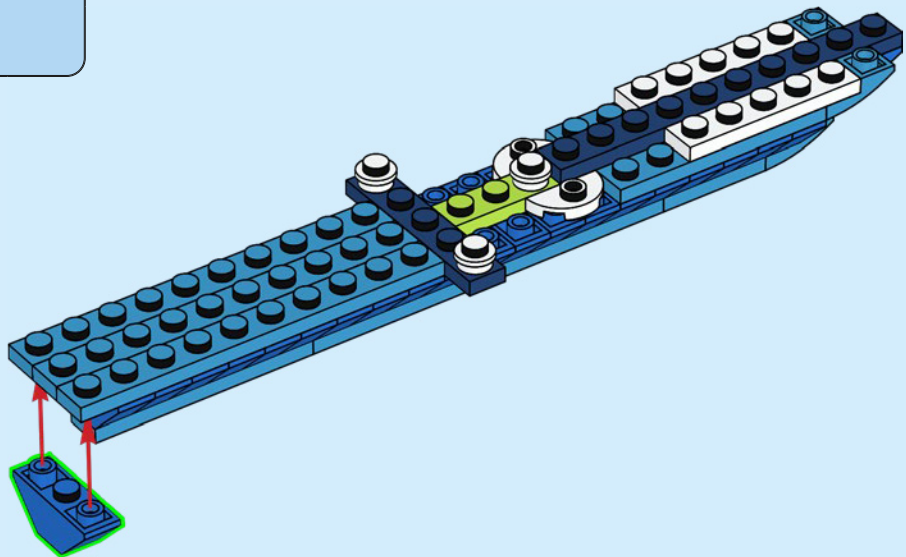

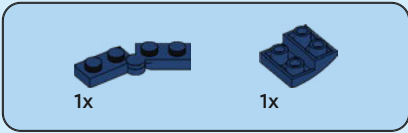

14

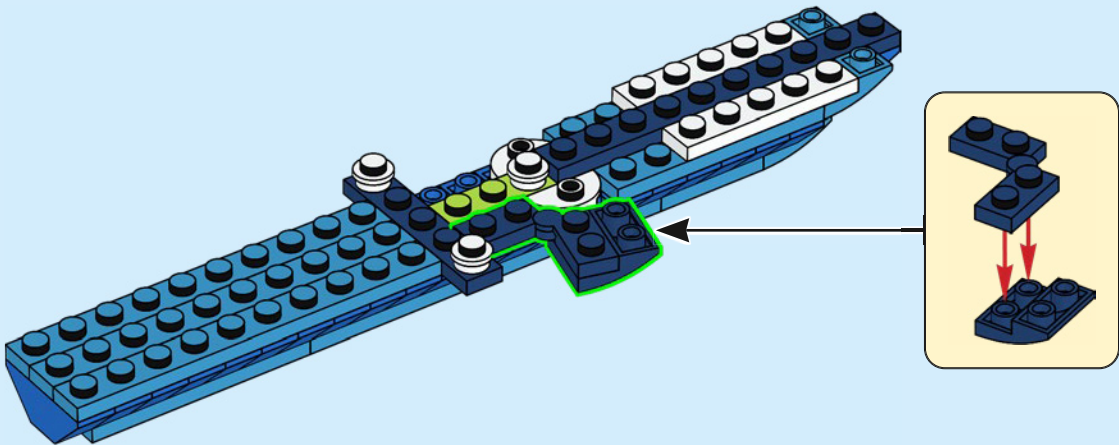

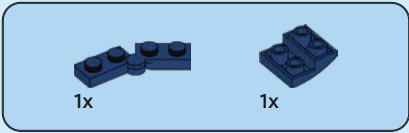

15

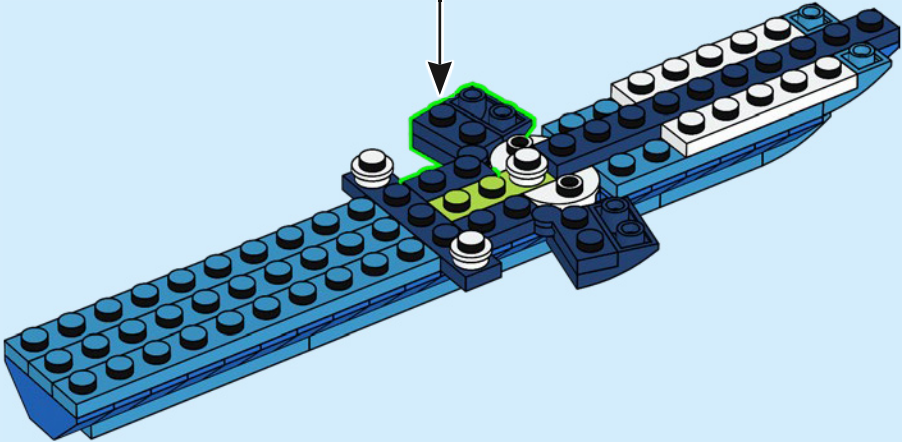
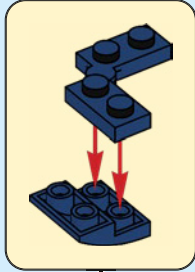

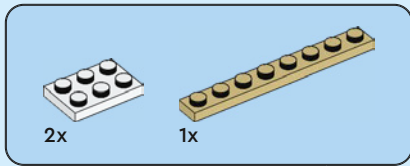

16

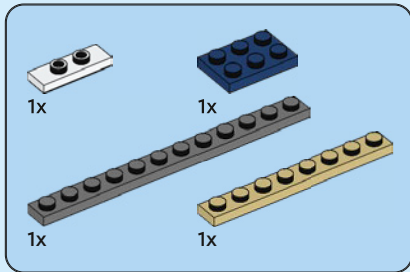
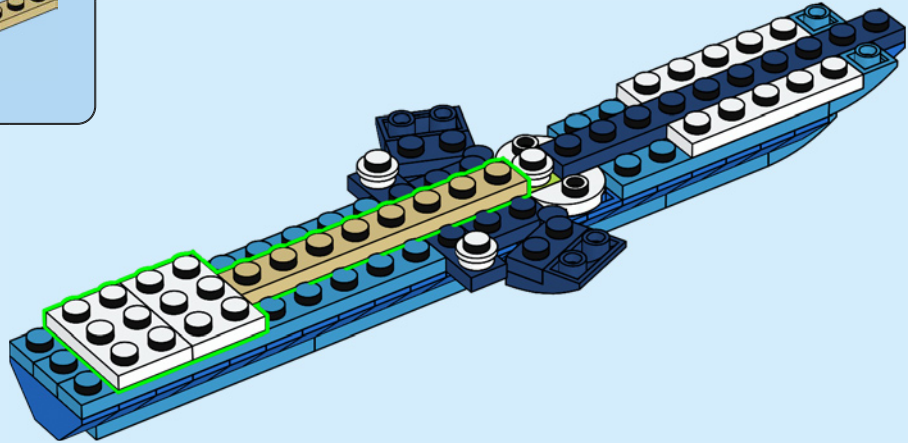

17

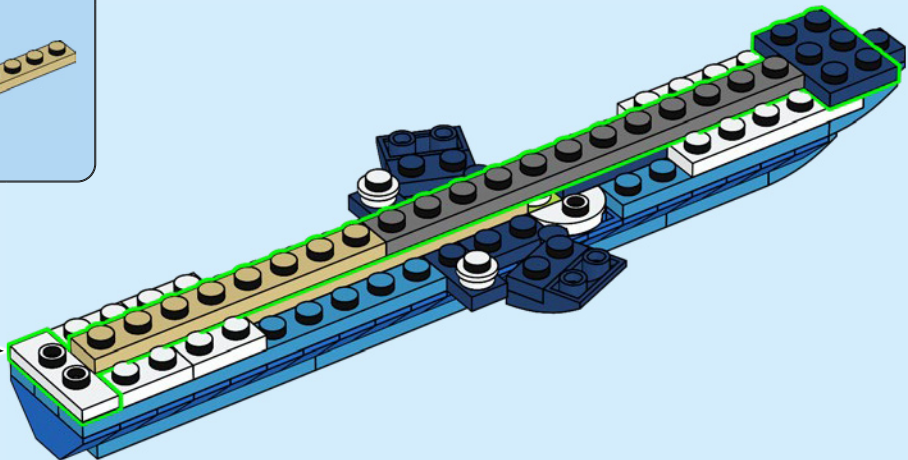
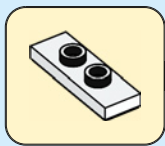



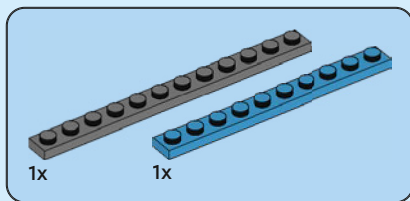

18

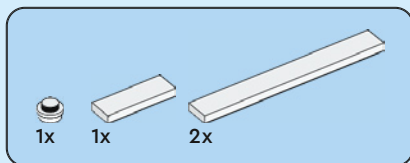
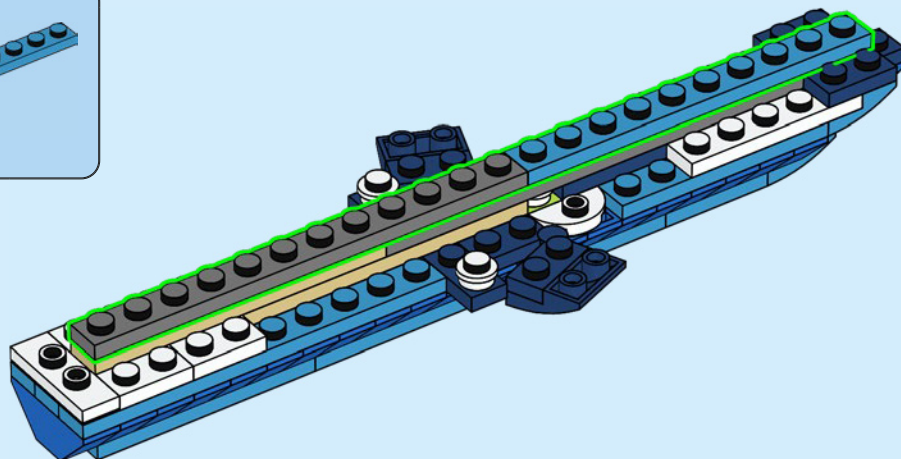

19

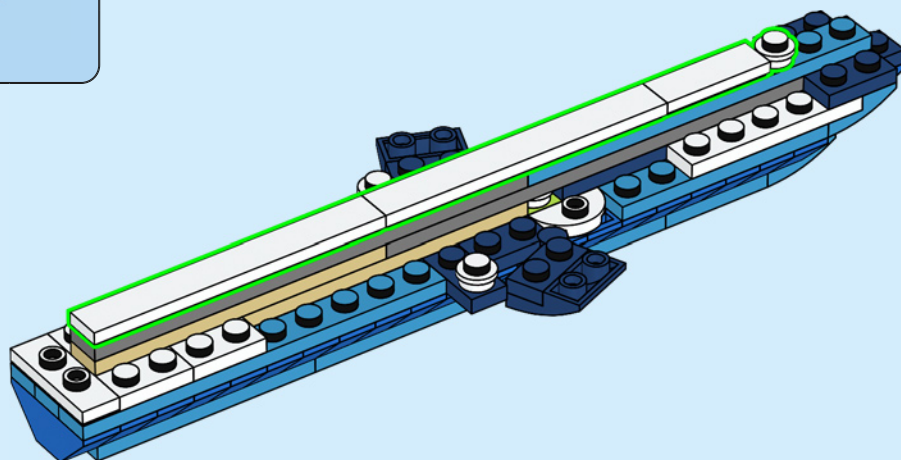

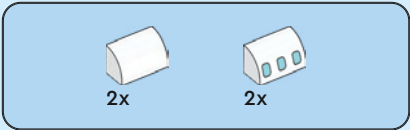

20

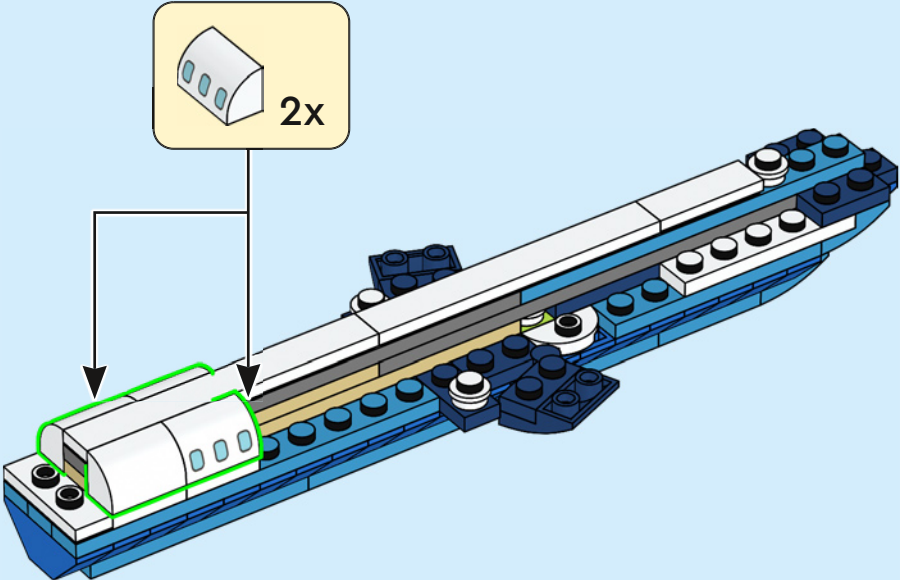

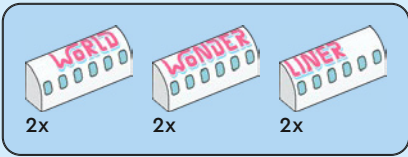

21

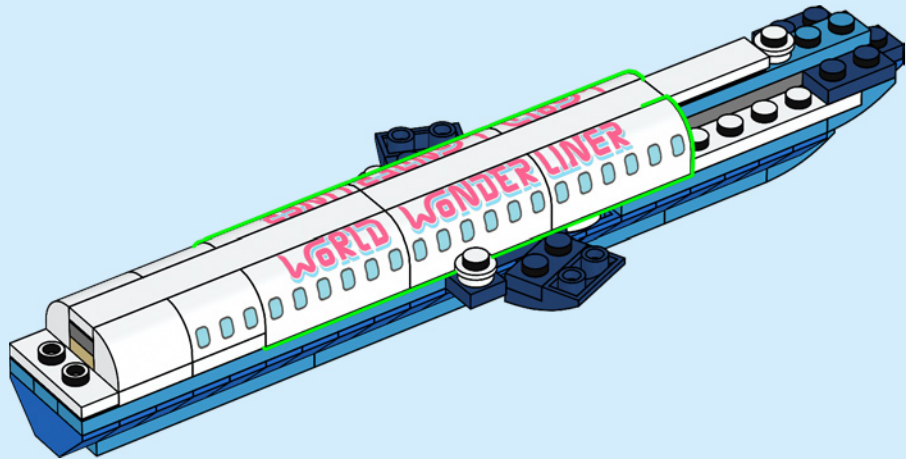
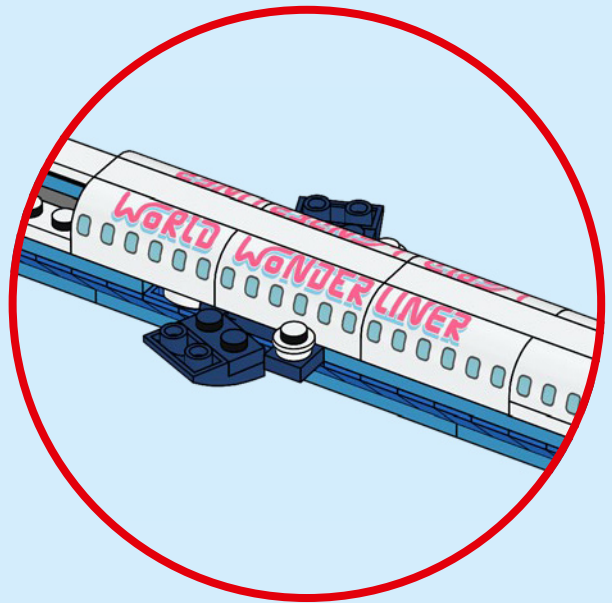

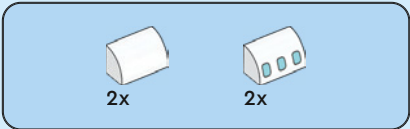

22

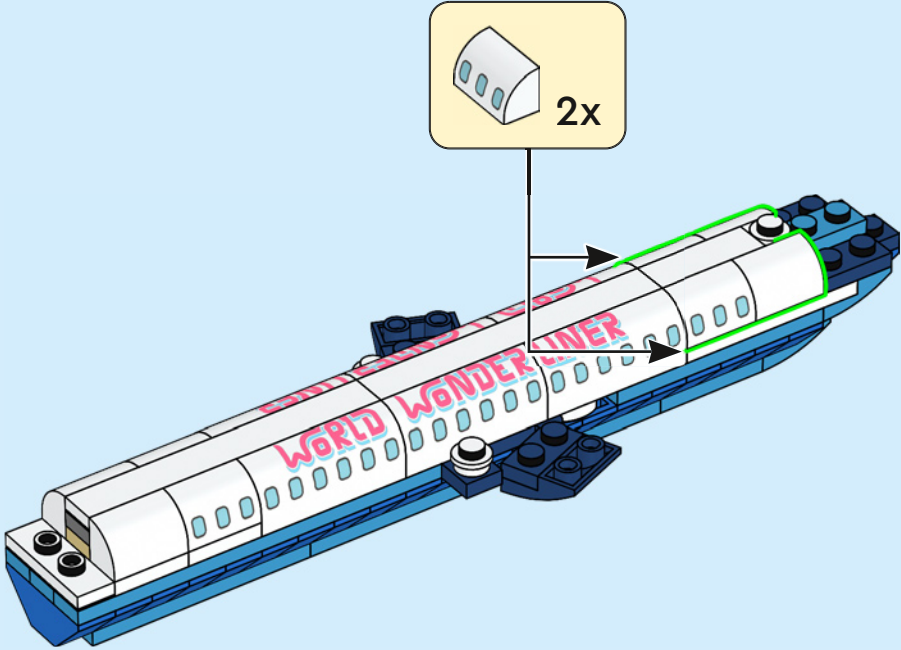

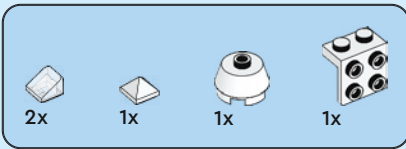

23

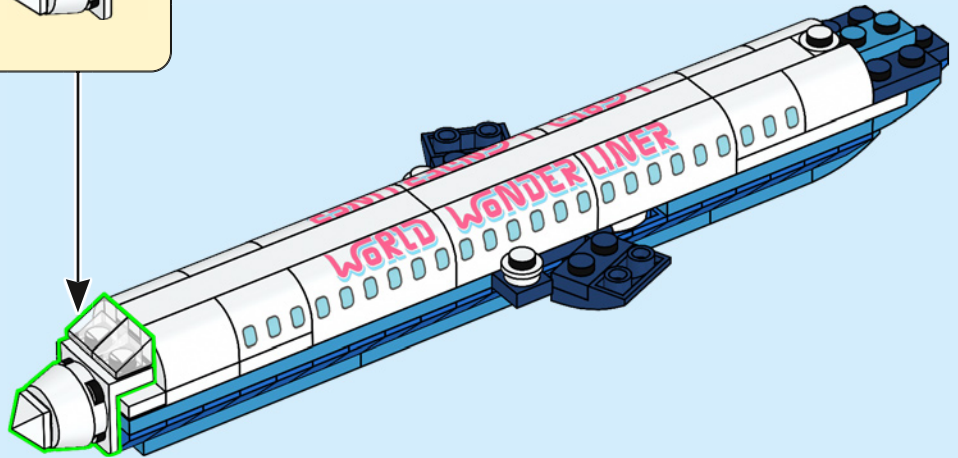
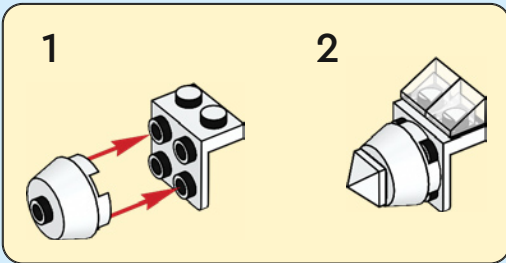



2x

24

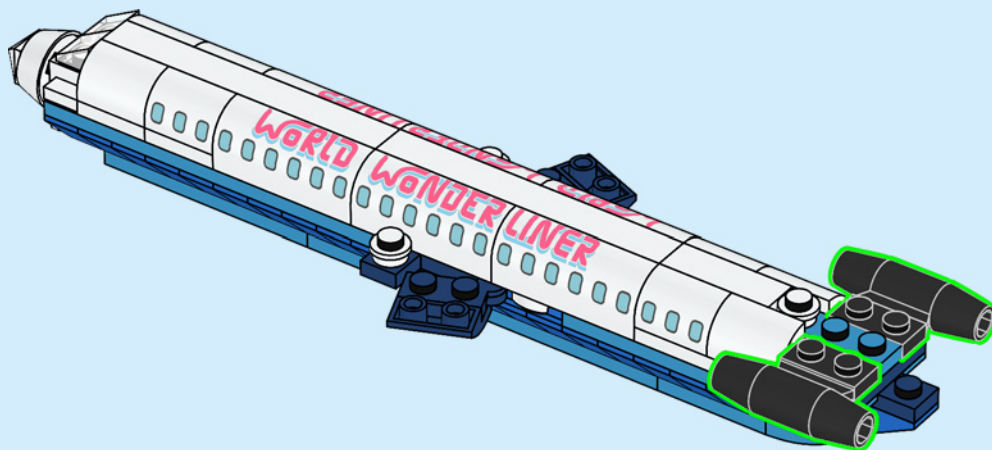

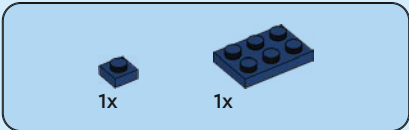

25

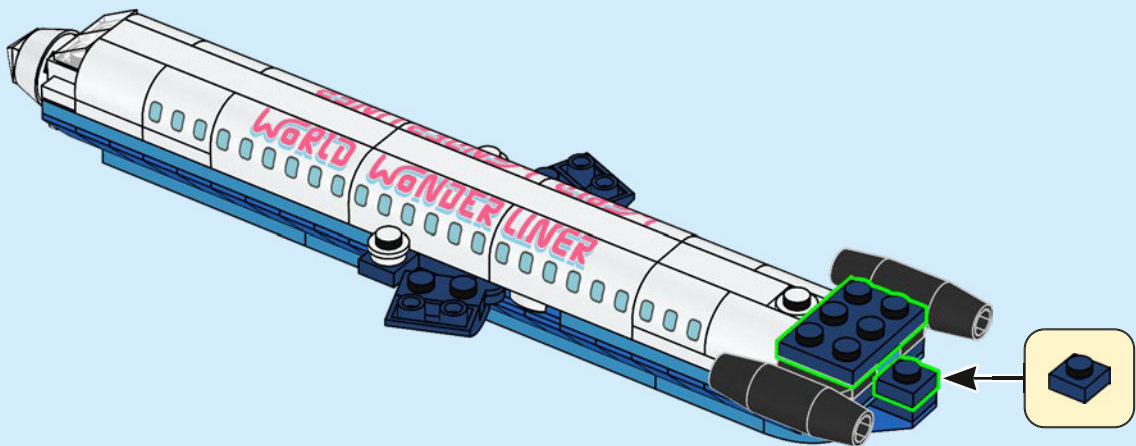



1x



1x

26

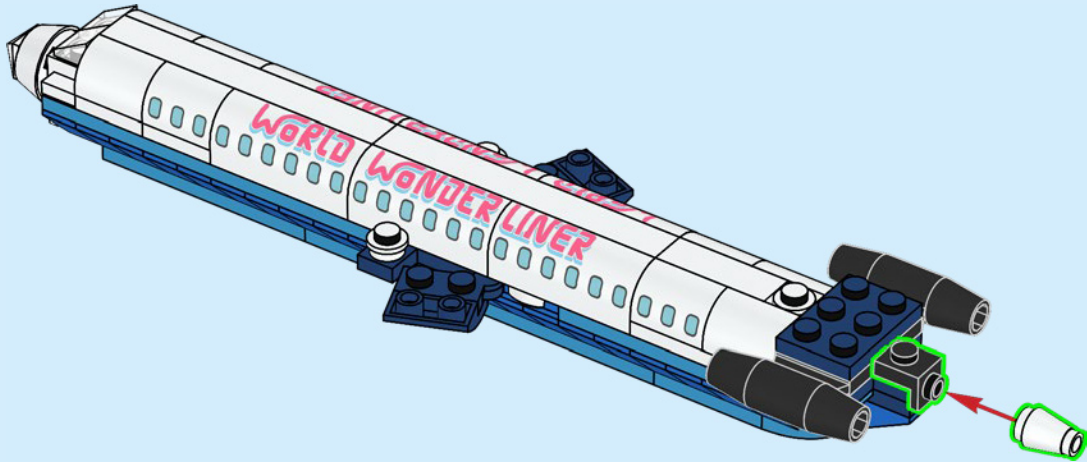



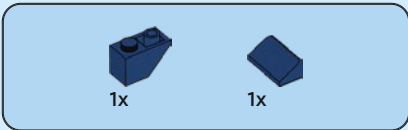

27

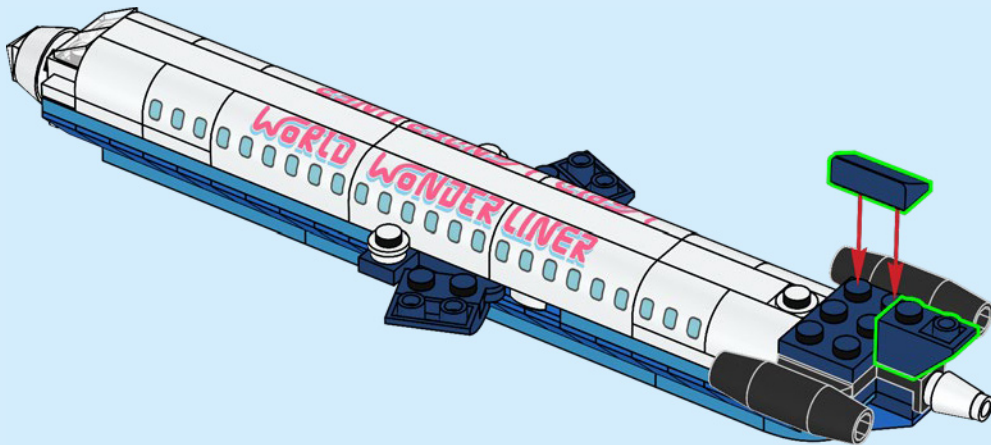

28

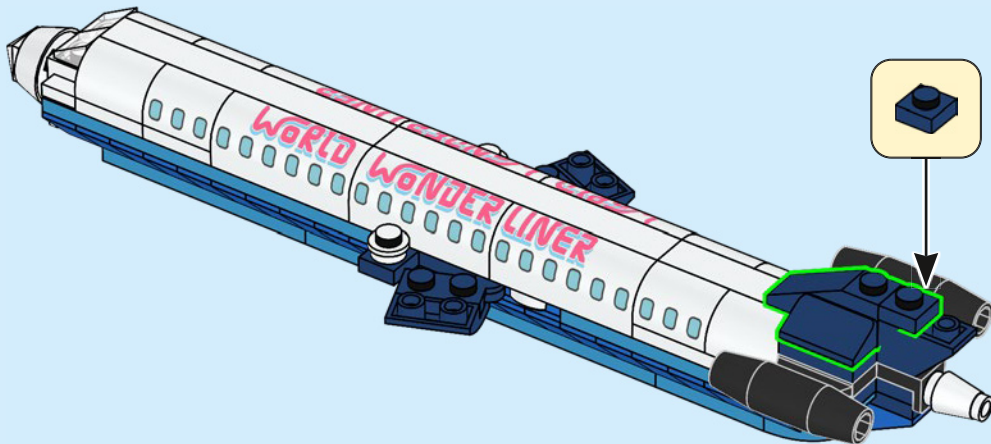



1x



1x

29

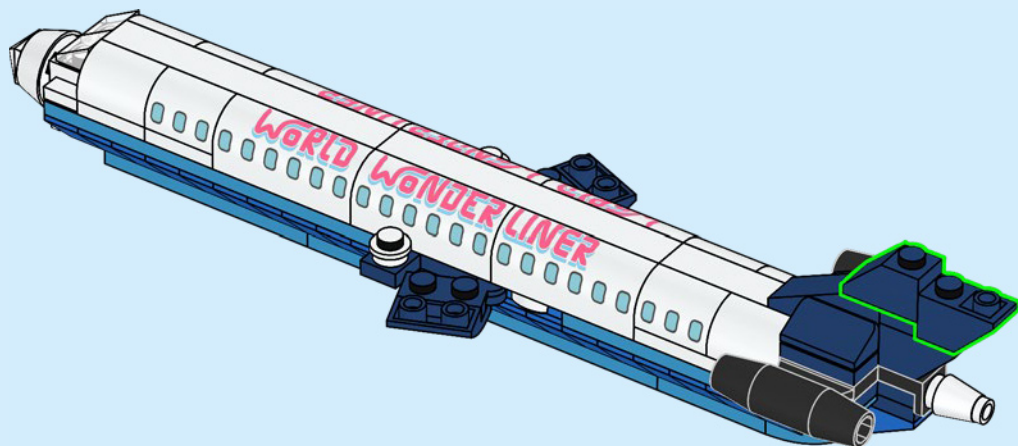

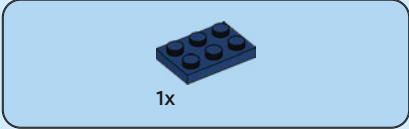
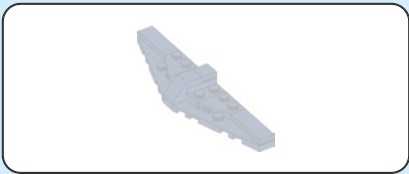

1x

30

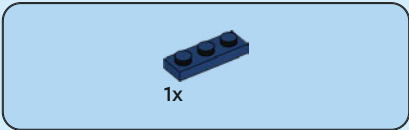
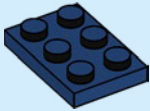

1x

31

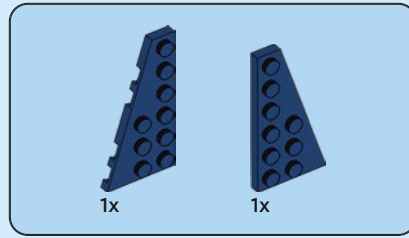
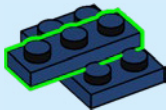

1x

1x

32

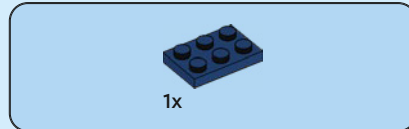
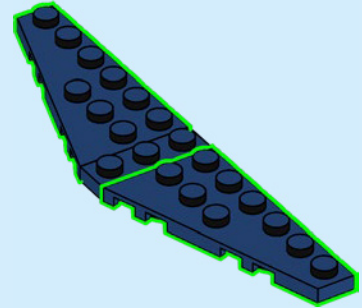

1x

33

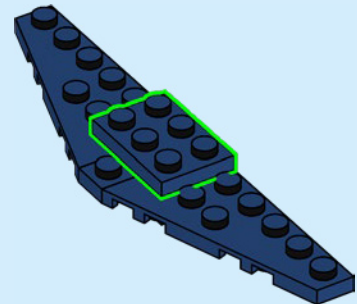

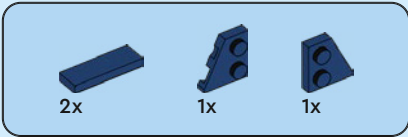

34

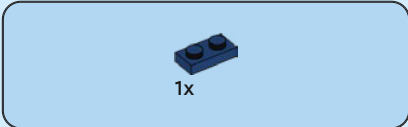
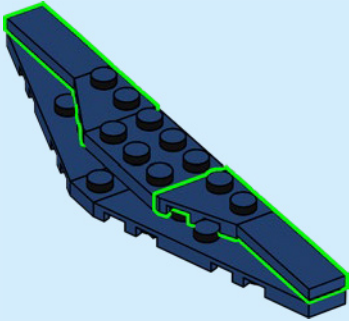

35

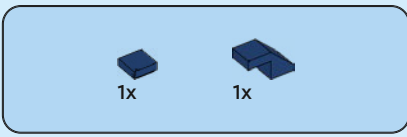
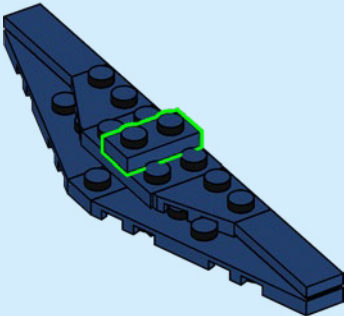

36



37

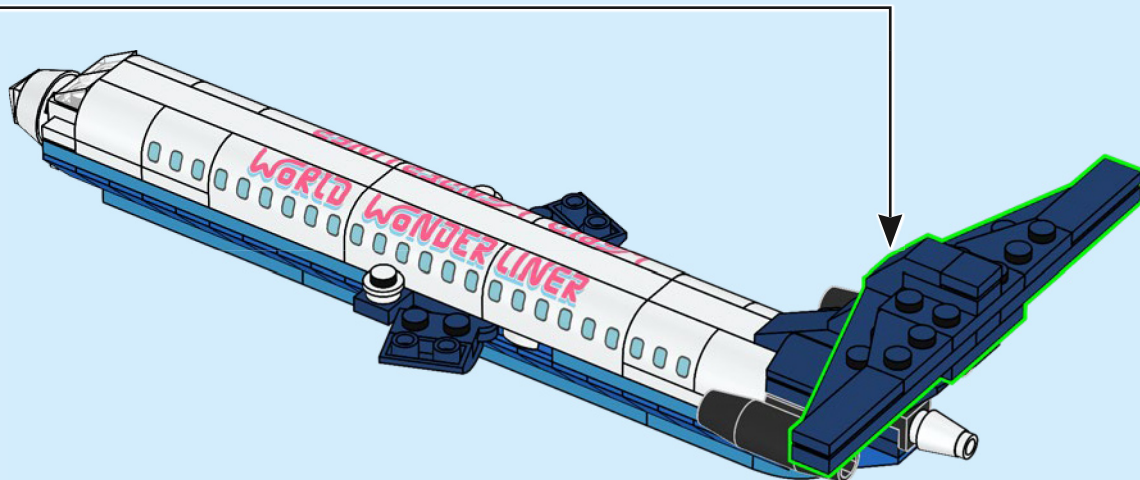

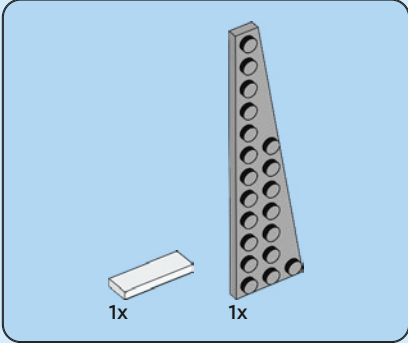
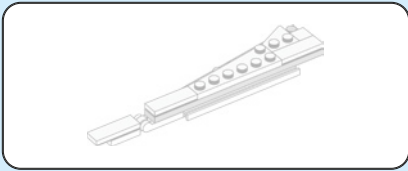

38

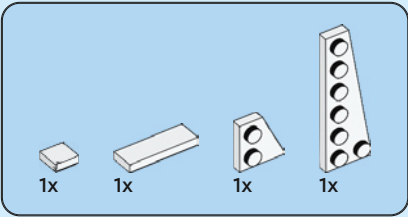
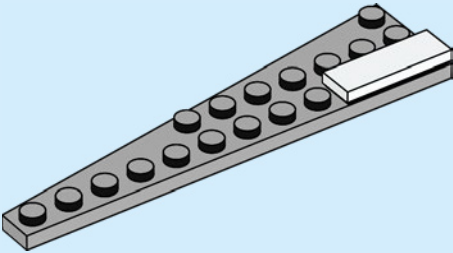

39

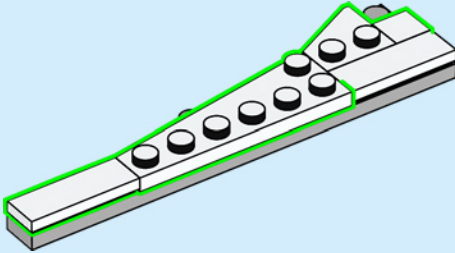

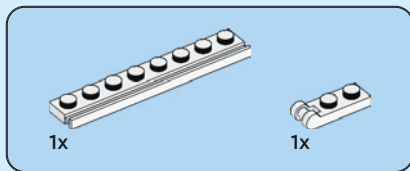

40

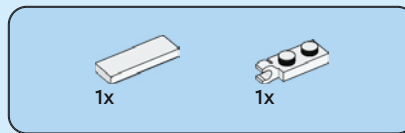
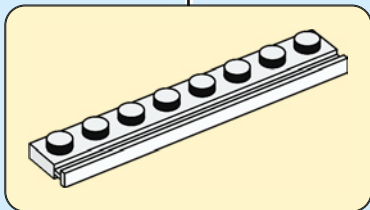
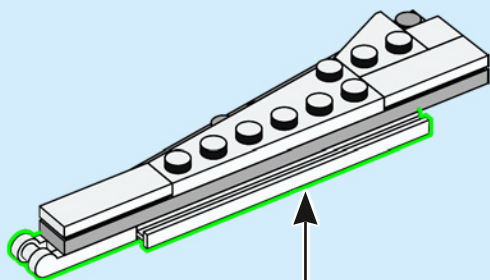

41

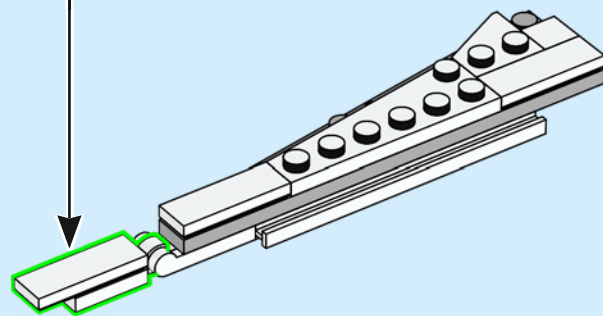
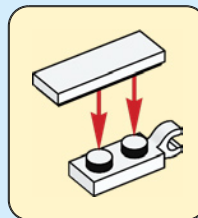

42

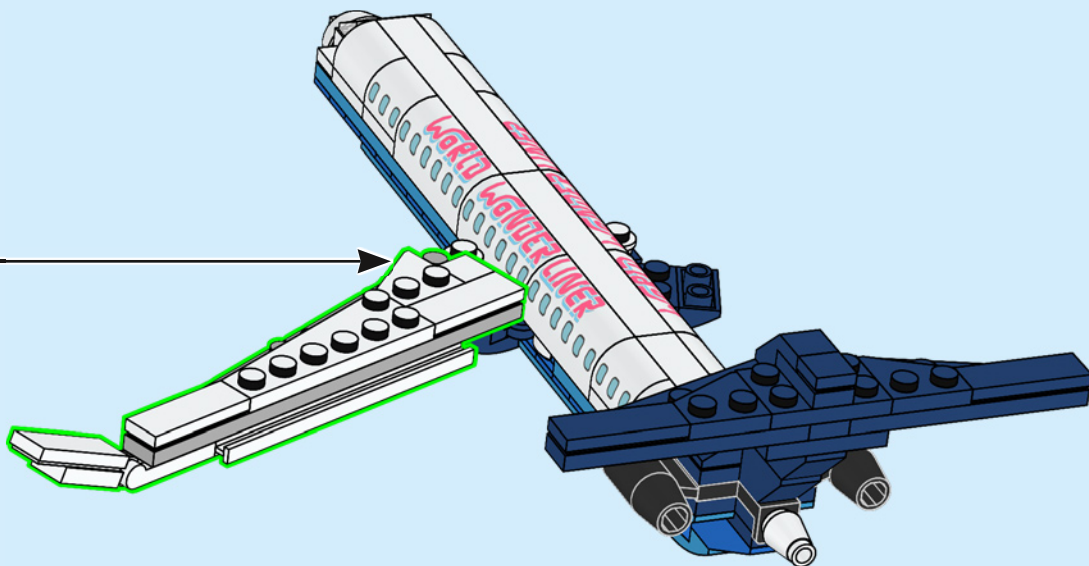



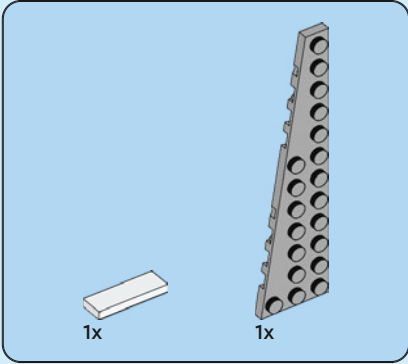
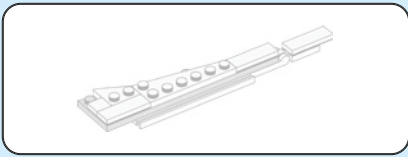

43

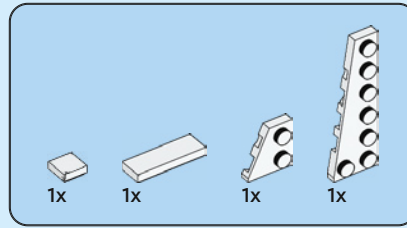
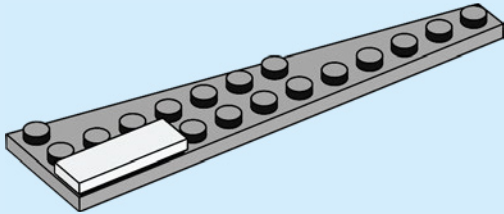

44

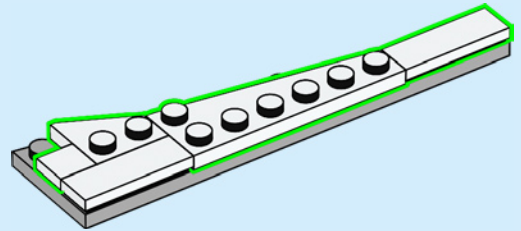

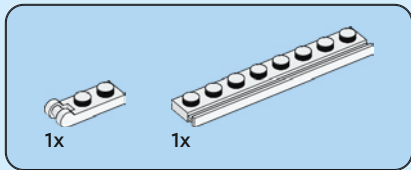

45

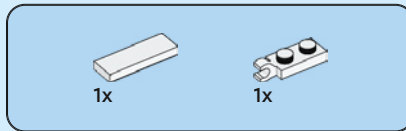
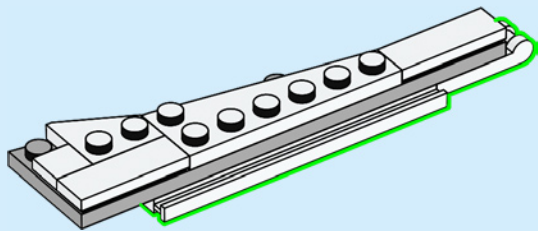

46

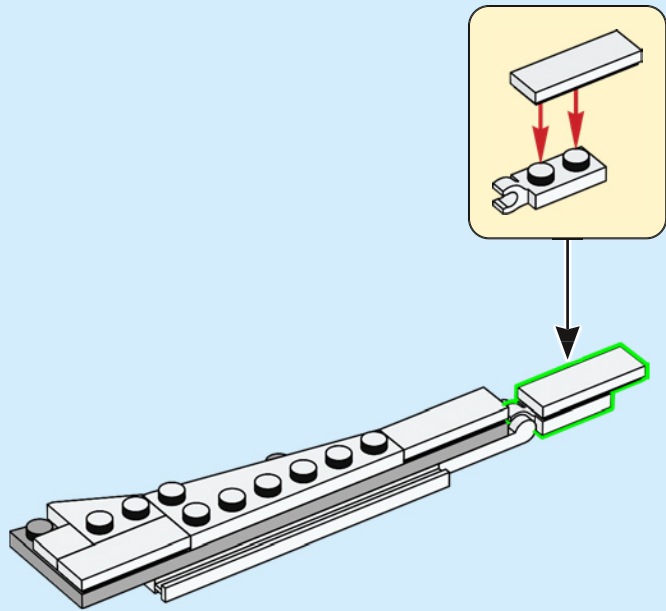

47

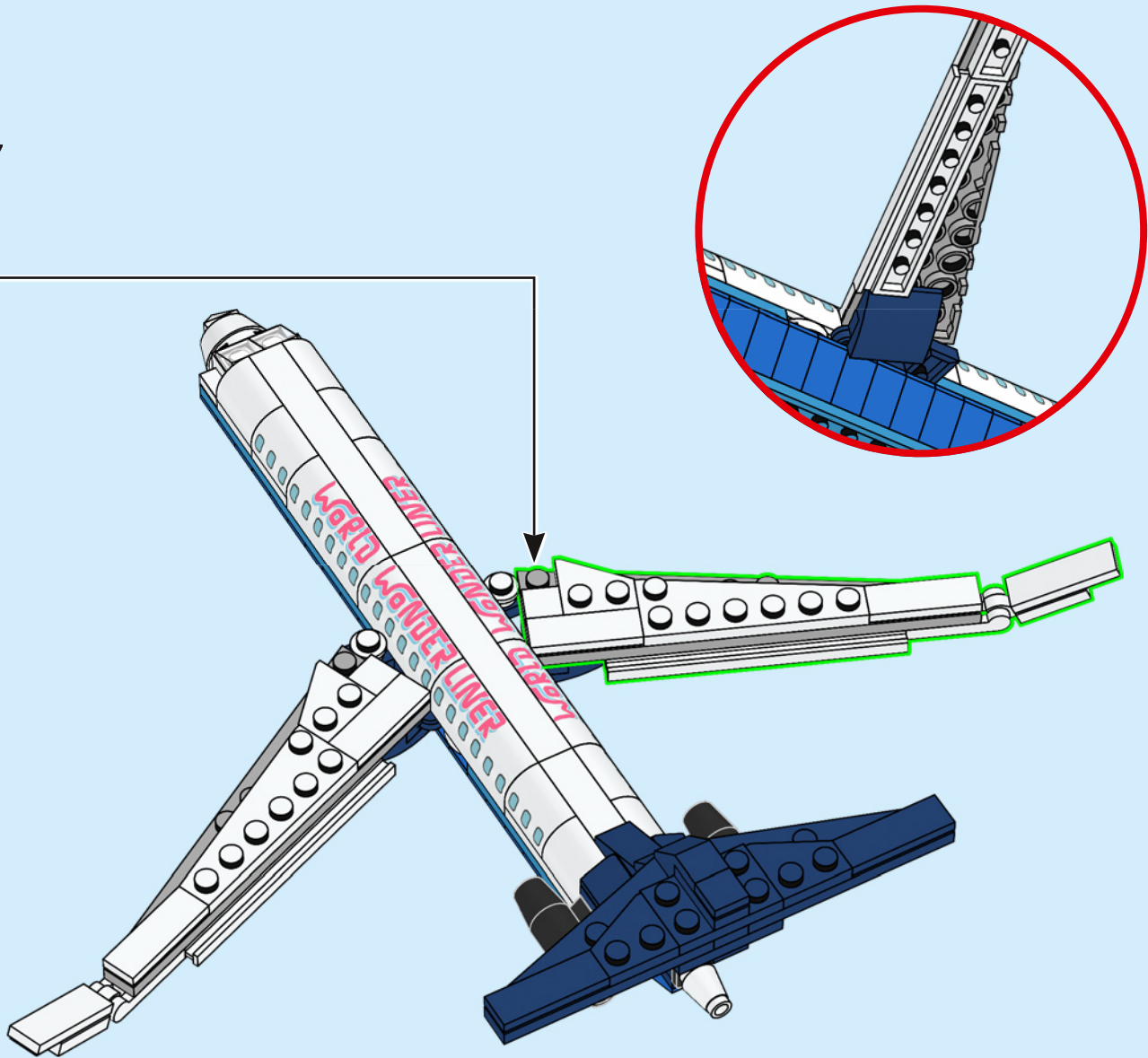

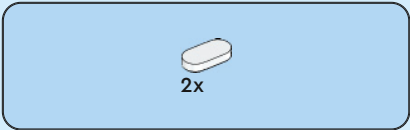

48

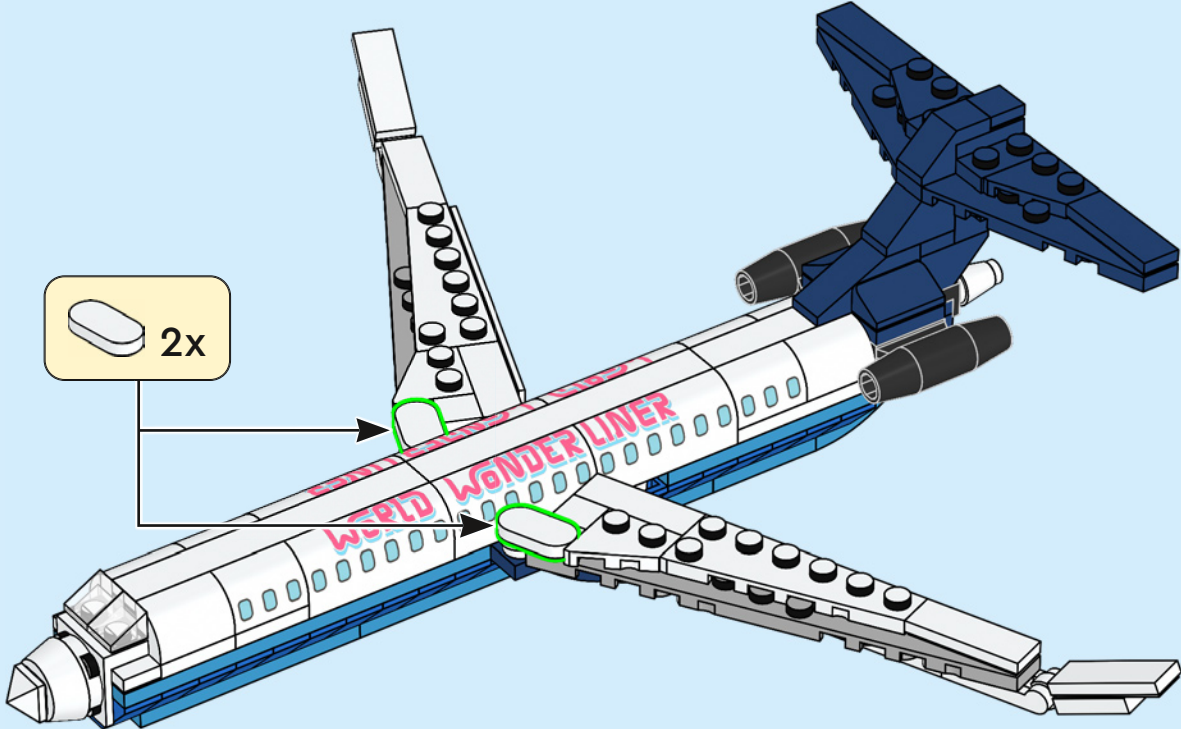



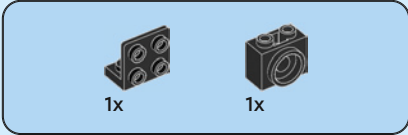
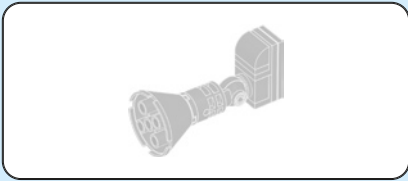

49

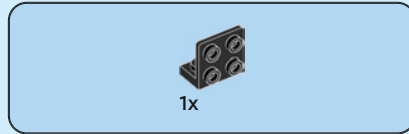
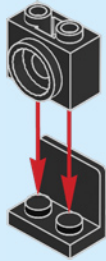

50

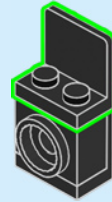

51

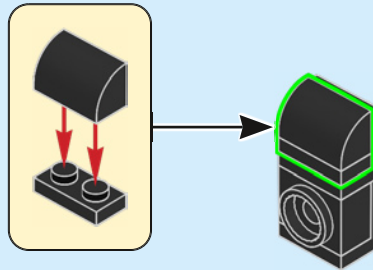

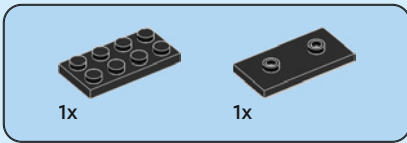

52

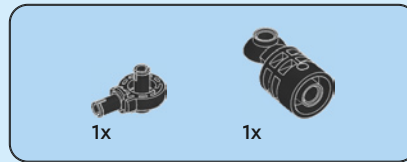
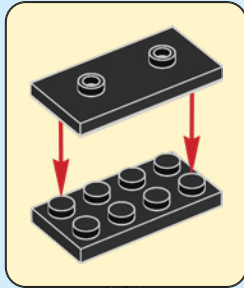

53

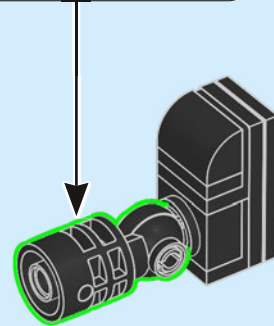
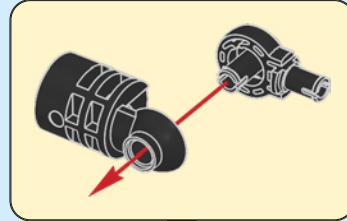

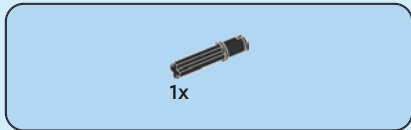

54

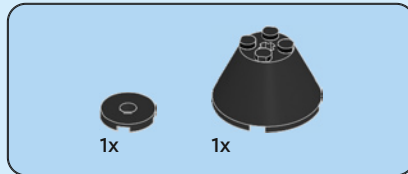
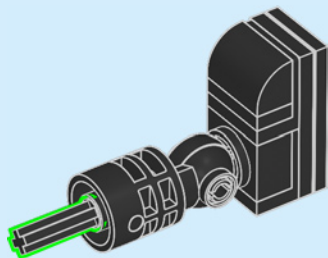

55

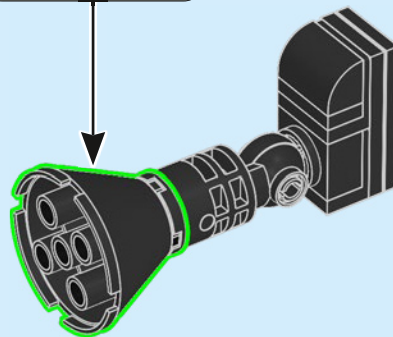
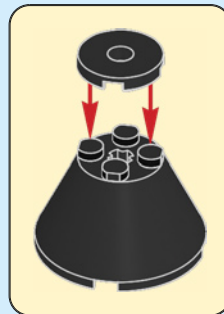



56

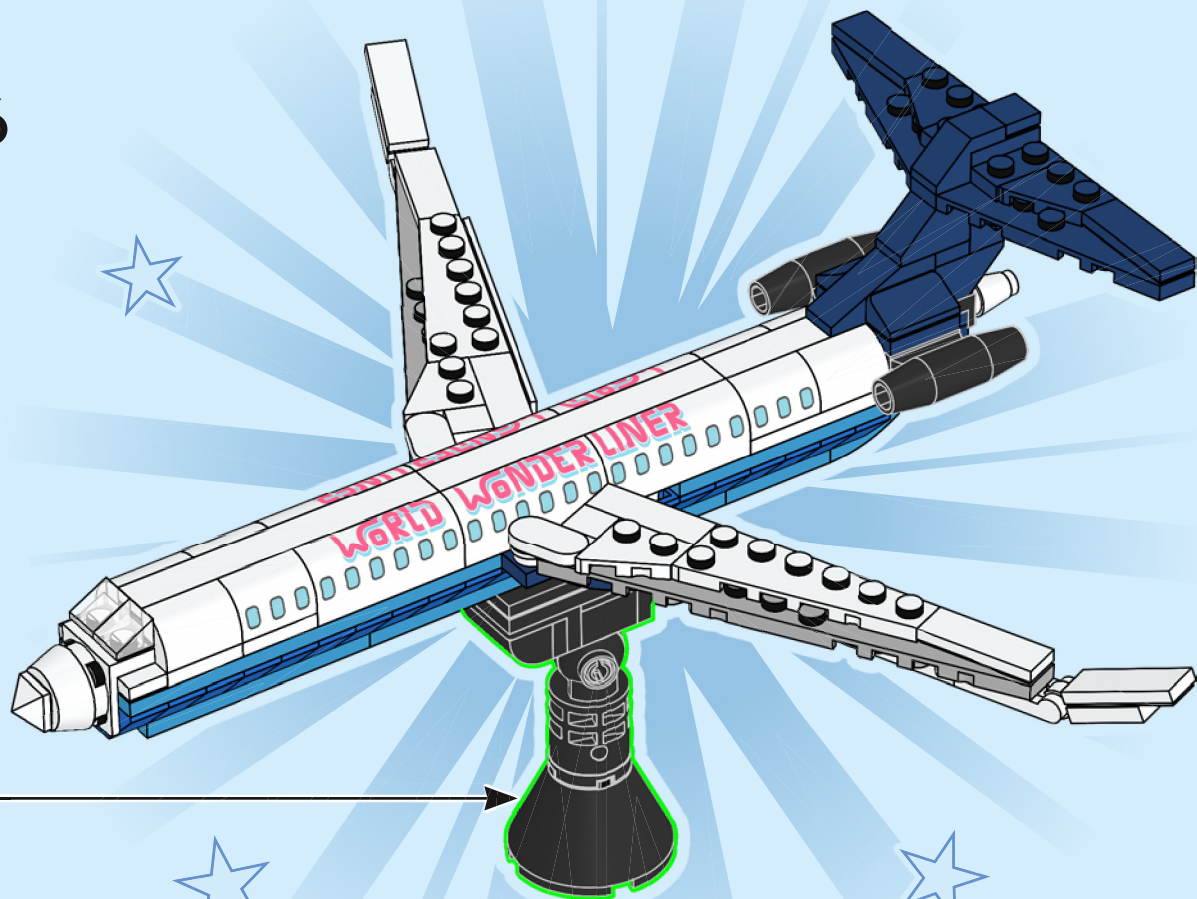

57

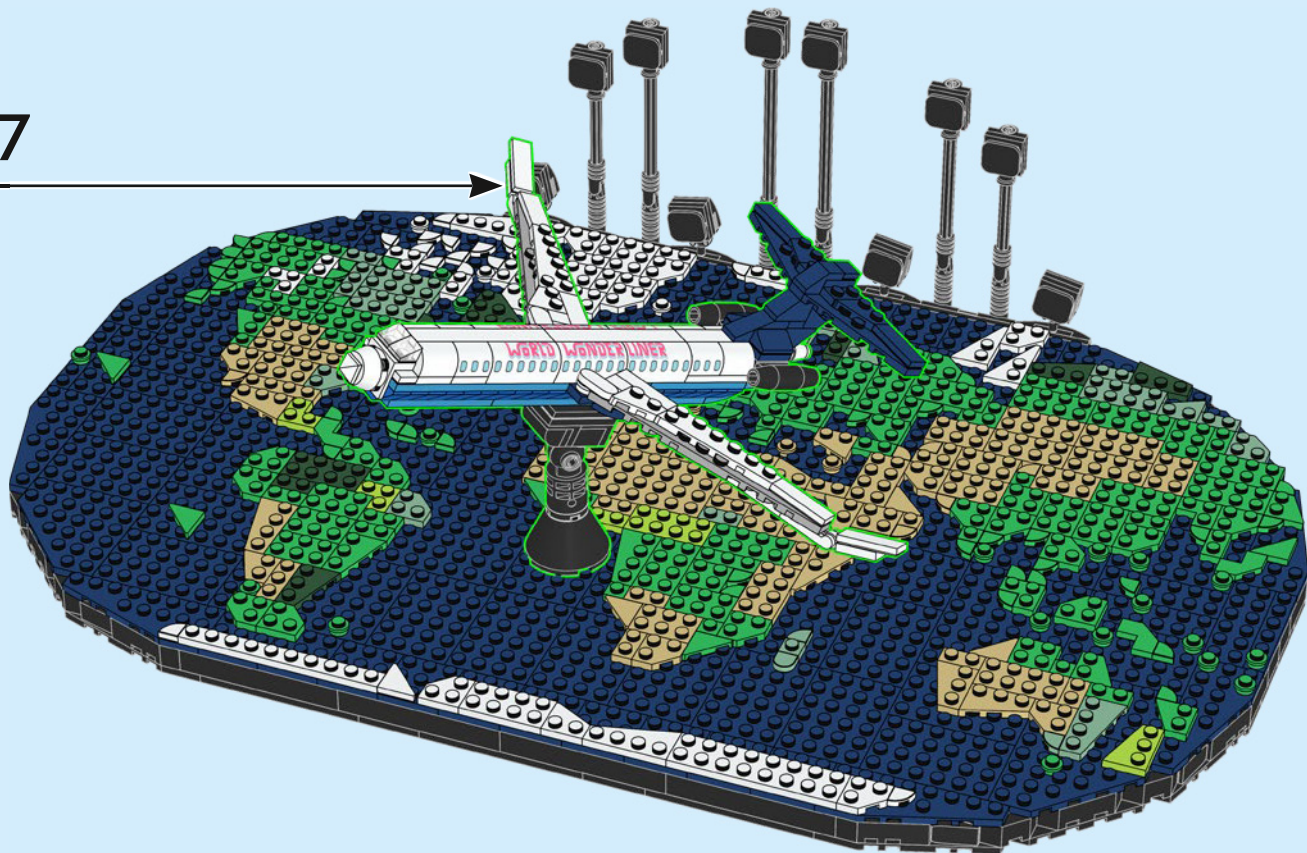

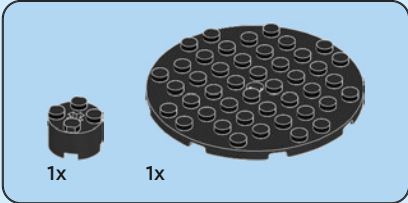

58

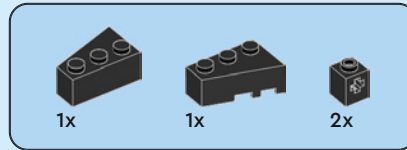
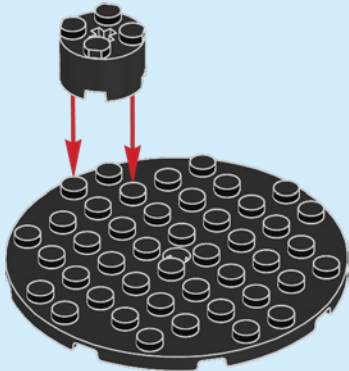

59

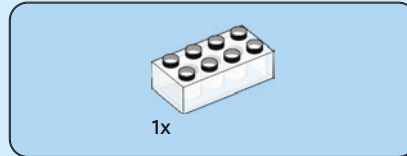
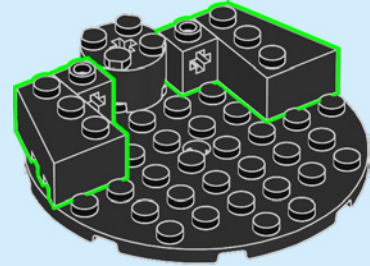

60

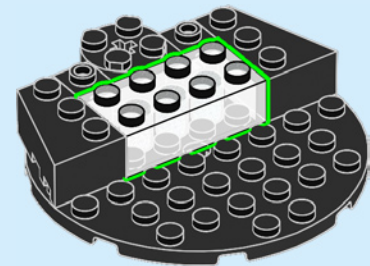



61

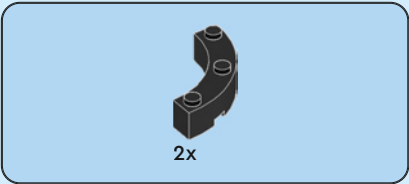
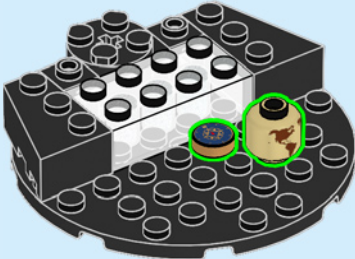

62

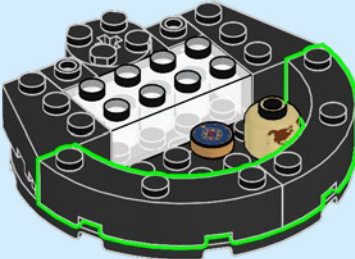



63

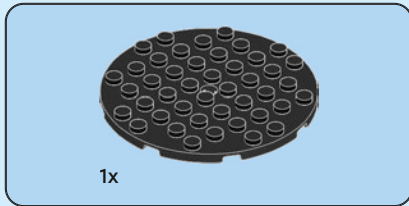
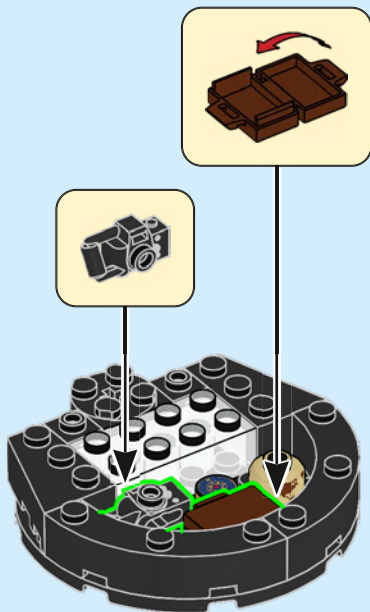

64

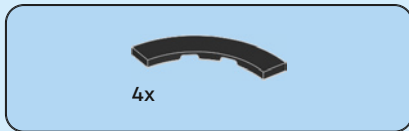
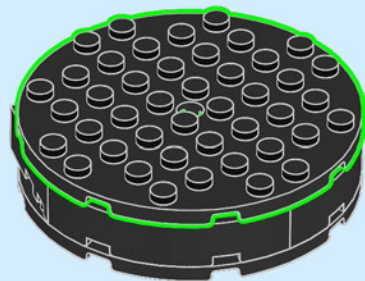

65

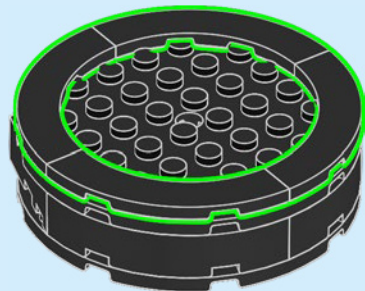

66

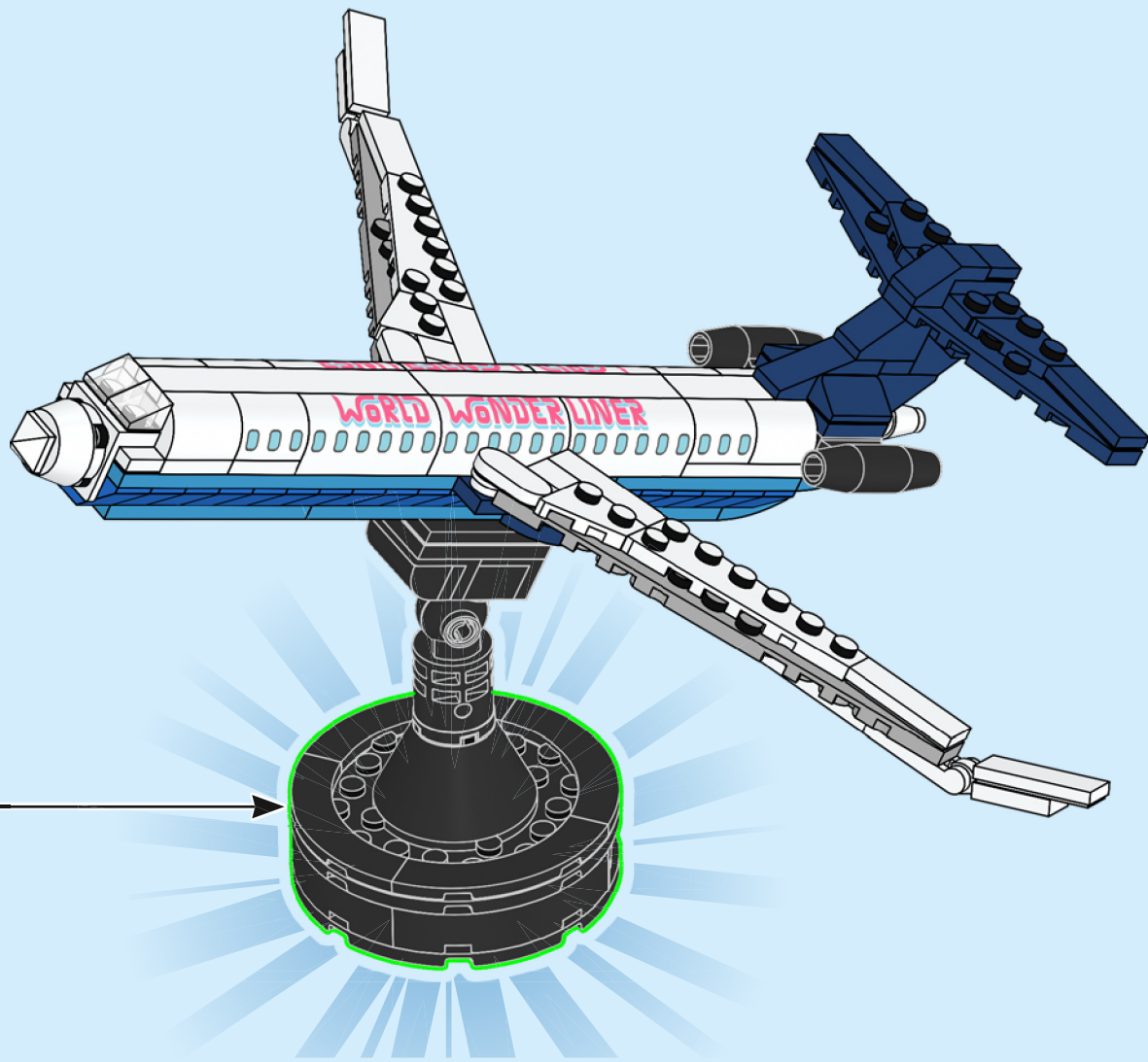

67

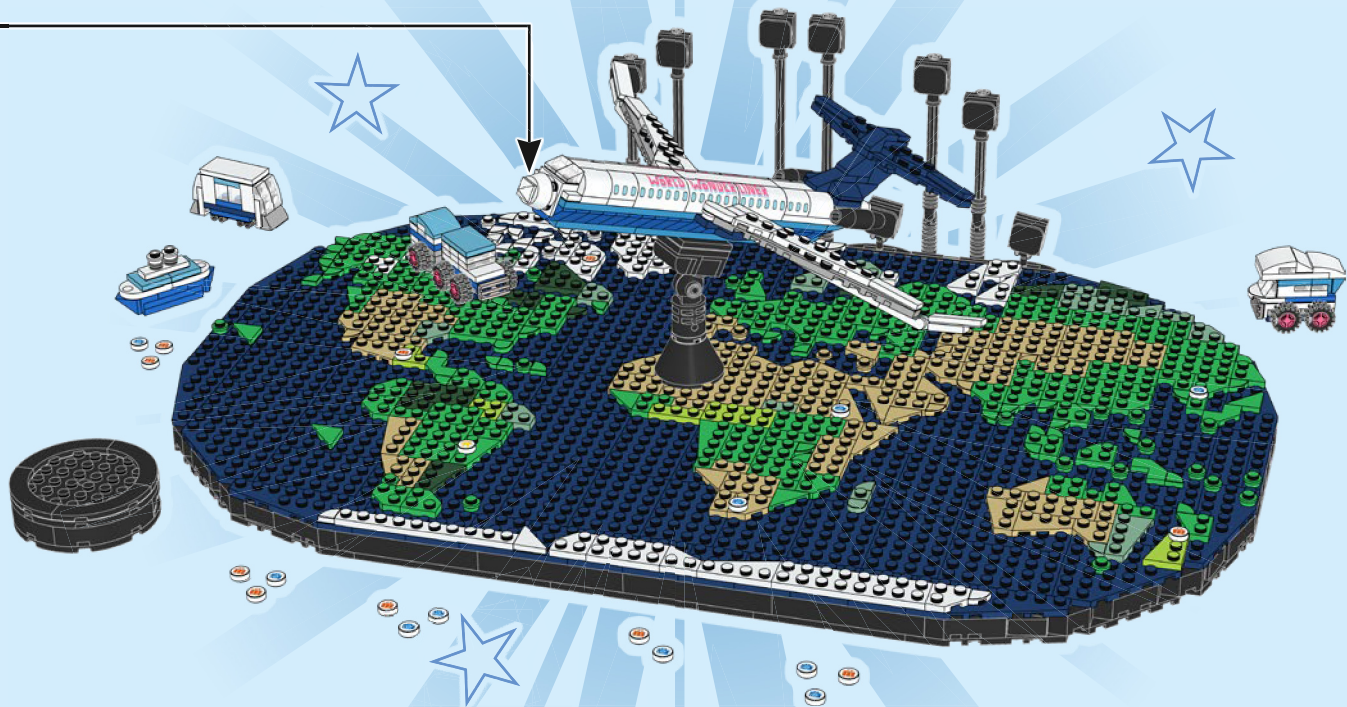



## Welcome aboard the World Wonderliner

On *LEGO® Masters (US)*, fortune favors bold builders, and the season 4 winning team, Christopher Lee and Robert Zhang, created some truly spectacular builds! As part of their grand prize, they got to work with LEGO designers Samuel Liltorp Johnson and Boone Langston to turn their winning World Wonderliner into this real-life LEGO set.

## Bienvenue à bord du World Wonderliner

Dans *LEGO® Masters (É.-U.)*, la fortune sourit aux constructeurs audacieux, et l'équipe gagnante de la saison 4, Christopher Lee et Robert Zhang, a créé des constructions vraiment spectaculaires ! Remporter le grand prix leur a permis de travailler avec les concepteurs LEGO Samuel Liltorp Johnson et Boone Langston pour transformer leur victorieux World Wonderliner en un ensemble LEGO réel.

## Te damos la bienvenida a bordo del World Wonderliner

En la edición estadounidense de *LEGO® Masters*, la fortuna favorece a los constructores más audaces. Y el equipo ganador de la 4.ª temporada, Christopher Lee y Robert Zhang, ¡lo demostró creando algunos modelos verdaderamente espectaculares! Como parte de su gran premio, ganaron la oportunidad de trabajar con los diseñadores de LEGO Samuel Liltorp Johnson y Boone Langston para convertir su propuesta ganadora, el World Wonderliner, en este set LEGO de la vida real.



## From LEGO® Masters to LEGO set

This Travel Moments set is perfect for building together. If you're a fan of the LEGO® Masters (US) TV show, you may recognize several elements inspired by the season 4 finale model as you build this set. The four designers worked together to tell the story behind Christopher and Robert's winning build in a new way. Now it's **YOUR** turn to share your stories together and display them your way!

## De LEGO® Masters à ensemble LEGO

L'ensemble Les souvenirs de voyage est parfait pour la construction partagée. Si vous êtes amateur de la série télé LEGO® Masters (É.-U.), vous reconnaîtrez peut-être plusieurs éléments inspirés du modèle final de la saison 4 lors de la construction de cet ensemble. Les quatre concepteurs ont travaillé ensemble pour raconter l'histoire de la construction gagnante de Christopher et Robert d'une nouvelle manière. C'est maintenant à **VOTRE** tour de partager vos histoires et de les exposer à votre façon !

## De LEGO® Masters a set LEGO del mundo real

El set Momentos de Viaje es perfecto para construir en compañía. Si eres fan de la edición estadounidense de la serie para televisión LEGO® Masters, quizá reconozcas algunos elementos inspirados en el modelo final de la 4.ª temporada al construir este set. Los cuatro diseñadores trabajaron juntos para contar la historia de la propuesta ganadora de Christopher y Robert en una nueva forma. ¡Y ahora te toca a **TI** compartir tu historia de construcción en compañía y exhibirla a tu manera!



*From left to right: LEGO® Masters US winners Robert Zhang and Christopher Lee with LEGO designers Boone Langston and Samuel Liltorp Johnson*

*De gauche à droite : Les vainqueurs du concours LEGO® Masters (É.-U.), Robert Zhang et Christopher Lee, avec les concepteurs LEGO Boone Langston et Samuel Liltorp Johnson*

*De izquierda a derecha: Los ganadores de la edición estadounidense de LEGO® Masters Robert Zhang y Christopher Lee con los diseñadores de LEGO Boone Langston y Samuel Liltorp Johnson*



## Your favorite moments

Who has a great idea for your next fun adventure? What are the most exciting places you have traveled to together? Find your favorite places on the map and mark them with the small icon tiles with cameras, suitcases and the 'home' tile. The vehicle models are all-terrain and will take you wherever you want to go. Search your photo albums, your dream vacation brochures or vacation scrapbooks and find photos, memorabilia, postcards or tickets you can add to your display!

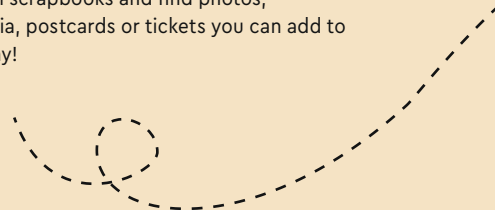

## Vos moments préférés

Qui a une bonne idée pour votre prochaine belle aventure ? Quels sont les endroits les plus fascinants que vous avez visités ensemble ? Trouvez vos endroits préférés sur la carte et marquez-les à l'aide des petites tuiles représentant des appareils photo, des valises et une maison. Les modèles de véhicules sont tout-terrain et vous emmèneront partout où vous voulez aller. Cherchez dans vos albums photos ou vos brochures de vacances de rêve et trouvez des photos, des souvenirs, des cartes postales ou des billets que vous pouvez ajouter à votre pièce !

## Sus momentos más especiales

¿Quién tiene una grandiosa idea para su próxima aventura divertida? ¿Cuáles son los lugares más emocionantes a los que han viajado juntos? Busquen sus lugares favoritos en el mapa y márkennlos con las cubiertas pequeñas decoradas con imágenes de cámaras y maletas. No olviden identificar su hogar con la cubierta incluida especialmente para este fin. Los modelos de vehículos son todoterreno y los llevarán a donde quieran ir. ¡Busquen en sus álbumes de fotos, en los folletos de sus vacaciones soñadas o en sus colecciones de recortes de destinos de viajes y encuentren imágenes, recuerdos, postales o boletos que puedan añadir a su exhibición!

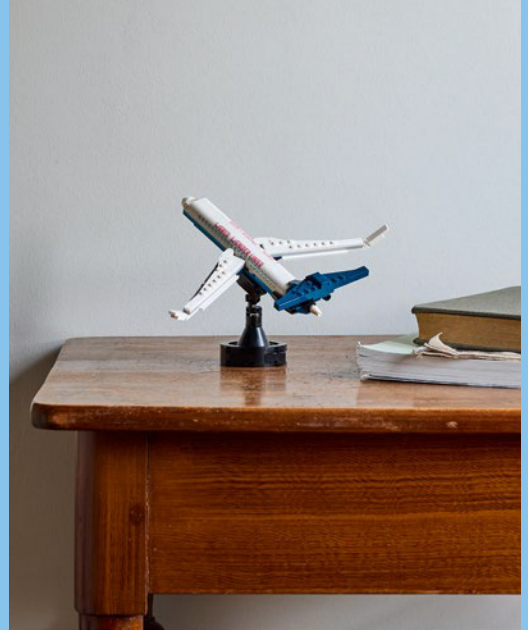

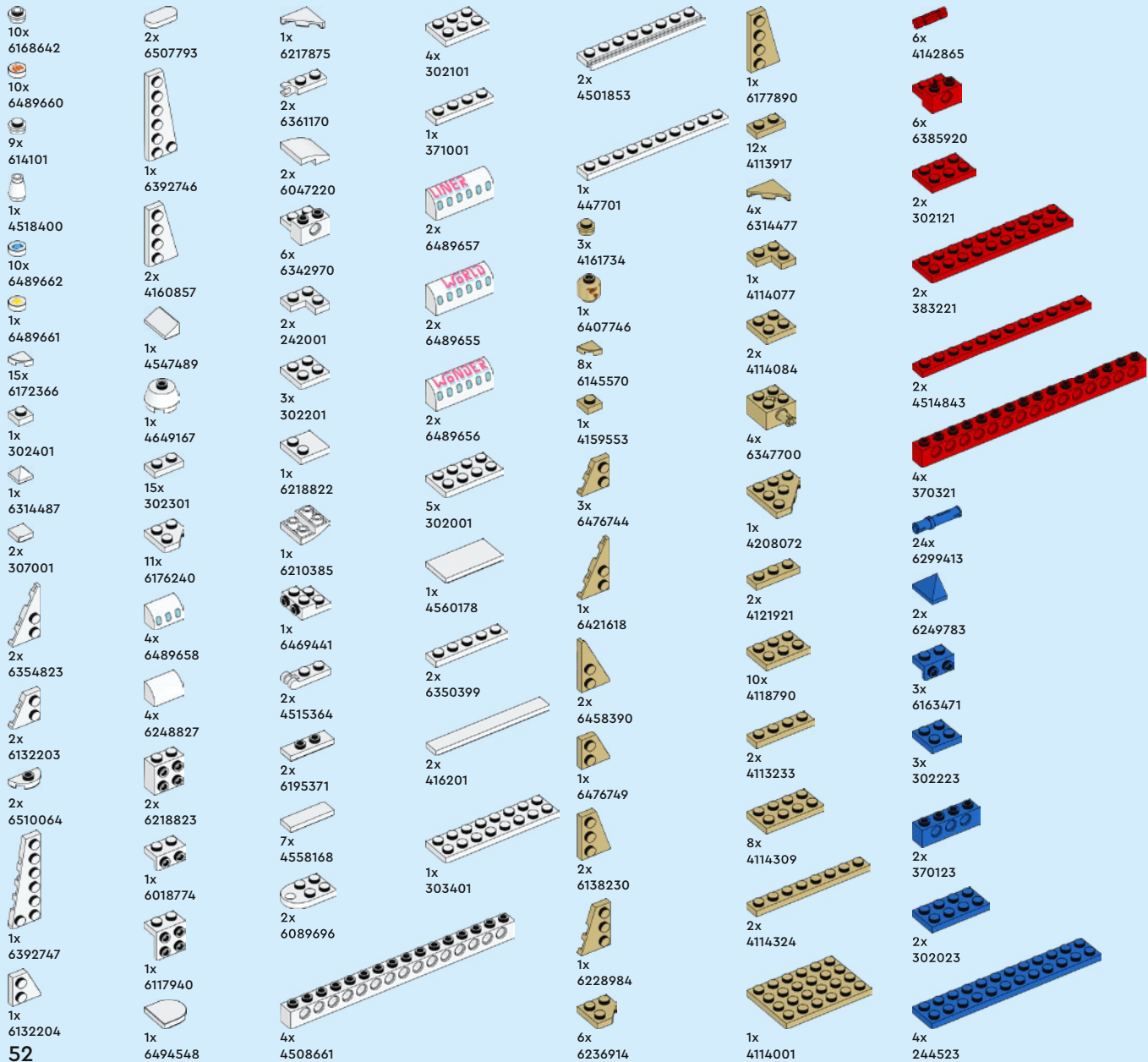



8x  
6488776



4x  
6231513



21x  
6502462



1x  
6372038



1x  
302123



2x  
614126



4x  
4504382



2x  
6344819



1x  
6299338



6x  
6265699



10x  
4578677



8x  
6483559



1x  
4548180



12x  
6271535



1x  
6143850



1x  
614326



1x  
6476480



8x  
300426



2x  
6338799



8x  
302326



2x  
6047276



1x  
6507242



1x  
6275732



8x  
302226



2x  
370626

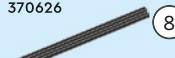

2x  
370726



2x  
373726



2x  
4660876



1x  
4143243



4x  
6174917



1x  
6438520



1x  
302026



2x  
6252902



2x  
6000650



4x  
4251394



4x  
4251394



4x  
4251393



4x  
4106977



4x  
4106977



1x  
4213374



4x  
6265730



10x  
6502463



6x  
281726



8x  
4584274



4x  
6211476



1x  
6089119



12x  
6469445



4x  
6448318



6x  
6321745



4x  
4159550



5x  
4526931



1x  
6432442



1x  
6432442



4x  
300226



5x  
4527766



8x  
302126



2x  
362226



4x  
4613153



4x  
4243819



4x  
6458165



2x  
6302094



6x  
300826



3x  
416226



3x  
303426



2x  
6393938



2x  
6393938



20x  
4569058



2x  
6250600



40x  
6150607



12x  
302428



14x  
302328



6x  
6385279



1x  
4543259



1x  
4621946



2x  
379528



2x  
6462430



4x  
6448394



12x  
4107558



2x  
428226



5x  
4157120



4x  
302228



3x  
6385275



19x  
6311453



5x  
6385265



2x  
4107758



7x  
302128



2x  
371028



16x  
302028



4x  
6245250



8x  
6514001



2x  
6514262



4x  
6508253



2x  
6345402



2x  
6350418

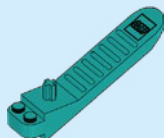

3x  
6254100



2x  
6257063

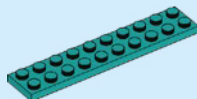

2x  
6249538

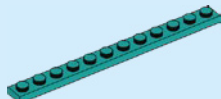

2x  
6391345

54



1x  
4539907



4x  
4164037



2x  
4633822



1x  
4210210



2x  
6132373



1x  
4187743

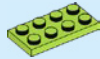

2x  
4537936

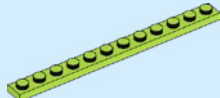

2x  
6392869

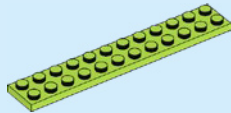

4x  
6392867

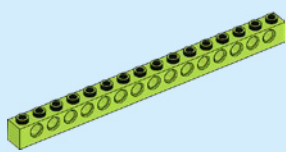

4x  
6132379



2x  
6282101

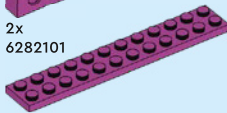

4x  
6093863



4x  
4184108



1x  
4631385



1x  
6224384



1x  
6224385



2x  
6216905



2x  
6135606



1x  
6103405



1x  
4528981



2x  
6097498



1x  
6200663



8x  
6146302



1x  
6166857



4x  
6249596



4x  
6115221



1x  
6253880



1x  
6253881



2x  
6470263



1x  
4177735



2x  
6132566



1x  
6103774



6x  
4530028



18x  
6135597



2x  
6416530



3x  
4667595



1x  
6384913



2x  
4508313



4x  
6027625



6x  
6097420



4x  
6310974



6x  
6097420



4x  
6310974



48x  
6037887



2x  
6167129



1x  
6167130



2x  
6315608



4x  
6035029



4x  
6013102



1x  
6328333



1x  
4586057



1x  
6423386



2x  
6316573



1x  
6099189



3x  
6247895



1x  
6258329



4x  
4655080



6x  
6233984

1x  
6069257

4x  
6184348

3x  
6249817

1x  
6268857

2x  
4568637

8x  
6326478

4x  
6043656

1x  
6273227

5x  
6408022

4x  
4211640

4x  
4211443

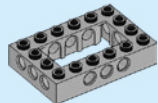

8x  
4211716



1x  
4208988



1x  
4209006



2x  
6136553



2x  
6240515

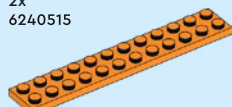

4x  
6313826



7x  
6448317

3x  
4618986

2x  
6097503

3x  
6097509

10x  
4210633

1x  
6039479

1x  
6287847

4x  
6215447

2x  
4619636

1x  
6151663

3x  
6475998

1x  
6152101

1x  
6206809

1x  
6153538

2x  
6151657

1x  
4640891

4x  
6185546

5x  
6151666

1x  
6097444

4x  
6109752

2x  
6126090

1x  
6119126

1x  
4625032

1x  
6233166

1x  
4655256

2x  
6253666

4x  
6426724

2x  
6355730

10x  
6310372

1x  
6305455

1x  
6508093

4x  
6469085

1x  
6296524

2x  
6132422

7x  
403224

88x  
6331822

2x  
370124

2x  
383224

2x  
4514844

2x  
6133611

 [LEGO.com/service](https://www.LEGO.com/service)

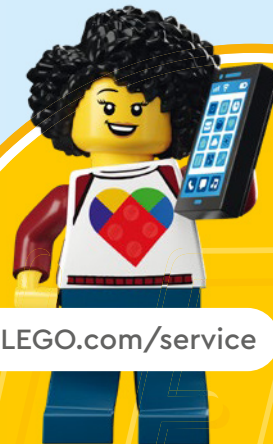

YOU COULD **WIN**



Scan this QR code or go to **LEGO.COM/PRODUCTFEEDBACK** and give us your short feedback about this LEGO® set for a chance to win a cool LEGO prize.

Terms and Conditions apply\*

**EN: YOU COULD WIN.** Terms and Conditions apply\* **DE: Du könntest GEWINNEN.** Es gelten die Teilnahmebedingungen\* **FR: Tu pourrais GAGNER.** Des conditions s'appliquent\* **IT: Potresti VINCERE tu.** Termini e condizioni sono applicabili\* **ES: Puedes GANAR.** Aplican términos y condiciones\* **PT: Poderá GANHAR.** Aplicam-se termos e condições\* **ZH: 轻松获奖. 条款和条件适用\*** **PL: Szansa na WYGRANĄ.** Obowiązują warunki korzystania\* **CS: Máte šanci VYHRÁT.** Platí všeobecné smluvní podmínky\* **SK: Máte šancu VYHRAŤ.** Platia všeobecné zmluvné podmienky\* **HU: TE IS NYERHETSZ.** Felhasználási feltételek érvényesek\* **RO: Ai putea CÂȘTIGA.** Se aplică termeni și condiții\* **BG: Можете да СПЕЧЕЛИТЕ.** Има определени правила и условия\* **LV: Tu vari LAIMĒT.** Ir spēkā noteikumi un nosacījumi.\* **ET: Sul on võimalus VÕITA.** Kehtivad tingimused\* **LT: Jūs galite LAIMĖTI.** Taikomos sąlygos\*

\*[LEGO.com/productfeedback-terms](https://www.lego.com/productfeedback-terms)

LEGO and the LEGO logo are trademarks of the/son des marques de commerce du/son marcas registradas de LEGO Group.  
©2024 The LEGO Group.

6532164