



41838





### **Get excited about our new packaging!**

We're switching from plastic to paper-based packaging. That's why you might find a mix of paper and plastic in our boxes!

### **Nos nouveaux emballages vous emballeront !**

Nous passons des emballages en plastique aux emballages à base de papier. C'est pourquoi vous pourriez trouver un mélange de papier et de plastique dans nos boîtes !

### **¡Te presentamos nuestros nuevos empaques!**

Estamos sustituyendo las bolsas de plástico por bolsas con base de papel. ¡Por eso, puedes encontrar una mezcla de papel y de plástico en nuestras cajas!

**[LEGO.com/sustainable-packaging](https://www.lego.com/sustainable-packaging)**

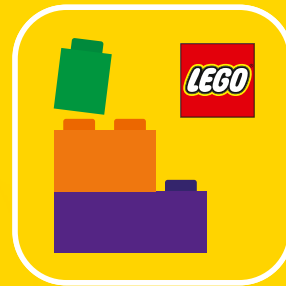

🔍 LEGO® Builder

# BUILDER

Download on the  
App Store

GET IT ON  
Google Play

腾讯应用宝  
安卓应用商店

Apple and the Apple logo are trademarks of Apple Inc., registered in the U.S. and other countries and regions. App Store is a service mark of Apple Inc. Google Play and the Google Play logo are trademarks of Google LLC. Tencent and the Tencent logo are trademarks of Tencent Inc.

🔍 [LEGO.com/devicecheck](https://LEGO.com/devicecheck)

EN Ask parents' permission before going online | DE Eltern um Erlaubnis bitten, bevor du online gehst | FR Demande l'autorisation d'un parent avant d'aller en ligne | IT Chiedi il permesso ai tuoi genitori prima di andare online | ES Pídeles permiso a tus papás antes de conectarte a Internet | PT Peça autorização aos pais antes de acederes online | ZH 上网前应先征得父母的同意 | PL Poproś rodziców o zgodę, zanim wejdiesz do Internetu | CS Než půjdeš na internet, požádej rodiče o svolení | SK Skôr než pôjdeš na internet, vypýtaj si povolenie od rodičov | HU Kérj szülői engedélyt, mielőtt online csatlakoznál! | RO Cere permisiunea părinților înainte de a te conecta online | BG Поискайте разрешение от родител, преди да влезете онлайн | LV Pirms došanās tiešsaistē palūdz atļauju vecākiem | ET Enne Interneti kasutamist küsi vanematelt luba | LT Prieš prisijungdami prie interneto, atsklauskite tėvų



# Let the family fun take flight!

When you open up this LEGO® set, everyone is invited to create and play. So, gather your family, friends, partners, cousins, or neighbors, and fly off to new corners of your imagination together onboard your own World Wonderliner!



# Le plaisir en famille prend son envol !

Cet ensemble LEGO® invite tout le monde à créer et à jouer. Alors, réunissez votre famille, vos amis, vos cousins ou vos voisins, et envolez-vous vers de nouveaux recoins de votre imagination à bord de votre World Wonderliner !

# ¡Haz que la diversión familiar emprenda el vuelo!

Abrir este set LEGO® es sinónimo de una invitación a crear y jugar para todos. Así que reúne a tus familiares, amigos, pareja, primos o vecinos, ¡y vuelen juntos hacia nuevos rincones de la fantasía a bordo de su propio World Wonderliner!



## COMBINE AND CONQUER

*With five engaging builds, five intuitive building instructions booklets and five brick separators, this set is made to be social. Have even more builders? Try building in teams. Here, your combined creativity knows no borders, and everyone can play a part in creating a shared world.*

## COMBINEZ ET CONQUÉREZ

*Avec ses cinq constructions captivantes, ses cinq livrets d'instructions de construction intuitifs et ses cinq séparateurs de briques, cet ensemble est fait pour être partagé. Vous avez plus de constructeurs ? Essayez de construire en équipes. Ici, votre créativité combinée ne connaît pas de frontières, et chacun peut jouer un rôle dans la création d'un monde commun.*

## COMBINA Y CONQUISTA

*Con cinco atractivos modelos, cinco intuitivos folletos de instrucciones de construcción y cinco separadores de bricks, este set está diseñado como una experiencia social. ¿Hay aún más constructores? La posibilidad de participar por equipos siempre está sobre la mesa. No existen los límites para la creatividad combinada, ¡y así todos tienen algo que aportar a la creación de un mundo compartido!*

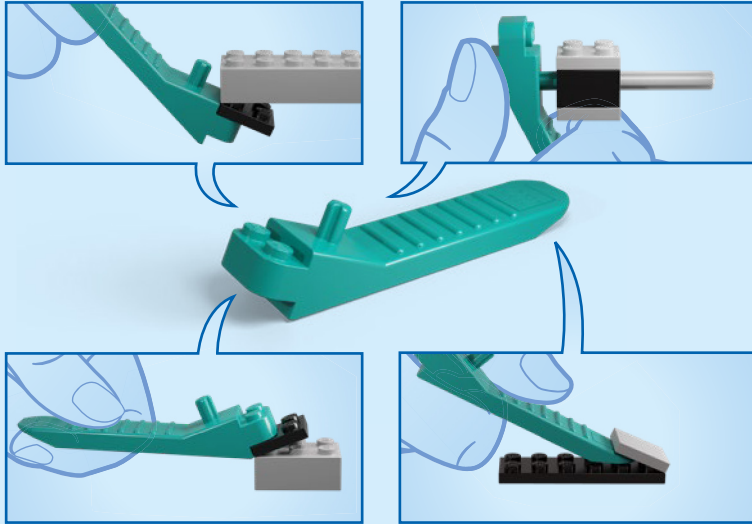

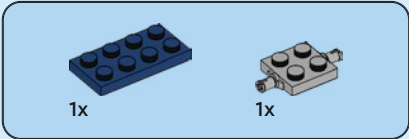
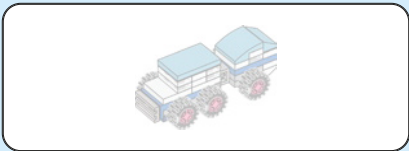

1

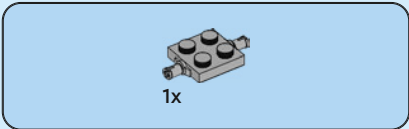
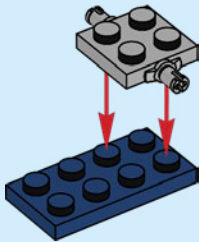

2

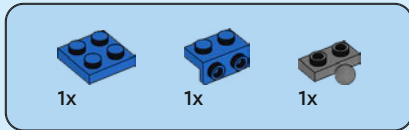
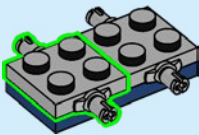

3

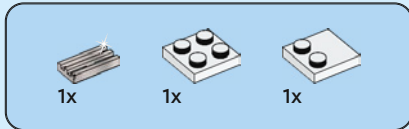
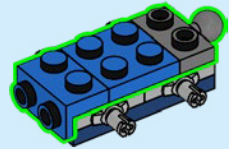

4

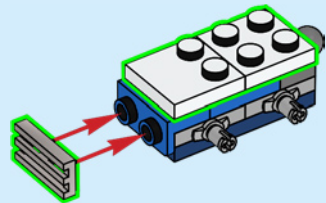



2x

5

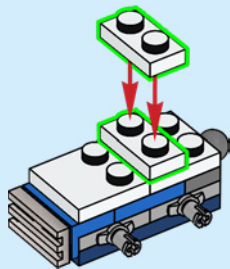

4x

6

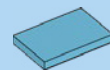
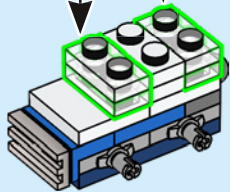
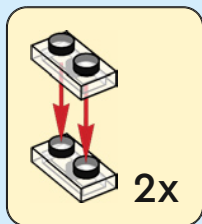

1x

7

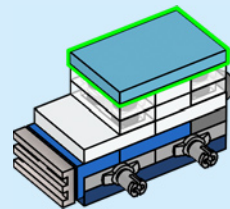

4x



4x

8

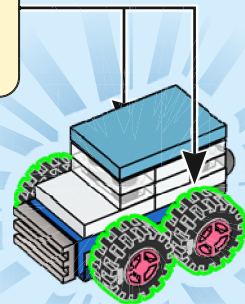



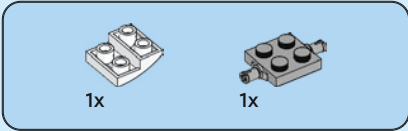

9

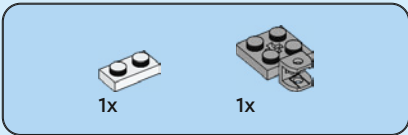
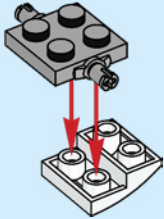

10

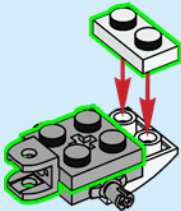

11

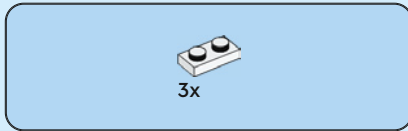
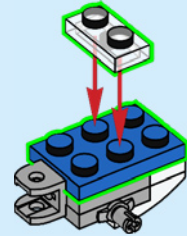

12

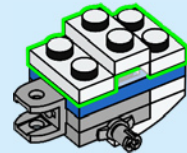

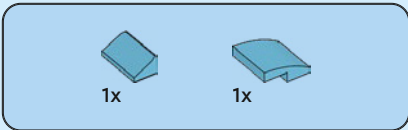

13

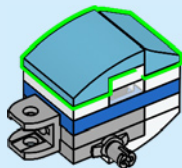

14

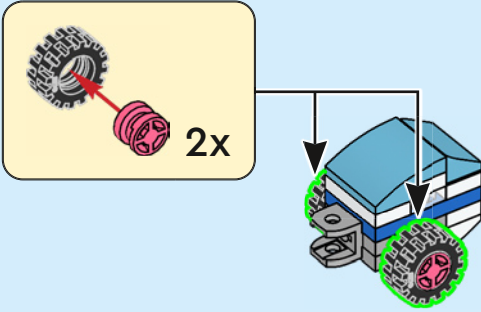

15

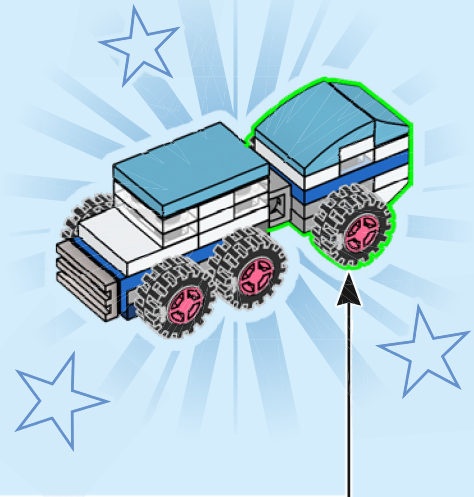

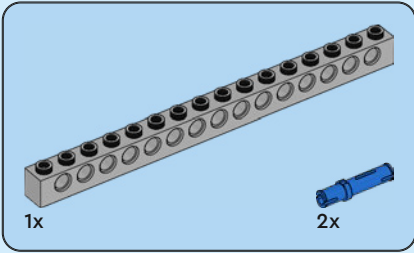
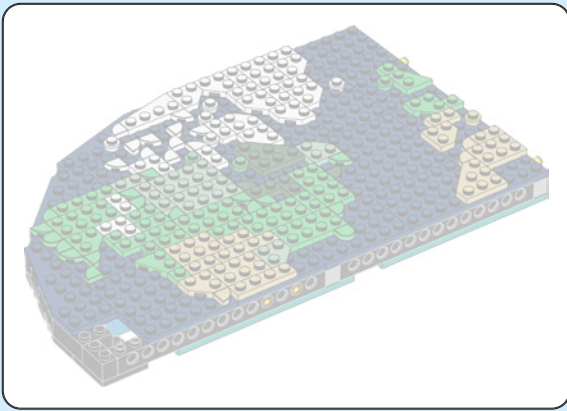

1

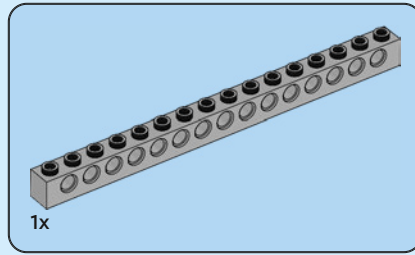
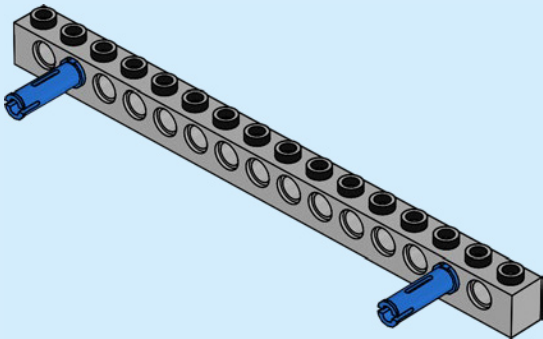

2

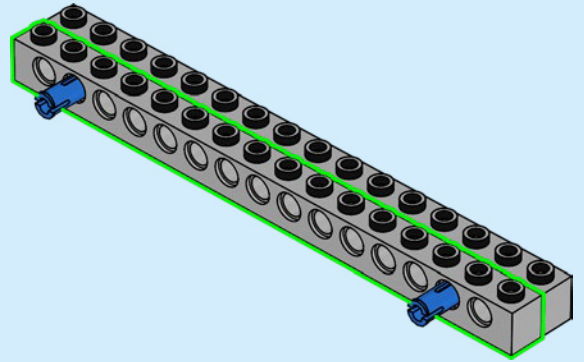

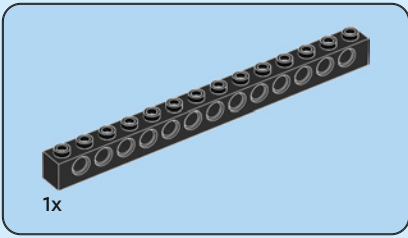

3

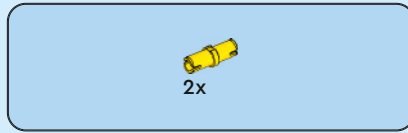
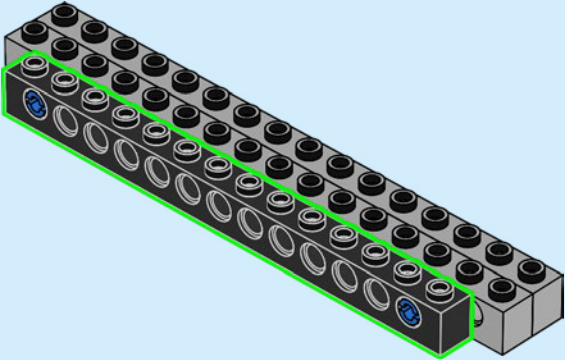

4

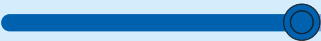
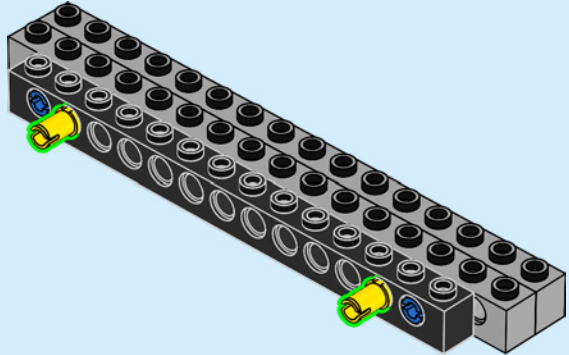

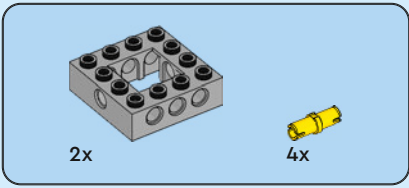

5

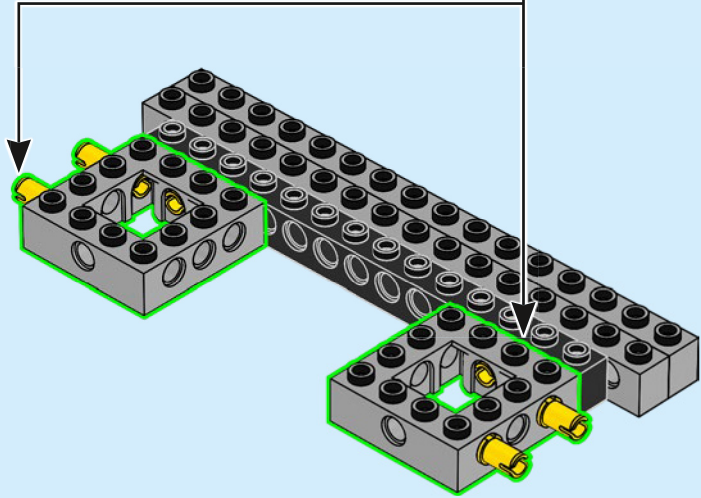
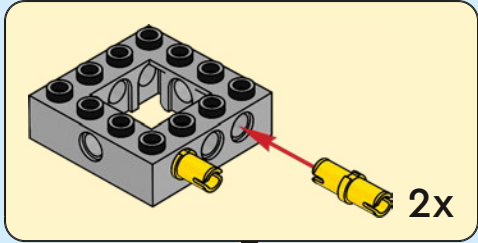

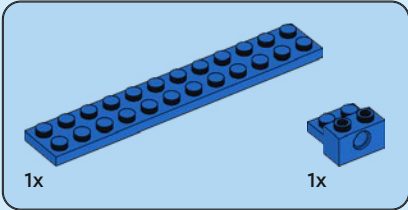
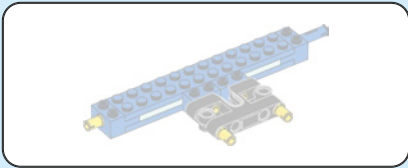

6

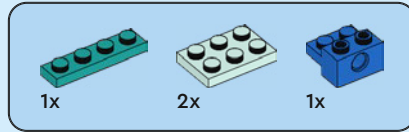
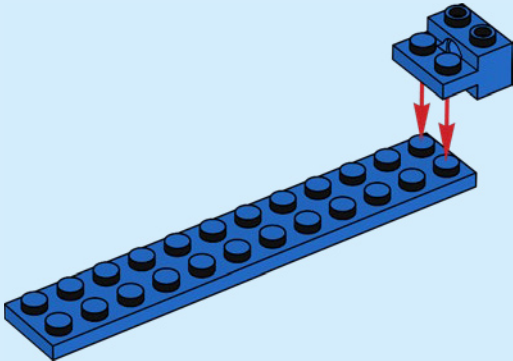

7

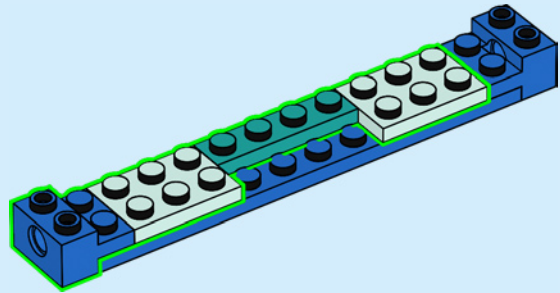

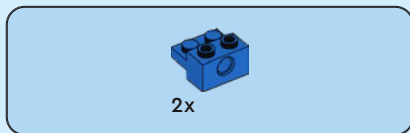

8

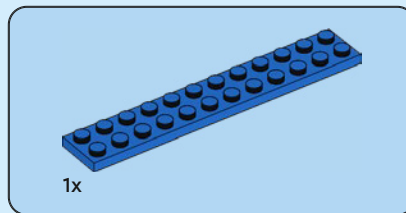
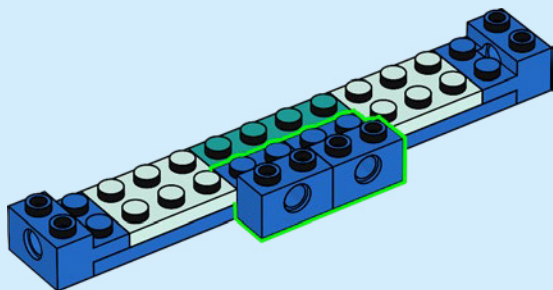

9

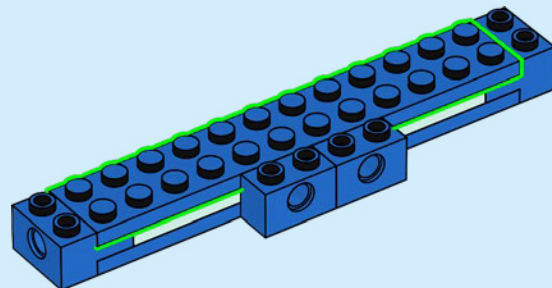

10

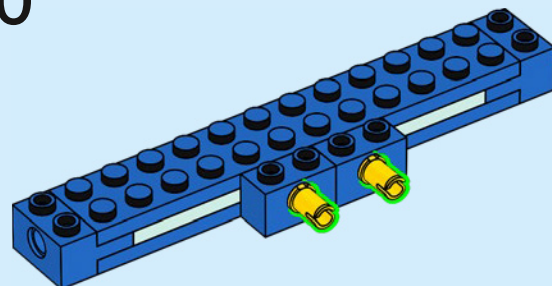

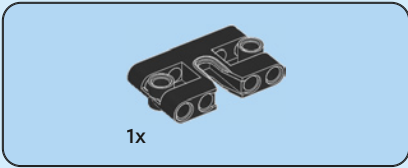

11

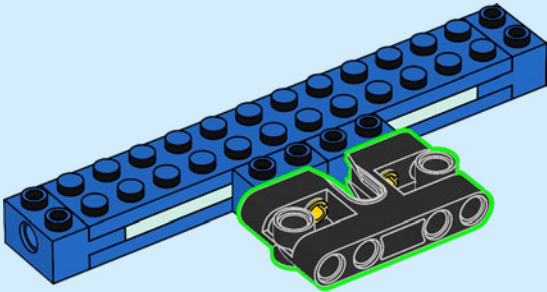

12

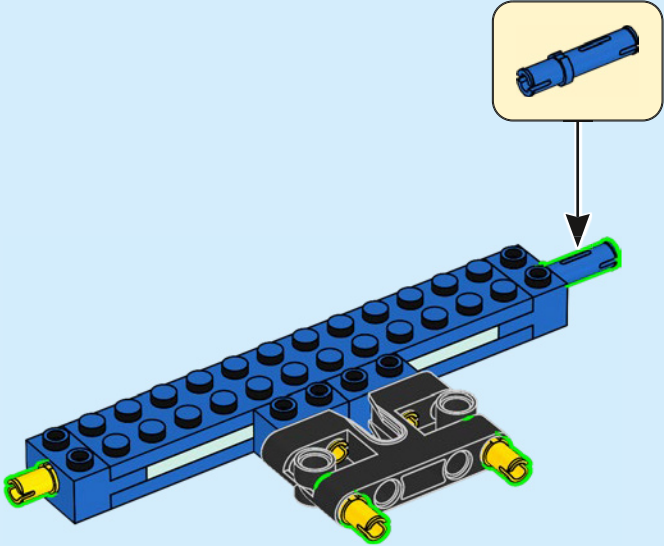



13

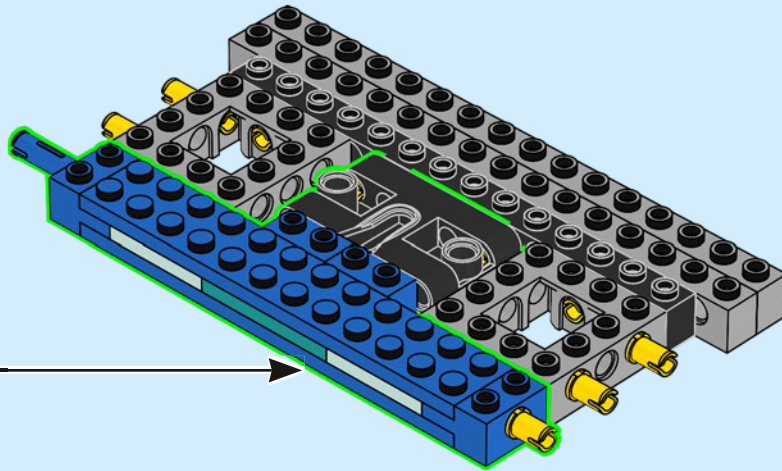

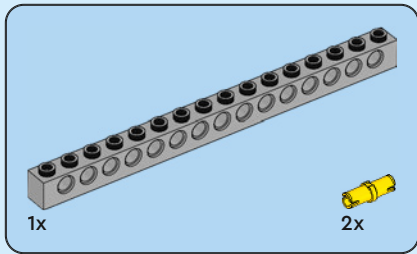

14

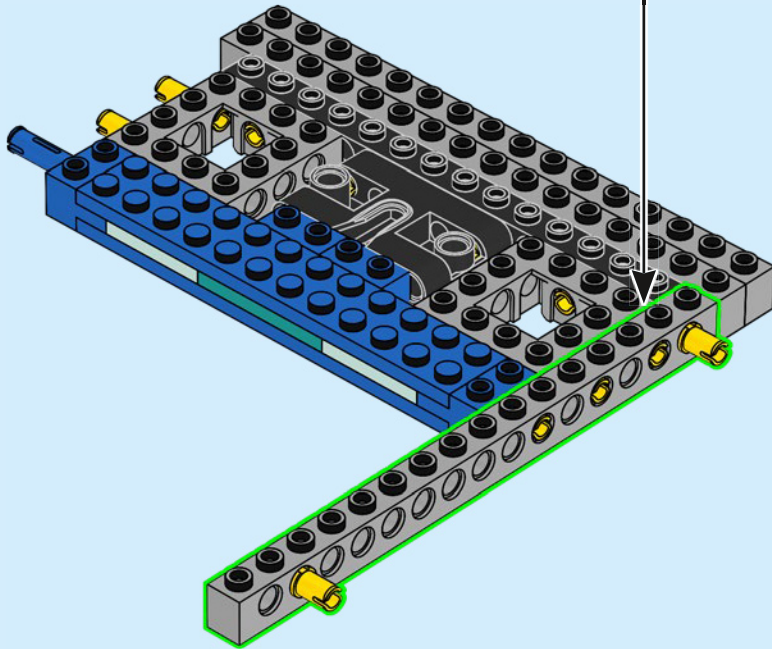
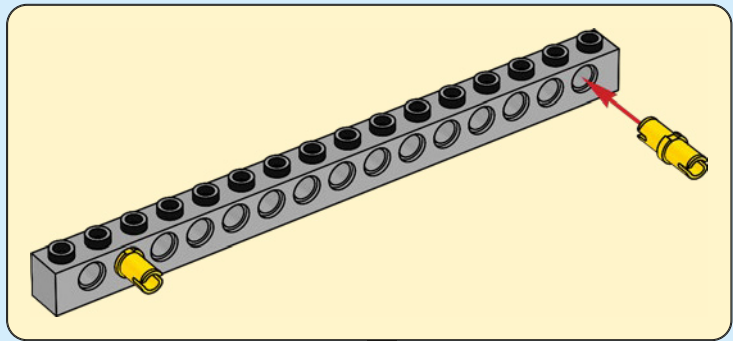



15

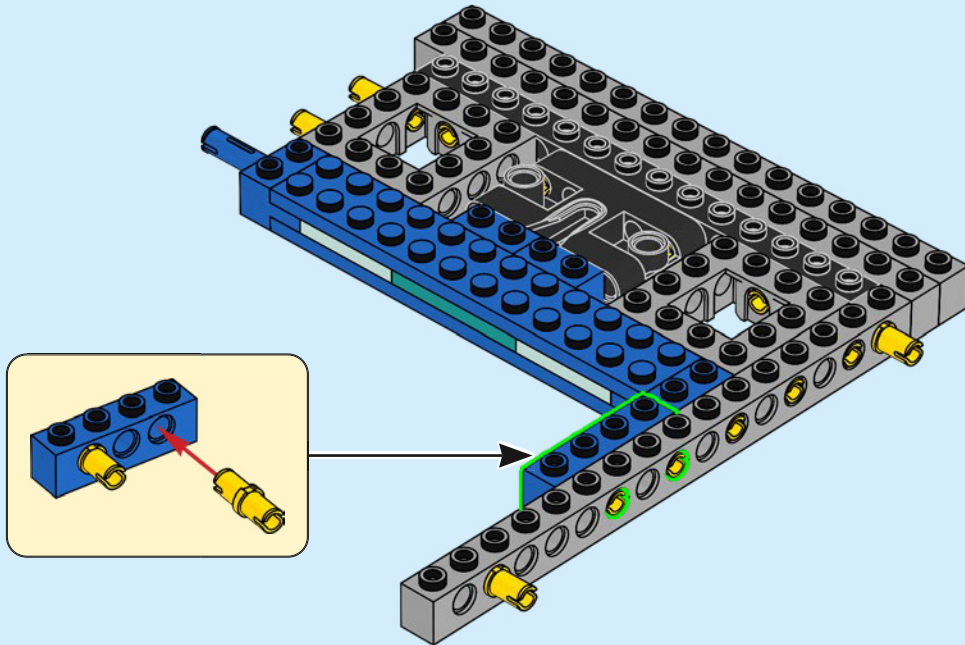

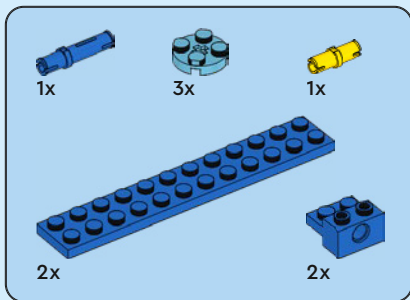

16

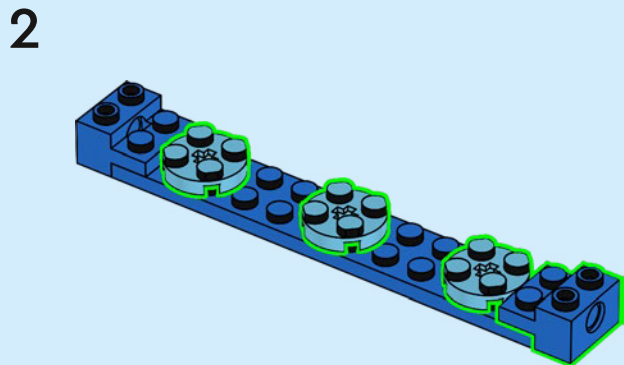
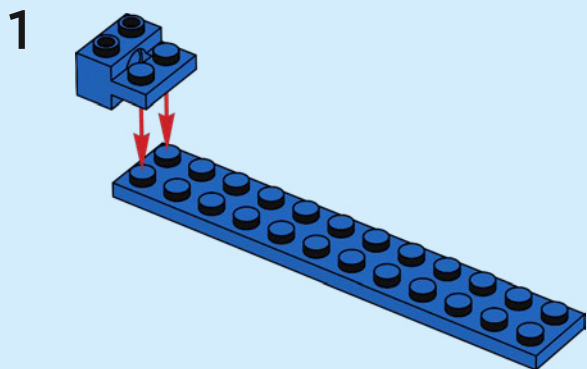

3

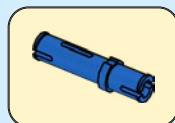
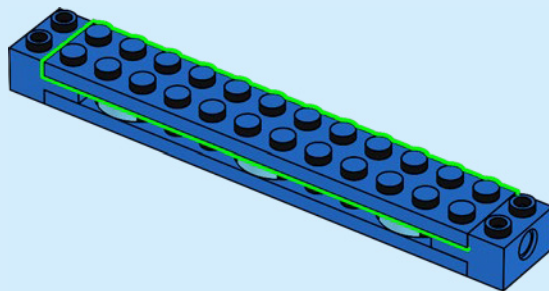

4

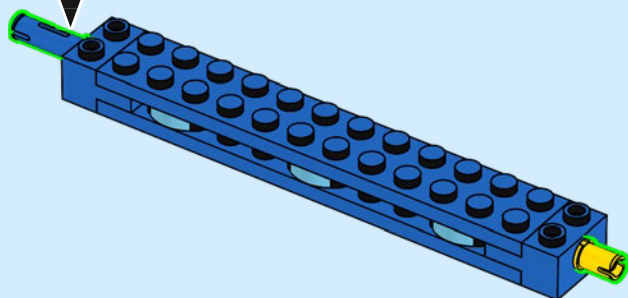

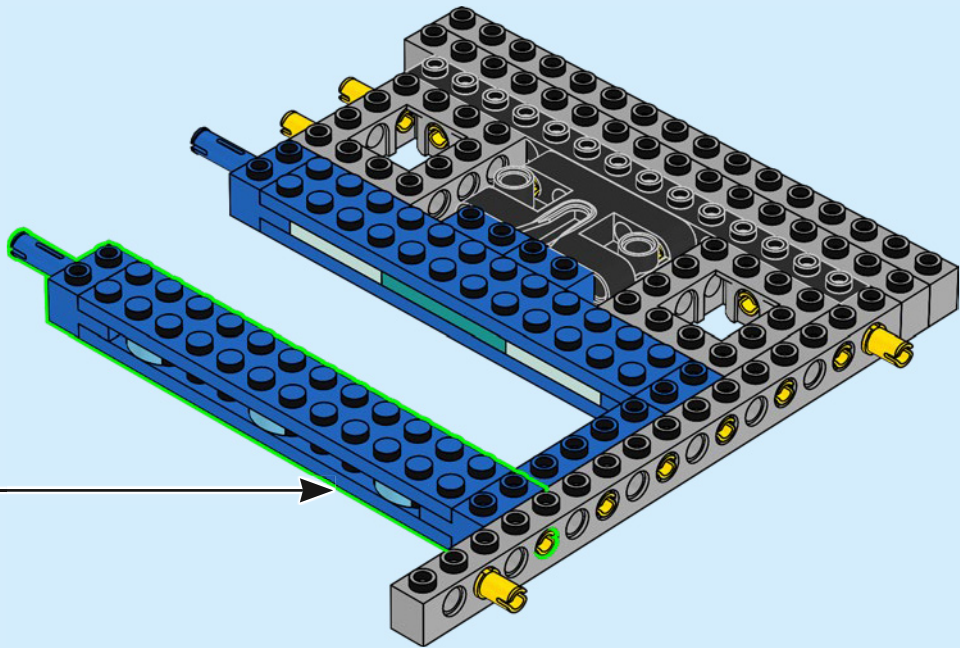

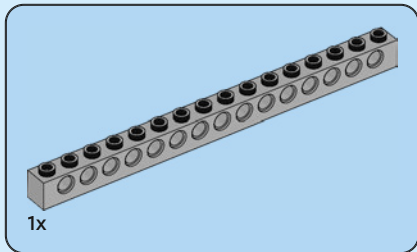

17

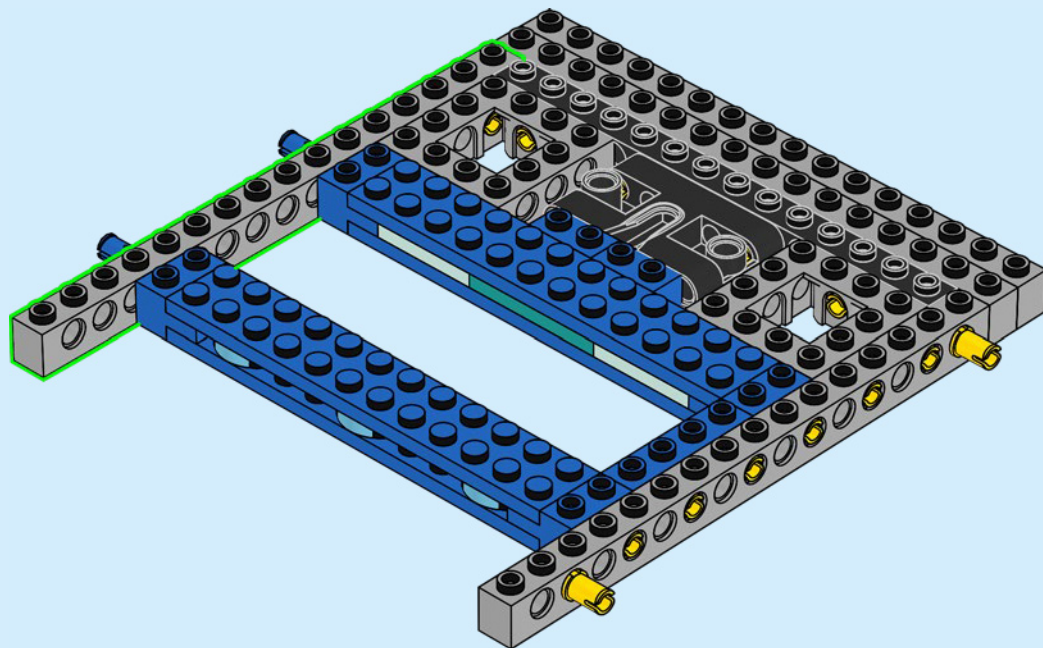

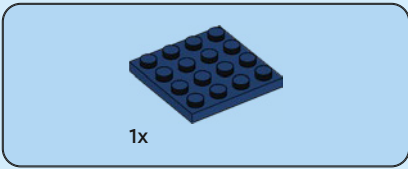

18

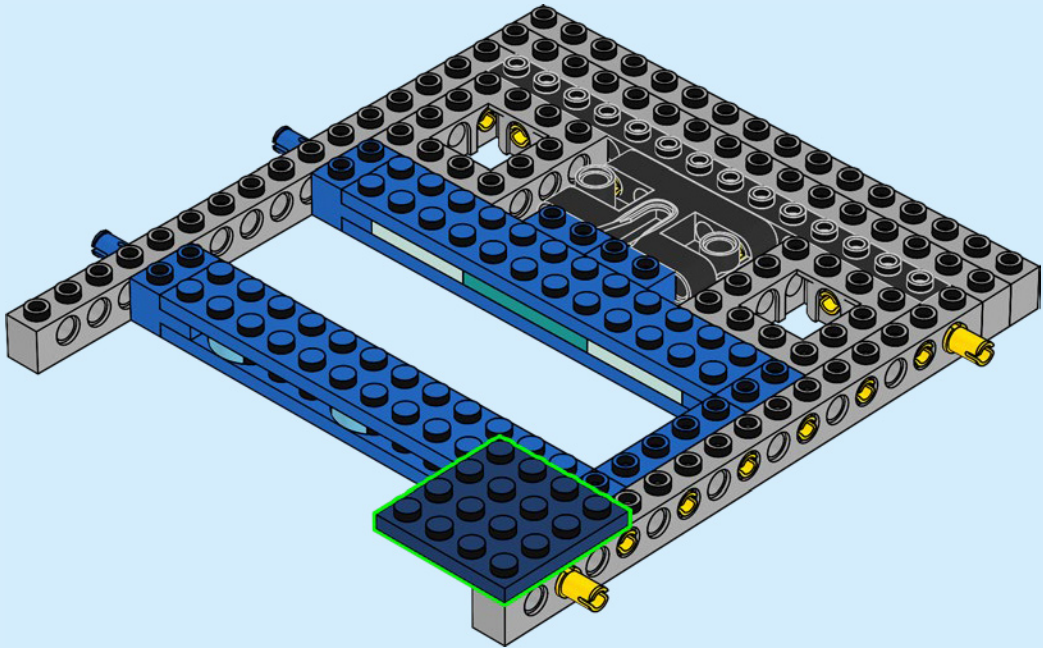

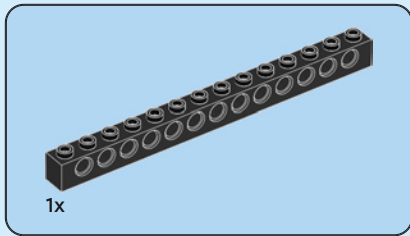

19

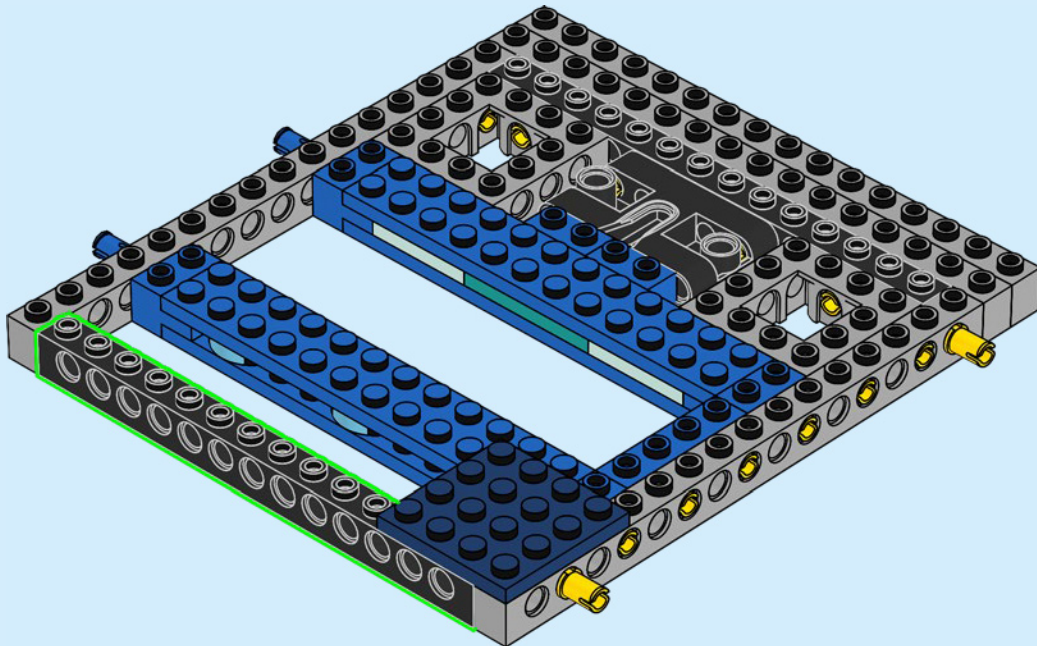



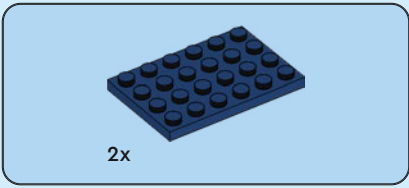

20

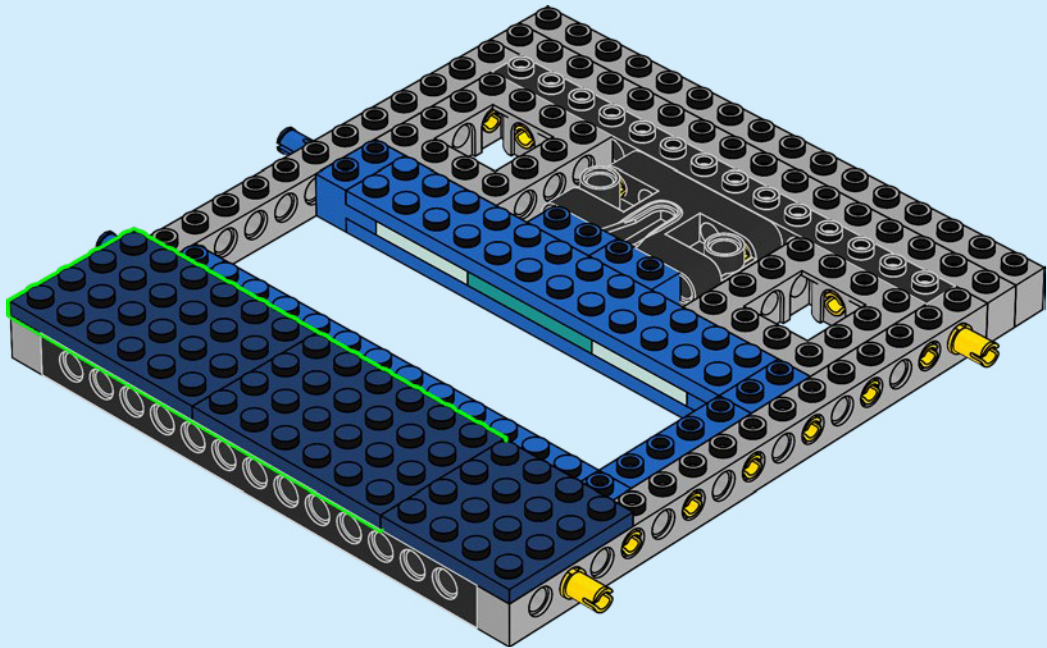

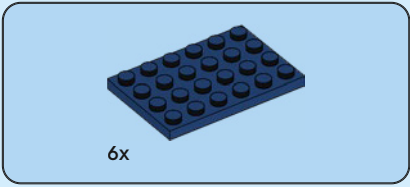

21

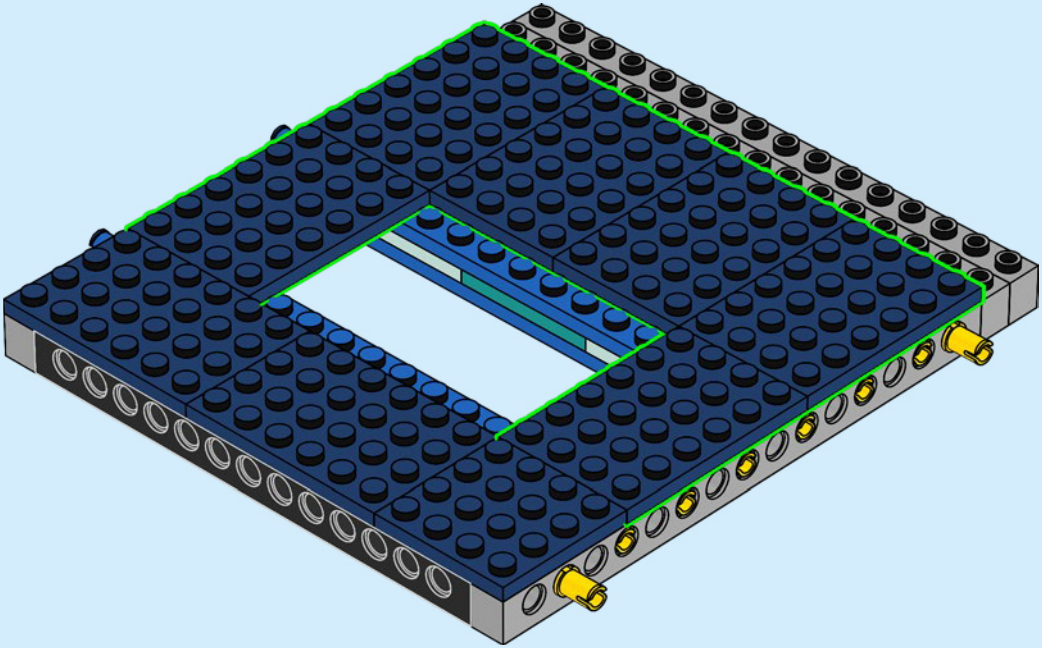

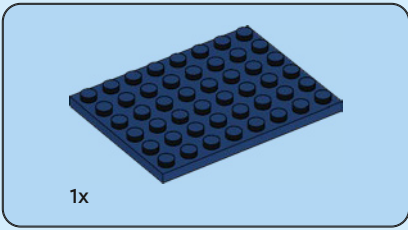

22

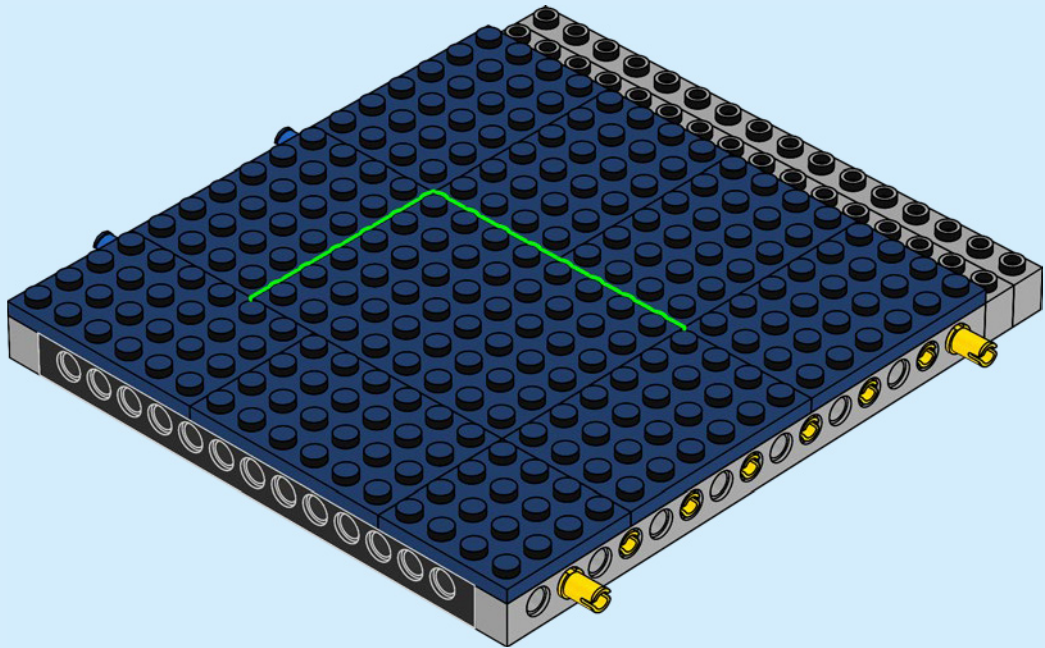

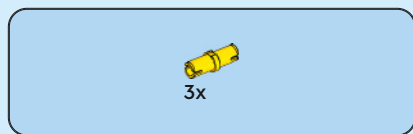

23

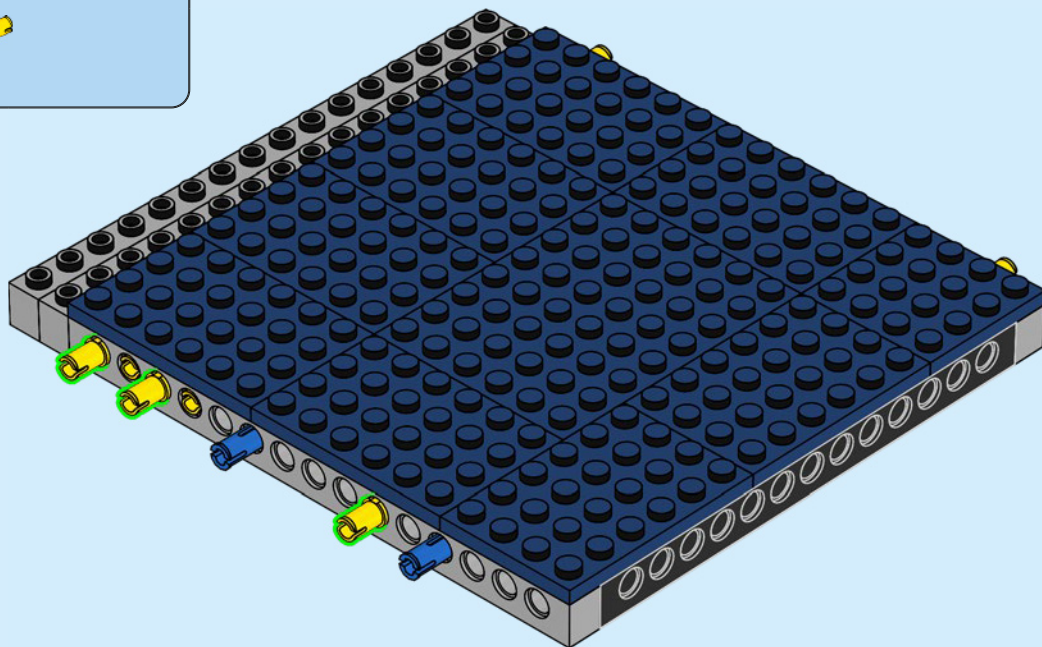

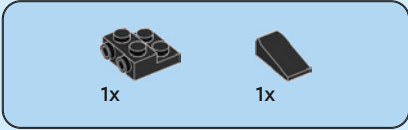
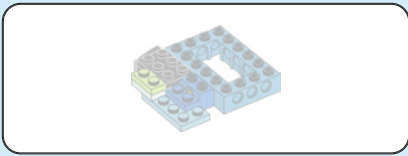

24

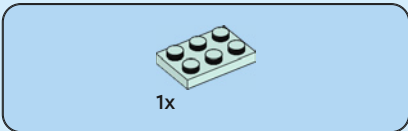
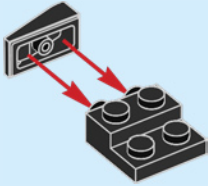

25

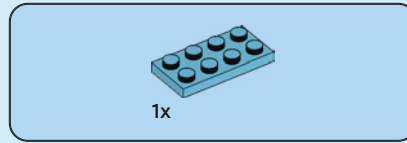
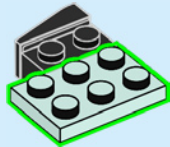

26

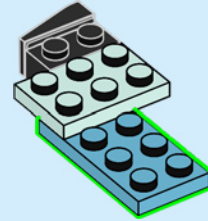

27

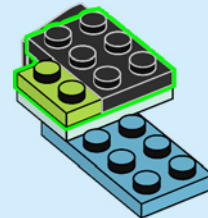

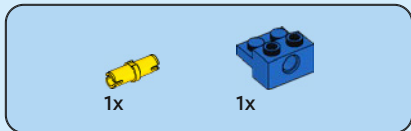

28

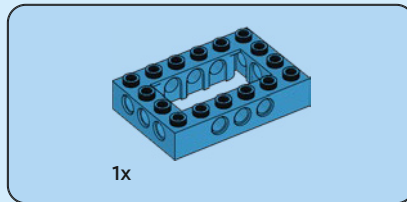
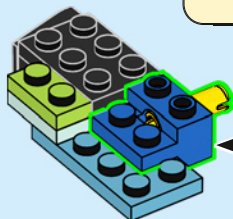
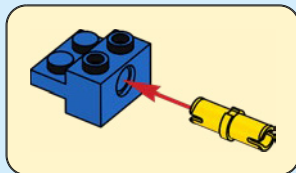

29

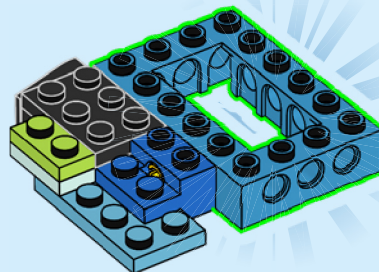

30

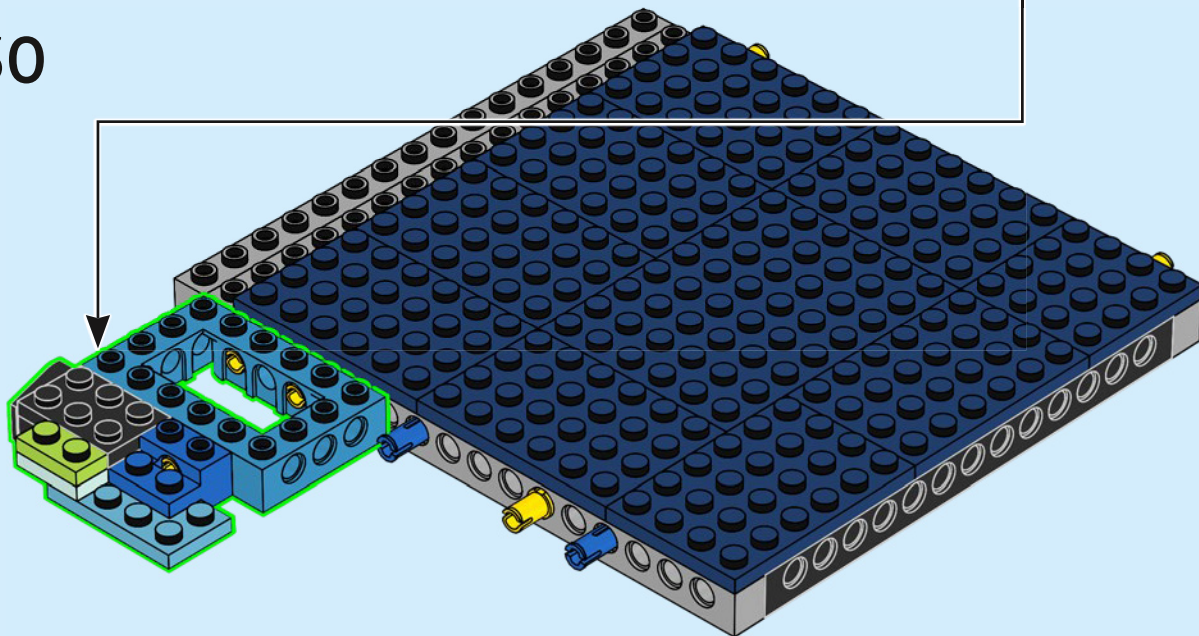

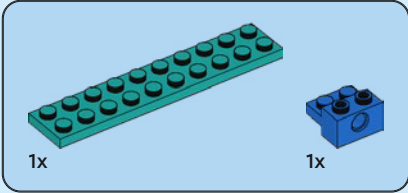
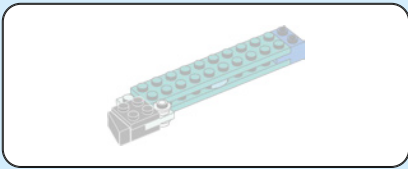

31

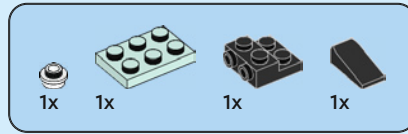
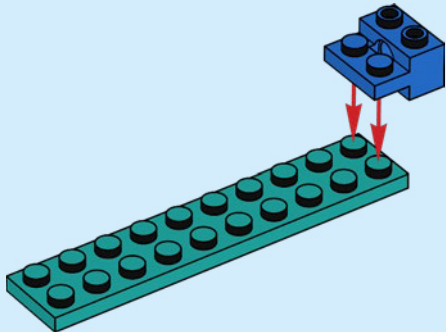

32

1

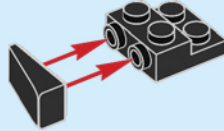

2

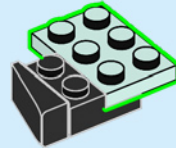

3

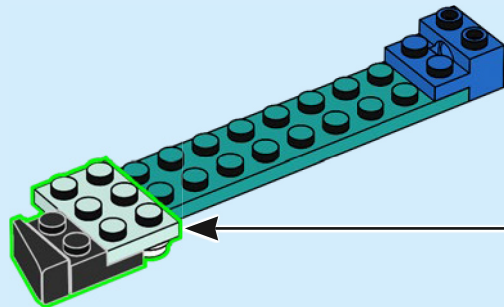
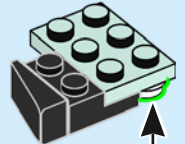



33

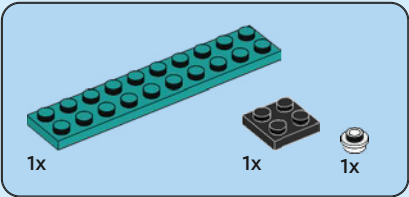
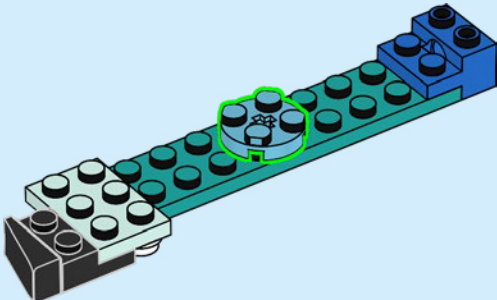

34

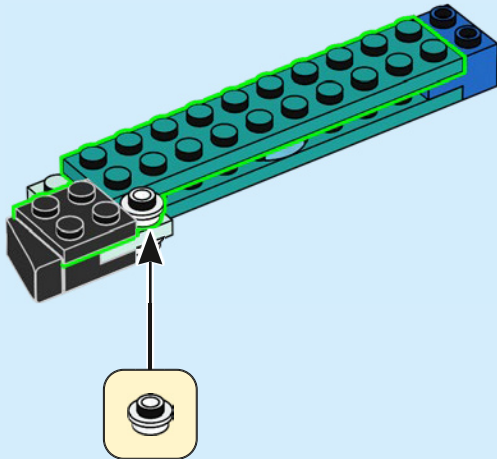



35

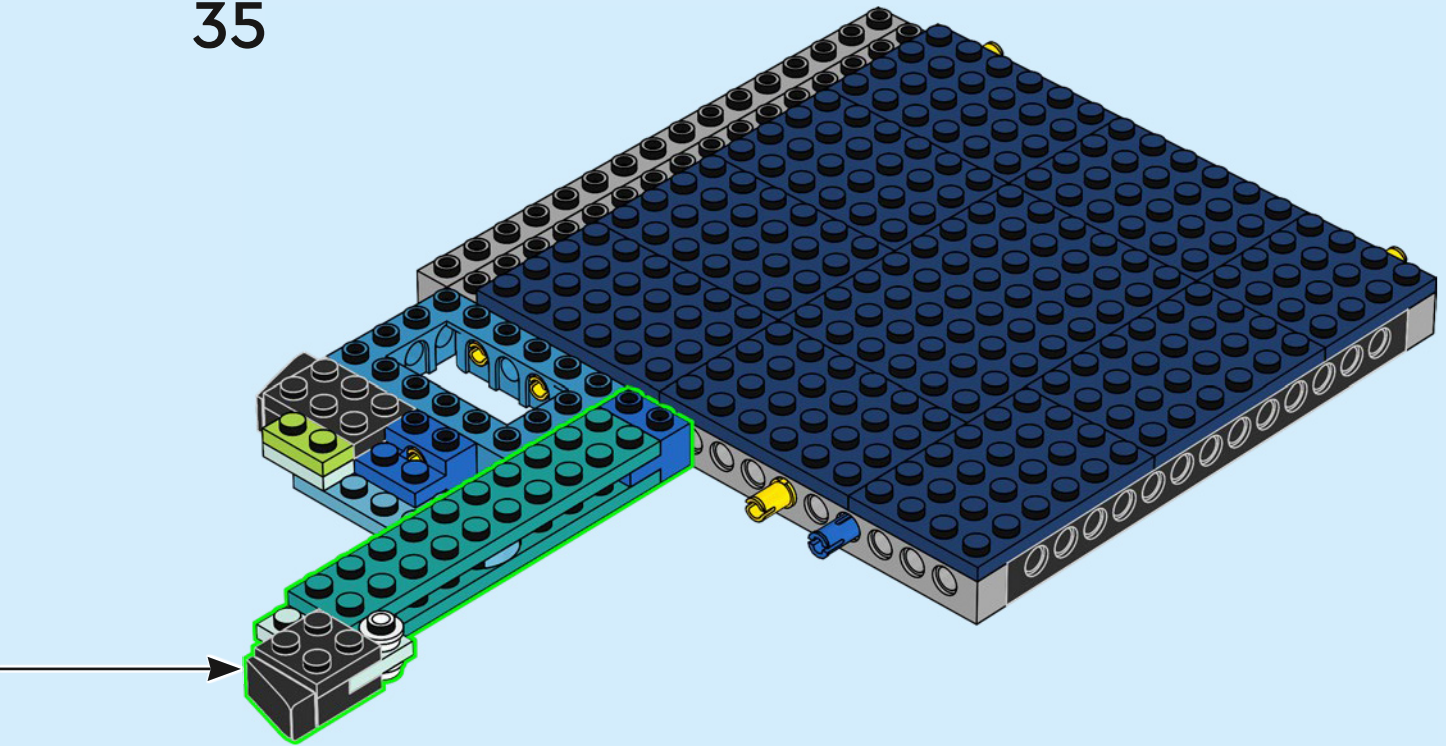

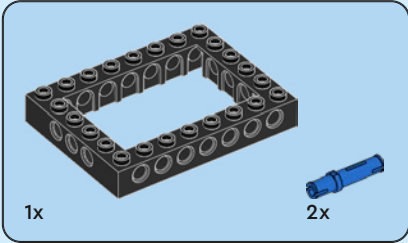
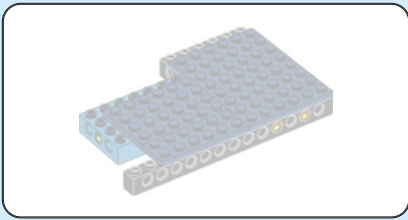

36

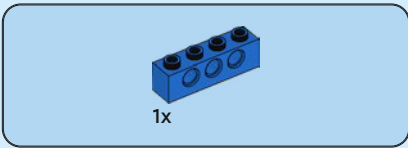
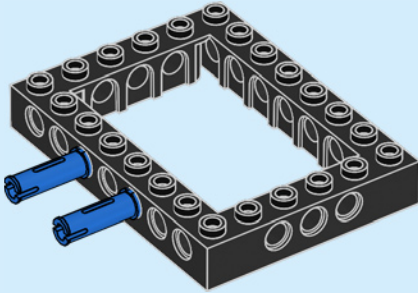

37

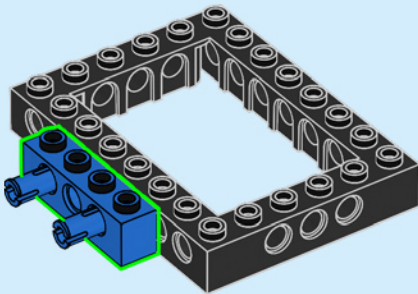

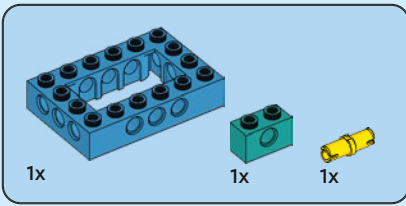

# 38

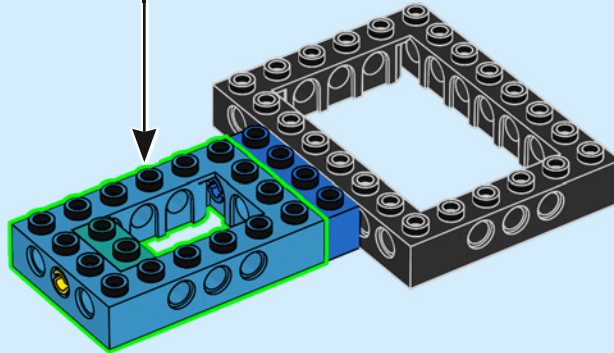
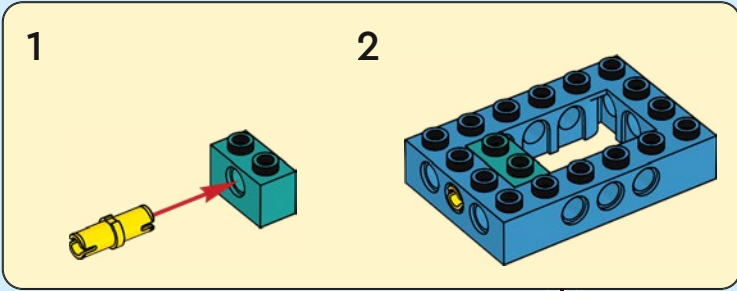

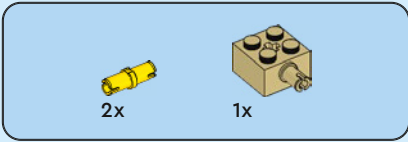

39

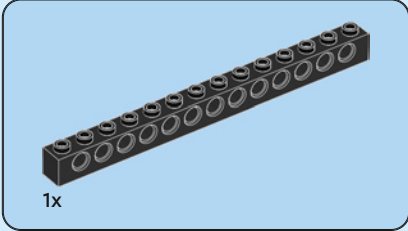
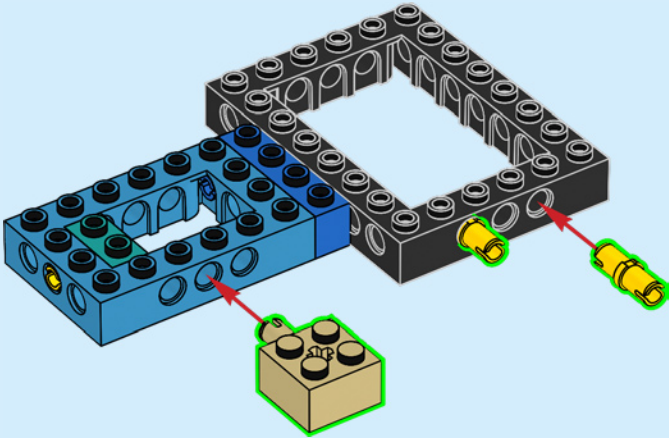

40

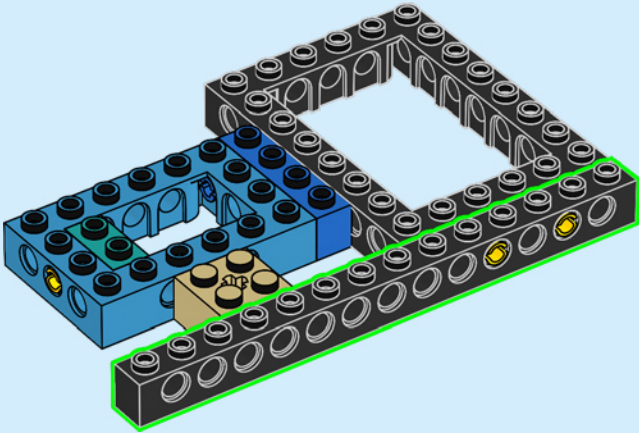

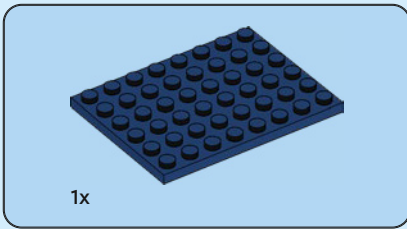

41

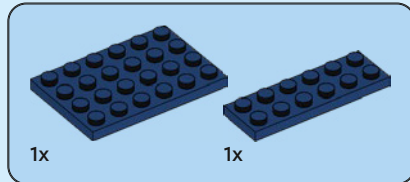
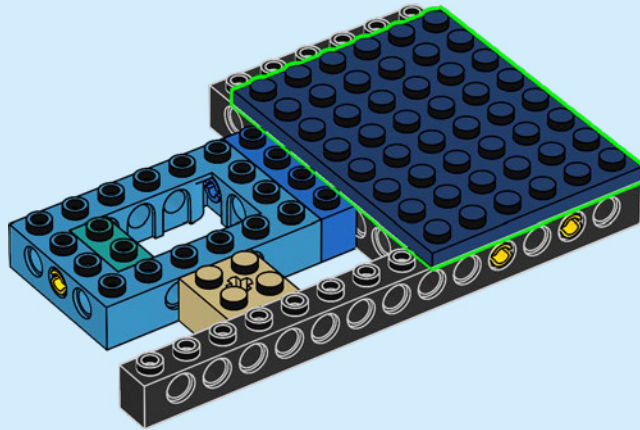

42

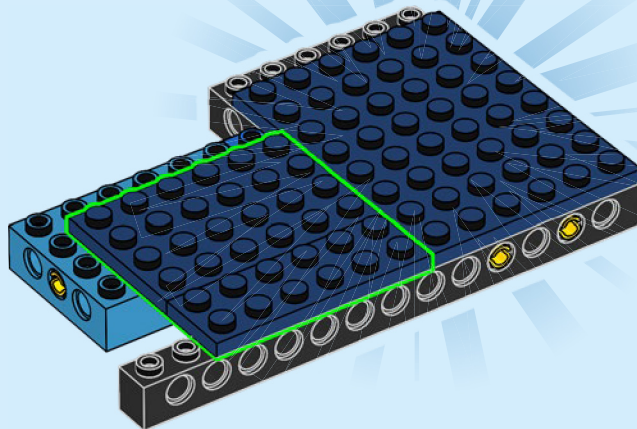

43

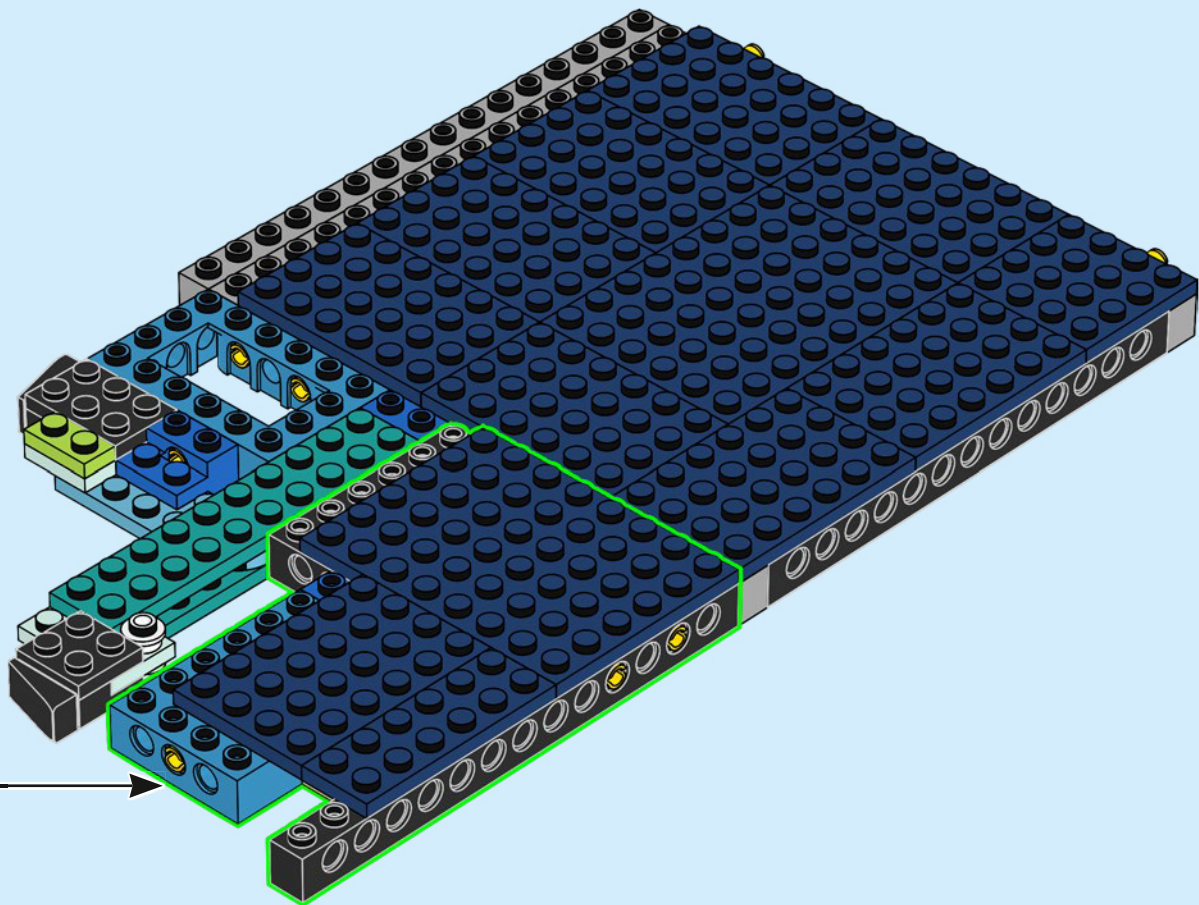

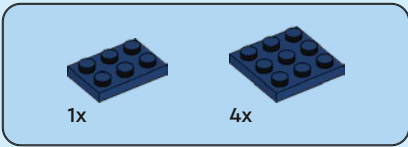

44

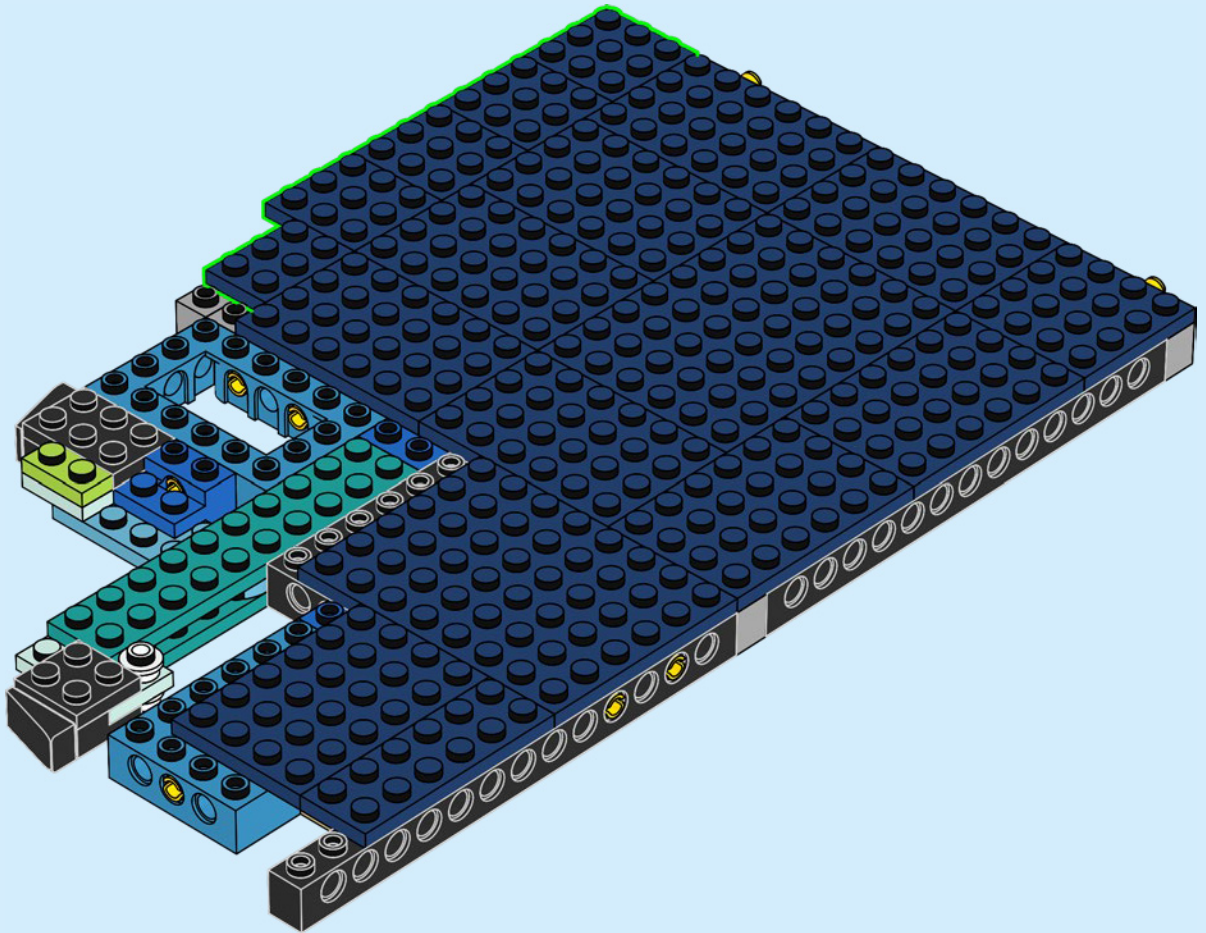

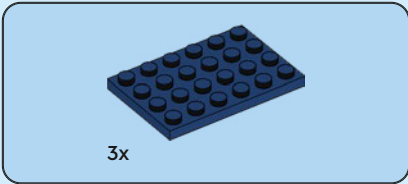

45

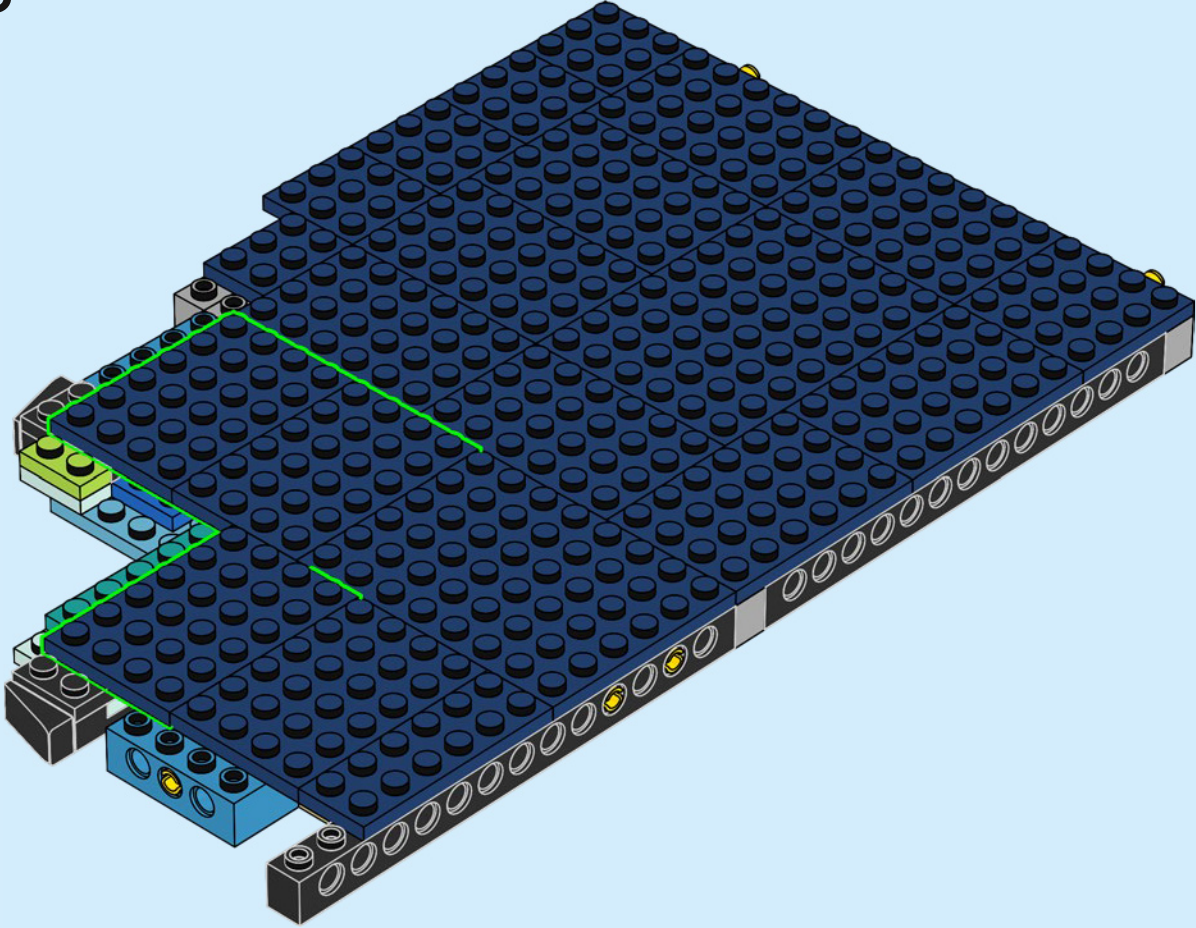



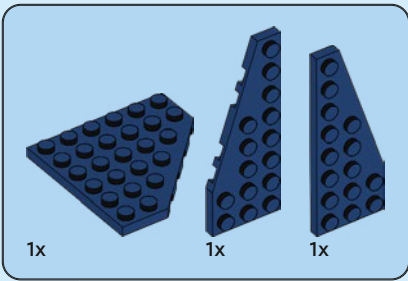

46

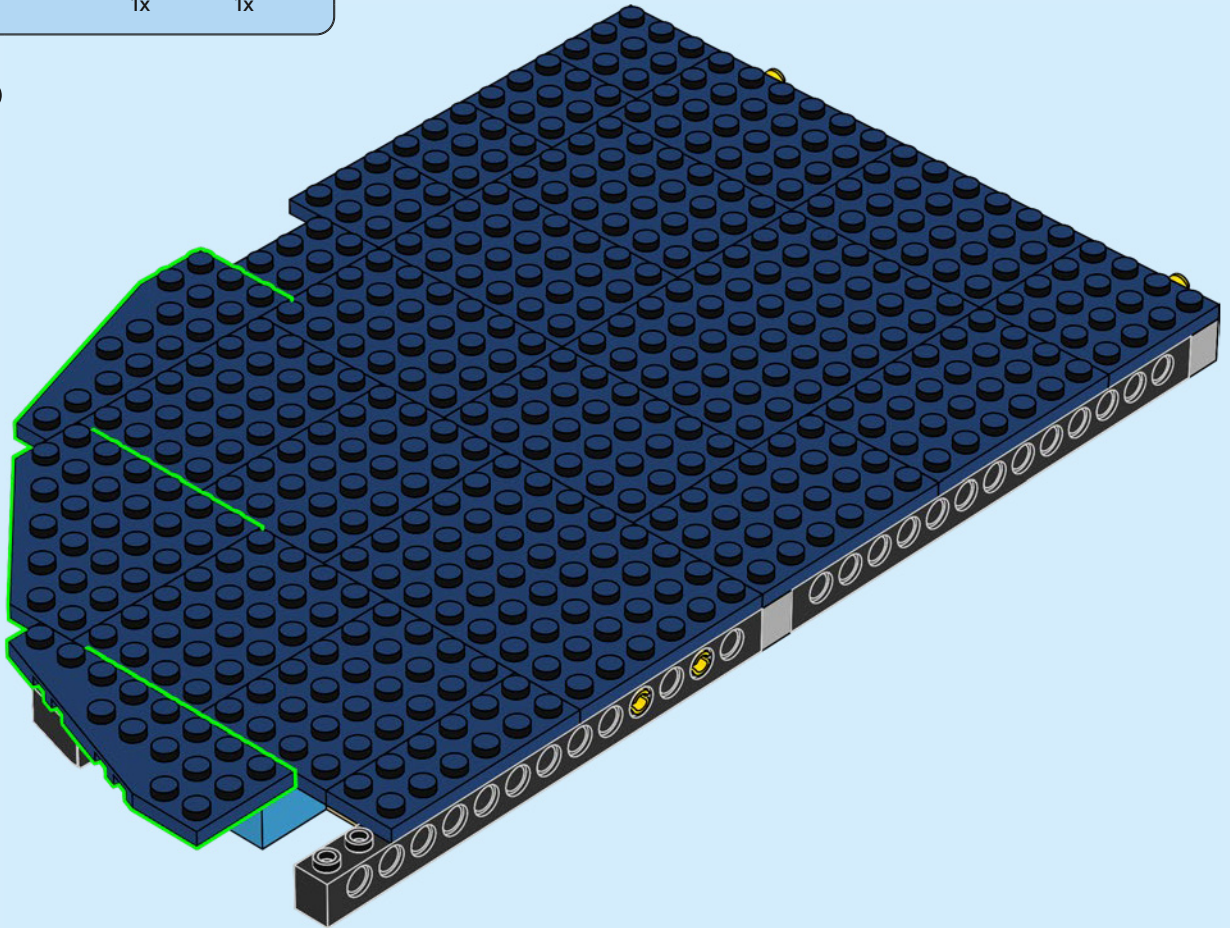

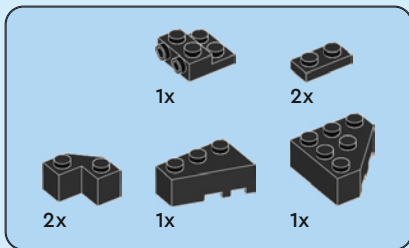

47

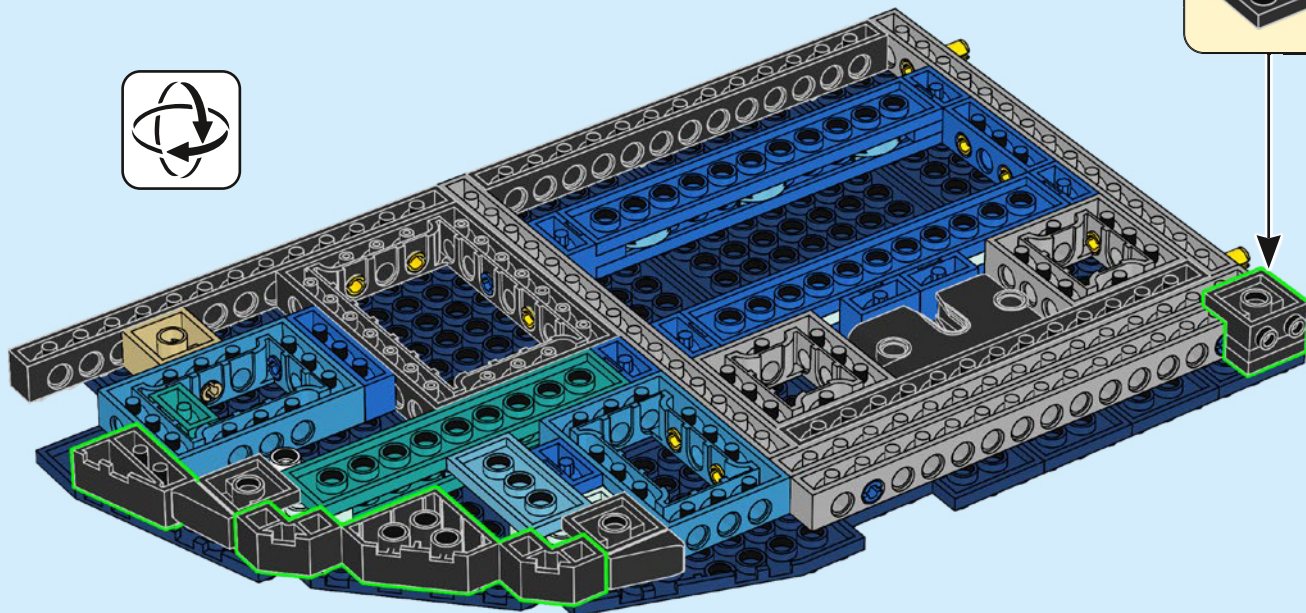
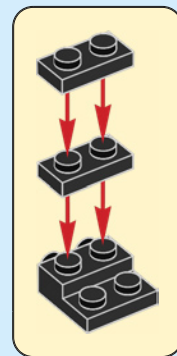

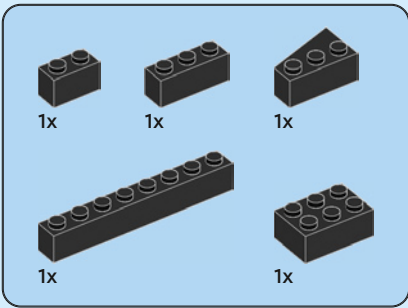

48

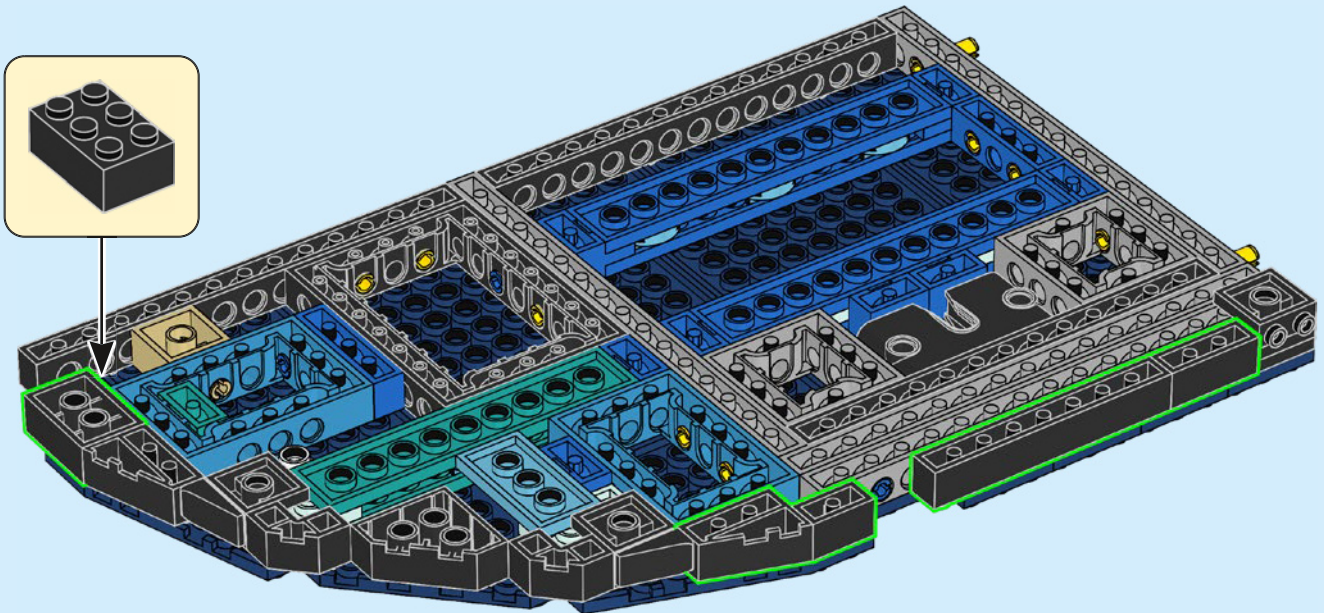

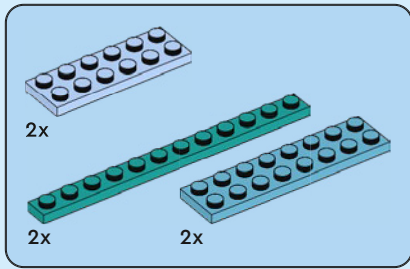

49

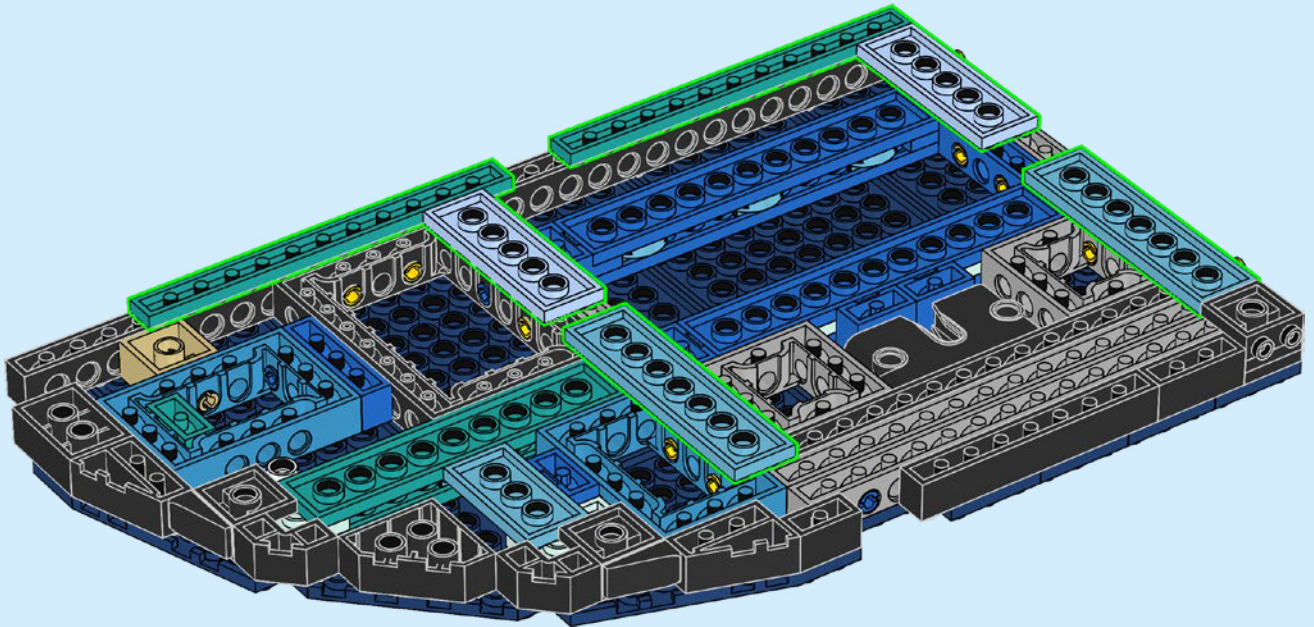

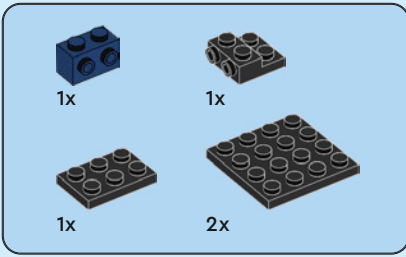

50

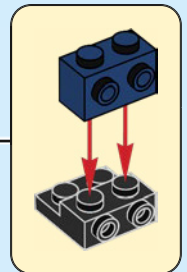
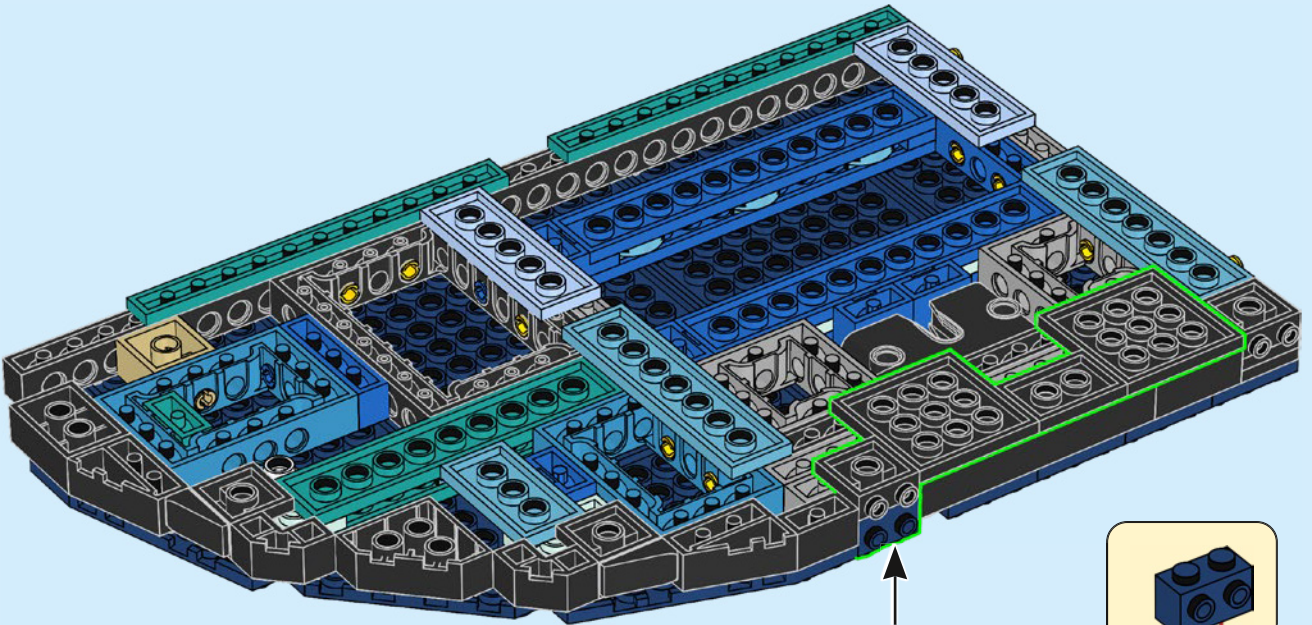

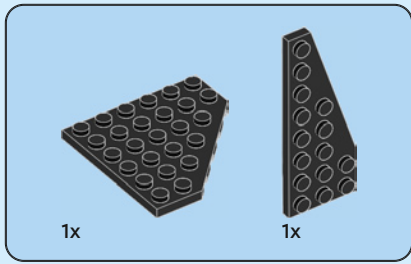

51

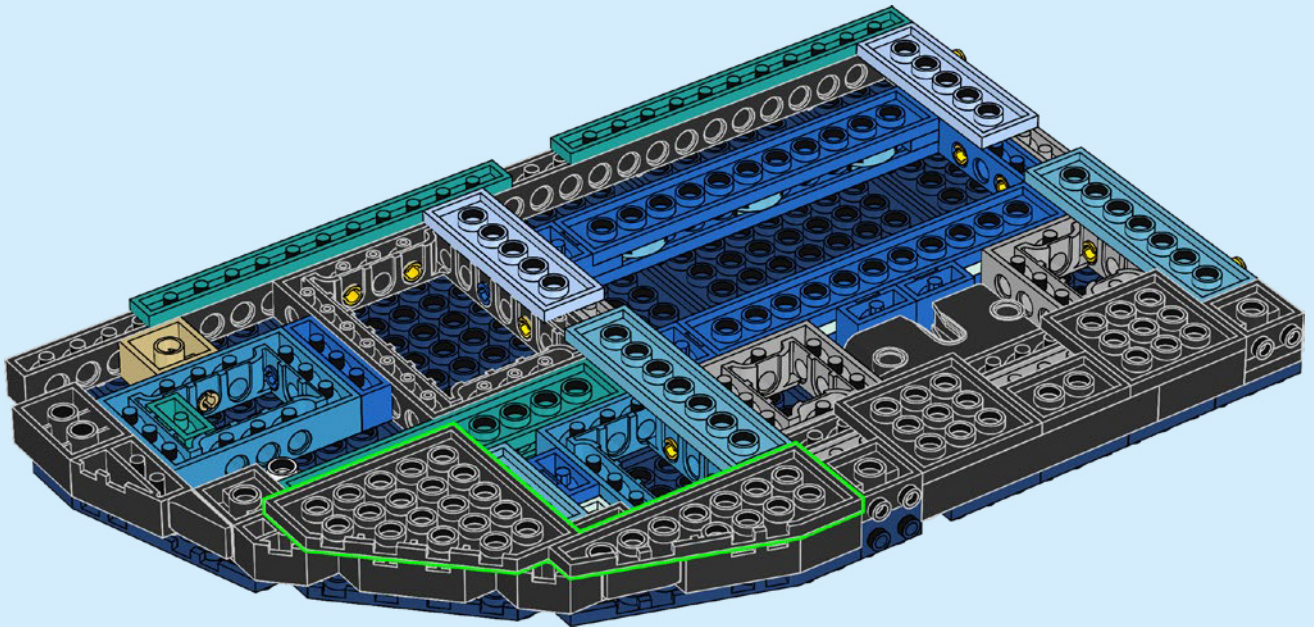

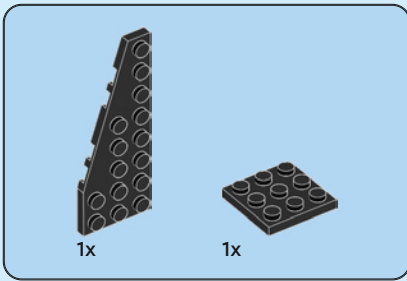

52

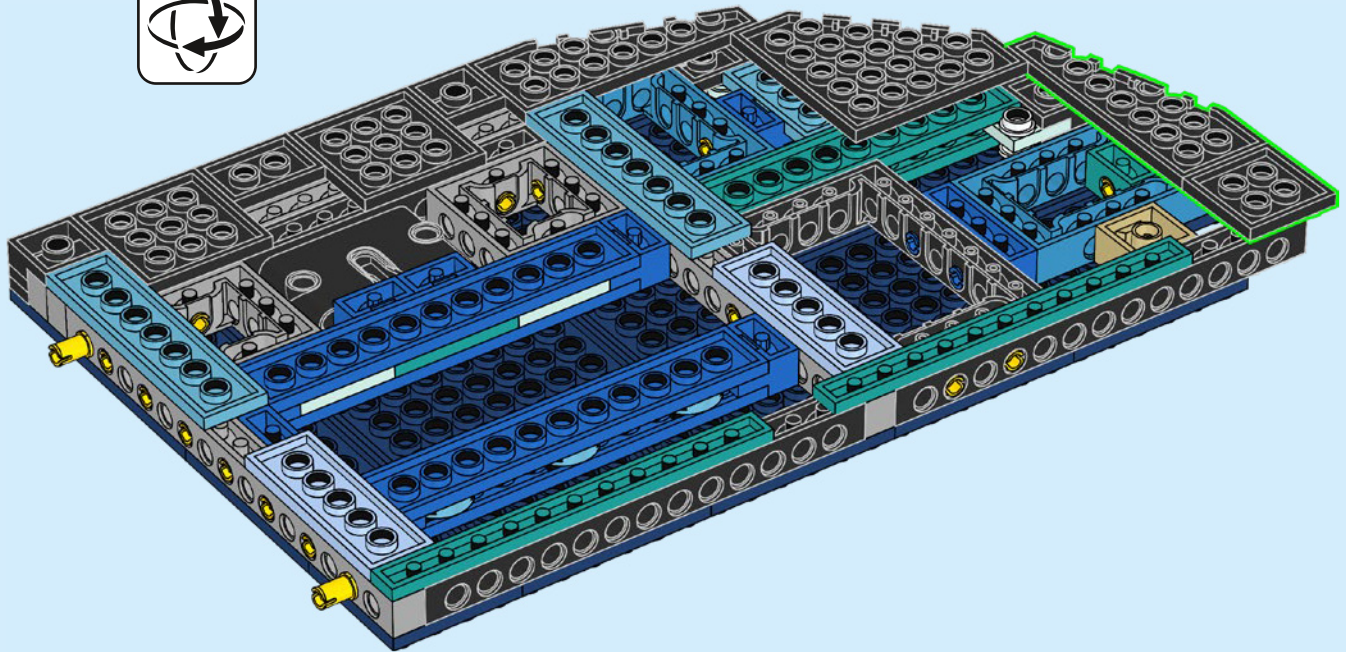

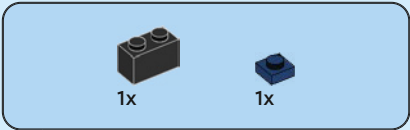

53

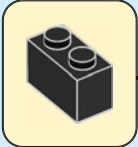
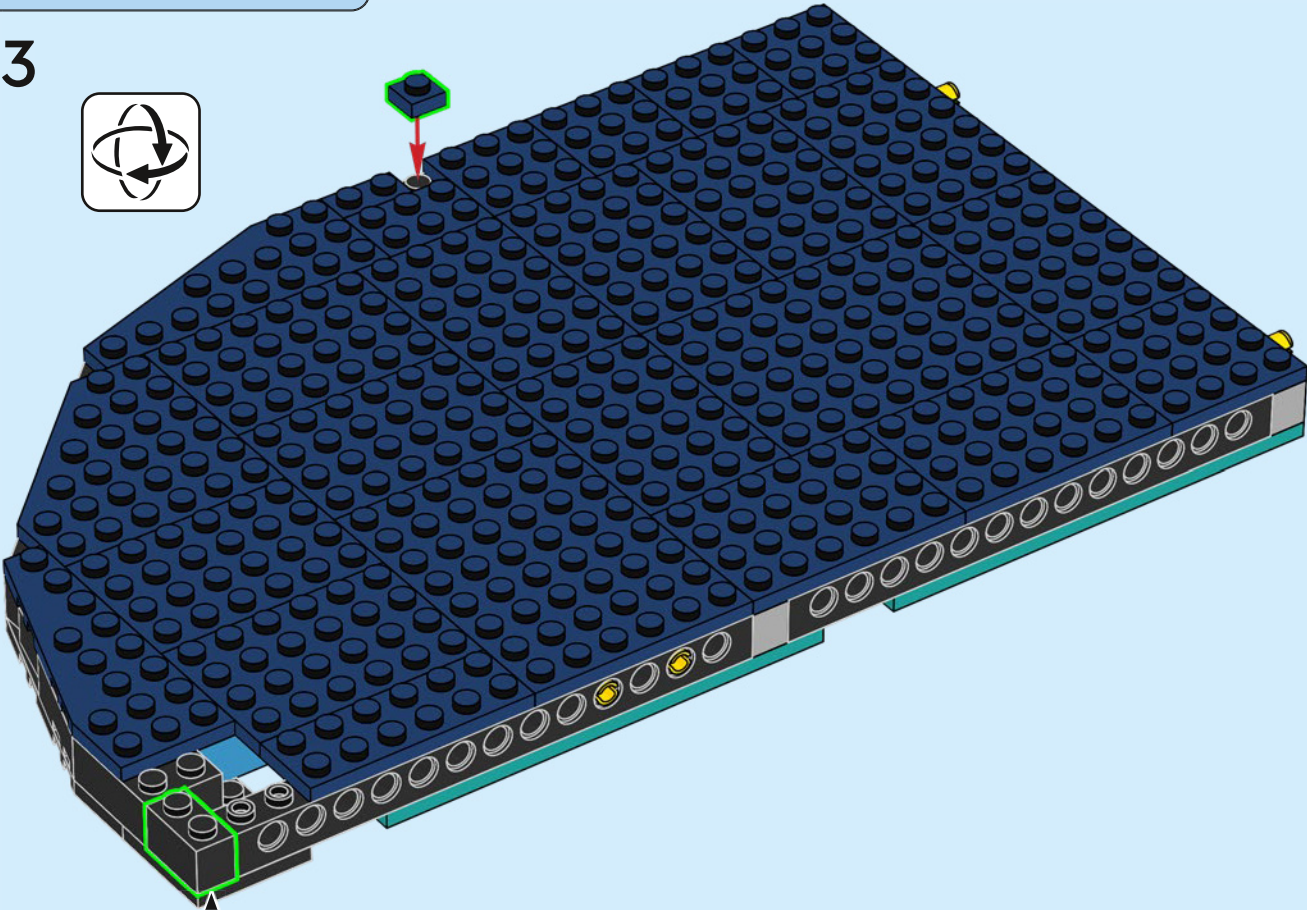



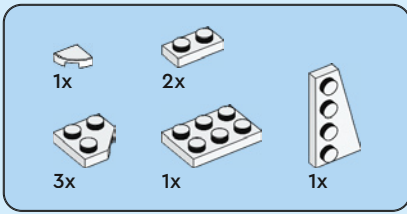

54

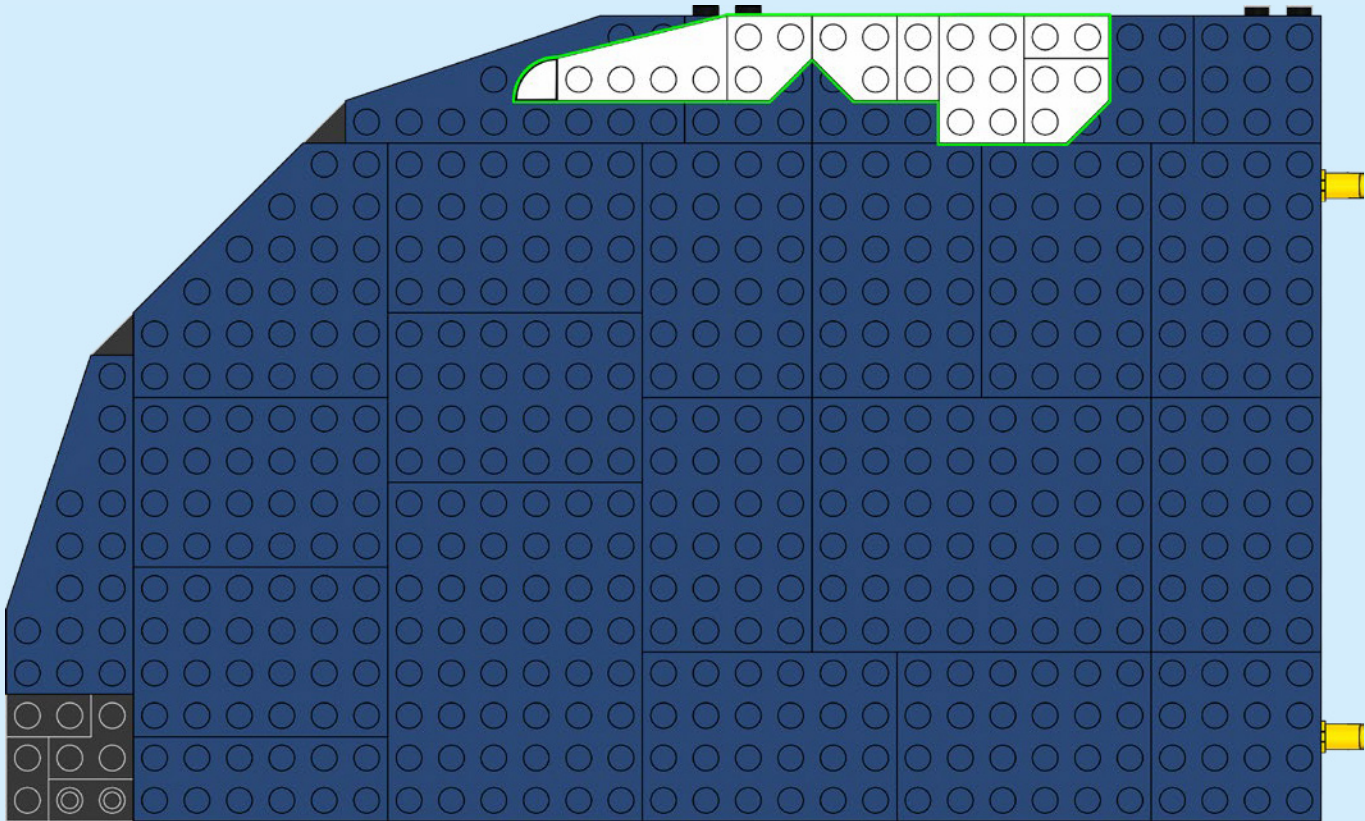

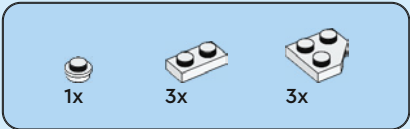

55

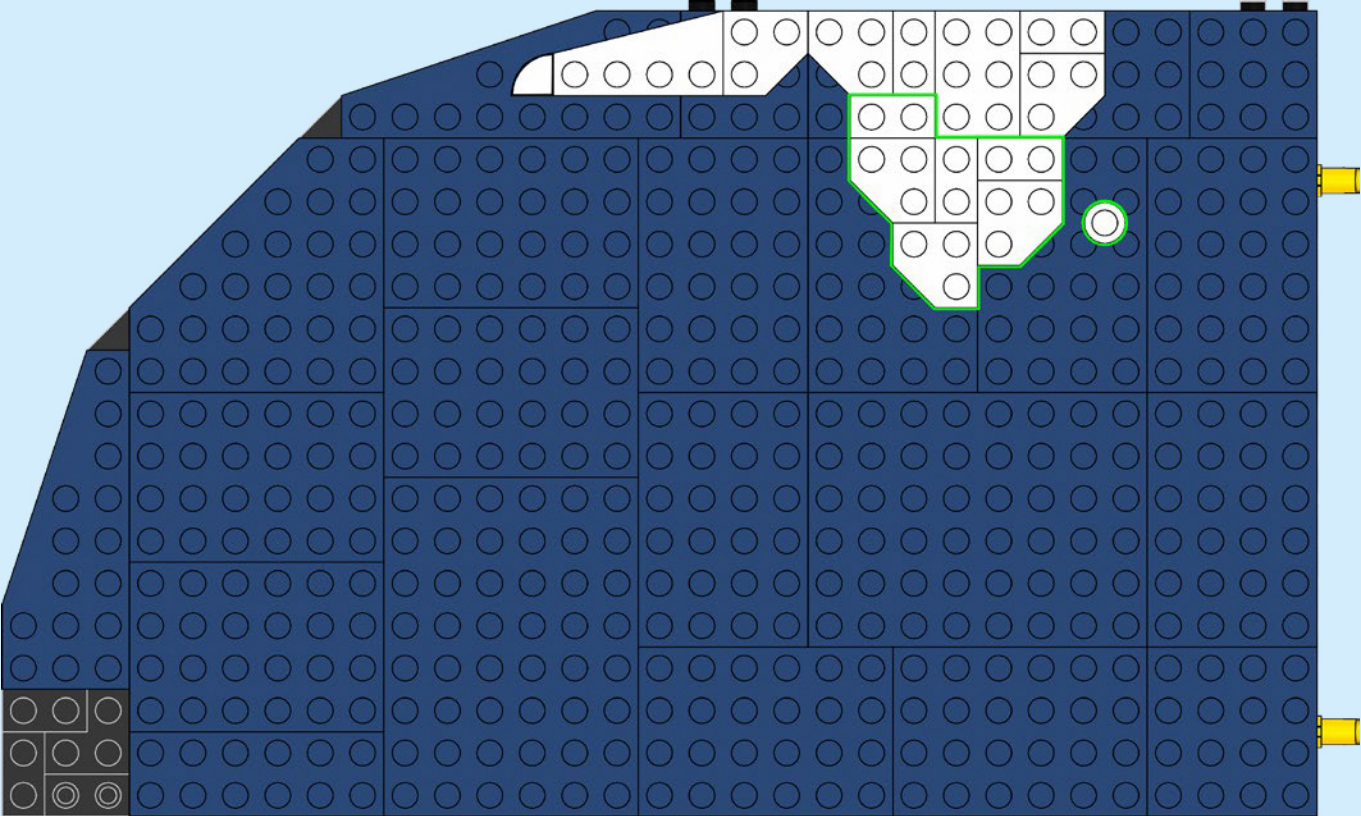

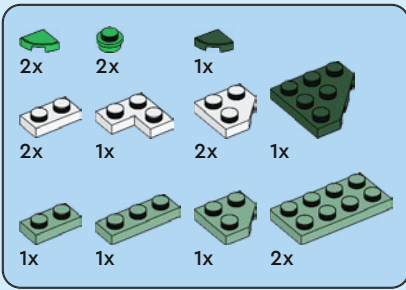

56

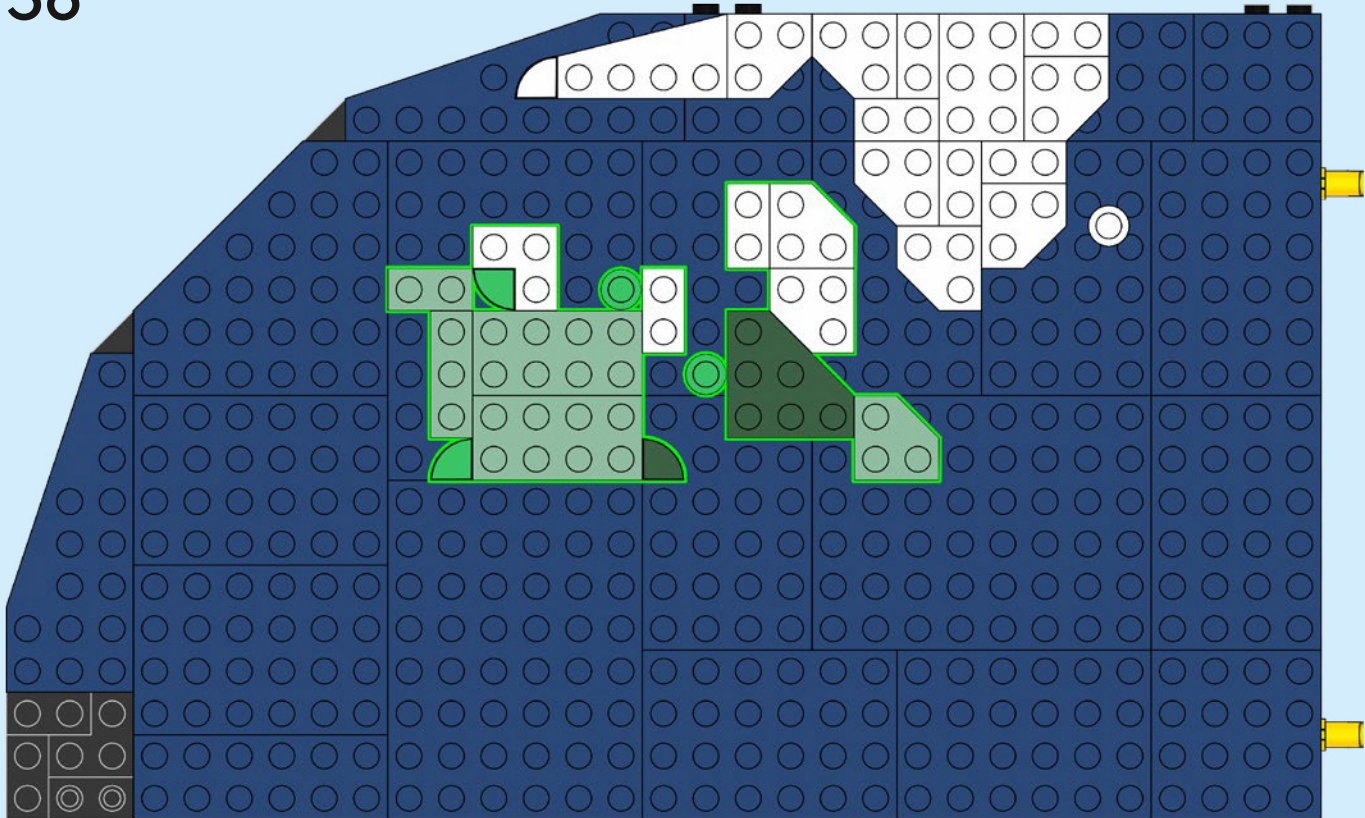



4x



10x

57

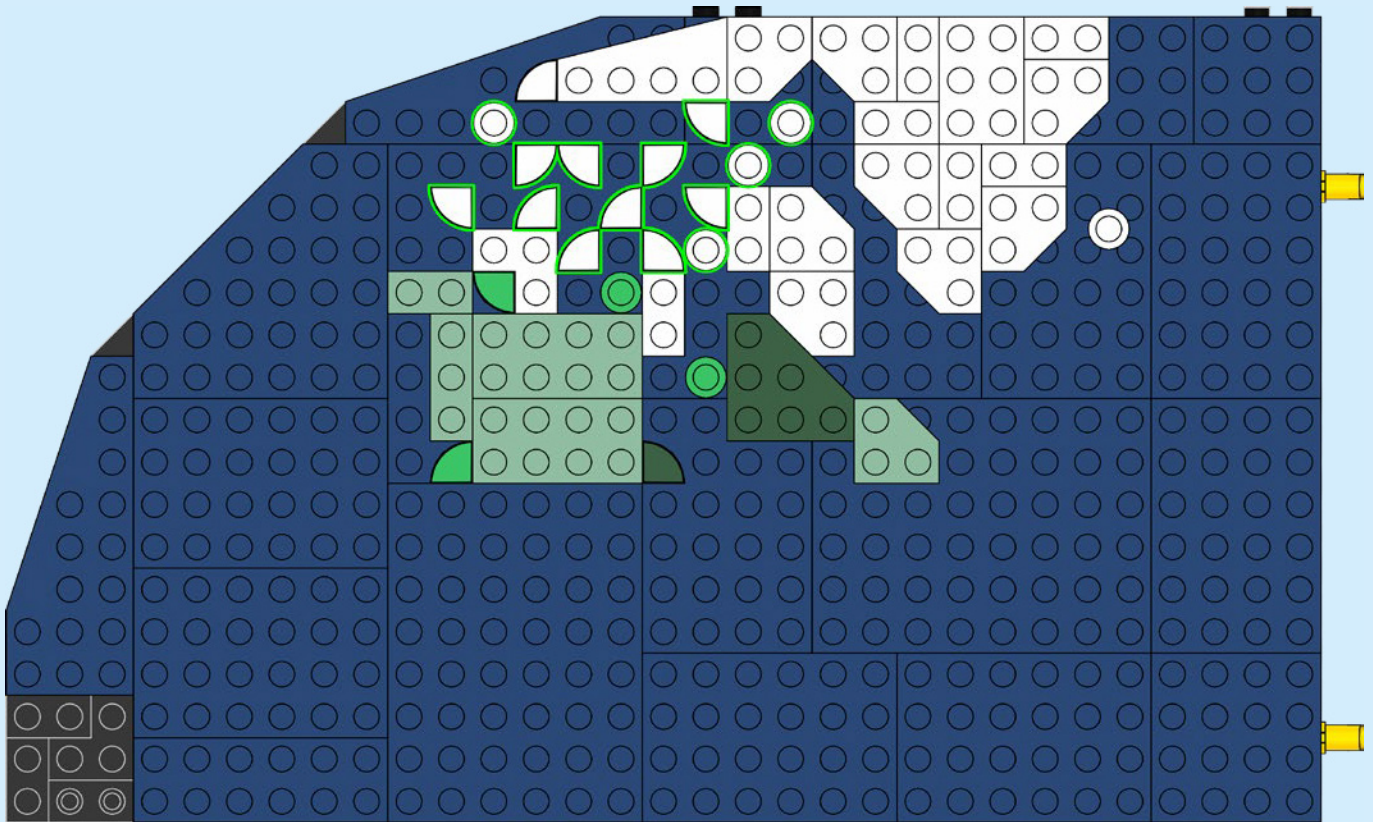

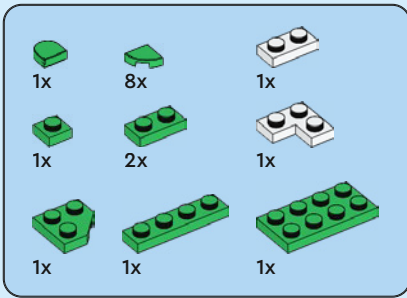

58

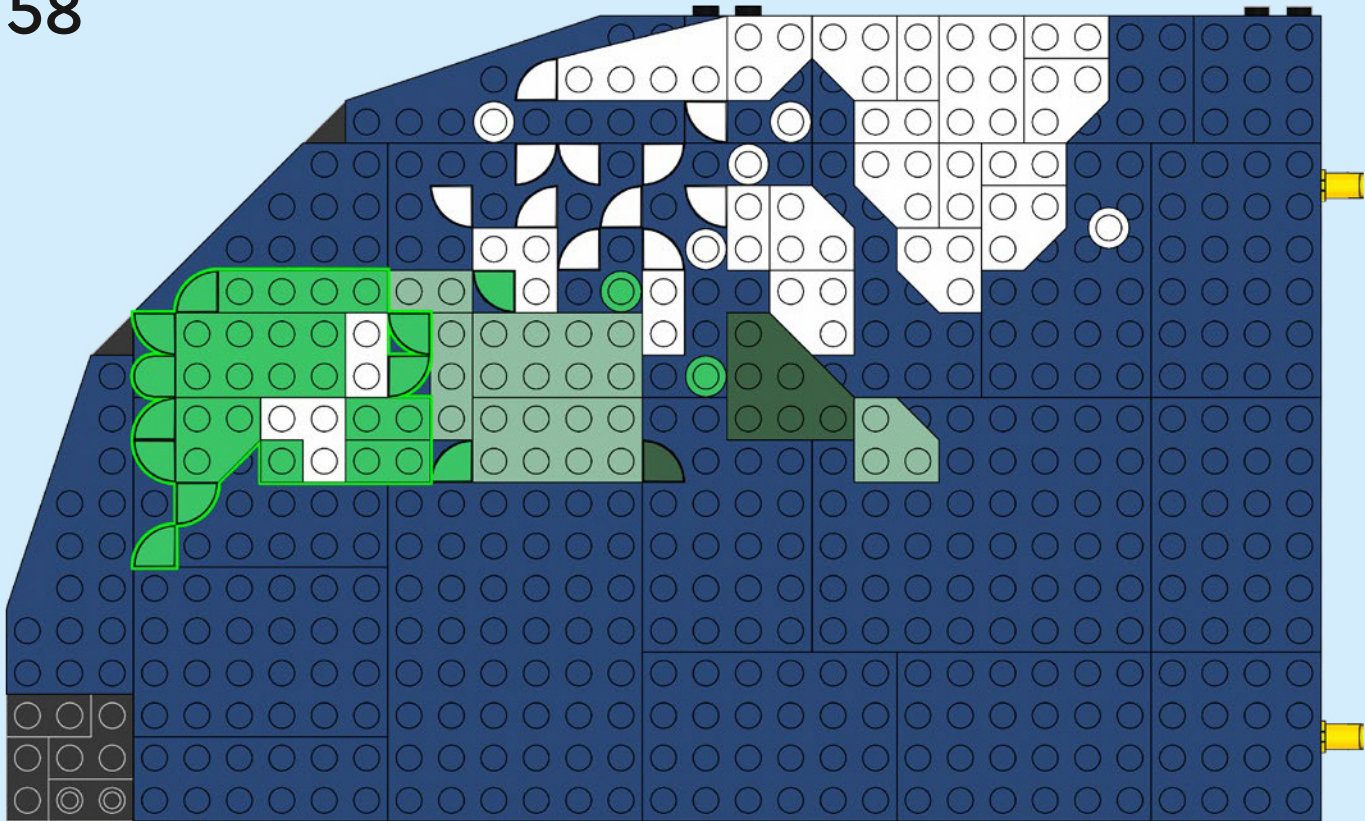

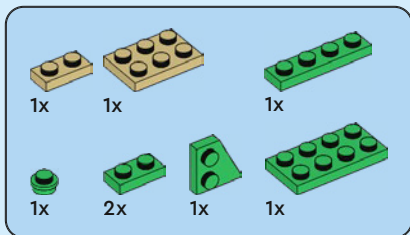

59

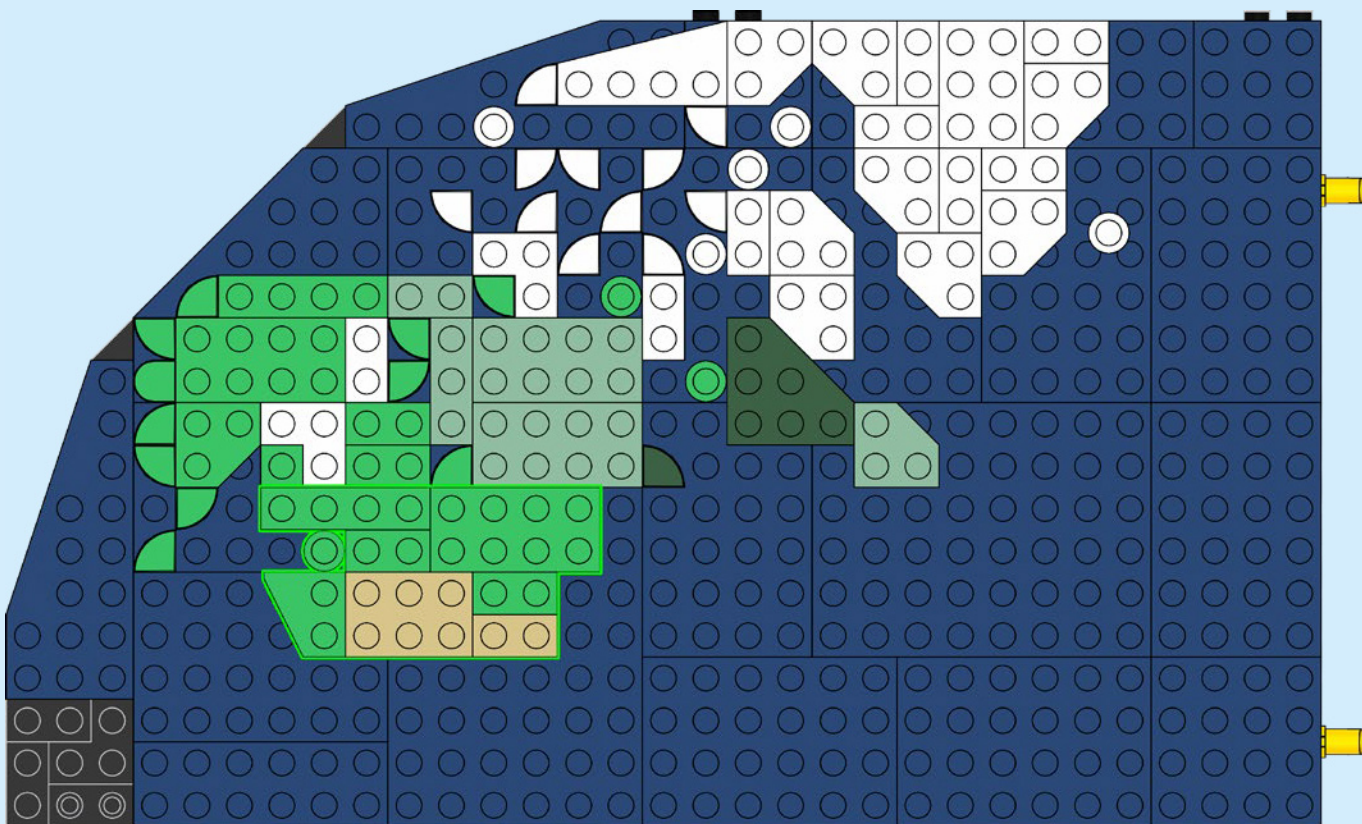

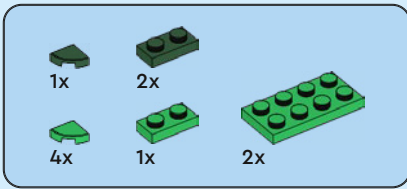

60

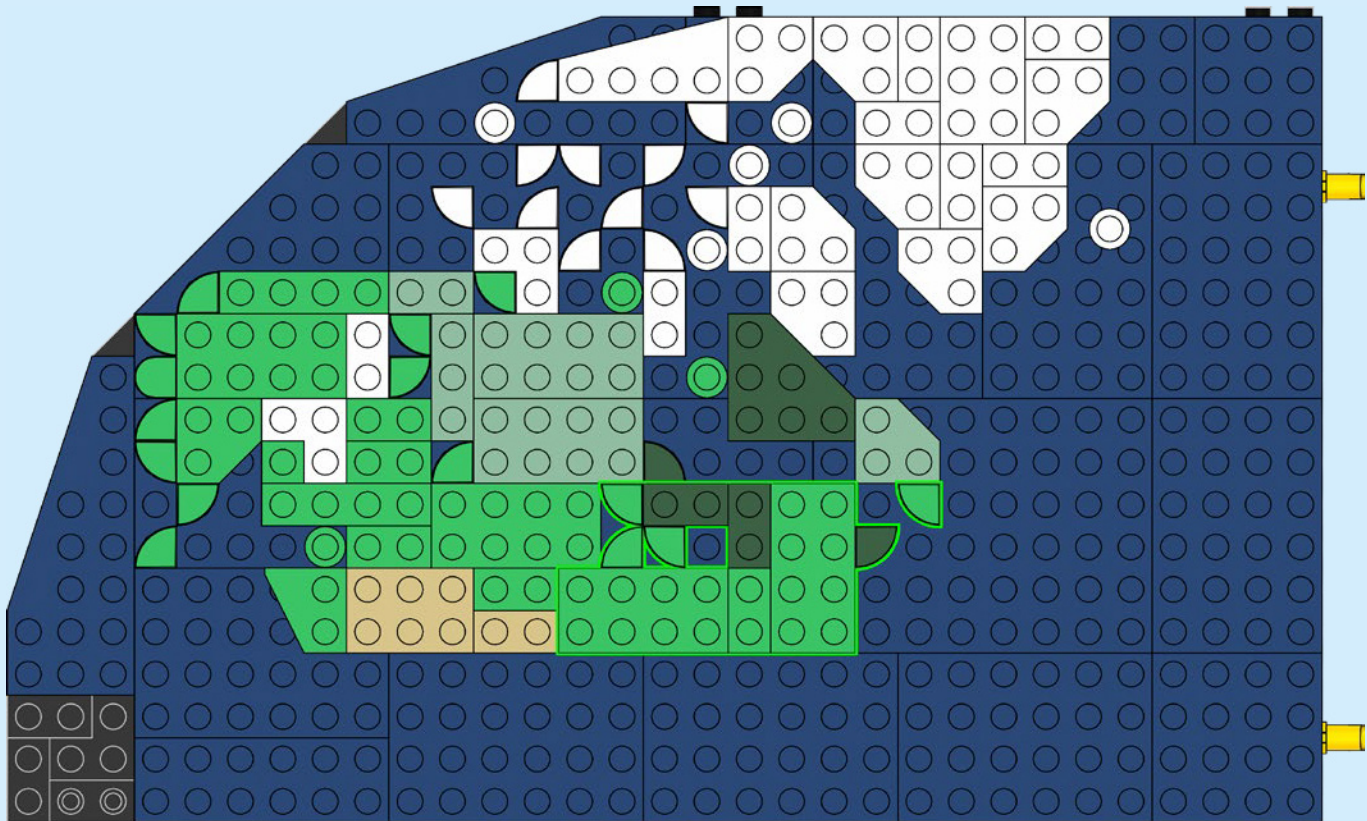

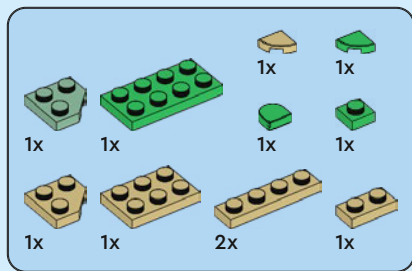

61

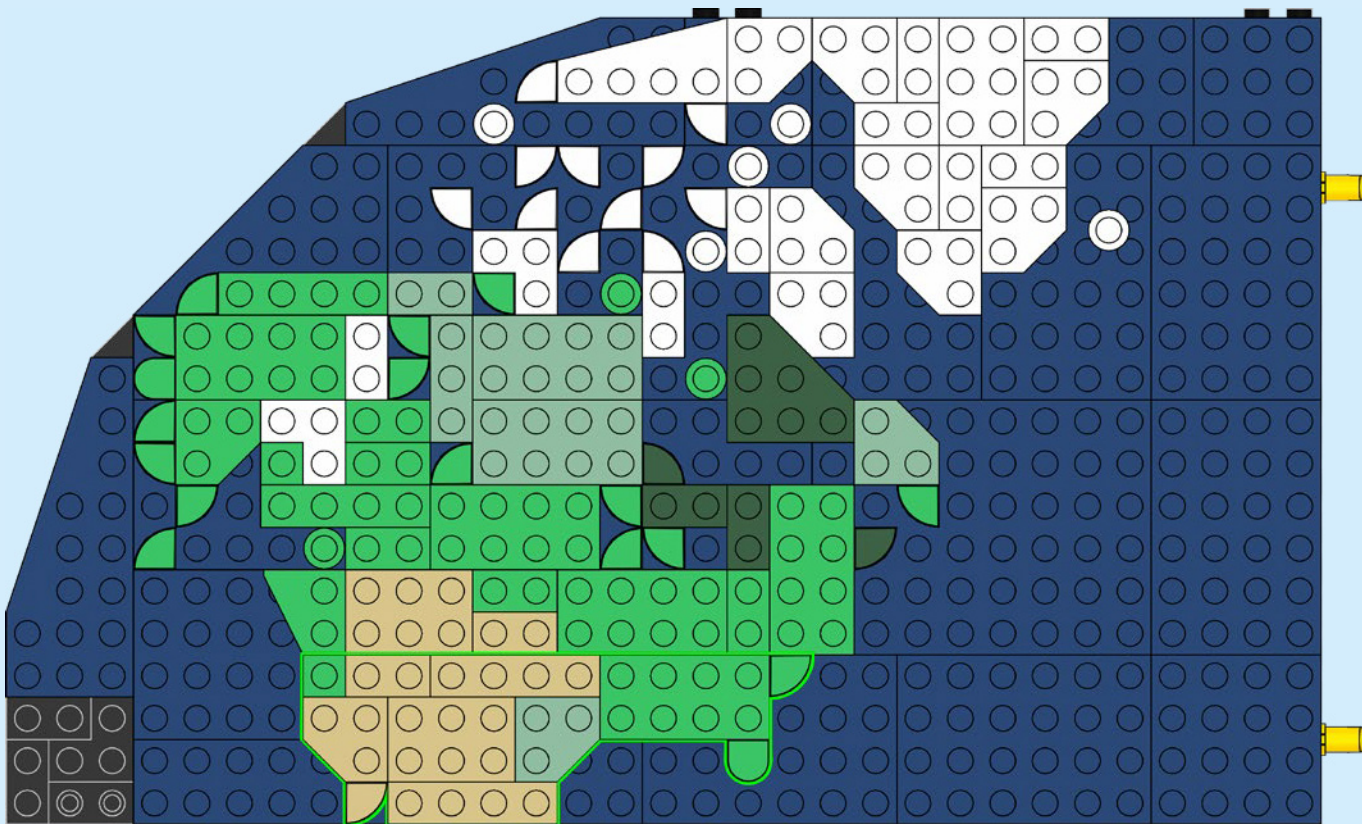



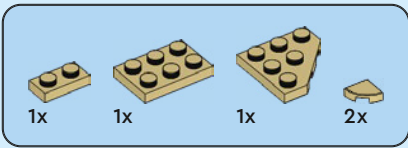

62

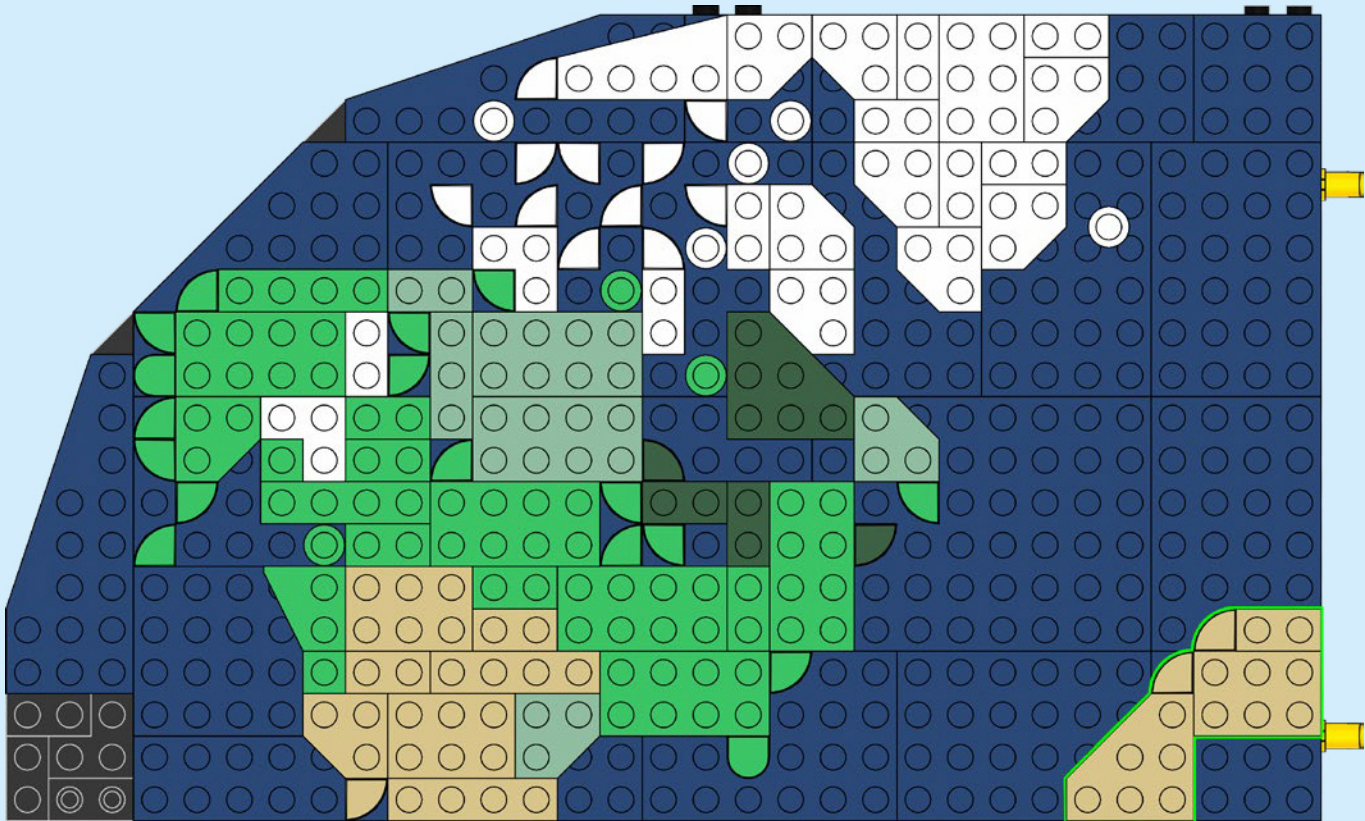

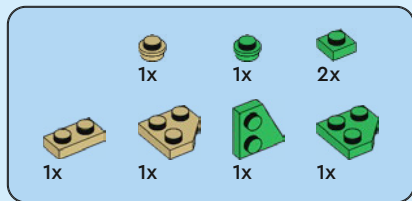

63

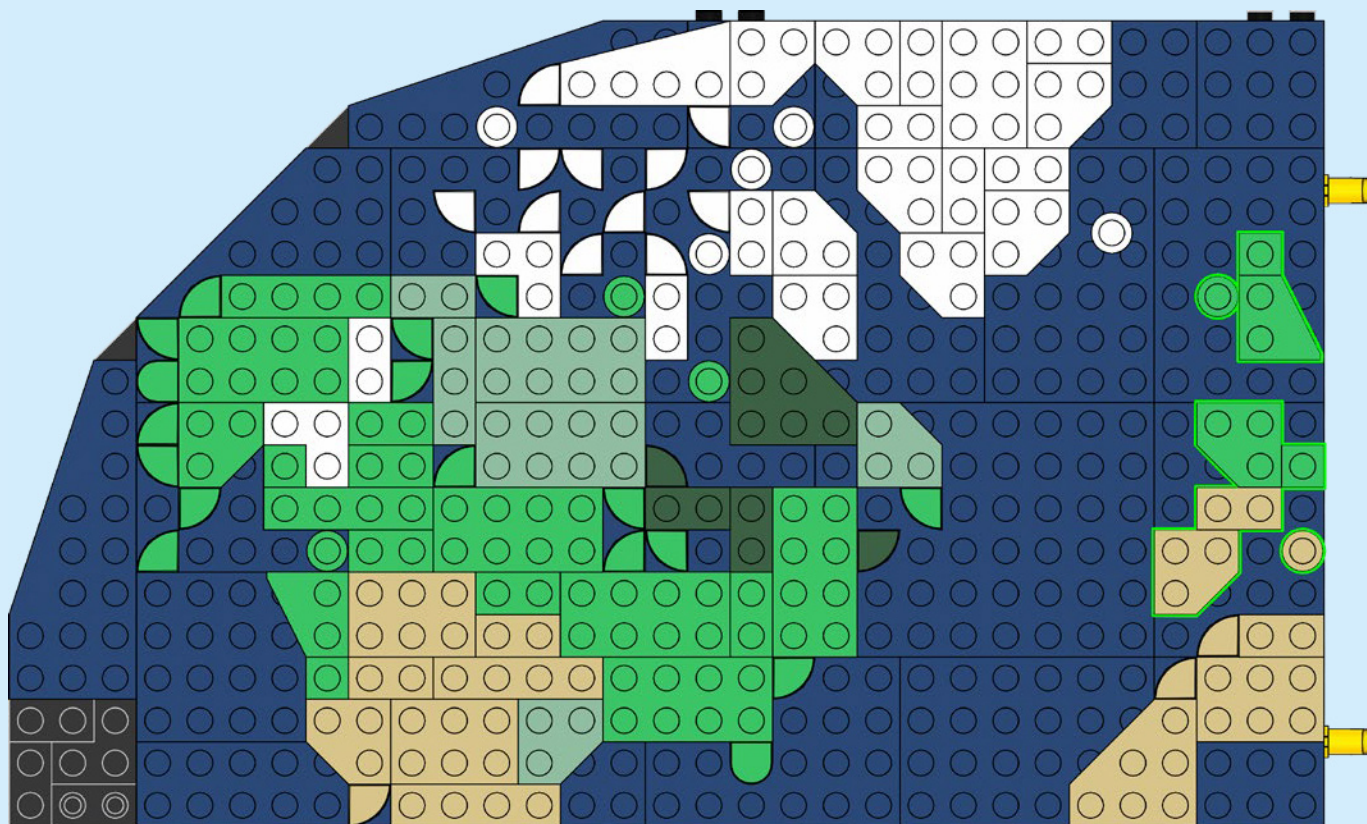

64

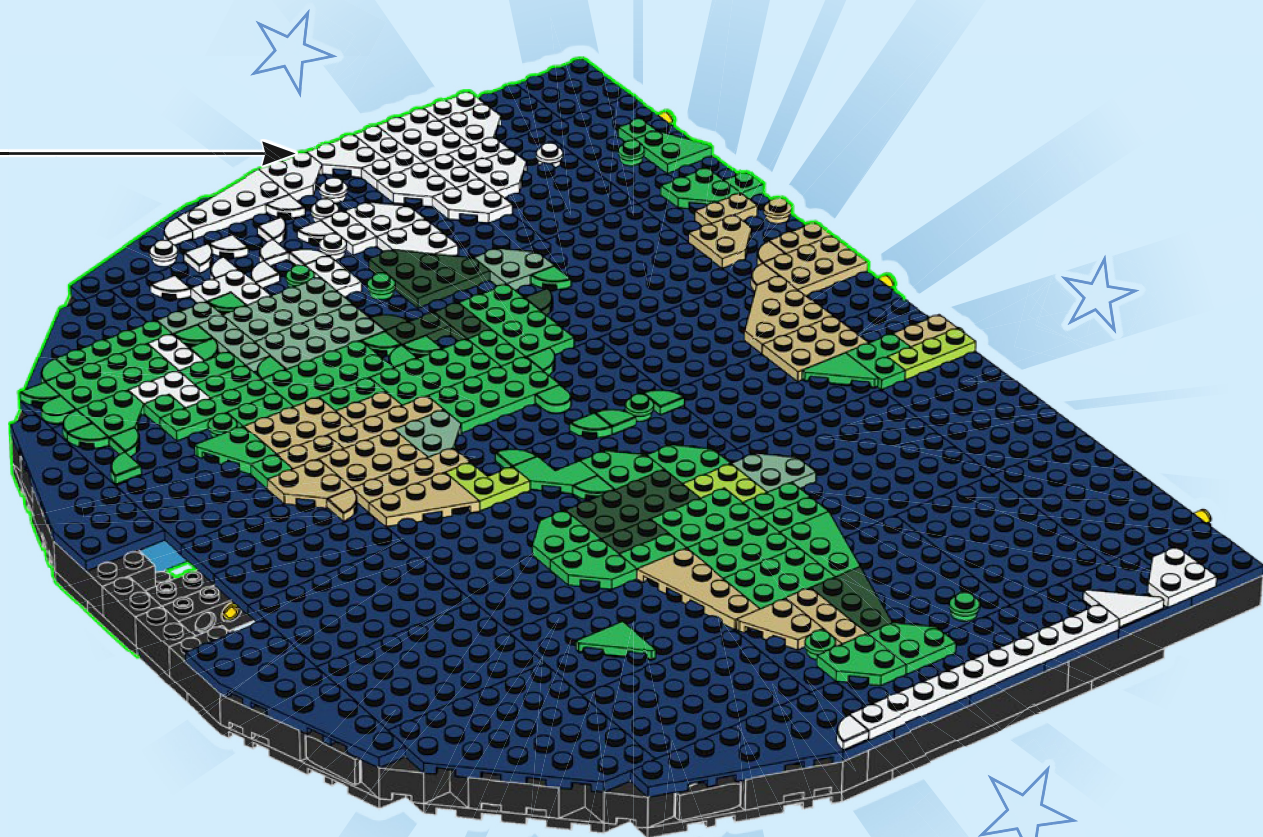



## Welcome aboard the World Wonderliner

On *LEGO® Masters (US)*, fortune favors bold builders, and the season 4 winning team, Christopher Lee and Robert Zhang, created some truly spectacular builds! As part of their grand prize, they got to work with LEGO designers Samuel Liltorp Johnson and Boone Langston to turn their winning World Wonderliner into this real-life LEGO set.

## Bienvenue à bord du World Wonderliner

Dans *LEGO® Masters (É.-U.)*, la fortune sourit aux constructeurs audacieux, et l'équipe gagnante de la saison 4, Christopher Lee et Robert Zhang, a créé des constructions vraiment spectaculaires ! Remporter le grand prix leur a permis de travailler avec les concepteurs LEGO Samuel Liltorp Johnson et Boone Langston pour transformer leur victorieux World Wonderliner en un ensemble LEGO réel.

## Te damos la bienvenida a bordo del World Wonderliner

En la edición estadounidense de *LEGO® Masters*, la fortuna favorece a los constructores más audaces. Y el equipo ganador de la 4.ª temporada, Christopher Lee y Robert Zhang, ¡lo demostró creando algunos modelos verdaderamente espectaculares! Como parte de su gran premio, ganaron la oportunidad de trabajar con los diseñadores de LEGO Samuel Liltorp Johnson y Boone Langston para convertir su propuesta ganadora, el World Wonderliner, en este set LEGO de la vida real.

## From LEGO® Masters to LEGO set

This Travel Moments set is perfect for building together. If you're a fan of the LEGO® Masters (US) TV show, you may recognize several elements inspired by the season 4 finale model as you build this set. The four designers worked together to tell the story behind Christopher and Robert's winning build in a new way. Now it's **YOUR** turn to share your stories together and display them your way!

## De LEGO® Masters à ensemble LEGO

L'ensemble Les souvenirs de voyage est parfait pour la construction partagée. Si vous êtes amateur de la série télé LEGO® Masters (É.-U.), vous reconnaîtrez peut-être plusieurs éléments inspirés du modèle final de la saison 4 lors de la construction de cet ensemble. Les quatre concepteurs ont travaillé ensemble pour raconter l'histoire de la construction gagnante de Christopher et Robert d'une nouvelle manière. C'est maintenant à **VOTRE** tour de partager vos histoires et de les exposer à votre façon !

## De LEGO® Masters a set LEGO del mundo real

El set Momentos de Viaje es perfecto para construir en compañía. Si eres fan de la edición estadounidense de la serie para televisión LEGO® Masters, quizá reconozcas algunos elementos inspirados en el modelo final de la 4.ª temporada al construir este set. Los cuatro diseñadores trabajaron juntos para contar la historia de la propuesta ganadora de Christopher y Robert en una nueva forma. ¡Y ahora te toca a **TI** compartir tu historia de construcción en compañía y exhibirla a tu manera!



*From left to right: LEGO® Masters US winners Robert Zhang and Christopher Lee with LEGO designers Boone Langston and Samuel Liltorp Johnson*

*De gauche à droite : Les vainqueurs du concours LEGO® Masters (É.-U.), Robert Zhang et Christopher Lee, avec les concepteurs LEGO Boone Langston et Samuel Liltorp Johnson*

*De izquierda a derecha: Los ganadores de la edición estadounidense de LEGO® Masters Robert Zhang y Christopher Lee con los diseñadores de LEGO Boone Langston y Samuel Liltorp Johnson*



## Your favorite moments

Who has a great idea for your next fun adventure? What are the most exciting places you have traveled to together? Find your favorite places on the map and mark them with the small icon tiles with cameras, suitcases and the 'home' tile. The vehicle models are all-terrain and will take you wherever you want to go. Search your photo albums, your dream vacation brochures or vacation scrapbooks and find photos, memorabilia, postcards or tickets you can add to your display!

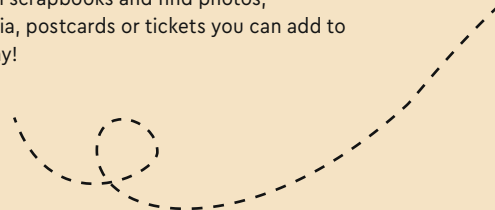

## Vos moments préférés

Qui a une bonne idée pour votre prochaine belle aventure ? Quels sont les endroits les plus fascinants que vous avez visités ensemble ? Trouvez vos endroits préférés sur la carte et marquez-les à l'aide des petites tuiles représentant des appareils photo, des valises et une maison. Les modèles de véhicules sont tout-terrain et vous emmèneront partout où vous voulez aller. Cherchez dans vos albums photos ou vos brochures de vacances de rêve et trouvez des photos, des souvenirs, des cartes postales ou des billets que vous pouvez ajouter à votre pièce !

## Sus momentos más especiales

¿Quién tiene una grandiosa idea para su próxima aventura divertida? ¿Cuáles son los lugares más emocionantes a los que han viajado juntos? Busquen sus lugares favoritos en el mapa y márkennlos con las cubiertas pequeñas decoradas con imágenes de cámaras y maletas. No olviden identificar su hogar con la cubierta incluida especialmente para este fin. Los modelos de vehículos son todoterreno y los llevarán a donde quieran ir. ¡Busquen en sus álbumes de fotos, en los folletos de sus vacaciones soñadas o en sus colecciones de recortes de destinos de viajes y encuentren imágenes, recuerdos, postales o boletos que puedan añadir a su exhibición!

