



SONIC™

THE HEDGEHOG

76998



LEGO® Builder



Get excited about our new packaging!

We're switching from plastic to paper-based packaging. That's why you might find a mix of paper and plastic in our boxes!

Nos nouveaux emballages vous emballeront !

Nous passons des emballages en plastique aux emballages à base de papier. C'est pourquoi vous pourriez trouver un mélange de papier et de plastique dans nos boîtes !

¡Te presentamos nuestros nuevos empaques!

Estamos sustituyendo las bolsas de plástico por bolsas con base de papel. ¡Por eso, puedes encontrar una mezcla de papel y de plástico en nuestras cajas!

[LEGO.com/sustainable-packaging](https://www.lego.com/sustainable-packaging)



BUILDER



Apple and the Apple logo are trademarks of Apple Inc., registered in the U.S. and other countries and regions. App Store is a service mark of Apple Inc. Google Play and the Google Play logo are trademarks of Google LLC. Tencent and the Tencent logo are trademarks of Tencent Inc.

LEGO.com/devicecheck

EN Ask parents' permission before going online | DE Eltern um Erlaubnis bitten, bevor du online gehst | FR Demande l'autorisation d'un parent avant d'aller en ligne | IT Chiedi il permesso ai tuoi genitori prima di andare online | ES Pídeles permiso a tus papás antes de conectarte a Internet | PT Pede autorização aos pais antes de acederes online | ZH 上网前应先征得父母的同意 | PL Poproś rodziców o zgodę, zanim wejdiesz do Internetu | CS Než půjdeš na internet, požádej rodiče o svolení | SK Skôr než pôjdeš na internet, vypýtaj si povolenie od rodičov | HU Kérj szülői engedélyt, mielőtt online csatlakoznál! | RO Cere permisiunea părinților înainte de a te conecta online | BG Поискайте разрешение от родител, преди да влезете онлайн | LV Pirms došanās tiešsaistē palūdz atļauju vecākiem | ET Enne Interneti kasutamist küsi vanematelt luba | LT Prieš prisijungdami prie interneto, atsklauskite tėvų



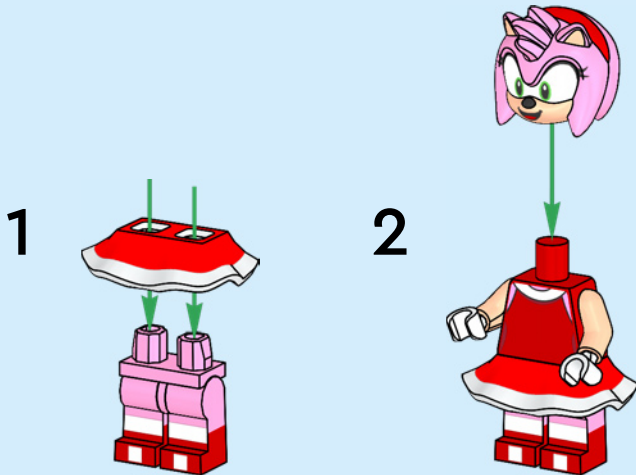
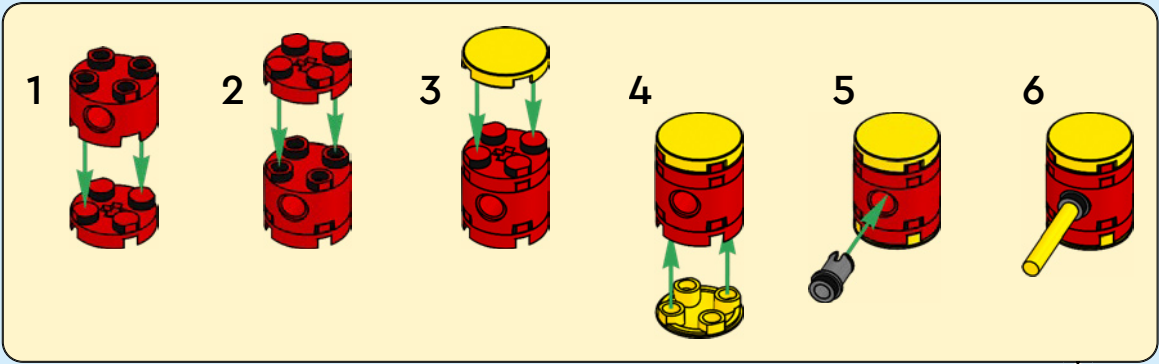

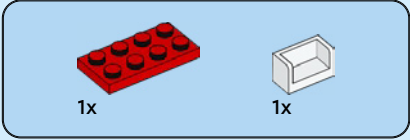
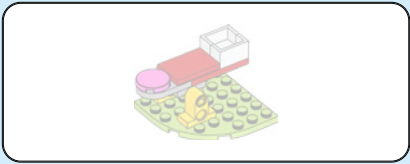

1

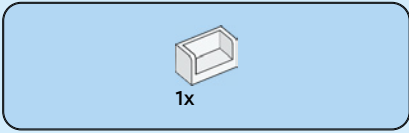
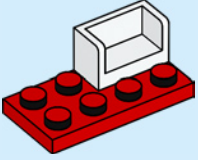

2

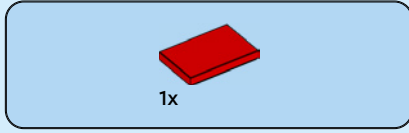
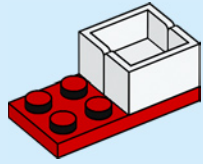

3

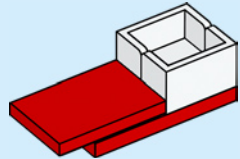

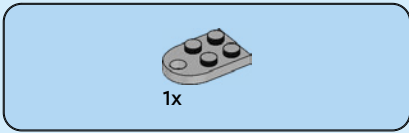

4

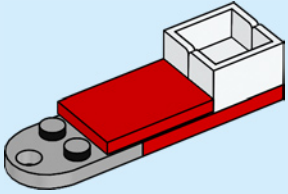

5

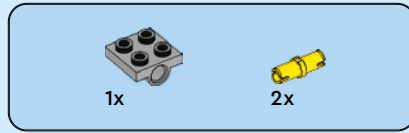
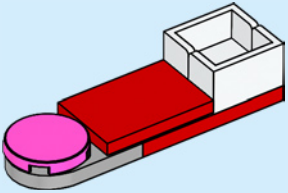

6

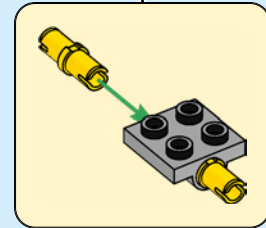
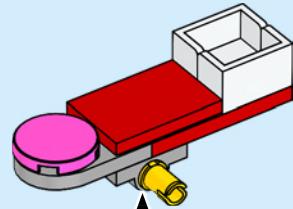



2x

7

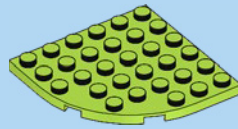
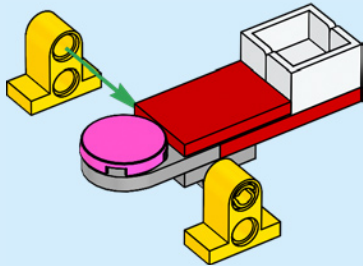

1x

8





9

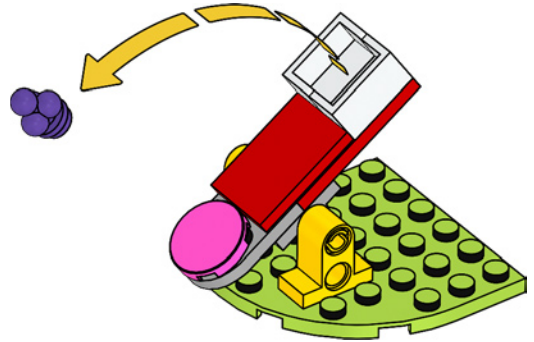
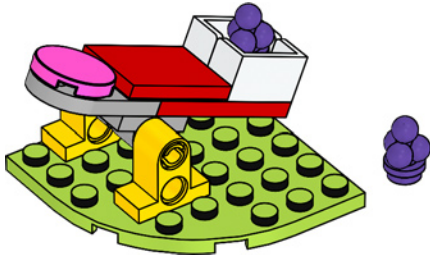



1

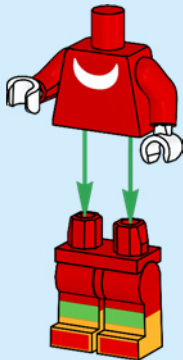

2

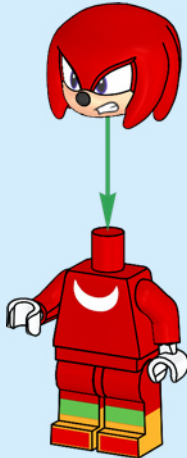

3



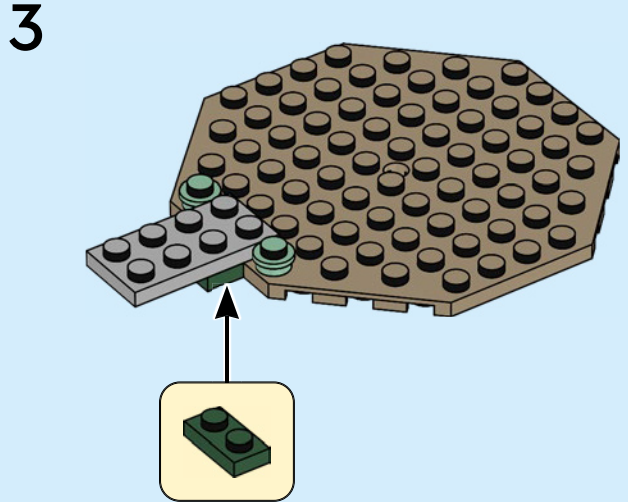
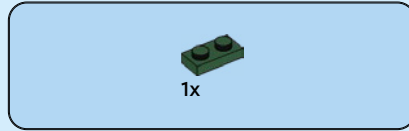
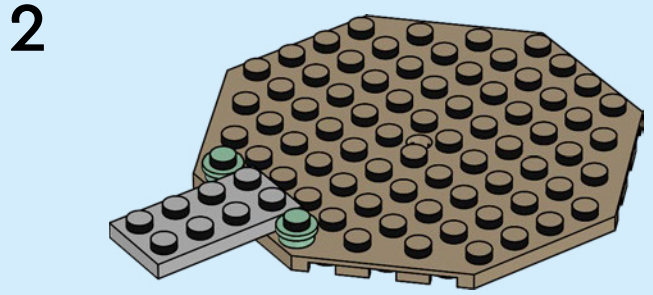
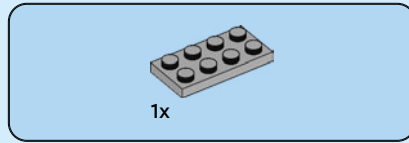
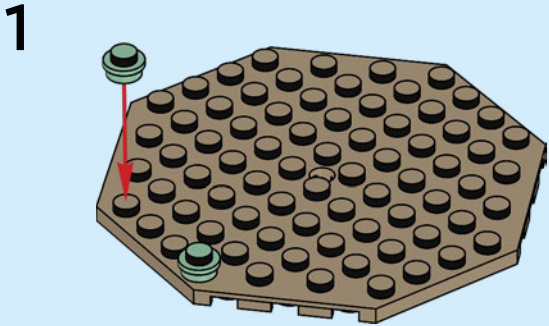
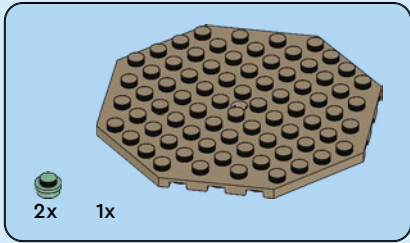
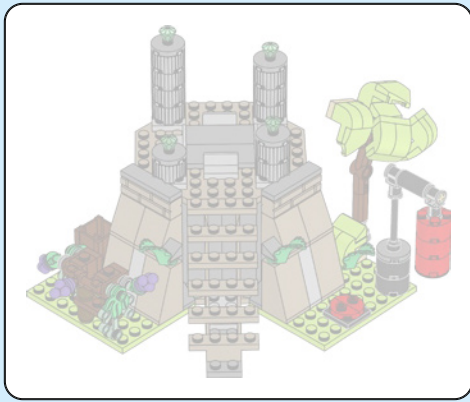

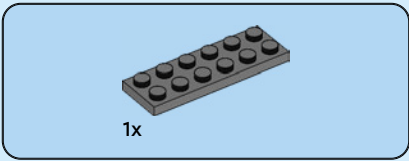

4

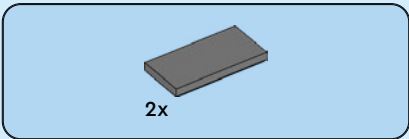
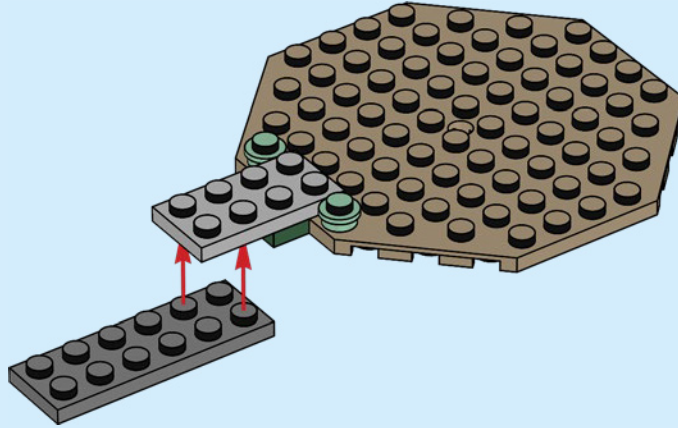

5

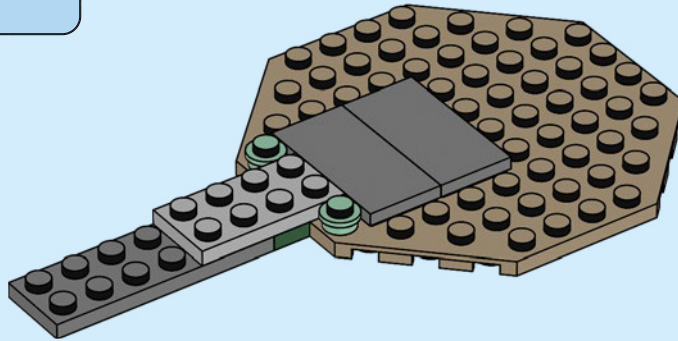

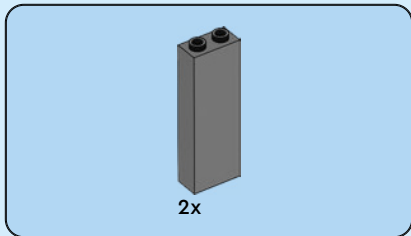

6

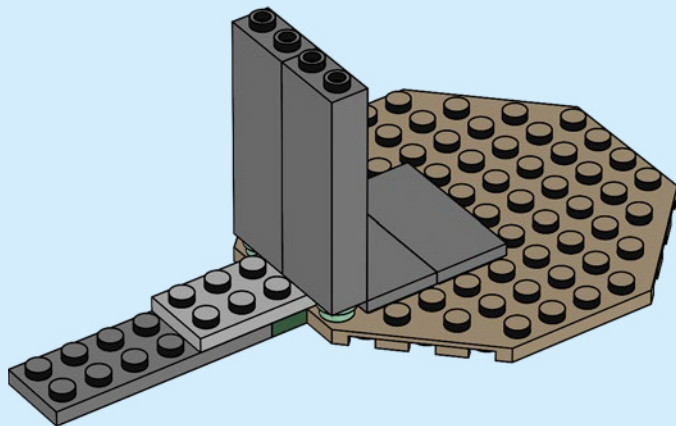

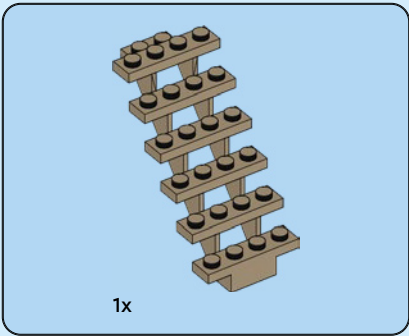

7

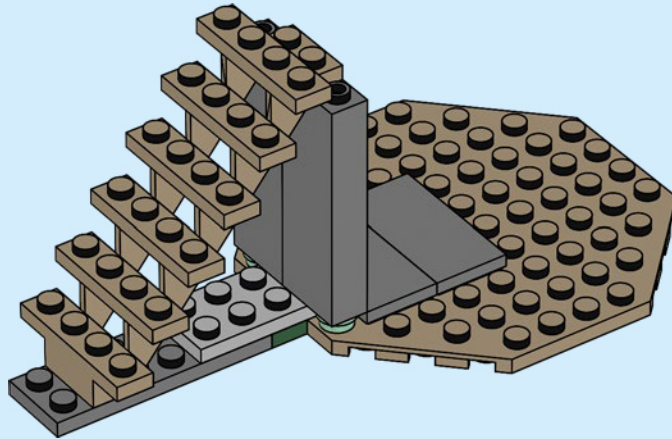



2x

8

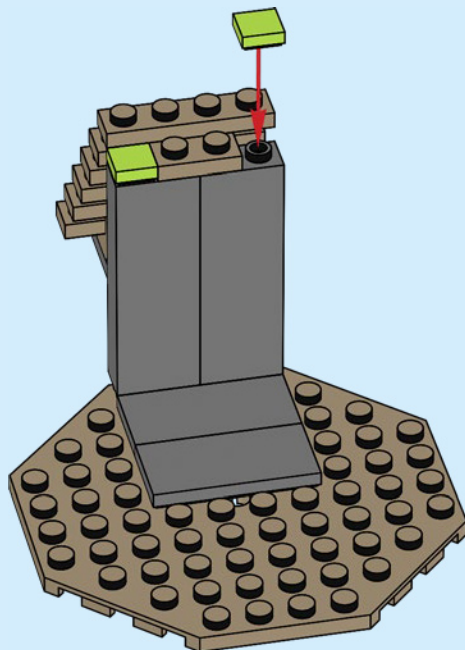
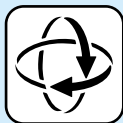

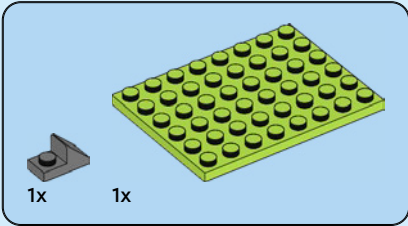
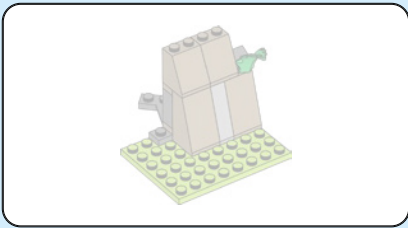

9

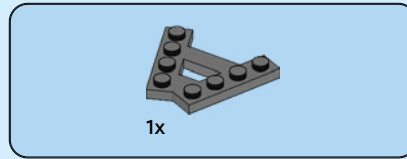
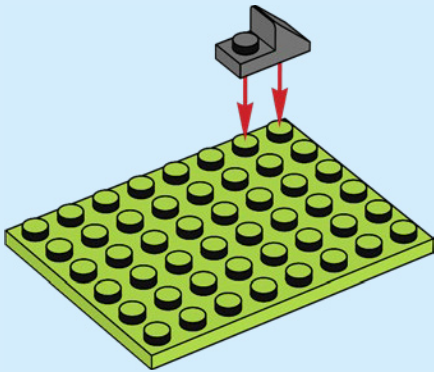

10

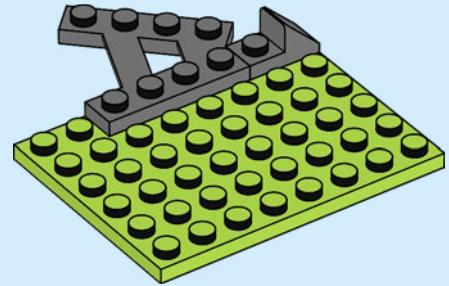

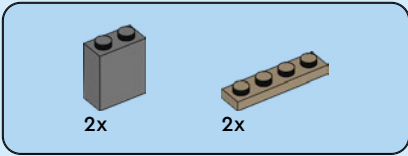

11

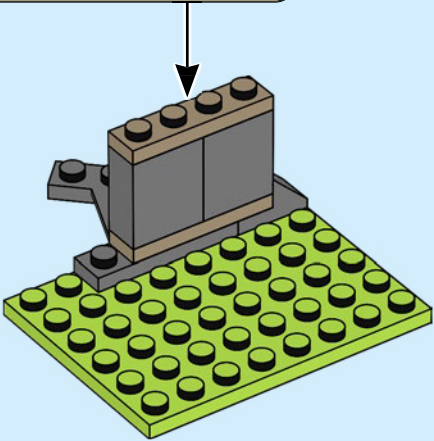
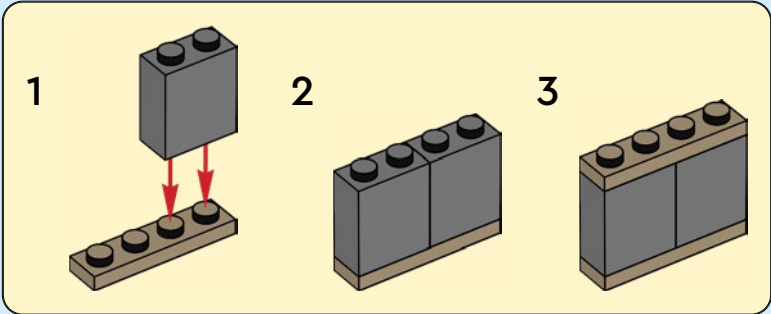

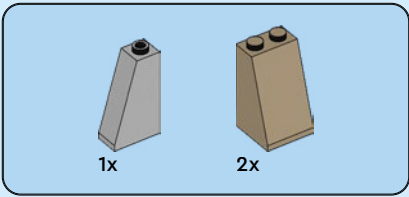

12

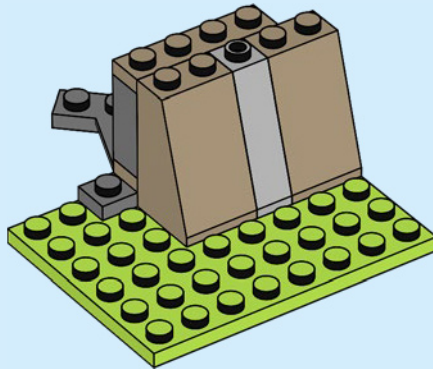

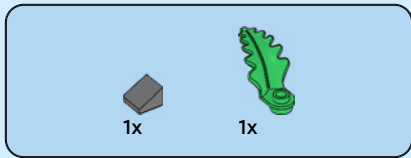

13

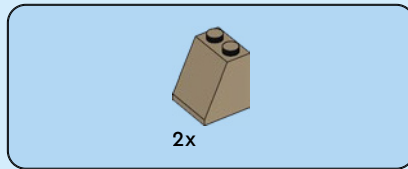
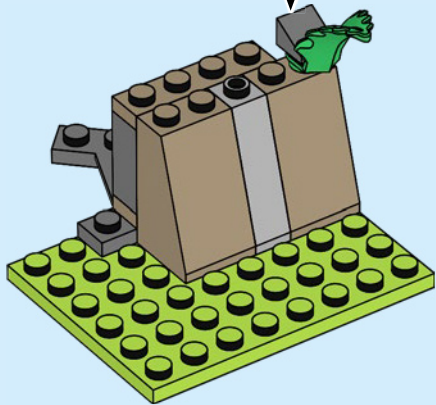
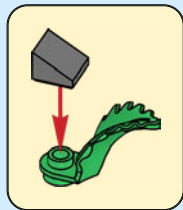

14

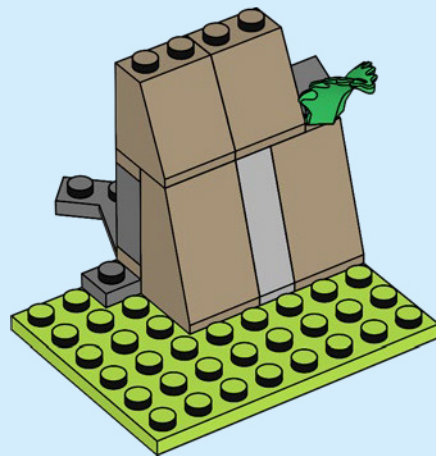

15

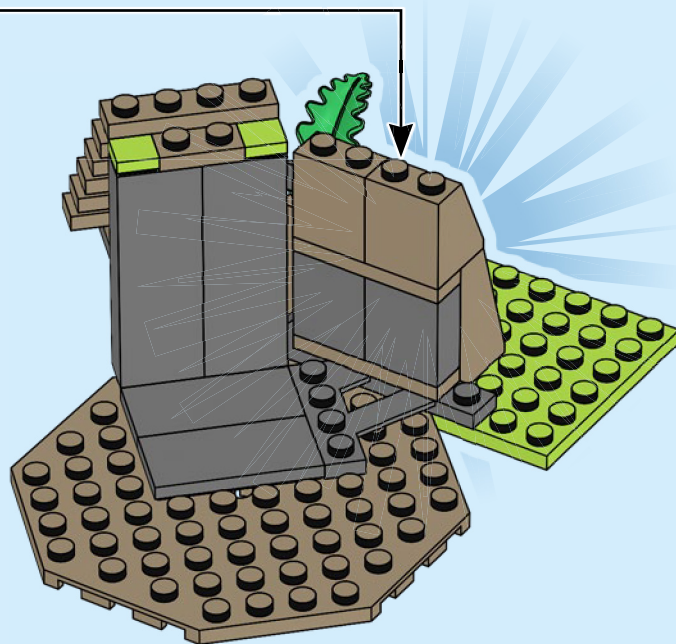

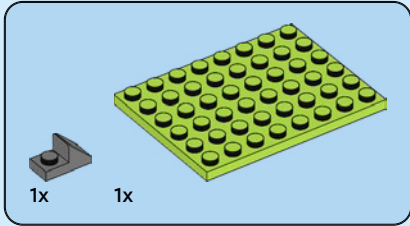
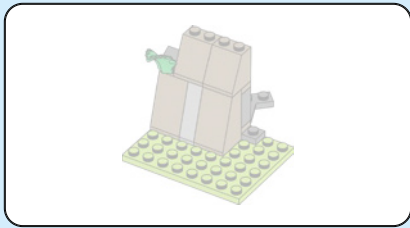

16

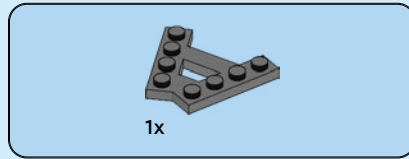
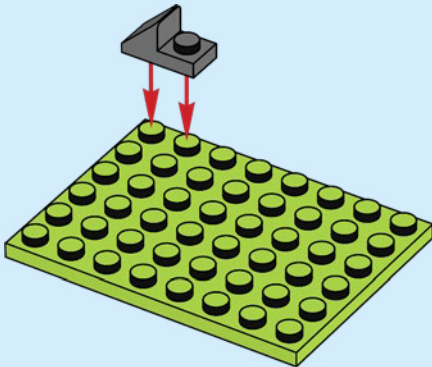

17

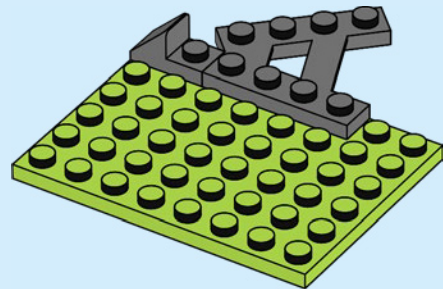

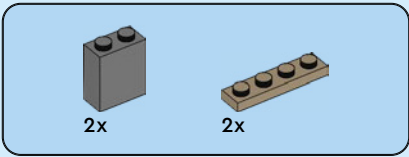

18

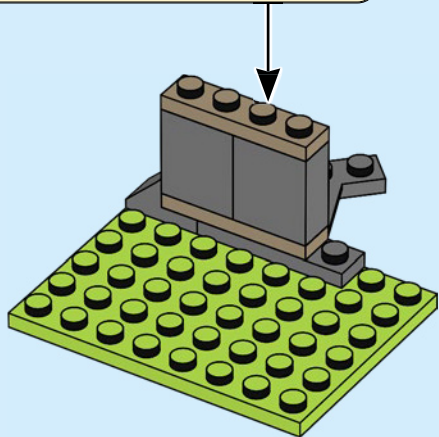
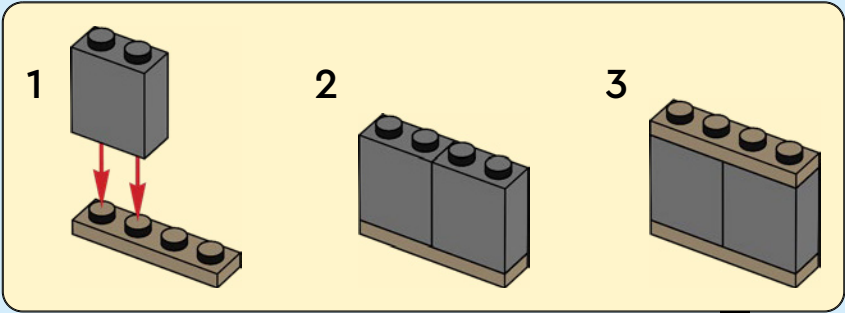

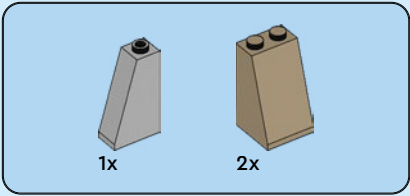

19

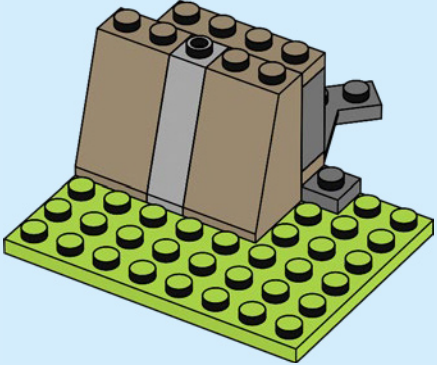

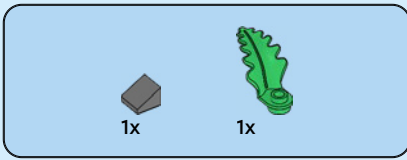

20

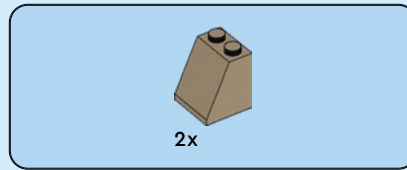
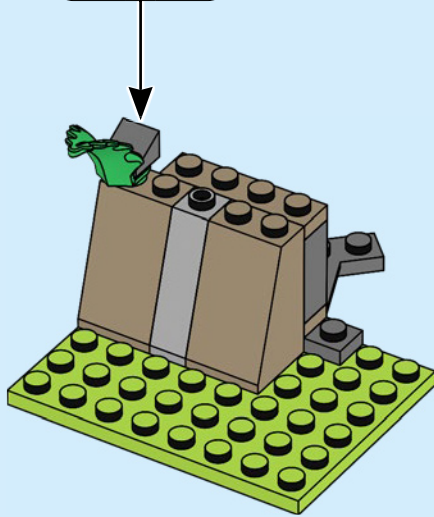
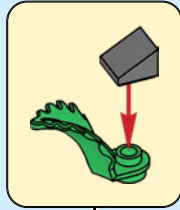

21

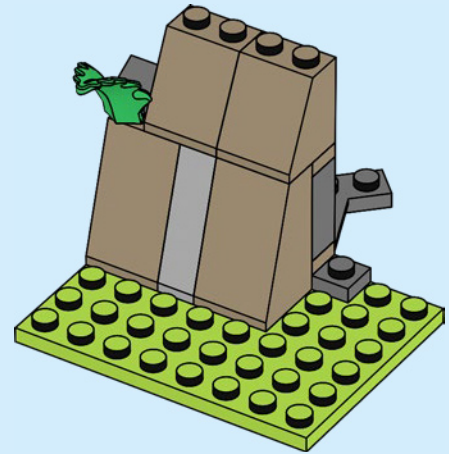

22

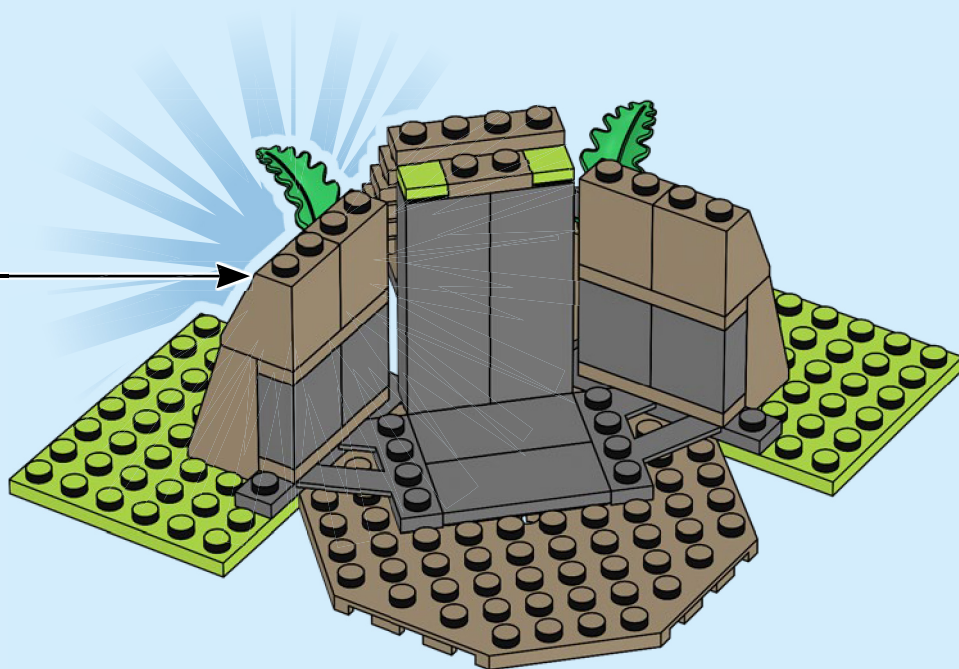

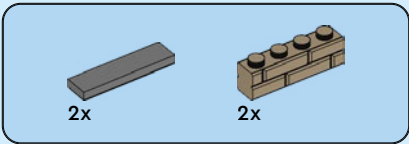

23

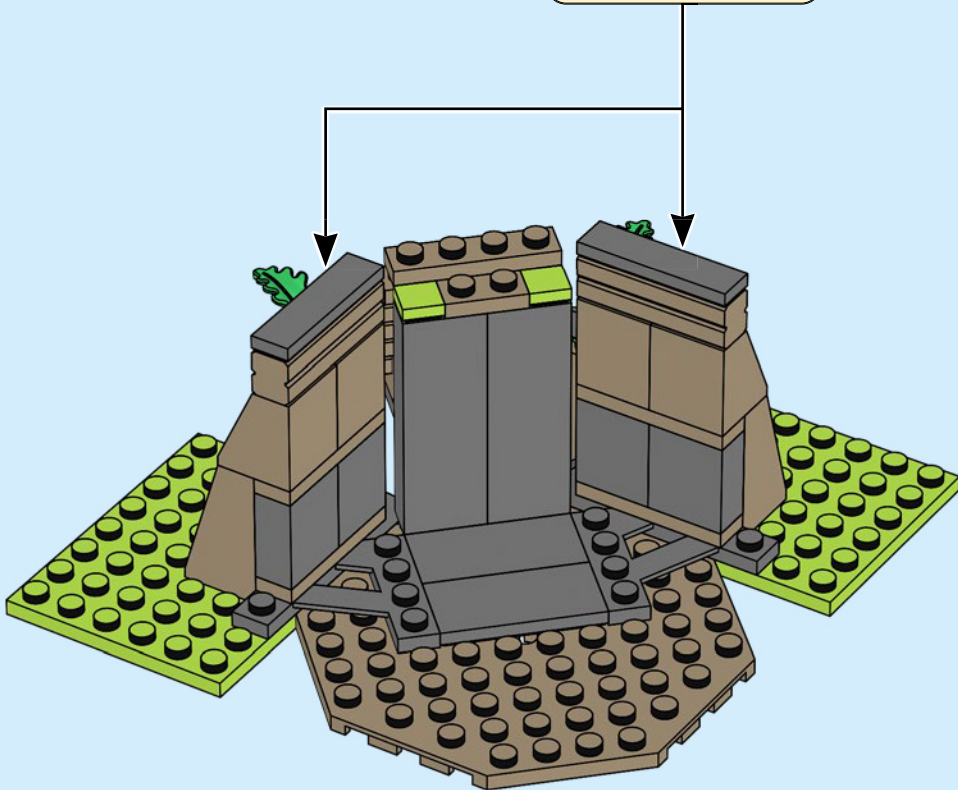
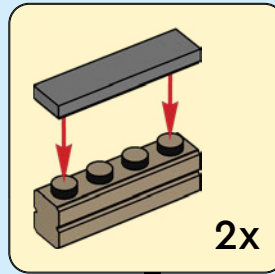

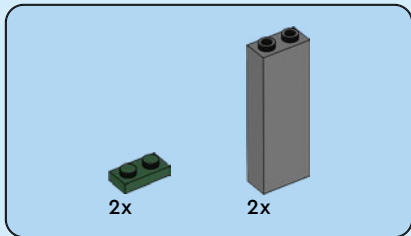

24

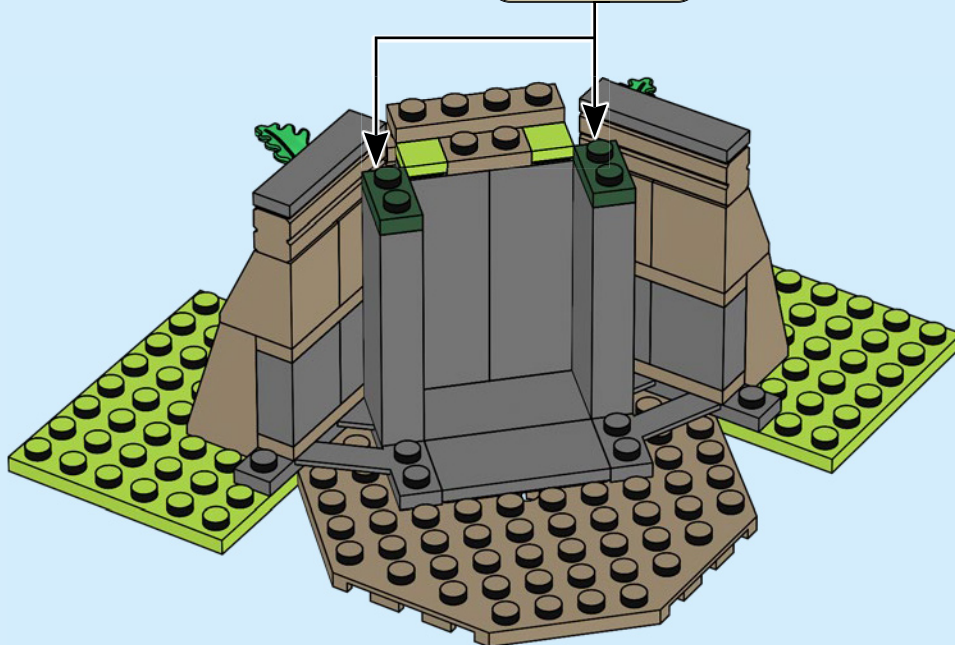
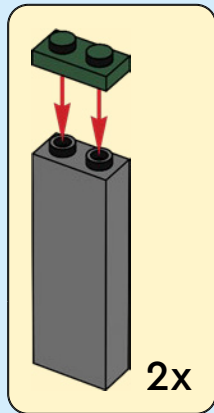



2x



2x

25

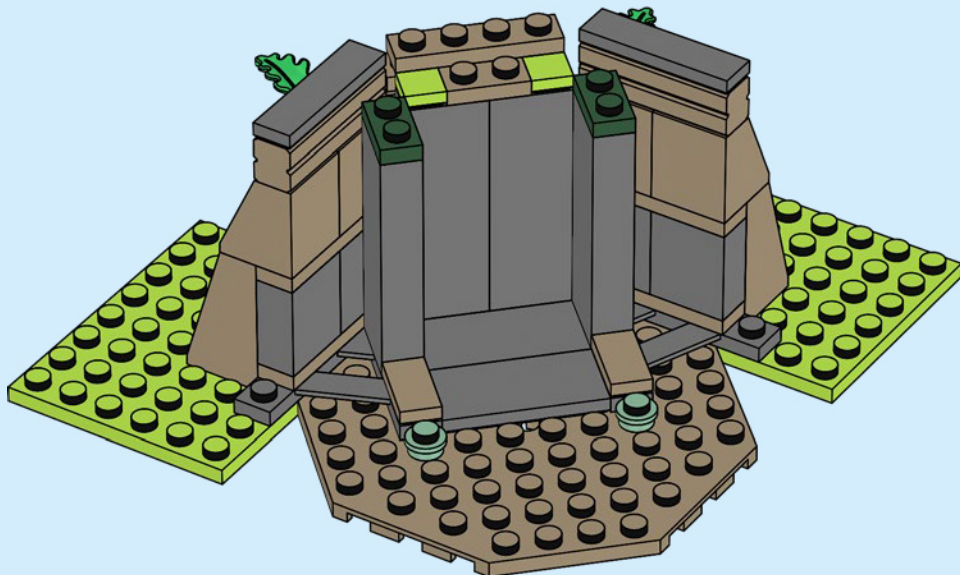



2x

26

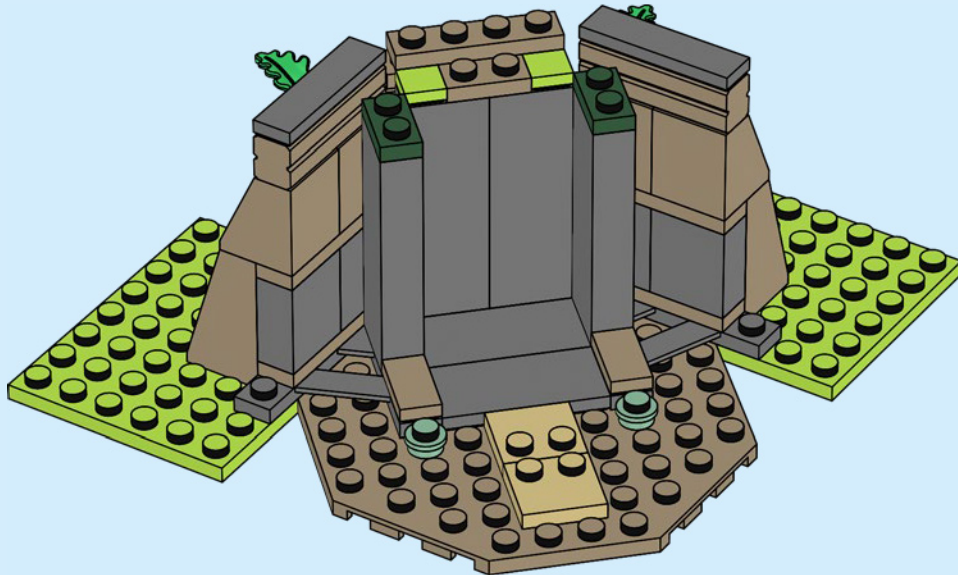

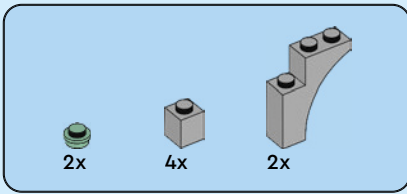

27

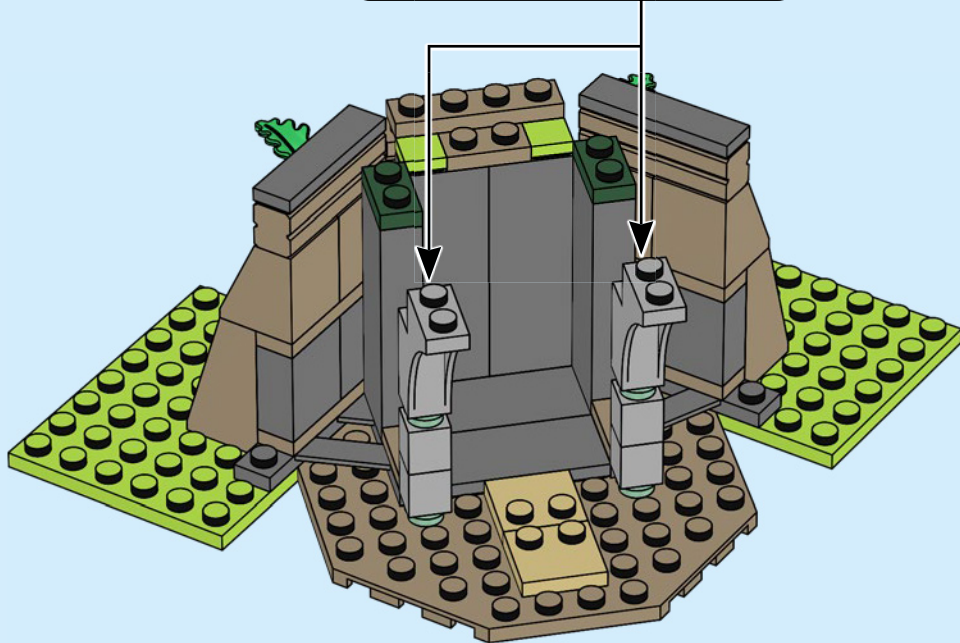
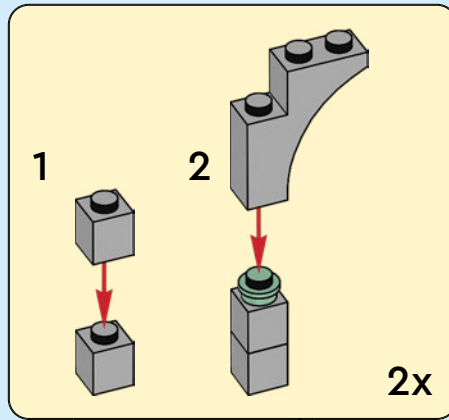

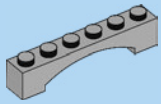

1x

28

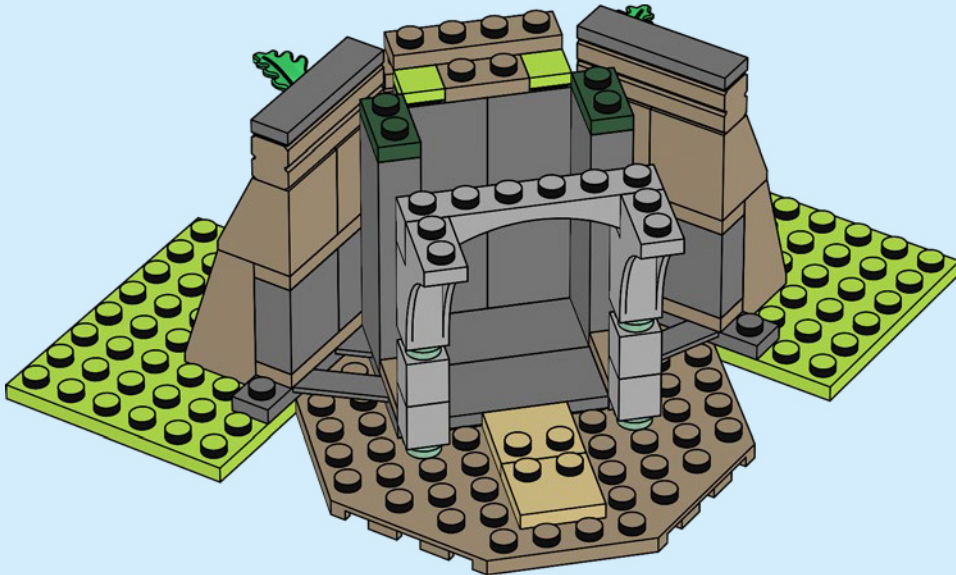

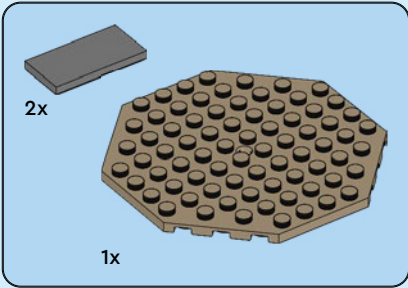
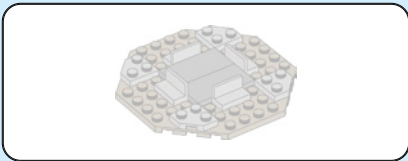

29

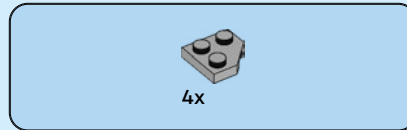
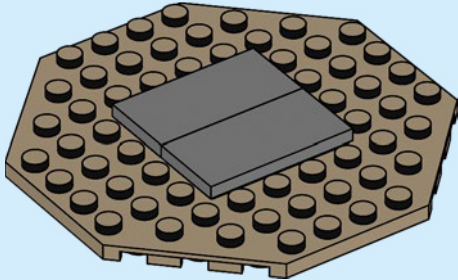

30

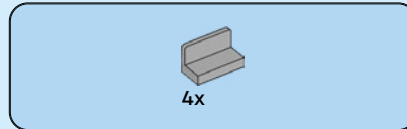
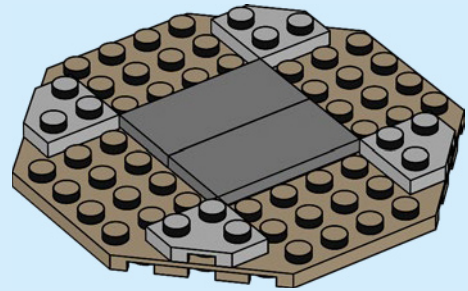

31

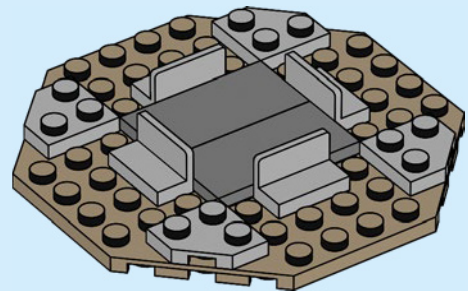

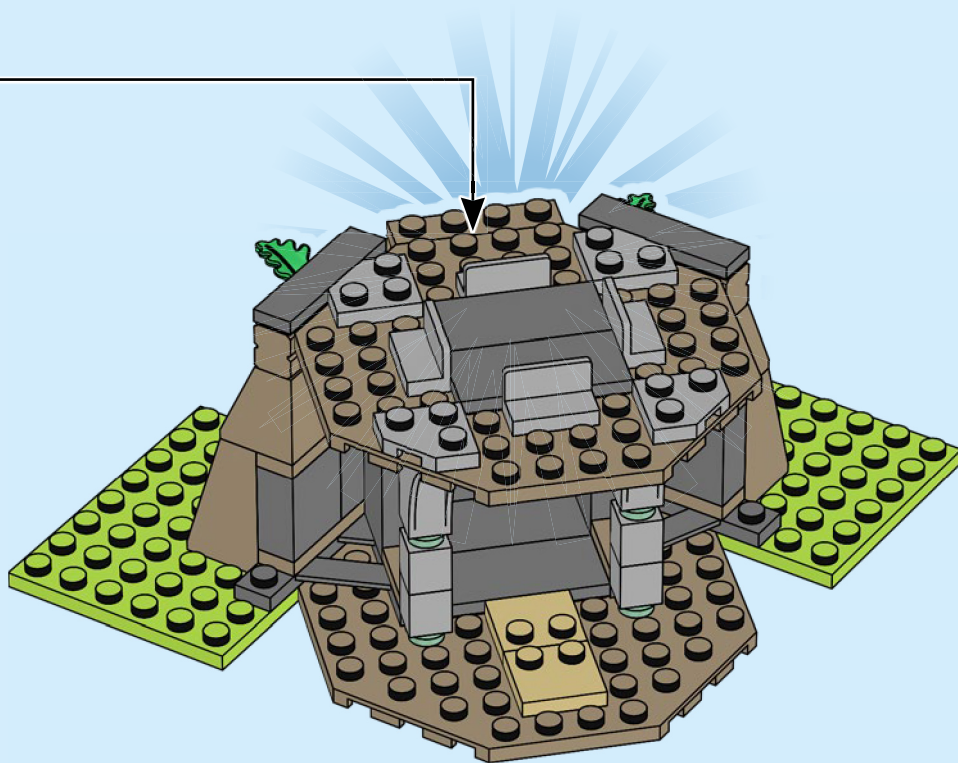

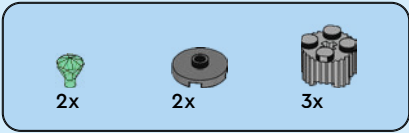

33

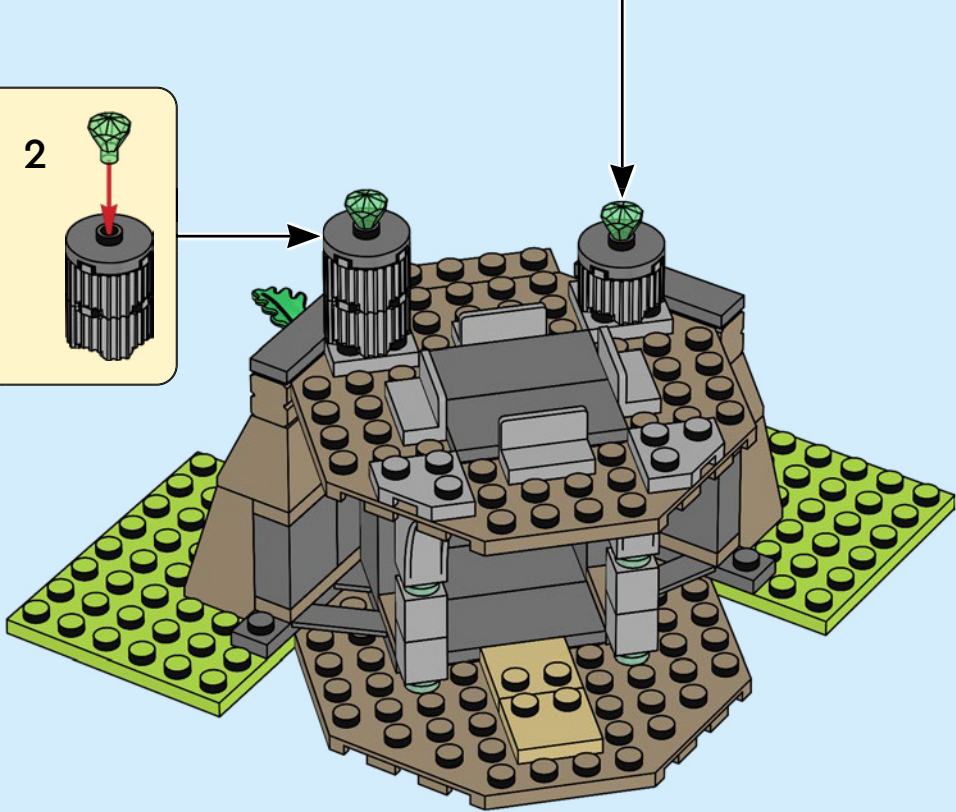
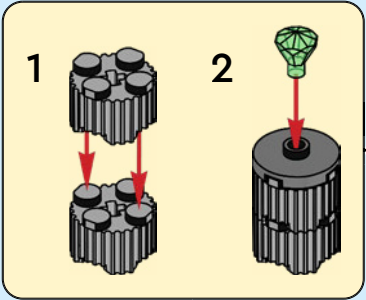
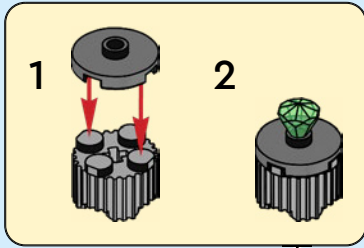

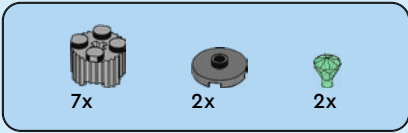

34

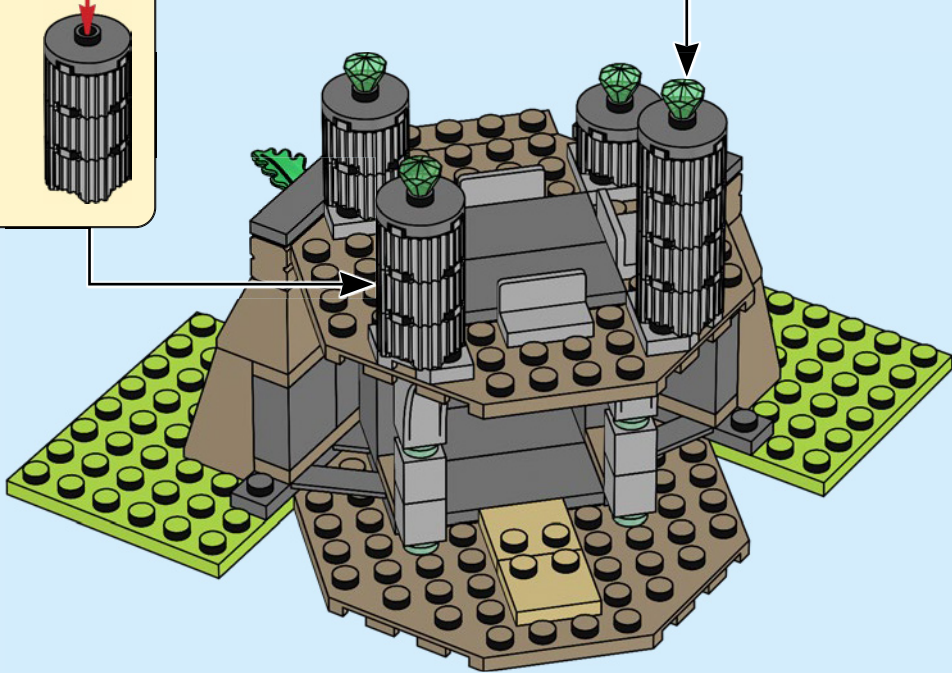
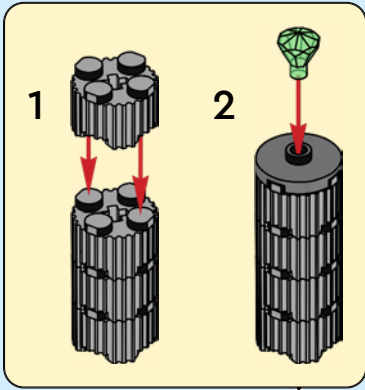
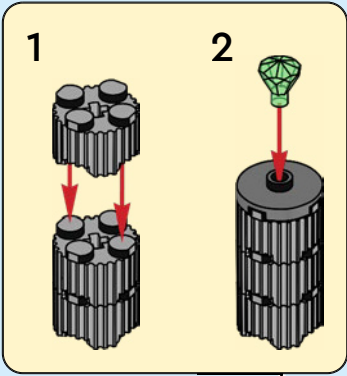

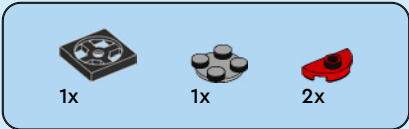

35

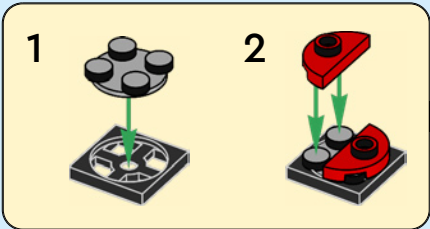
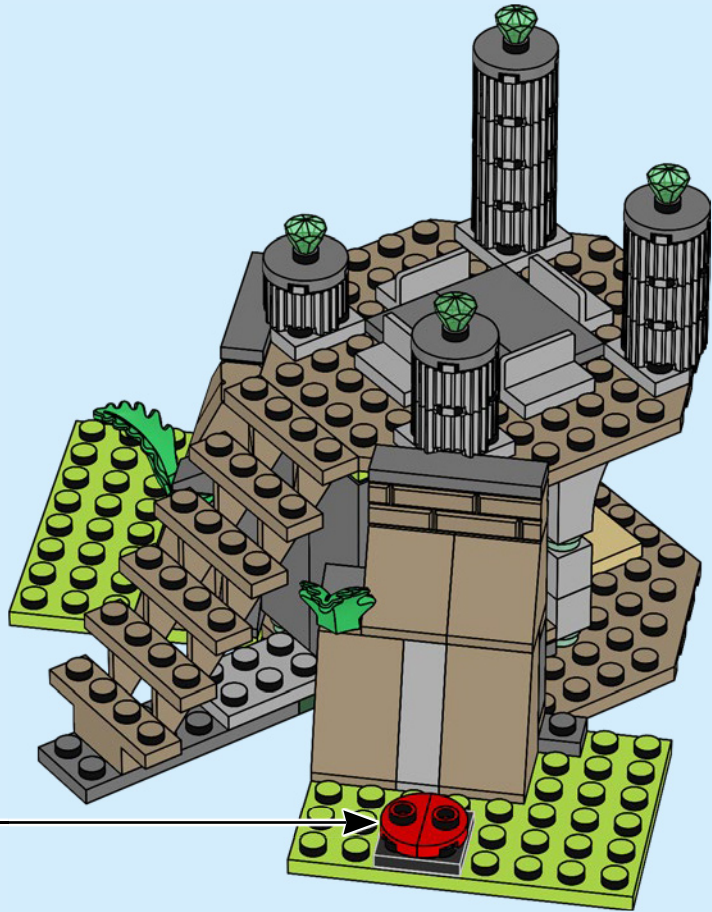

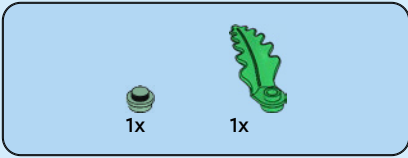

36

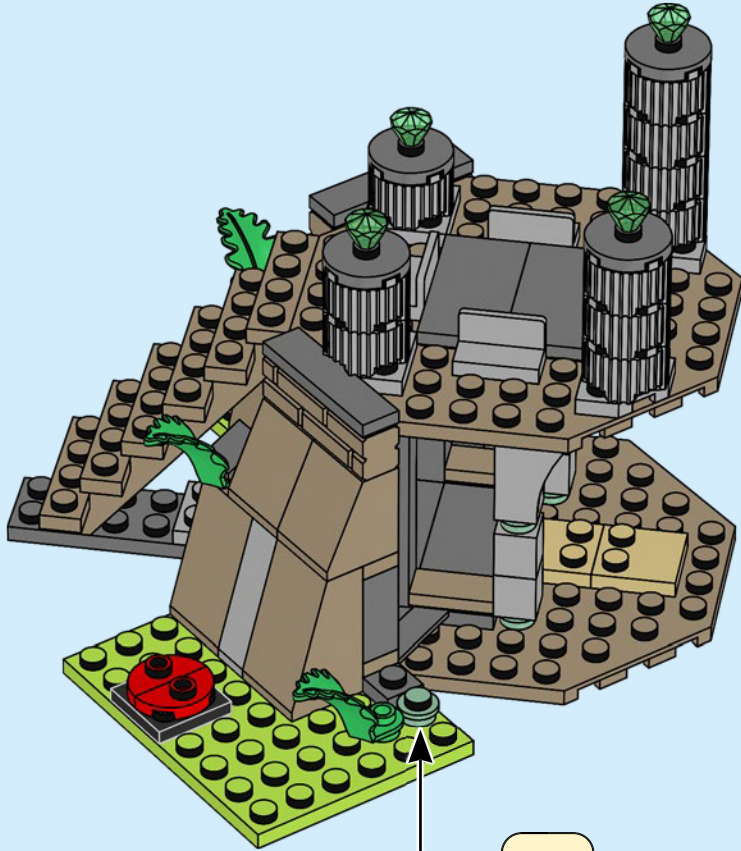



1x

37

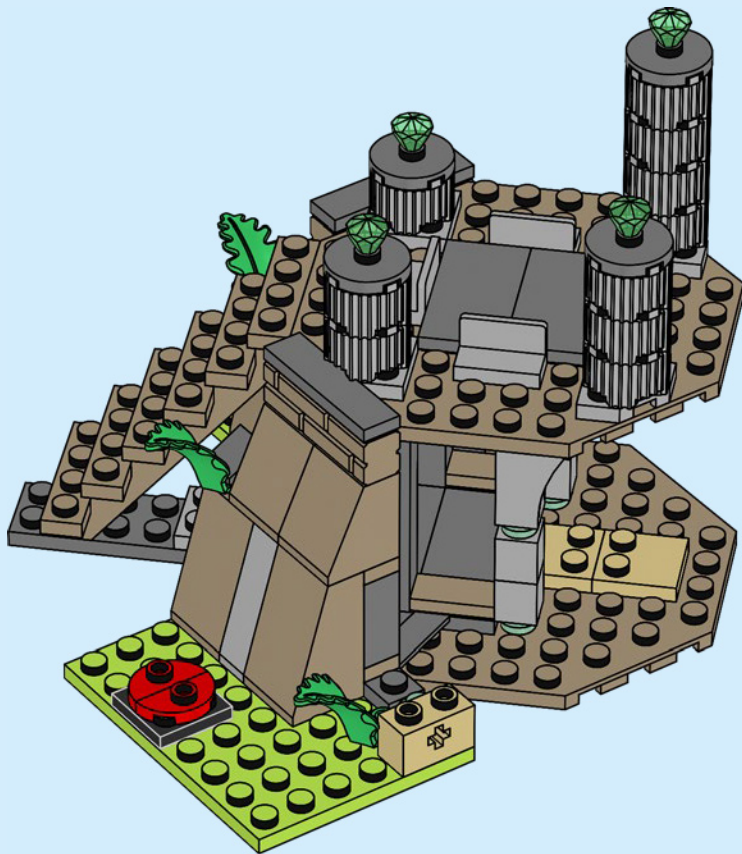



2x

38

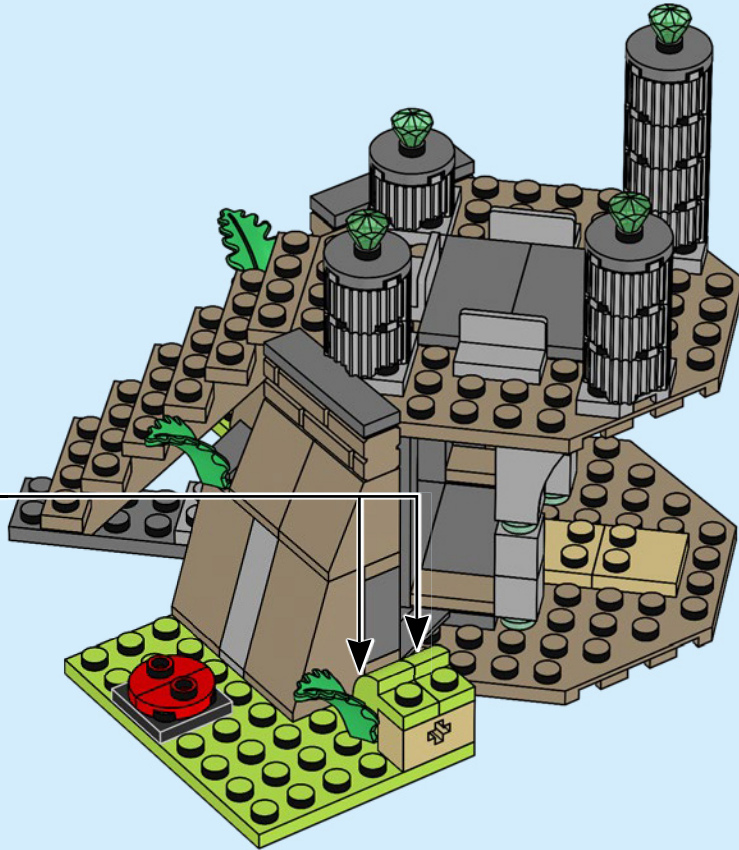

2x





1x

39

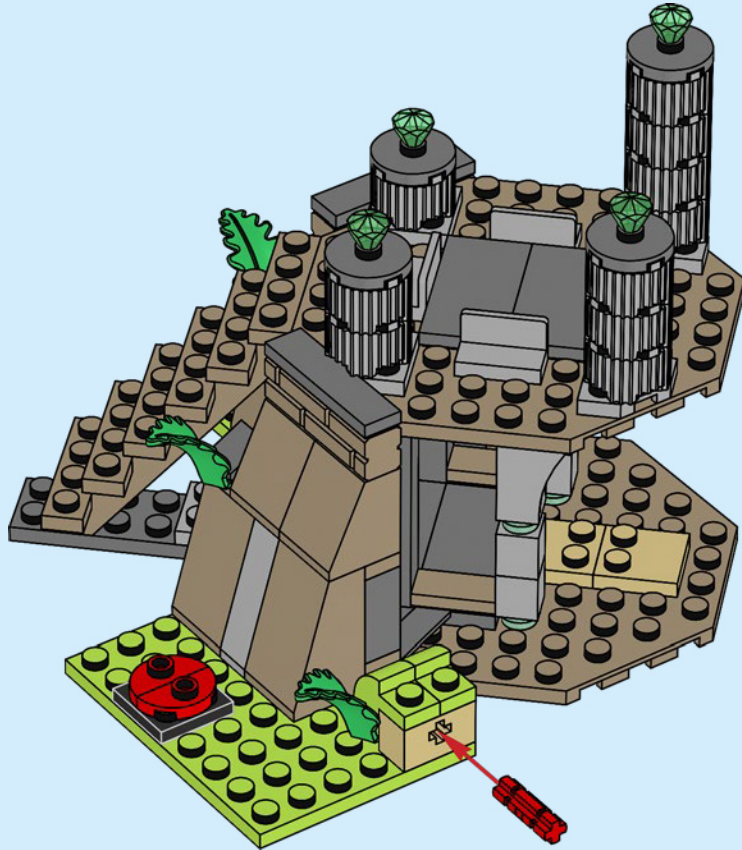



1x



1x

40

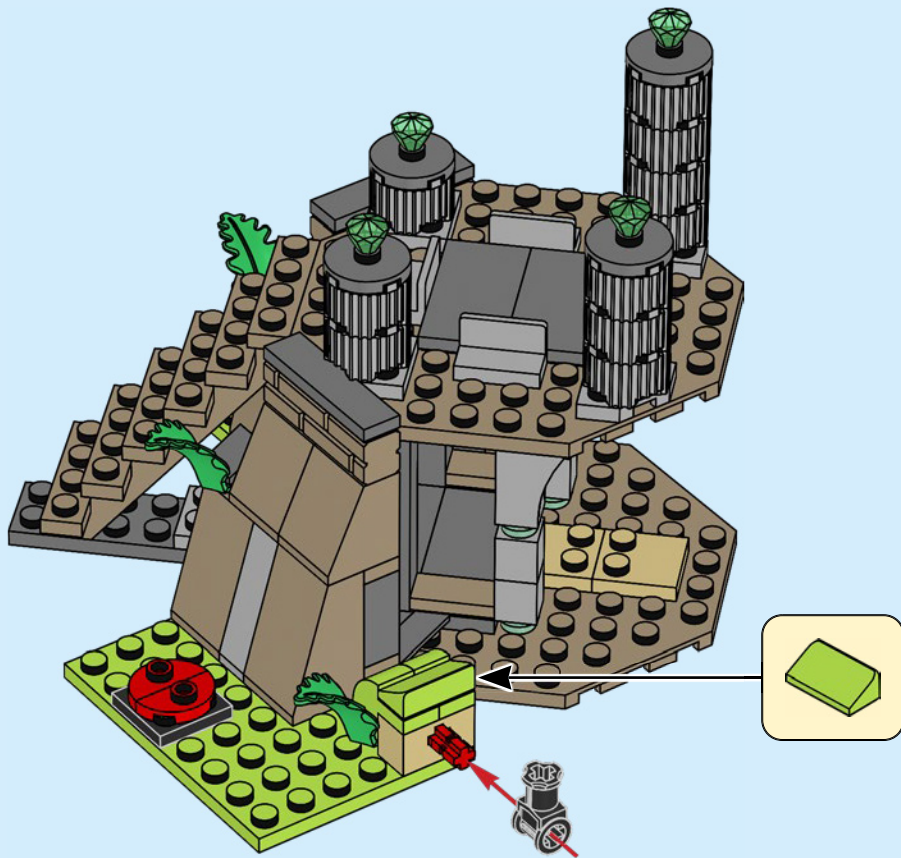

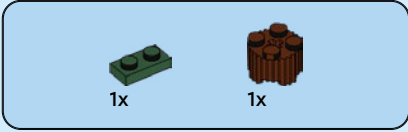

41

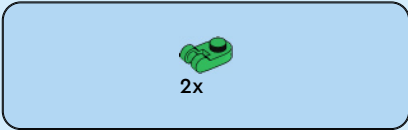

42

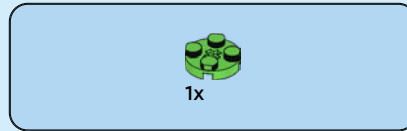

43

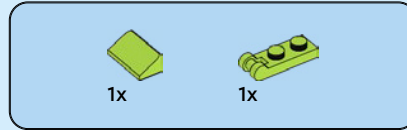
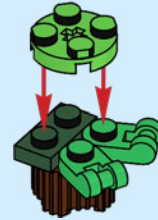

44

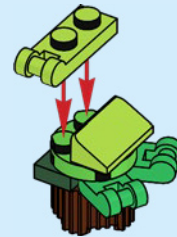



2x

45

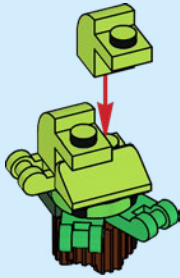

1x

46



2x



4x



2x

47

1

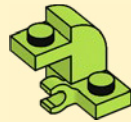

2

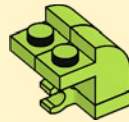

3

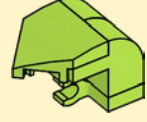

2x

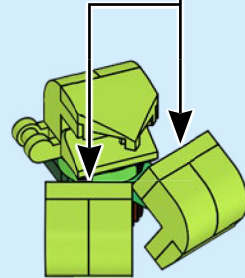



48

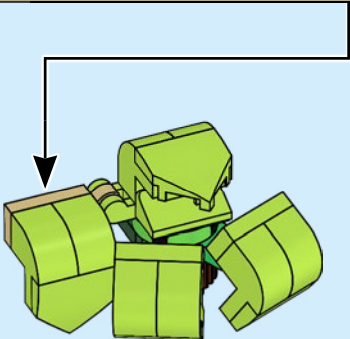
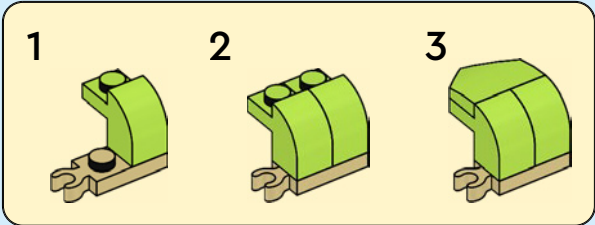



49

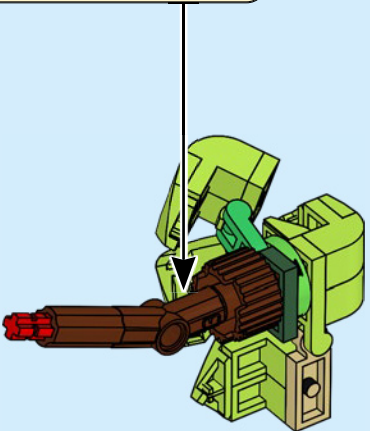
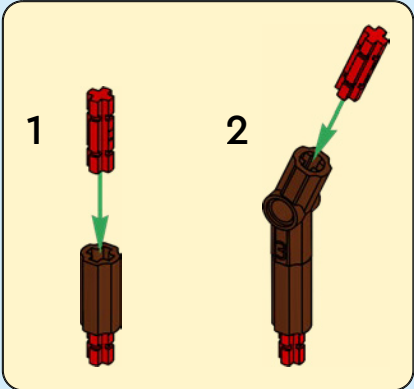

50

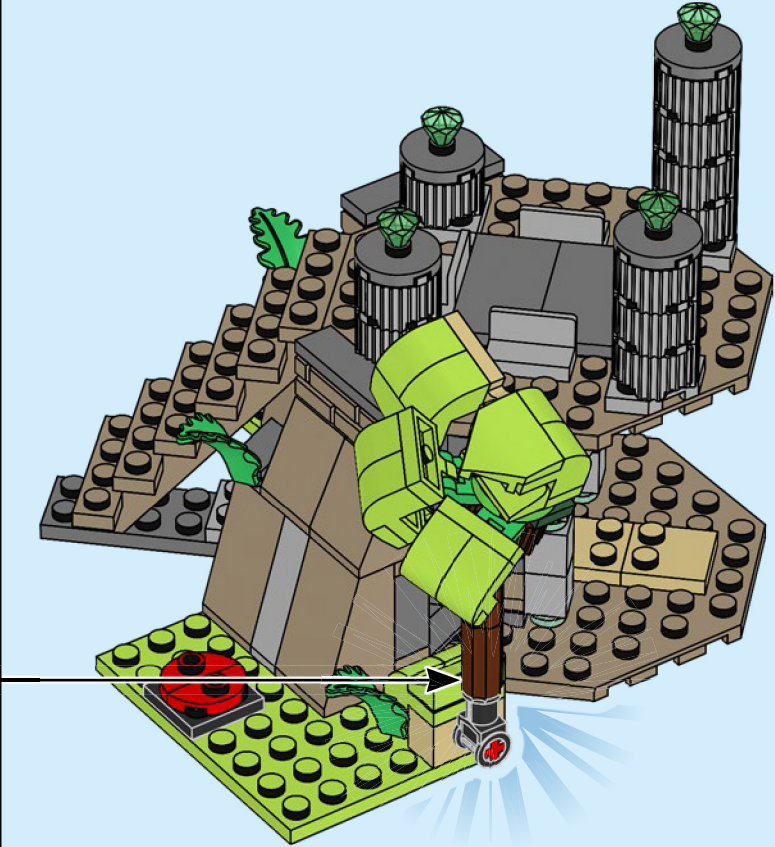



1x



2x

51

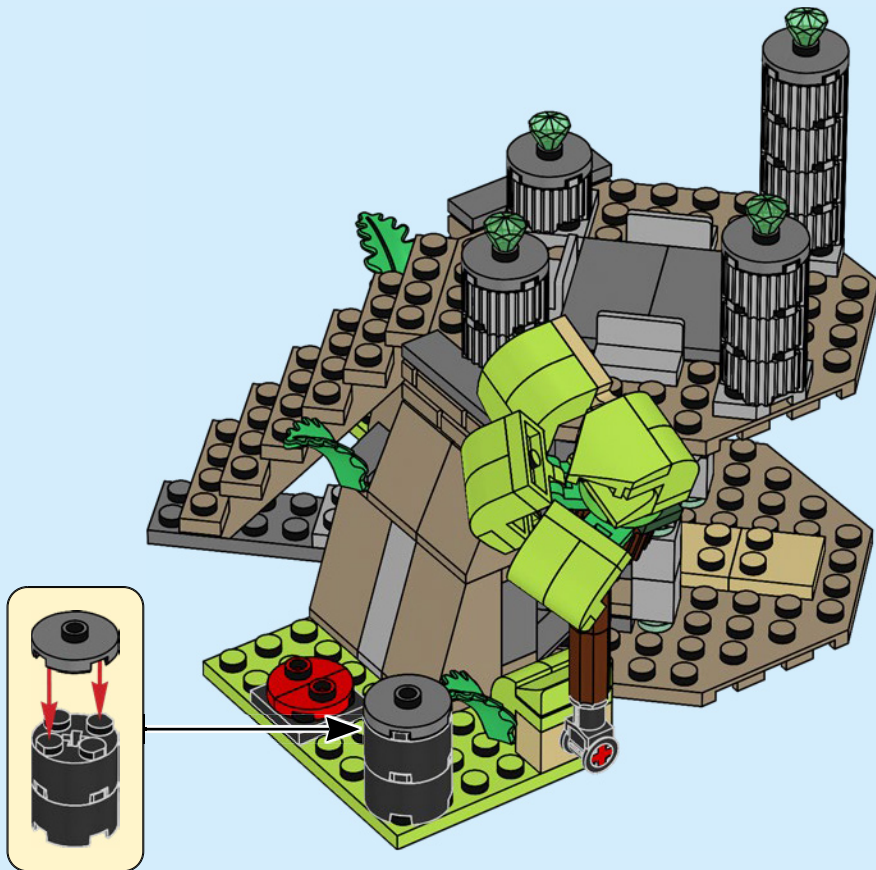

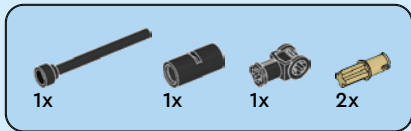

52

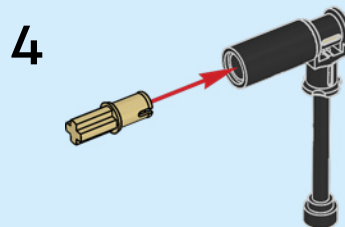
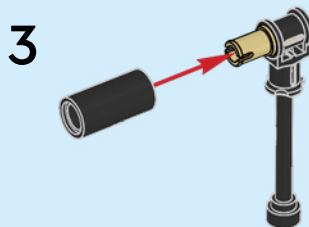
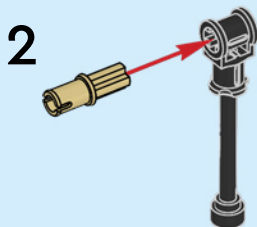
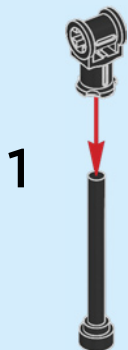

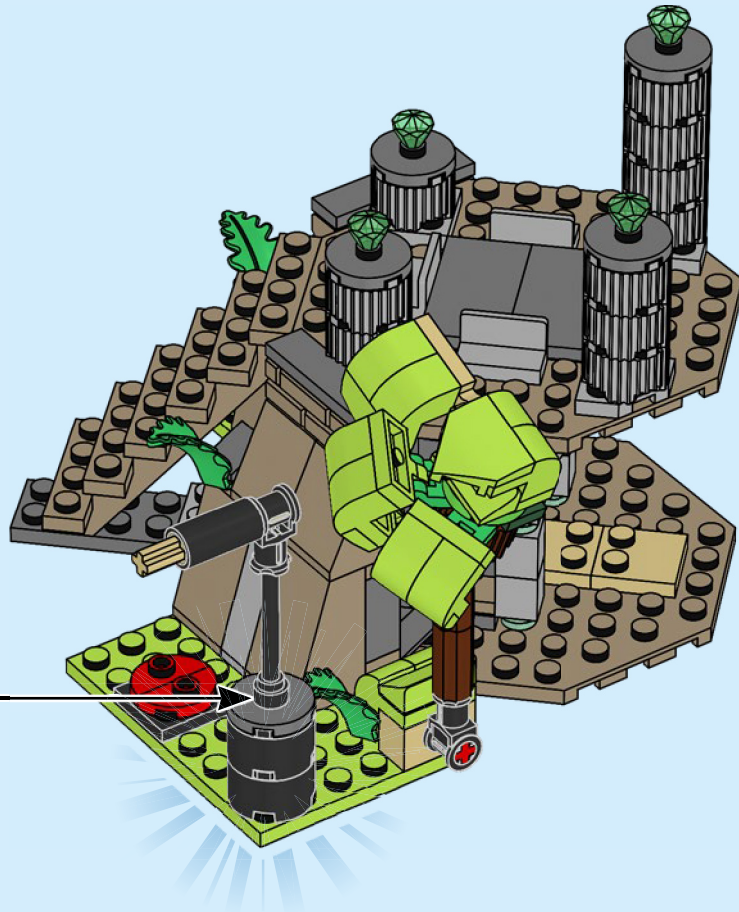

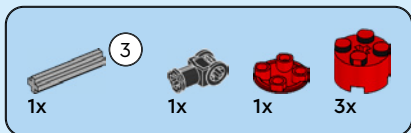

53

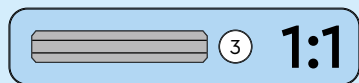
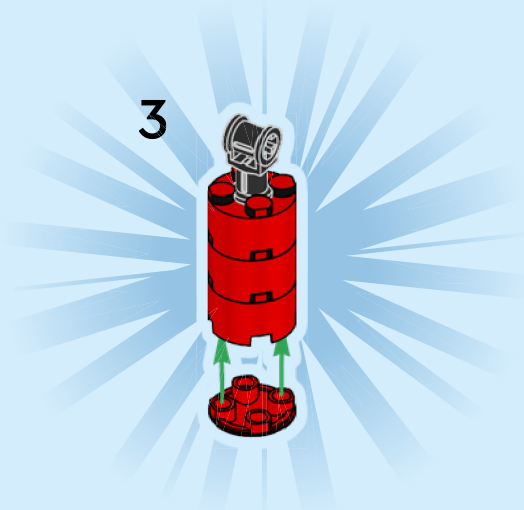
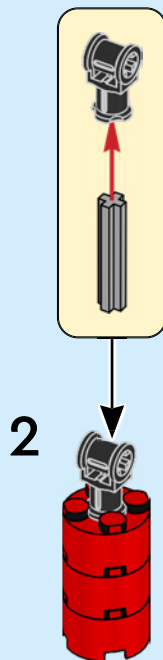
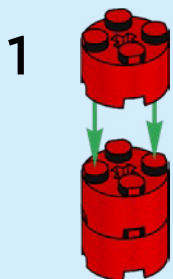

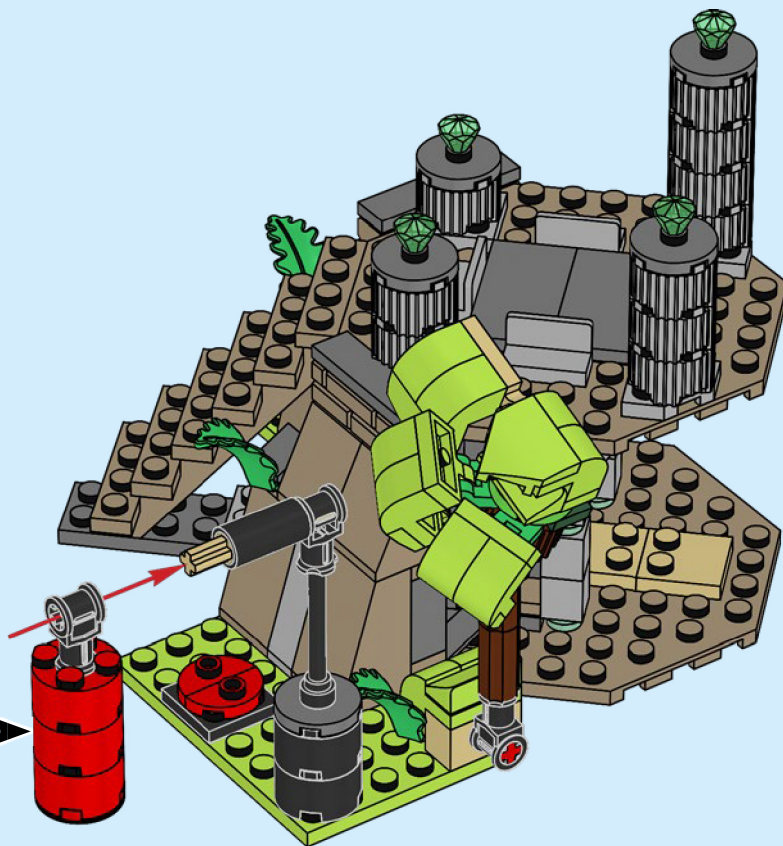





1x

54

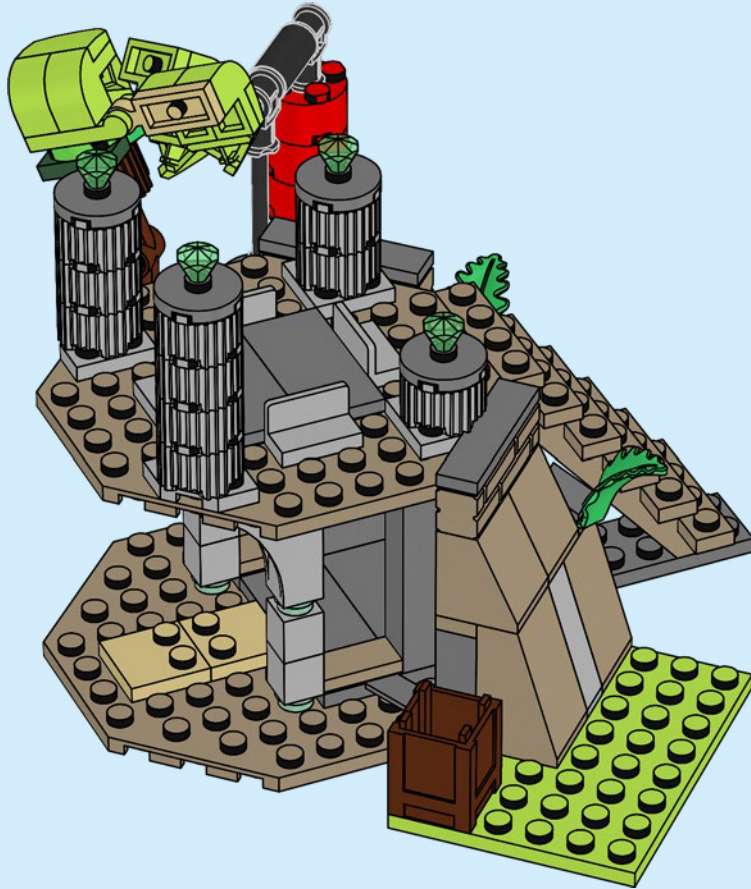



1x



1x

55



1x

56



1x



1x



1x



1x

57

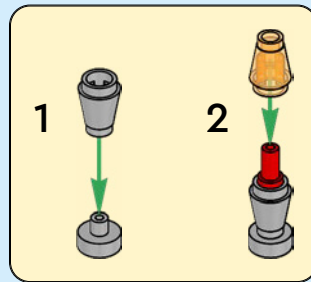

58

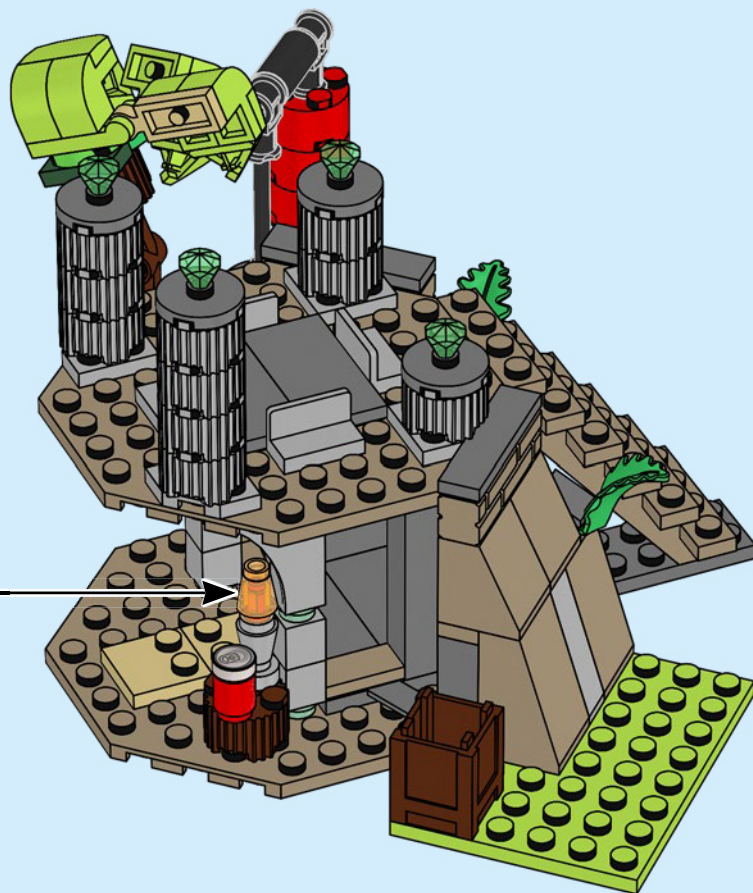

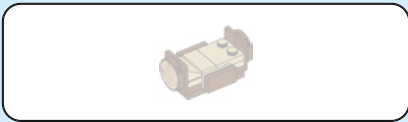

59

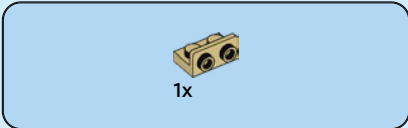

60



61

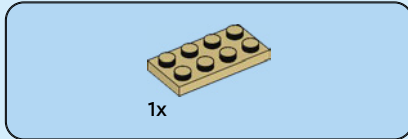
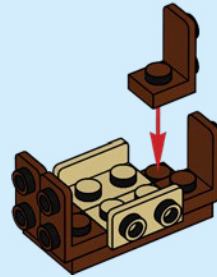

62

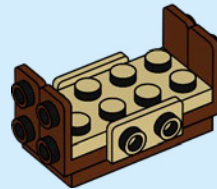

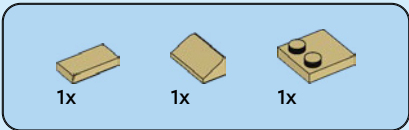

63

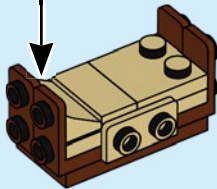
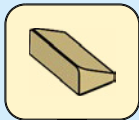

64

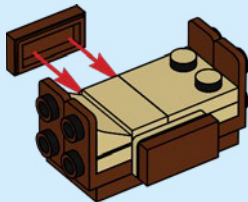

65

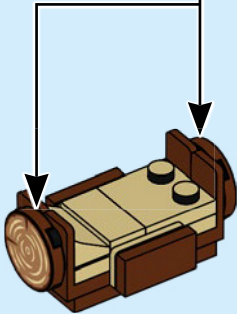

66

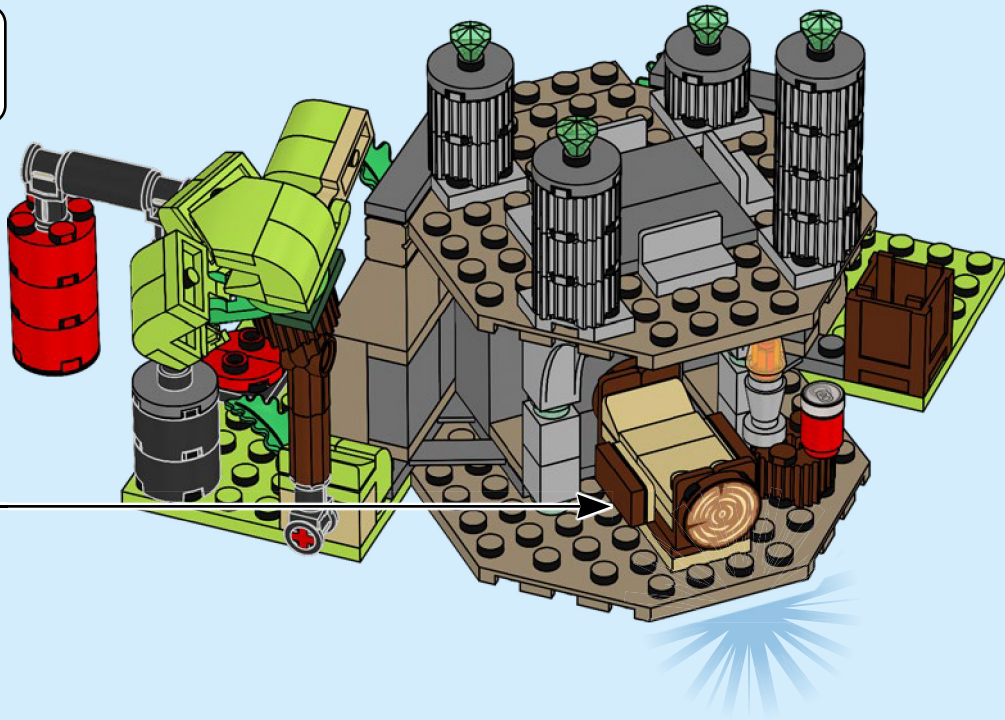

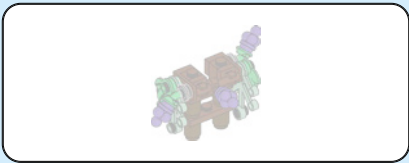

67

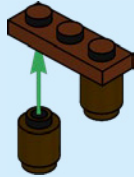

68

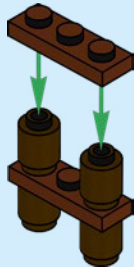

69

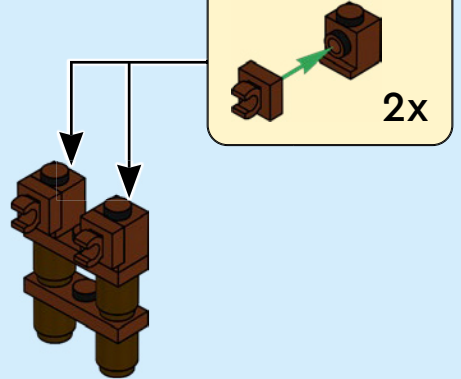

70

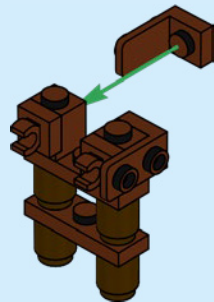

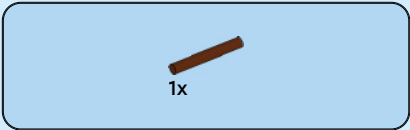

71

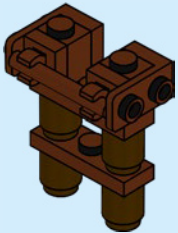

72

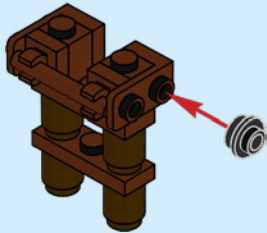

73

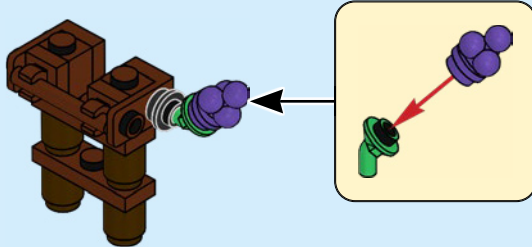

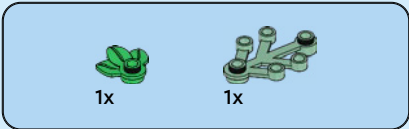

74

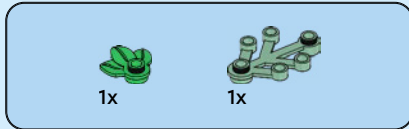
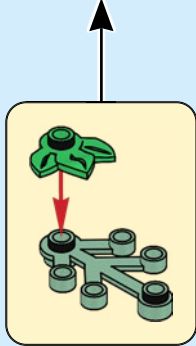
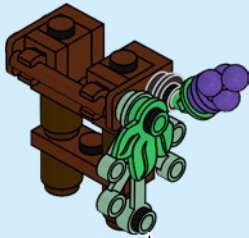

75

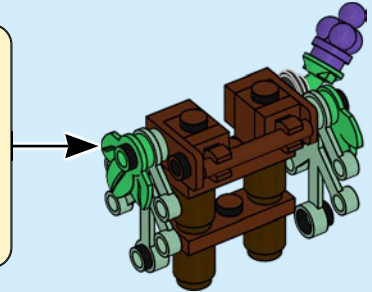
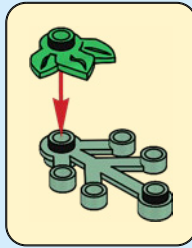
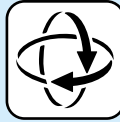

76

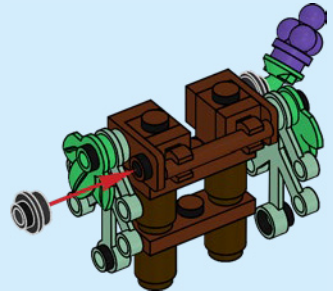



1x



1x

77

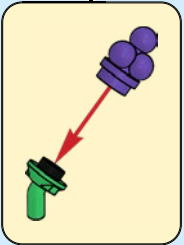
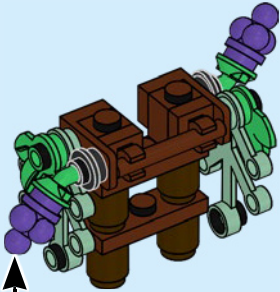

1x



1x

78

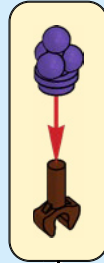
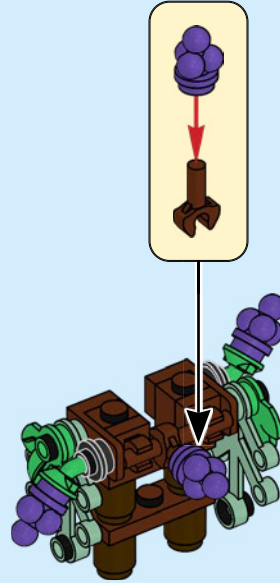

79

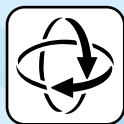

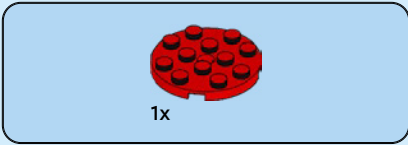
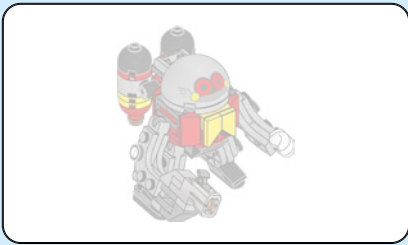

1



2

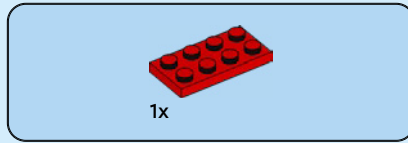
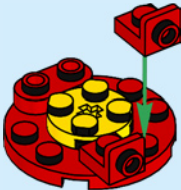

3

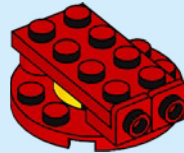

4

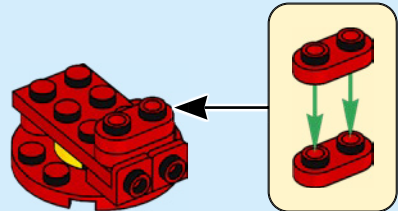



1x

5

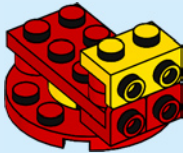

1x



2x

6

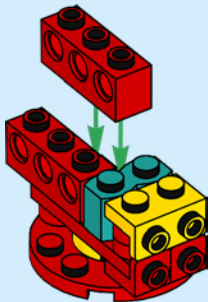

1x



1x

7

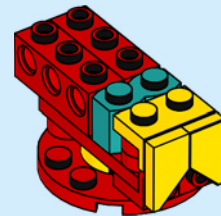



2x



4x



4x



4x



2x

8

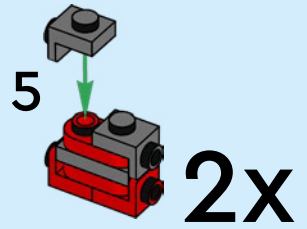
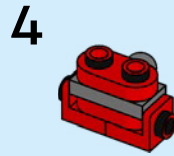
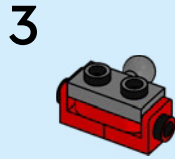
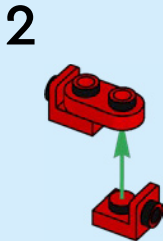
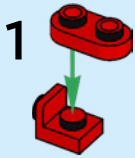

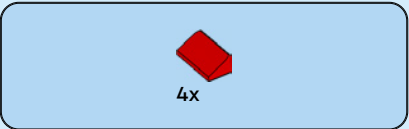

9

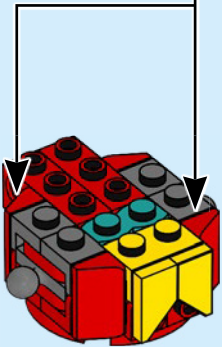
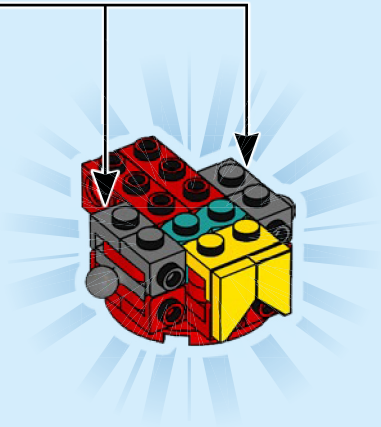
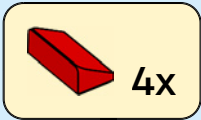

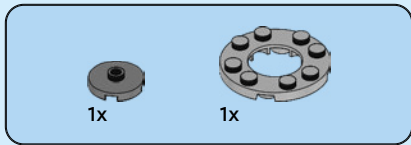

10

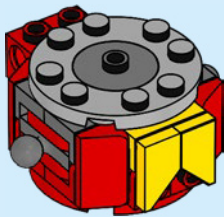

11

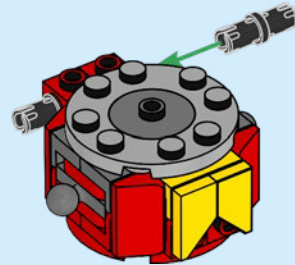



12

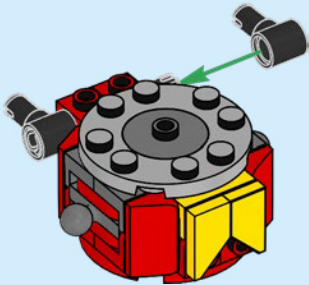

13

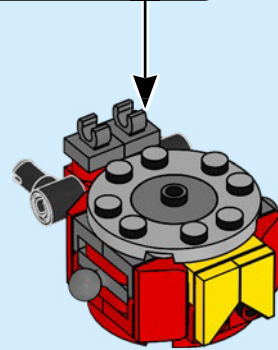
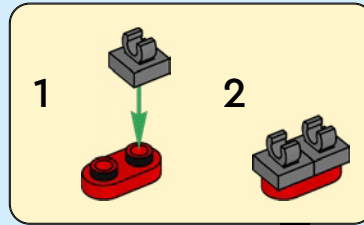



1x

14

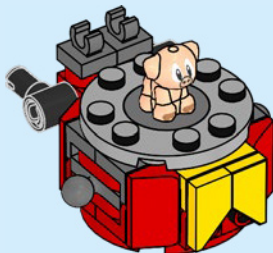

1x

15

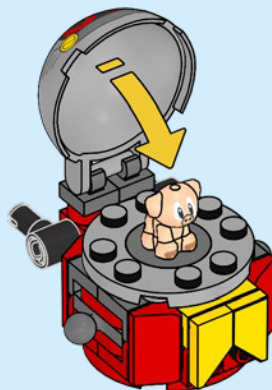

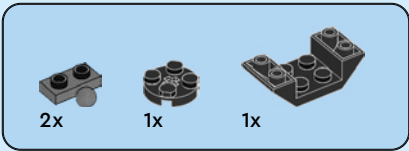

16

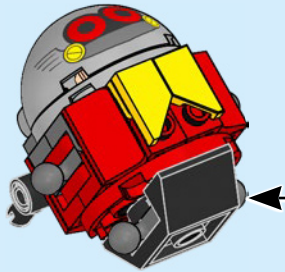
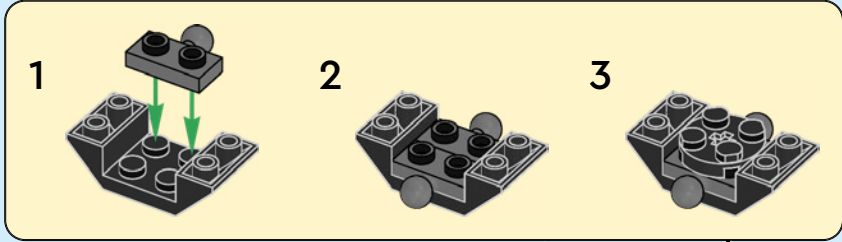

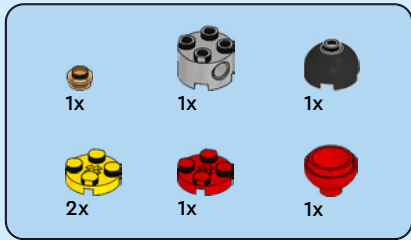

17

1



2

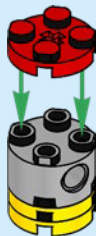

3



4

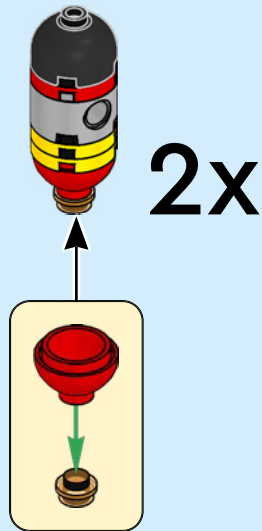

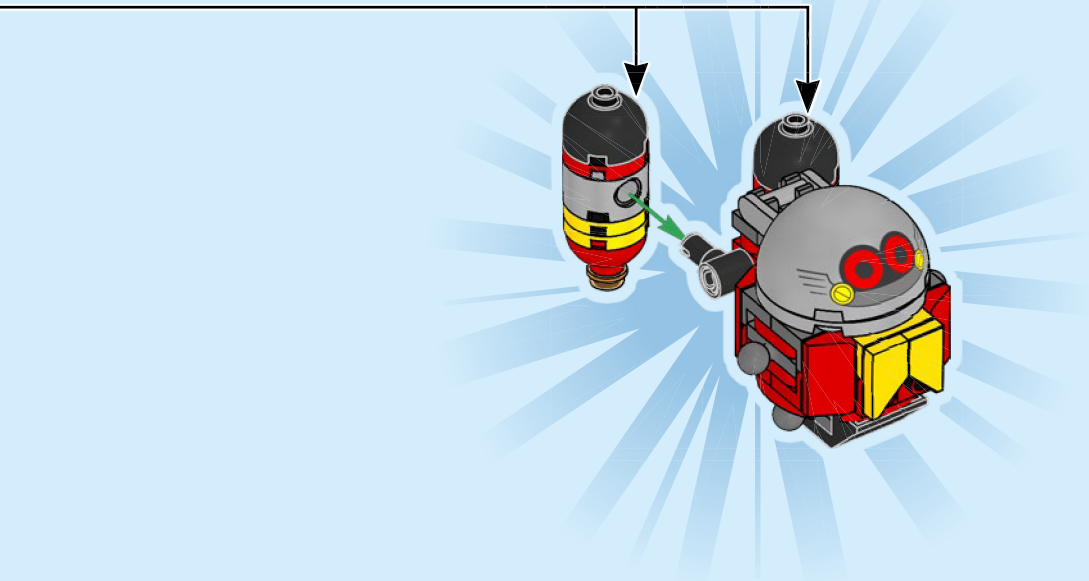

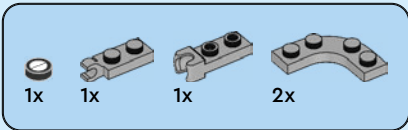

18

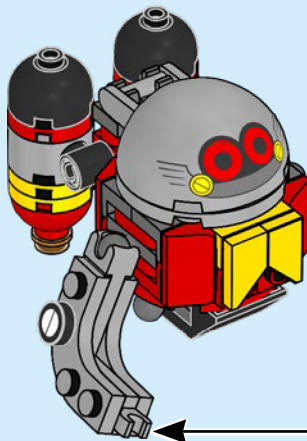
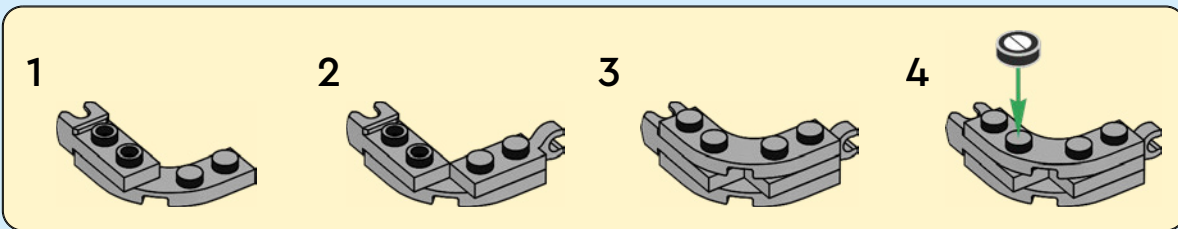

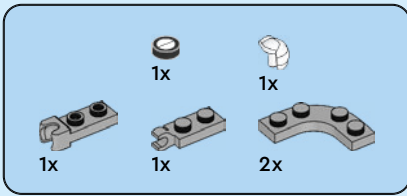

19

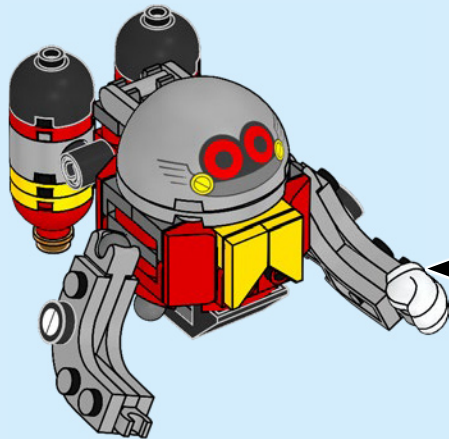
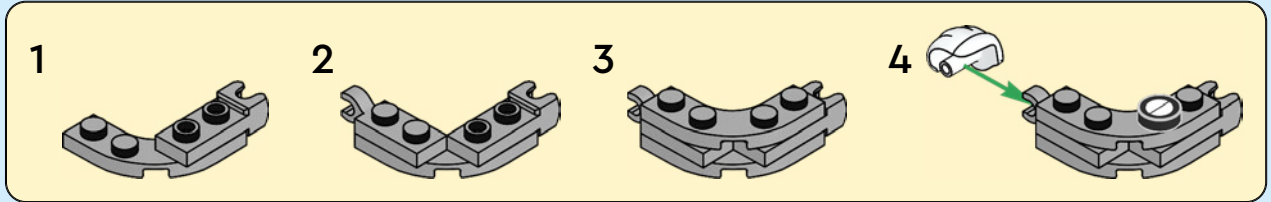

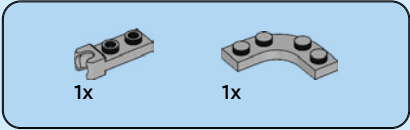

20

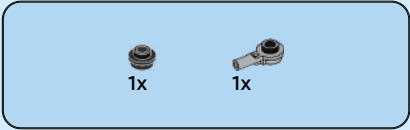
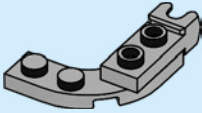

21

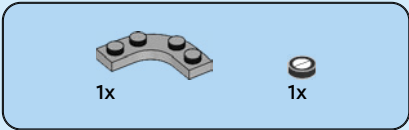
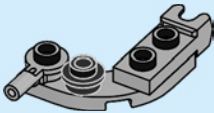

22

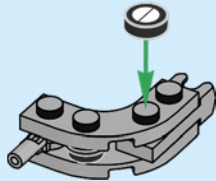

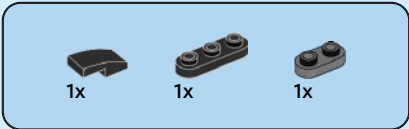

23

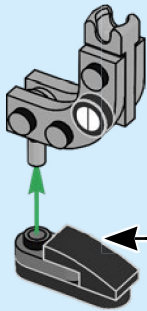
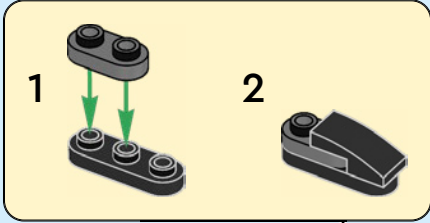

24

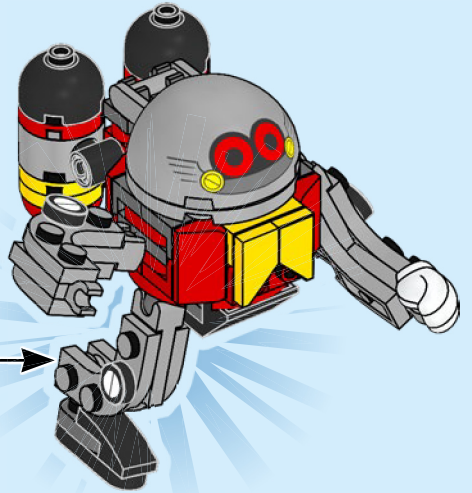

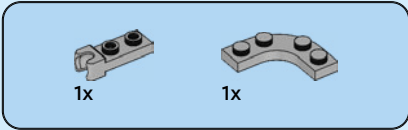

25

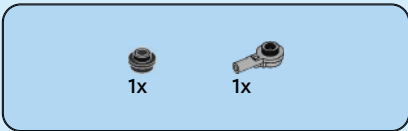
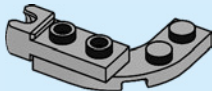

26

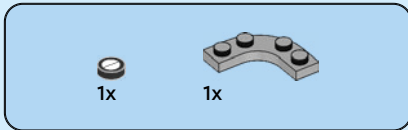

27

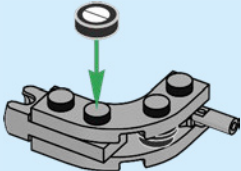

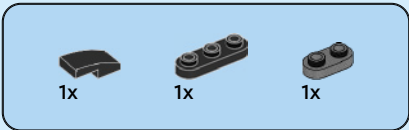

28

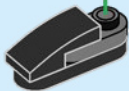
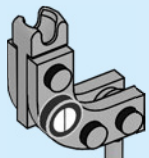
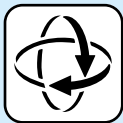
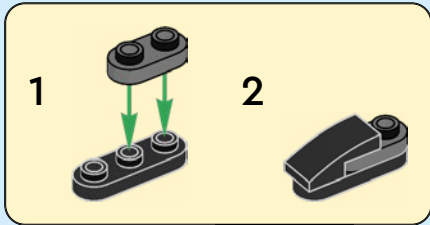

29

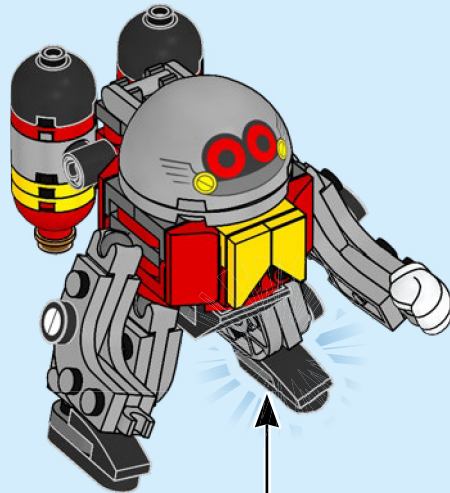

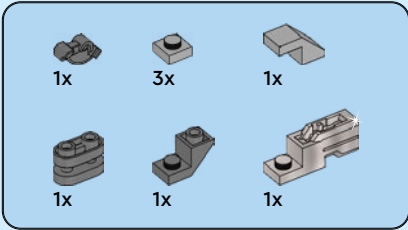

30

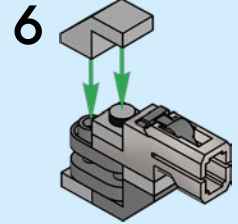
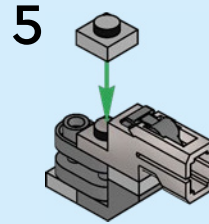
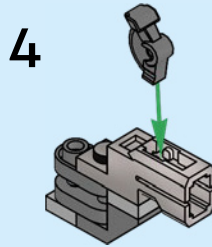
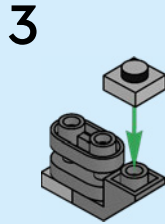
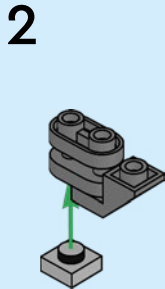
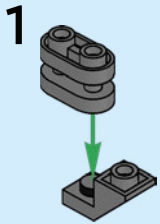

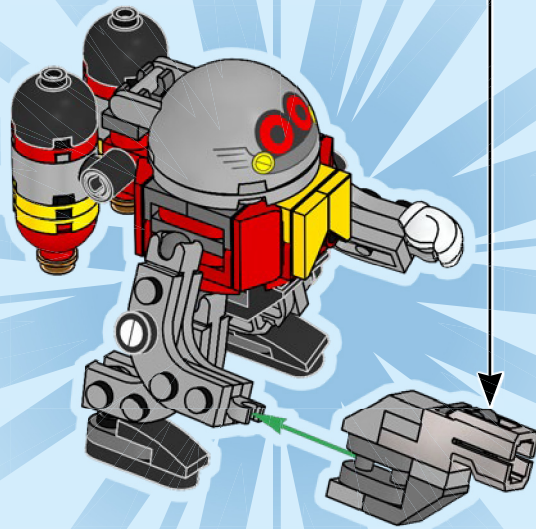

3x



31

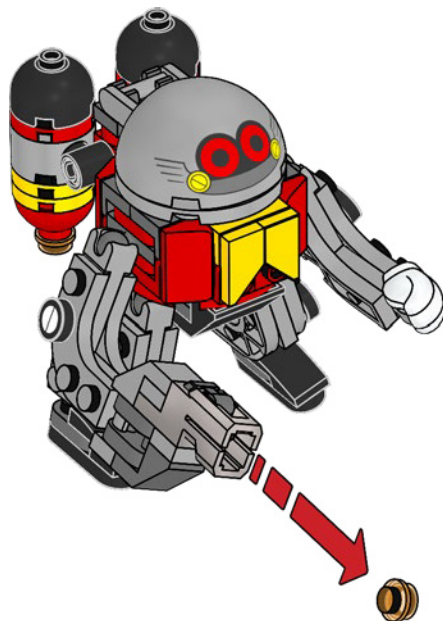
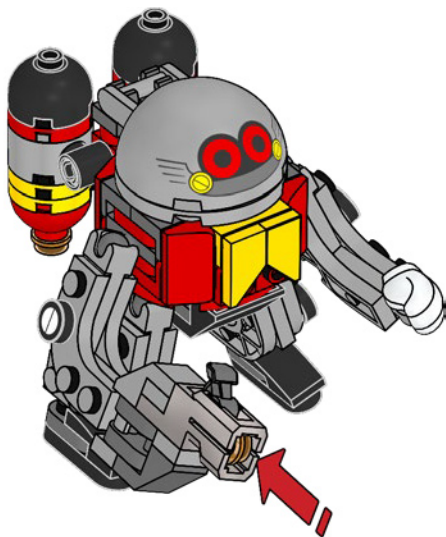





SONIC™

THE HEDGEHOG

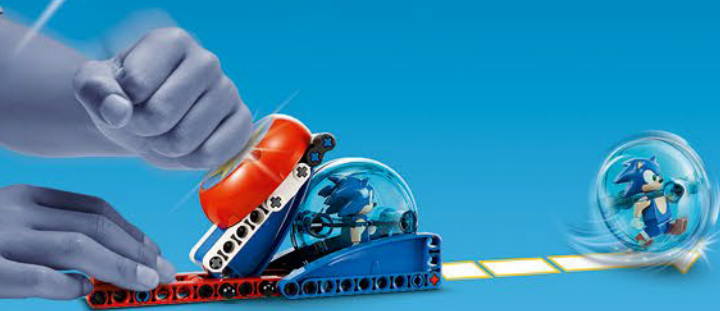

EXPLORE MORE
DÉCOUVRIR PLUS
EXPLORA MÁS



 LEGO.com/sonic



1x 6506160
 2x 6431337
 2x 6248490
 1x 6510482
 1x 4624086
 2x 4666579
 1x 4114026
 1x 6219794
 2x 6313611
 1x 6372047
 3x 6221467
 1x 4114309
 1x 6452585
 6x 6249907
 1x 6399645

2x 6510057
 8x 6210269
 2x 6065839
 4x 4651524
 4x 403221
 4x 4142865
 1x 4278275
 1x 6173922
 3x 614321
 1x 6508124
 1x 6492337
 2x 6494104
 1x 6453242

1x 6474530
 1x 6189130
 1x 4515348
 2x 302021
 1x 6510151
 1x 6294771
 1x 6078279
 5x 403224
 2x 6331822
 1x 6510138
 2x 6247387
 1x 6185994
 1x 6116606

4x 6168646
 4x 6478985
 1x 403226
 2x 6279875
 2x 6429056
 2x 614326
 2x 6282140
 3x 6331716
 1x 6173119
 2x 6047276
 2x 6428168
 1x 368026
 1x 395726
 1x 4188534

2x 6510190
 2x 6229130
 2x 6253140
 3x 6411022
 1x 6138624
 2x 4537251
 2x 6025026
 10x 6411328
 2x 6334046
 4x 6442920
 1x 6133859
 1x 6129601
 2x 6100914

4x 6013102
 2x 4496699
 4x 4616593
 4x 6000852
 4x 4626904
 2x 6502374
 1x 6506126
 2x 6288246

1x
4529241

1x
6258831

4x
4211389

3x
4211399

2x
6227897

10x
4650645

1x
4540203

2x
6372076

4x
6186657

4x
6146223

2x
4211494

1x
6213378

2x
6319336

1x
4211376

1x
4211815

4x
6043639

2x
6225228

1x
4211419

1x
6167798

8x
6383110

1x
4211395

1x
6478984

1x
4618874

1x
6439053

2x
6348057

2x
4225469

6x
6341553

2x
6036503

2x
6182435

1x
4531751

2x
4211151

1x
6428805

1x
4520638

1x
6261388

2x
4211152

1x
4211186

1x
6395635

6x
6115080

4x
6039479

2x
6069164

1x
6435267

4x
4210978

4x
4211075

2x
4211053

4x
4560184

2x
6133811

1x
4211002

2x
4504378

4x
6413106

2x
6344022

1x
6360675

1x
6390673

2x
6221607

1x
6172233

5x
6240227

5x
6278447

7x
6403175

2x
6328339

4x
6247788

1x
6325980

1x
6174946

1x
6501235

1x
6443212

1x
6443196

4x
6022105

1x
6322904

1x
6345950

 [LEGO.com/service](https://www.LEGO.com/service)

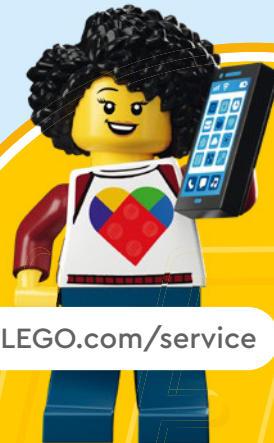

YOU COULD **WIN**

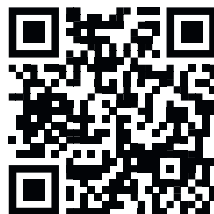

Scan this QR code or go to **LEGO.COM/PRODUCTFEEDBACK** and give us your short feedback about this LEGO® set for a chance to win a cool LEGO prize.

Terms and Conditions apply*

EN: YOU COULD WIN. Terms and Conditions apply* **DE: Du könntest GEWINNEN.** Es gelten die Teilnahmebedingungen* **FR: Tu pourrais GAGNER.** Des conditions s'appliquent* **IT: Potresti VINCERE tu.** Termini e condizioni sono applicabili* **ES: Puedes GANAR.** Aplican términos y condiciones* **PT: Poderá GANHAR.** Aplicam-se termos e condições* **ZH: 轻松获奖. 条款和条件适用*** **PL: Szansa na WYGRANĄ.** Obowiązują warunki korzystania* **CS: Máte šanci VYHRÁT.** Platí všeobecné smluvní podmínky* **SK: Máte šancu VYHRAŤ.** Platia všeobecné zmluvné podmienky* **HU: TE IS NYERHETSZ.** Felhasználási feltételek érvényesek* **RO: Ai putea CÂȘTIGA.** Se aplică termeni și condiții* **BG: Можете да СПЕЧЕЛИТЕ.** Има определени правила и условия* **LV: Tu vari LAIMĒT.** Ir spēkā noteikumi un nosacījumi.* **ET: Sul on võimalus VÕITA.** Kehtivad tingimused* **LT: Jūs galite LAIMĖTI.** Taikomos sąlygos*

*[LEGO.com/productfeedback-terms](https://www.lego.com/productfeedback-terms)

LEGO and the LEGO logo are trademarks of the/sont des marques de commerce du/son marcas registradas de LEGO Group.
©2024 The LEGO Group.

©SEGA. All rights reserved. SEGA is registered in the U.S. Patent and Trademark Office.
SEGA and SONIC THE HEDGEHOG are either registered trademarks or trademarks of SEGA CORPORATION.

6530638