



SONIC™

THE HEDGEHOG

76997



LEGO® Builder



LEGO.com/sustainable-packaging



FR
DONNEZ
OU
RECYCLEZ



OU



OU



ASSOCIATION

MAGASIN

DÉCHÈTERIE

Adresses sur quefairedemesdechets.fr

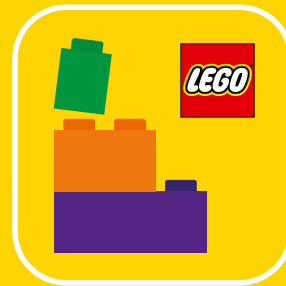

BUILDER



Apple and the Apple logo are trademarks of Apple Inc., registered in the U.S. and other countries and regions. App Store is a service mark of Apple Inc. Google Play and the Google Play logo are trademarks of Google LLC. Tencent and the Tencent logo are trademarks of Tencent Inc.

[LEGO.com/devicecheck](https://www.lego.com/devicecheck)

EN Ask parents' permission before going online | **DE** Eltern um Erlaubnis bitten, bevor du online gehst | **FR** Demande l'autorisation d'un parent avant d'aller en ligne | **IT** Chiedi il permesso ai tuoi genitori prima di andare online | **ES** Pídeles permiso a tus papás antes de conectarte a Internet | **PT** Peça autorização aos pais antes de acederes online | **ZH** 上网前应先征得父母的同意 | **PL** Poproś rodziców o zgodę, zanim wejdiesz do Internetu | **CS** Než půjdeš na internet, požádej rodiče o svolení | **SK** Skôr než pôjdeš na internet, vypýtaj si povolenie od rodičov | **HU** Kérj szülői engedélyt, mielőtt online csatlakoznál! | **RO** Cere permisiunea părinților înainte de a te conecta online | **BG** Поискайте разрешение от родител, преди да влезете онлайн | **LV** Pirms došanās tiešsaistē palūdz atļauju vecākiem | **ET** Enne Interneti kasutamist küsi vanematelt luba | **LT** Prieš prisijungdami prie interneto, atsklauskite tėvų

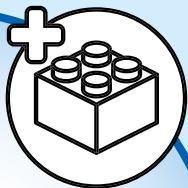

2x

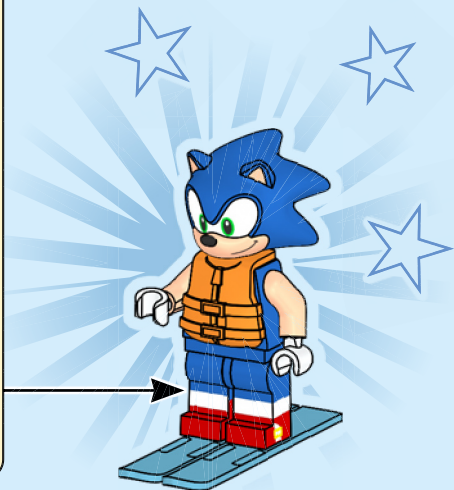
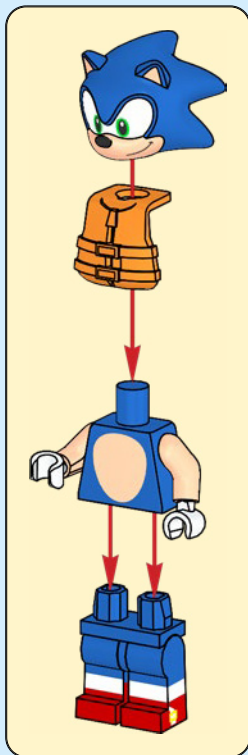
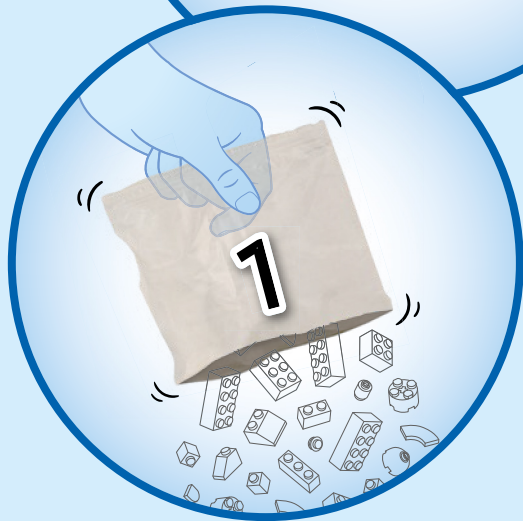

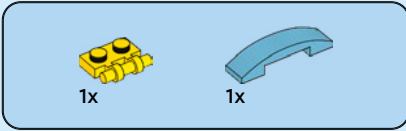
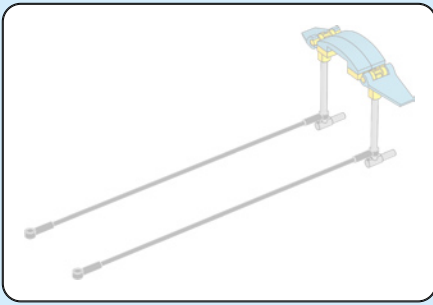

1

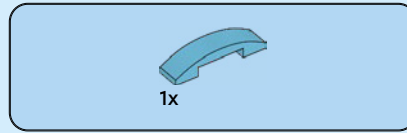
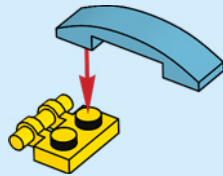

2

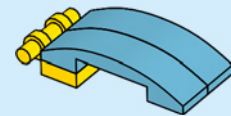



1x

3

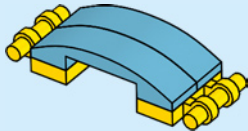

2x

4

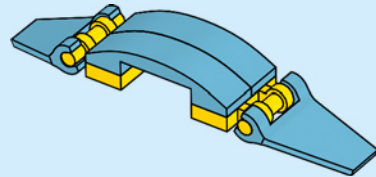

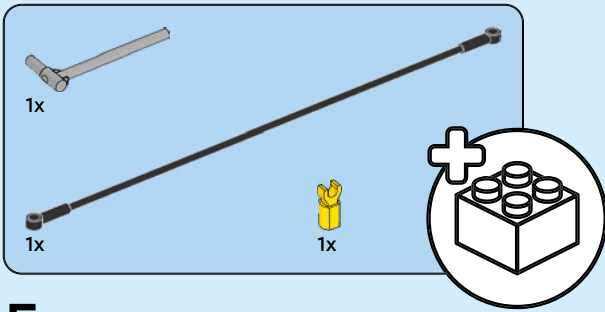

5

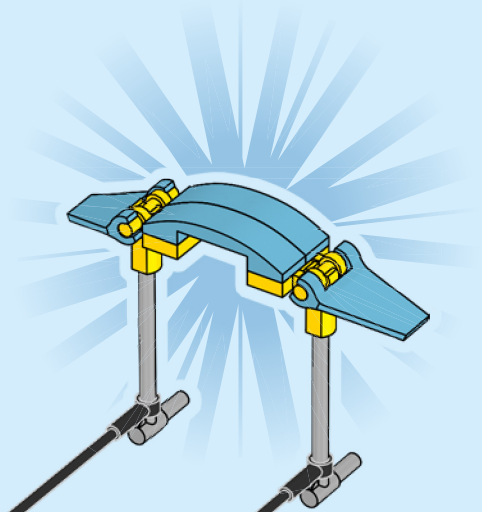
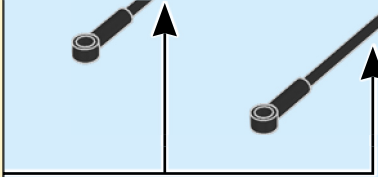
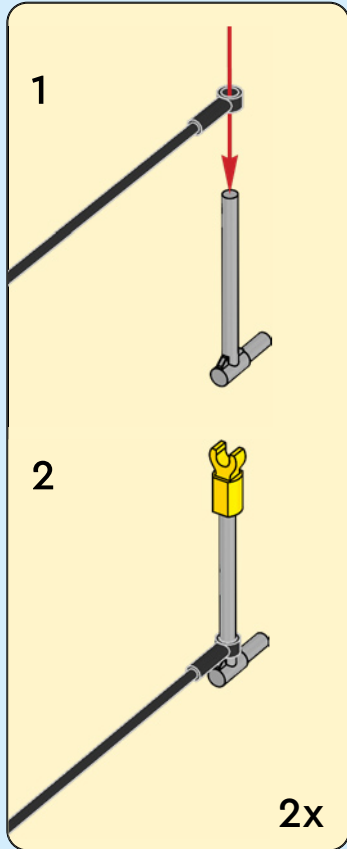

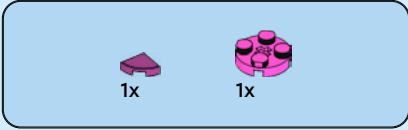
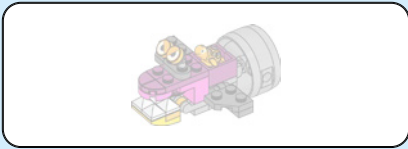

1



2

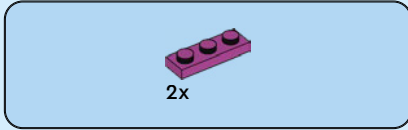

3

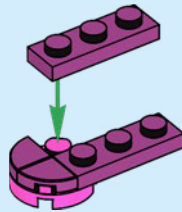

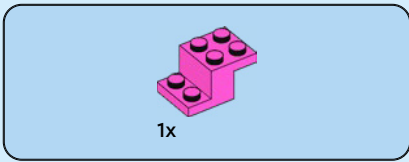

4

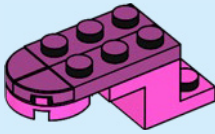

5

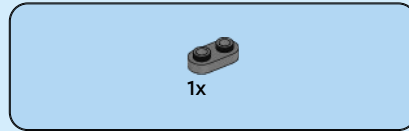
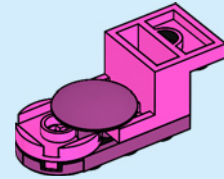
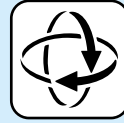

6

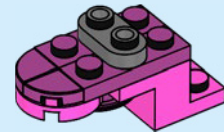
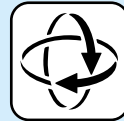

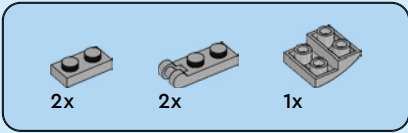

7

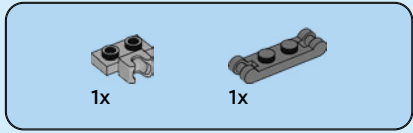
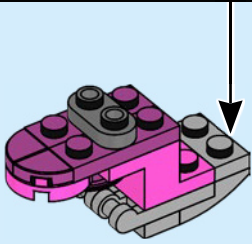
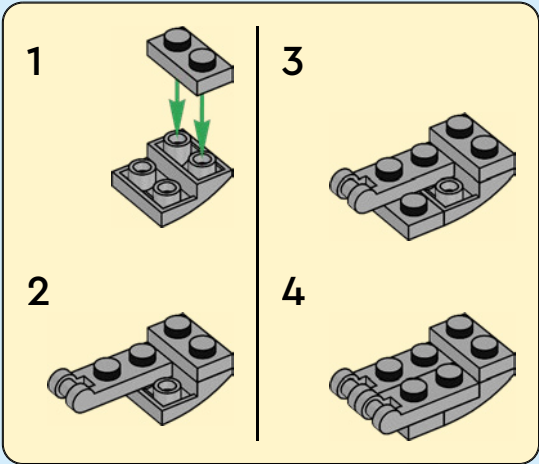

8

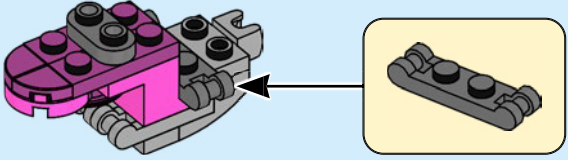



2x

9

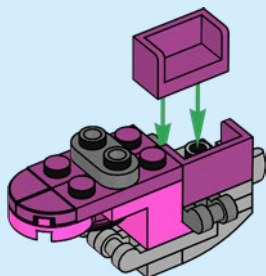

1x



1x

10

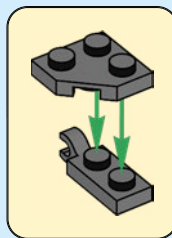
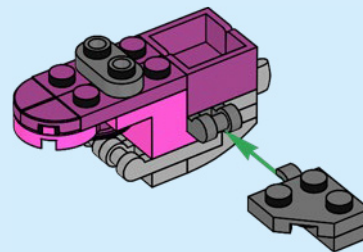

1x



1x

11

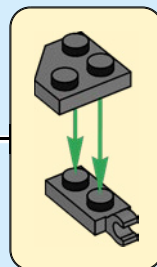
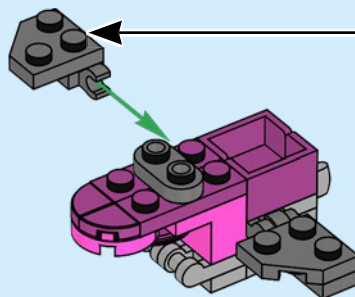

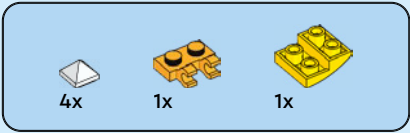

12

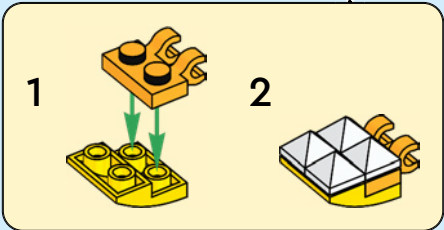
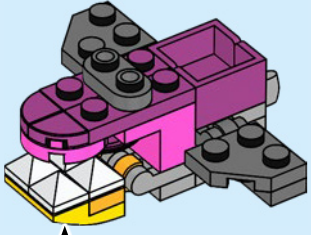

13

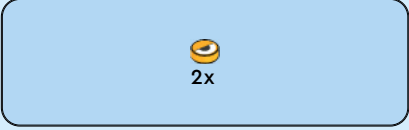
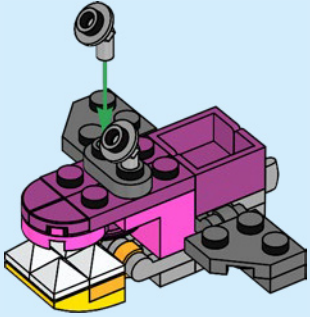

14

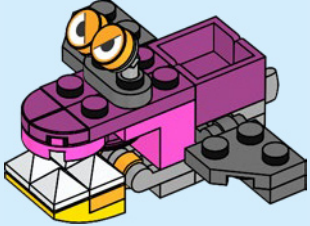

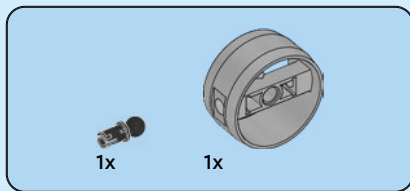

15

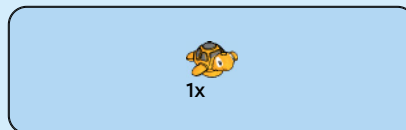
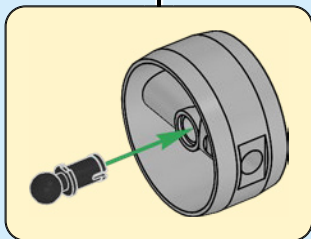
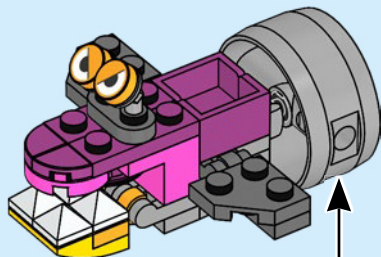

16

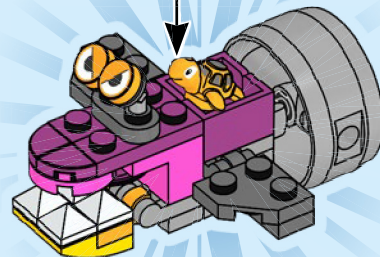

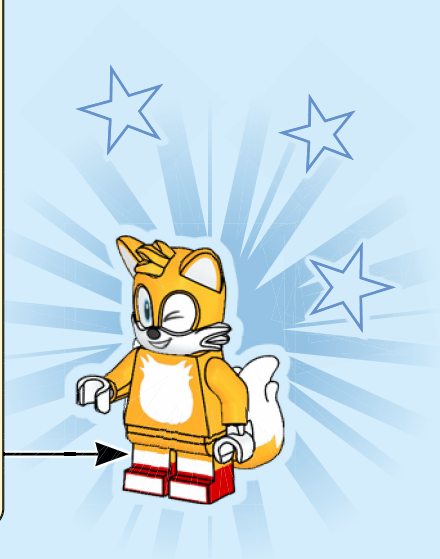
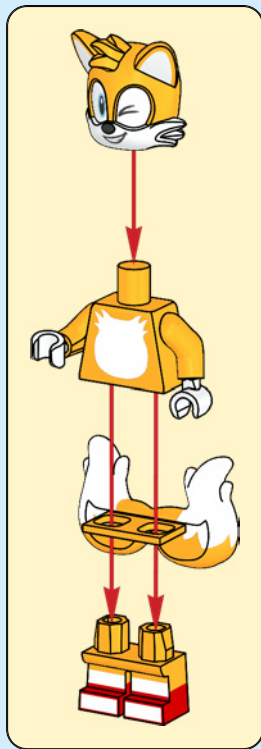

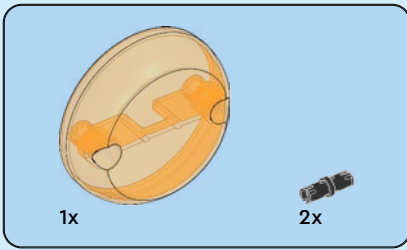

1

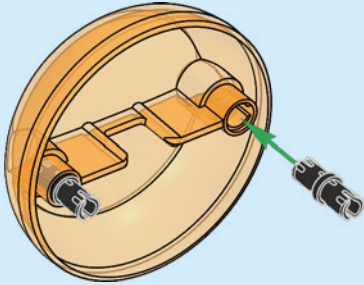

2

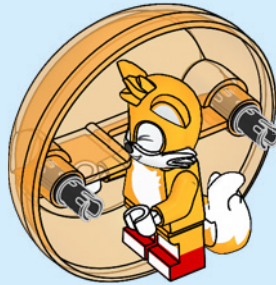

3

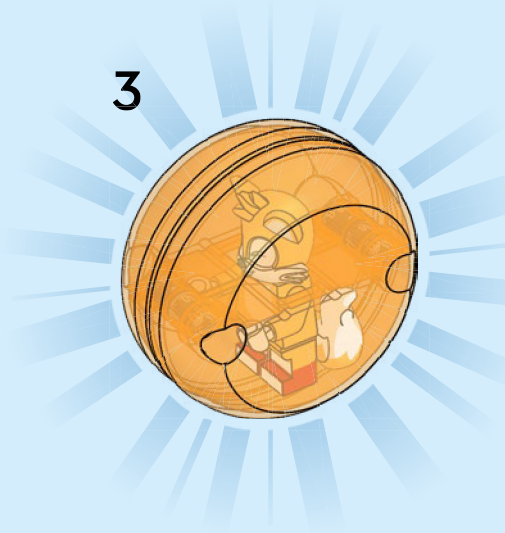

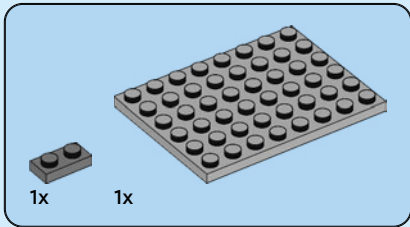
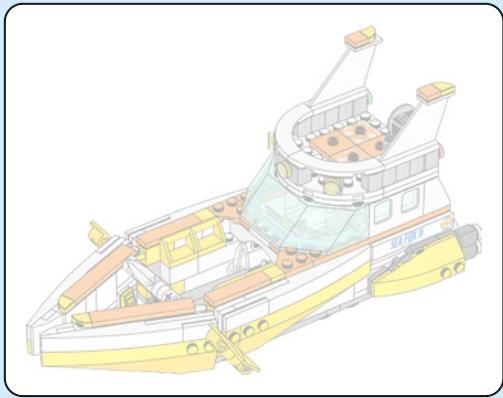

1

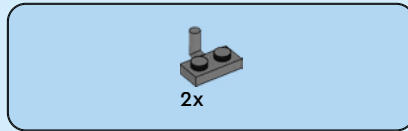
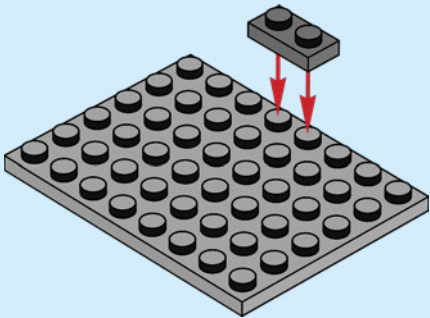

2

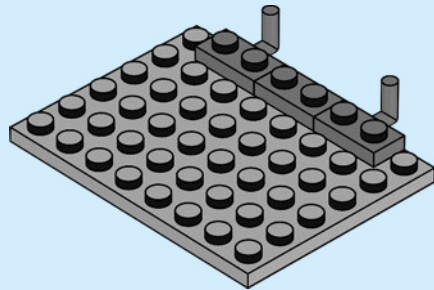

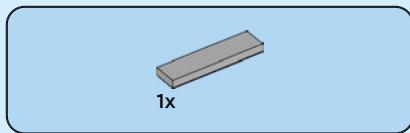

3

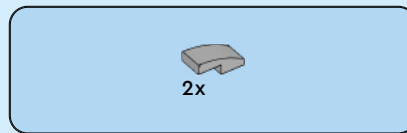
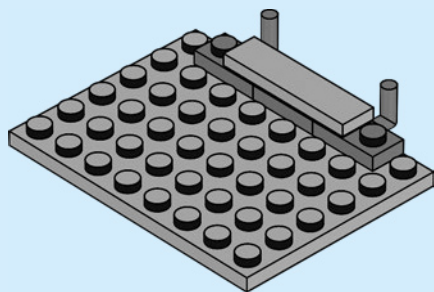

4

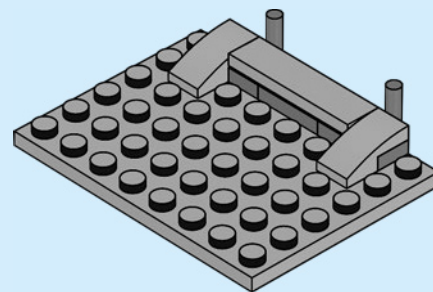

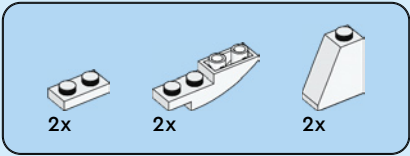

5

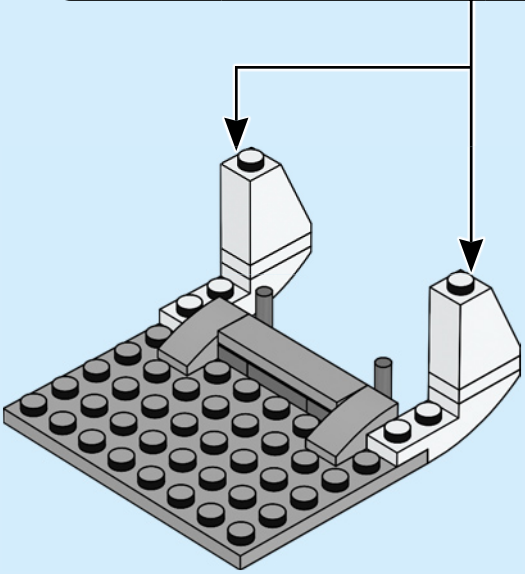
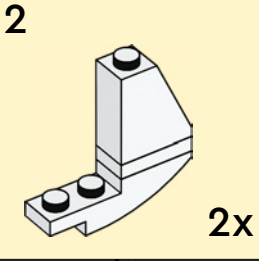
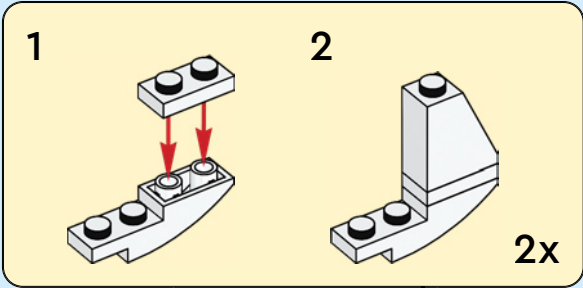



4x

6

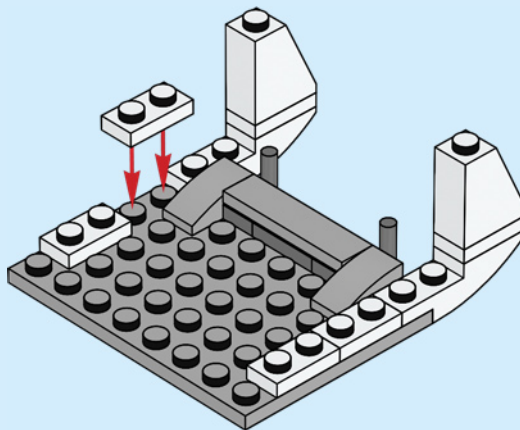

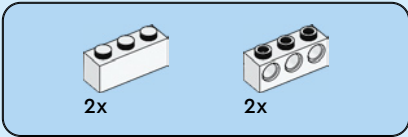

7

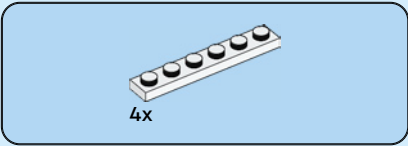
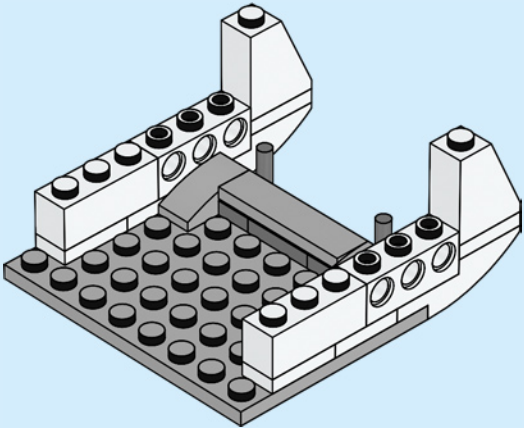

8

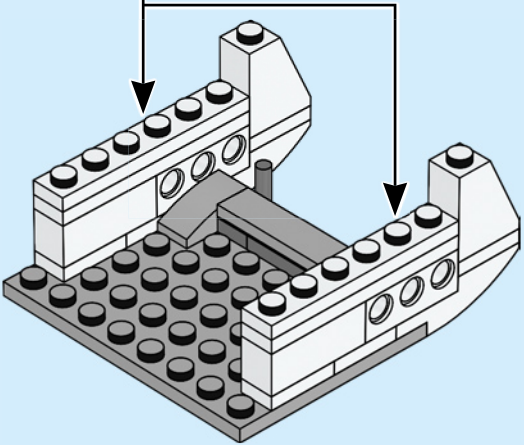
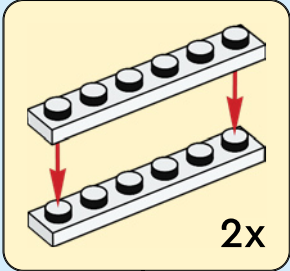



1x



1x

9

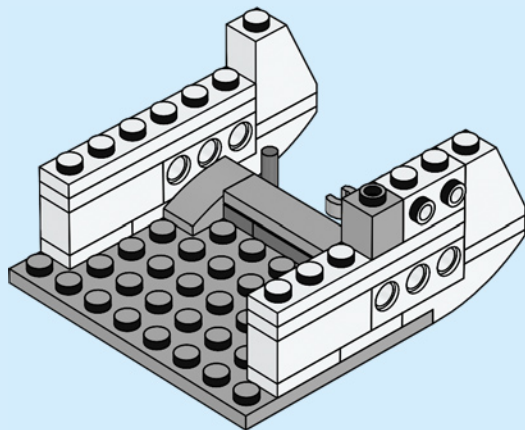

1x



1x

10

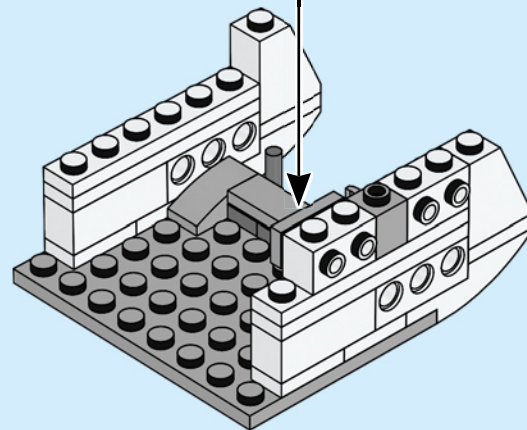
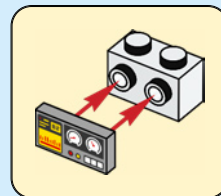

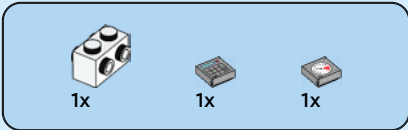

11

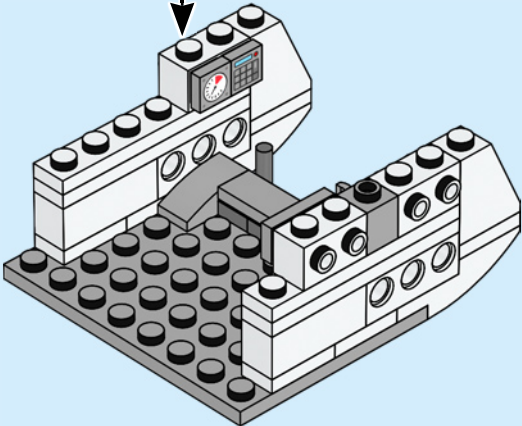
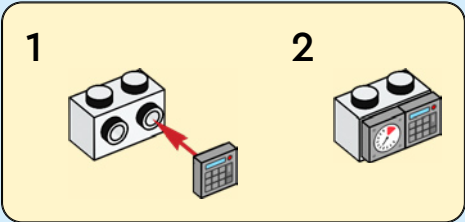

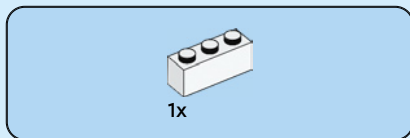

12

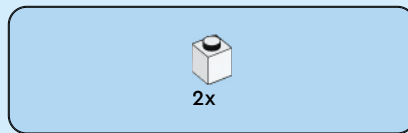
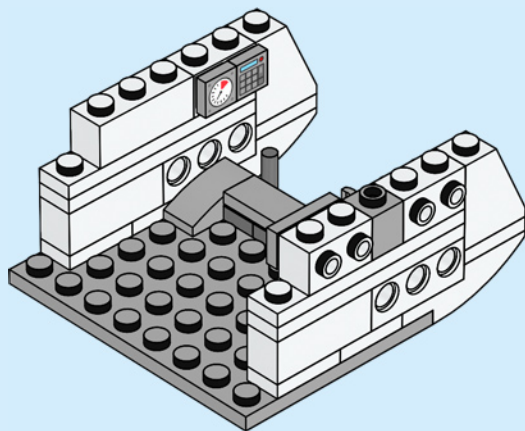

13

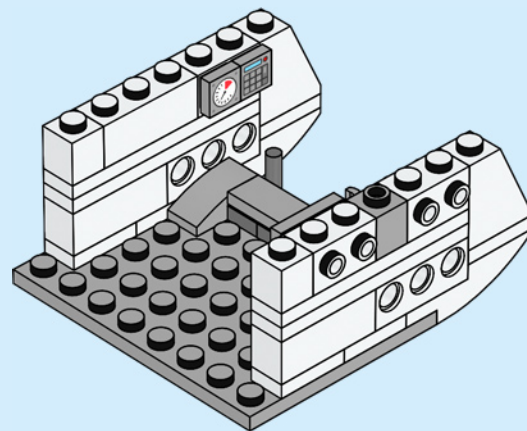

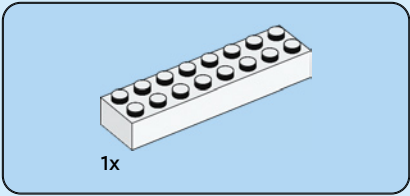

14

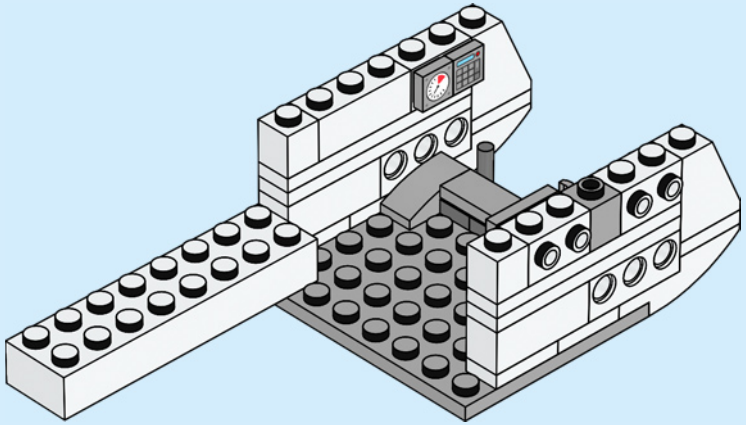

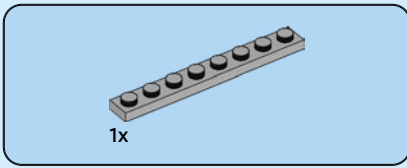

15

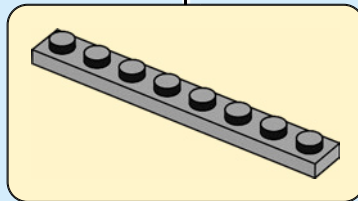
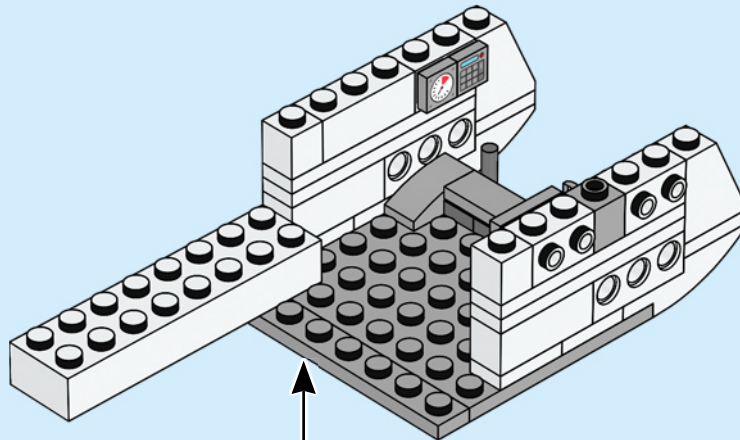

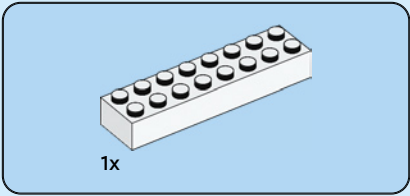

16

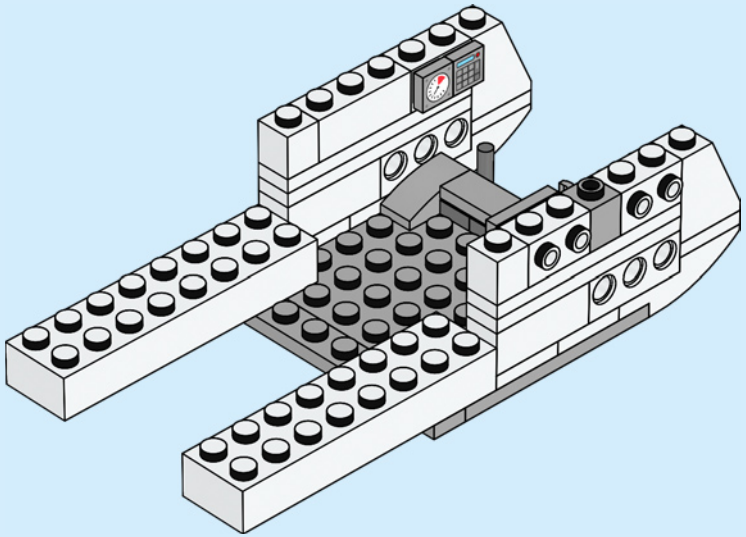

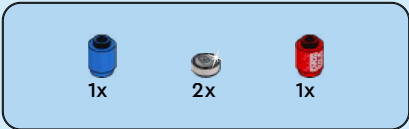

17

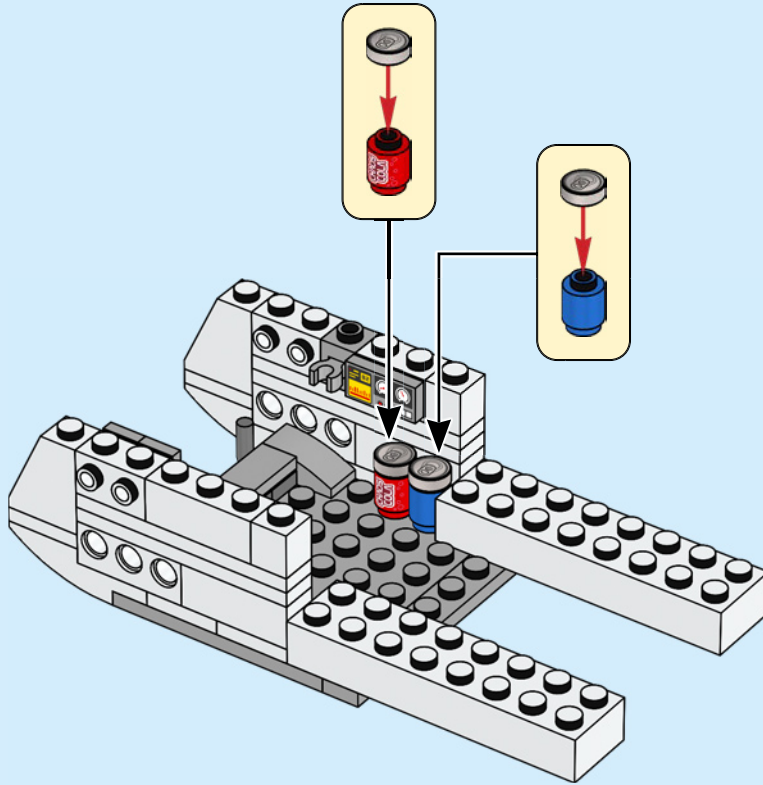

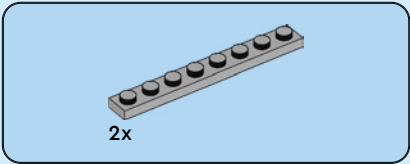

18

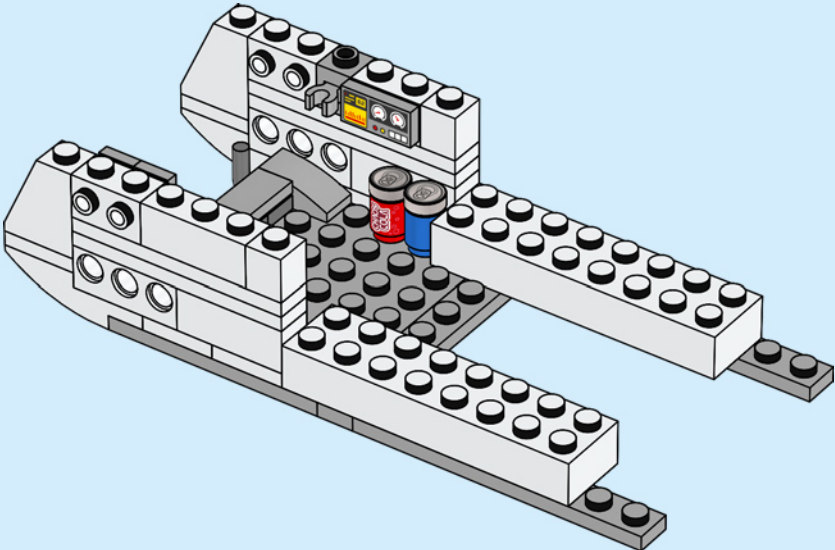

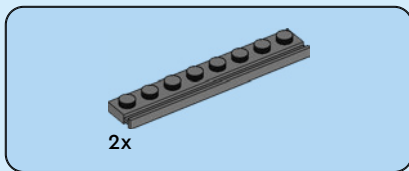

19

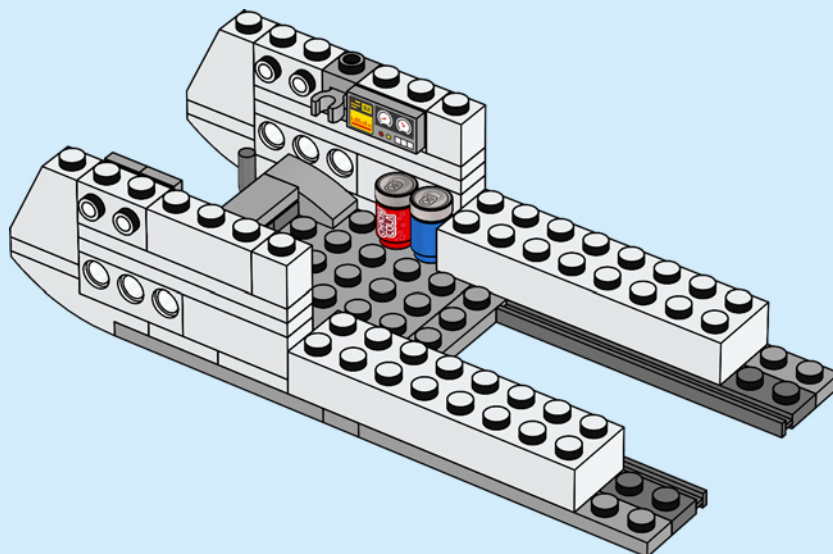

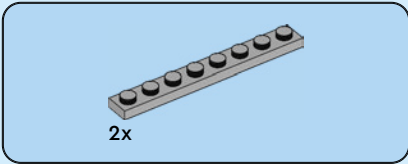

20

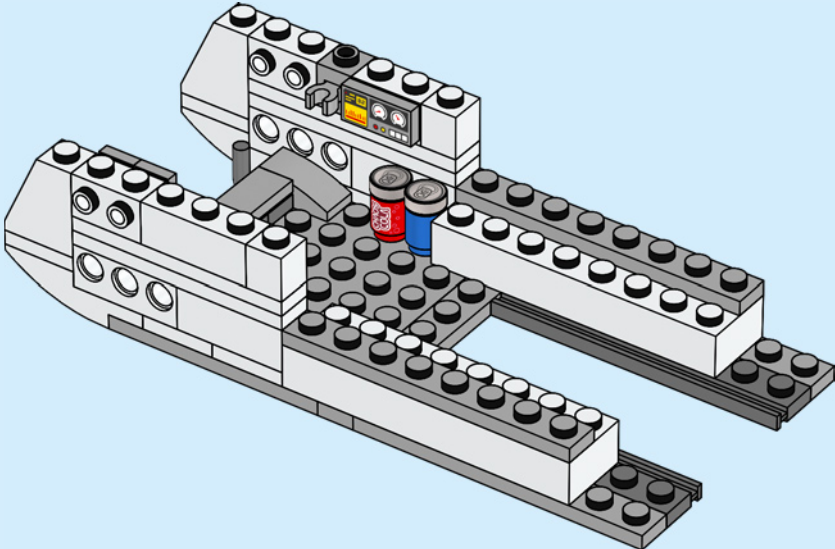

21

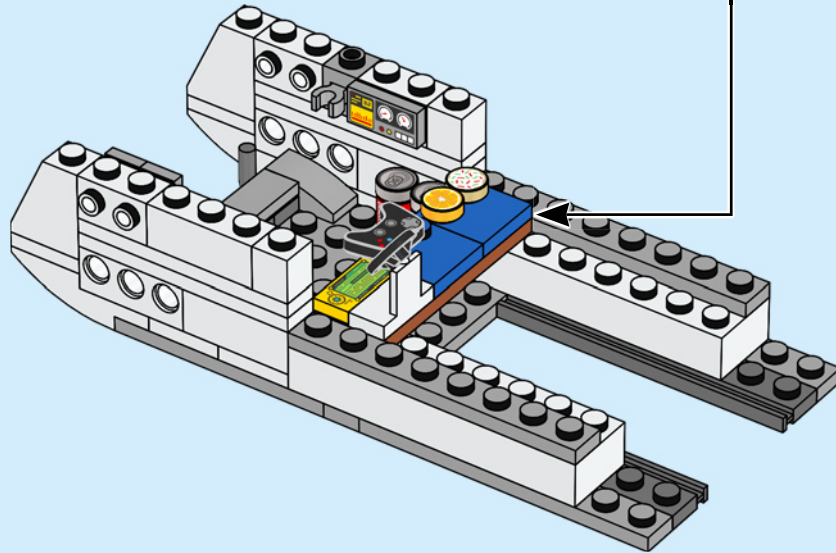
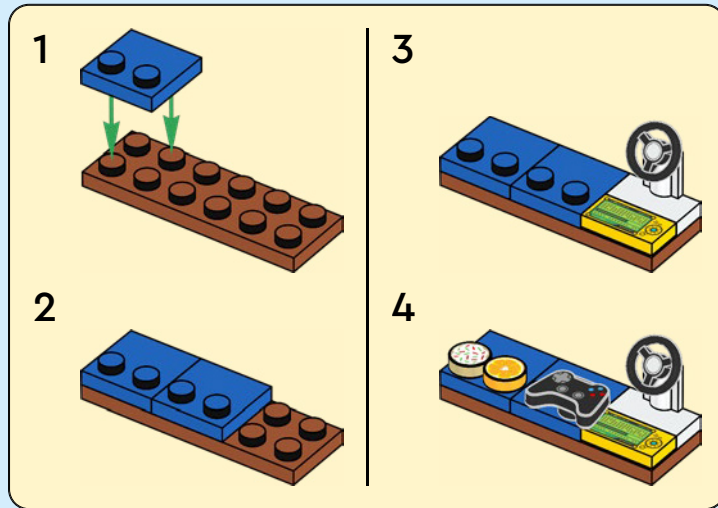
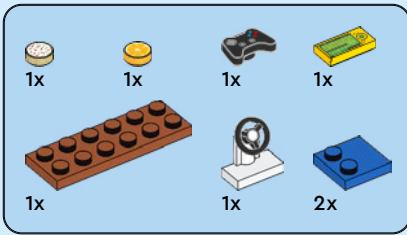



4x

22

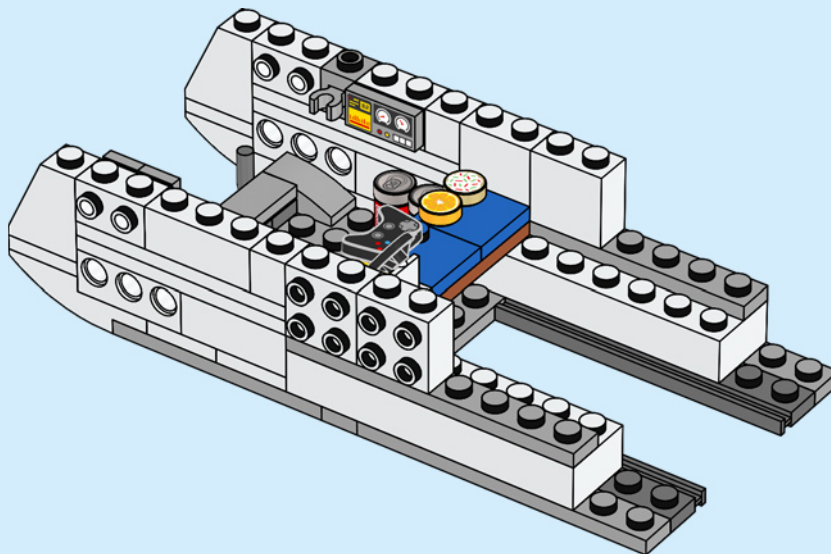

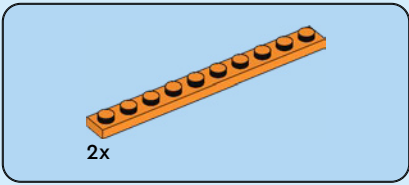

23

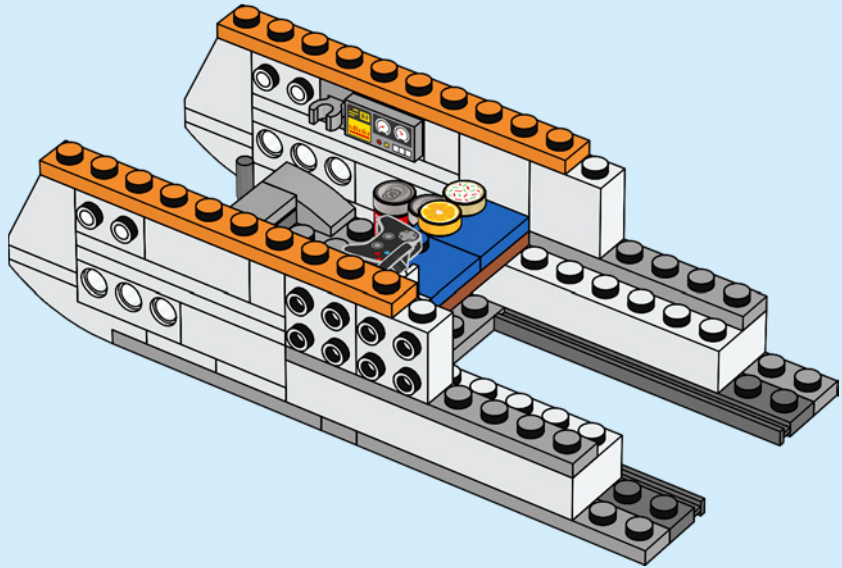

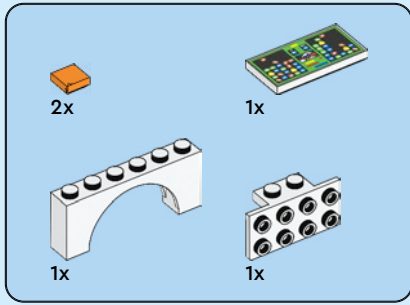

24

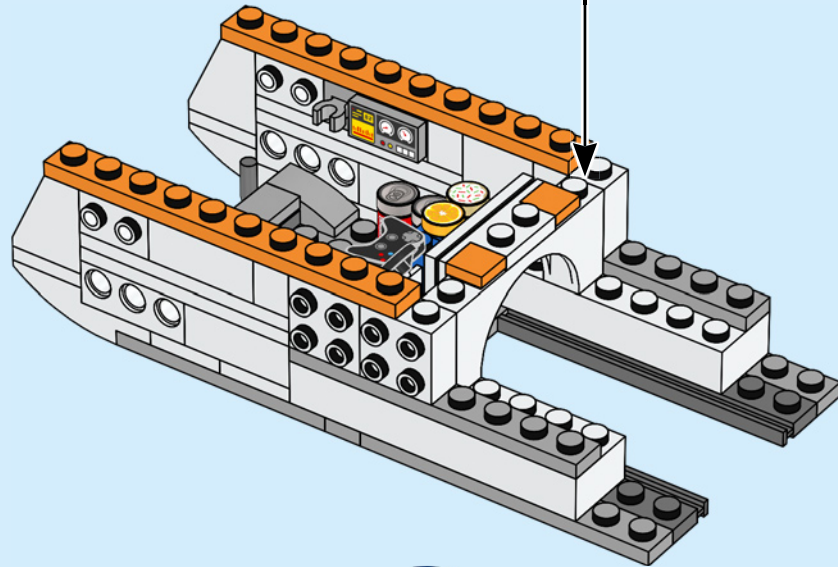
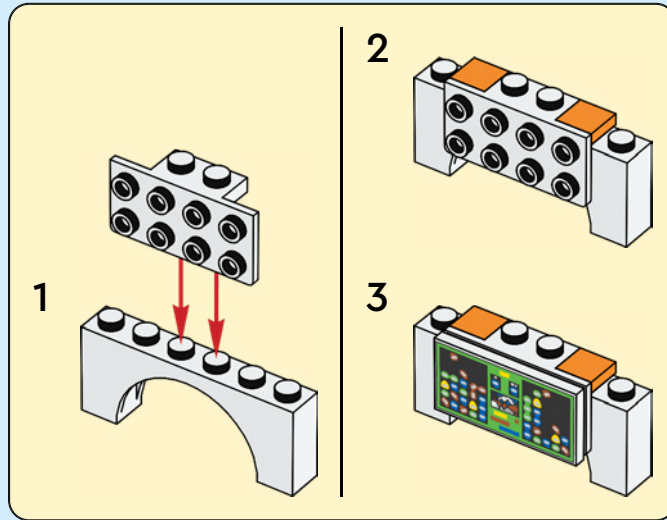



2x



2x

25

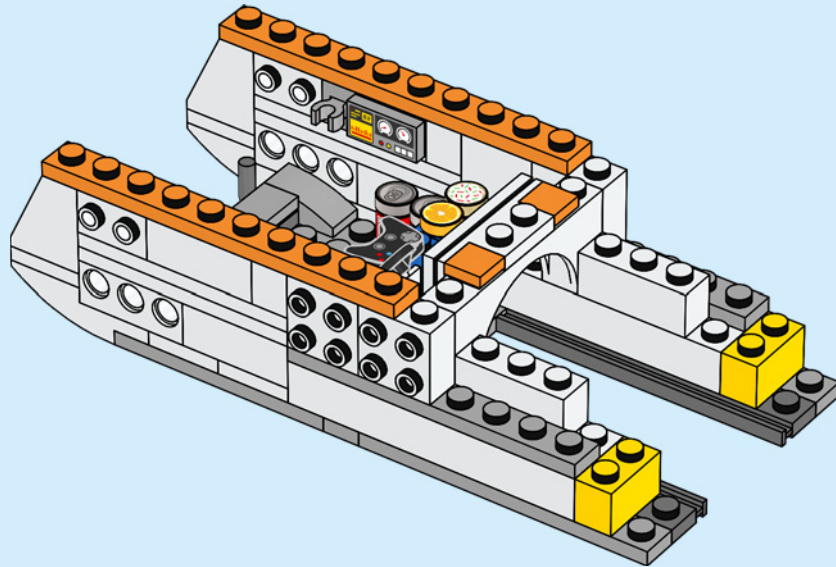



4x

26

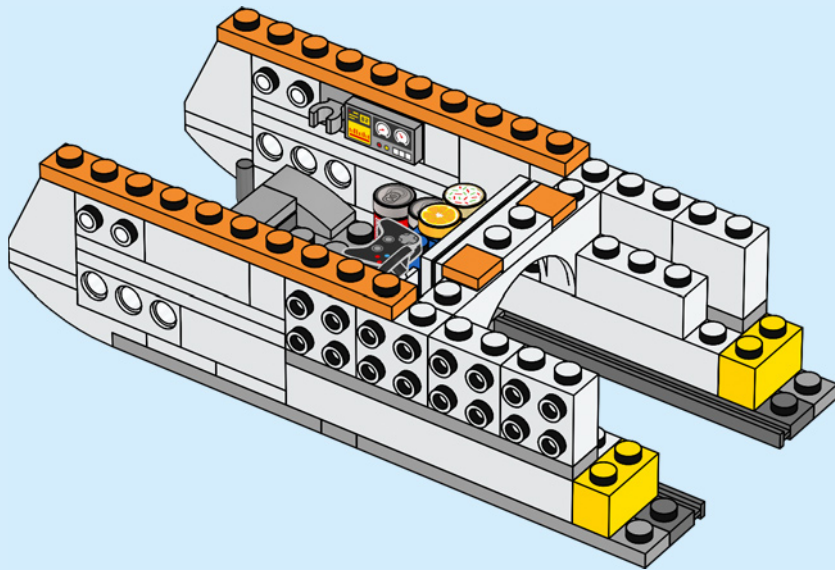

2x



2x

27

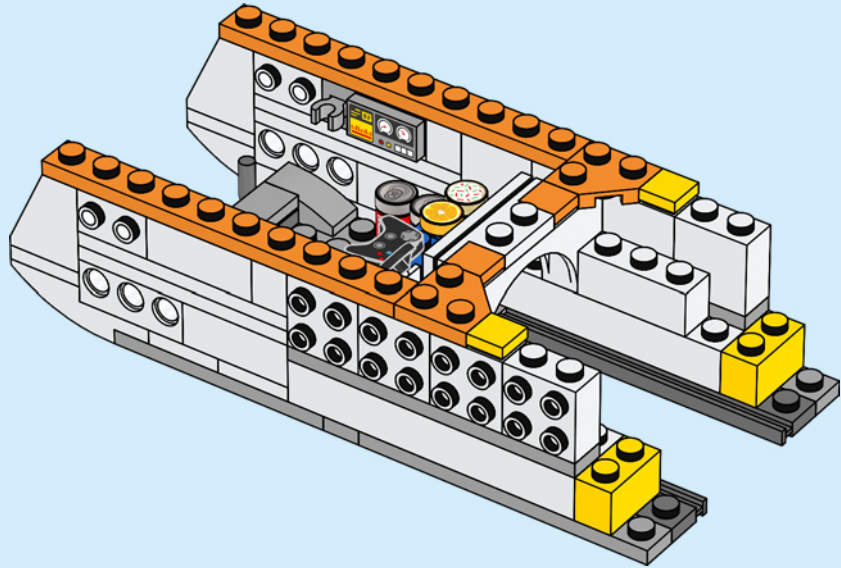



2x

28

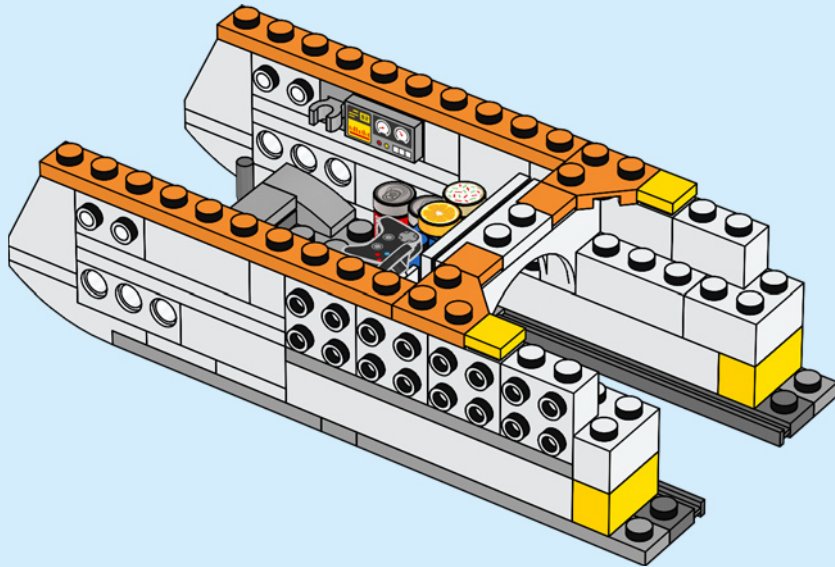



4x

29

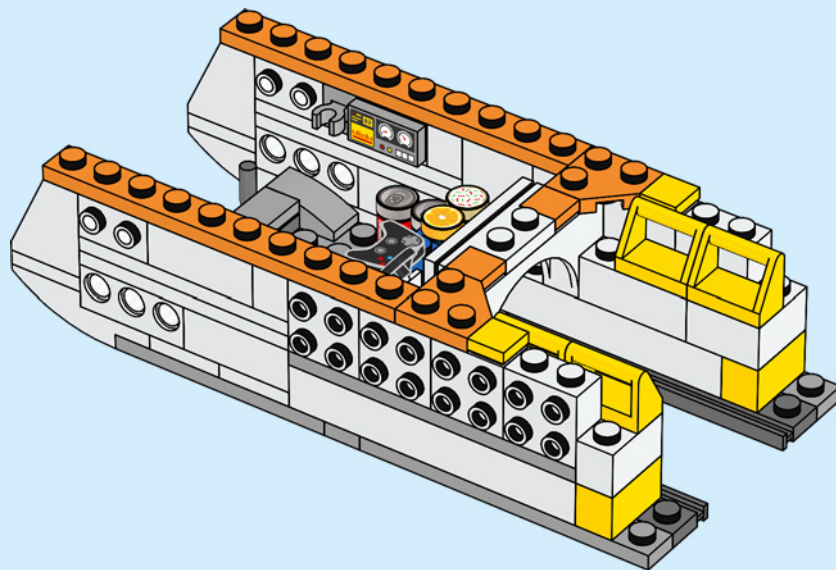



9x

30

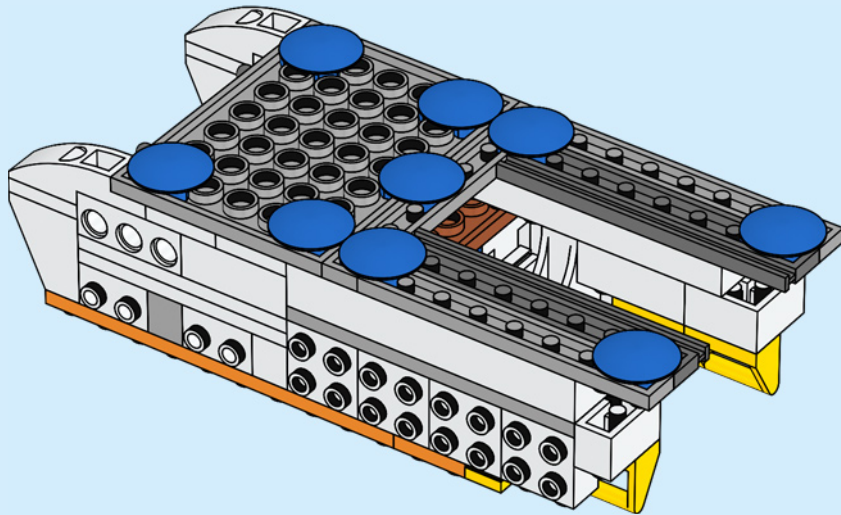

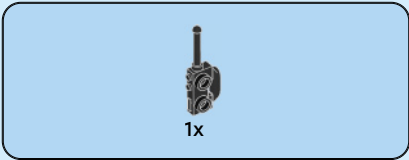

31

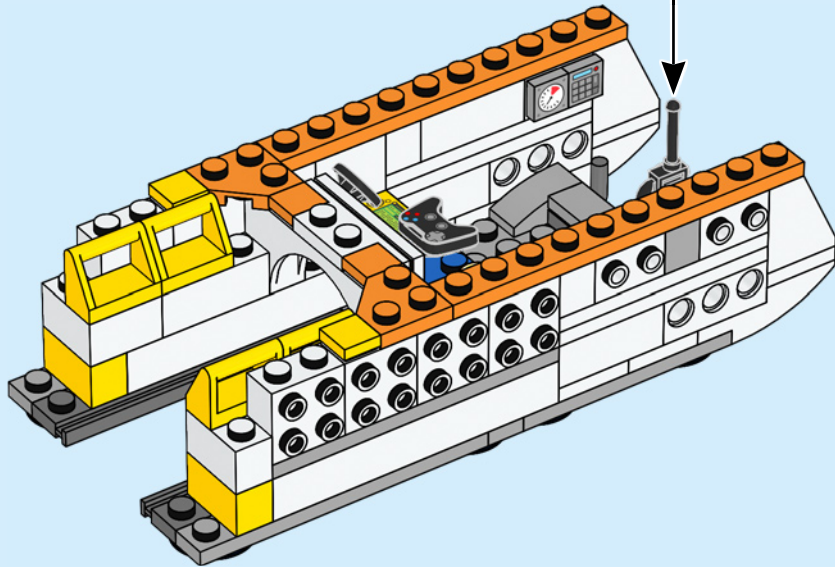



2x

32

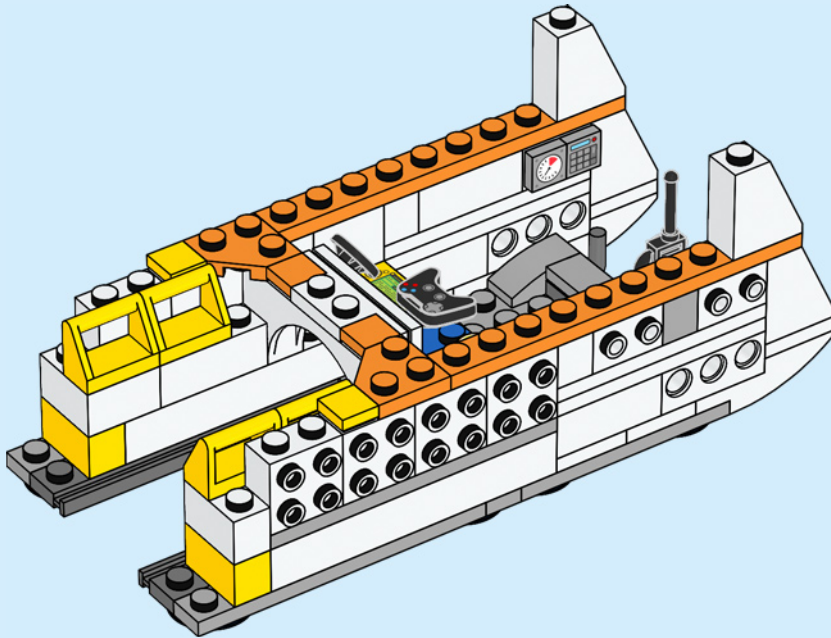

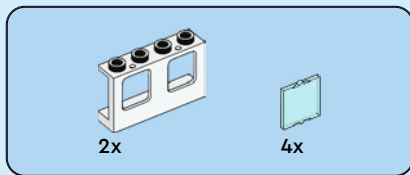

33

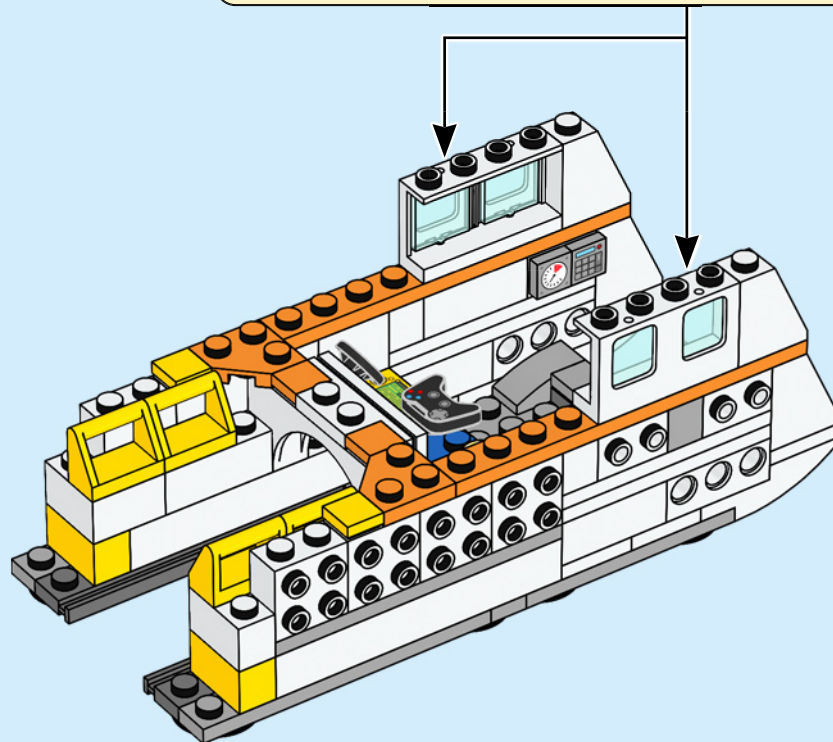
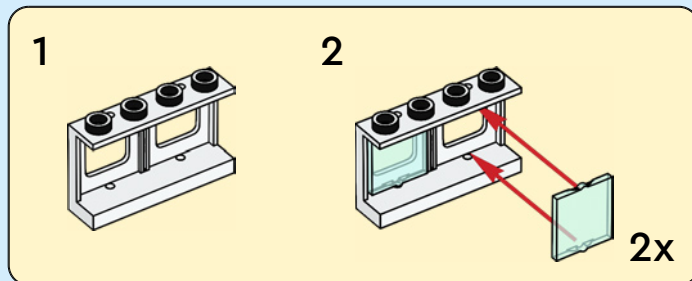

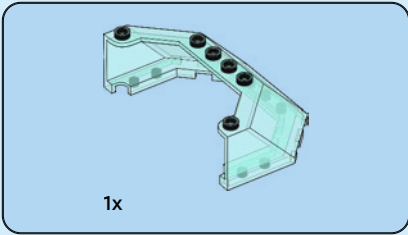

34

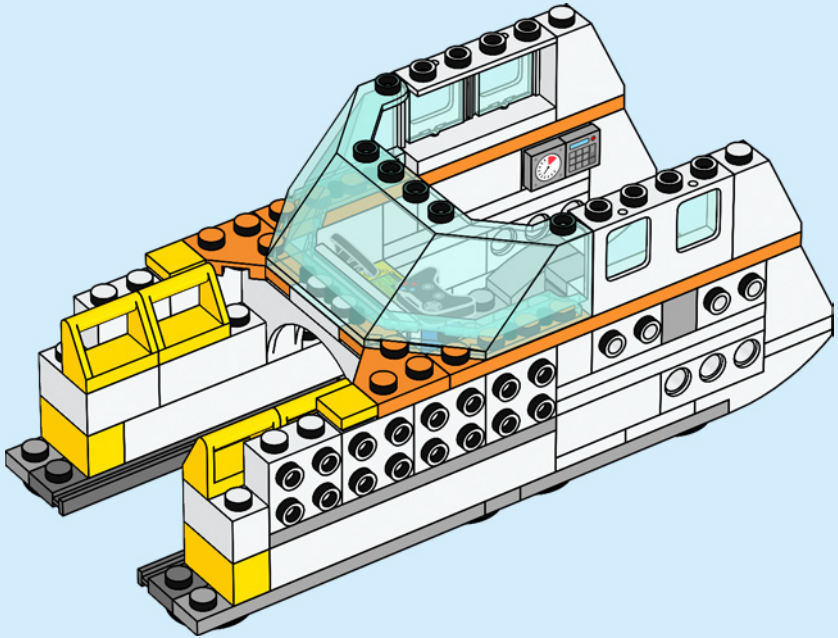

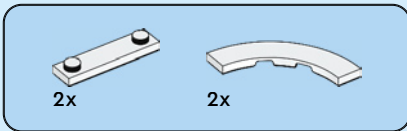

35

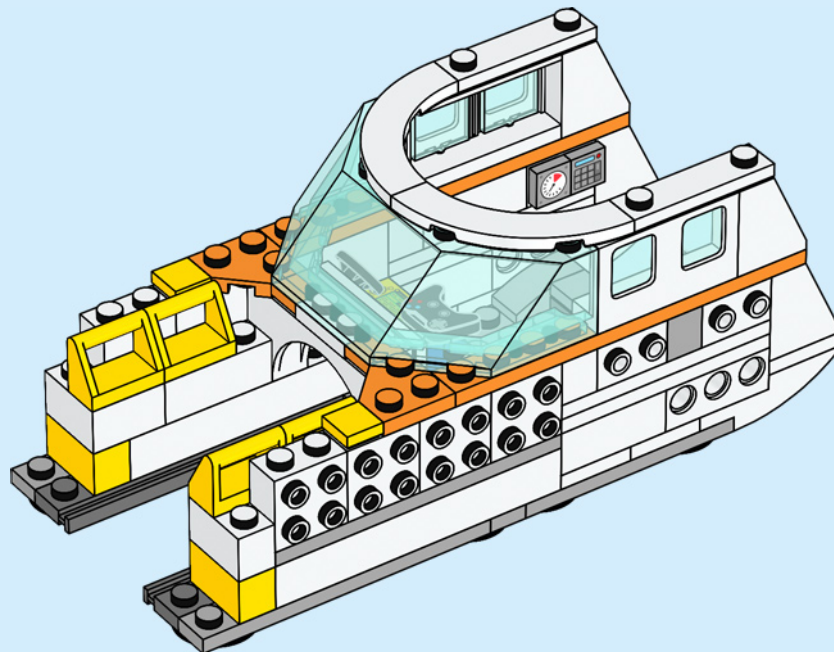

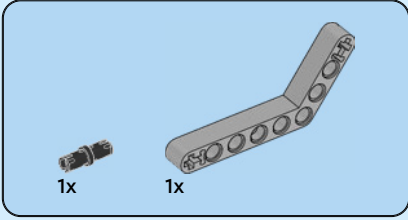
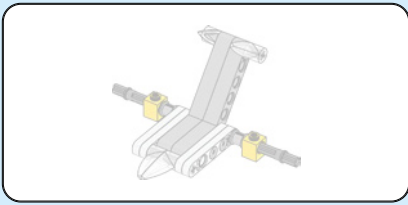

36

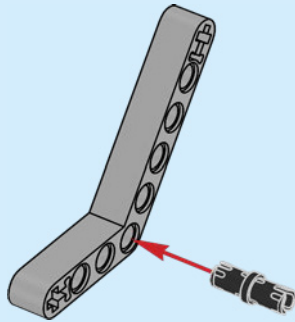

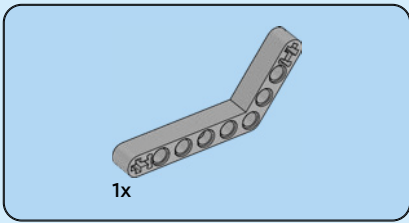

37

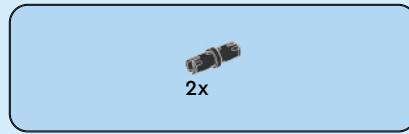
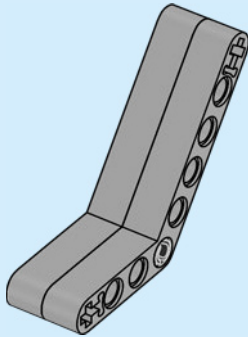

38

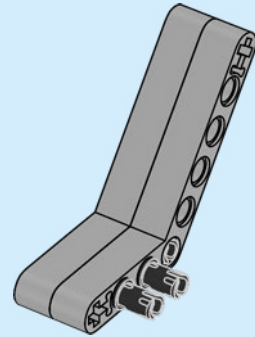

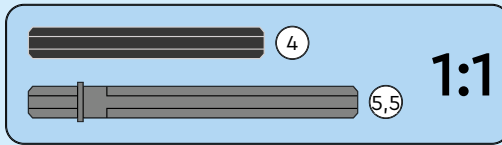
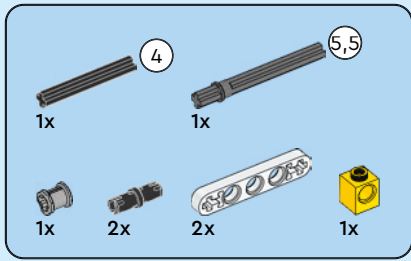

39

1

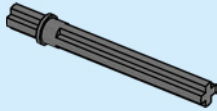

2

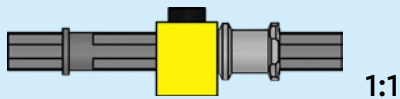

3

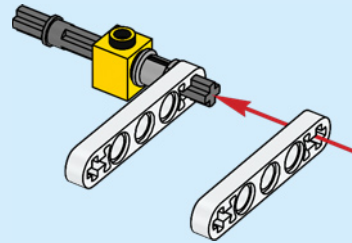

4

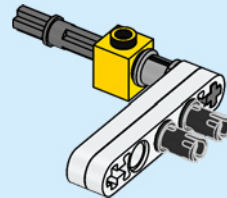

5

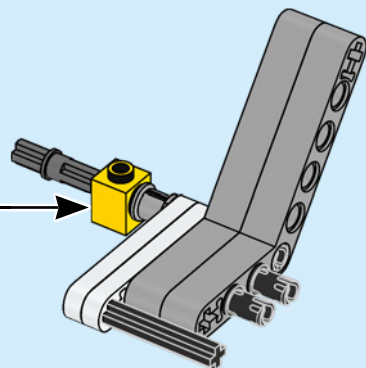
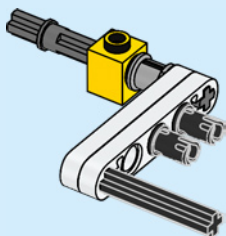



2x

40

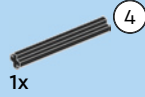
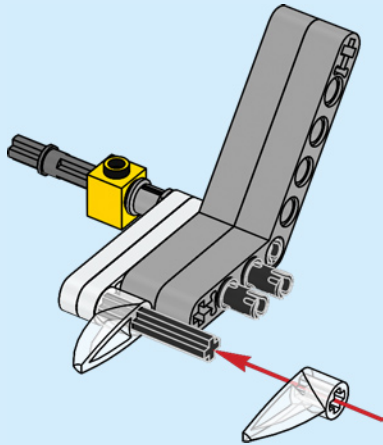

41

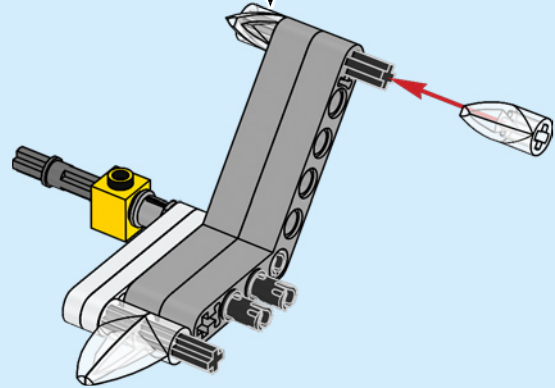
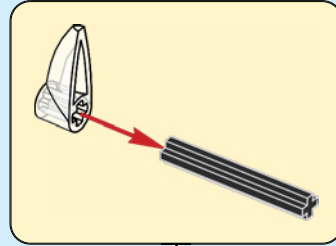

4

1:1



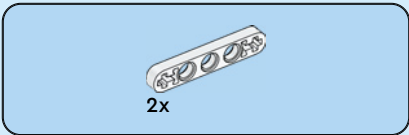

42

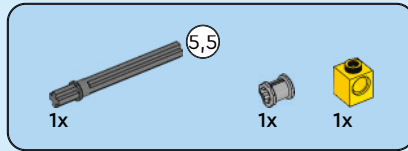
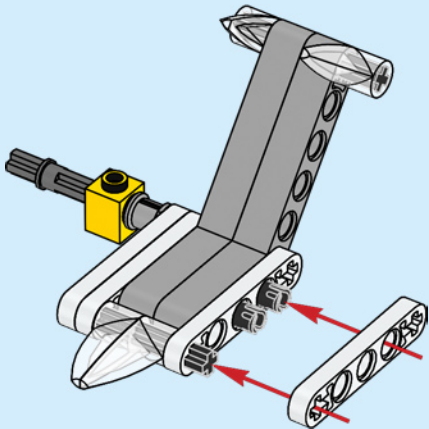

43

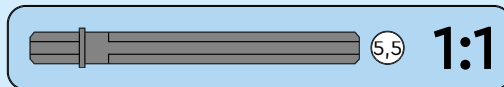
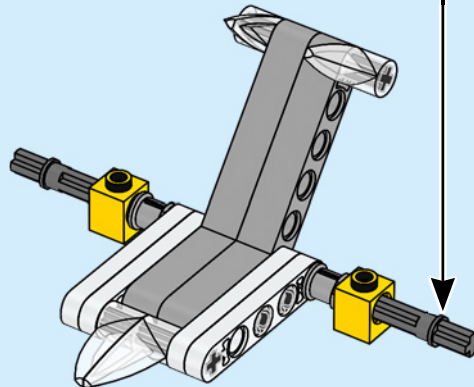
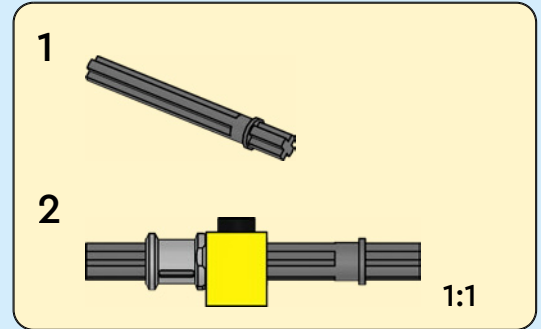

44

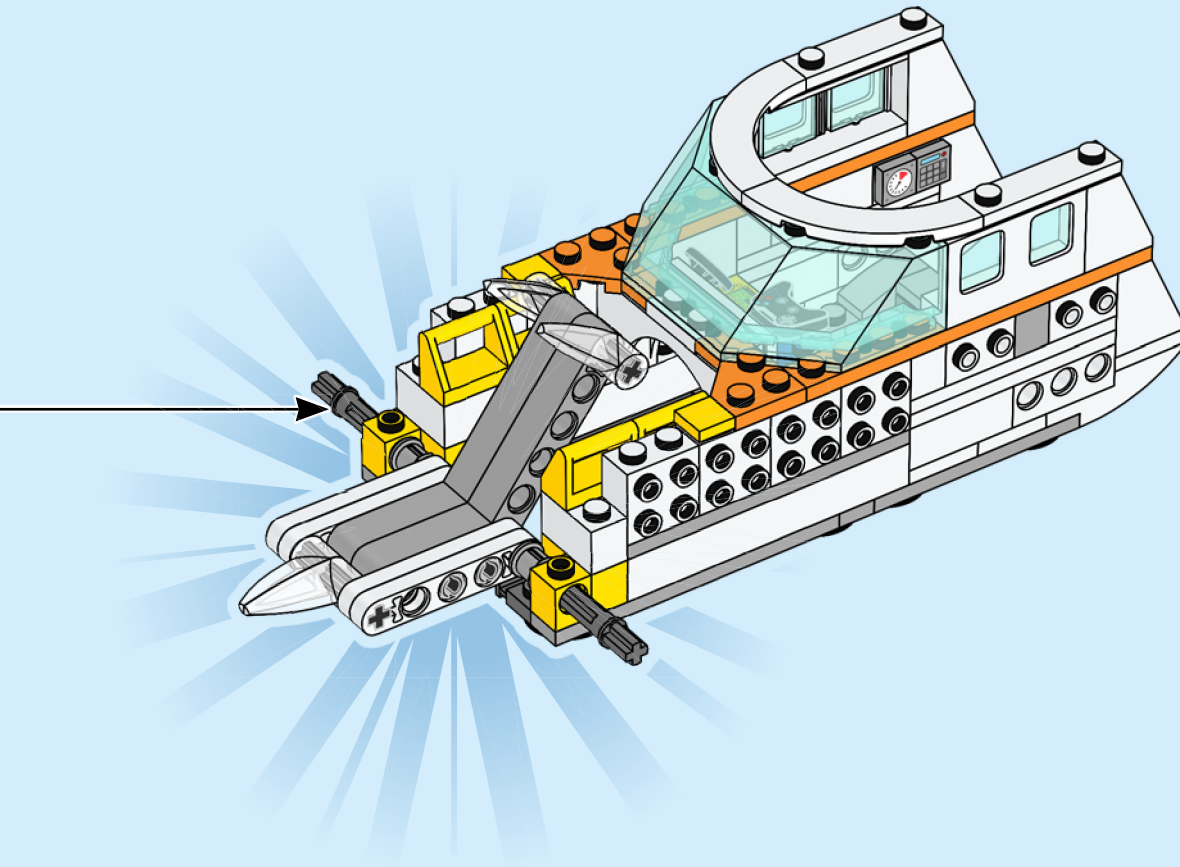



2x

45

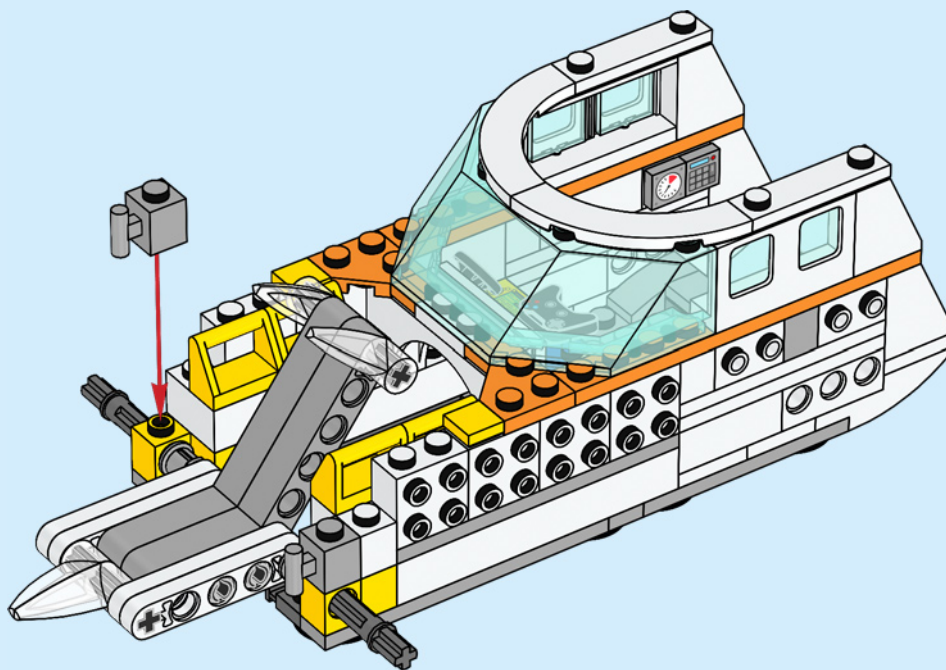



2x

46

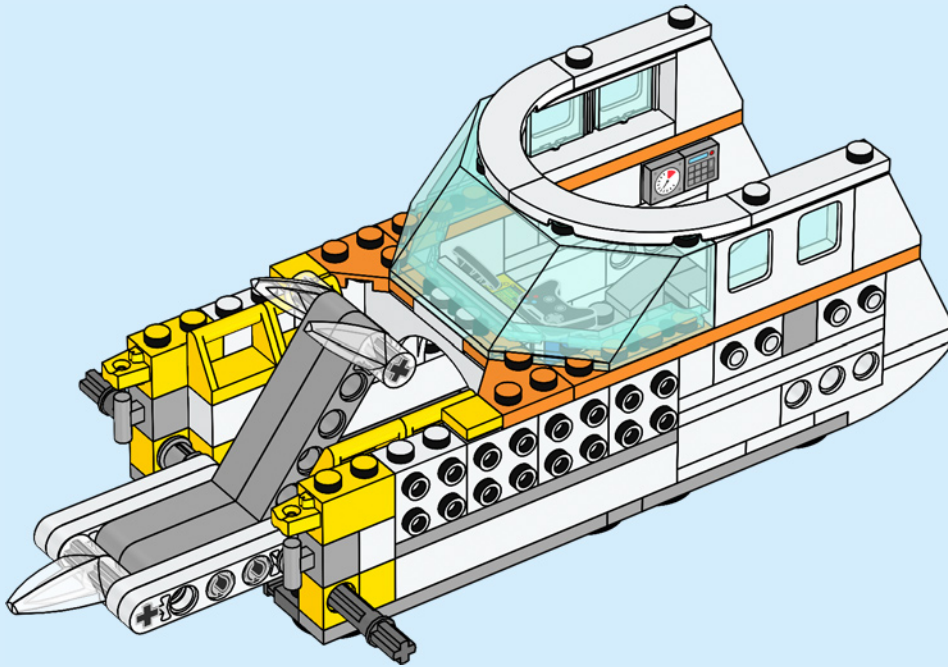

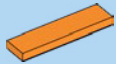

2x

47

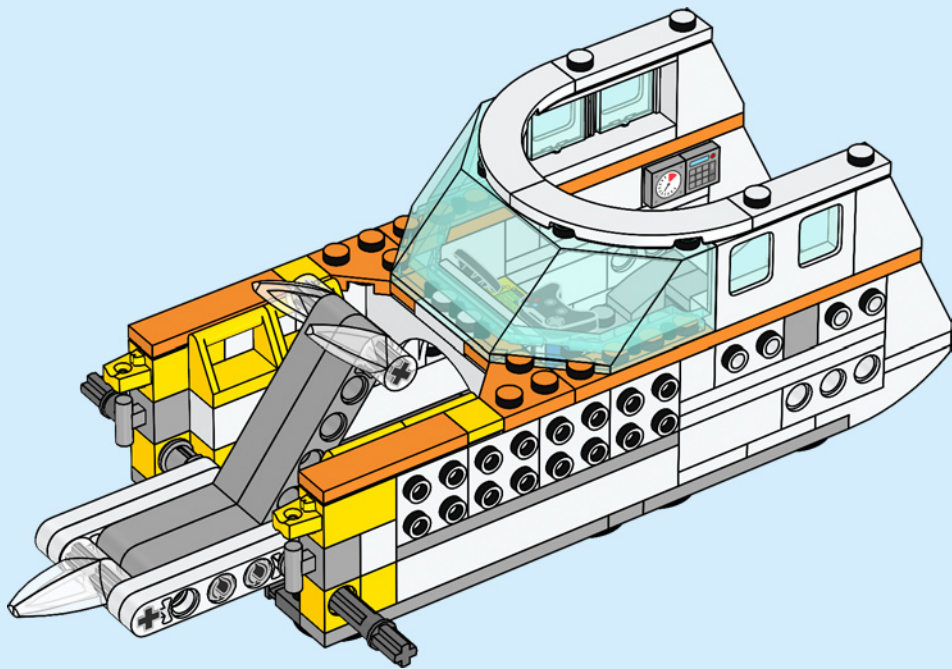

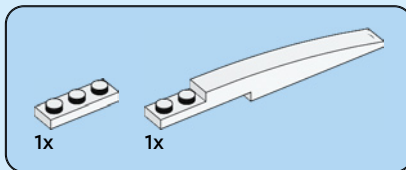
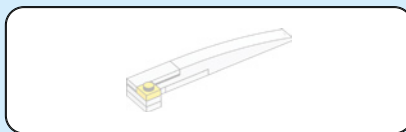

48

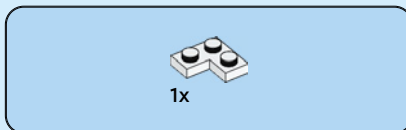
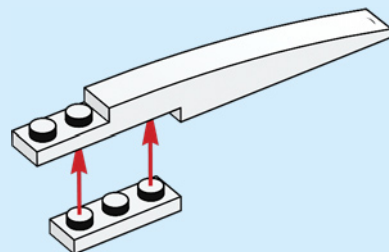

49

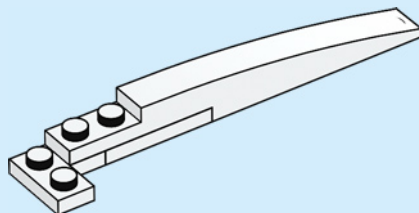



1x

50

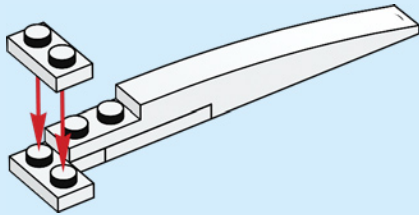

1x

51

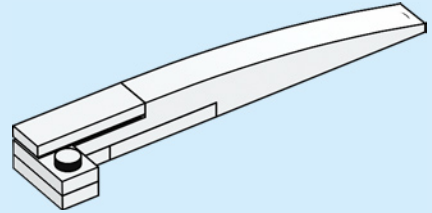

1x

52

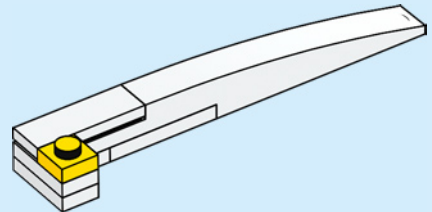

53

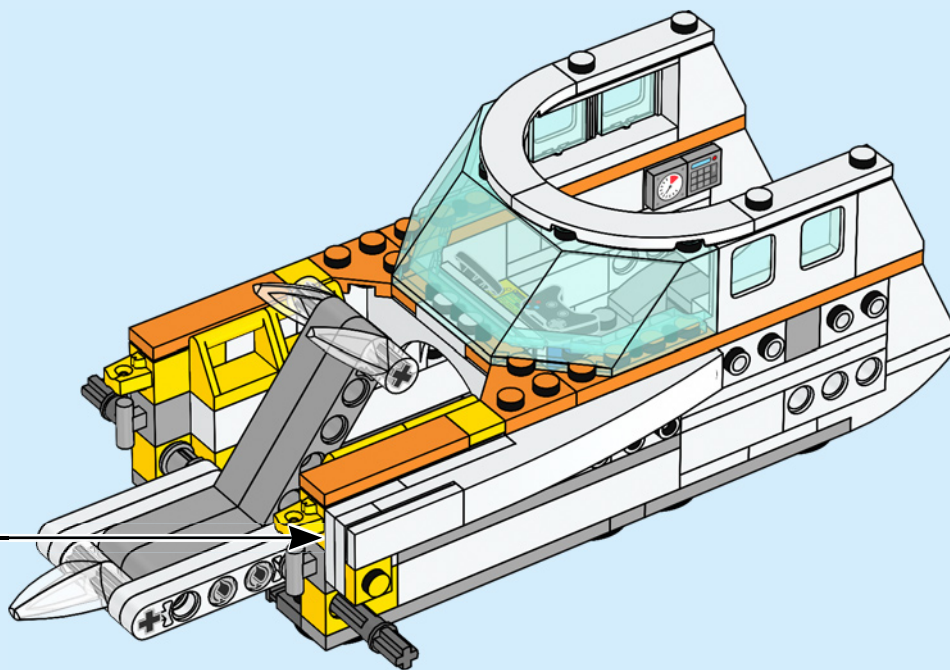

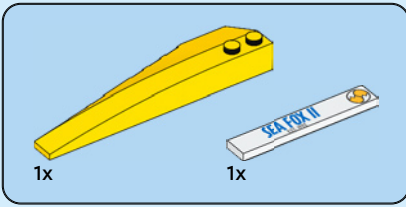

54

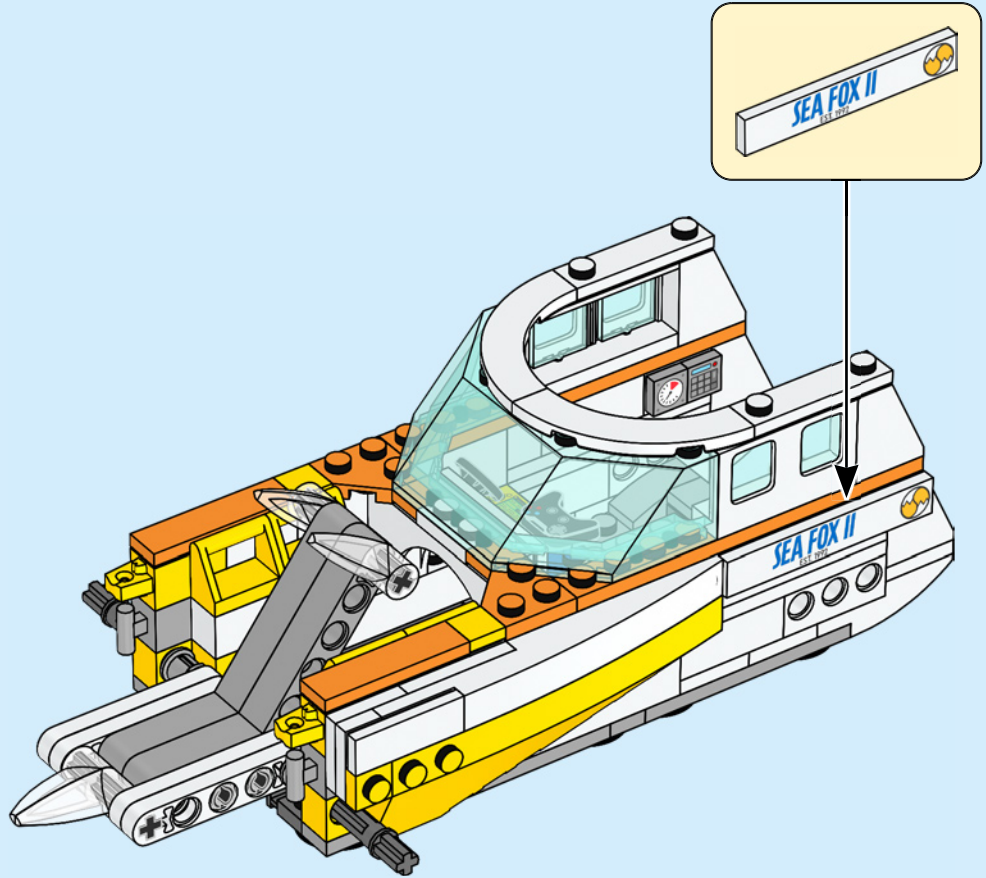

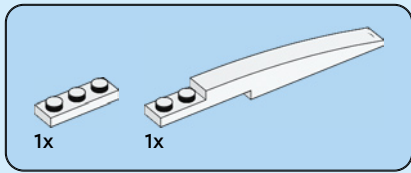

55

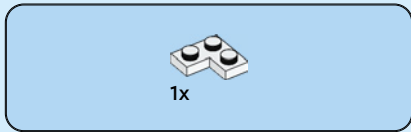
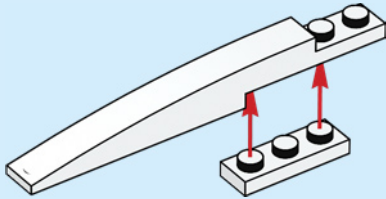

56

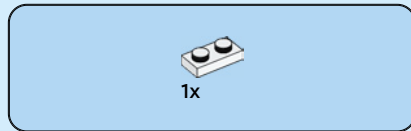
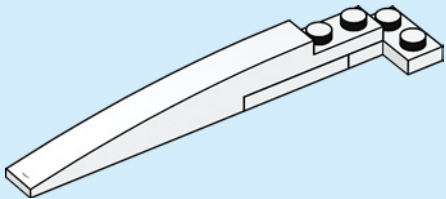

57

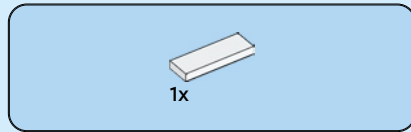
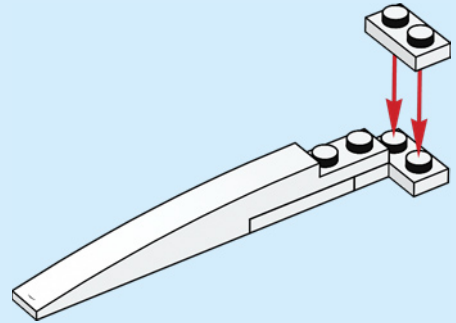

58

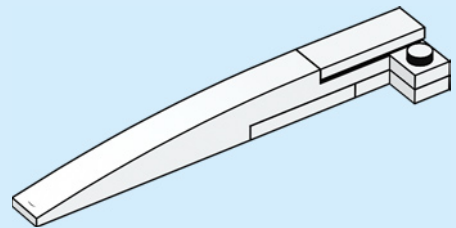



1x

59

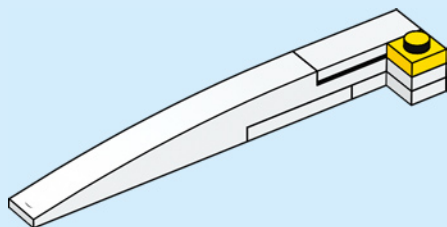

60

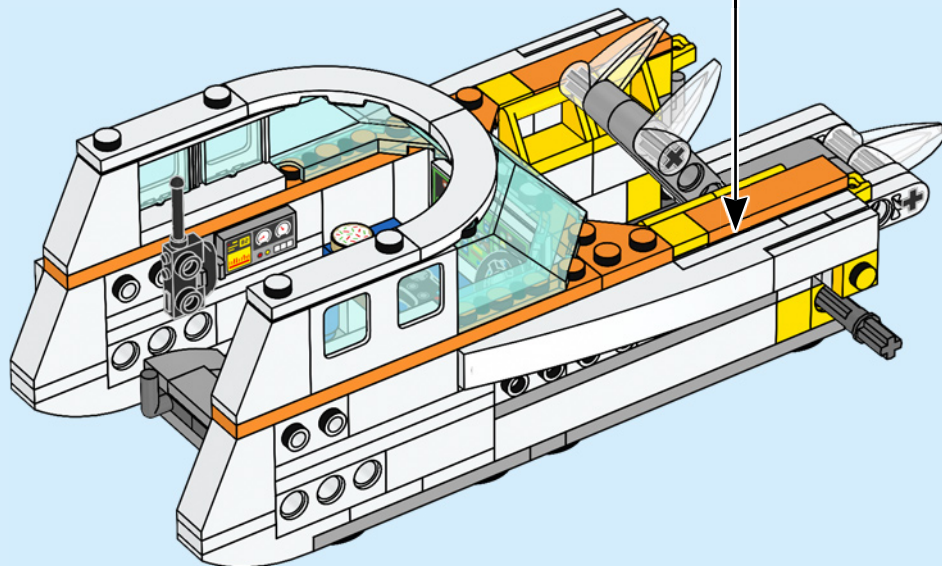

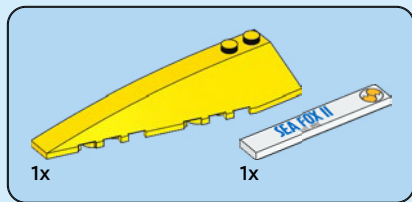

61

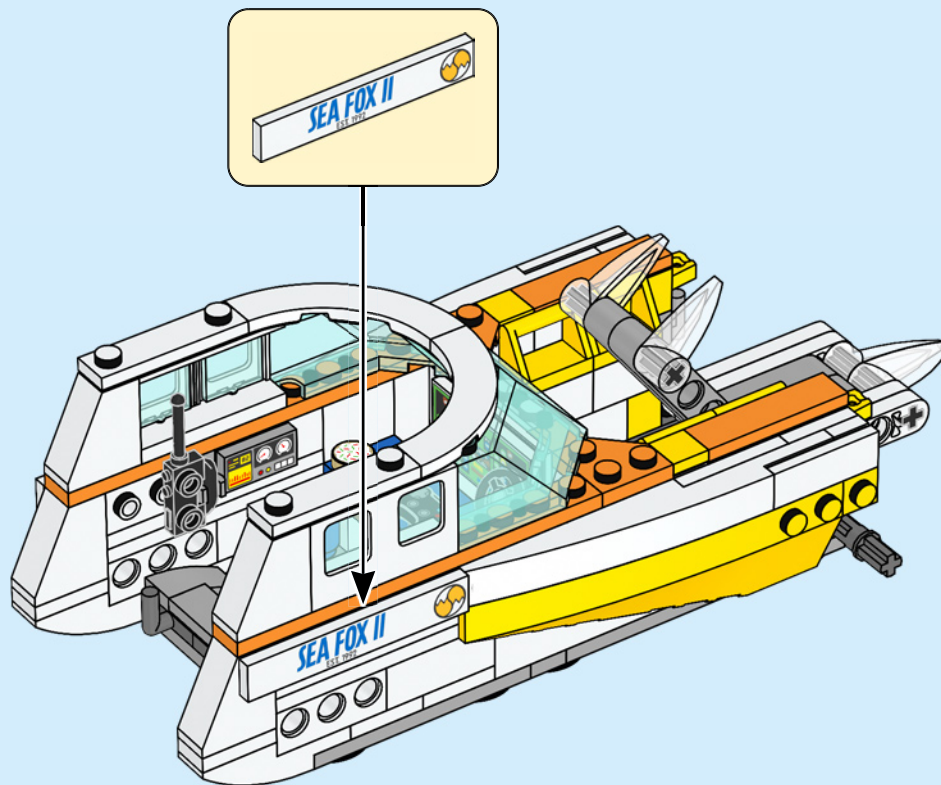

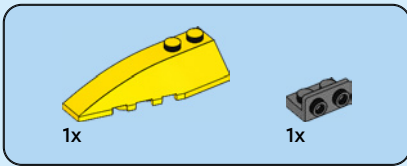

62

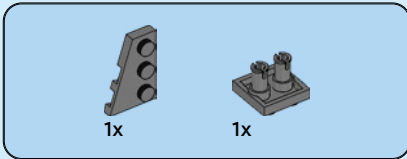
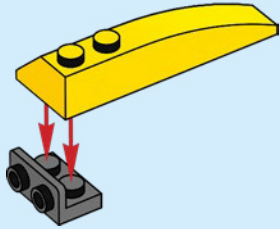

63

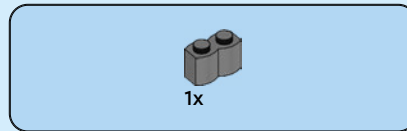
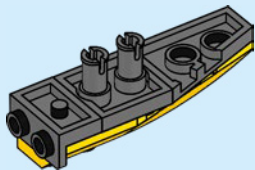

64

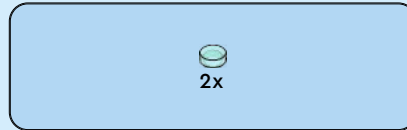
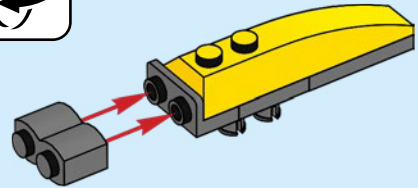
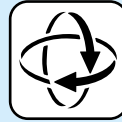

65

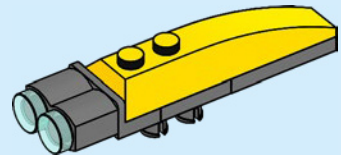

66

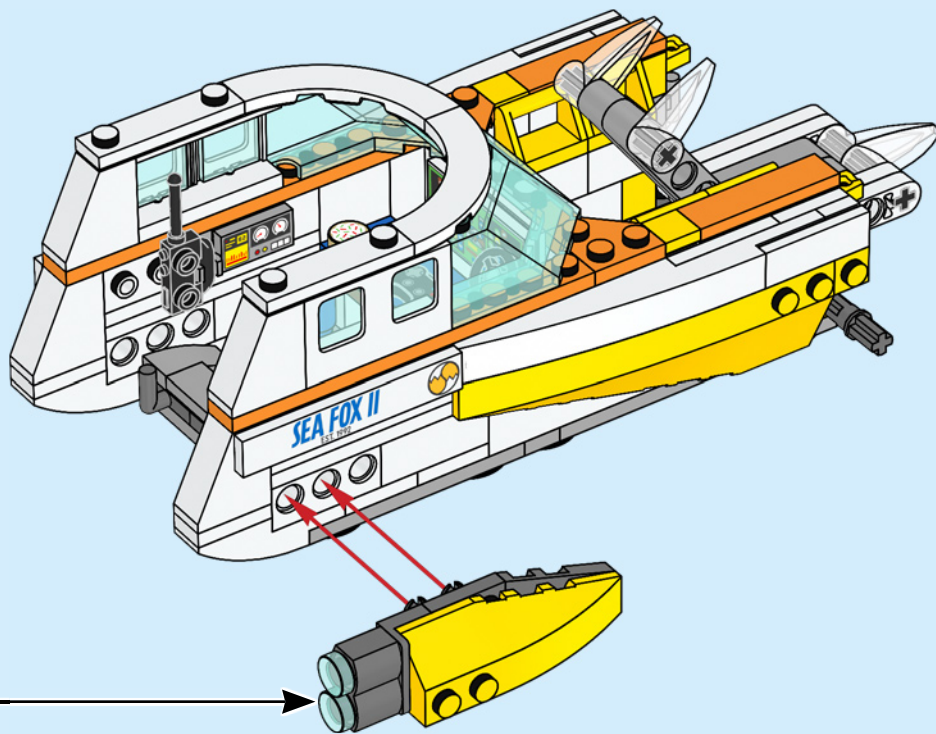

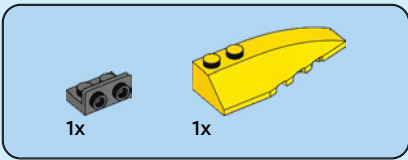

67

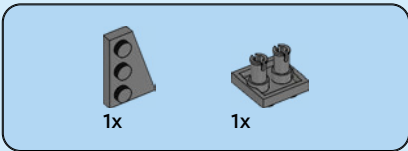
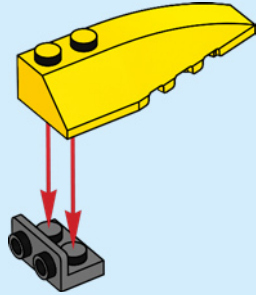

68

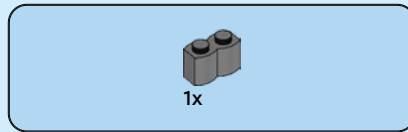
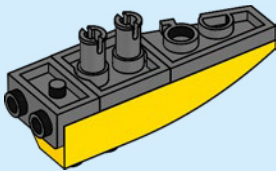

69

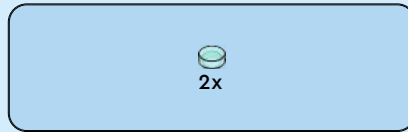
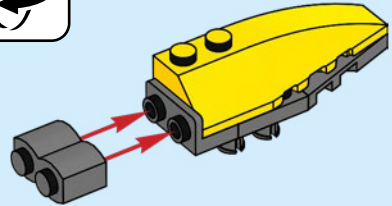
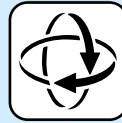

70

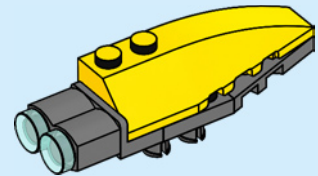

71

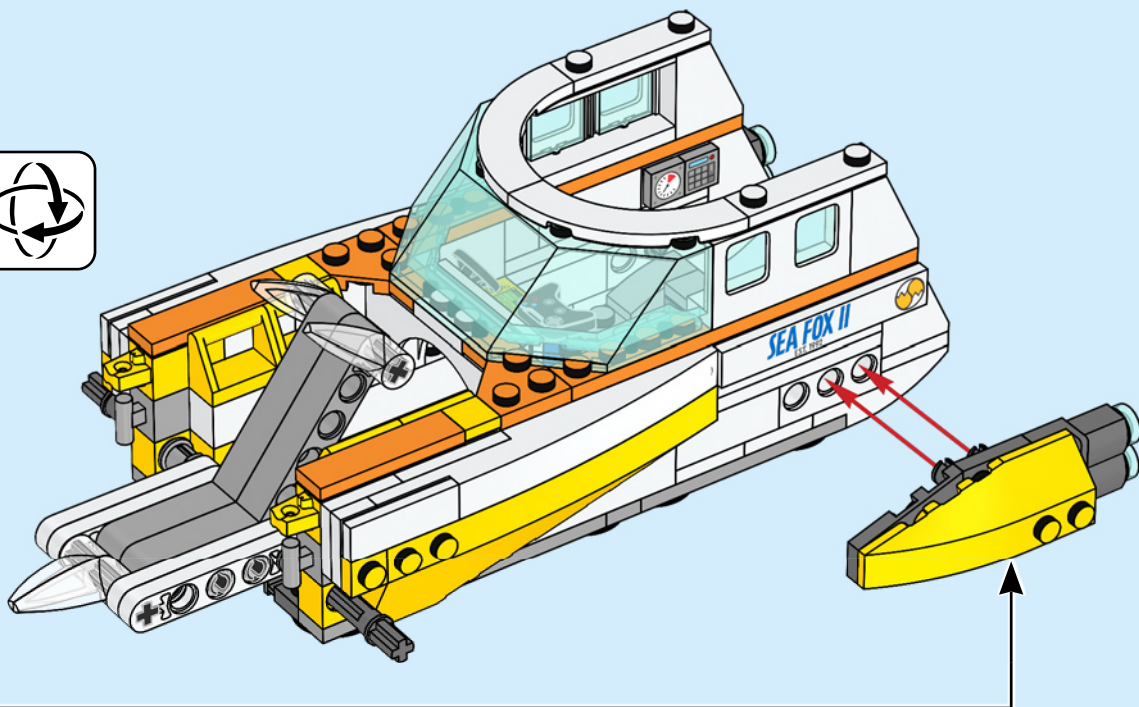

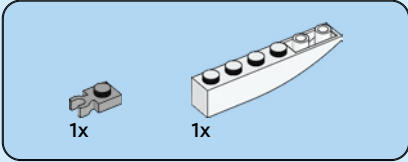
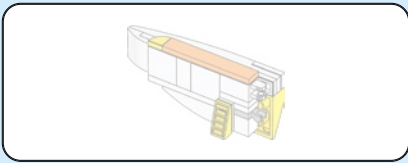

72

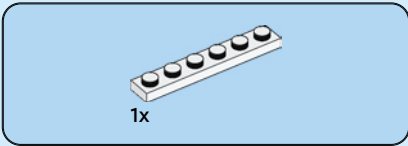
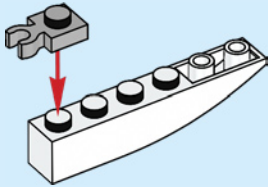

73

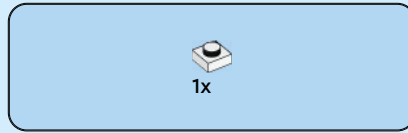
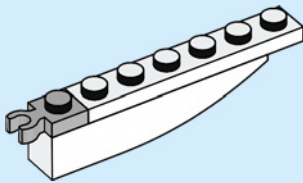

74

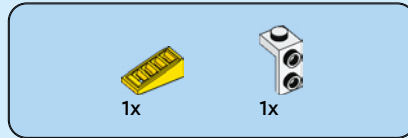
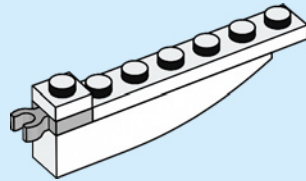

75

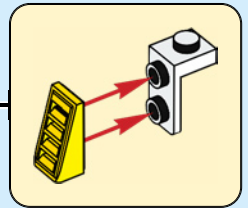
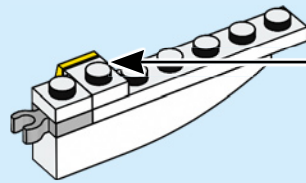



1x

76

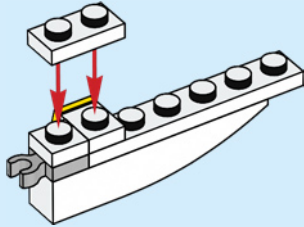

1x

77

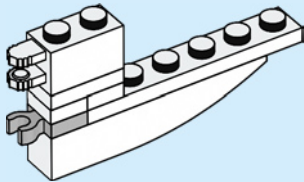

2x



1x

78

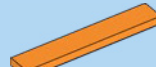
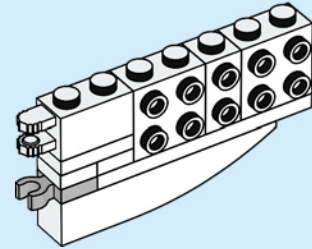

1x



1x

79

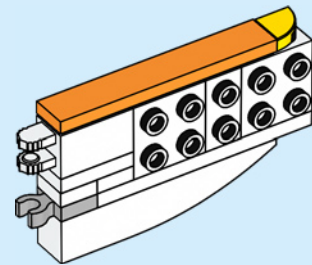

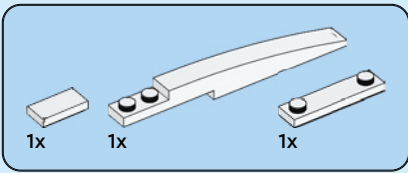

80

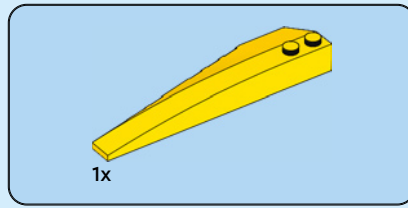
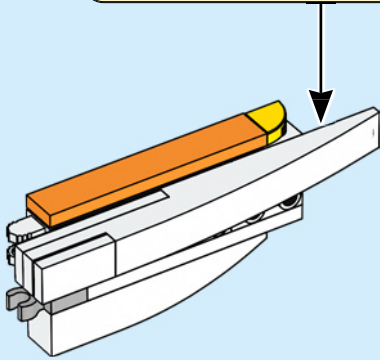
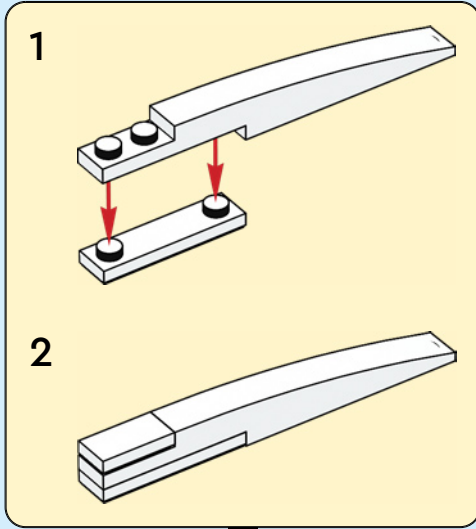

81

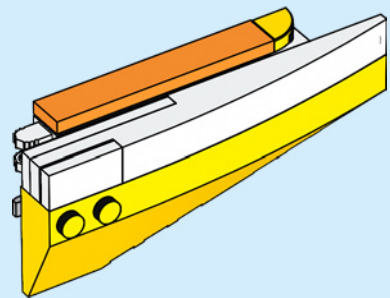

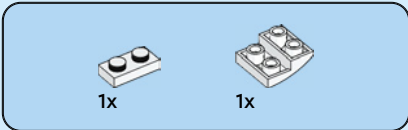

82

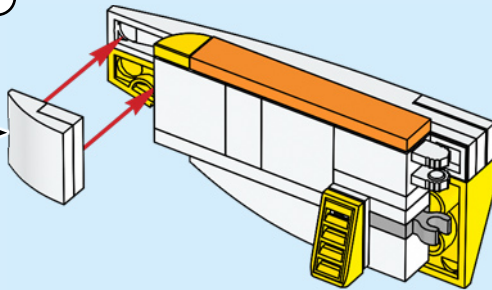
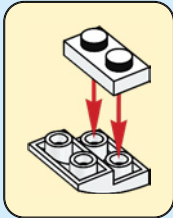

83

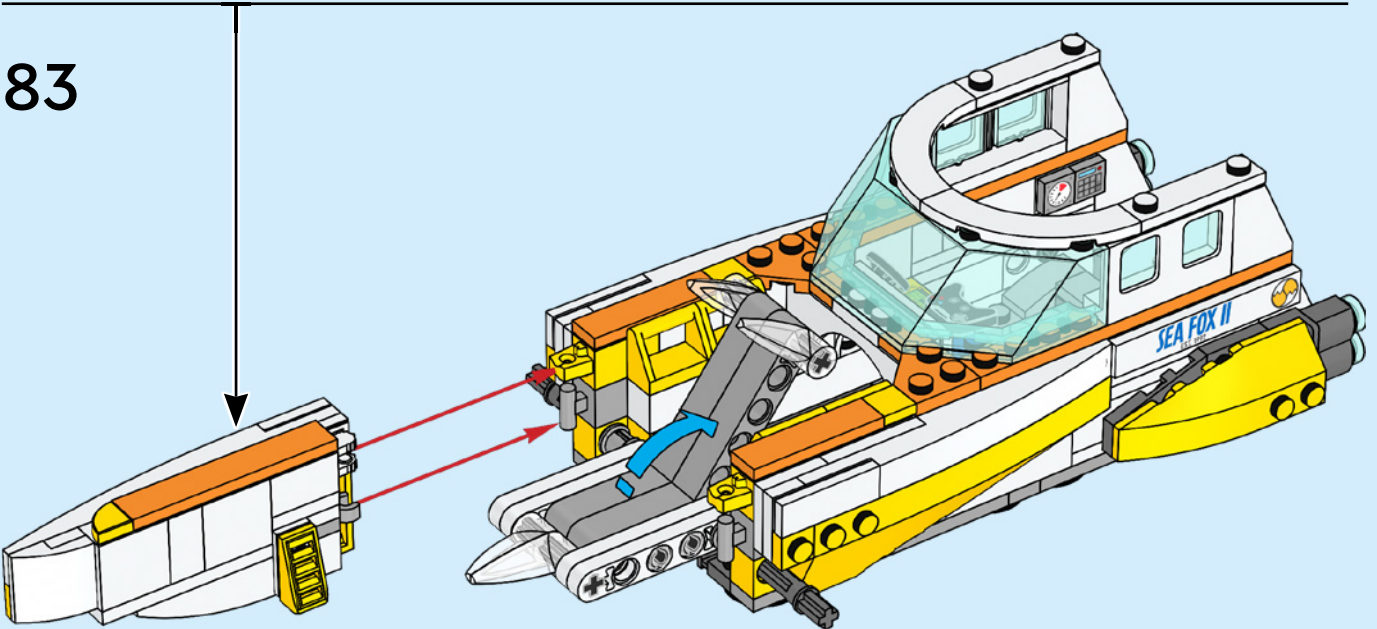

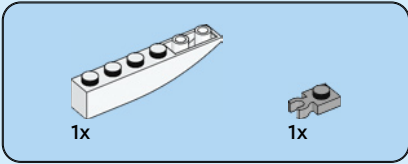
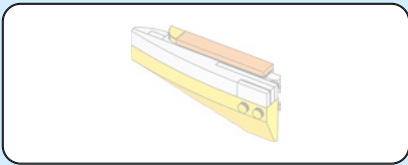

84

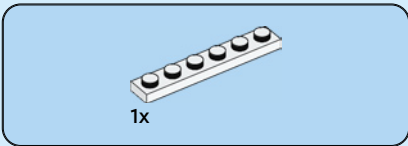
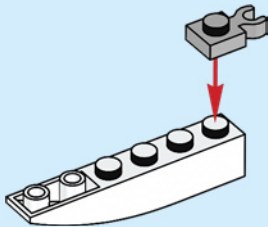

85

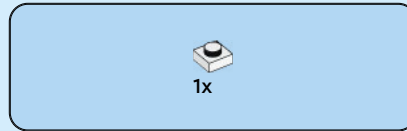
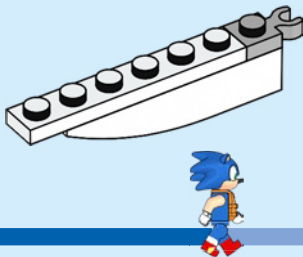

86

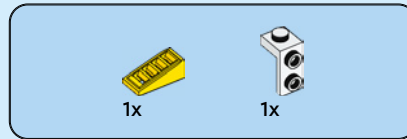
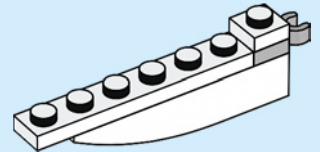

87

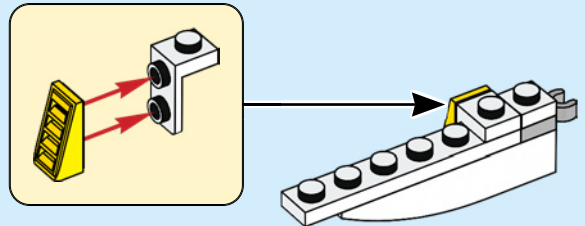



1x

88

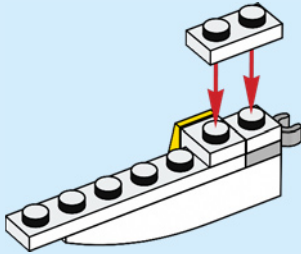

1x

89

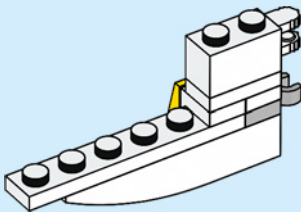

2x



1x

90

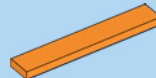
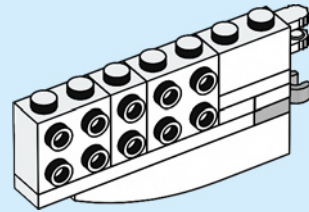

1x



1x

91

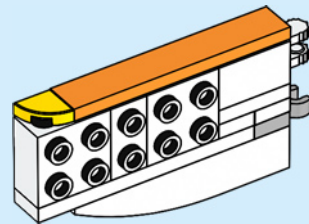

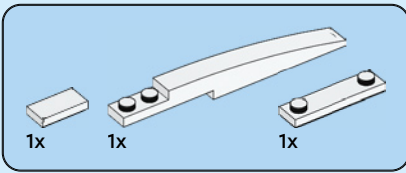

92

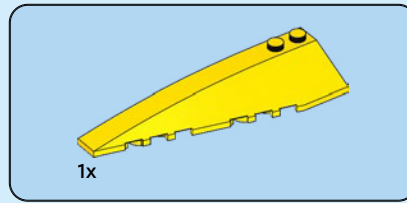
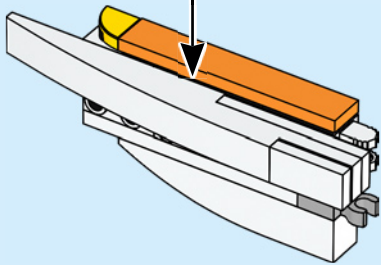
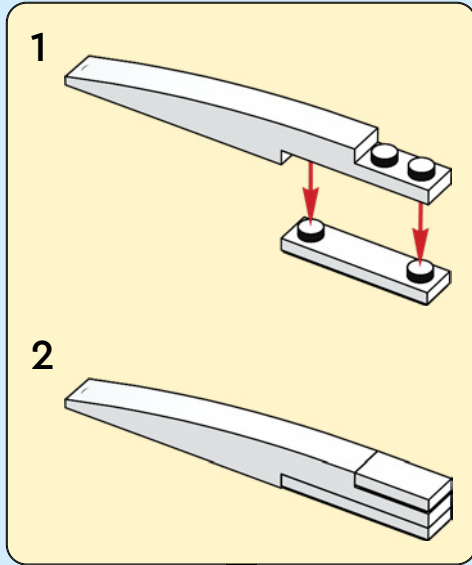

93

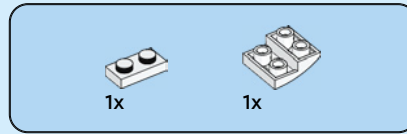
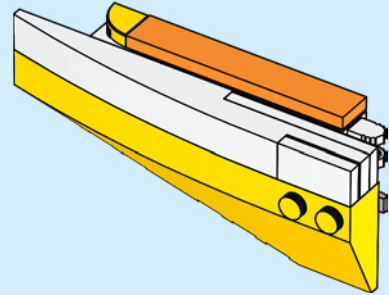

94

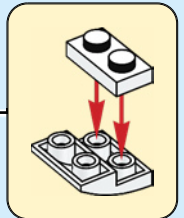
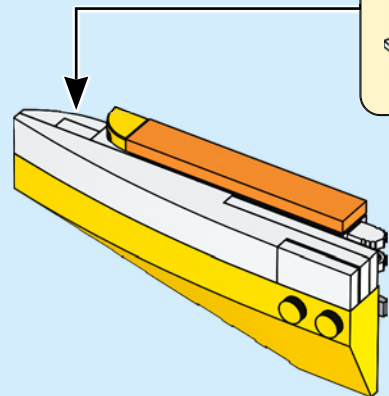

95

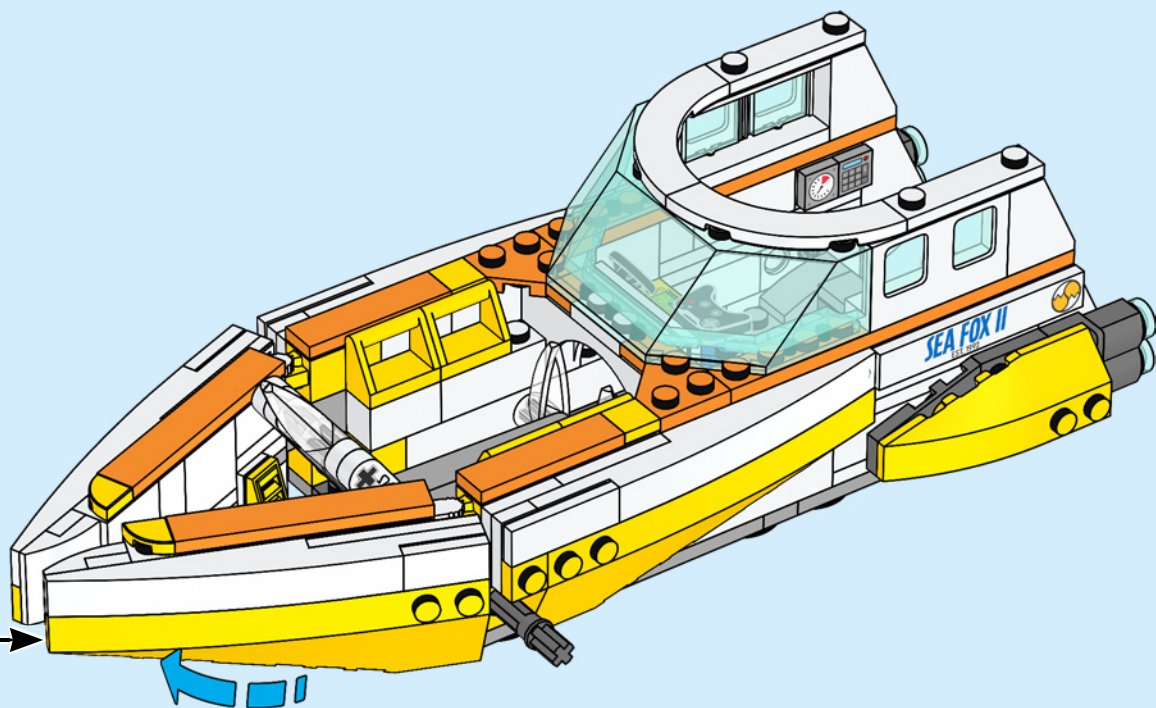

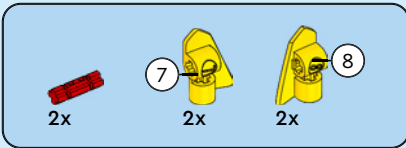

96

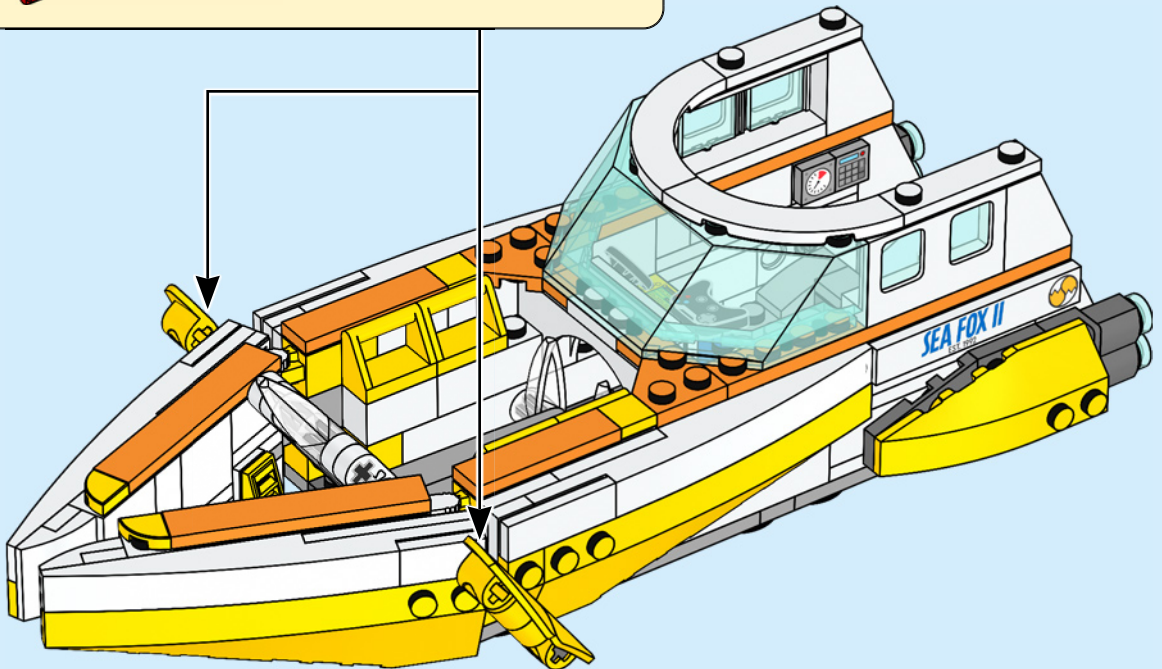
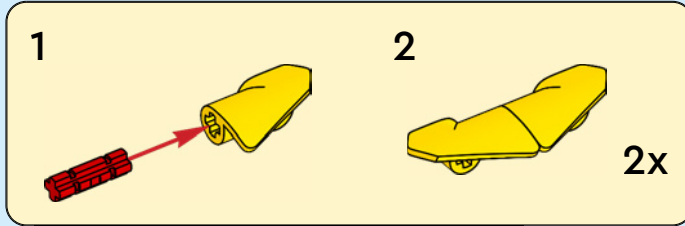

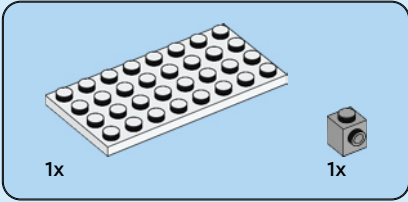
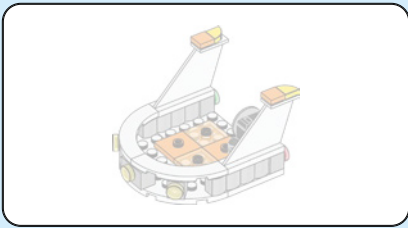

97

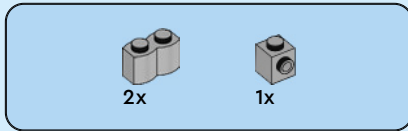
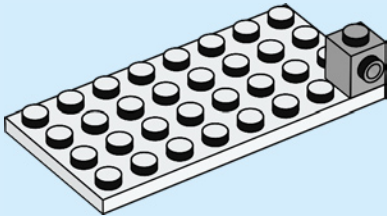

98

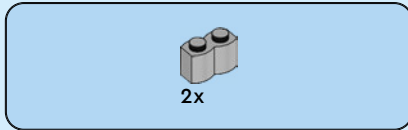
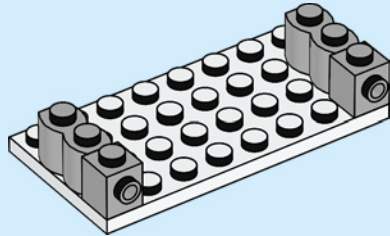

99

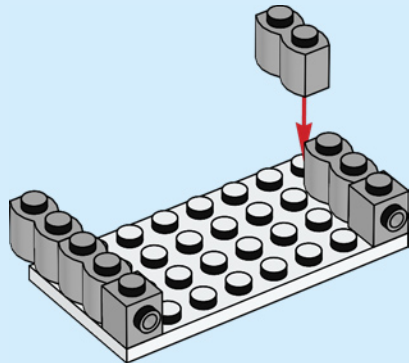

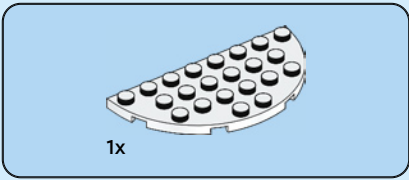

100

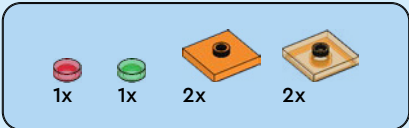
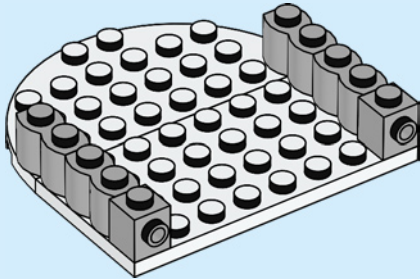

101

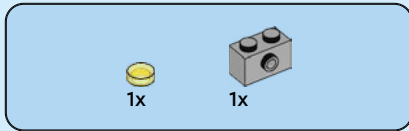
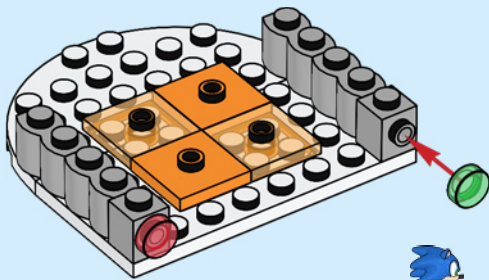

102

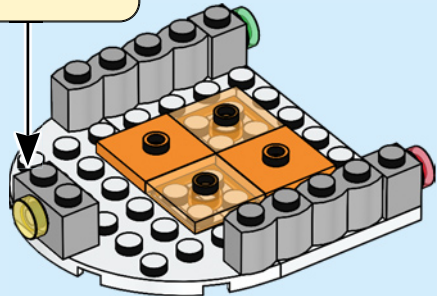
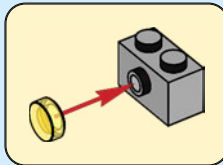



2x



2x

103

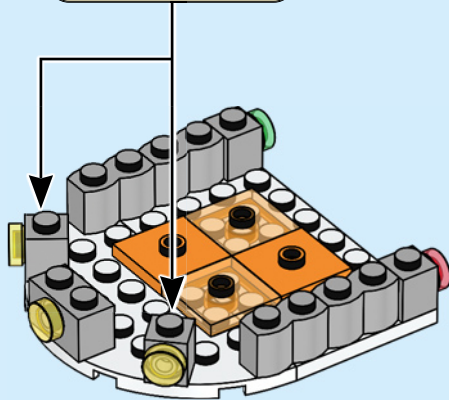
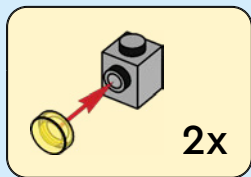

2x

104

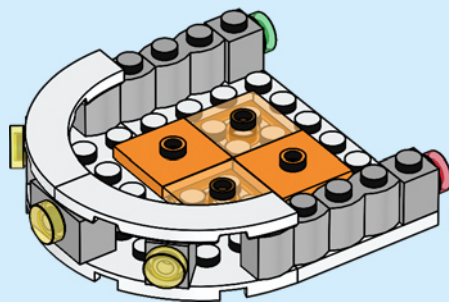

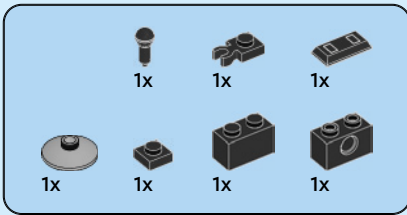

105

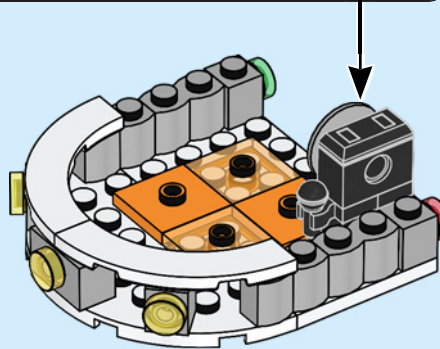
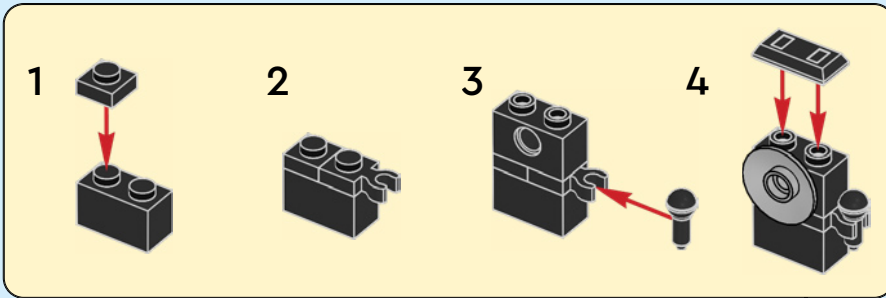

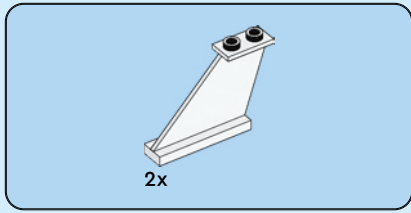

106

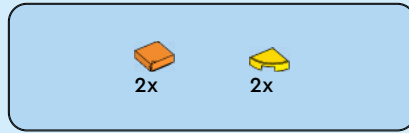
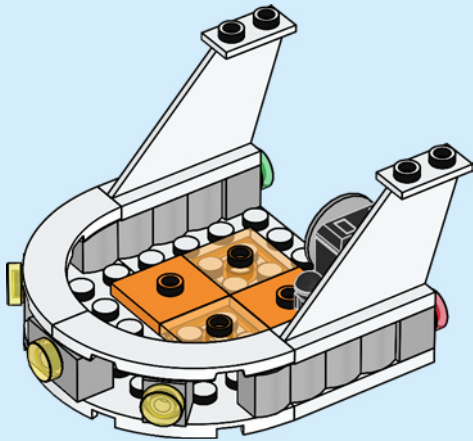

107

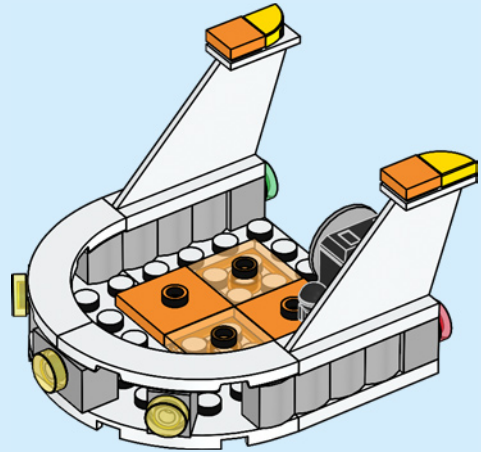

108

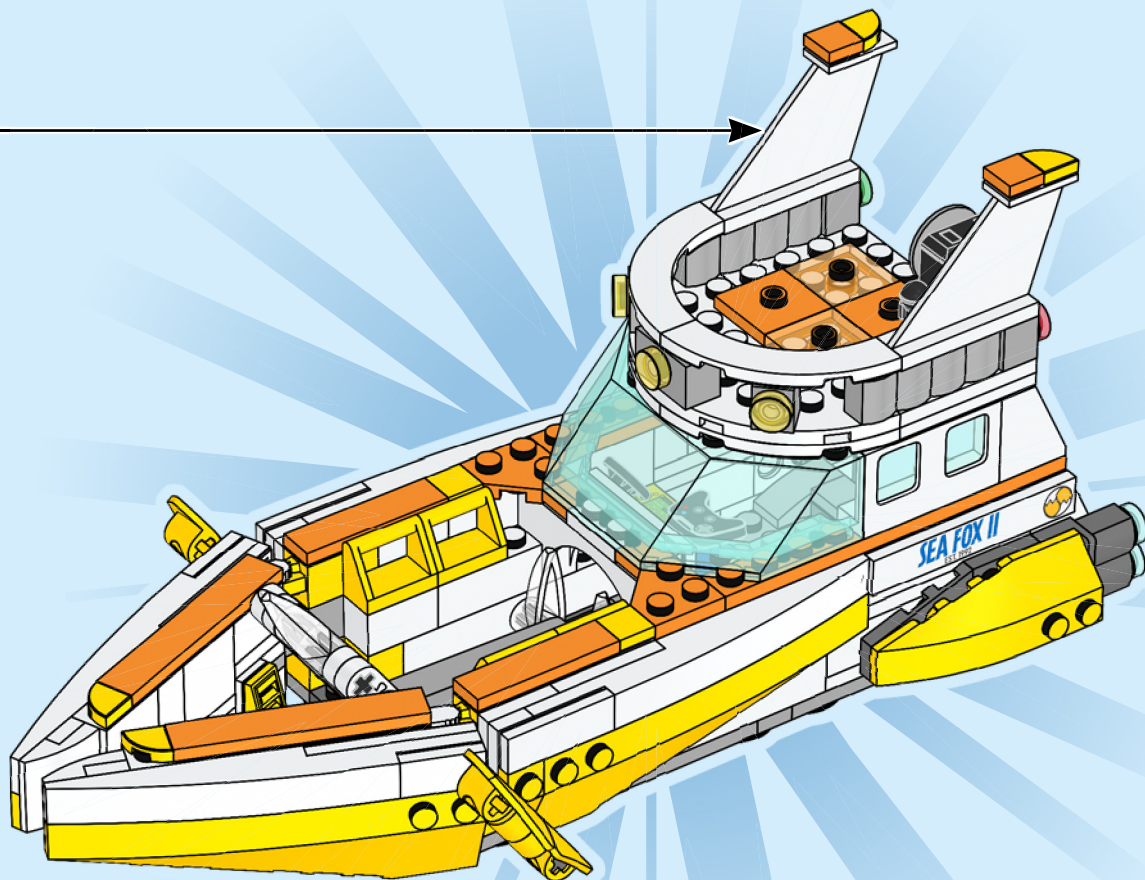

1

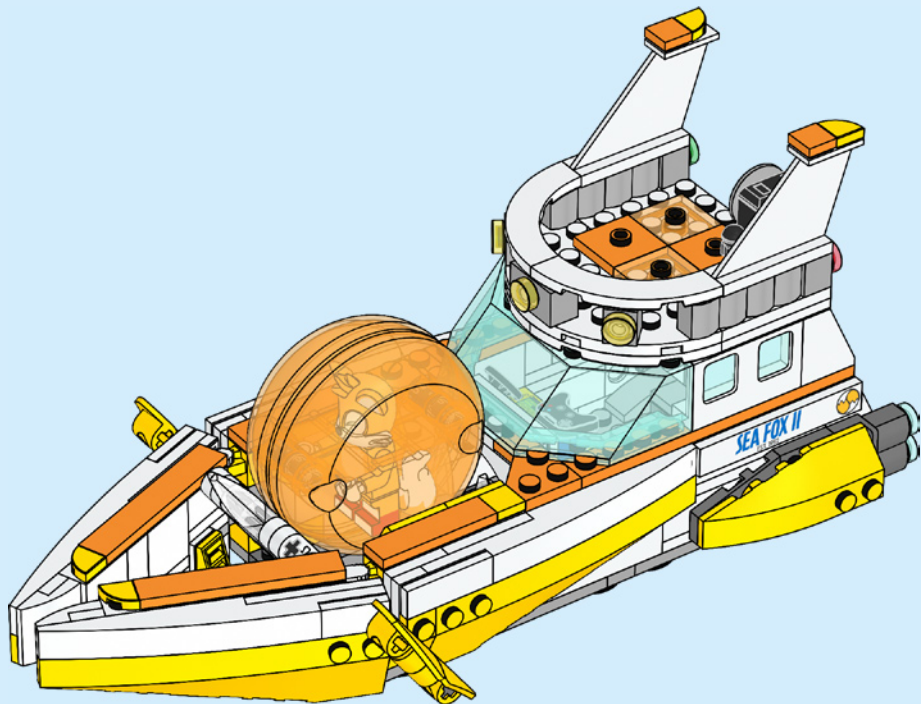

2

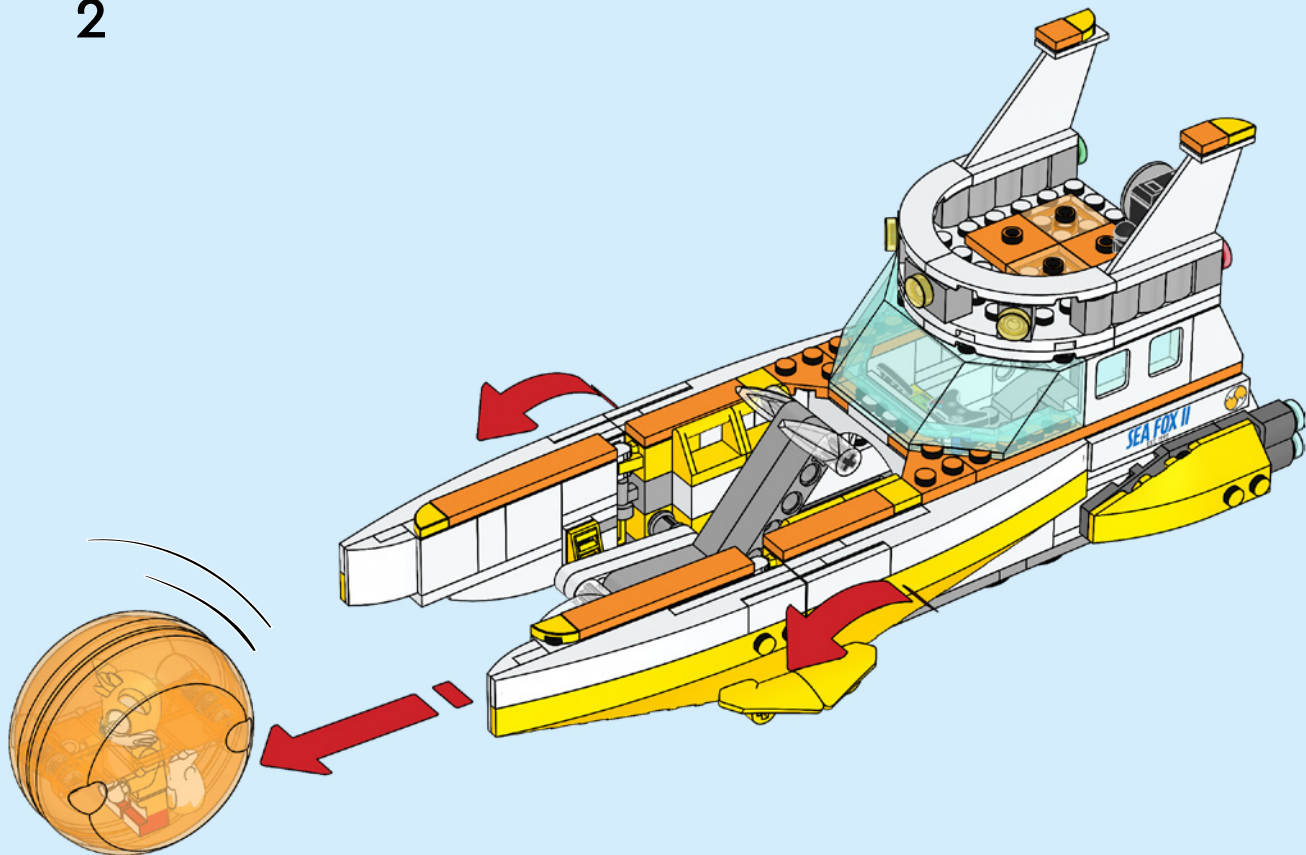

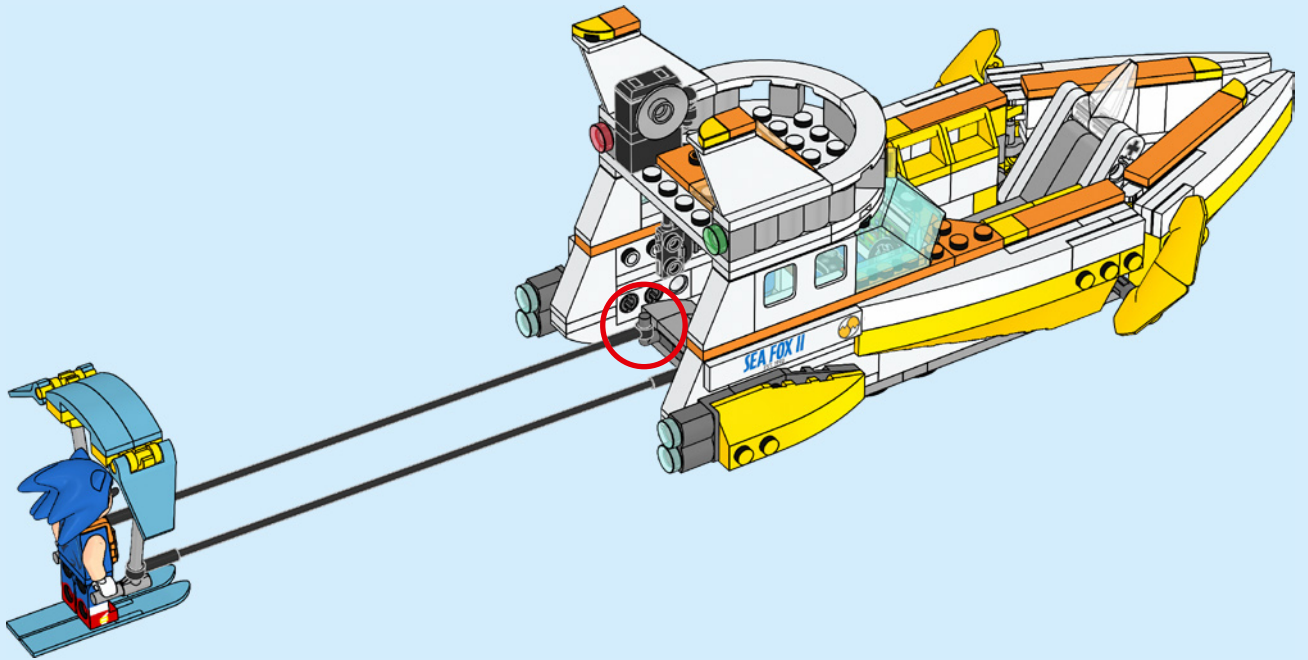

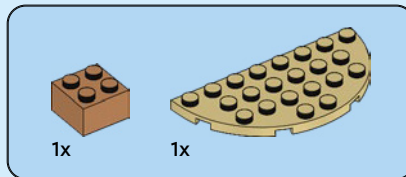
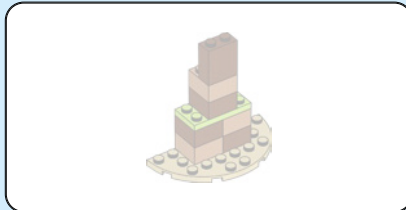
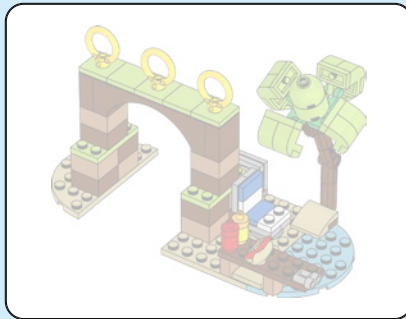

1

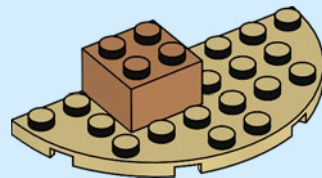

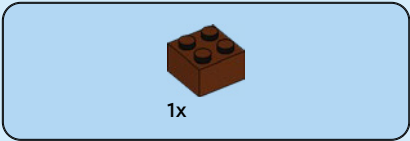

2

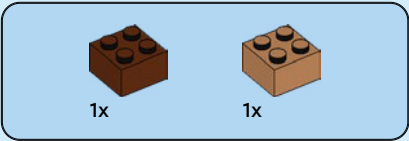
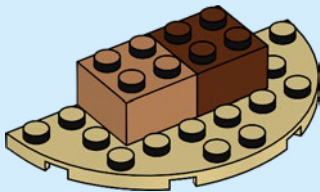

3

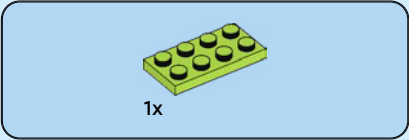
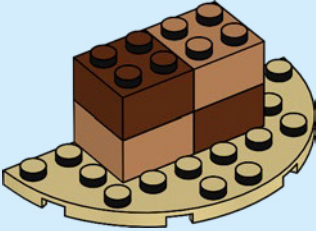

4

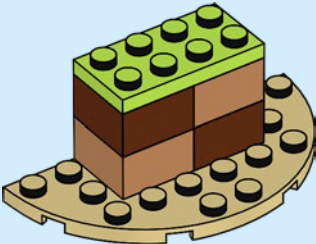

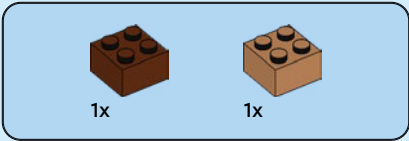

5

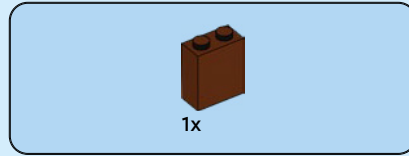
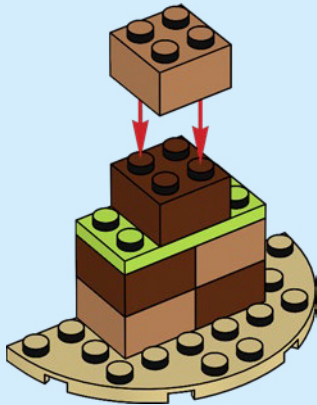

6

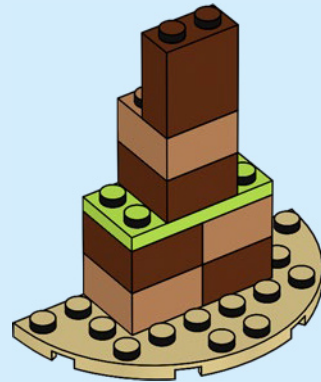

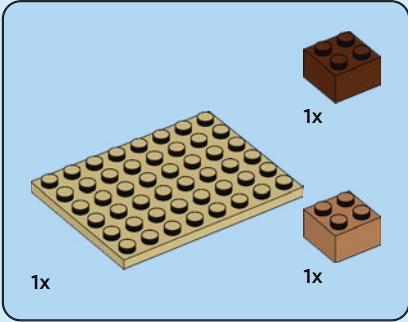
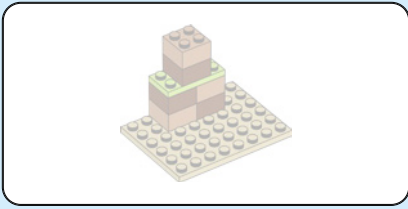

7

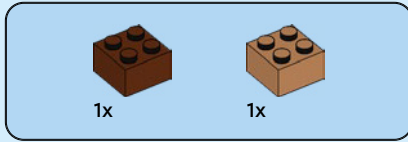
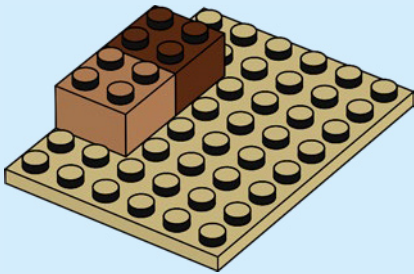

8

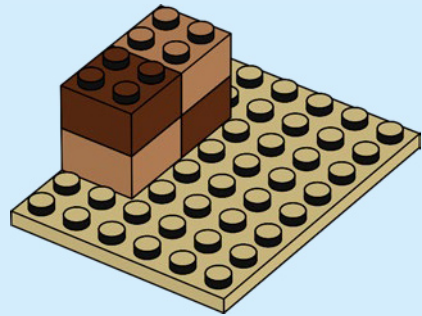

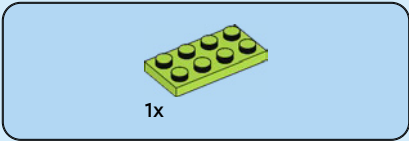

9

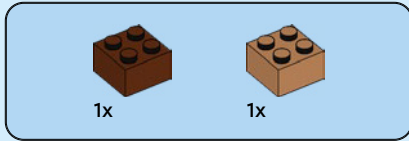
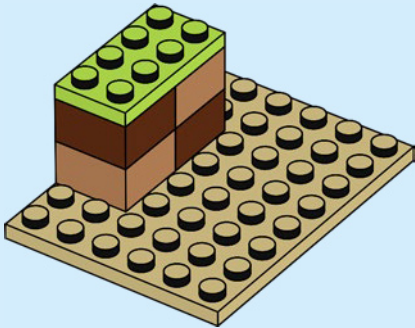

10

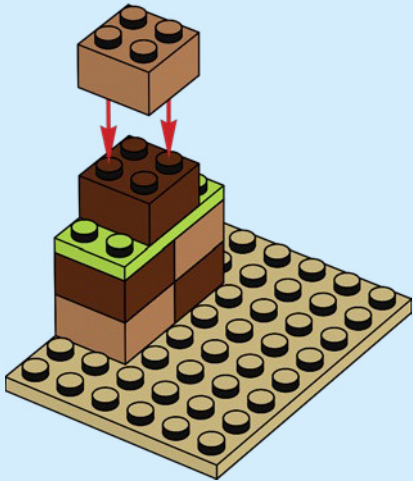

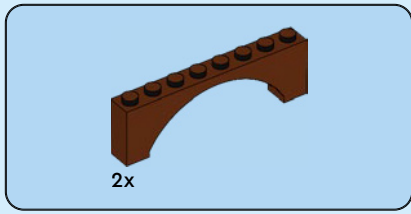

11

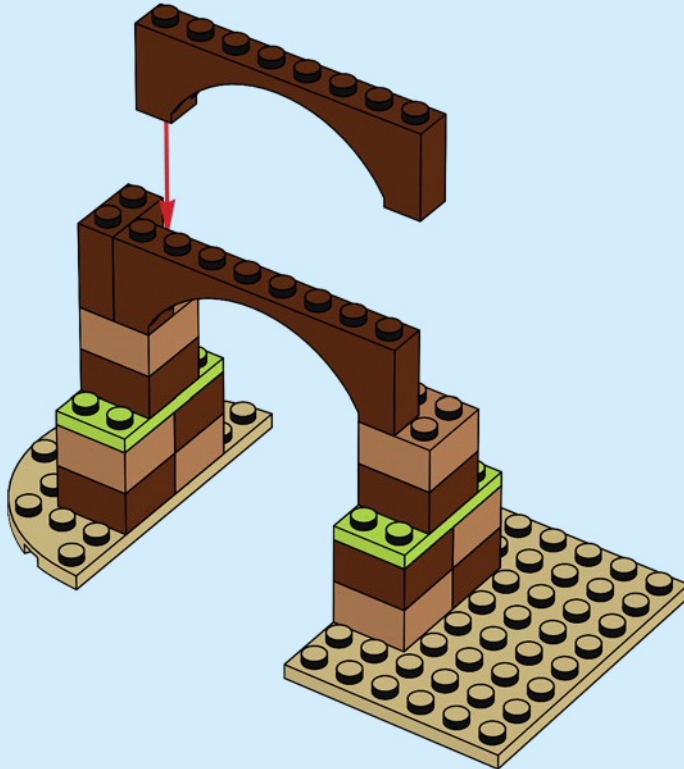



1x

12

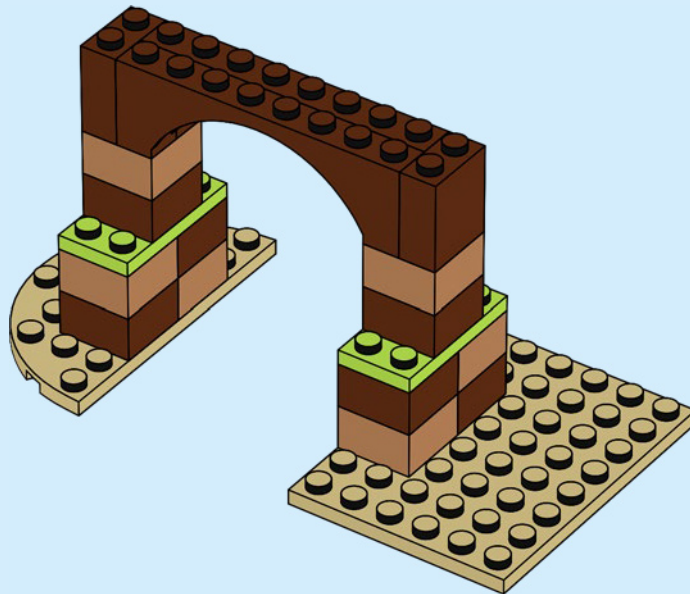



3x

13

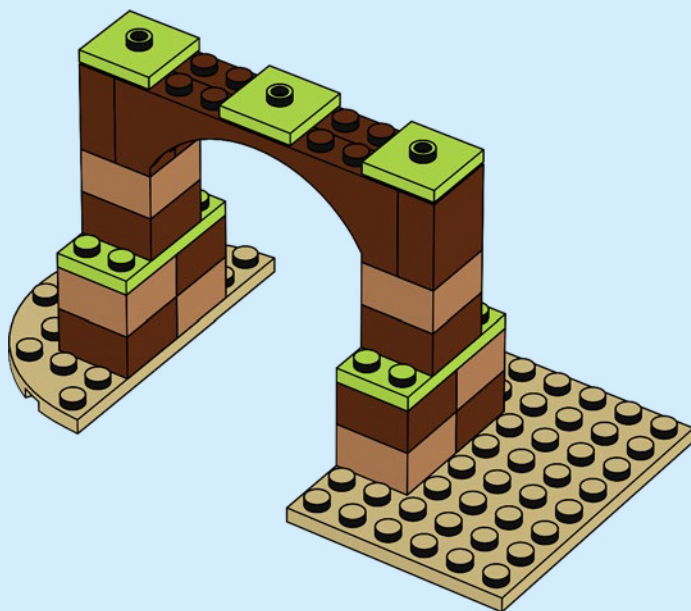



2x

14

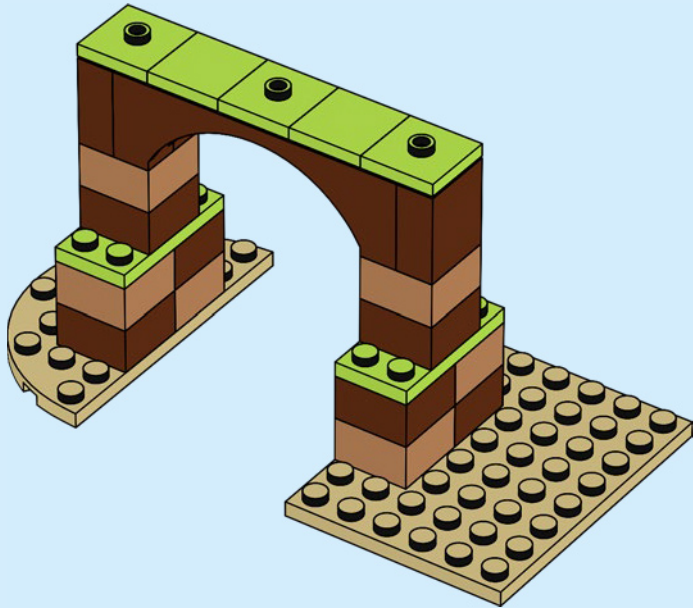



3x

15

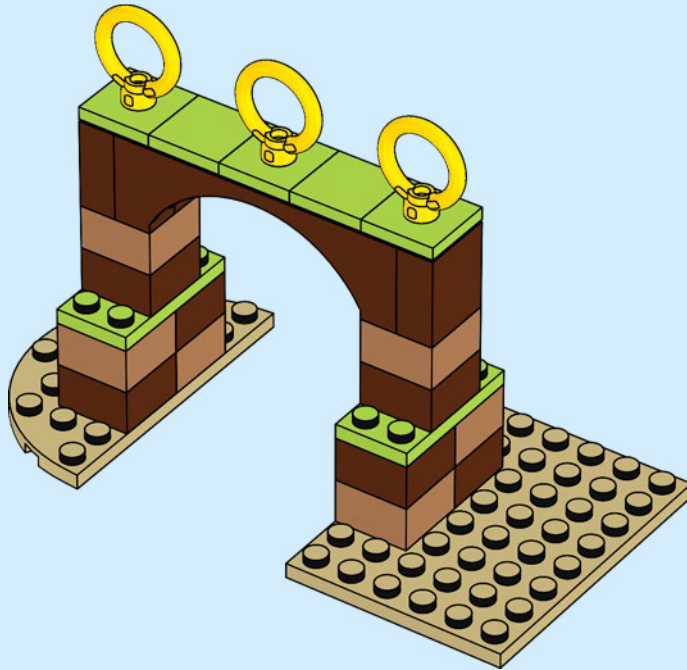

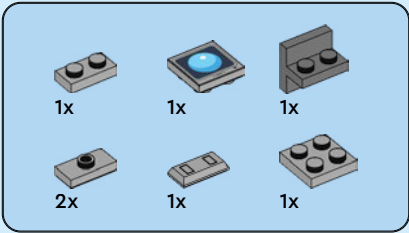

16

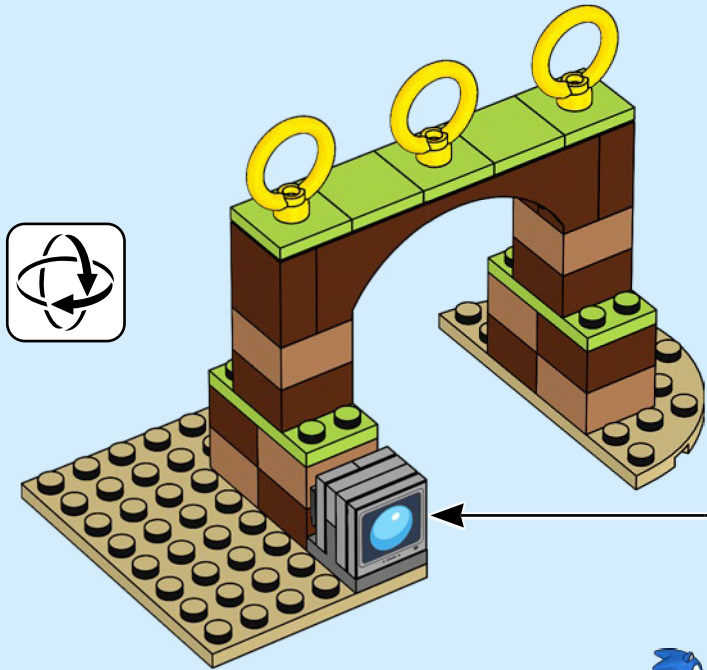
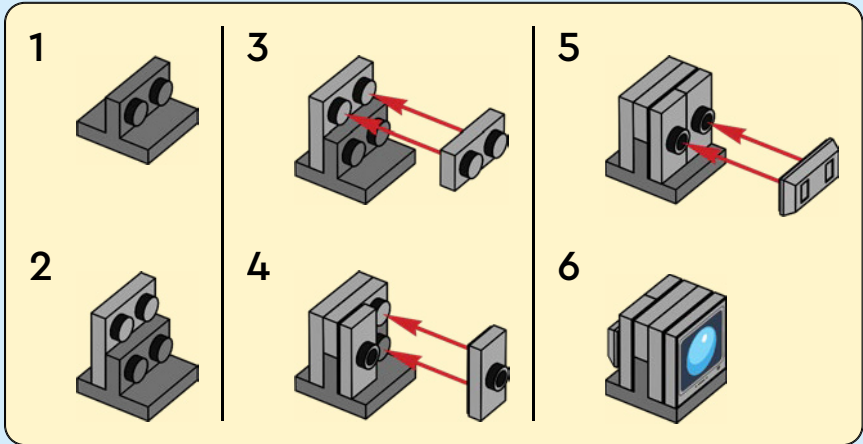

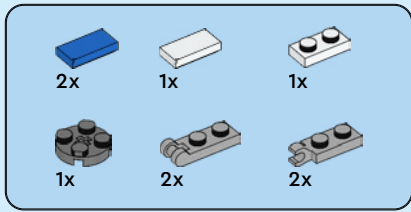

17

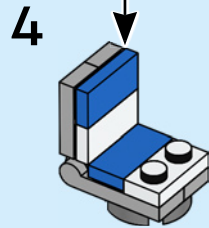
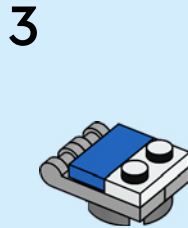
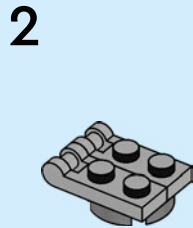
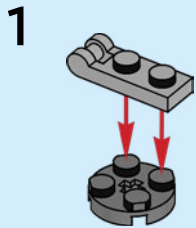
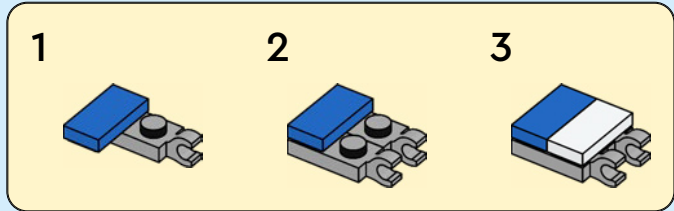

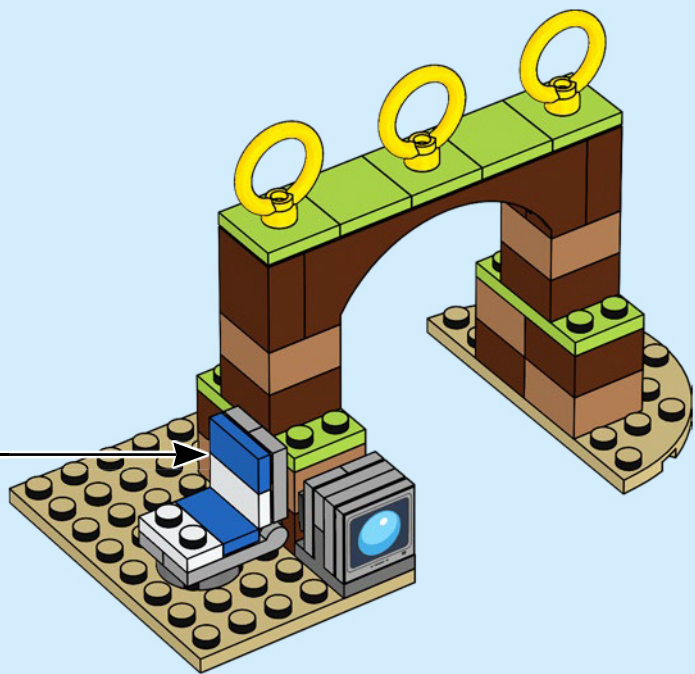



1x

18

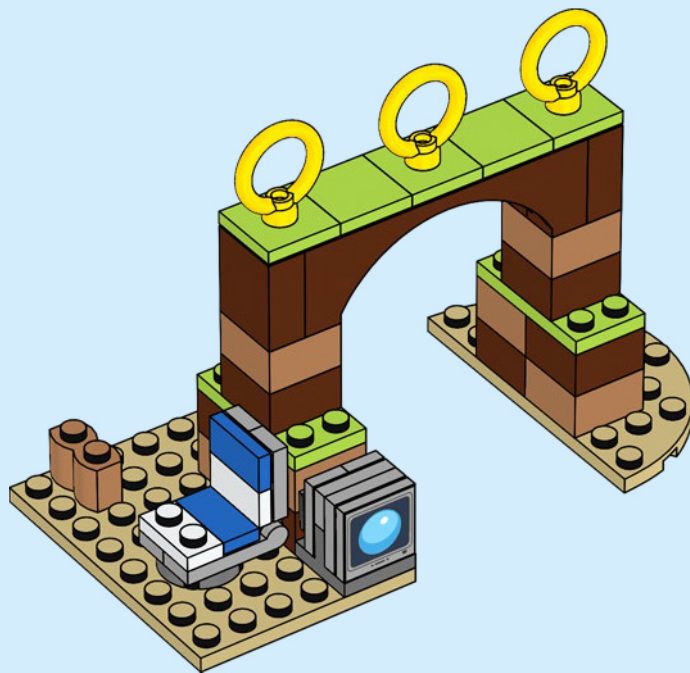

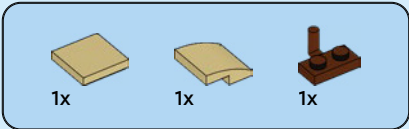

19

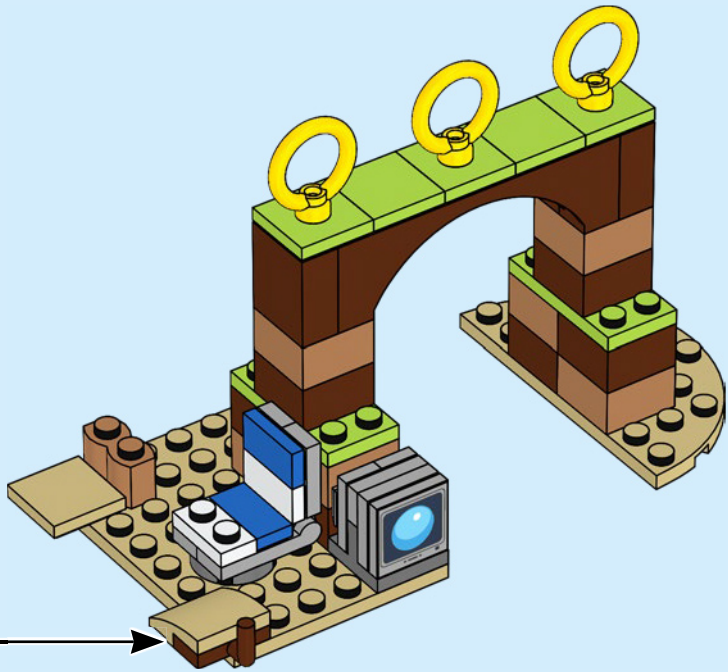

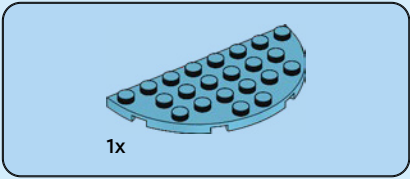

20

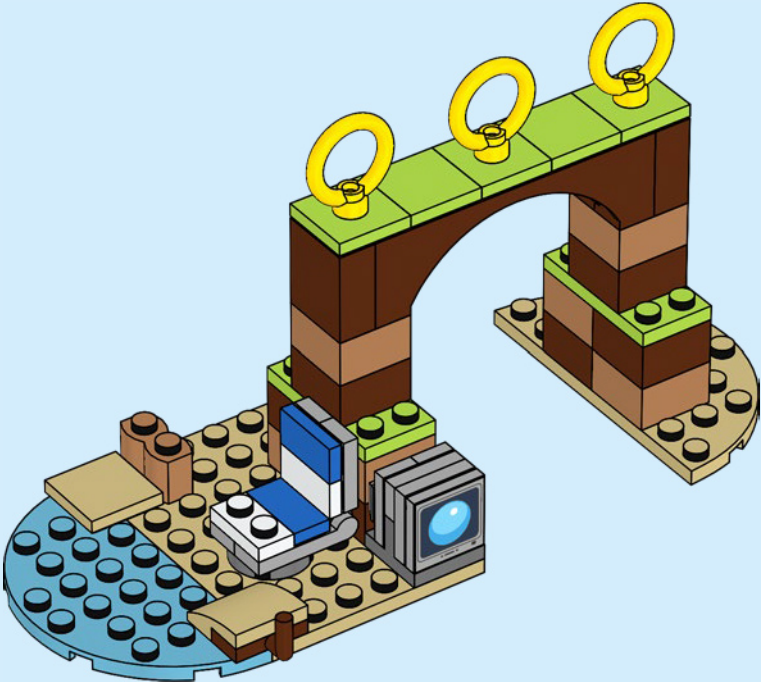



1x

21

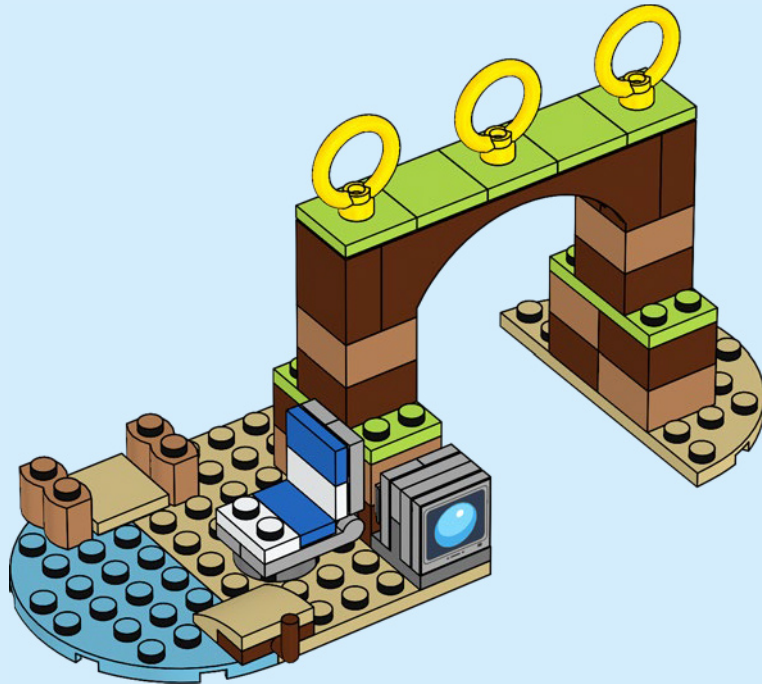

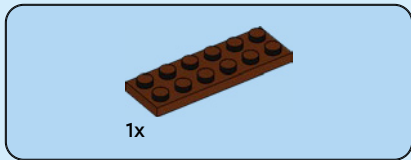

22

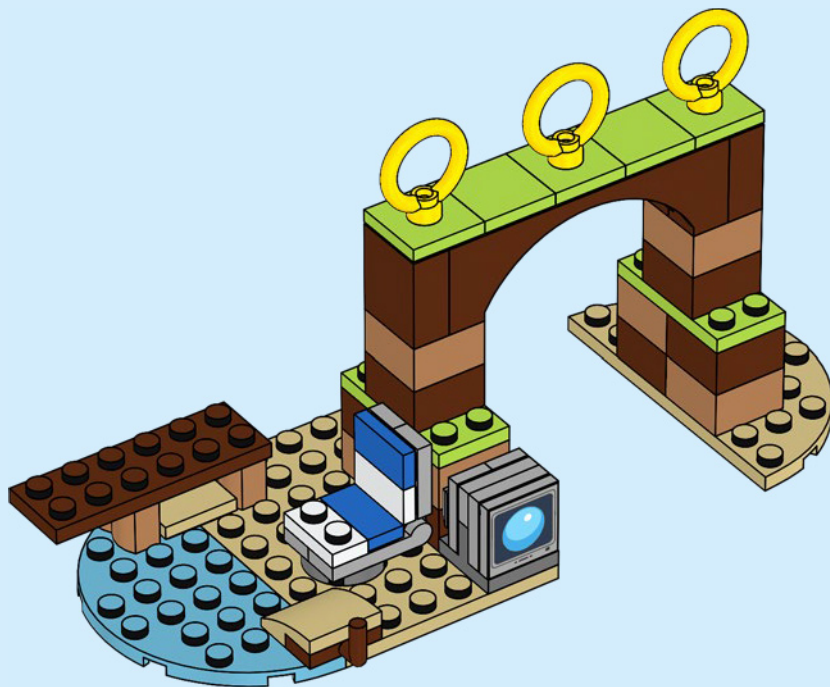

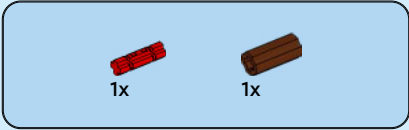
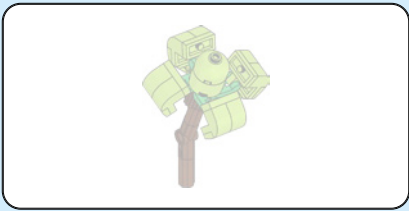

23

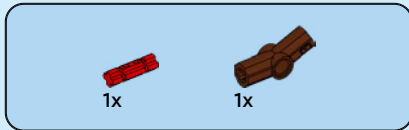

24

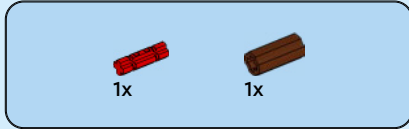

25



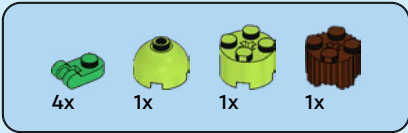

26

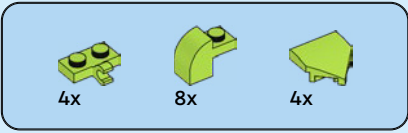
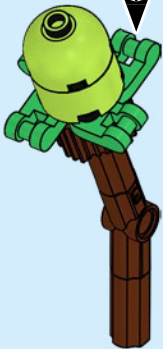
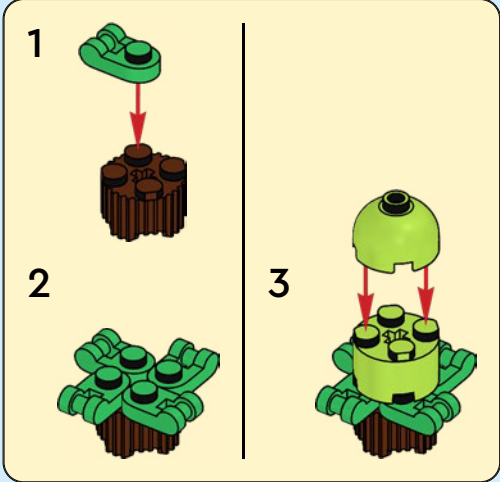

27

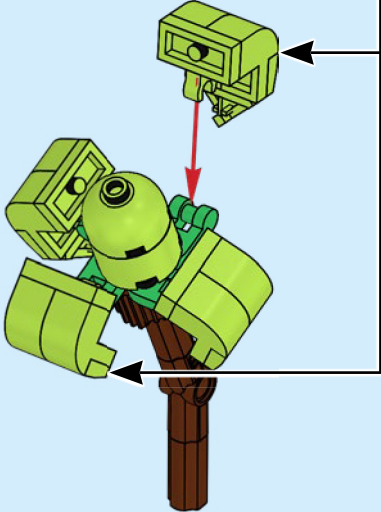
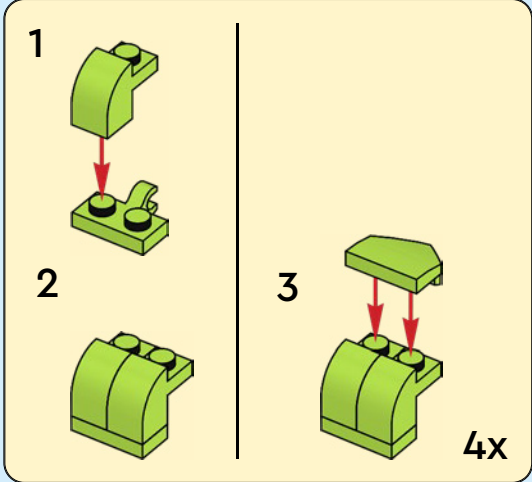

28

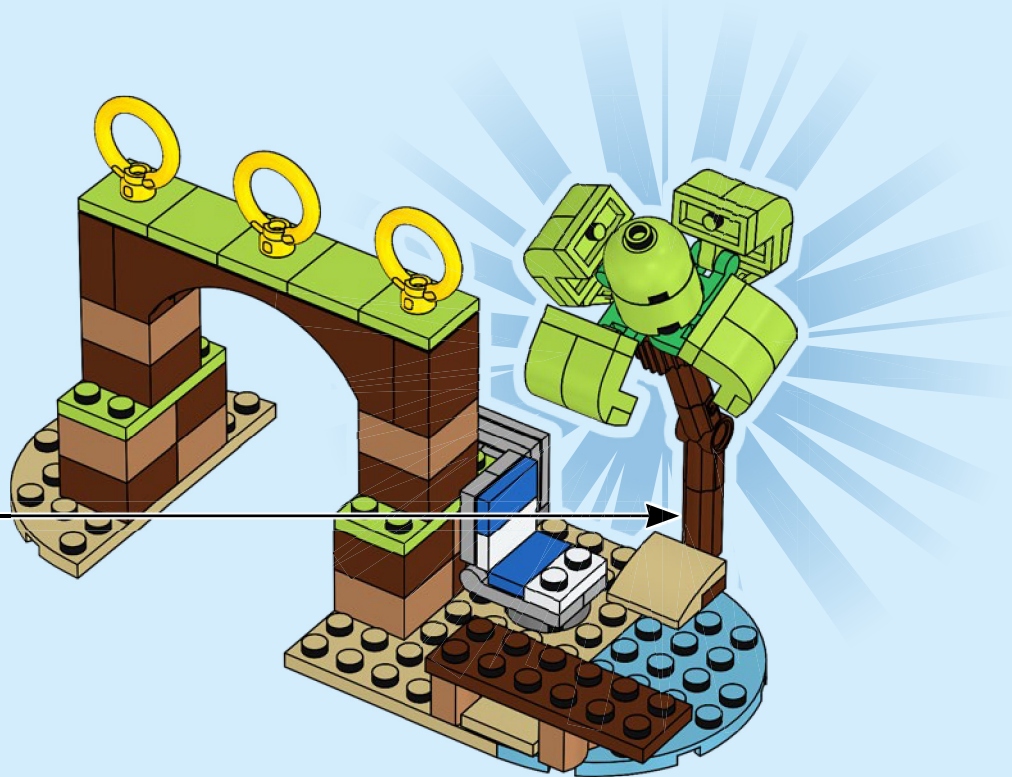

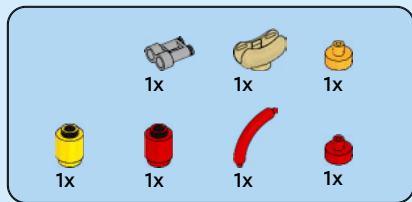

29

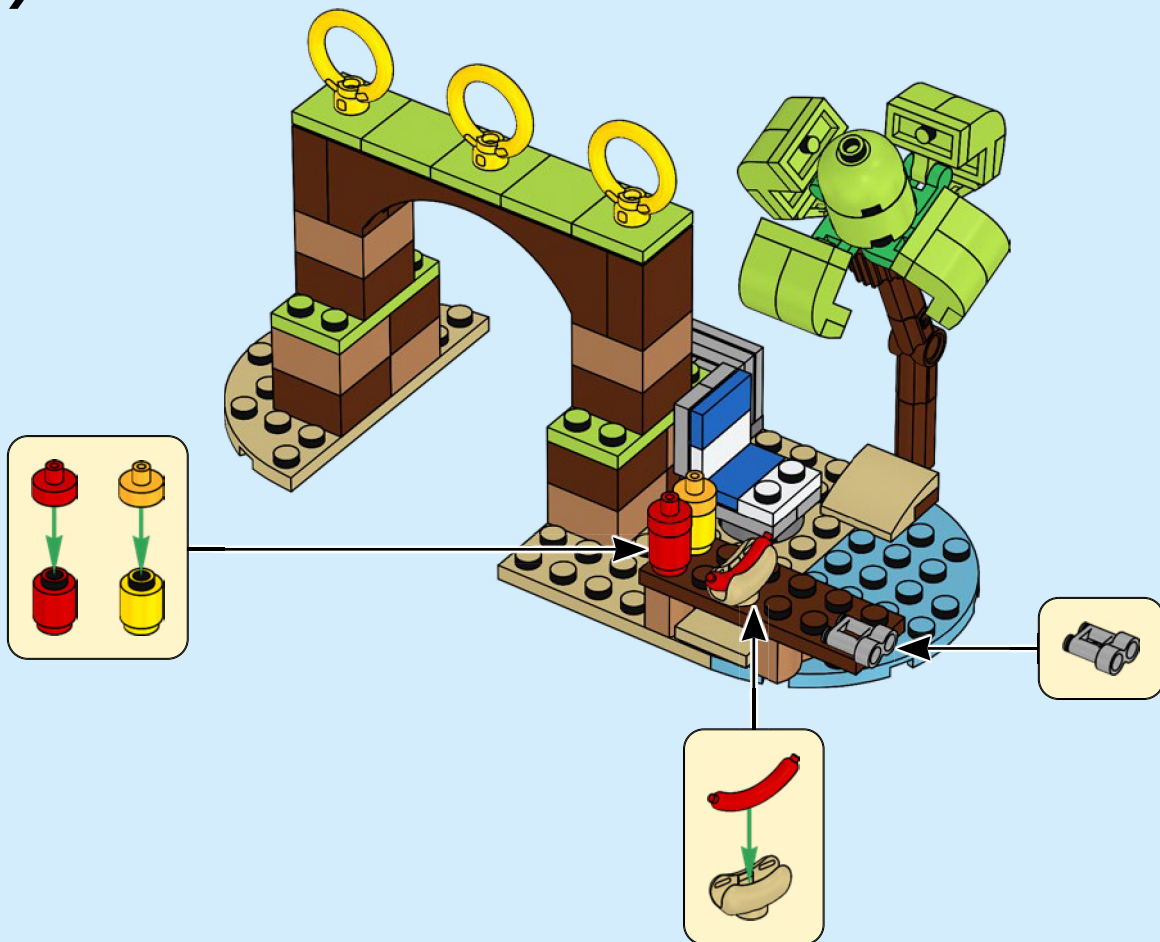

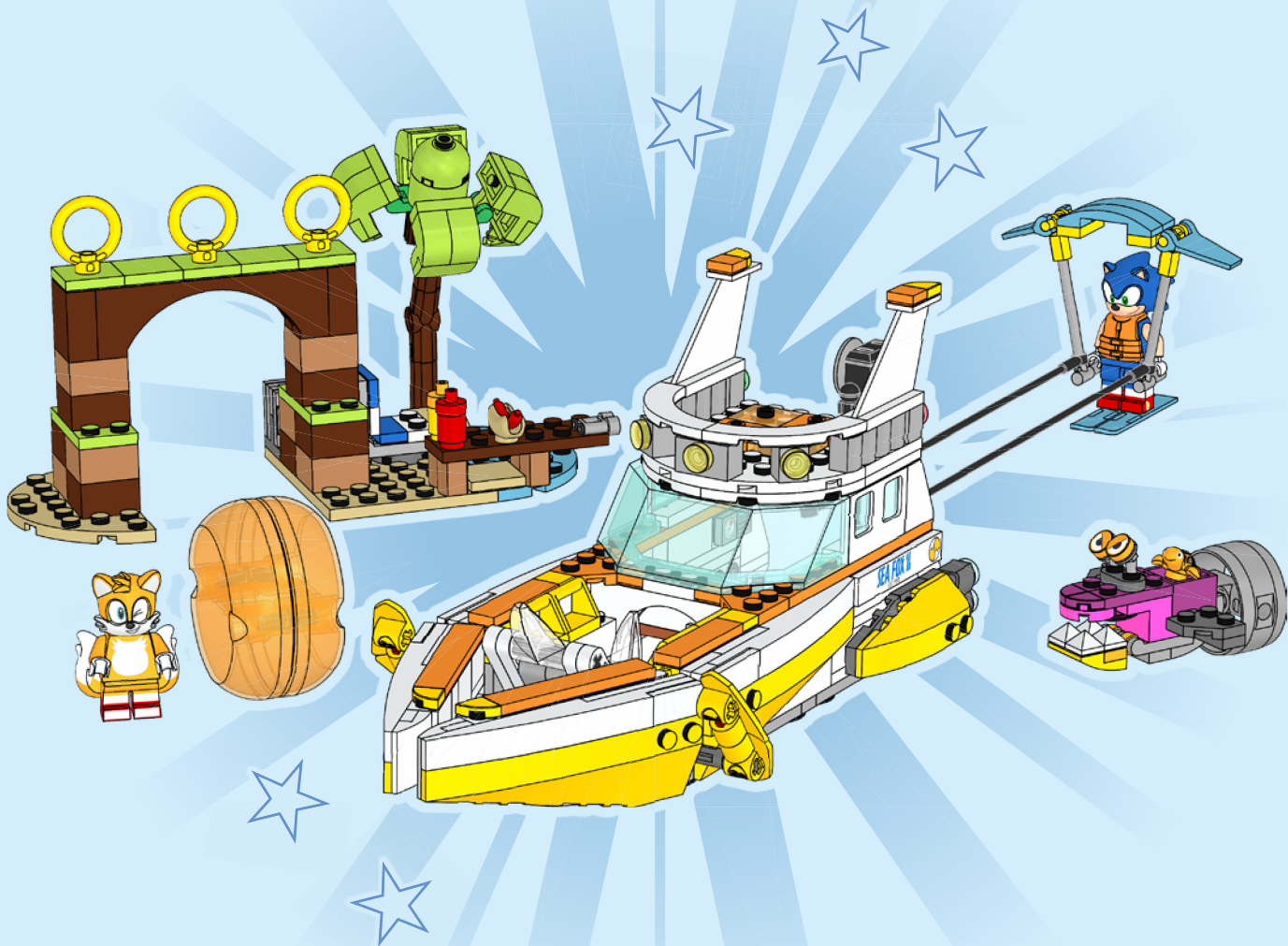



SONIC™

THE HEDGEHOG

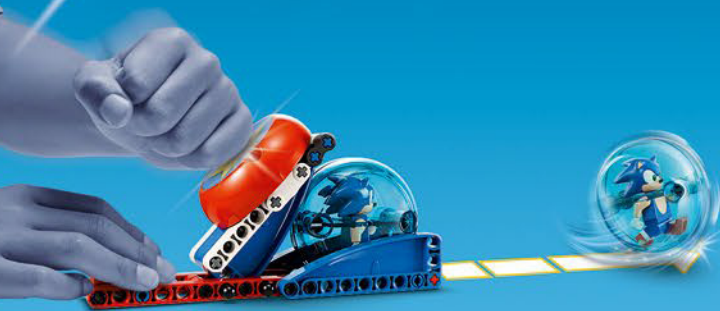

EXPLORE MORE



7 LEGO.com/sonic



Explore more
Mehr entdecken
En savoir plus
Esplora di più
Explora más
Explorar mais
了解更多
Zobacz więcej

Objev více
Objav viac
Tudj meg többet!
Descoperă mai multe
Разгледайте още
Izpēti vairāk
Uuri lähemalt
Atraskite daugiau



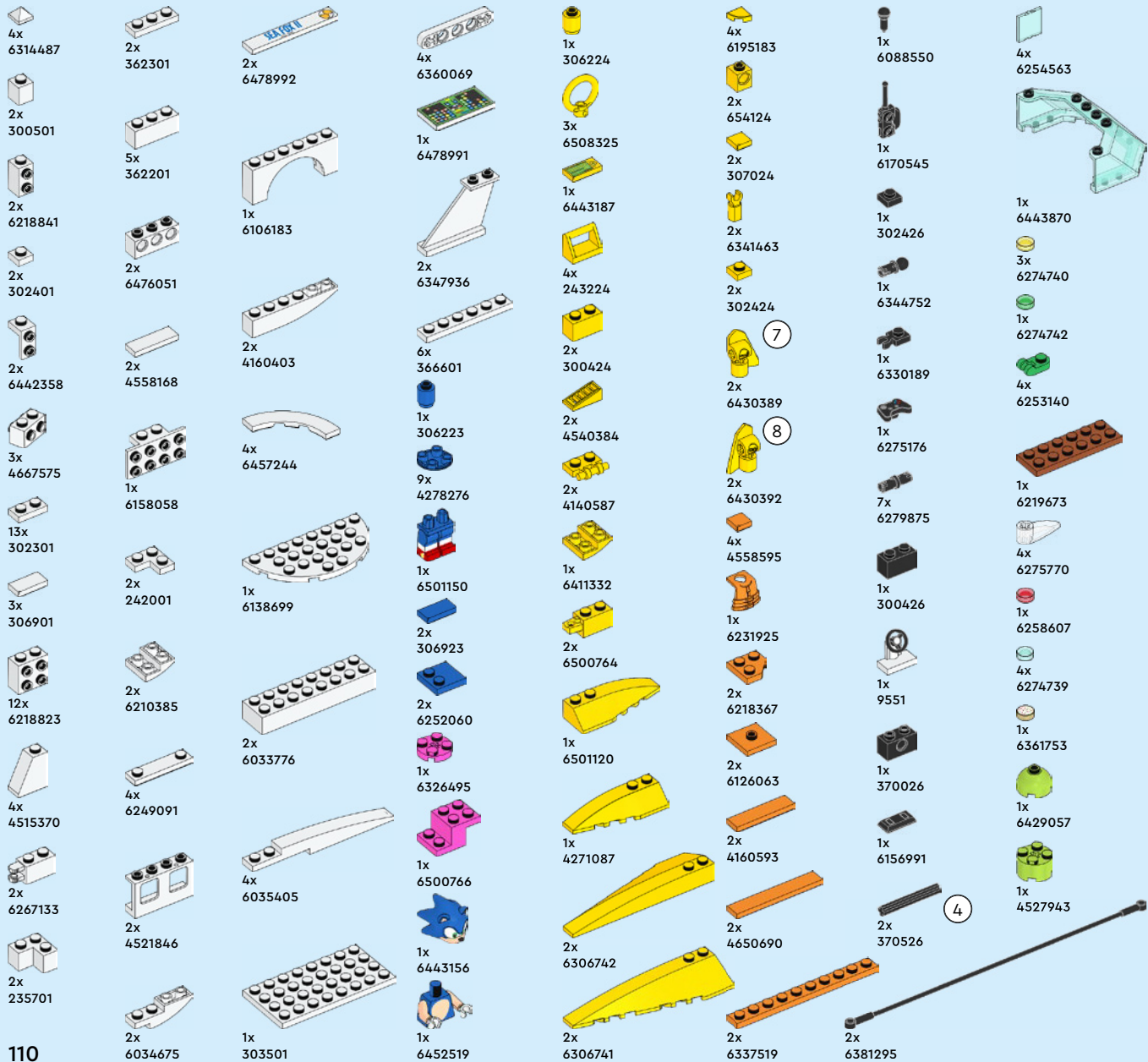

4x
6334046
8x
6411328
4x
6442920
3x
6056291
2x
4518611
2x
4537936
2x
6199889
1x
6143445
2x
6248482
2x
6022048
1x
306221
1x
6452585
1x
6215539
1x
6144805
5x
4142865

1x
6036503
2x
4531751
2x
6172808
1x
6261359
6x
4211210
1x
6261388
1x
4211247
2x
6313665
1x
6147214
1x
4185177
1x
6046924
1x
6123812
1x
6070501

2x
6510189
2x
6275844
4x
4558953
1x
6329583
1x
6329584
2x
6170569
1x
6345426
1x
4550170
2x
6296894
1x
4211512
4x
4550325
3x
4211398
2x
6066097
1x
6134378
1x
6043656
1x
6329585

1x
6383177
2x
6028813
2x
6319336
1x
4211397
1x
6478993
1x
6185676
4x
4515369
1x
4211356
1x
4507052
2x
4565433
2x
6279885
5x
4211425
1x
4211408

1x
6221607
1x
4210872
1x
4210869
1x
4211042
2x
4211095
2x
6164073
2x
6261355
1x
4211063
2x
6000606
1x
6250018
2x
6336990
2x
6284702
1x
6396395
2x
4508553
2x
4210967

1x
6443193
1x
6492805
1x
6337271
1x
6443191
1x
6452547
2x
6499254
2x
6474296
1x
6435103
1x
6223719
1x
6443215

2x
6500765
2x
4651231
6x
6058085
2x
6322904
2x
6365501
2x
6097093
2x
6170544
1x
6138571

5,5

 [LEGO.com/service](https://www.LEGO.com/service)

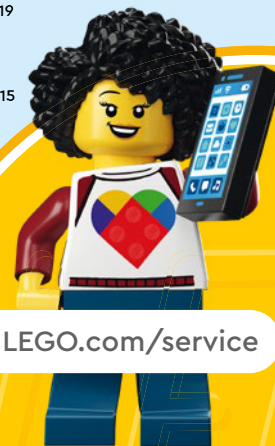

YOU COULD **WIN**

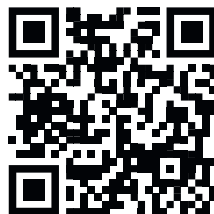

Scan this QR code or go to **LEGO.COM/PRODUCTFEEDBACK** and give us your short feedback about this LEGO® set for a chance to win a cool LEGO prize.

Terms and Conditions apply*

EN: YOU COULD WIN. Terms and Conditions apply* **DE: Du könntest GEWINNEN.** Es gelten die Teilnahmebedingungen* **FR: Tu pourrais GAGNER.** Des conditions s'appliquent* **IT: Potresti VINCERE tu.** Termini e condizioni sono applicabili* **ES: Puedes GANAR.** Aplican términos y condiciones* **PT: Poderá GANHAR.** Aplicam-se termos e condições* **ZH: 轻松获奖. 条款和条件适用*** **PL: Szansa na WYGRANĄ.** Obowiązują warunki korzystania* **CS: Máte šanci VYHRÁT.** Platí všeobecné smluvní podmínky* **SK: Máte šancu VYHRAŤ.** Platia všeobecné zmluvné podmienky* **HU: TE IS NYERHETSZ.** Felhasználási feltételek érvényesek* **RO: Ai putea CÂȘTIGA.** Se aplică termeni și condiții* **BG: Можете да СПЕЧЕЛИТЕ.** Има определени правила и условия* **LV: Tu vari LAIMĒT.** Ir spēkā noteikumi un nosacījumi.* **ET: Sul on võimalus VÕITA.** Kehtivad tingimused* **LT: Jūs galite LAIMĖTI.** Taikomos sąlygos*

*[LEGO.com/productfeedback-terms](https://www.lego.com/productfeedback-terms)