



DREAMZZZ™

71480



Q LEGO® Builder



LEGO.com/sustainable-packaging



FR
DONNEZ
OU
RECYCLEZ



OU



OU



ASSOCIATION

MAGASIN

DÉCHÈTERIE

Adresses sur quefairedemesdechets.fr

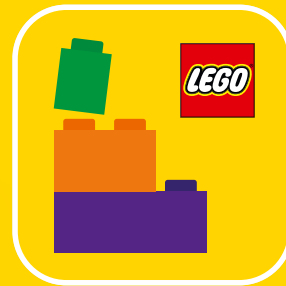

🔍 LEGO® Builder

BUILDER

Download on the
App Store

GET IT ON
Google Play

腾讯应用宝
安卓应用商店

Apple and the Apple logo are trademarks of Apple Inc., registered in the U.S. and other countries and regions. App Store is a service mark of Apple Inc. Google Play and the Google Play logo are trademarks of Google LLC. Tencent and the Tencent logo are trademarks of Tencent Inc.

🔍 LEGO.com/devicecheck

EN Ask parents' permission before going online | DE Eltern um Erlaubnis bitten, bevor du online gehst | FR Demande l'autorisation d'un parent avant d'aller en ligne | IT Chiedi il permesso ai tuoi genitori prima di andare online | ES Pídeles permiso a tus papás antes de conectarte a Internet | PT Pede autorização aos pais antes de acederes online | ZH 上网前应先征得父母的同意 | PL Poproś rodziców o zgodę, zanim wejdiesz do Internetu | CS Než půjdeš na internet, požádej rodiče o svolení | SK Skôr než pôjdeš na internet, vypýtaj si povolenie od rodičov | HU Kérj szülői engedélyt, mielőtt online csatlakoznál! | RO Cere permisiunea părinților înainte de a te conecta online | BG Поискайте разрешение от родител, преди да влезете онлайн | LV Pirms došanās tiešsaistē palūdz atļauju vecākiem | ET Enne Interneti kasutamist küsi vanematelt luba | LT Prieš prisijungdami prie interneto, atsklauskite tėvų





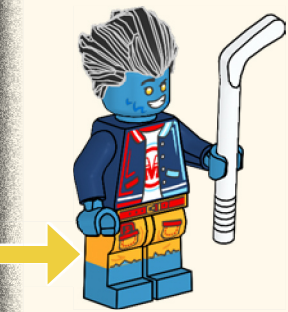
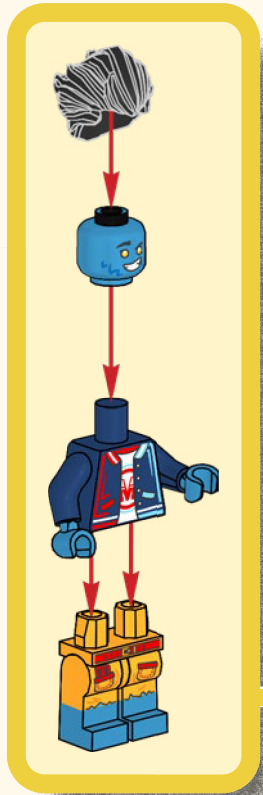
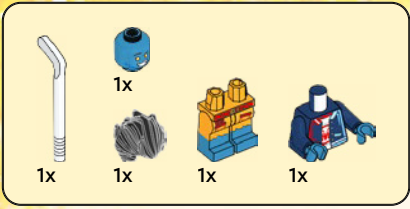



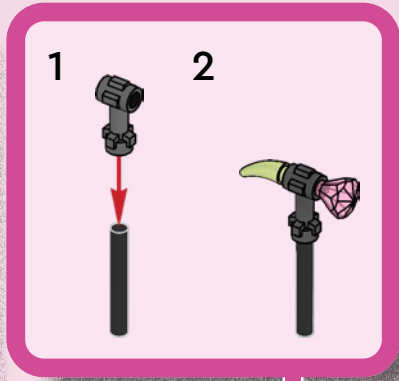
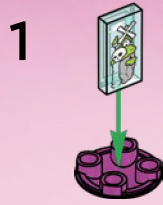
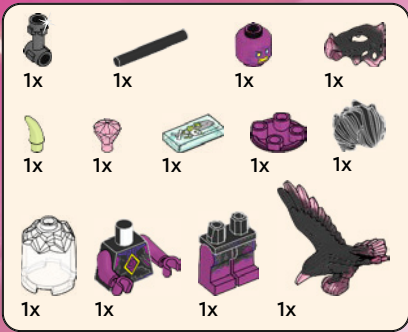



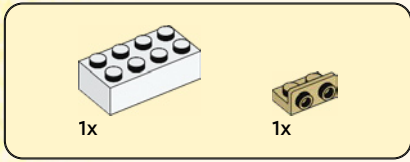

1

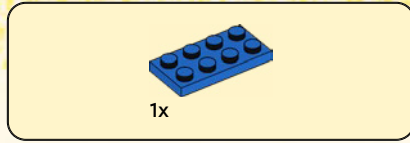
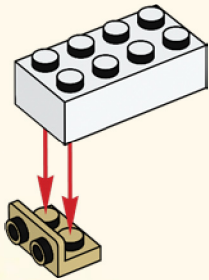

2

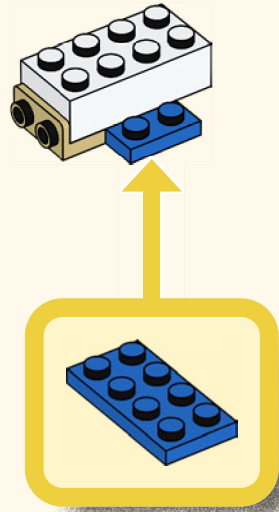



2x

3

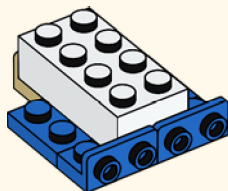

4x

4

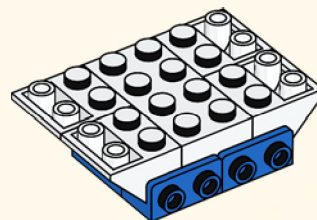

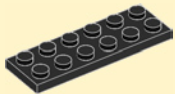

1x

5

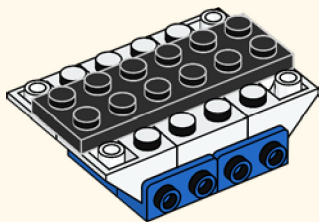

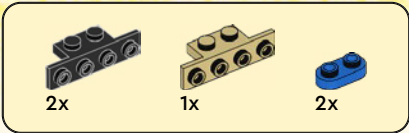

6

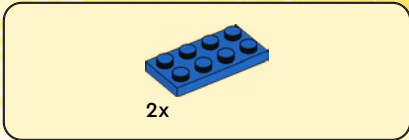
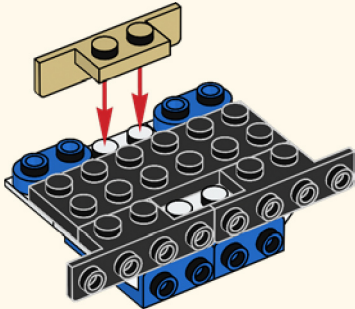

7

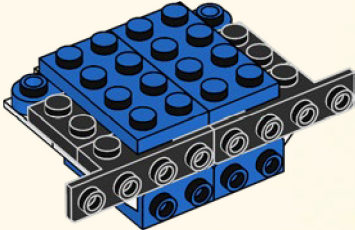

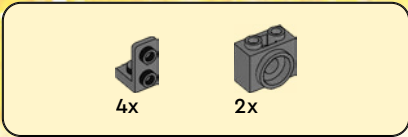

8

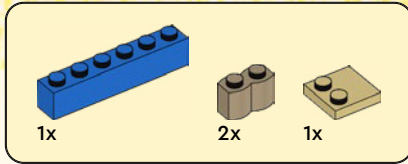
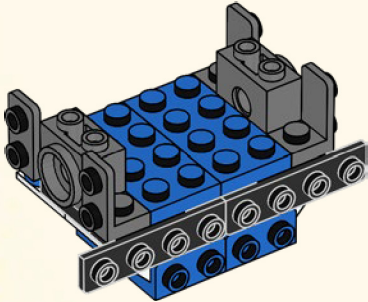

9

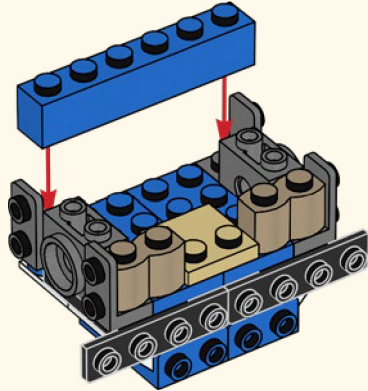

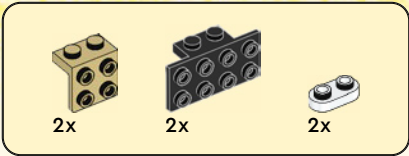

10

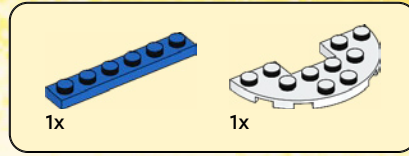
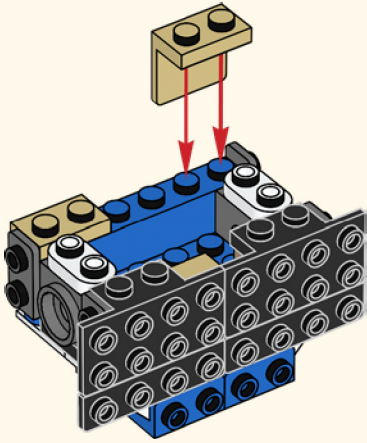

11

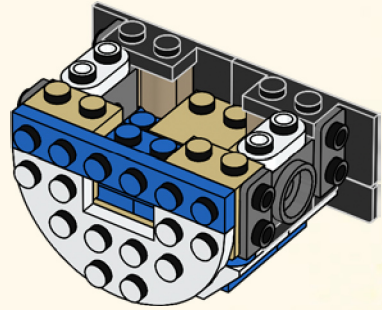

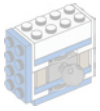

1x



1x

12

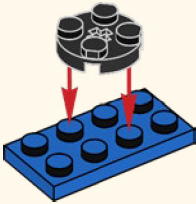

2x

13

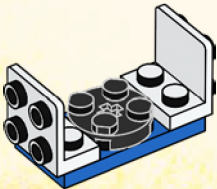

1x

14

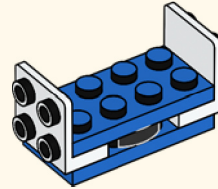

2x

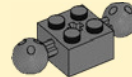

1x

15

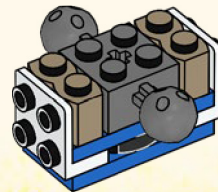



1x



2x

16

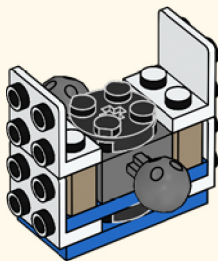

1x



1x

17

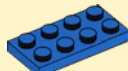
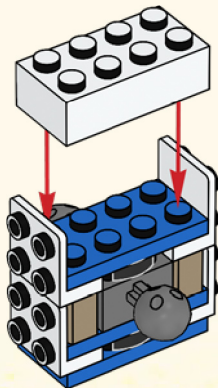

1x

18

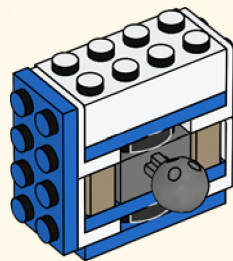

19

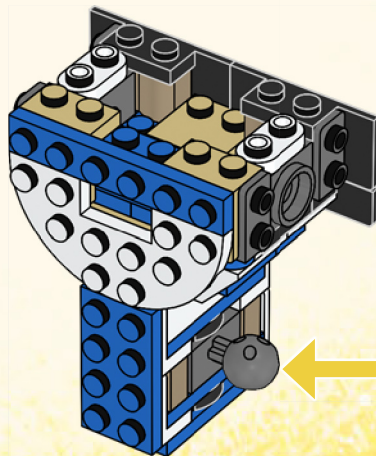



1x



1x

20

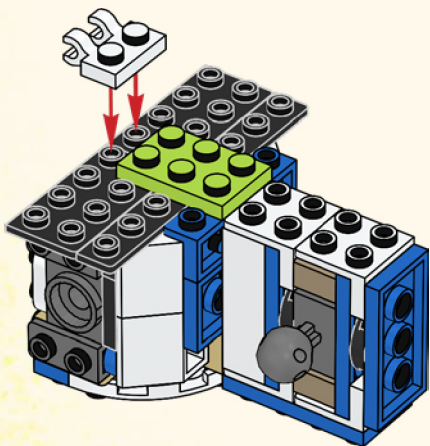

1x



1x

21

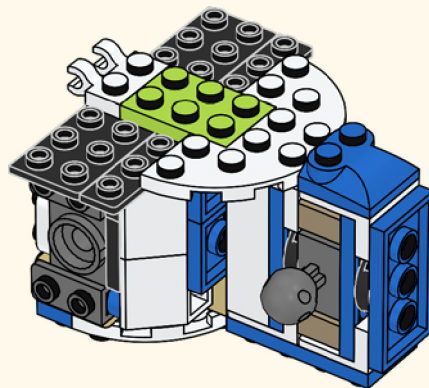



2x



1x

22

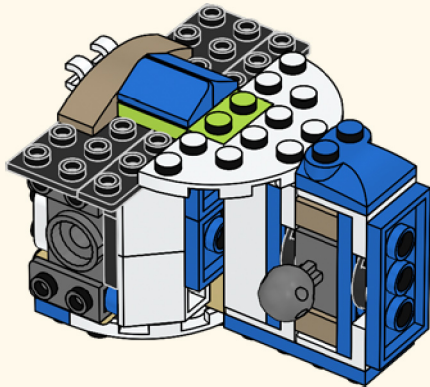

1x



1x



2x

23

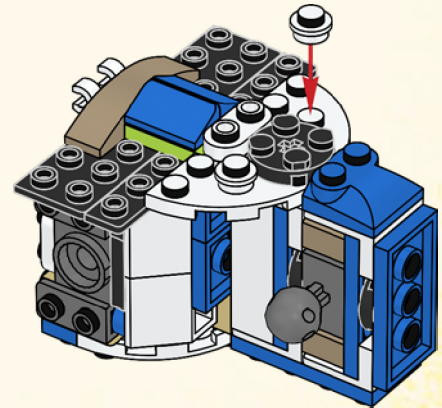



4x

24

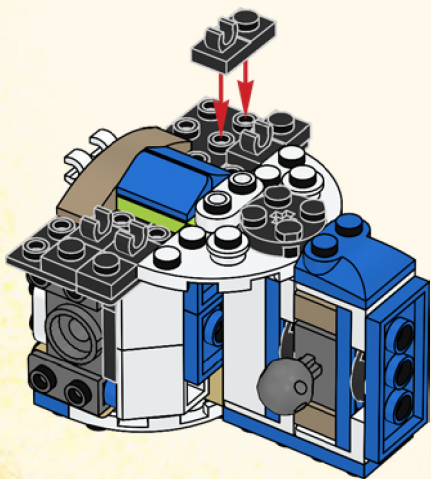

1x



2x



1x



1x

25

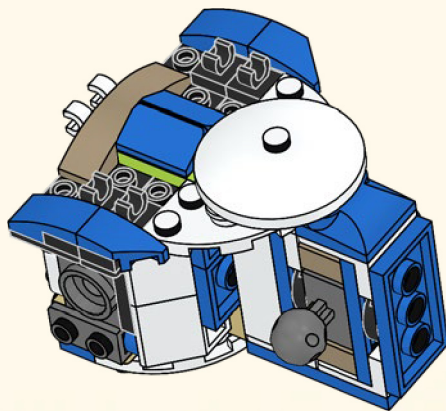

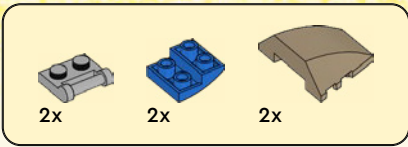

26

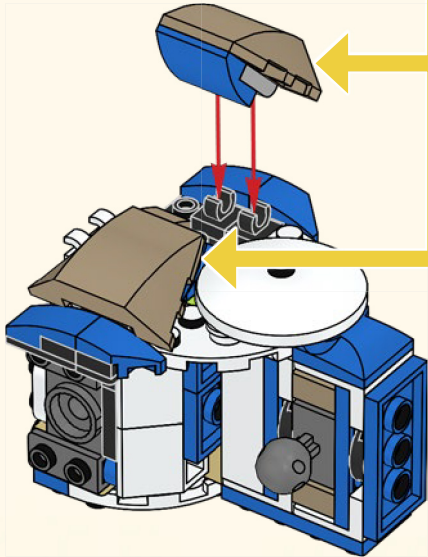
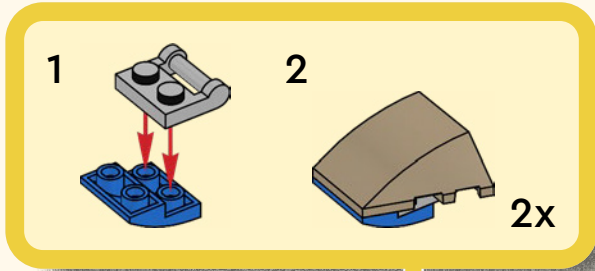

27

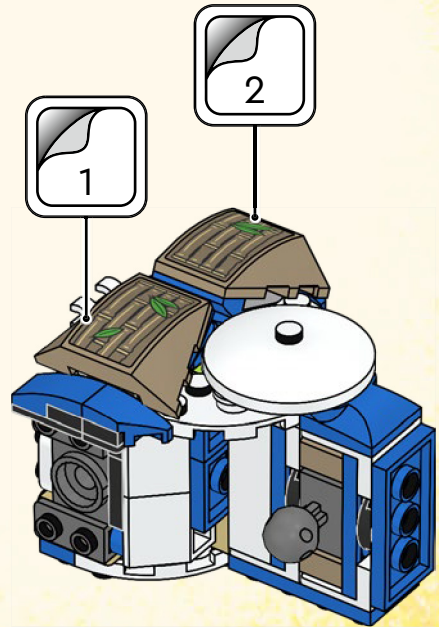



28

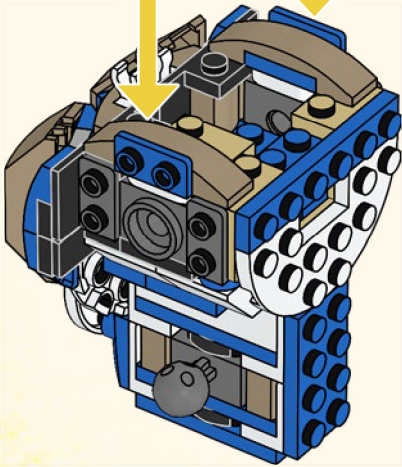
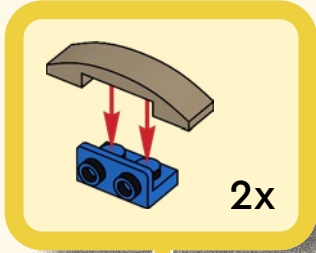

29

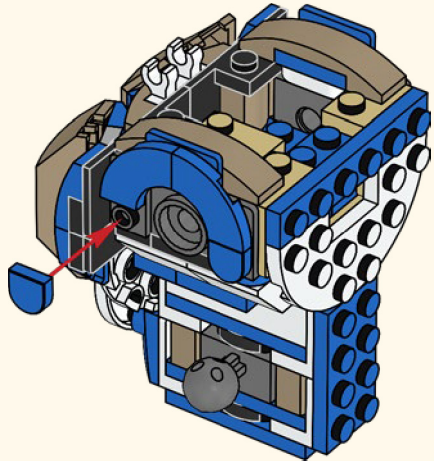

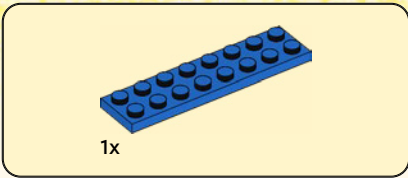

30

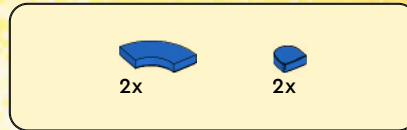
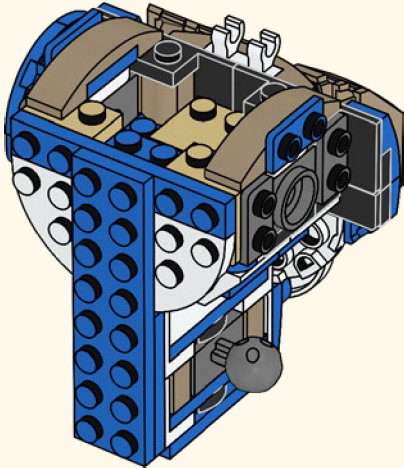

31

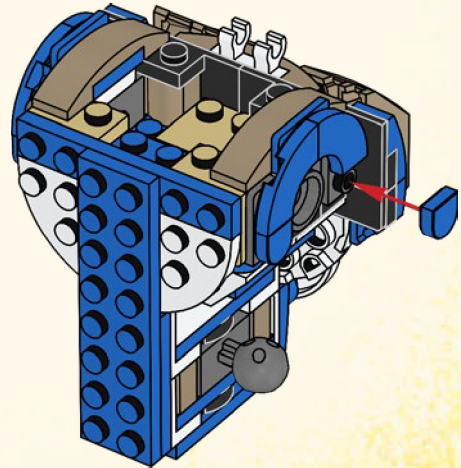



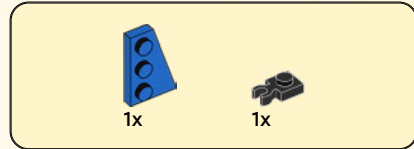
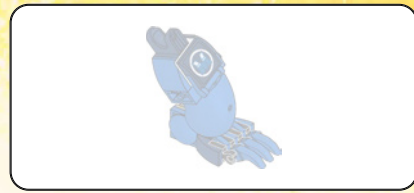

32

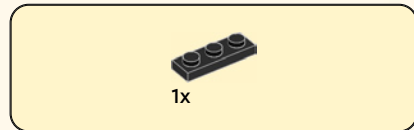
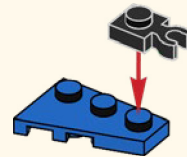

33

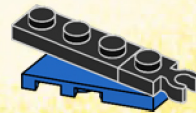



1x

34

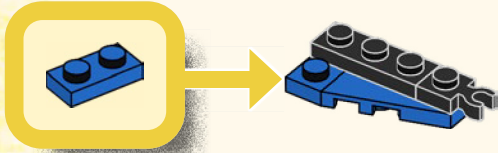

2x



1x

35

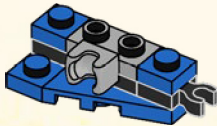

1x



1x



1x

36

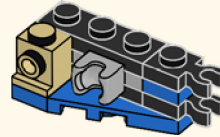

1x



1x

37

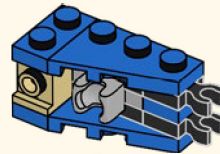



38

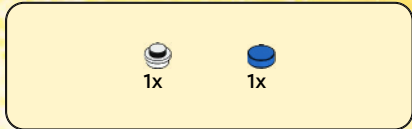
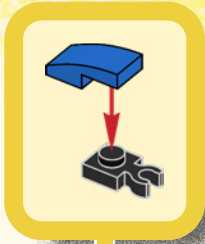
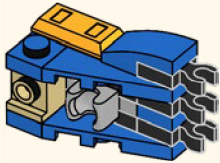

40

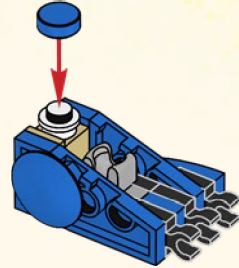

39

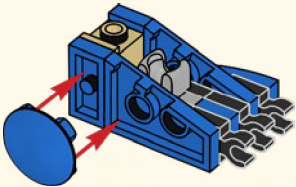

41

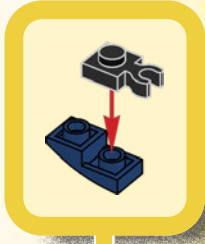
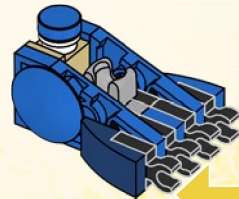

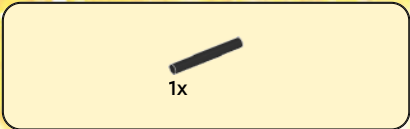

42

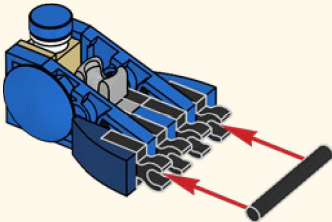

43

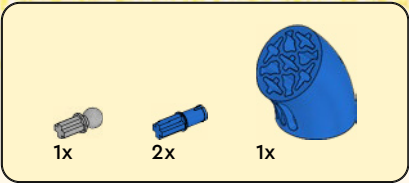
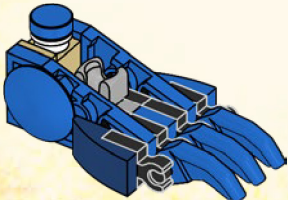

44

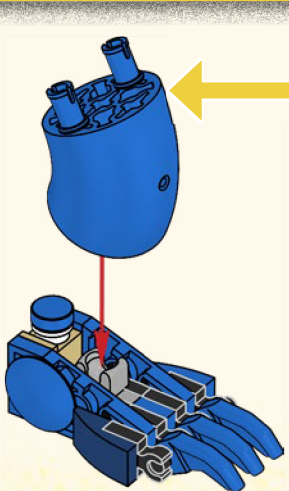
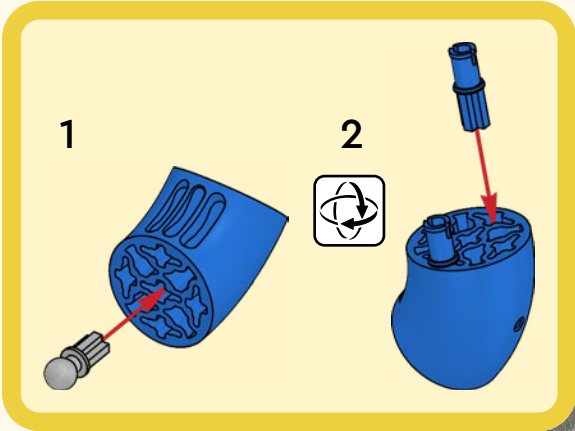

5

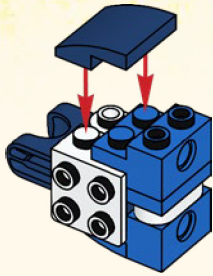

1

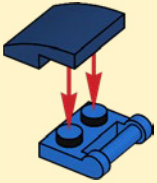

2



6

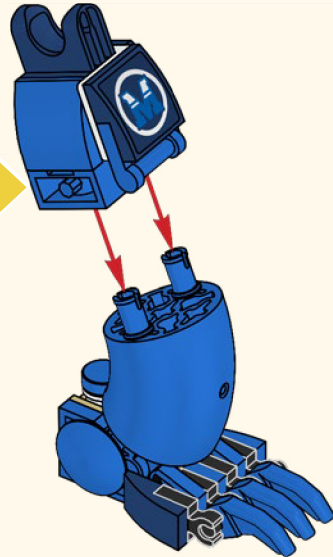

46

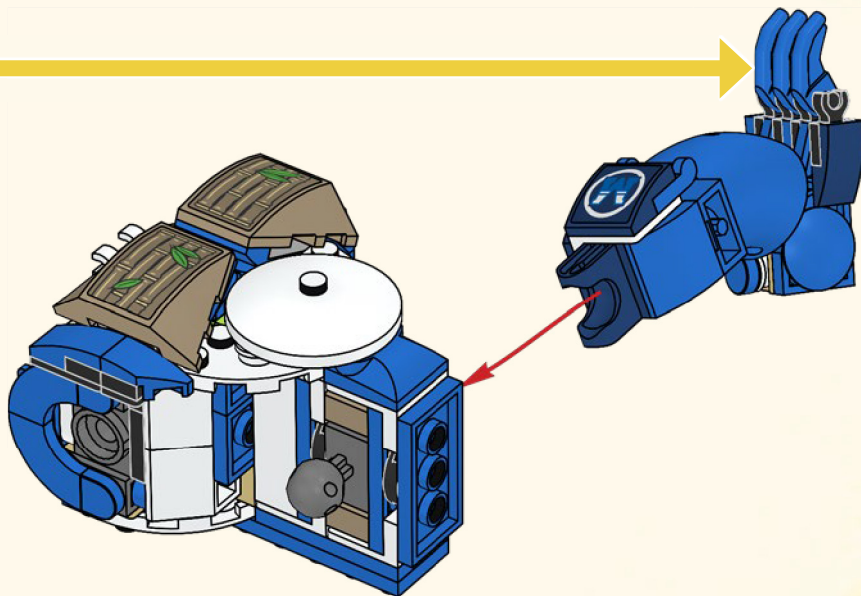

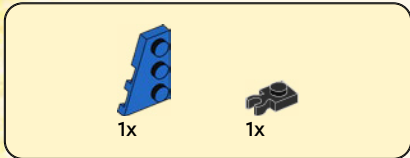
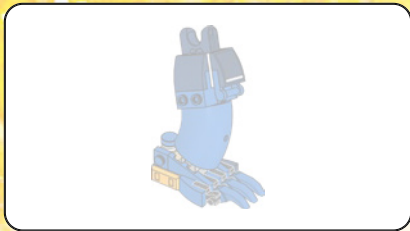

47

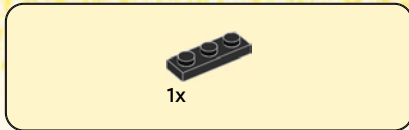
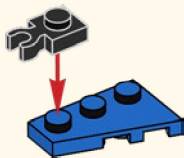

48

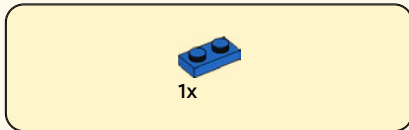
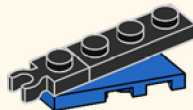

49

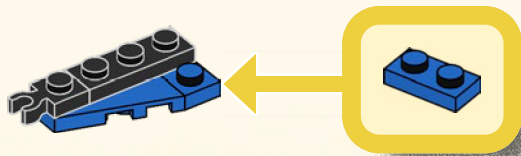



2x



1x

50

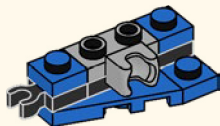

1x



1x



1x

51

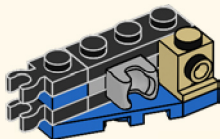

1x



1x

52

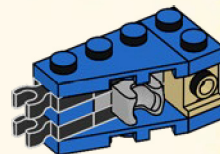

1x



1x



1x

53

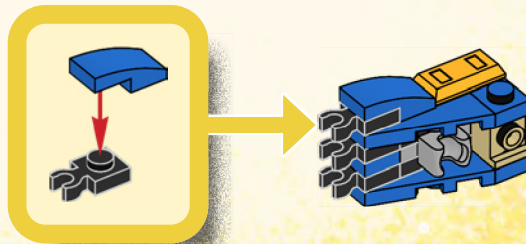



1x

54

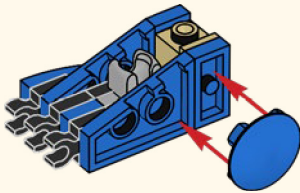

1x



1x

55

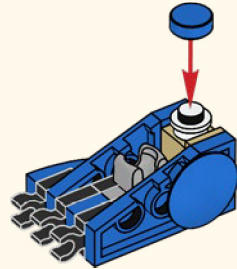

1x



1x

56

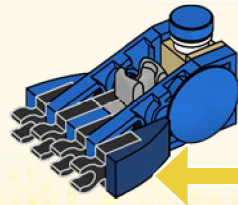
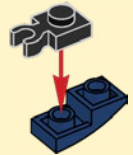

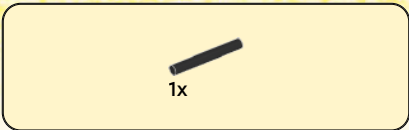

57

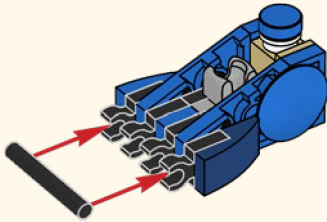

58

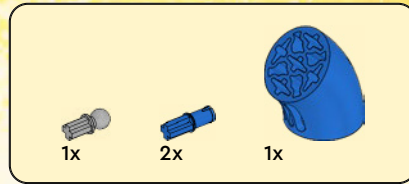
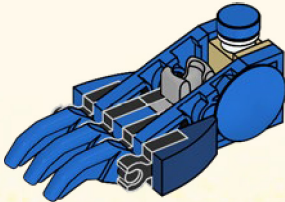

59

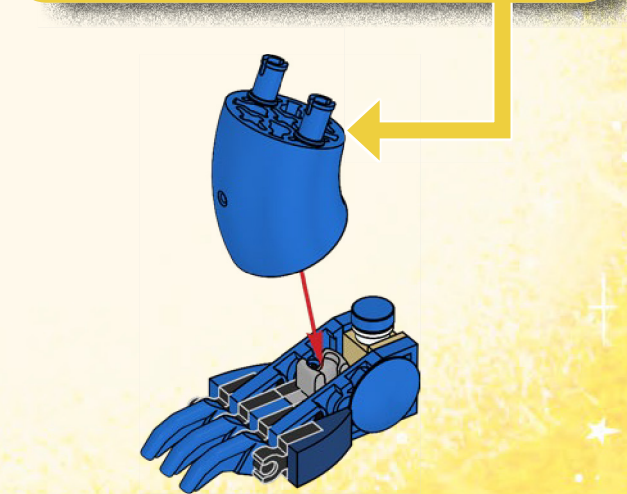
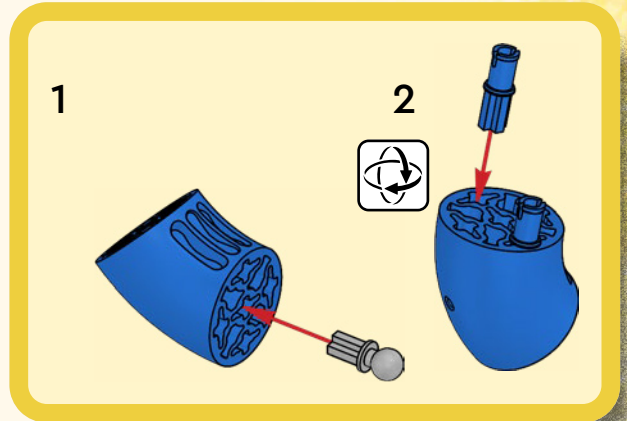

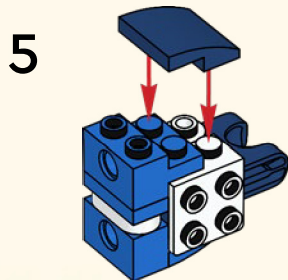
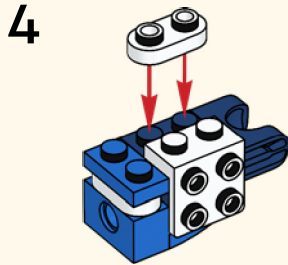

6

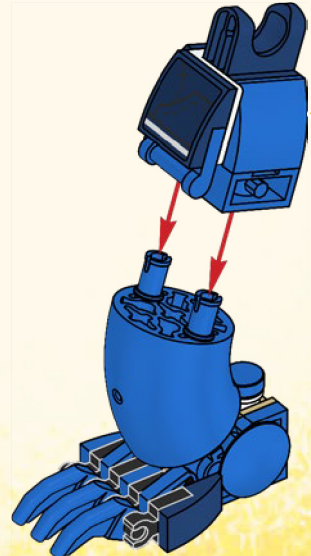
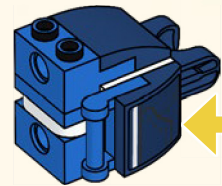
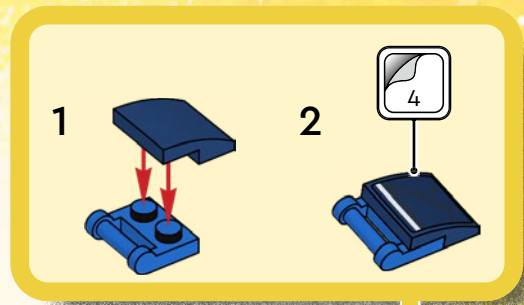

61

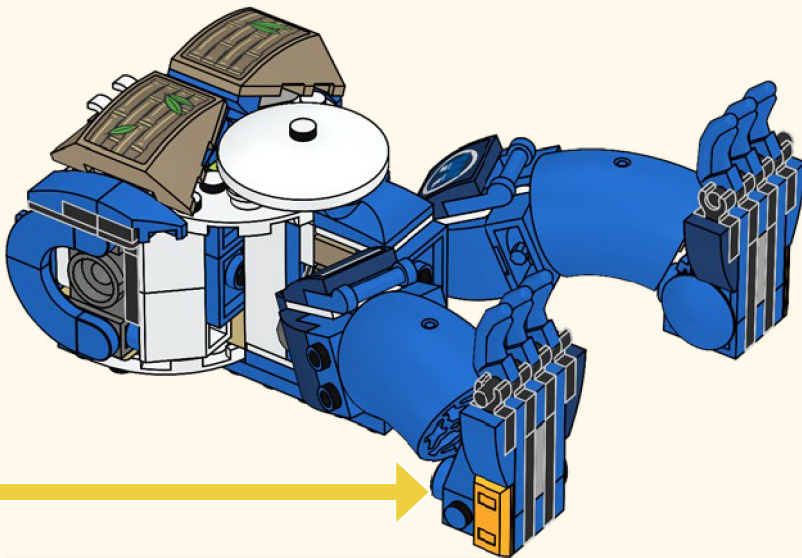



62

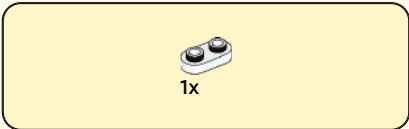
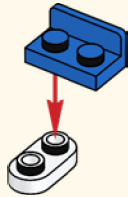

63

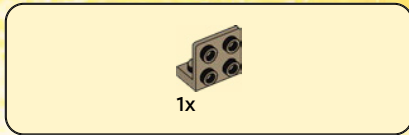

64

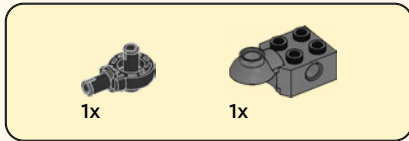

65

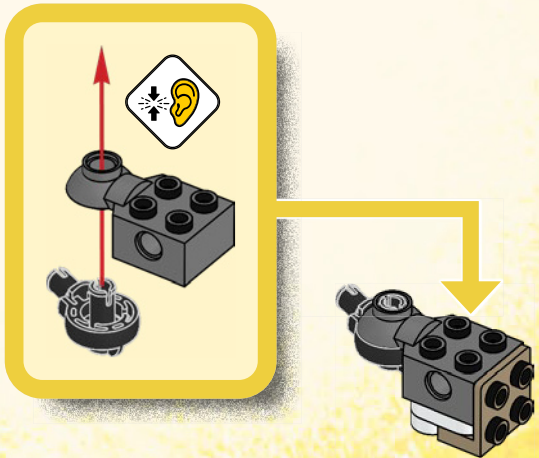



1x



1x

66

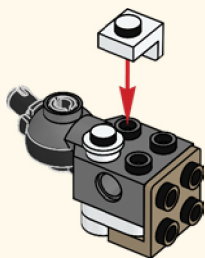

1x

67

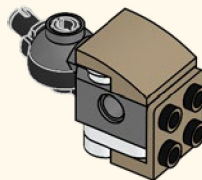

68

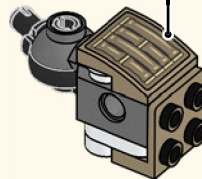



1x

69

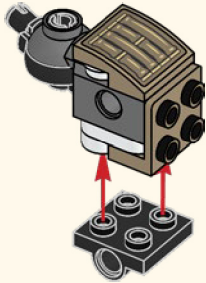

1x

70

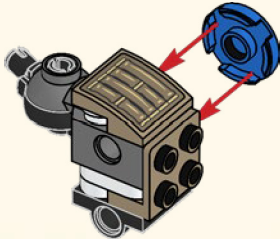

1x



3x

71

1

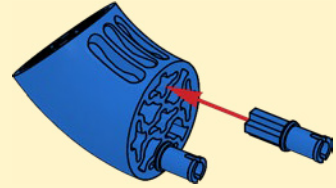

2

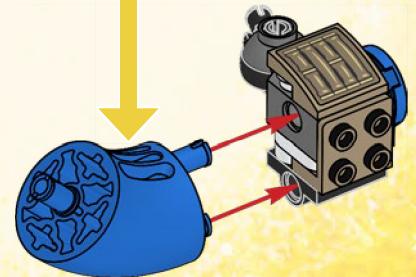
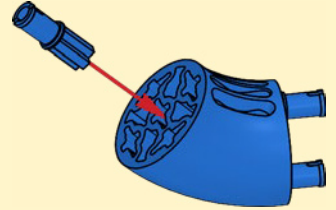



1x



1x

72

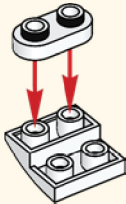

1x



1x

73

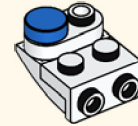

2x

74

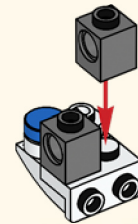



1x



1x

75

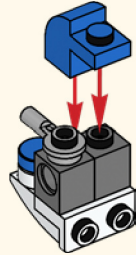

1x

76

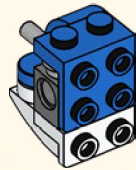

1x



3x

77

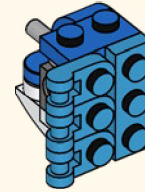

4x

78

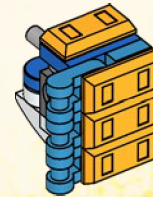



4x

79

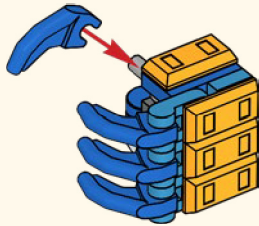

80

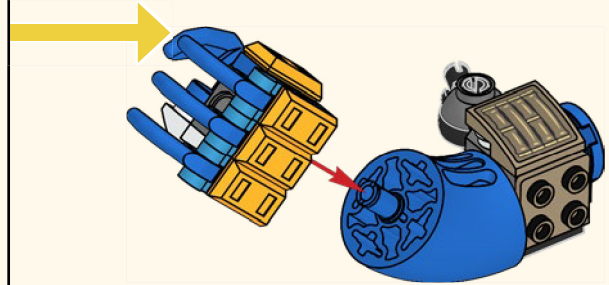

81

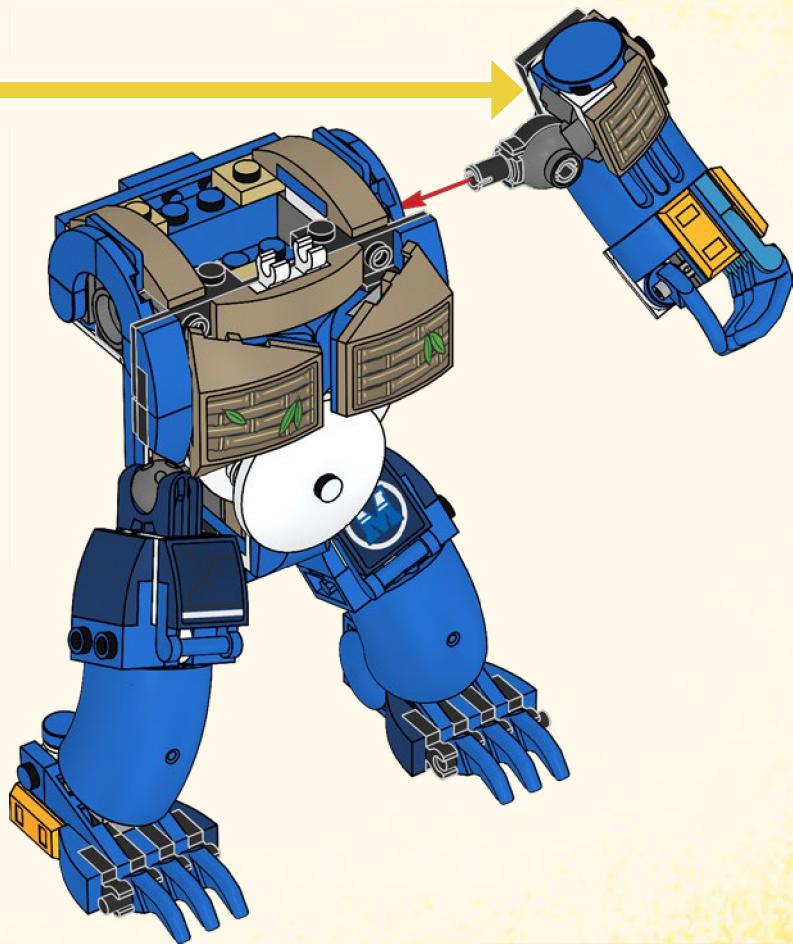

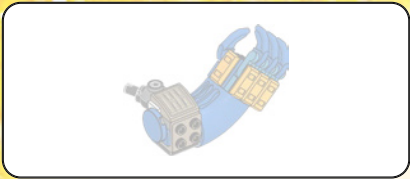

82

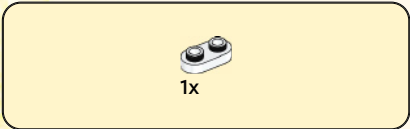
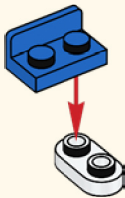

83

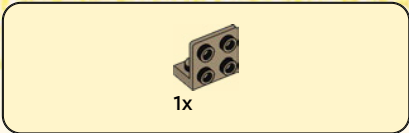

84

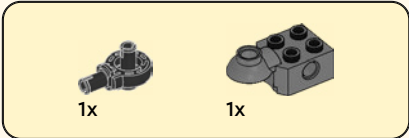

85

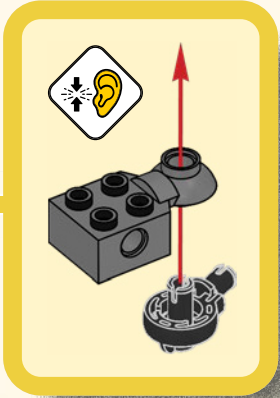
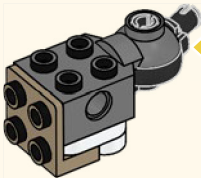



1x



1x

86

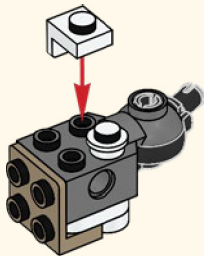

88



3

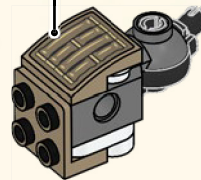

1x

87

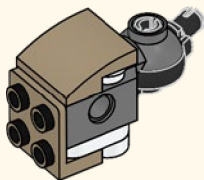

1x

89

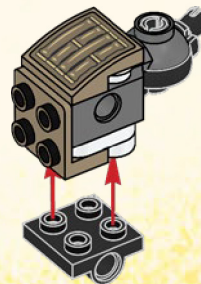

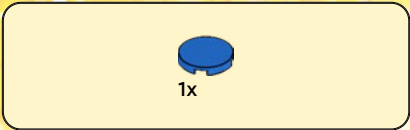

90

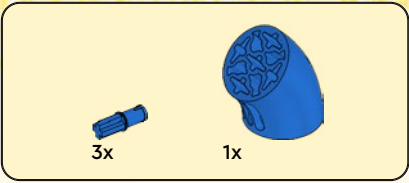
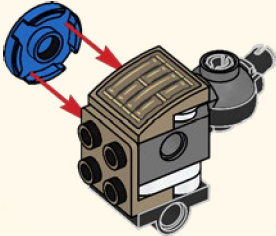

91

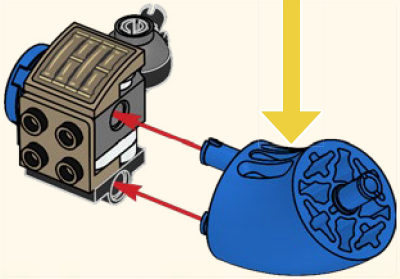
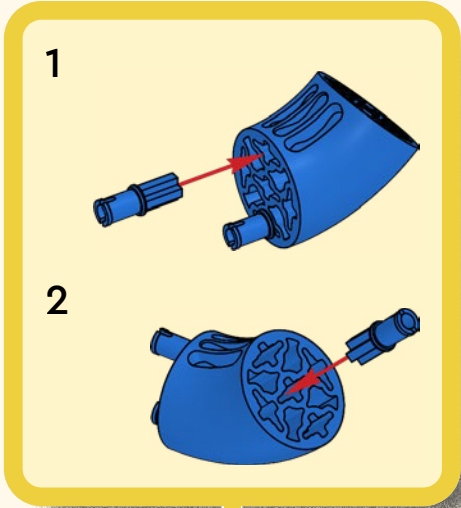



1x



1x

92

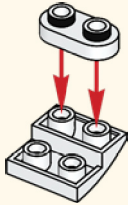

1x



1x

93

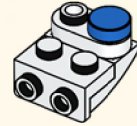

2x

94

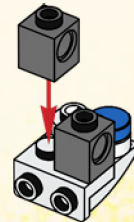



1x



1x

95

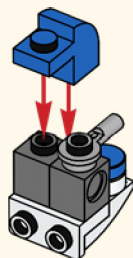

1x

96

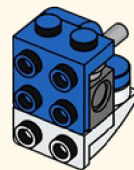

1x



3x

97

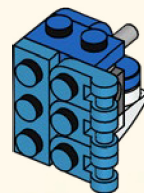



98

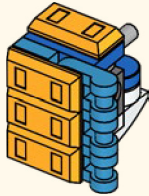

99

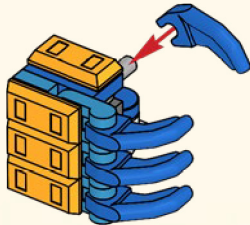

100

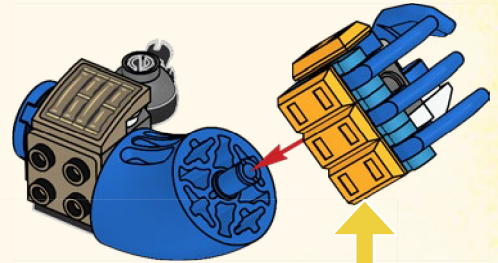

101

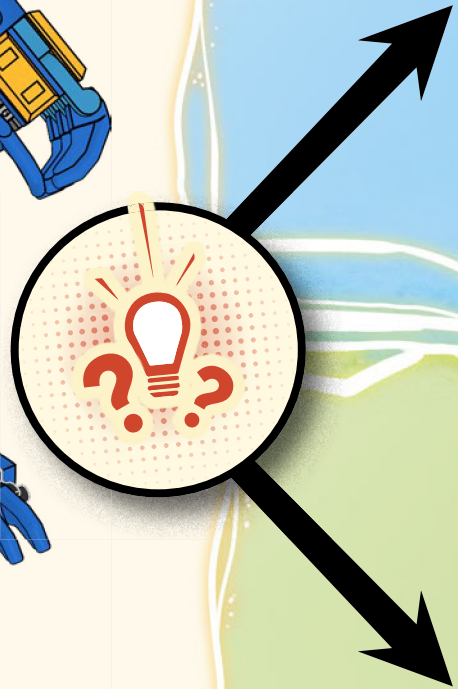
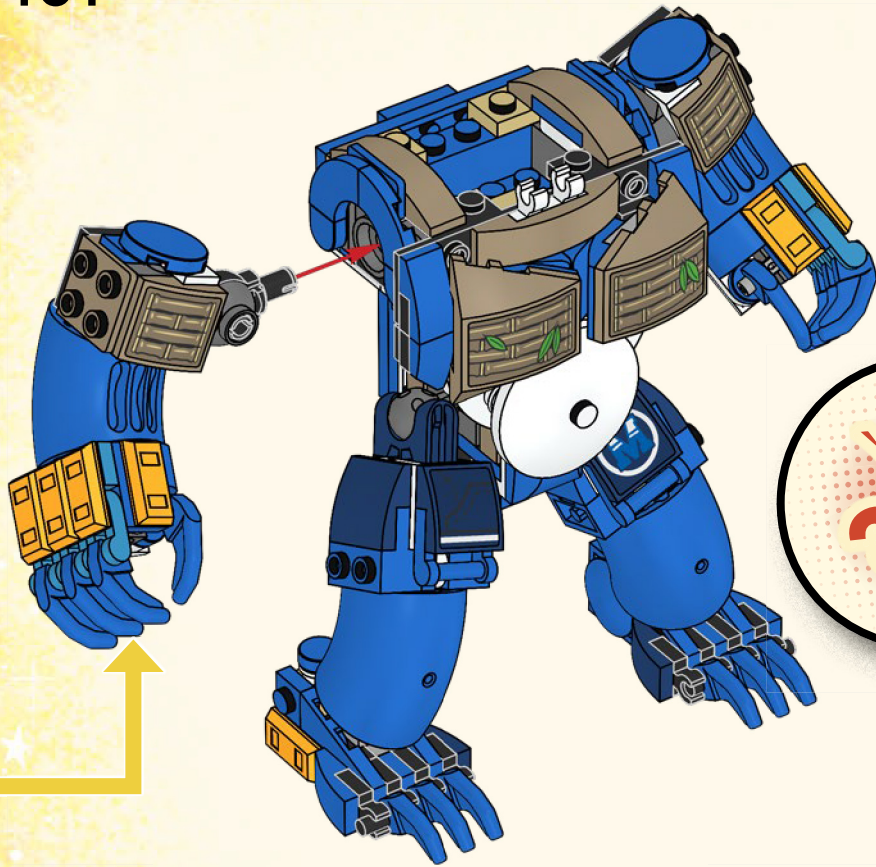





102

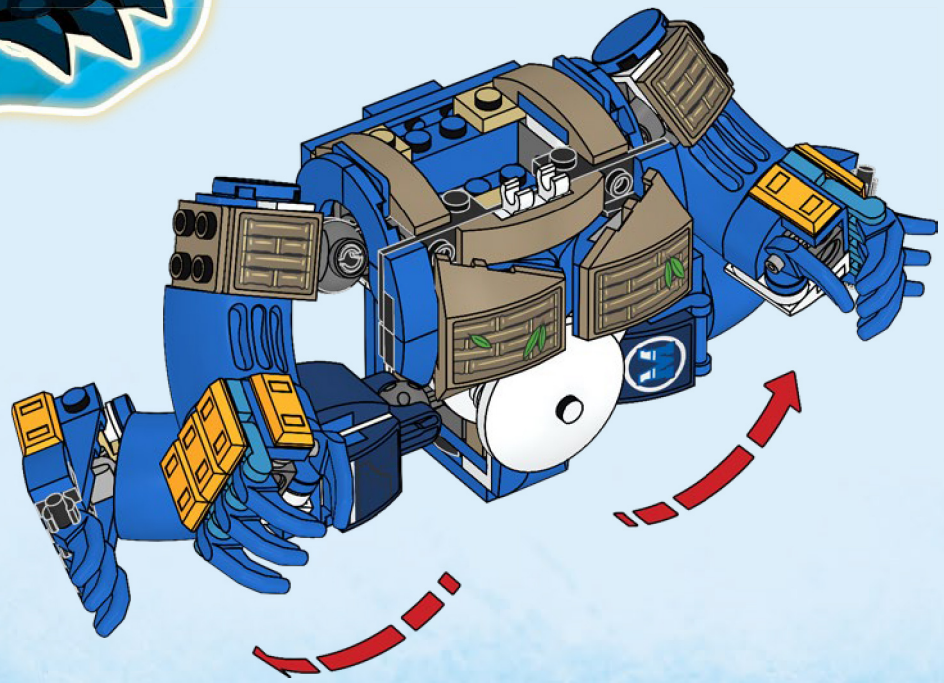



2x



2x

103

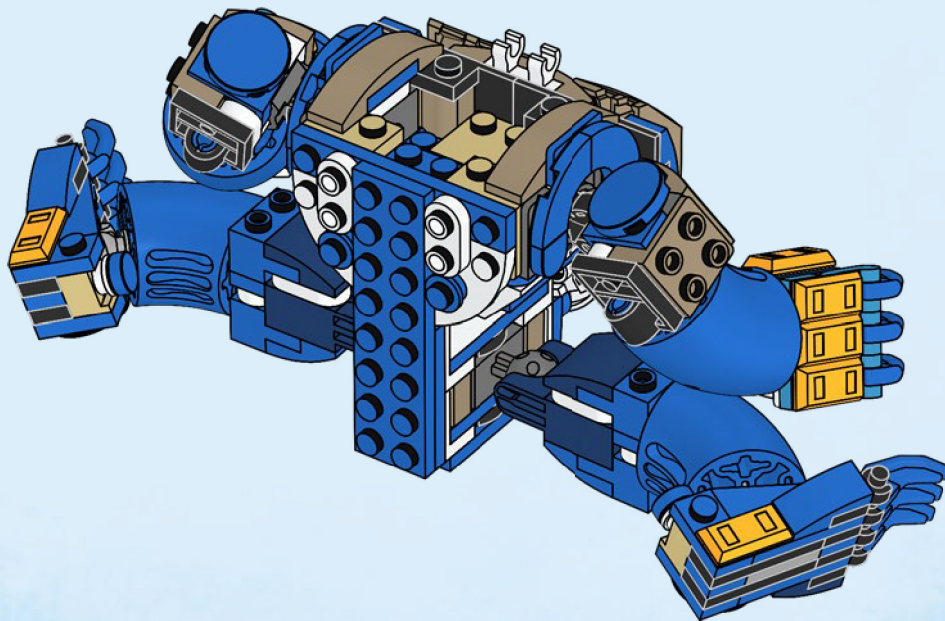

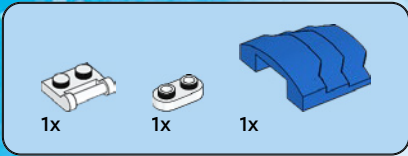

104

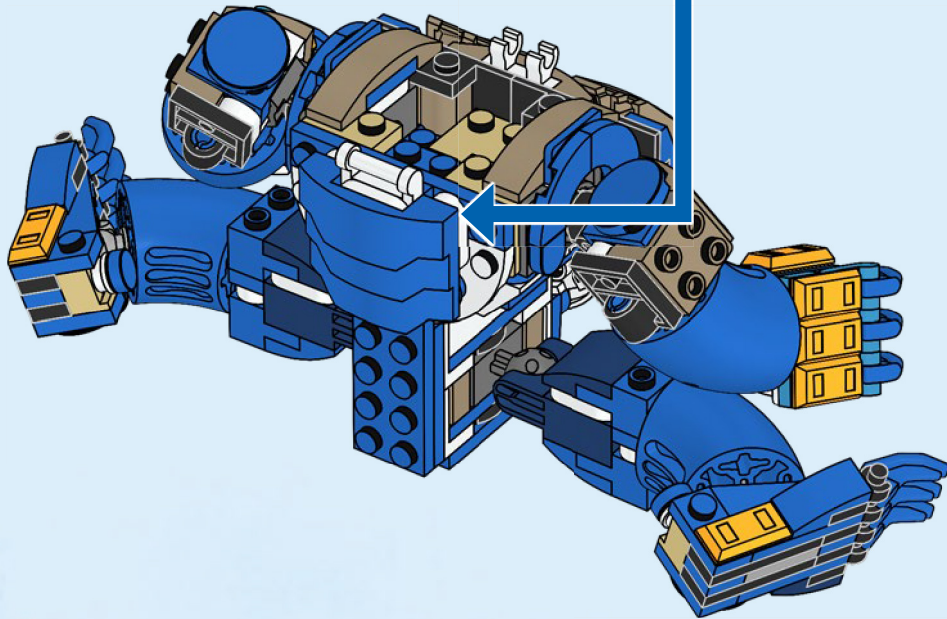
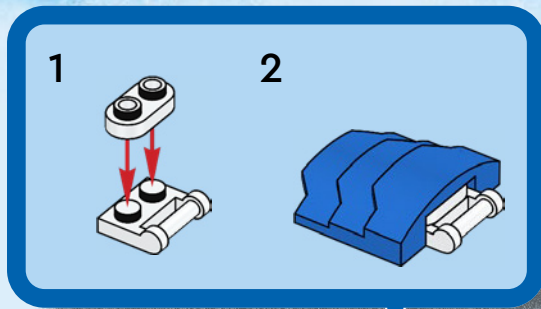



2x



1x

105

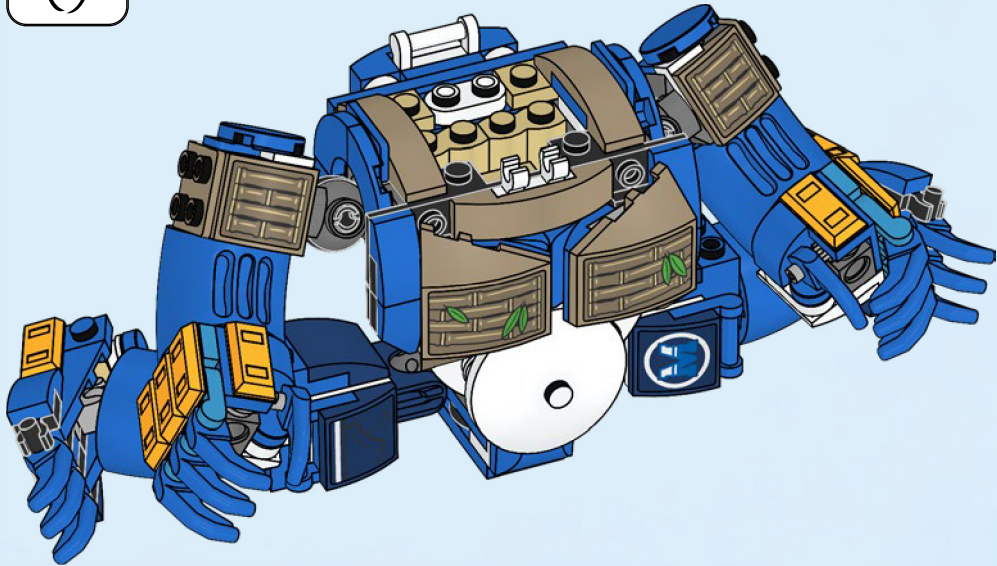



2x

106

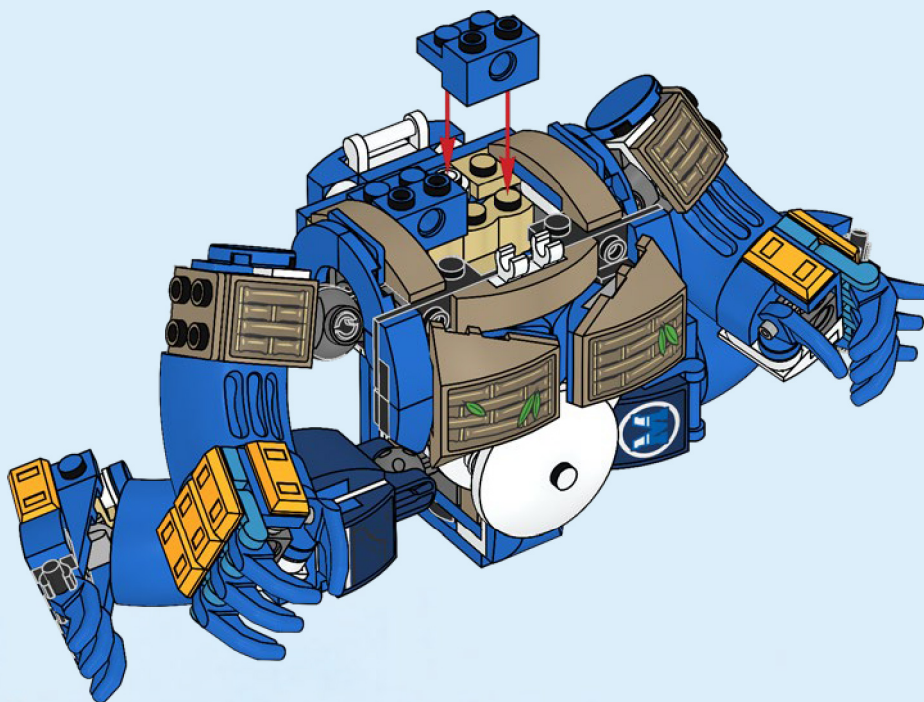



1x

107

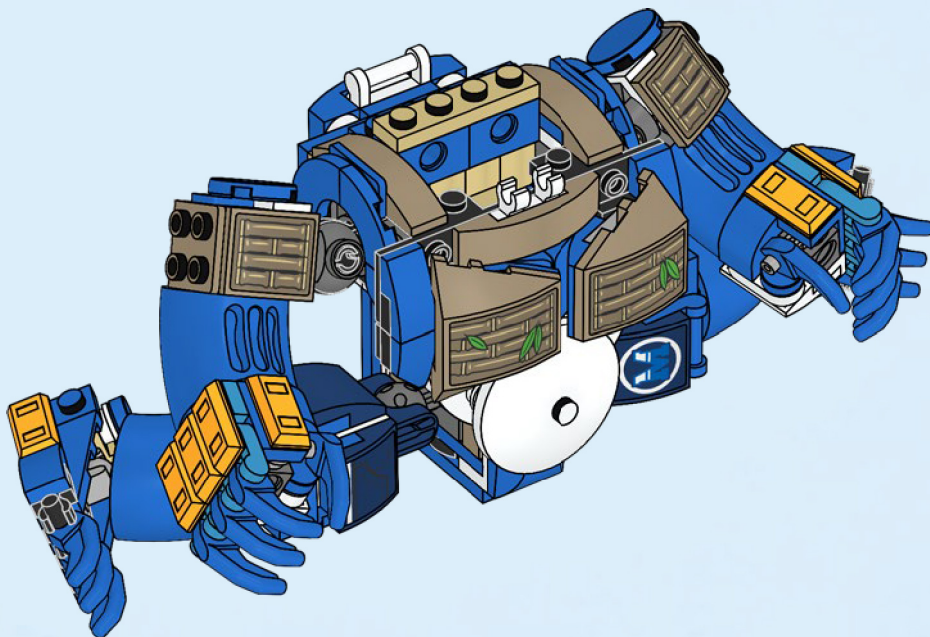

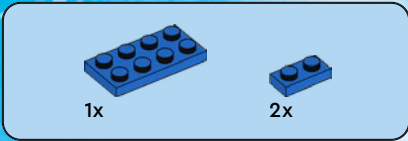

108

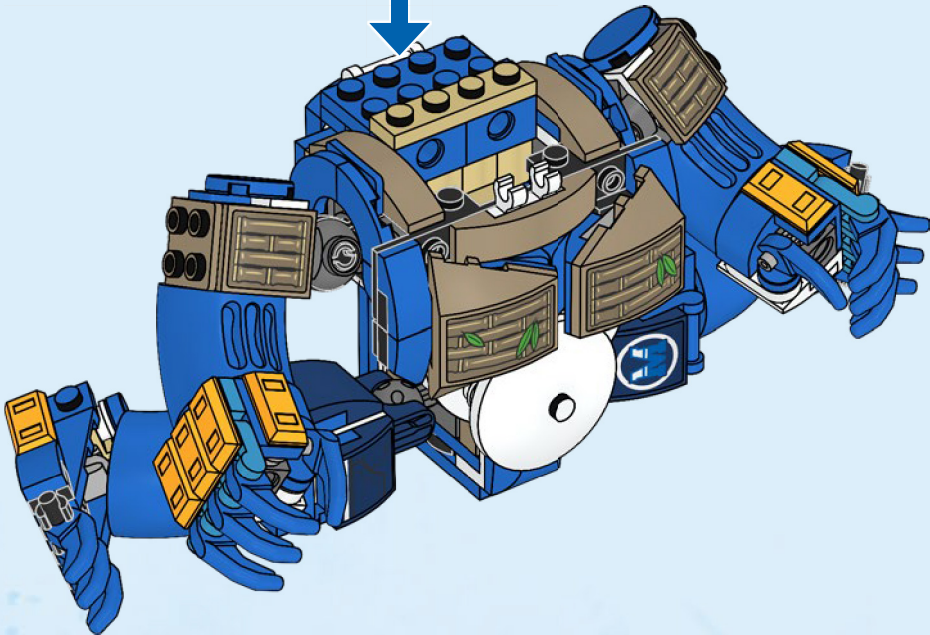
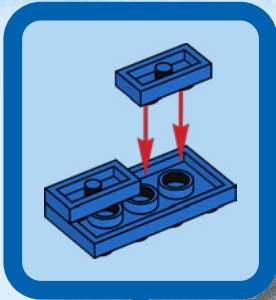



1x



2x

109

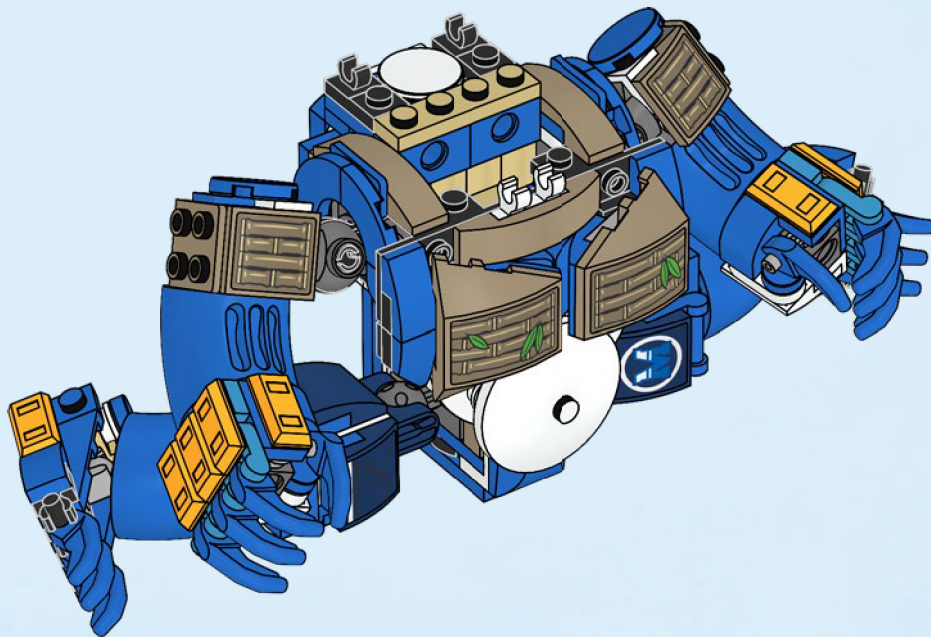



2x

110

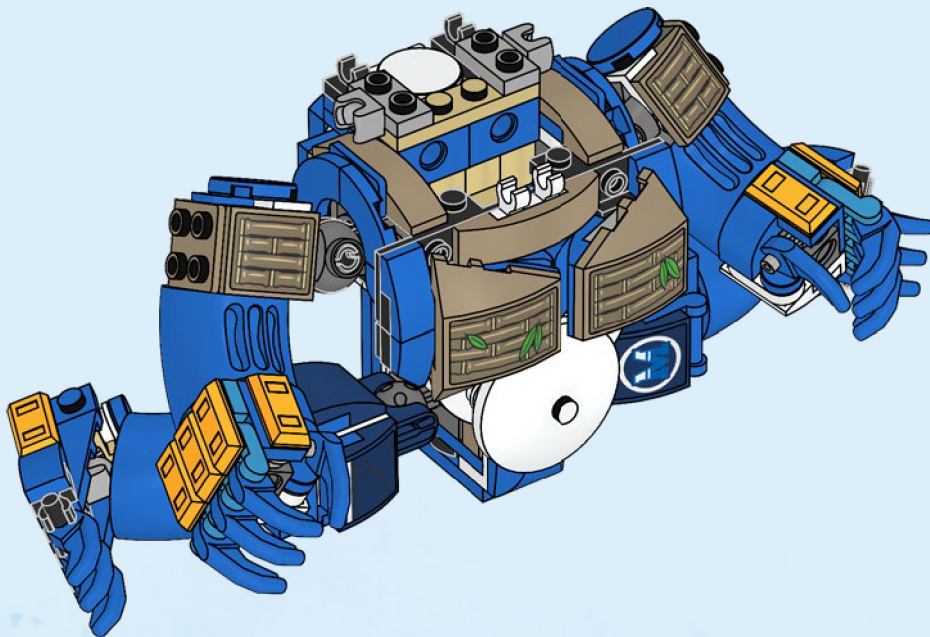



2x

111

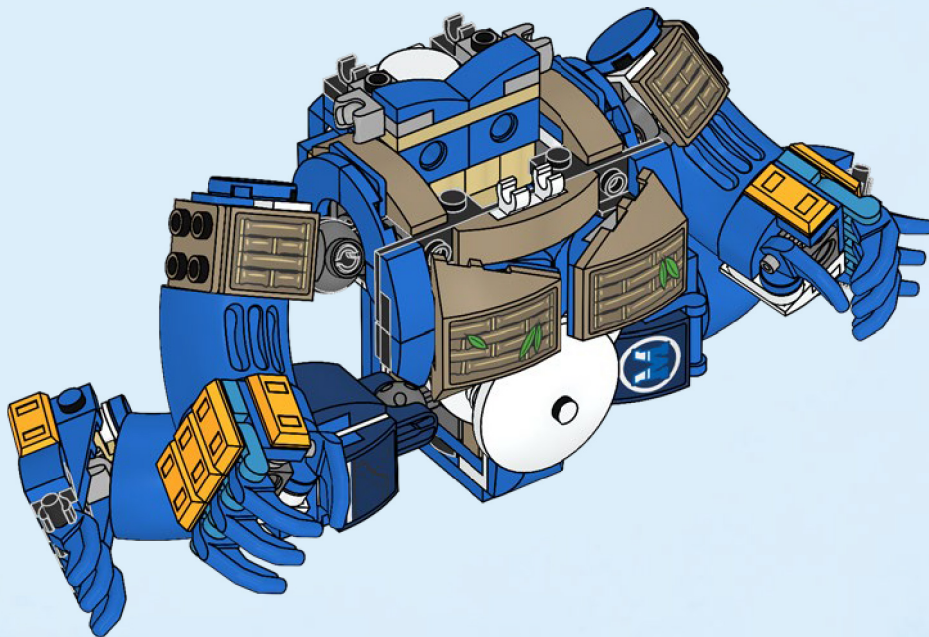



2x



2x

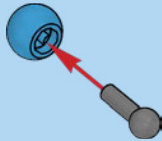

2x

112

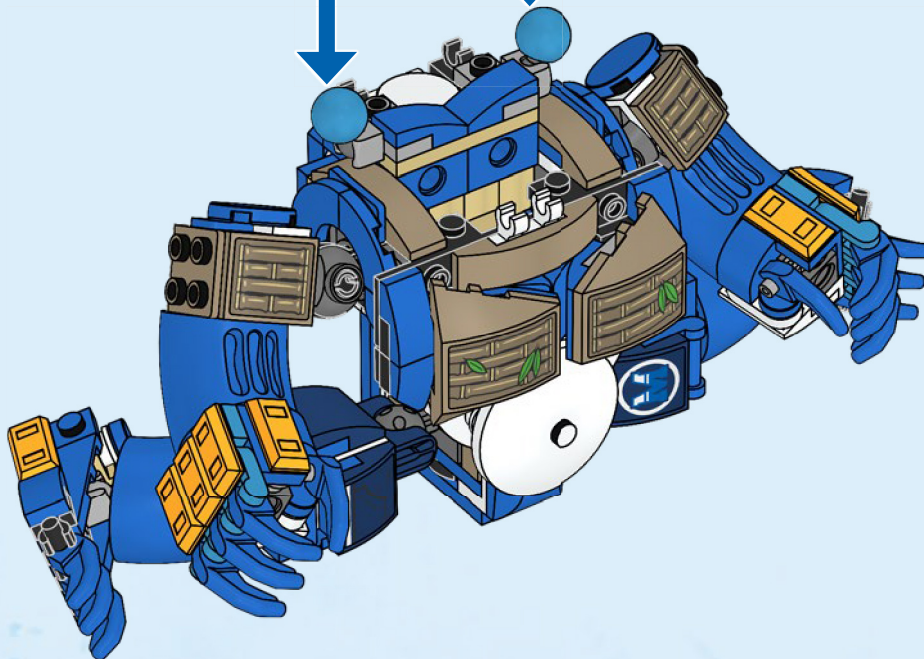

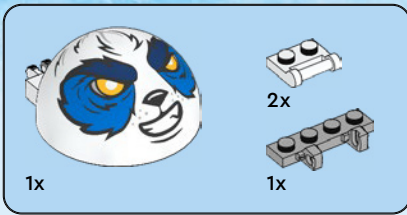

113

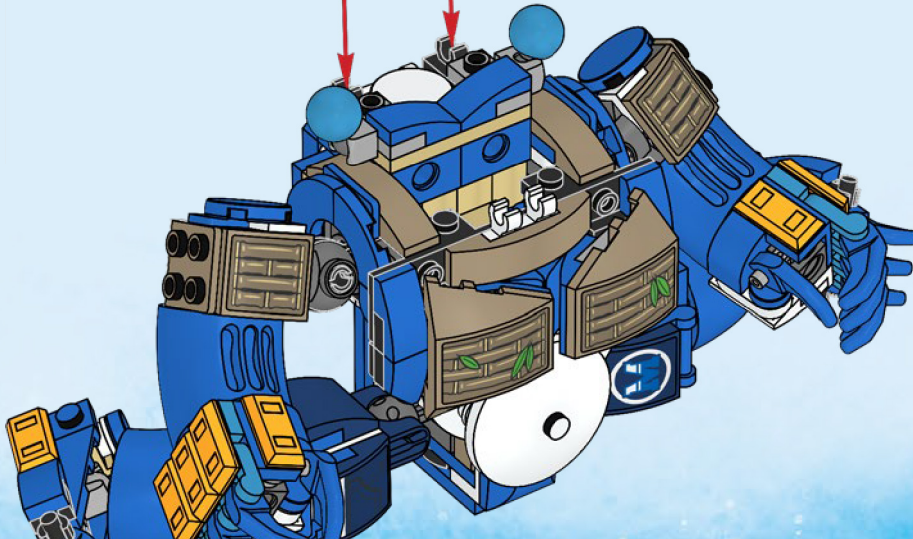
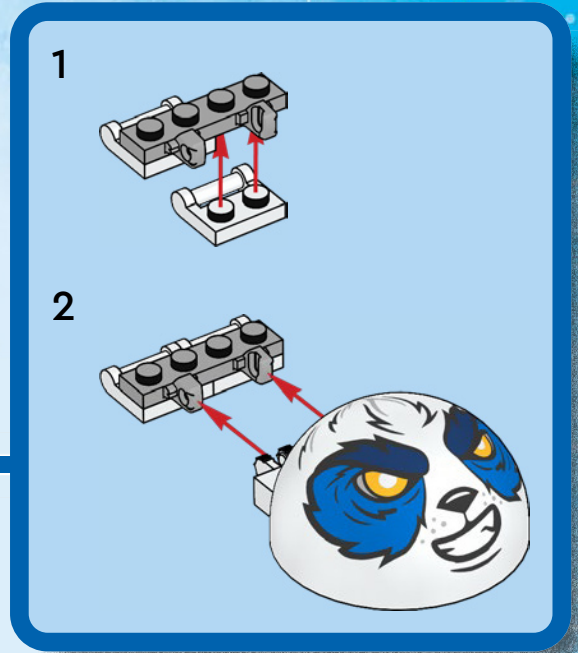
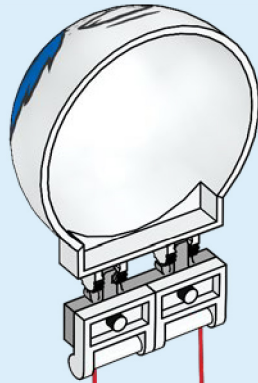

114

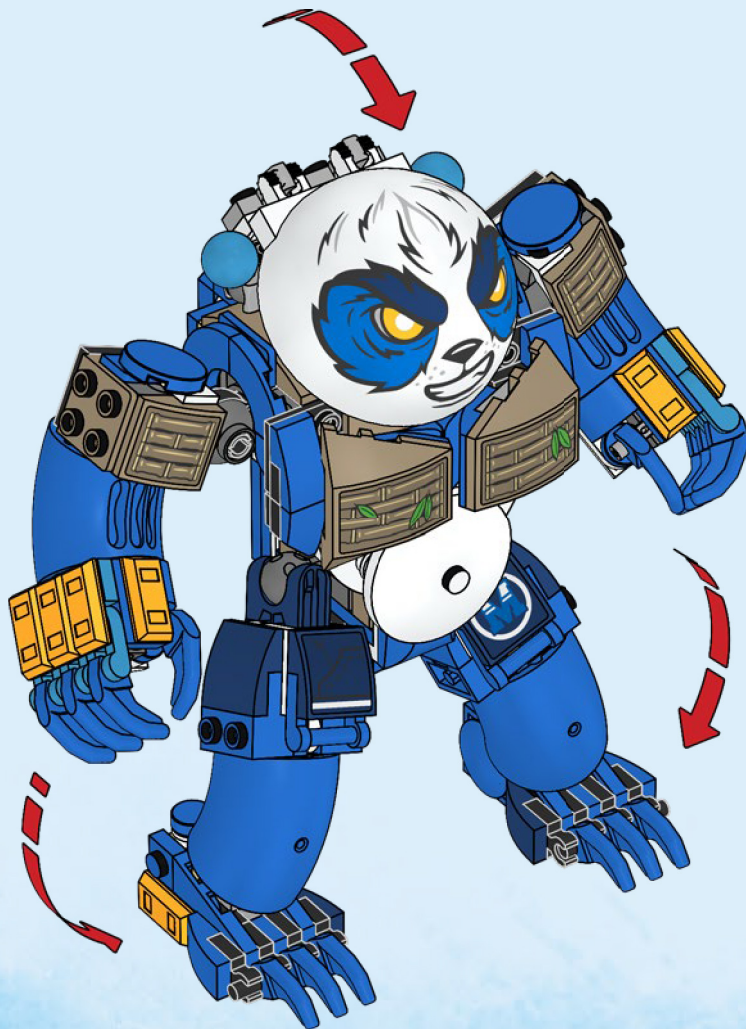

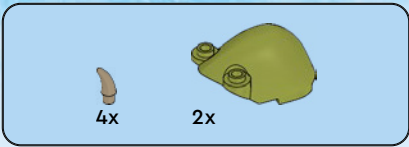

115

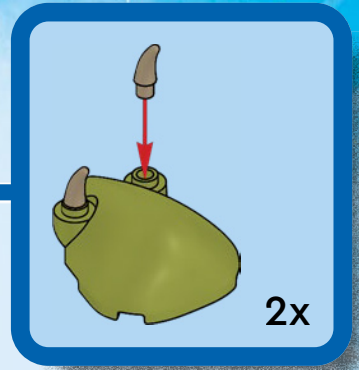

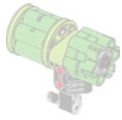

2x



1x

116





117

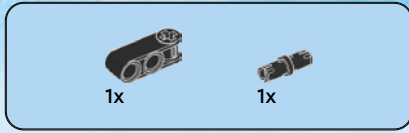
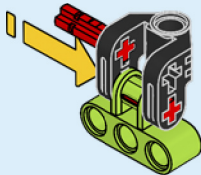

118

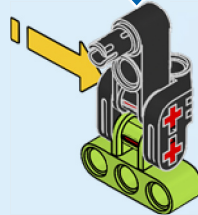
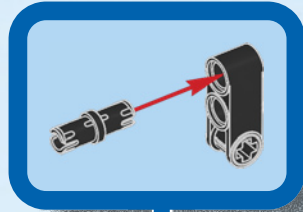

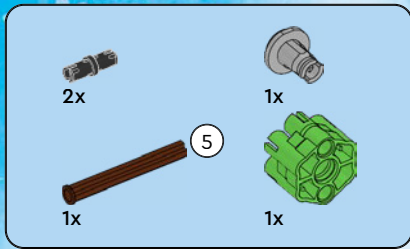

119

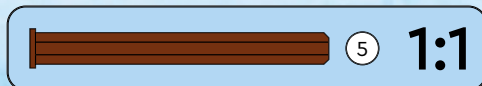
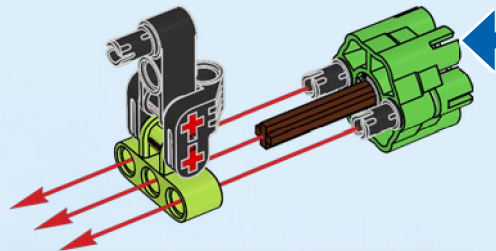
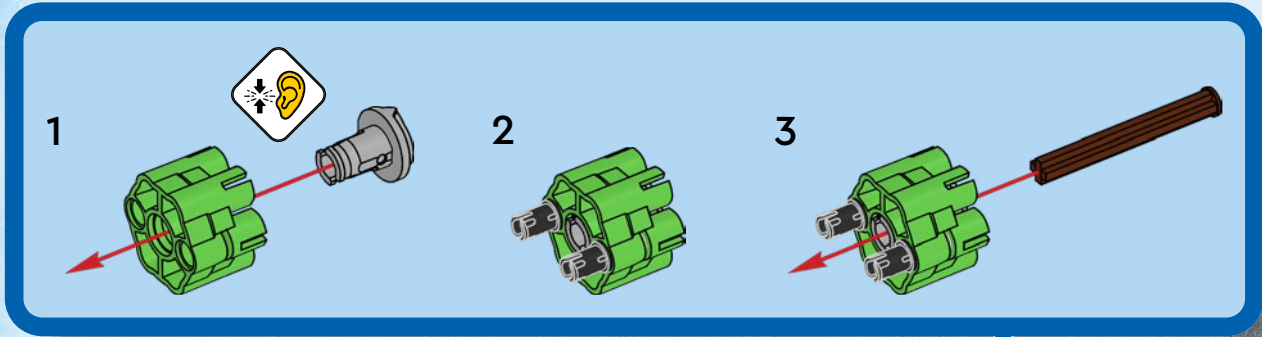

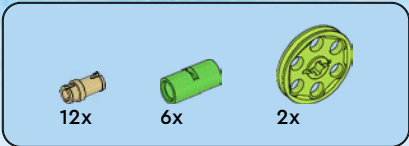

120

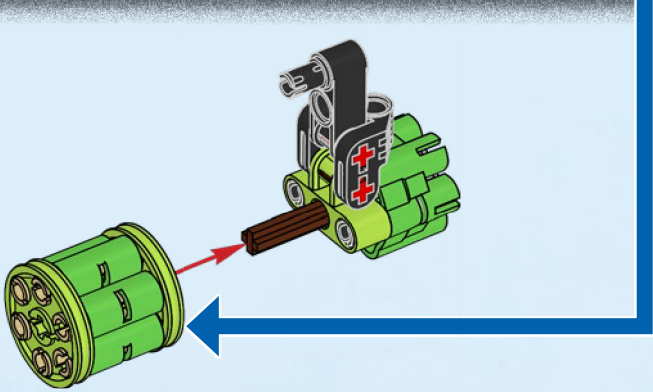
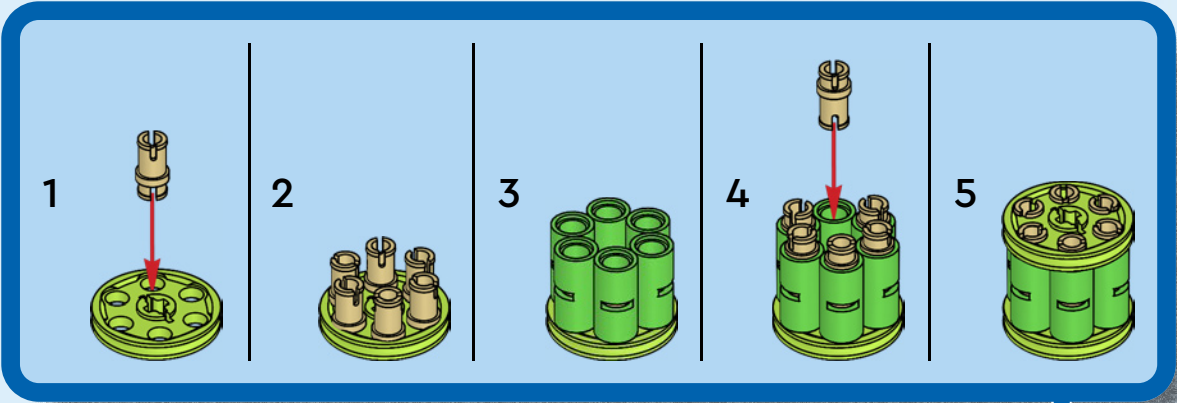

121



12x

122

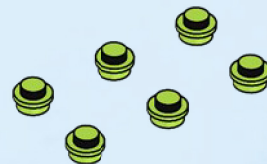







102

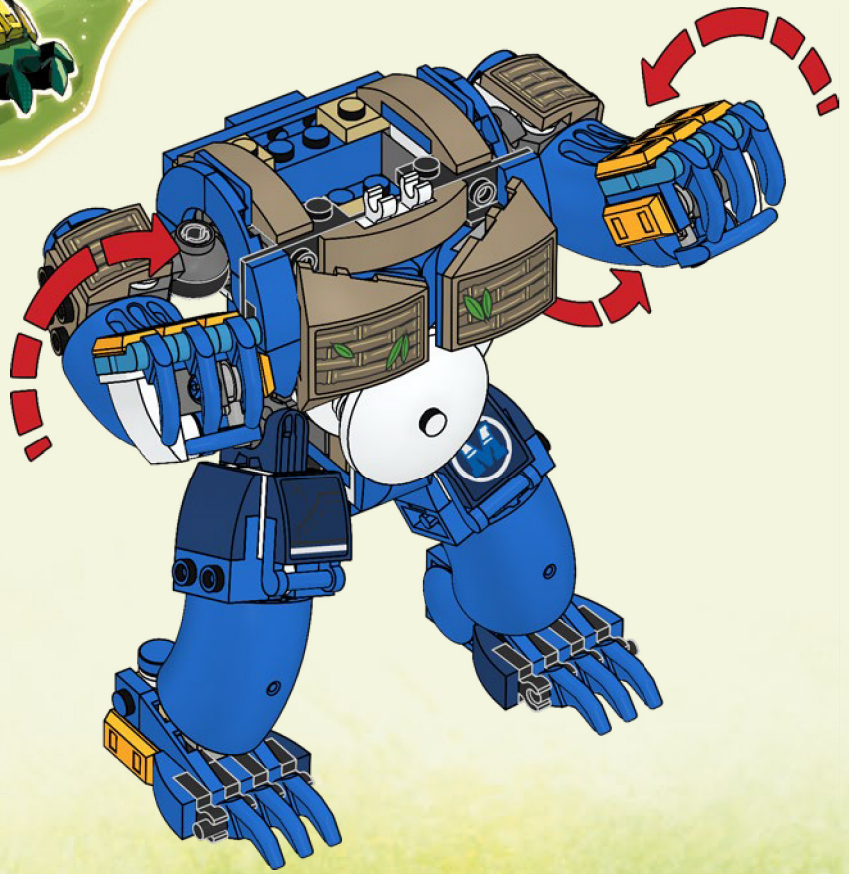

103

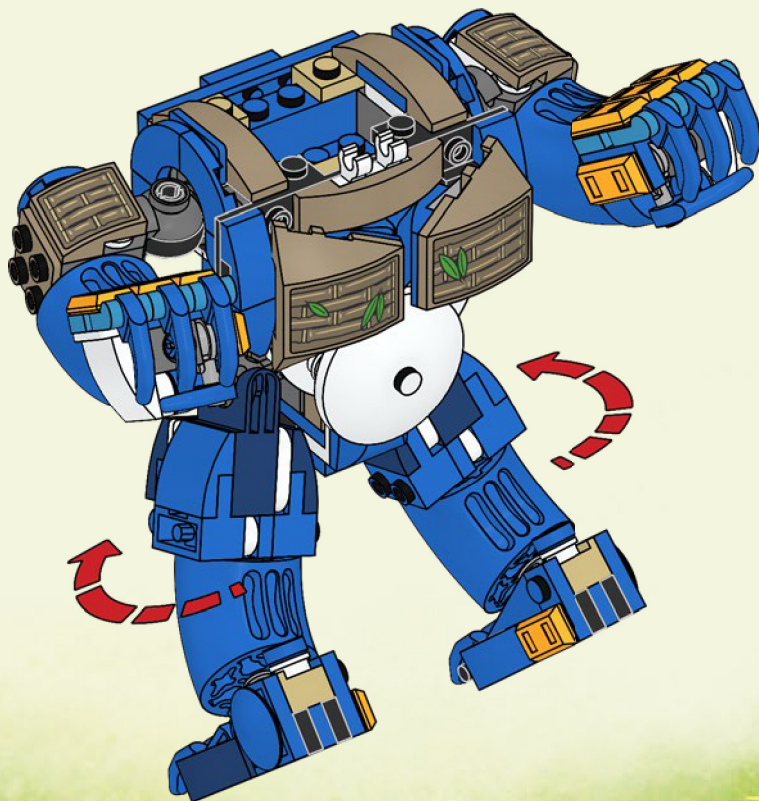

104

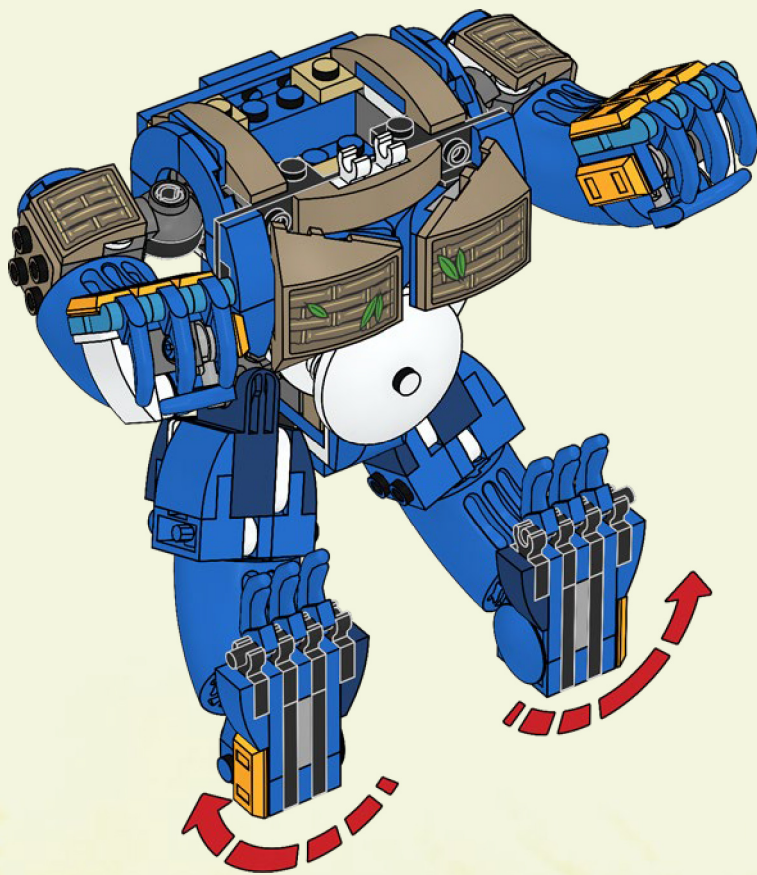

105

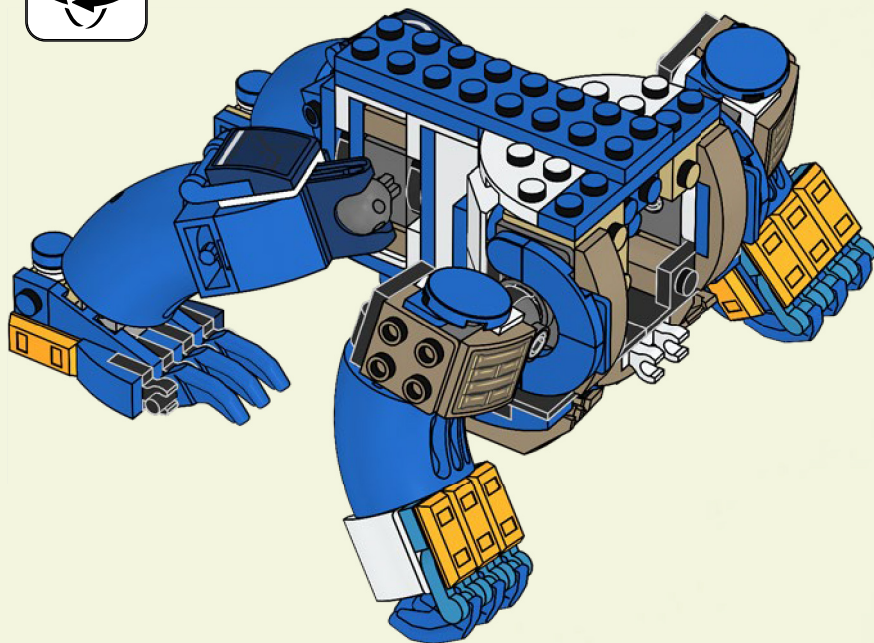

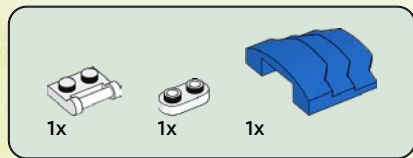
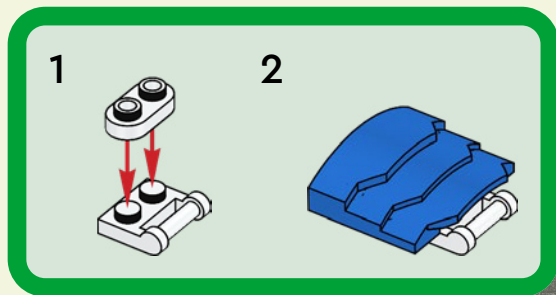

106

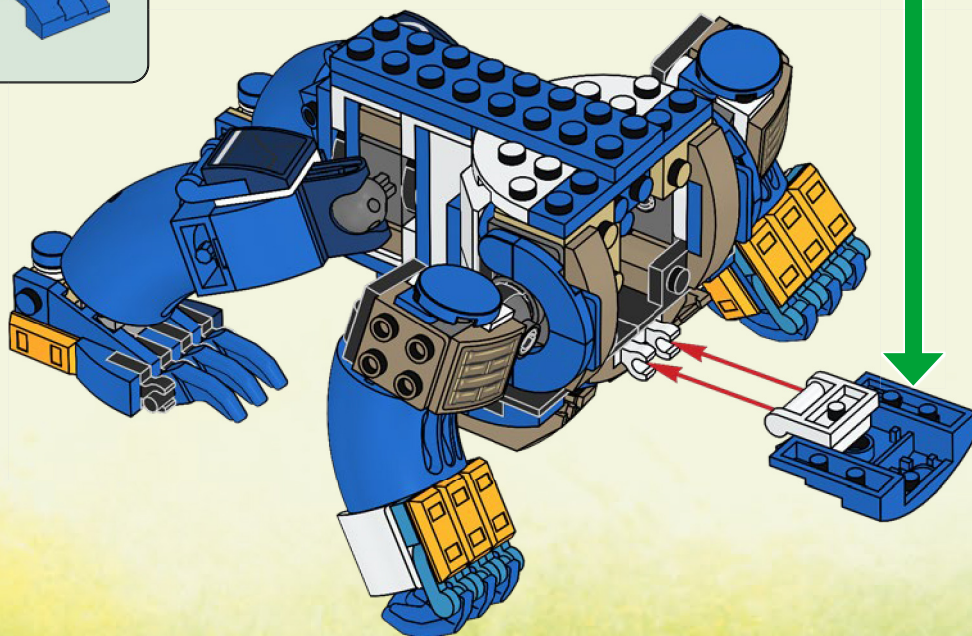



2x



2x

107

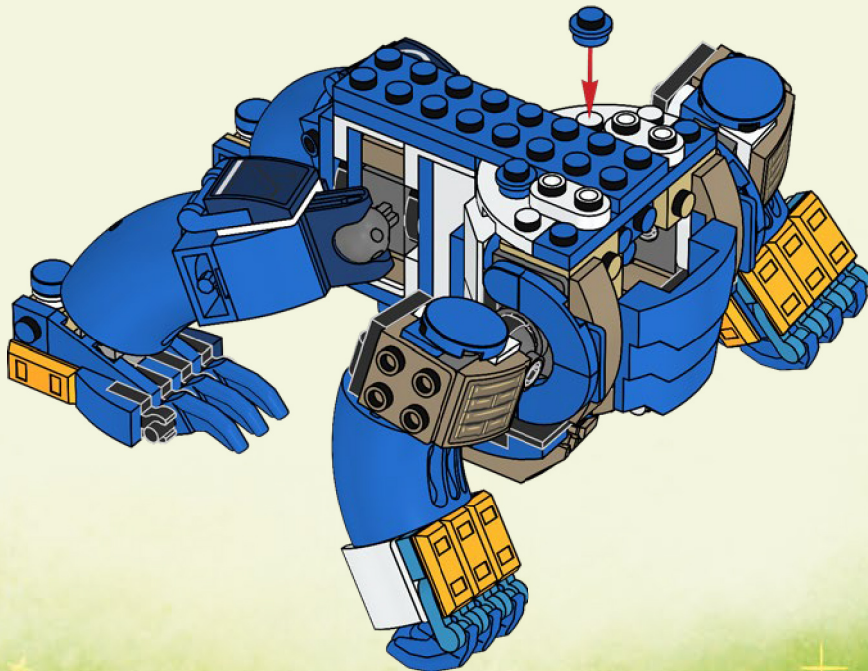



1x



1x



2x

108

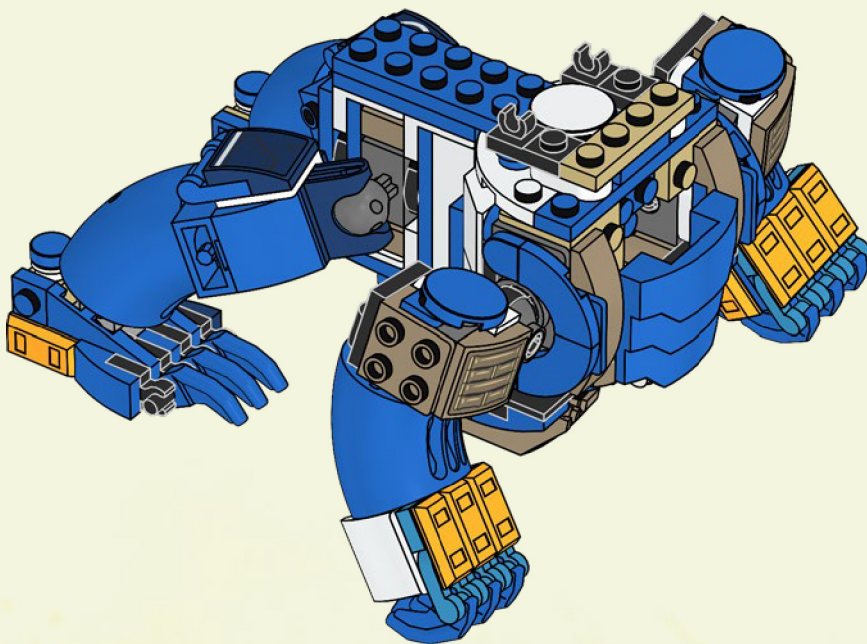



2x

109

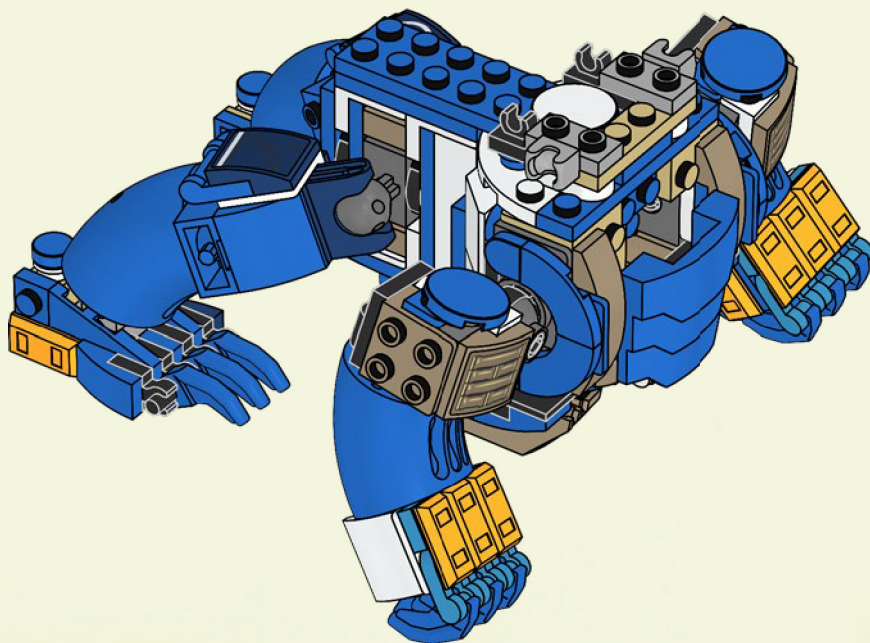



2x

110

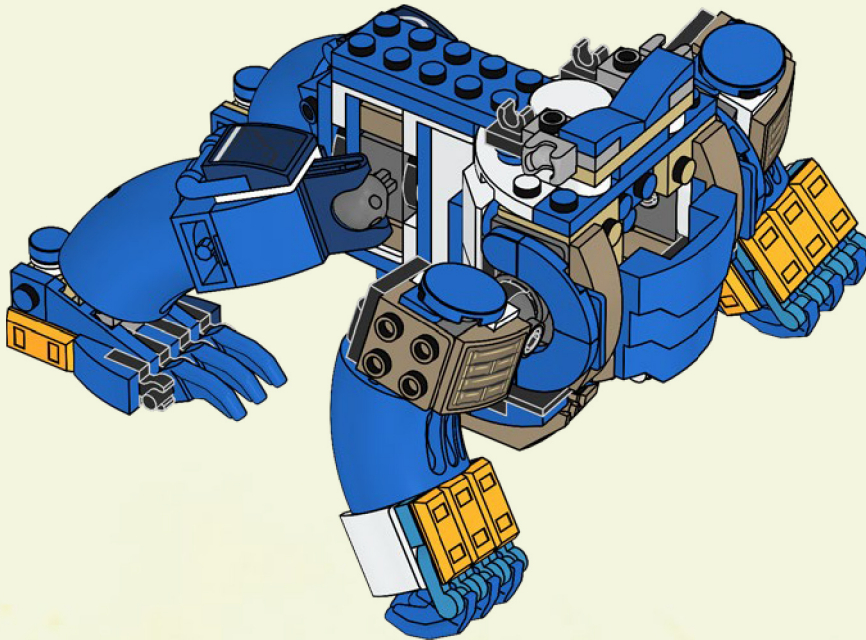

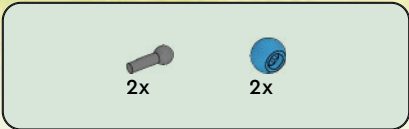

111

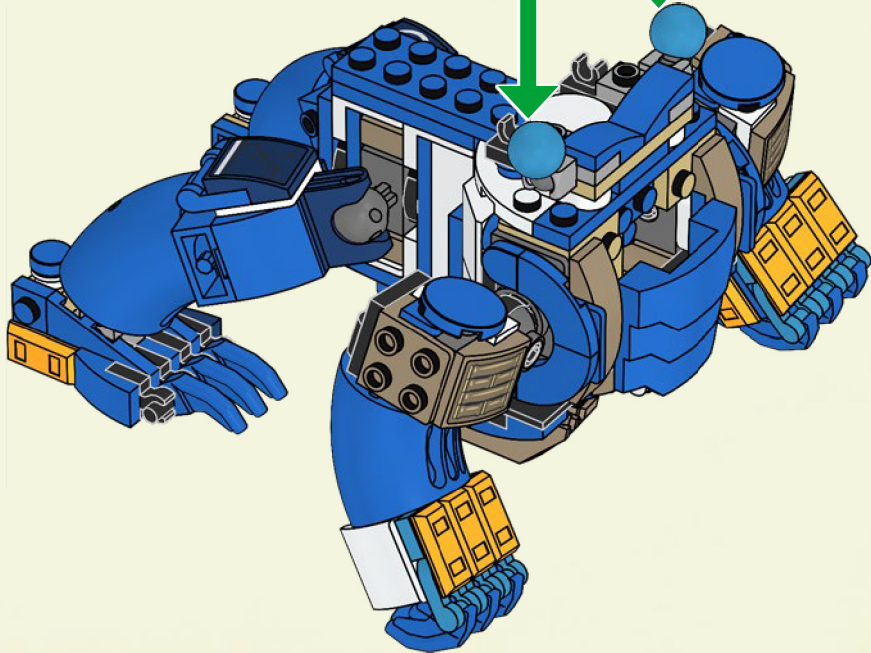
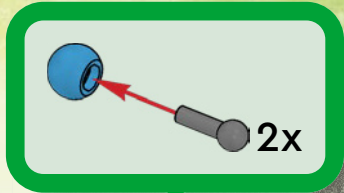

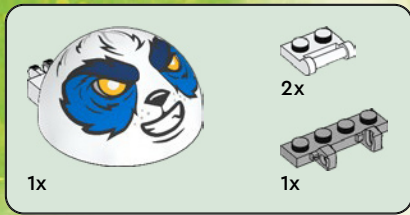

112

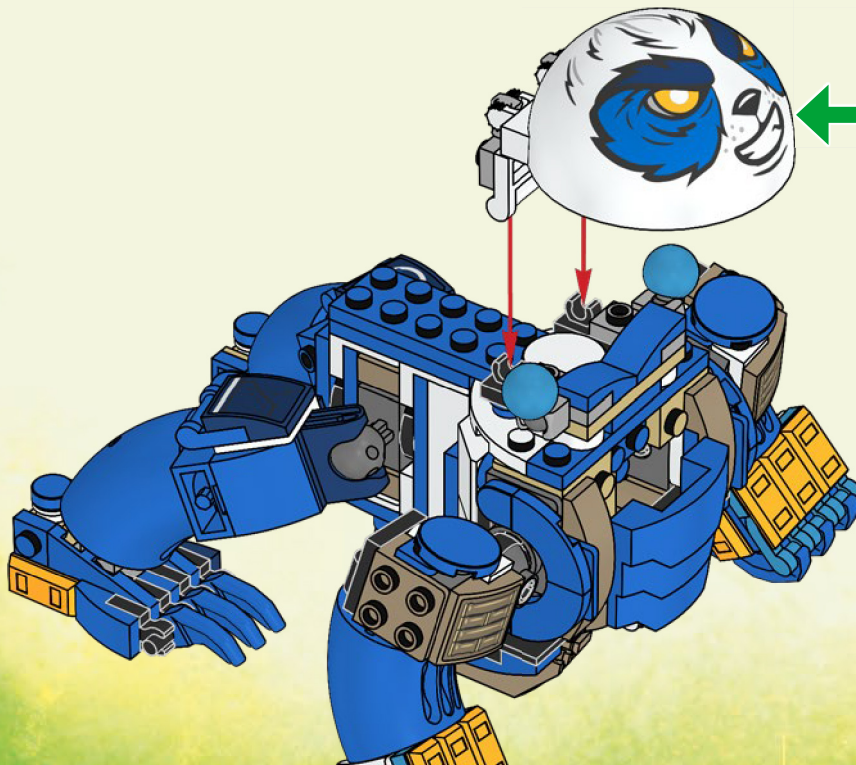
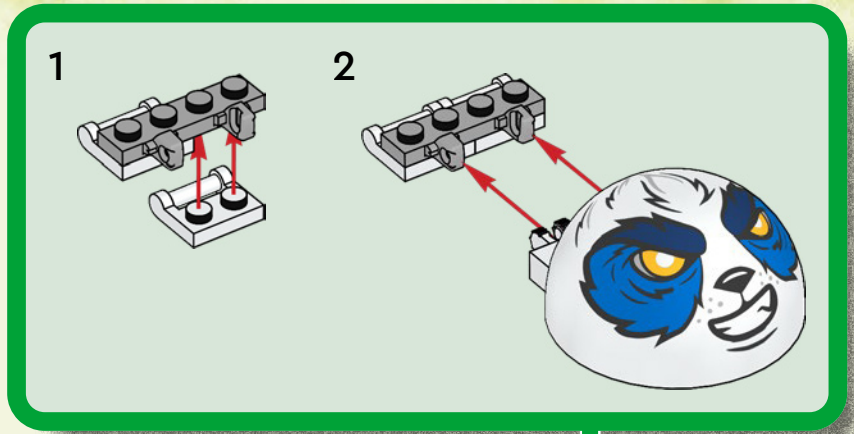

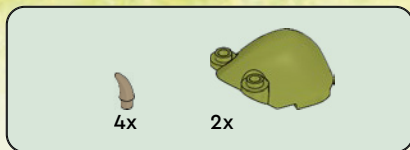

113

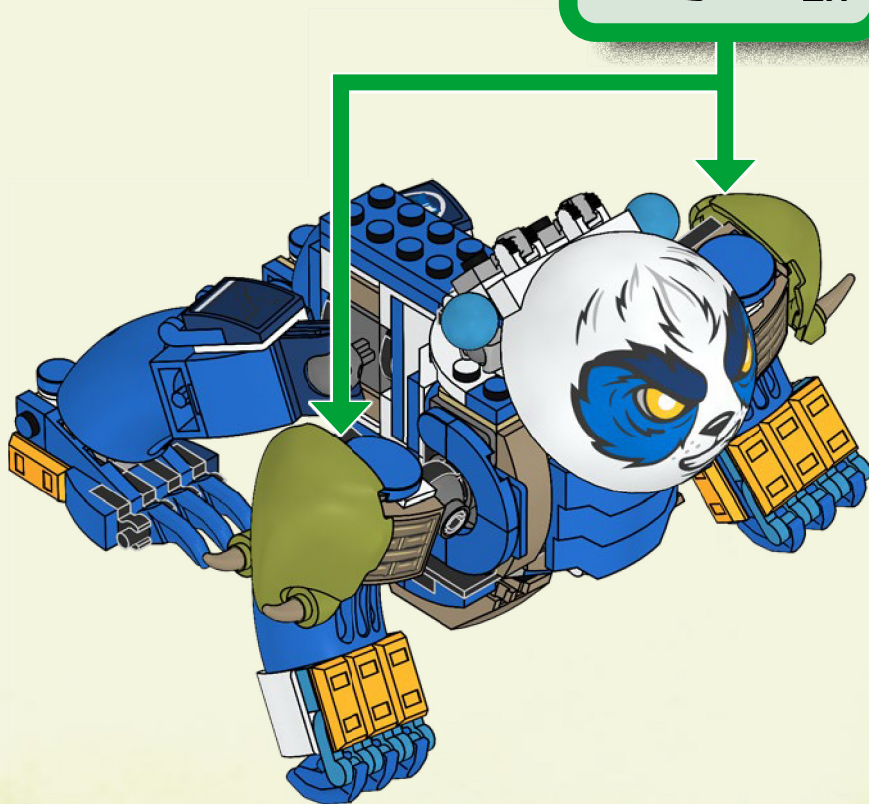
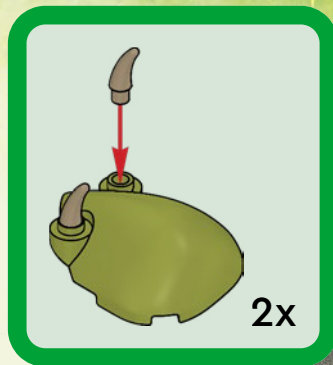



1x



1x

114

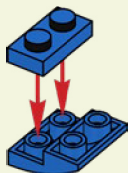

1x

115

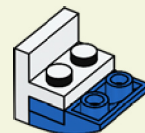



1x

116

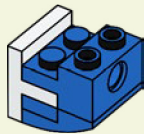

1x



1x



1x

117

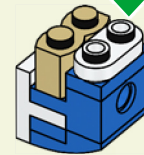
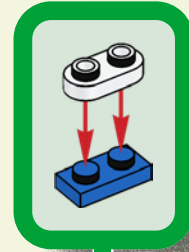



1x

118

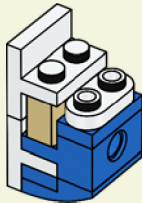

1x



1x

119

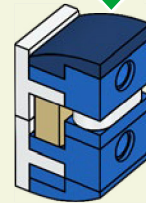
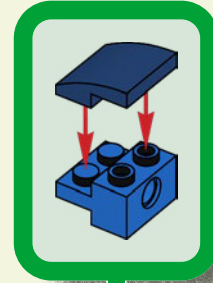



1x

120

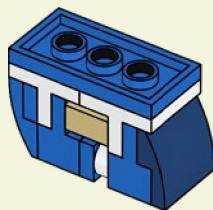

2x

121

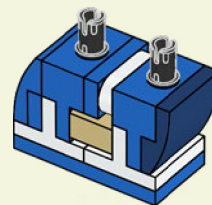

122

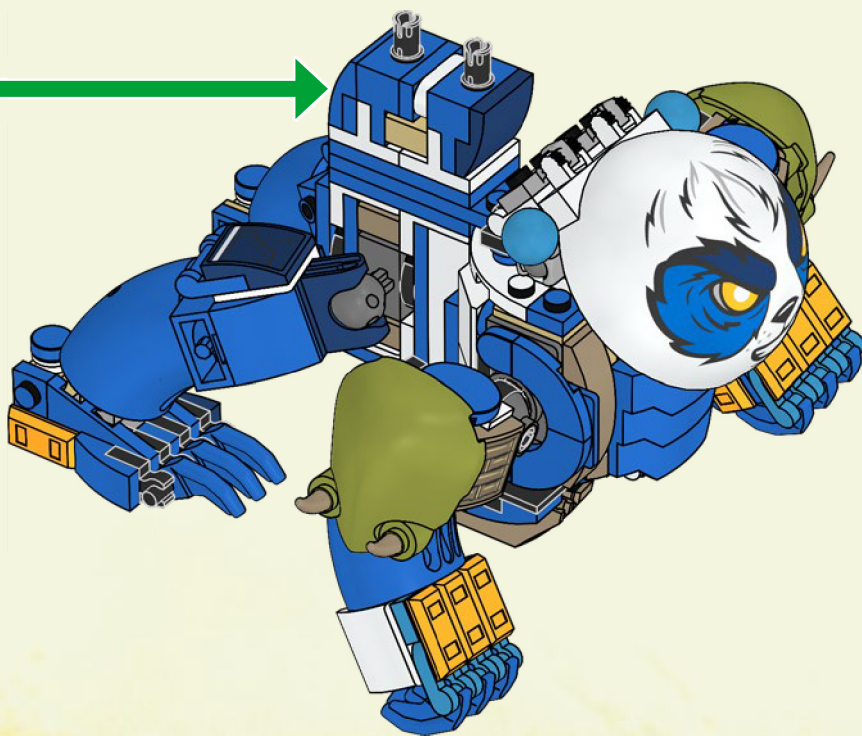

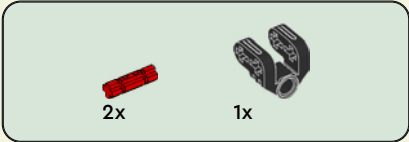
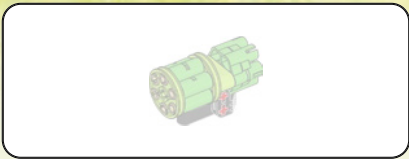

123

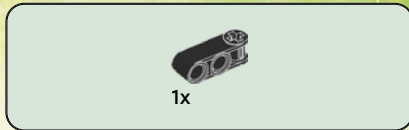
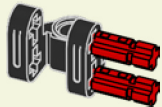

124

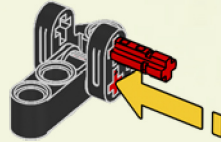

125

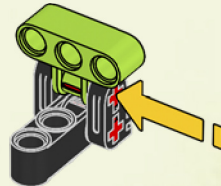

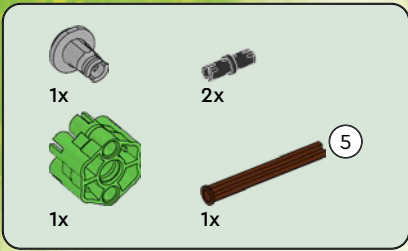

126

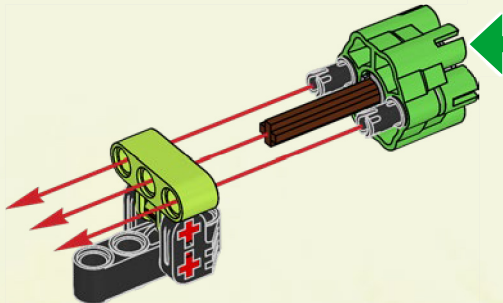
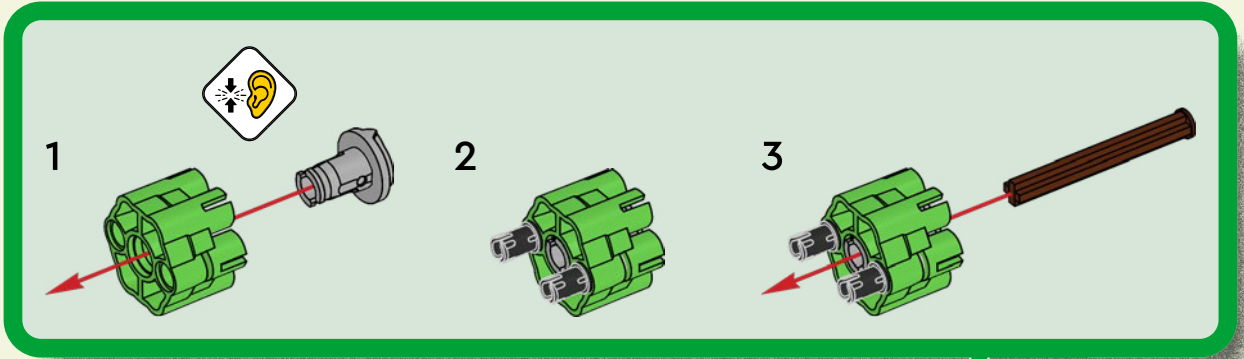

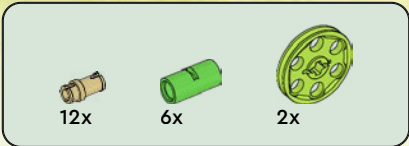

127

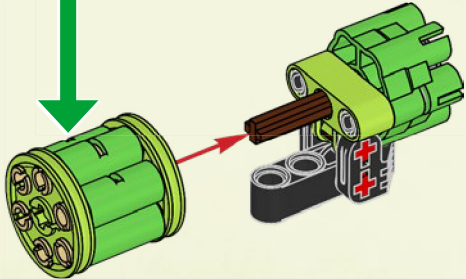
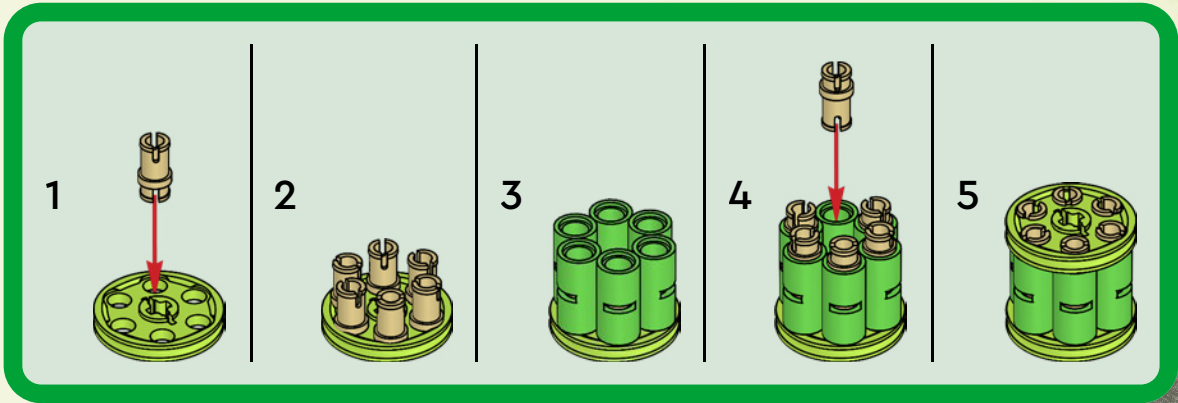

128

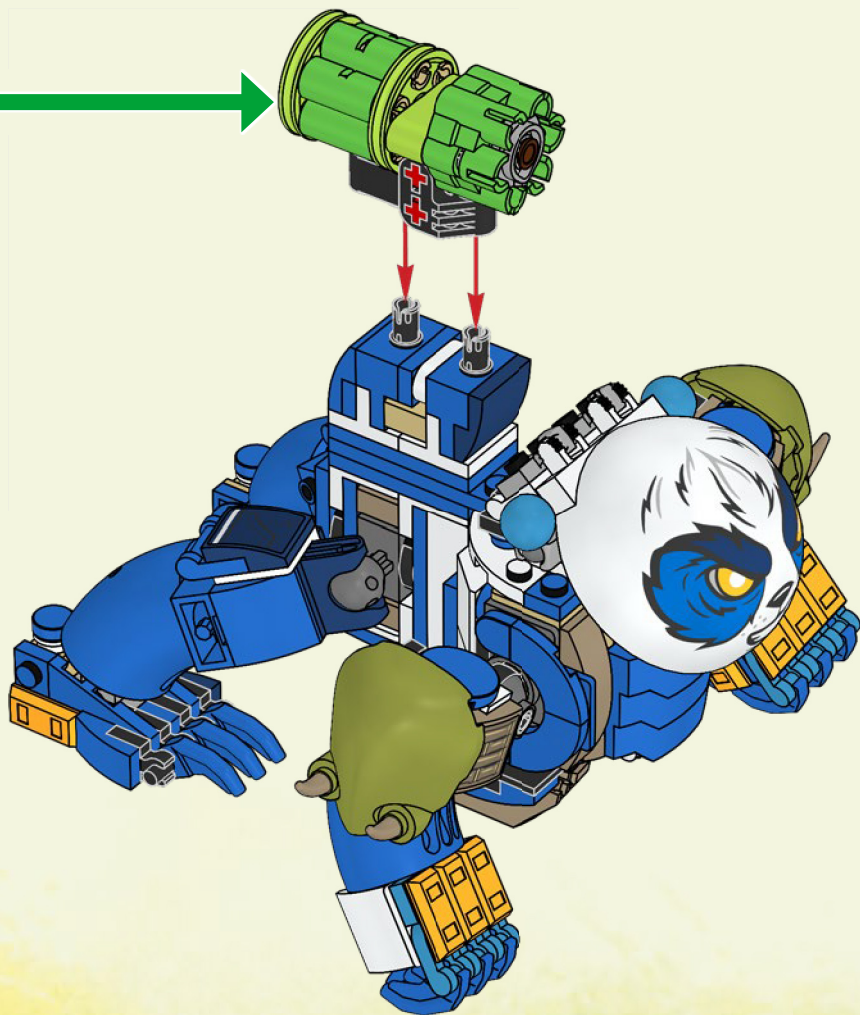

12x

129

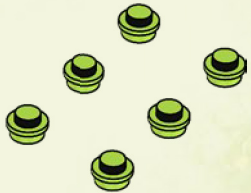

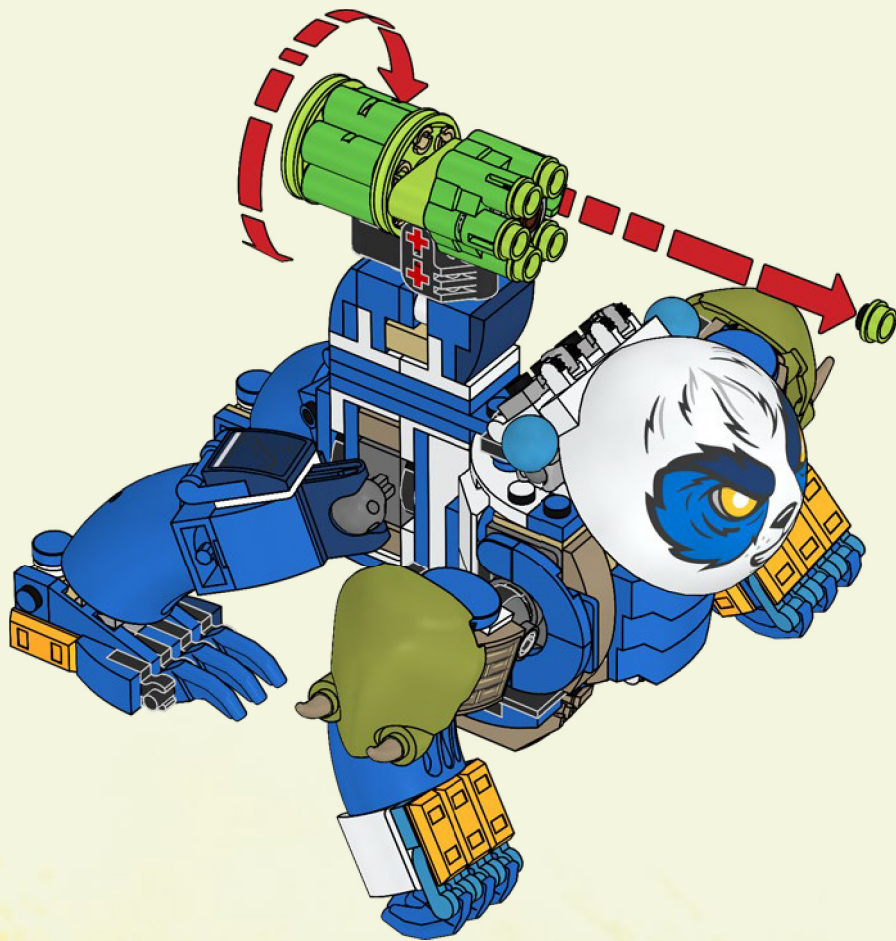





DREAMZZZ™





DREAMZZZ



**WATCH
SERIES
ONLINE** 

Watch series online
Schau dir die Serie online an
Regarde la série en ligne
Guarda la serie online
Mira la serie en Internet
Assistir à série online
在线观看
Oglądaj serial w internecie

Sleduj seriál online
Pozri si seriál online
Nézd a sorozatot online
Vizionează serialul online
Гледайте сериала онлайн
Skaties seriālu tiešsaistē
Vaata sarja veebist
Žiūrėk serialą internetu



 LEGO.com/DREAMZZZ

6x
614101



1x
6276148



2x
6296132



17x
6210272



1x
6044691



4x
6097637



2x
6117940



2x
6018774



1x
6347287



2x
6250019



3x
4222017



4x
6366391



2x
6210385



1x
4113233



1x
4113233



1x
4113233

1x
4113233



1x
396001



2x
300101



2x
6192352



1x
6487099



2x
4118793



12x
6013938



2x
4218749



2x
6117975



1x
6313611



1x
6221467



1x
6318084



1x
4113233



1x
4113233

1x
4113233



2x
4142865



4x
6284575



2x
614123



4x
6268862



1x
6172414



4x
302423



14x
6447238



2x
6315482



2x
4498155



1x
6172411



2x
4498156



2x
4651236



2x
6133844



10x
4206482



2x
4278276



1x
4278276



8x
302323



6x
6055065



2x
6347945



6x
6133721



2x
6117968



2x
4514398



4x
6194724



6x
6488776



1x
4496366



5x
6307924



6x
6492756



8x
302023



1x
6421594



1x
6421594



1x
6421594



1x
6421594



1x
300923



1x
366623



1x
303423



8x
6330189



2x
6344417



3x
403226



4x
6279875



1x
6487098



6x
6347310



3x
6093525



2x
4213374



1x
6279021



1x
6273708



1x
6273708

1x
6273708

2x
6061032

4x
362326

1x
6493258

2x
6168620

2x
6118829

1x
379526

6x
6173135

1x
6466880

1x
6523611

1x
6247796

1x
6508633

1x
6466858

12x
4183133

2x
6335116

1x
6334042

1x
6013530

1x
6487096

1x
6143445

4x
6270111

4x
4520257

2x
6330148

2x
6093038

3x
6167936

2x
6343454

2x
6236573

5x
6061569

1x
6493108

2x
6479467

1x
6487095

10x
6236454

1x
6159763

2x
6443149

2x
6227897

1x
6361703

4x
6043656

2x
4244627

1x
6276045

4x
4210639

4x
6336390

2x
6364352

2x
6398662

2x
6279898

1x
6065816

1x
6158415

1x
6487093

2x
6412745

6x
6481638

2x
6153538

1x
6275487

2x
6491523

1x
6491850

 [LEGO.com/service](https://www.LEGO.com/service)



YOU COULD WIN



Scan this QR code or go to **LEGO.COM/PRODUCTFEEDBACK** and give us your short feedback about this LEGO® set for a chance to win a cool LEGO prize.

Terms and Conditions apply*

EN: YOU COULD WIN. Terms and Conditions apply* **DE: Du könntest GEWINNEN.** Es gelten die Teilnahmebedingungen* **FR: Tu pourrais GAGNER.** Des conditions s'appliquent* **IT: Potresti VINCERE tu.** Termini e condizioni sono applicabili* **ES: Puedes GANAR.** Aplican términos y condiciones* **PT: Poderá GANHAR.** Aplicam-se termos e condições* **ZH: 轻松获奖. 条款和条件适用*** **PL: Szansa na WYGRANĄ.** Obowiązują warunki korzystania* **CS: Máte šanci VYHRÁT.** Platí všeobecné smluvní podmínky* **SK: Máte šancu VYHRAŤ.** Platia všeobecné zmluvné podmienky* **HU: TE IS NYERHETSZ.** Felhasználási feltételek érvényesek* **RO: Ai putea CÂȘTIGA.** Se aplică termeni și condiții* **BG: Можете да СПЕЧЕЛИТЕ.** Има определени правила и условия* **LV: Tu vari LAIMĒT.** Ir spēkā noteikumi un nosacījumi.* **ET: Sul on võimalus VÕITA.** Kehtivad tingimused* **LT: Jūs galite LAIMĖTI.** Taikomos sąlygos*

*[LEGO.com/productfeedback-terms](https://www.lego.com/productfeedback-terms)