



duplo™

10428





Get excited about our new packaging!

We're switching from plastic to paper-based packaging. That's why you might find a mix of paper and plastic in our boxes!

Nos nouveaux emballages vous emballeront !

Nous passons des emballages en plastique aux emballages à base de papier. C'est pourquoi vous pourriez trouver un mélange de papier et de plastique dans nos boîtes !

¡Te presentamos nuestros nuevos empaques!

Estamos sustituyendo las bolsas de plástico por bolsas con base de papel. ¡Por eso, puedes encontrar una mezcla de papel y de plástico en nuestras cajas!

[LEGO.com/sustainable-packaging](https://www.lego.com/sustainable-packaging)



Building the Big Skills Toddlers Need

We believe in big starts. Our big bricks are designed for little hands to master. When toddlers' creativity is set free, their opportunities to learn become endless. We call it Learning Through Play. And it inspires every LEGO® DUPLO® set. Based on thorough scientific research, each set helps young minds develop both IQ skills (cognitive, physical, creative) and EQ skills (social, emotional). Let all toddlers Start Off Big.

LEGO DUPLO sets are categorized into benefit territories that match toddlers' ages and developmental stages

Développer les grandes compétences dont les tout-petits ont besoin

Nous croyons aux grands départs. Nos grandes briques sont conçues pour être manipulées par les petites mains. Lorsque la créativité des tout-petits est libérée, les possibilités d'apprentissage deviennent infinies. C'est ce que nous appelons apprendre par le jeu. Et c'est ce qui inspire chaque ensemble LEGO® DUPLO®. Basé sur des recherches scientifiques approfondies, chaque ensemble aide les jeunes esprits à développer à la fois les compétences QI (cognitives, physiques, créatives) et les compétences QE (sociales, émotionnelles). Permettez à tous les enfants en bas âge de commencer en beauté.

Les ensembles LEGO DUPLO sont classés en catégories d'avantages qui correspondent à l'âge et au stade de développement des tout-petits

Desarrollamos las grandes habilidades que necesitan los peques

Creemos en los grandes comienzos. Nuestros bricks más grandes están diseñados para que una manita pueda manejarlos con facilidad. Cuando la creatividad de los peques fluye libremente, las oportunidades de aprender se vuelven infinitas. A eso lo llamamos "aprendizaje mediante el juego". Y es la fuente que inspira cada set LEGO® DUPLO®. Basados en rigurosos estudios científicos, los sets contribuyen al desarrollo del cociente intelectual (resultante de las habilidades cognitivas, físicas y creativas) y el cociente emocional (que depende de las habilidades sociales y emocionales) de las mentes más jóvenes. Todos los niños y niñas merecen un gran comienzo.

Los sets LEGO DUPLO se clasifican en campos de aprovechamiento acordes con las edades y etapas de desarrollo de los niños y niñas

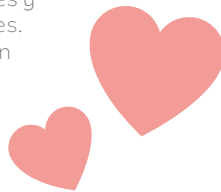

CREATIVE
SOLUTIONS



LEARN
PATIENCE

LEGO® DUPLO® sets in this territory involve playful challenges that can help toddlers master a range of skills, including hand-eye coordination, and how to focus, manage emotions, and solve problems. When you allow toddlers to play independently, and offer guidance from a distance, you can help them develop perseverance and learn to ask for help when needed.

SOLUTIONS
CRÉATIVES



APPRENDRE
LA PATIENCE

Les ensembles LEGO® DUPLO® de cette catégorie comportent des défis ludiques qui peuvent aider les tout-petits à maîtriser toute une série de compétences, notamment la coordination œil-main, la concentration, la gestion des émotions et la résolution de problèmes. Lorsque vous laissez les enfants jouer de manière autonome et que vous les guidez à distance, vous les aidez à développer leur persévérance et à apprendre à demander de l'aide en cas de besoin.

SOLUCIONES
CREATIVAS



APRENDE A
SER PACIENTE

Los sets LEGO® DUPLO® de este campo incluyen divertidos desafíos que pueden ayudar a los peques a dominar una amplia variedad de habilidades: coordinación mano-ojo, técnicas de concentración, manejo de emociones, solución de problemas, etc. Cuando los niños y niñas juegan con independencia y se les ofrece orientación a cierta distancia, desarrollan la perseverancia y aprenden a pedir ayuda cuando la necesitan.



PLAY
IDEAS

IDÉES
DE JEU

IDEAS
DE JUEGO





**CREATE A
STORY**

**CRÉER UNE
HISTOIRE**

**CREA UNA
HISTORIA**





























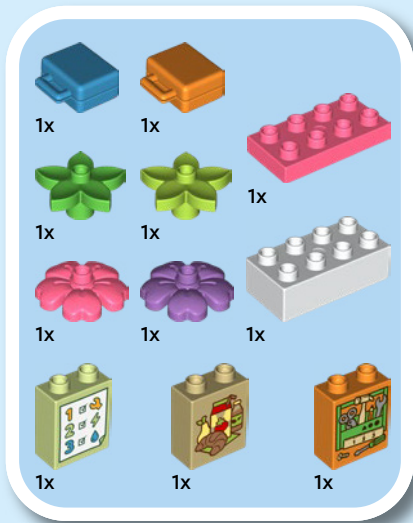



1

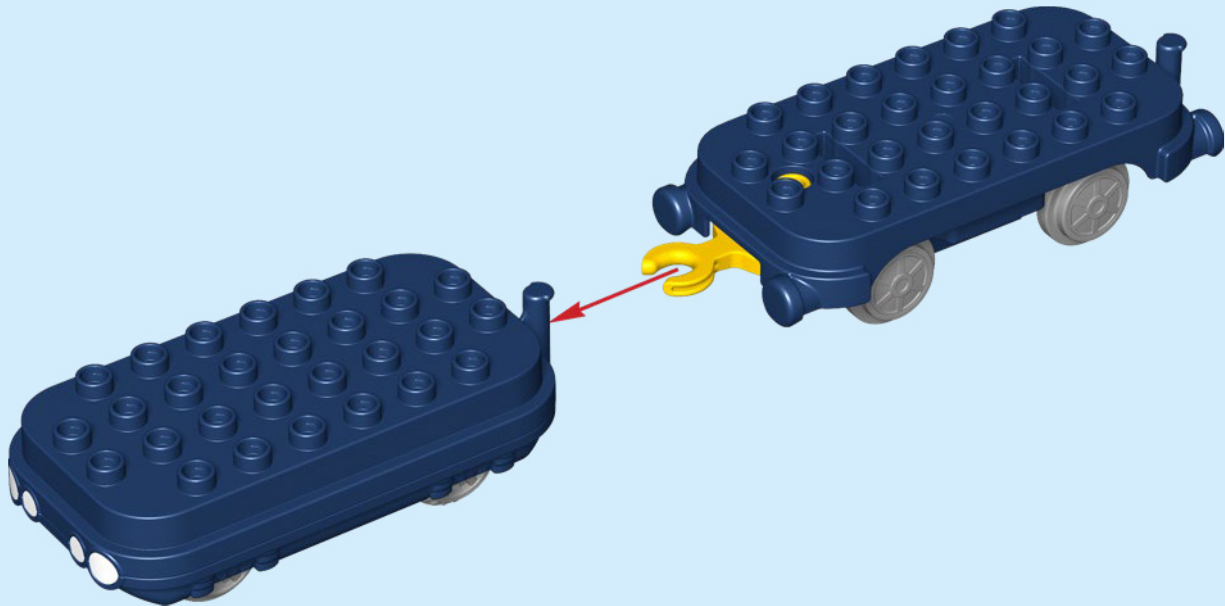

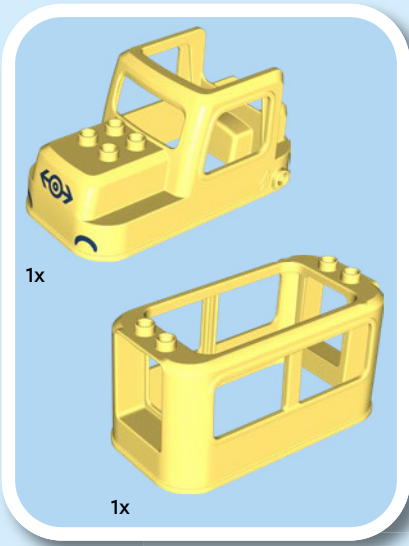

2



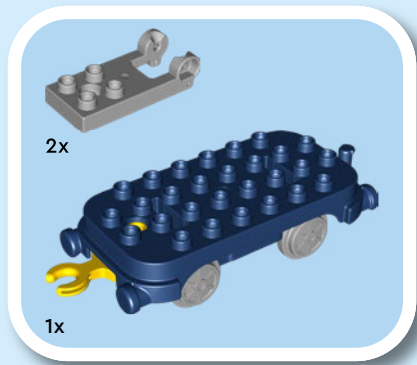

3

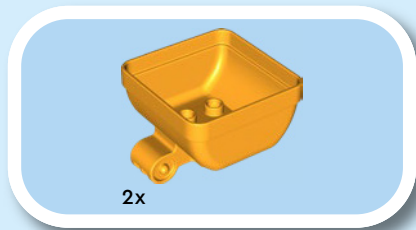
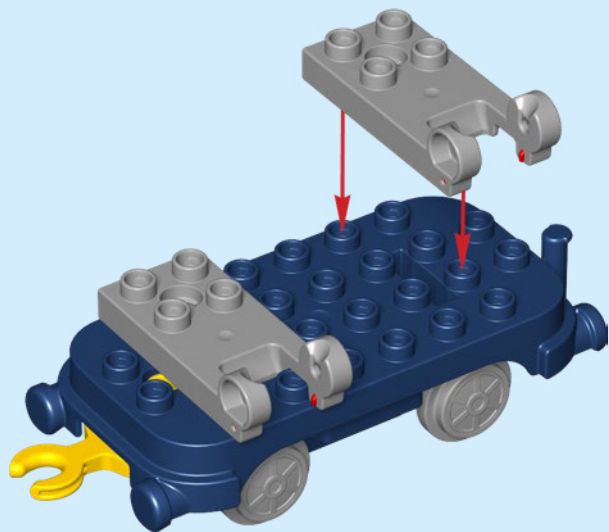

4

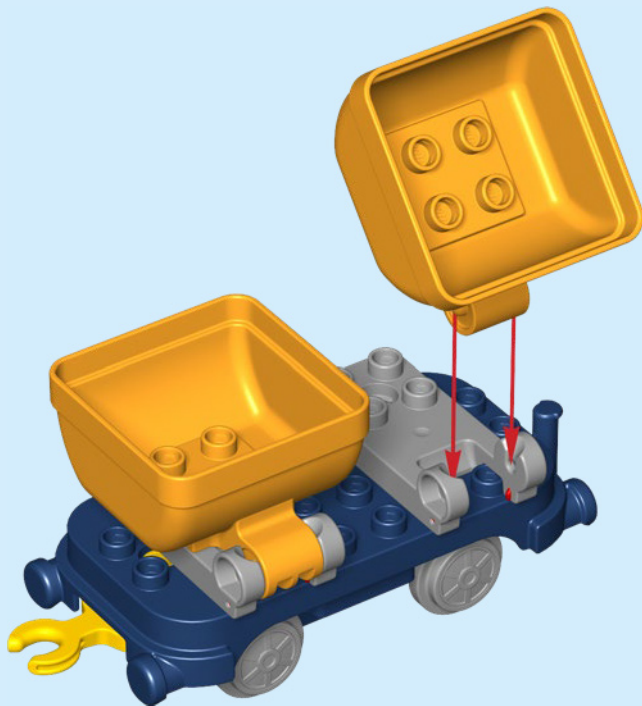

5

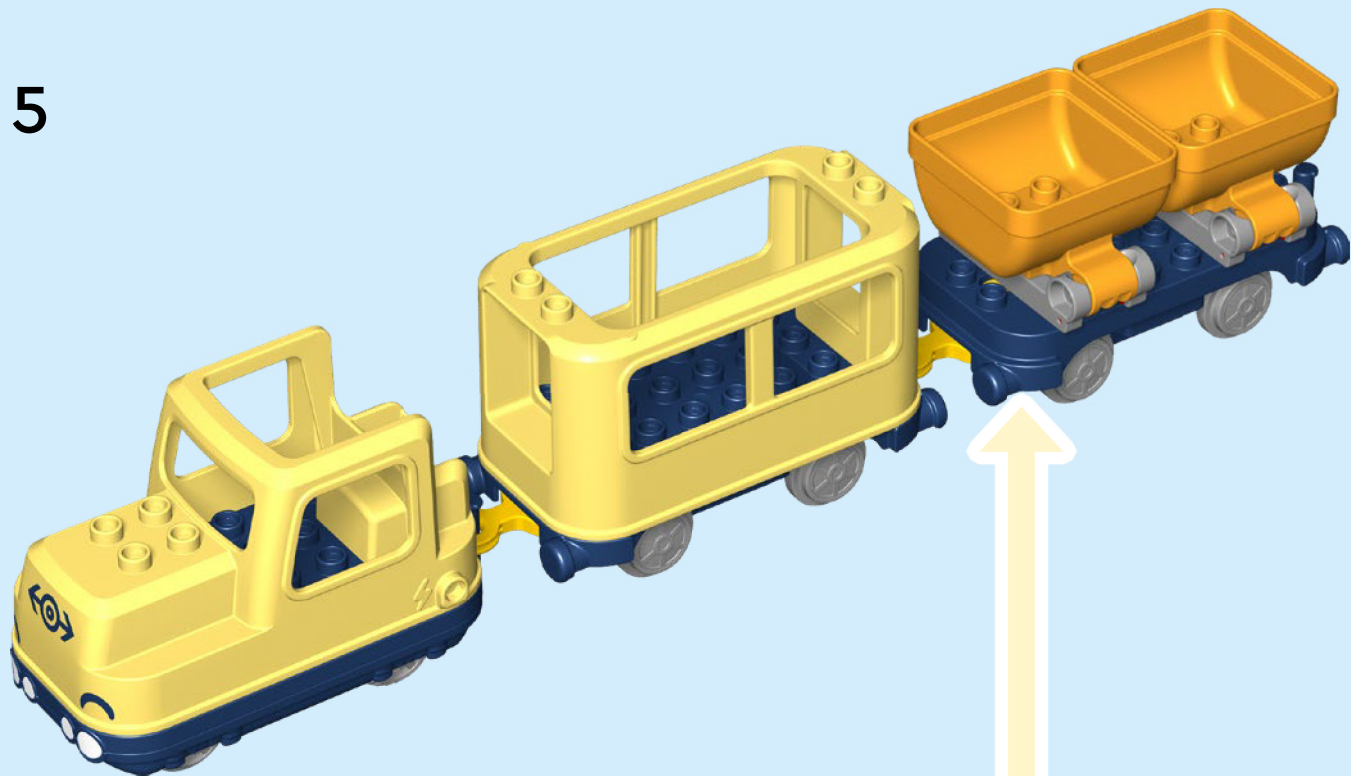

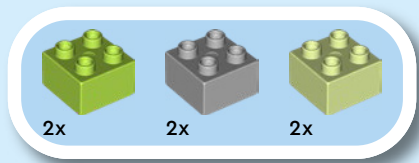

6



1



2



3

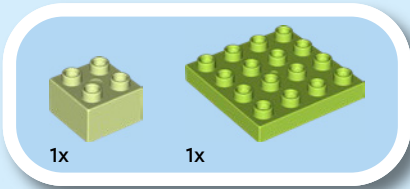

1

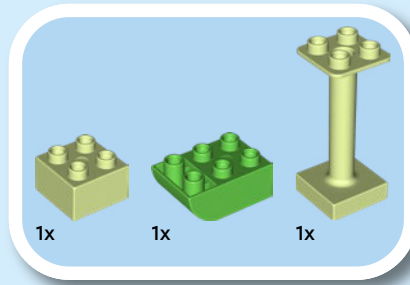
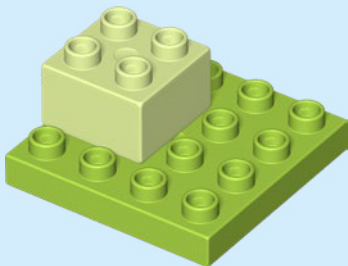

2

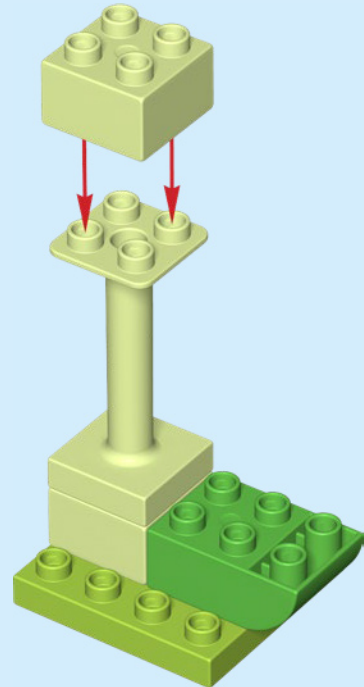

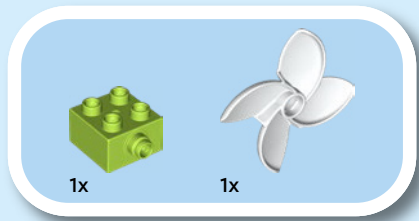

3

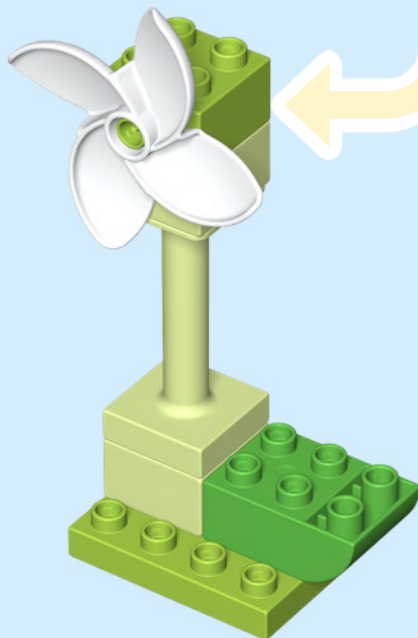
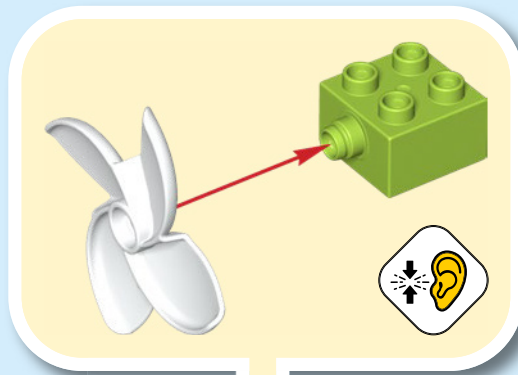



4



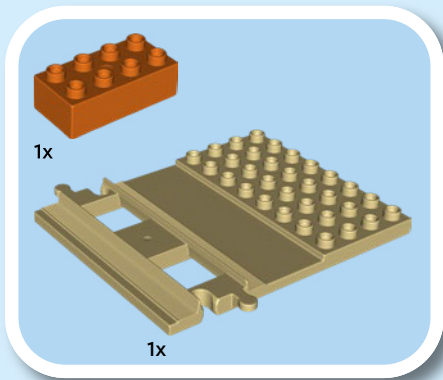

1

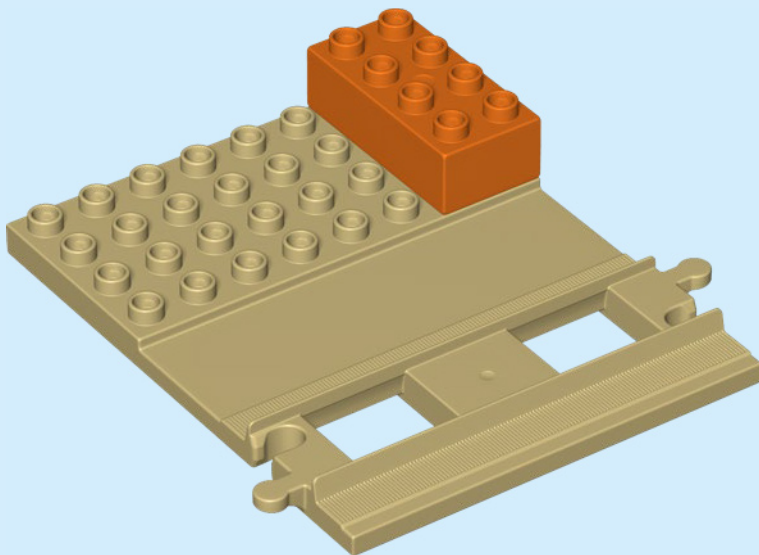

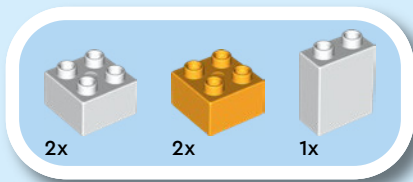

2

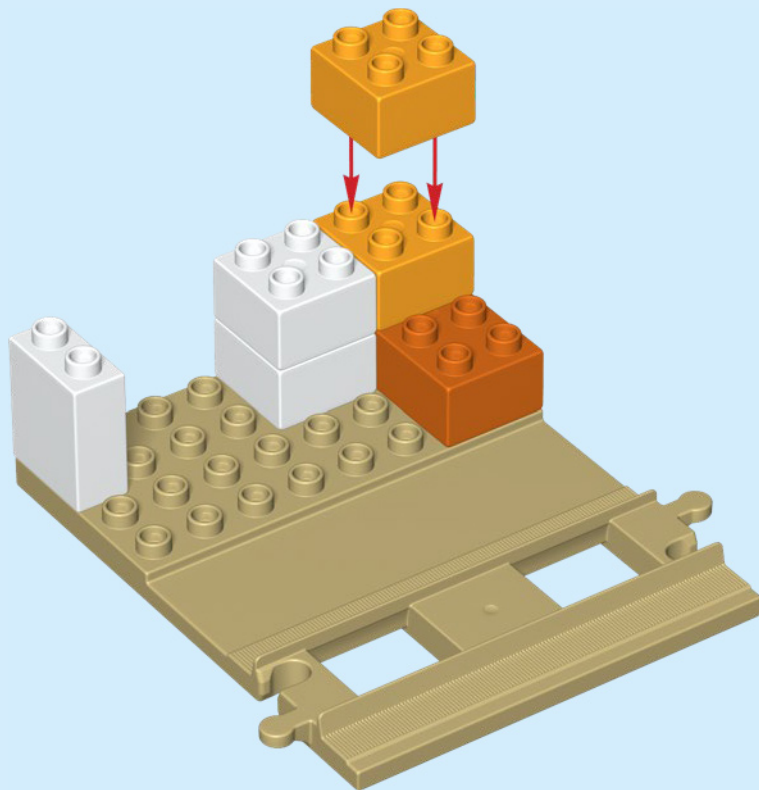

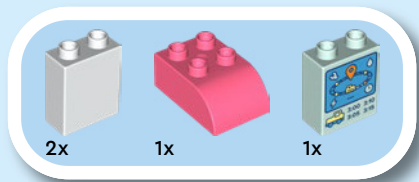

3

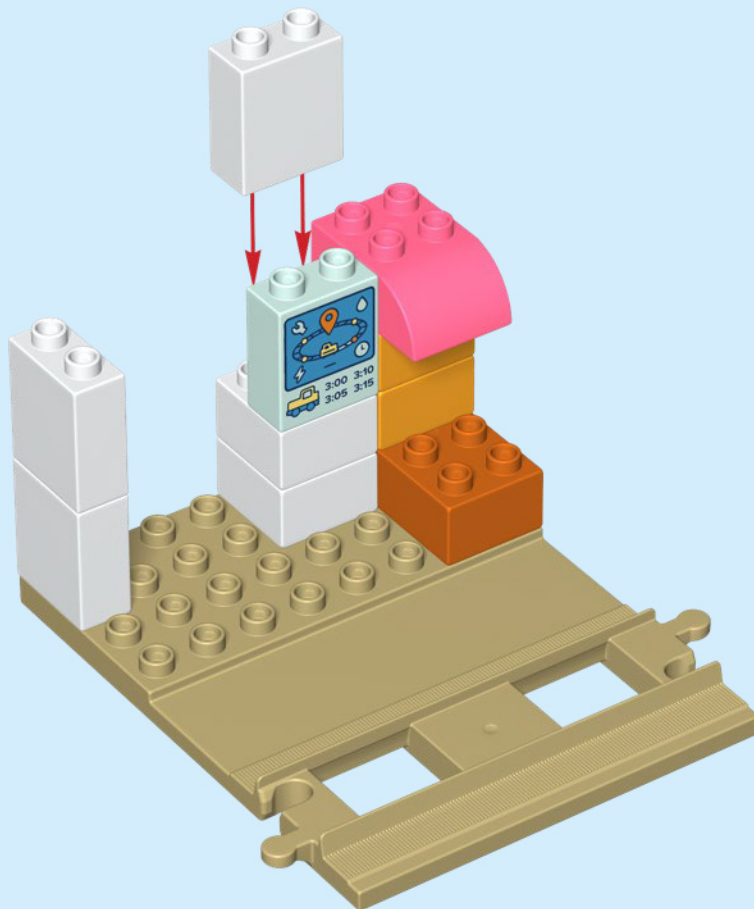

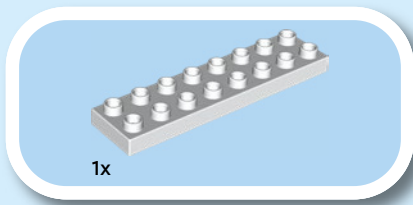

4

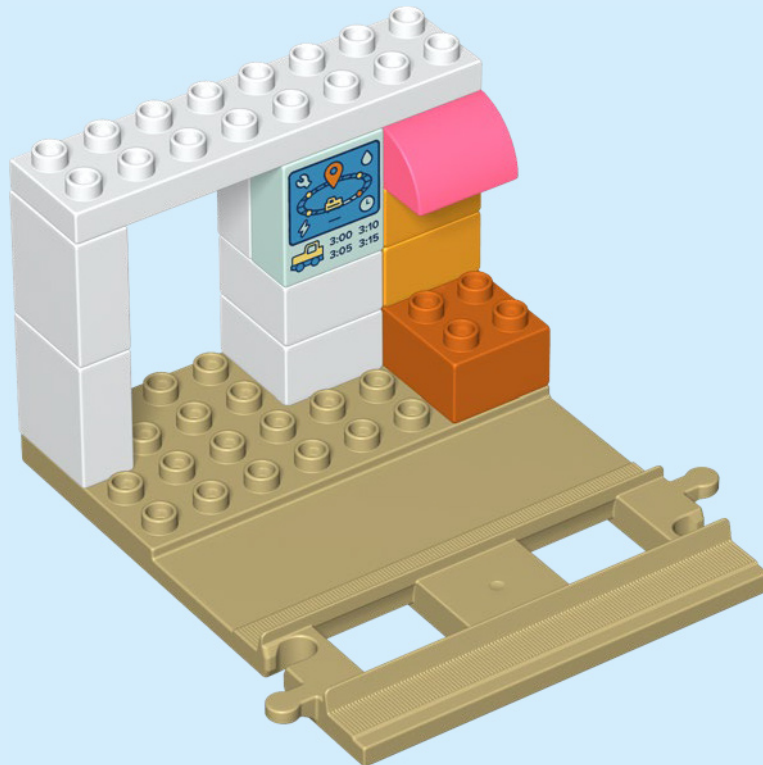

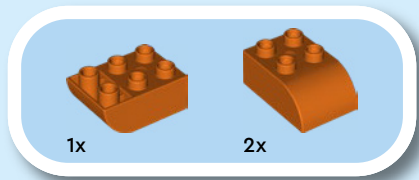

5

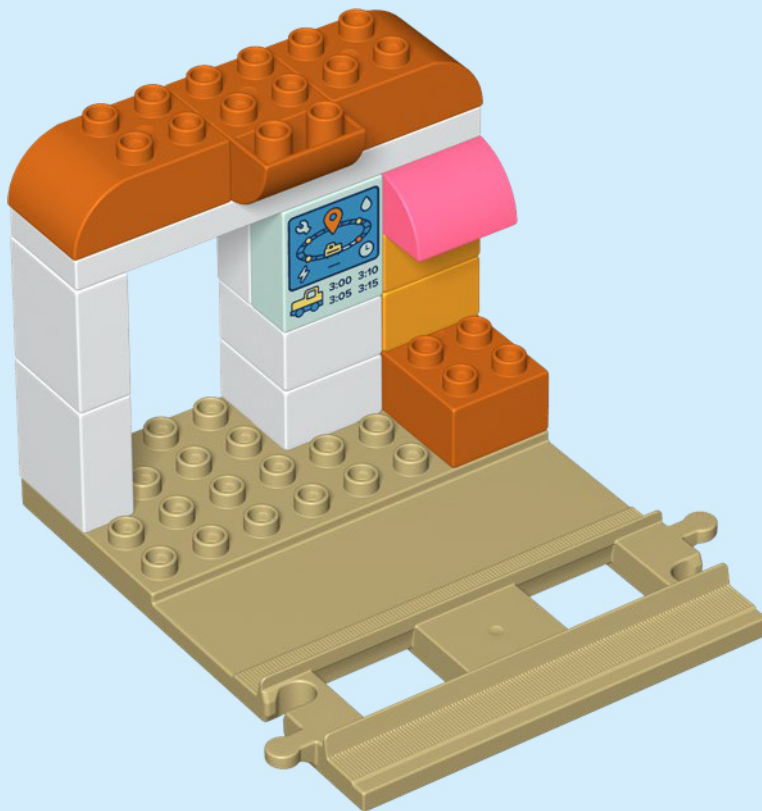

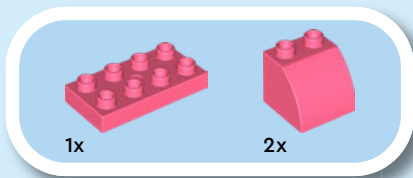

6

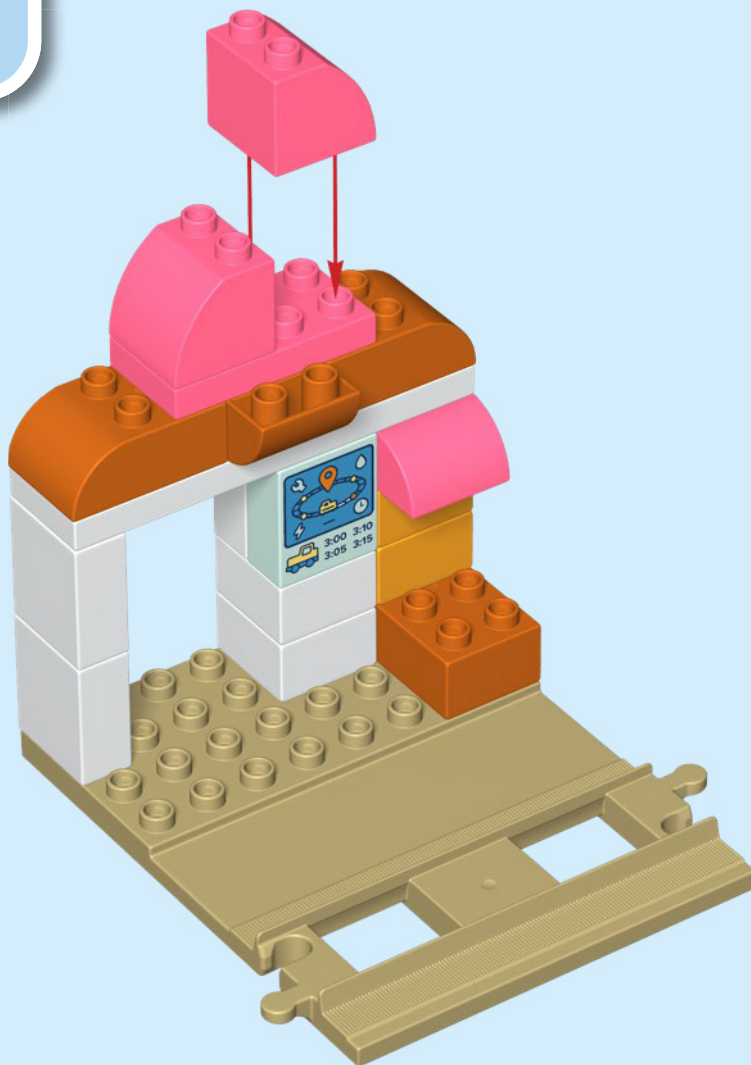

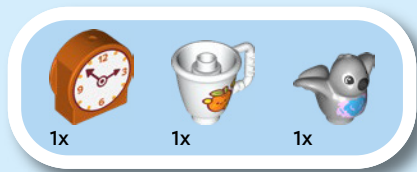

7

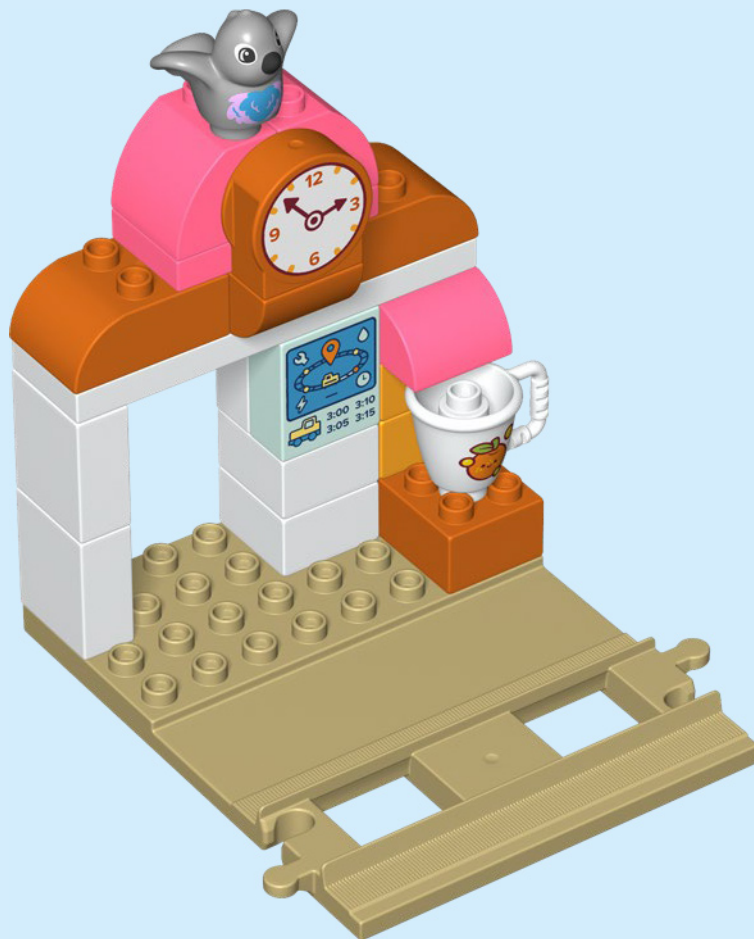

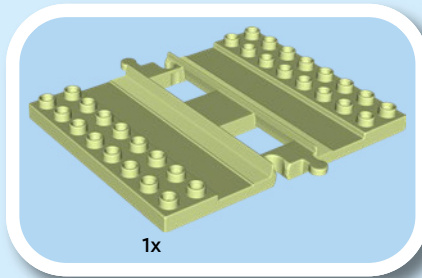

1

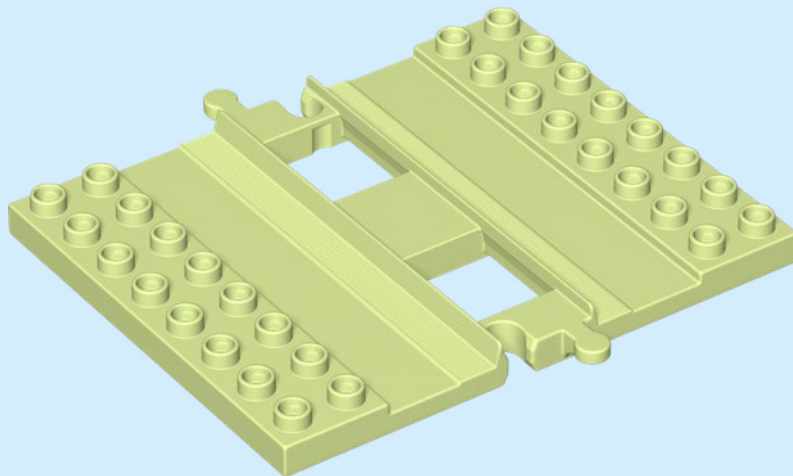

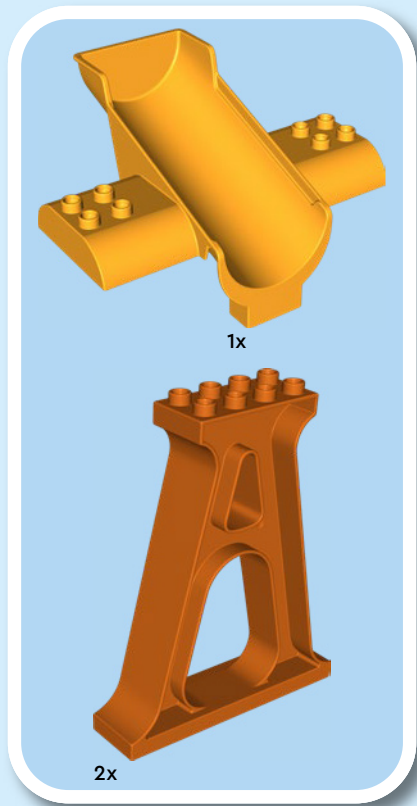

2

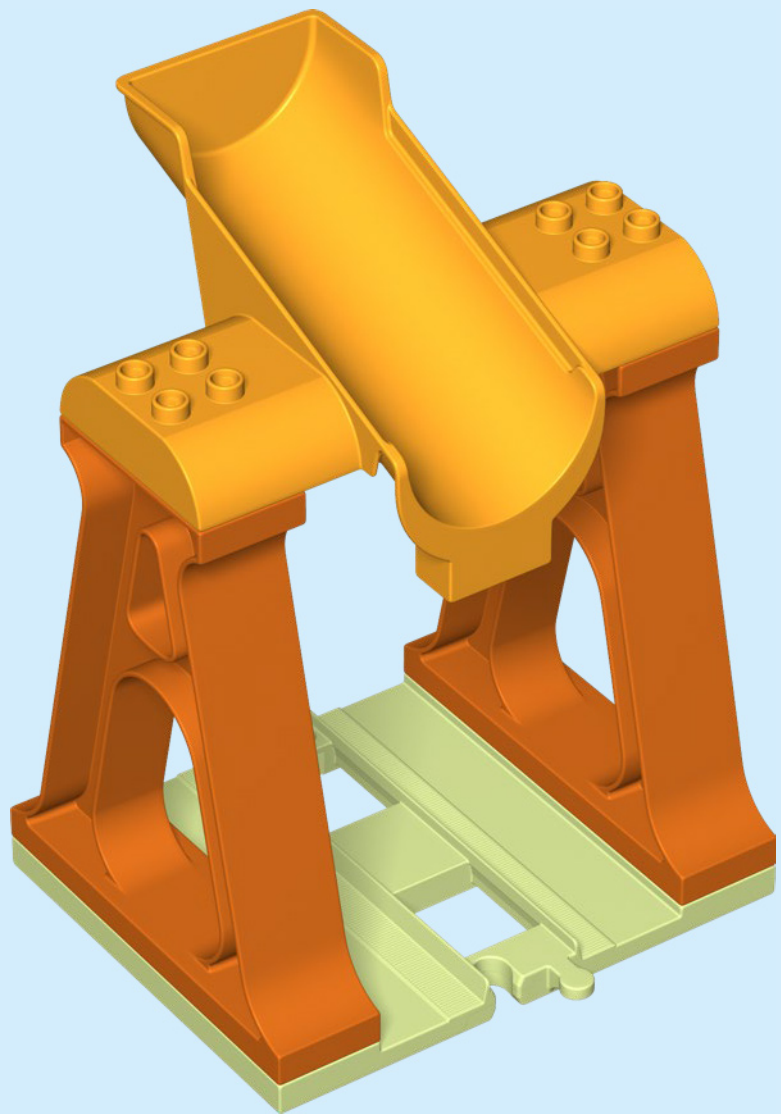

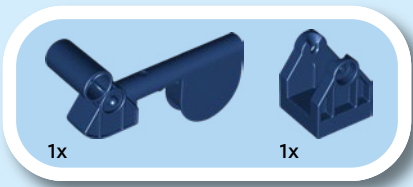

3

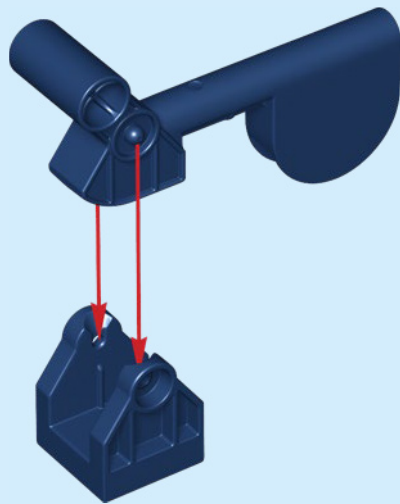

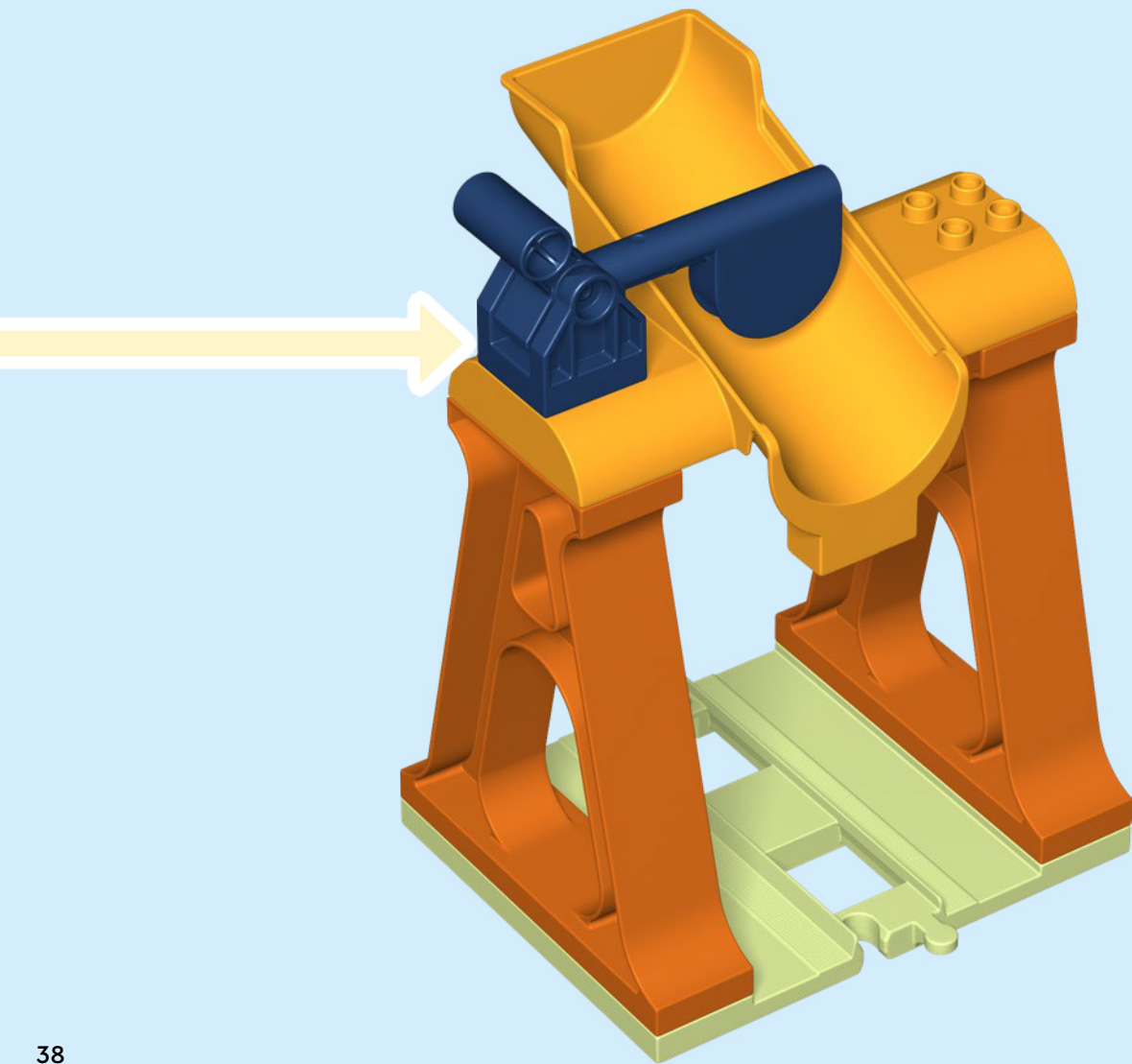

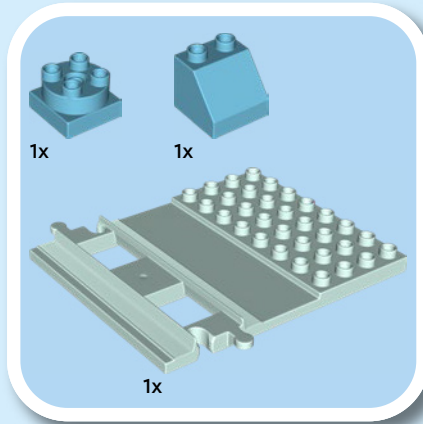

1

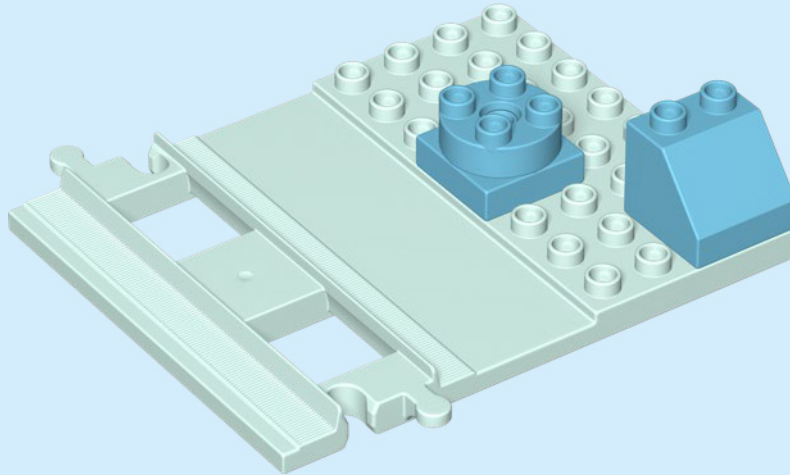

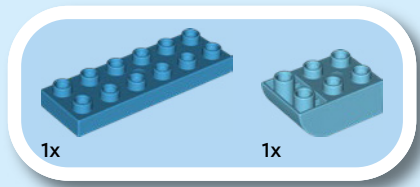

2

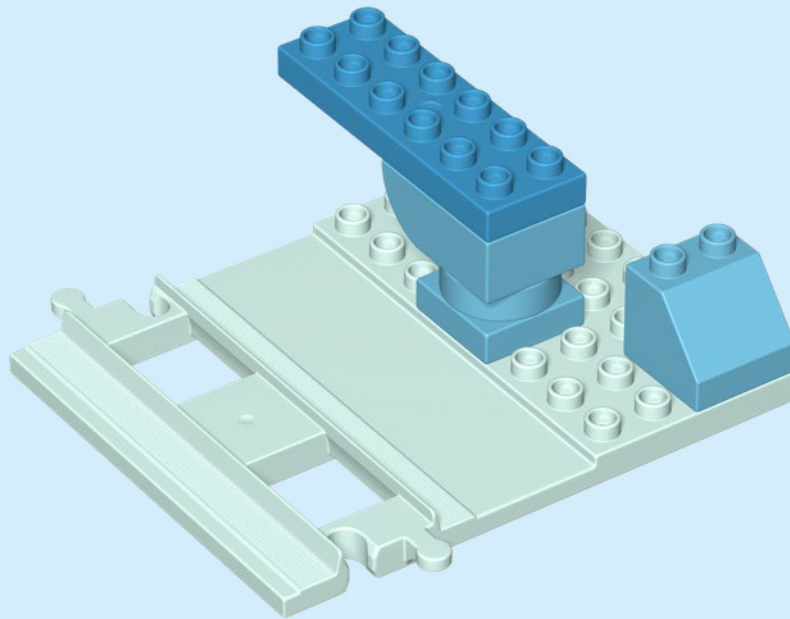

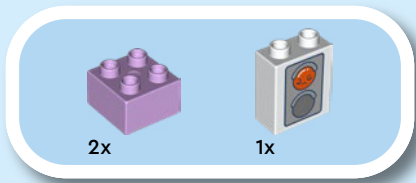

3

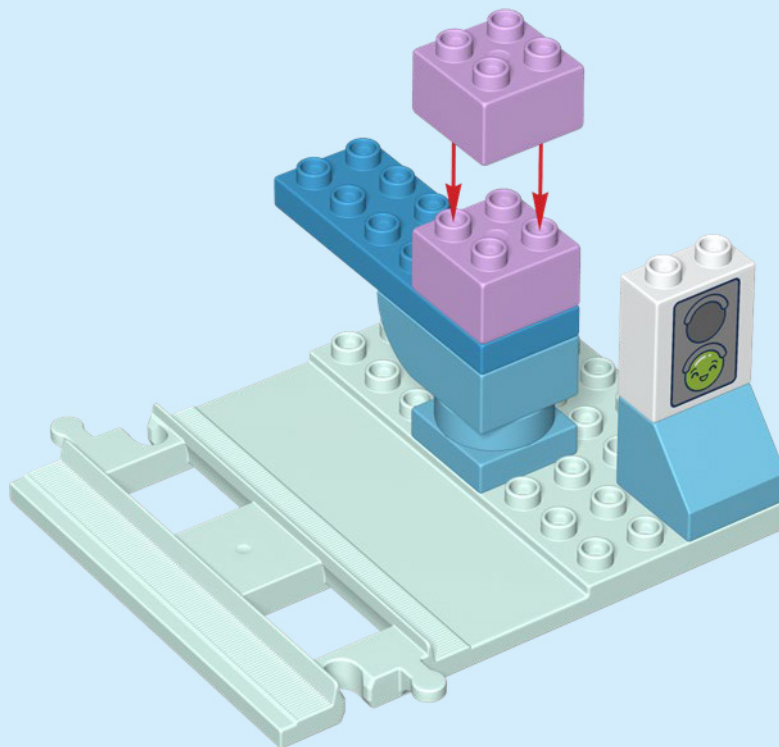

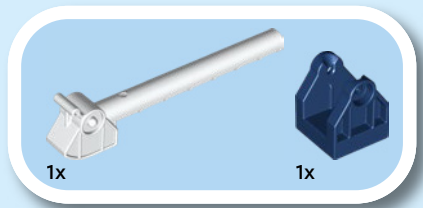

4

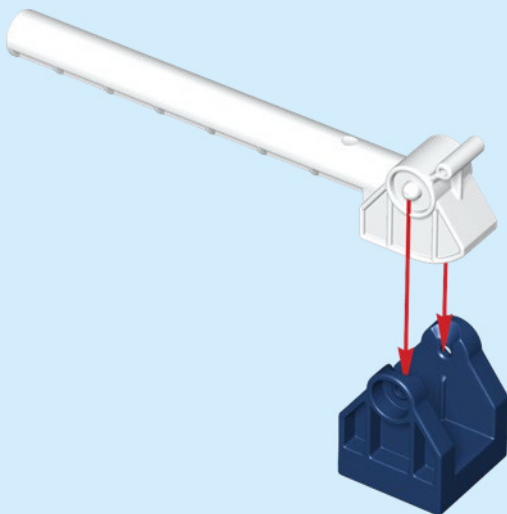

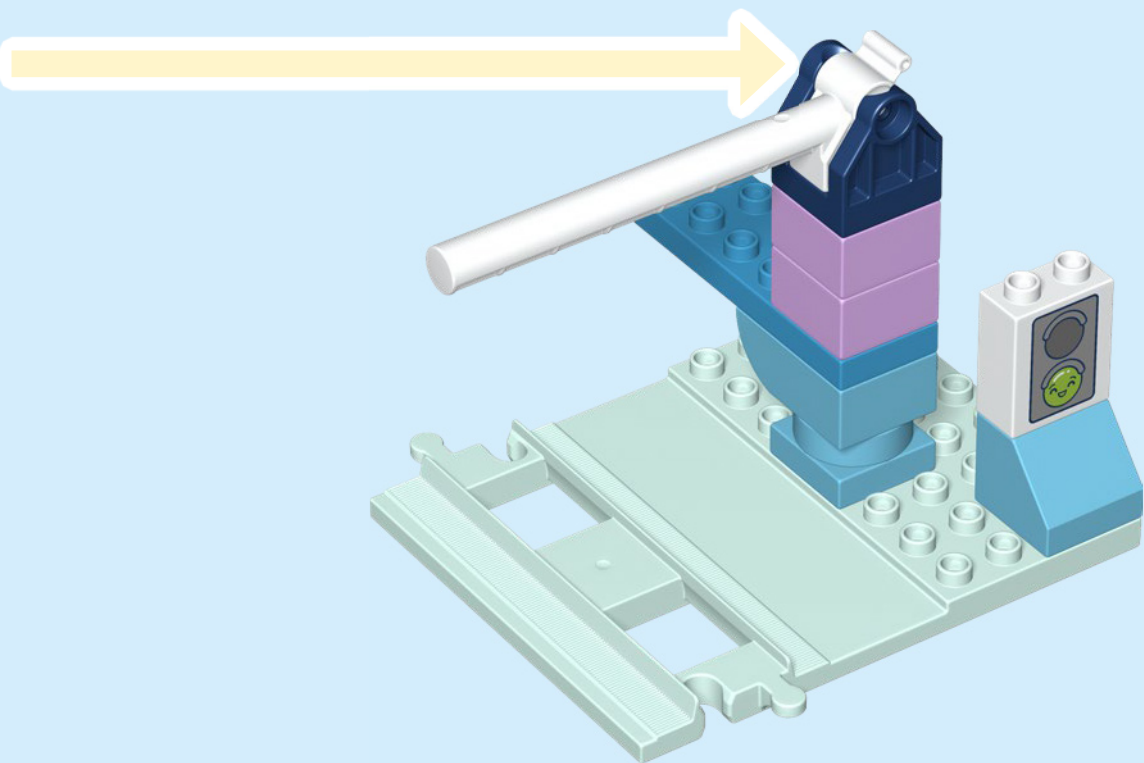

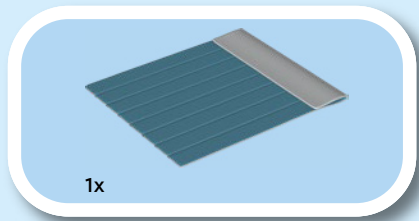

5

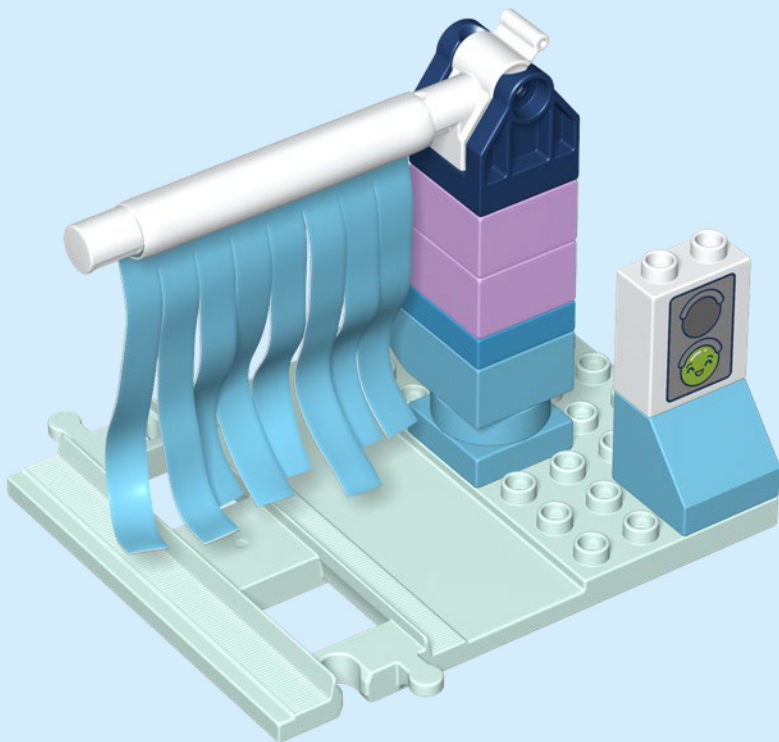

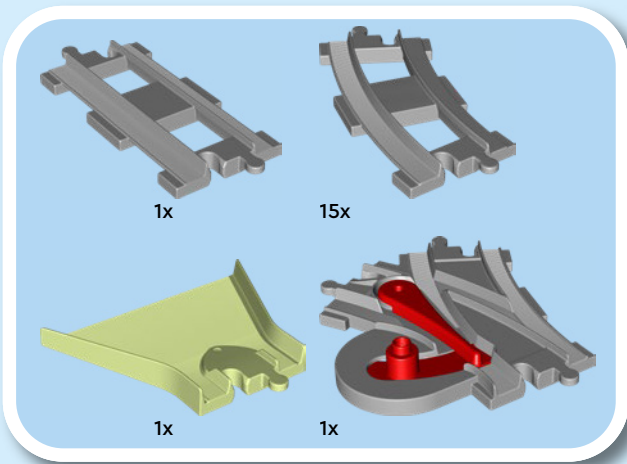

6

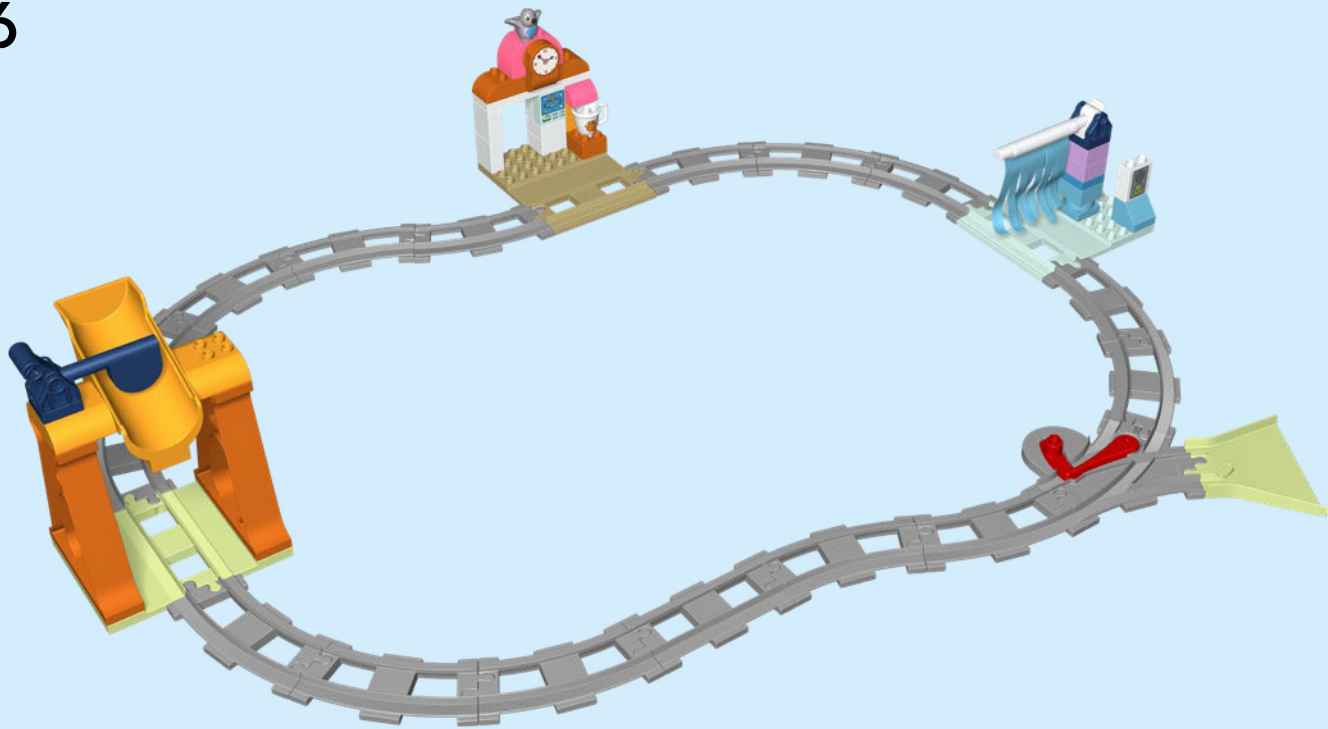

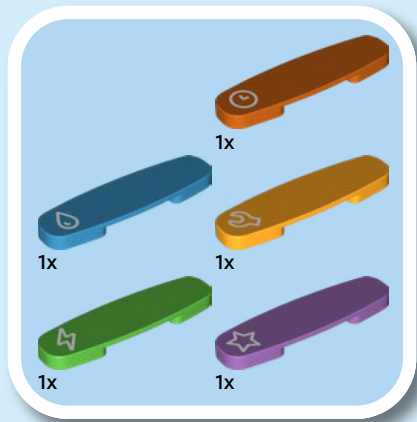

7

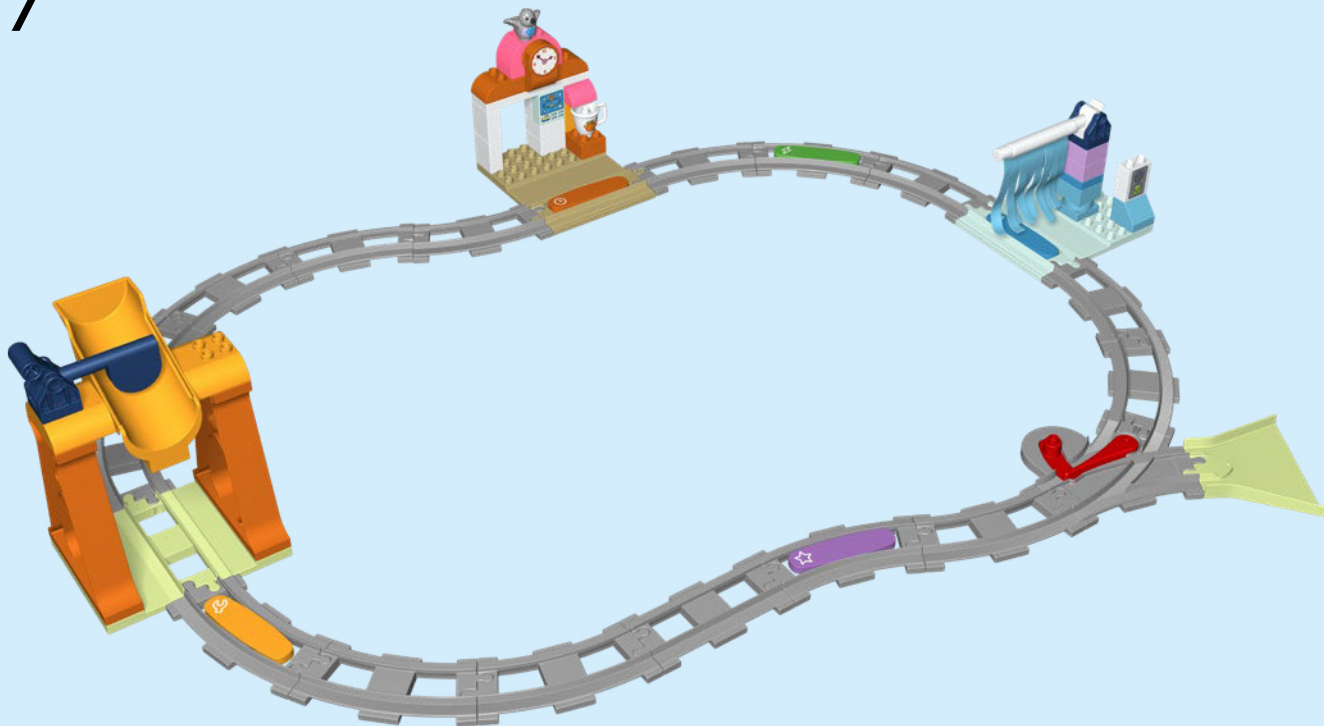

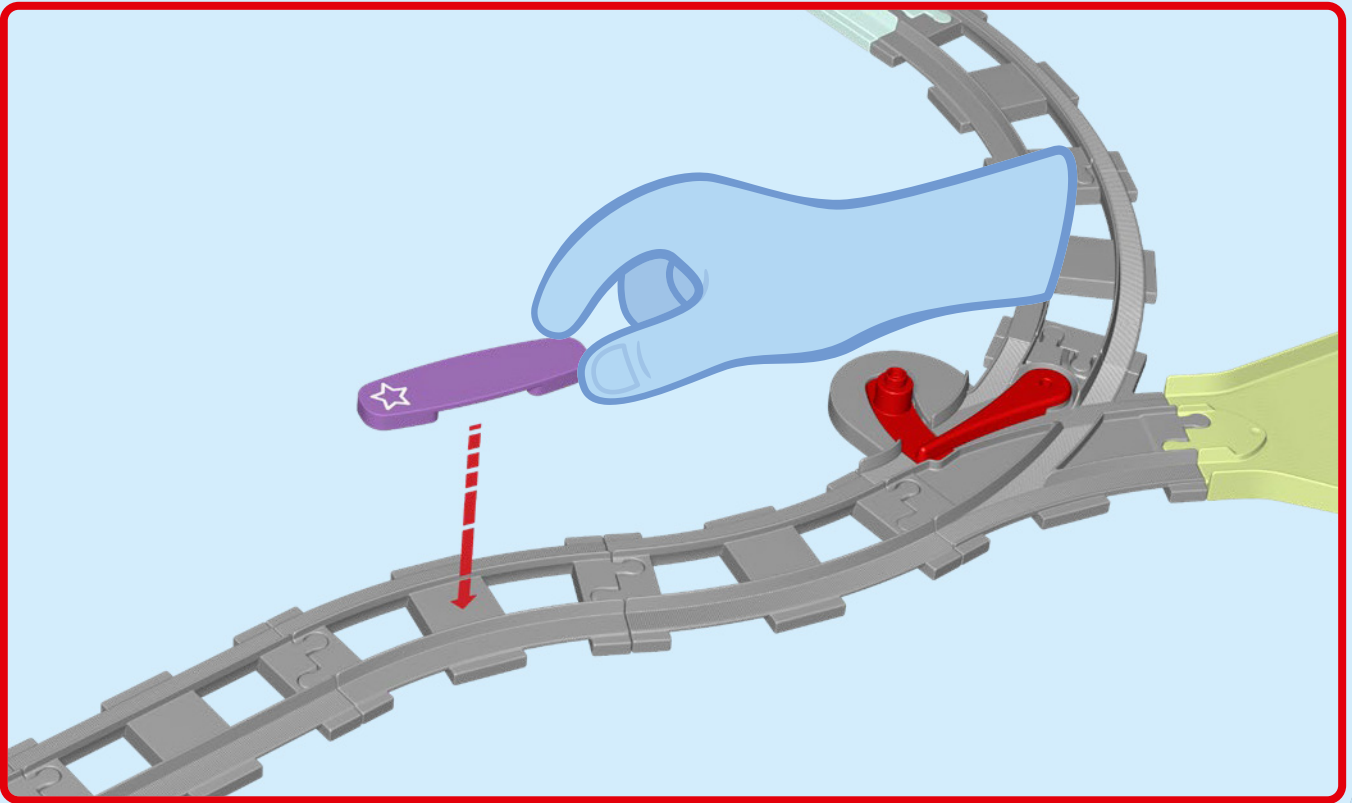

EXTEND PLAY
★ ★ ★ WITH THE ★ ★ ★
FREE APP

PROLONGEZ LE JEU
★ ★ ★ AVEC ★ ★ ★
L'APPLI GRATUITE

AMPLÍA EL JUEGO
★ ★ ★ CON LA ★ ★ ★
APP GRATUITA

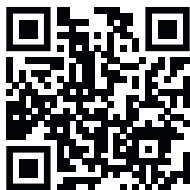

Apple and the Apple logo are trademarks of Apple Inc., registered in the U.S. and other countries and regions. App Store is a service mark of Apple Inc. Google Play and the Google Play logo are trademarks of Google LLC. Tencent and the Tencent logo are trademarks of Tencent Inc.

Q LEGO.com/devicecheck





Extend play • Prolongez le jeu • Amplía las posibilidades de juego

Have hours of fun together with the new LEGO® DUPLO® Interactive Train set! Find even more Learning Through Play ideas that support the developmental needs of your 2-3+ year-old.

Passez des heures à vous amuser avec les nouveaux ensembles de train interactif LEGO® DUPLO® ! Découvrez d'autres idées d'apprentissage par le jeu qui répondent aux besoins de développement de votre enfant de 2-3 ans et plus.

¡Diviértanse juntos durante horas con los nuevos trenes interactivos LEGO® DUPLO®! Conoce nuevas ideas de aprendizaje mediante el juego, adaptadas a los requisitos de desarrollo de niños y niñas de 2-3+ años.

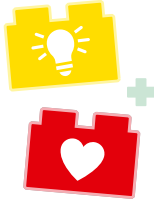

Customize • Personnalisez • Personaliza

Program and activate lots of inspirational sound effects in the special Action Brick. Find a playful song to go with your train adventures, or record your own short sound effects together.

Programmez et activez de nombreux effets sonores inspirants dans la brique d'action spéciale. Trouvez une chanson amusante pour accompagner vos aventures ferroviaires ou enregistrez ensemble vos propres effets sonores.

Programa y activa un montón de inspiradores efectos de sonido con el brick de acción especial. Encuentren una canción divertida para vivir aventuras ferroviarias, o graben juntos sus propios efectos de sonido breves.



Control • Contrôlez • Controla

The Remote-Control function puts your young train conductor right in the driver's seat. With intuitive commands, you can sound the train horn, control the lights, and drive the train back and forth. Enjoy the journey!

La fonction de contrôle à distance place votre jeune conducteur de train au volant. Grâce à des commandes intuitives, vous pouvez faire retentir le klaxon, contrôler les lumières et faire avancer ou reculer le train. Bon voyage !

La función de control remoto pone a tu joven constructor en el asiento del maquinista. Usando intuitivos comandos, podrán hacer sonar el silbato del tren, controlar las luces y manejar el tren hacia adelante y hacia atrás. ¡Disfruten del viaje!







10425



10426



10427



10428

4x 1.5V LR 03 (AAA)
1:1





1x
6442943



1x
6463924



1x
6226885



1x
6478079

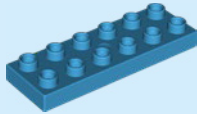

1x
6167685

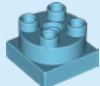

1x
6303199



1x
6172514

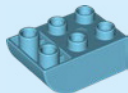

1x
6167834



1x
6478094



2x
4266228

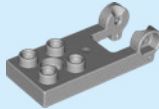

2x
6310412



1x
6464779

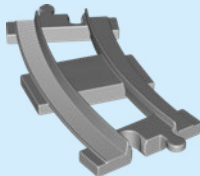

15x
6207493

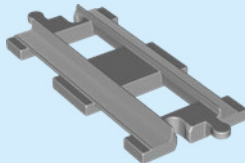

1x
6207494



1x
6478090



1x
6446310



1x
6480167



2x
4654789



1x
6478089



4x
6209859

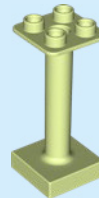

1x
6490943

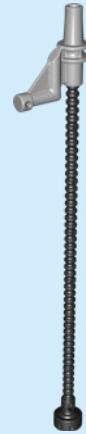

1x
4548111



1x
6478088



2x
6481109



1x
6466889

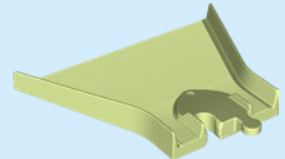

1x
6465960



1x
6376729



1x
6491600



1x
6478083



2x
4183780



1x
6491580



2x
6481108



2x
4226194



3x
6101121



1x
6127191



1x
6478087



1x
6393151



1x
6478085



1x
6478086



1x
6187321



1x
6104418



1x
6294240

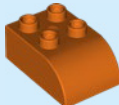

2x
6490877



1x
6478084

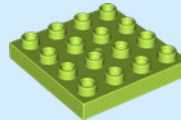

1x
6327077



1x
6214736

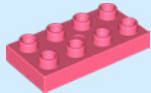

2x
6288476



1x
6481116



2x
343701

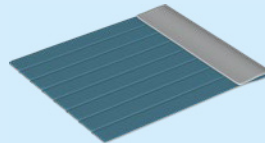

1x
6411819



1x
4121575



1x
6478080

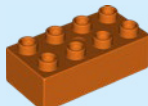

1x
6481102



1x
6481122

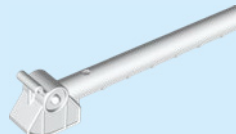

1x
6037884

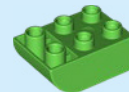

1x
6486218

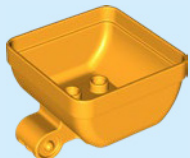

2x
6481124



1x
6478078



1x
301101

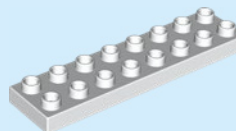

1x
4563575



1x
6478082



1x
6471949



2x
6481141

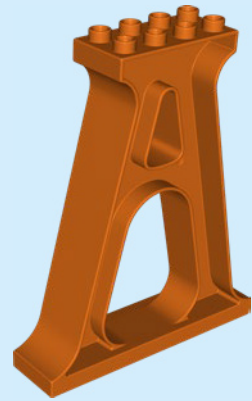

2x
6481132

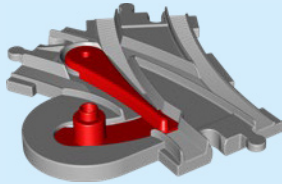

1x
6207508

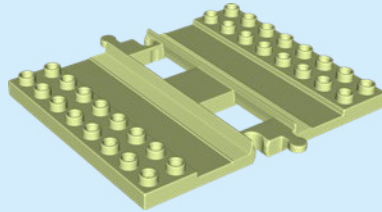

1x
6481090

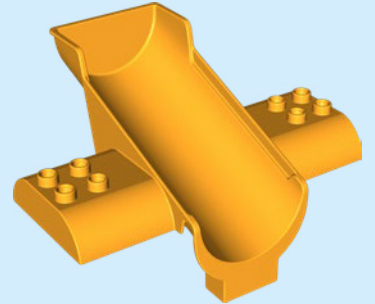

1x
6481138



1x
6478077

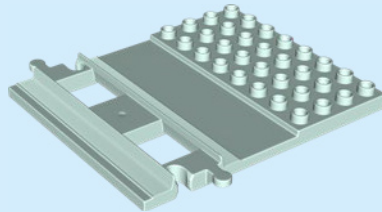

1x
6490945

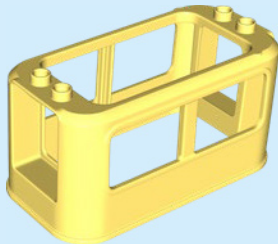

1x
6465964

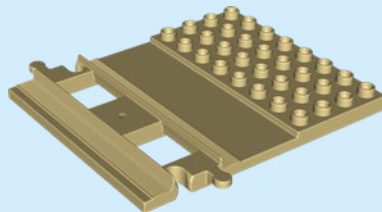

1x
6481125



 [LEGO.com/service](https://www.LEGO.com/service)

YOU COULD **WIN**

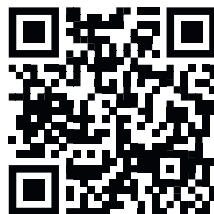

Scan this QR code or go to **LEGO.COM/PRODUCTFEEDBACK** and give us your short feedback about this LEGO® set for a chance to win a cool LEGO prize.

Terms and Conditions apply*

EN: YOU COULD WIN. Terms and Conditions apply* **DE: Du könntest GEWINNEN.** Es gelten die Teilnahmebedingungen* **FR: Tu pourrais GAGNER.** Des conditions s'appliquent* **IT: Potresti VINCERE tu.** Termini e condizioni sono applicabili* **ES: Puedes GANAR.** Aplican términos y condiciones* **PT: Poderá GANHAR.** Aplicam-se termos e condições* **ZH: 轻松获奖. 条款和条件适用*** **PL: Szansa na WYGRANĄ.** Obowiązują warunki korzystania* **CS: Máte šanci VYHRÁT.** Platí všeobecné smluvní podmínky* **SK: Máte šancu VYHRAŤ.** Platia všeobecné zmluvné podmienky* **HU: TE IS NYERHETSZ.** Felhasználási feltételek érvényesek* **RO: Ai putea CÂȘTIGA.** Se aplică termeni și condiții* **BG: Можете да СПЕЧЕЛИТЕ.** Има определени правила и условия* **LV: Tu vari LAIMĒT.** Ir spēkā noteikumi un nosacījumi.* **ET: Sul on võimalus VÕITA.** Kehtivad tingimused* **LT: Jūs galite LAIMĖTI.** Taikomos sąlygos*

*[LEGO.com/productfeedback-terms](https://www.lego.com/productfeedback-terms)

LEGO, the LEGO logo, DUPLO and the DUPLO logo are trademarks of the/son des marques de commerce du/son marcas registradas de LEGO Group. ©2025 The LEGO Group.