



# STAR WARS™

75391



Q LEGO® Builder



## **Get excited about our new packaging!**

We're switching from plastic to paper-based packaging. That's why you might find a mix of paper and plastic in our boxes!

## **Nos nouveaux emballages vous emballeront !**

Nous passons des emballages en plastique aux emballages à base de papier. C'est pourquoi vous pourriez trouver un mélange de papier et de plastique dans nos boîtes !

## **¡Te presentamos nuestros nuevos empaques!**

Estamos sustituyendo las bolsas de plástico por bolsas con base de papel. ¡Por eso, puedes encontrar una mezcla de papel y de plástico en nuestras cajas!

**[LEGO.com/sustainable-packaging](https://www.lego.com/sustainable-packaging)**



Q LEGO® Builder

# BUILDER



Apple and the Apple logo are trademarks of Apple Inc., registered in the U.S. and other countries and regions. App Store is a service mark of Apple Inc. Google Play and the Google Play logo are trademarks of Google LLC. Tencent and the Tencent logo are trademarks of Tencent Inc.

Q [LEGO.com/devicecheck](https://lego.com/devicecheck)

**EN** Ask parents' permission before going online | **DE** Eltern um Erlaubnis bitten, bevor du online gehst | **FR** Demande l'autorisation d'un parent avant d'aller en ligne | **IT** Chiedi il permesso ai tuoi genitori prima di andare online | **ES** Pídeles permiso a tus papás antes de conectarte a Internet | **PT** Peça autorização aos pais antes de acederes online | **ZH** 上网前应先征得父母的同意 | **PL** Poproś rodziców o zgodę, zanim wejdiesz do Internetu | **CS** Než půjdeš na internet, požádej rodiče o svolení | **SK** Skôr než pôjdeš na internet, vypýtaj si povolenie od rodičov | **HU** Kérj szülői engedélyt, mielőtt online csatlakoznál! | **RO** Cere permisiunea părinților înainte de a te conecta online | **BG** Поискайте разрешение от родител, преди да влезете онлайн | **LV** Pirms došanās tiešsaistē palūdz atļauju vecākiem | **ET** Enne Interneti kasutamist küsi vanematelt luba | **LT** Prieš prisijungdami prie interneto, atsiklauskite tėvų



# STAR WARS™



Join the 25<sup>th</sup> Anniversary  
at [LEGO.com/SW-25](http://LEGO.com/SW-25)

Participez au 25<sup>e</sup> anniversaire  
sur [LEGO.com/SW-25](http://LEGO.com/SW-25)

Participa en el 25 aniversario  
en [LEGO.com/SW-25](http://LEGO.com/SW-25)

**25**  
ANS DE  
LEGO® STAR WARS™

**25**  
AÑOS DE  
LEGO® STAR WARS™







1

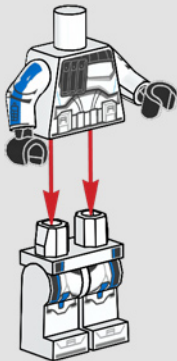

2

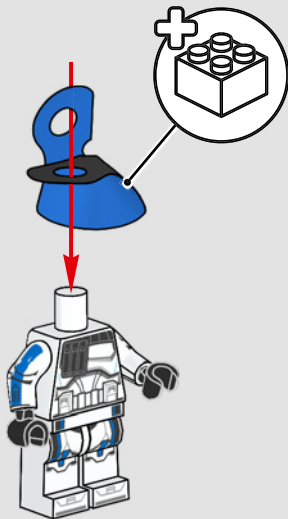

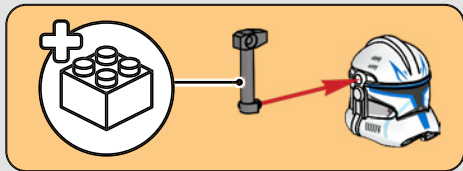

3

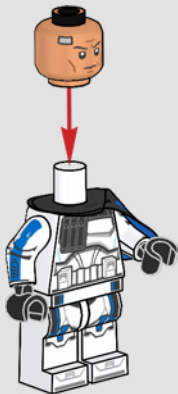

4

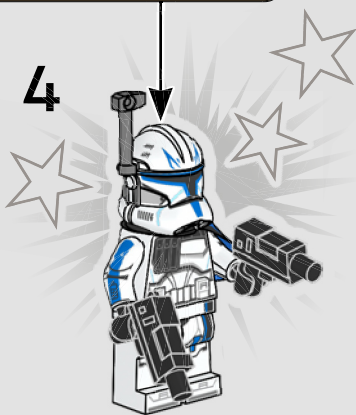

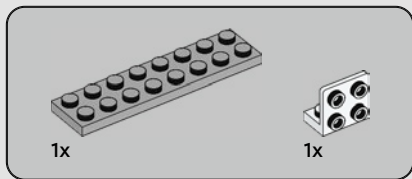

1

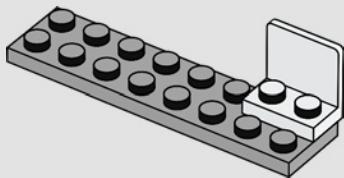

8





1x

2

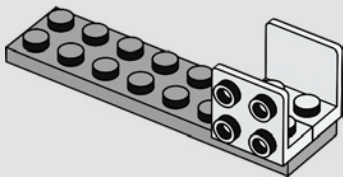



1x

3

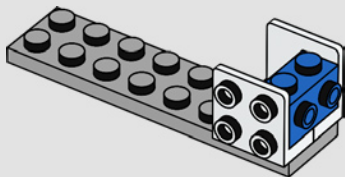

10





1x

4

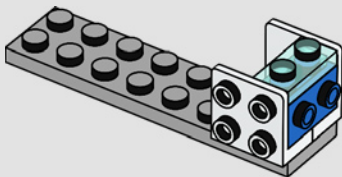



1x



1x

5

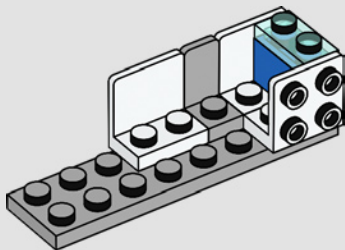





1x



1x

6

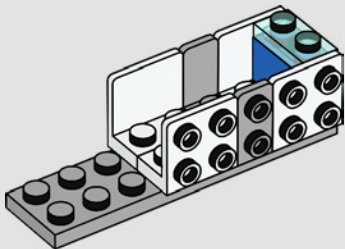

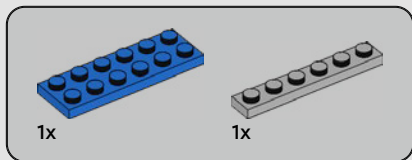

7

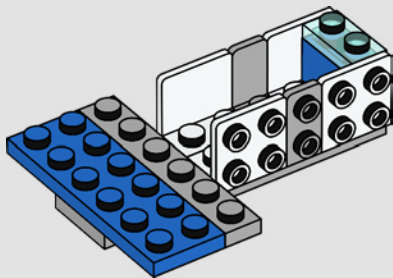

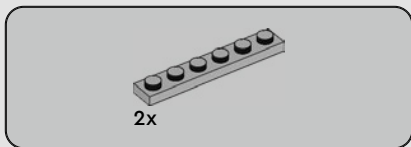

8

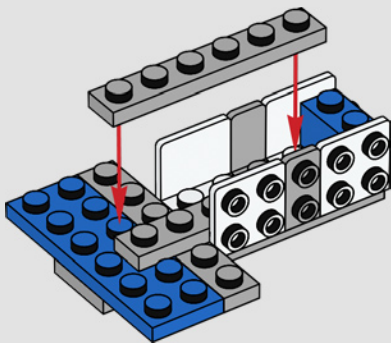



1x

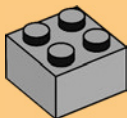

9

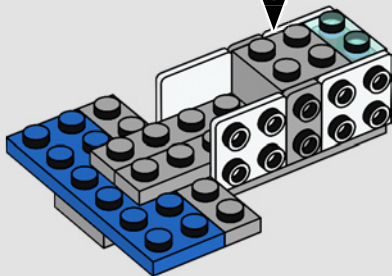



1x



2x

# 10

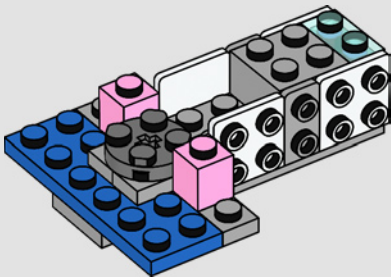



1x

11

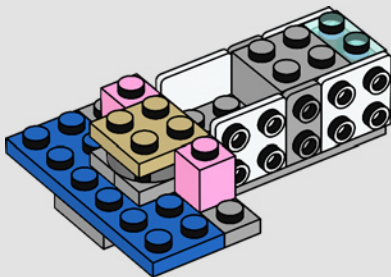



2x

12

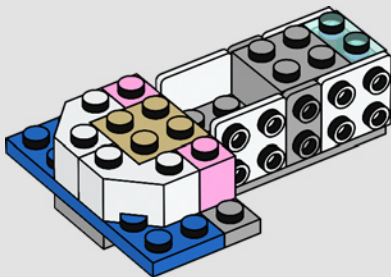



2x

# 13

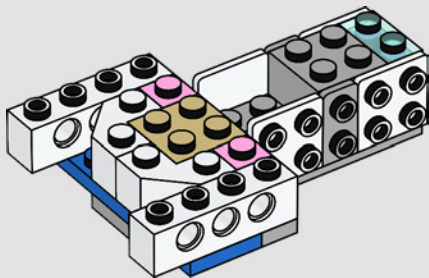





1x

14

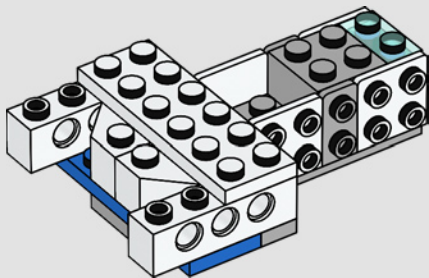



1x



1x

# 15

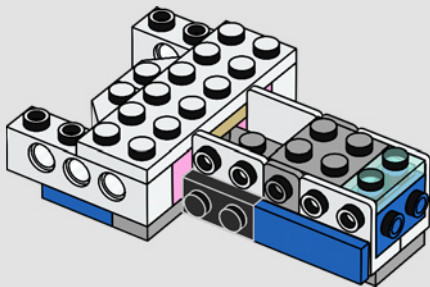



16

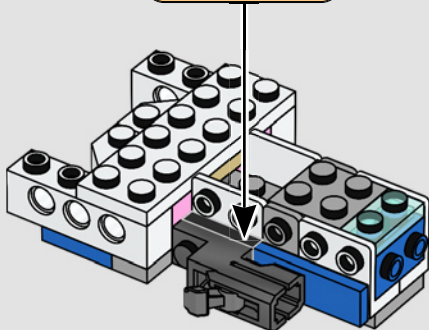
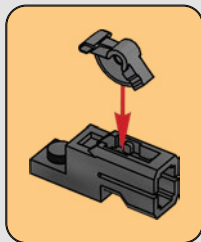



1x



1x

17

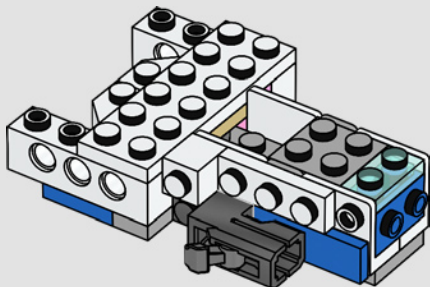



1x

18

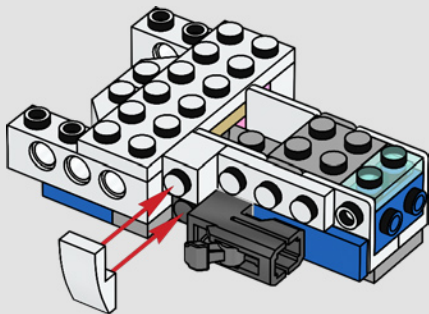



1x



1x

# 19

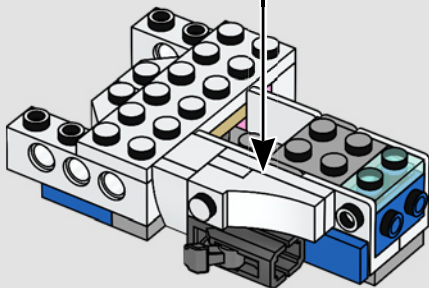
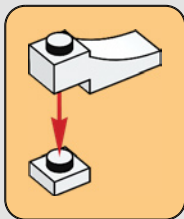





1x



1x

# 21

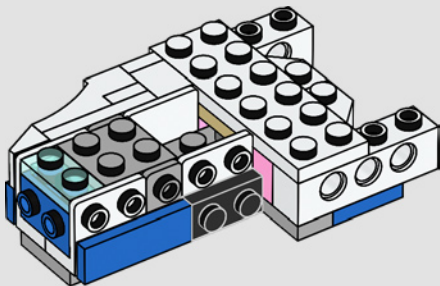





22

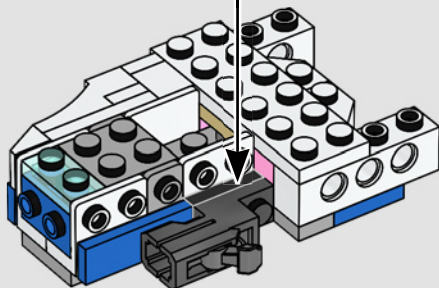
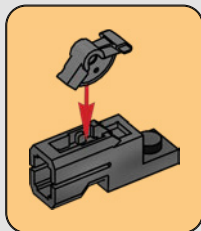





1x

# 24

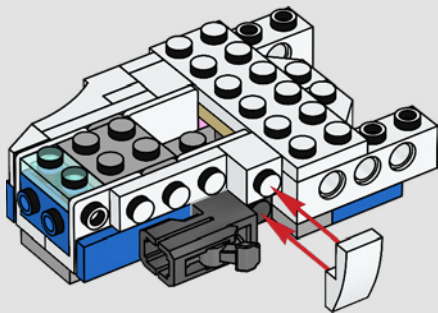



1x



1x

# 25

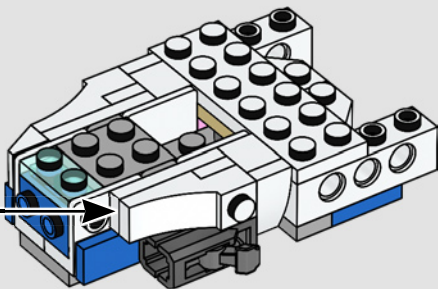
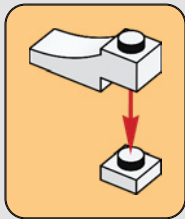



1x

# 26

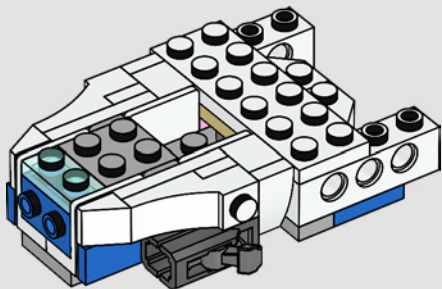



1x

27

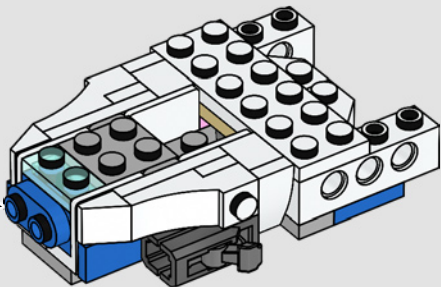



2x

# 28

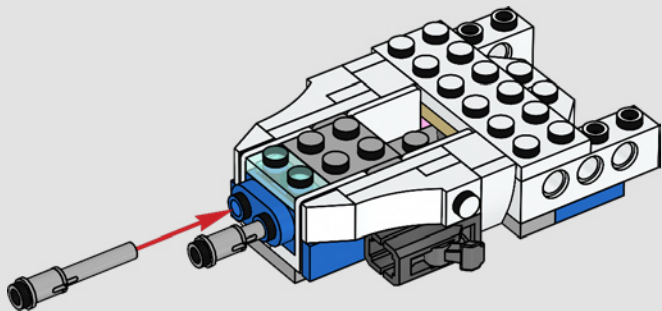







4x

29

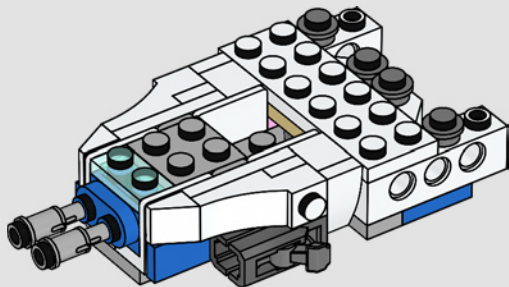



3x

30

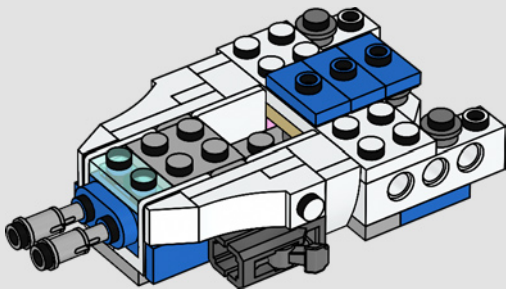



2x



2x

# 31

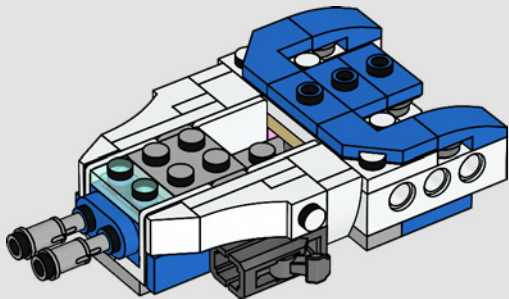



1x

32

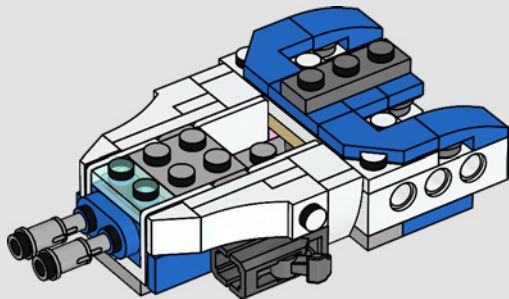



1x



1x

# 33

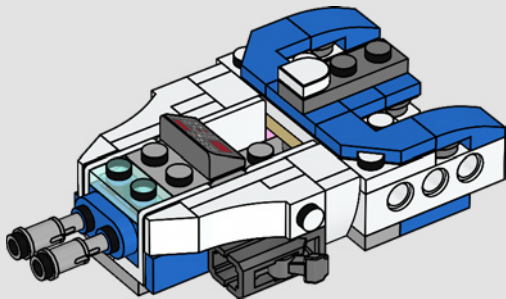

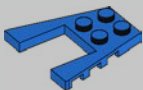

1x

# 34

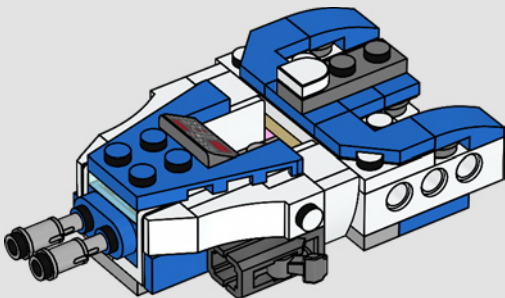



2x

# 35

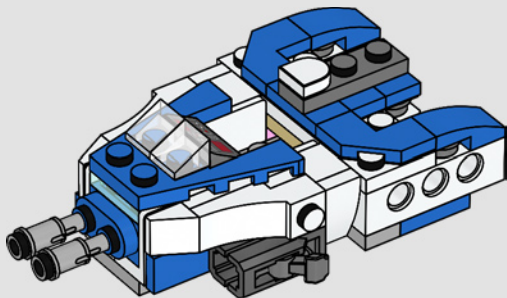

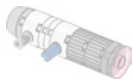

2x



1x



1x

36

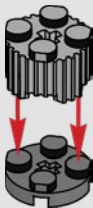



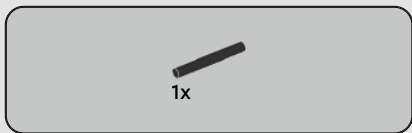

37





1x

# 38





1x



1x

# 39





1x

# 40





1x



1x

41





1x



1x

# 42





1x

43

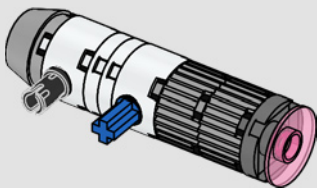

2x



44

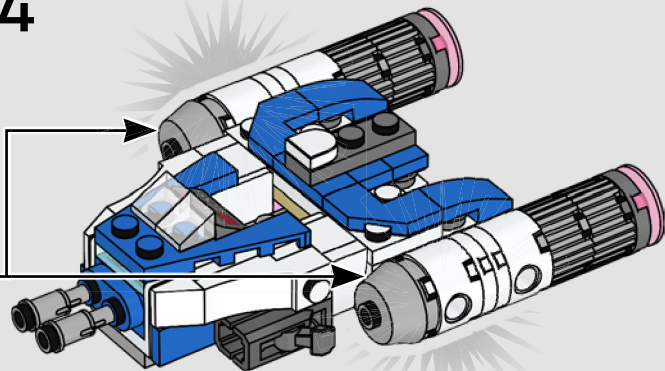





4x

45

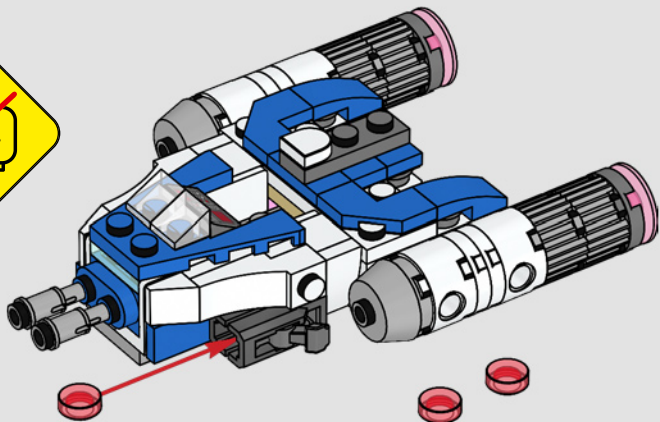

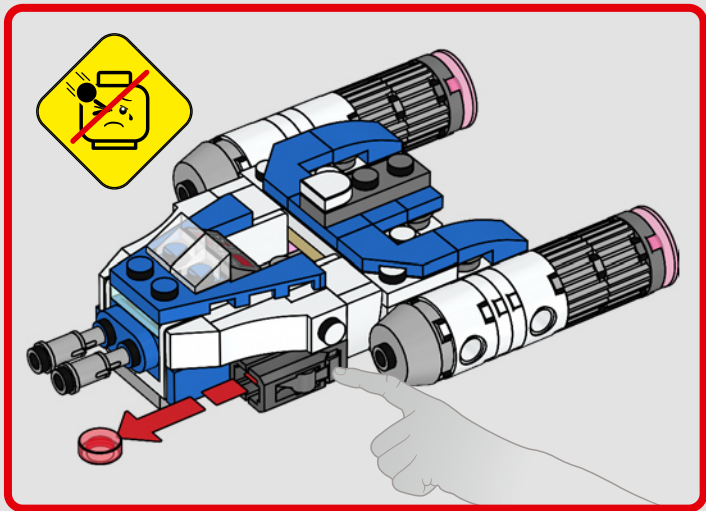

46

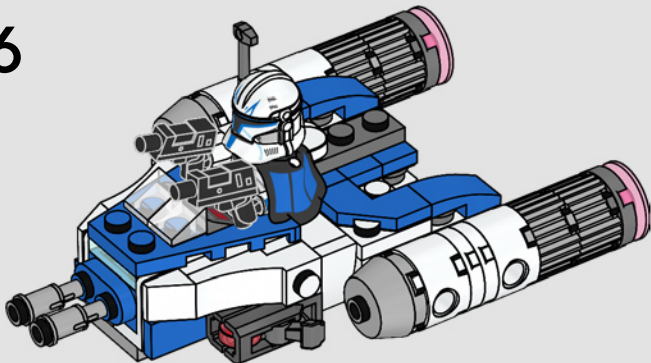

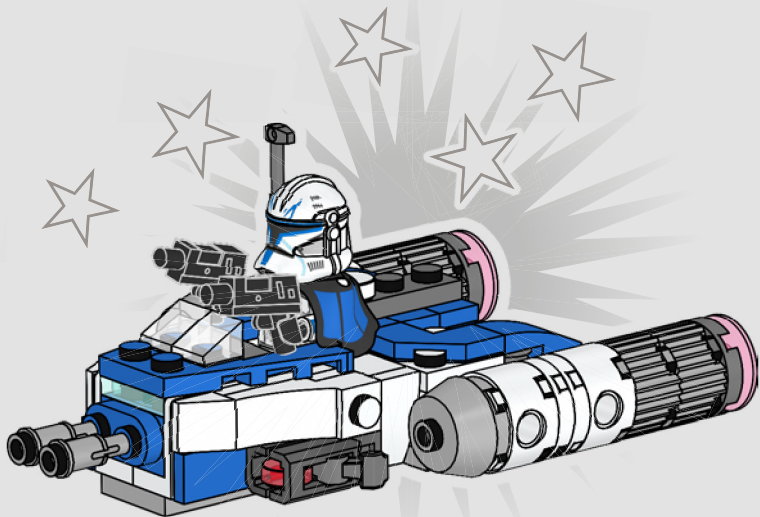



# STAR WARS™

75386



75390



75391



75373





1x  
6250591



2x  
6034044



2x  
370101



1x  
6315291



1x  
6240222



2x  
4504369



4x  
6097637



1x  
379501



2x  
6333512



2x  
6245302



2x  
300501



2x  
6137926



1x  
6461160



2x  
4587840



2x  
6103643



2x  
302401



2x  
362301



1x  
379523



3x  
6092582



2x  
6279875



1x  
6447201



2x  
6357598



1x  
6457102



1x  
6315482



2x  
302326



4x  
403201



1x  
6447206



2x  
6055065



2x  
4206482



2x  
6093525



4x  
6218899



4x  
4650645



2x  
6028324



1x  
4211387



3x  
4211438



2x  
6347715



2x  
6345639



1x  
4211133



2x  
6345952



3x  
4211042



4x  
4210633



2x  
6360675



1x  
6152814



2x  
6245250



2x  
4286050



1x  
4114084



1x  
6447202



4x  
6258607



1x  
4211406

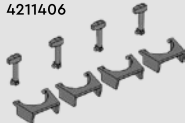

8x  
6461466



[LEGO.com/service](https://www.LEGO.com/service)

YOU COULD

WIN



Scan this QR code or go to  
**LEGO.COM/PRODUCTFEEDBACK** and give us  
your short feedback about this LEGO® set  
for a chance to win a cool LEGO prize.

Terms and Conditions apply\*

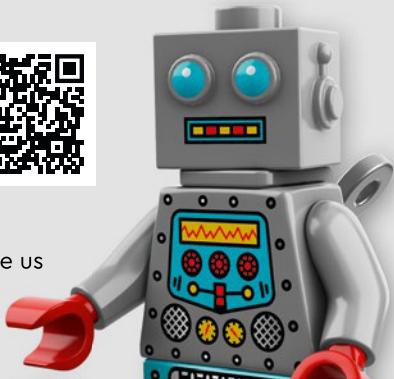

**EN: YOU COULD WIN.** Terms and Conditions apply\* **DE: Du könntest GEWINNEN.** Es gelten die Teilnahmebedingungen\* **FR: Tu pourrais GAGNER.** Des conditions s'appliquent\* **IT: Potresti VINCERE tu.** Termini e condizioni sono applicabili\* **ES: Puedes GANAR.** Aplican términos y condiciones\* **PT: Poderá GANHAR.** Aplicam-se termos e condições\* **ZH: 轻松获奖.** 条款和条件适用\* **PL: Szansa na WYGRANĄ.** Obowiązują warunki korzystania\* **CS: Máte šanci VYHRÁT.** Platí všeobecné smluvní podmínky\* **SK: Máte šancu VYHRÁŤ.** Platia všeobecné zmluvné podmienky\* **HU: TE IS NYERHETSZ.** Felhasználási feltételek érvényesek\* **RO: Ai putea CÂȘTIGA.** Se aplică termeni și condiții\* **BG: Можете да СПЕЧЕЛИТЕ.** Има определени правила и условия\* **LV: Tu vari LAIMĒT.** Ir spēkā noteikumi un nosacījumi.\* **ET: Sul on võimalus VÕITA.** Kehtivad tingimused\* **LT: Jūs galite LAIMĖTI.** Taikomos sąlygos\*

\*[LEGO.com/productfeedback-terms](https://www.lego.com/productfeedback-terms)

LEGO and the LEGO logo are trademarks of the/son des marques de commerce du/  
son marcas registradas de LEGO Group. ©2024 The LEGO Group.

© & ™ Lucasfilm Ltd.

6522630