



# NINJAGO

DRAGONS RISING

71816



Q LEGO® Builder



[LEGO.com/sustainable-packaging](https://LEGO.com/sustainable-packaging)



**FR**  
**DONNEZ**  
OU  
**RECYCLEZ**

 OU  OU 

ASSOCIATION    MAGASIN    DÉCHÈTERIE

Adresses sur [quefairedemesdechets.fr](https://quefairedemesdechets.fr)



Q LEGO® Builder

# BUILDER



Apple and the Apple logo are trademarks of Apple Inc., registered in the U.S. and other countries and regions. App Store is a service mark of Apple Inc. Google Play and the Google Play logo are trademarks of Google LLC. Tencent and the Tencent logo are trademarks of Tencent Inc.

Q [LEGO.com/devicecheck](https://LEGO.com/devicecheck)

**EN** Ask parents' permission before going online | **DE** Eltern um Erlaubnis bitten, bevor du online gehst | **FR** Demande l'autorisation d'un parent avant d'aller en ligne | **IT** Chiedi il permesso ai tuoi genitori prima di andare online | **ES** Pídeles permiso a tus papás antes de conectarte a Internet | **PT** Pede autorização aos pais antes de acederes online | **ZH** 上网前应先征得父母的同意 | **PL** Poproś rodziców o zgodę, zanim wejdiesz do Internetu | **CS** Než půjdeš na internet, požádej rodiče o svolení | **SK** Skôr než pôjdeš na internet, vypýtaj si povolenie od rodičov | **HU** Kérj szülői engedélyt, mielőtt online csatlakoznál! | **RO** Cere permisiunea părinților înainte de a te conecta online | **BG** Поискайте разрешение от родител, преди да влезете онлайн | **LV** Pirms došanās tiešsaistē palūdz atļauju vecākiem | **ET** Enne Interneti kasutamist küsi vanematelt luba | **LT** Prieš prisijungdami prie interneto, atsiklauskite tėvų





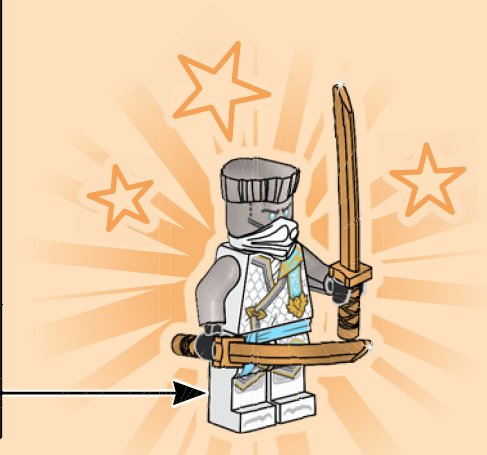
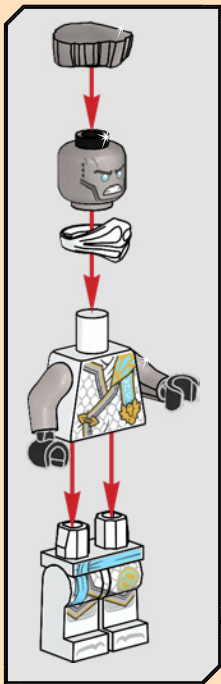

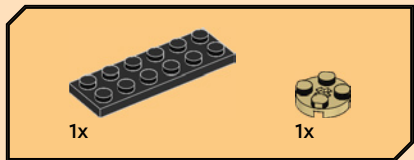

1

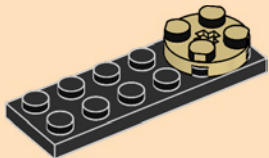

6



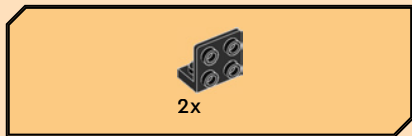

2

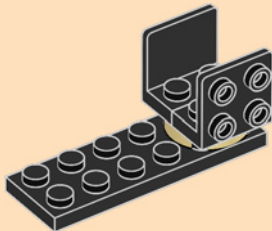



3

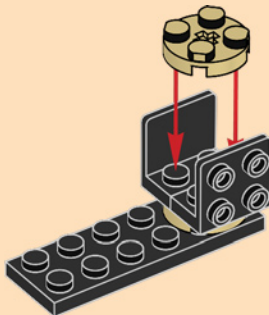





4

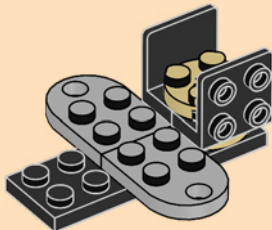

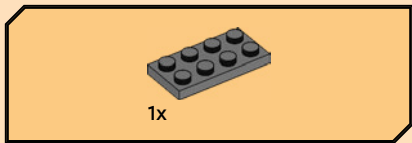

5

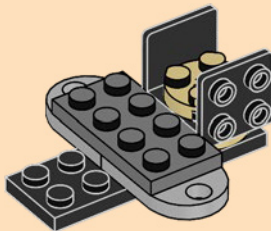

10







1x

7

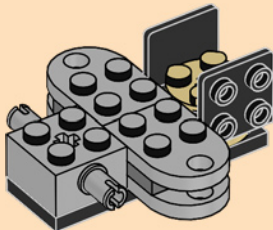

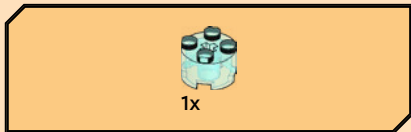

8

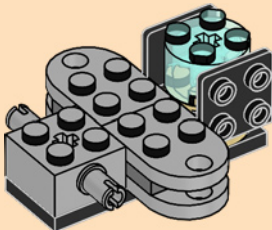



2x

9

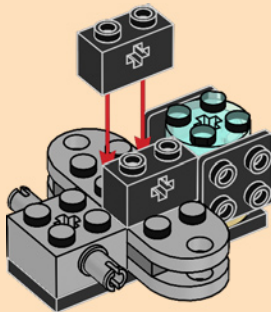

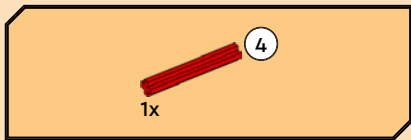

10

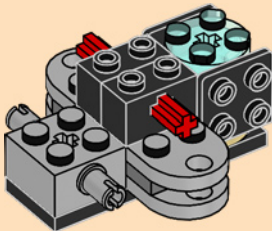



1x

11

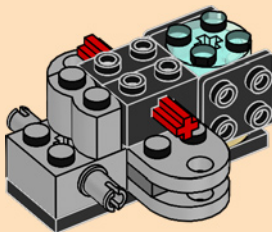



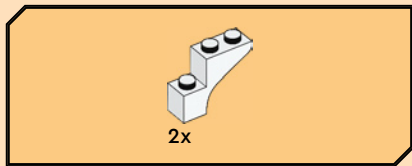

12

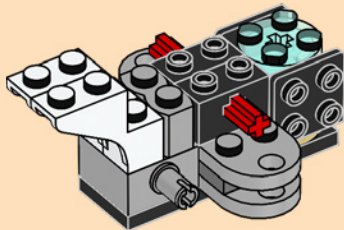

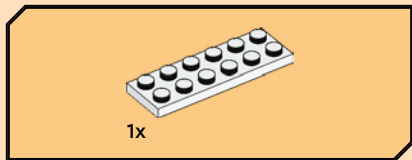

13

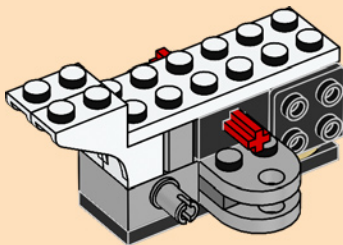

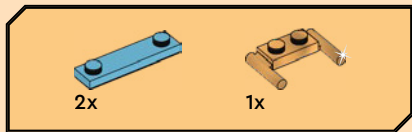

14

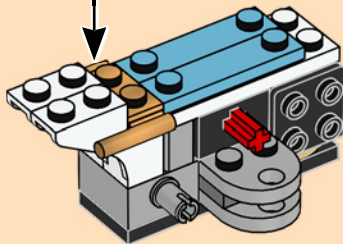
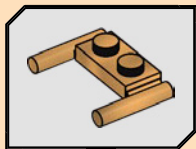



1x

15

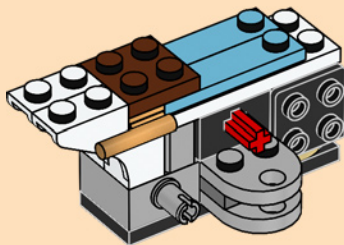

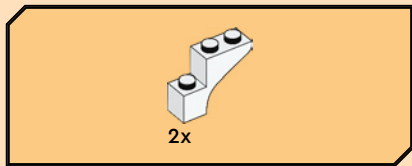

16

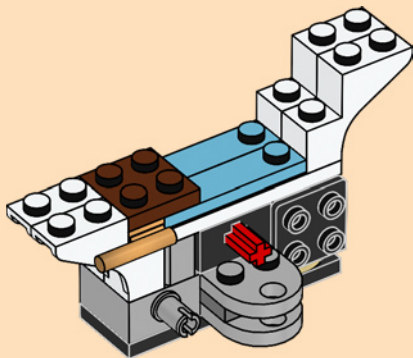



2x

17

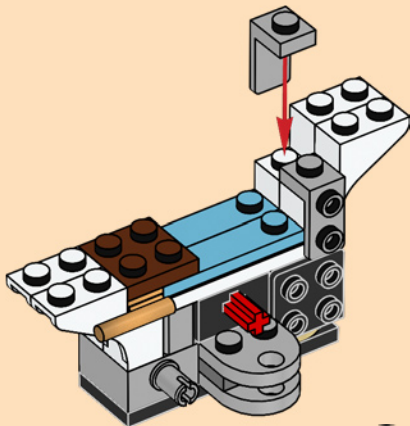

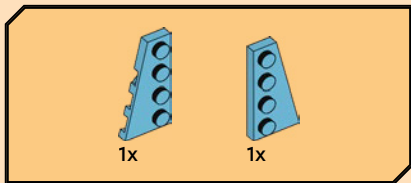

18

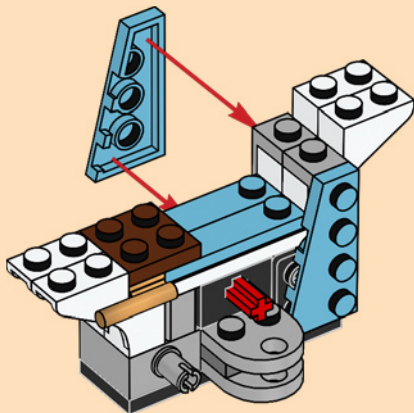









1x

# 21

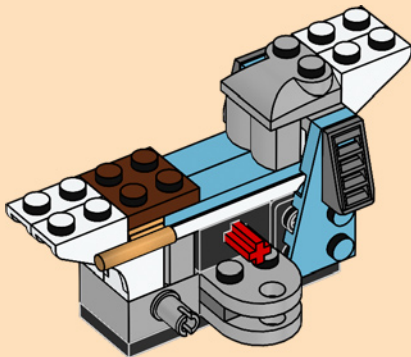



1x

22

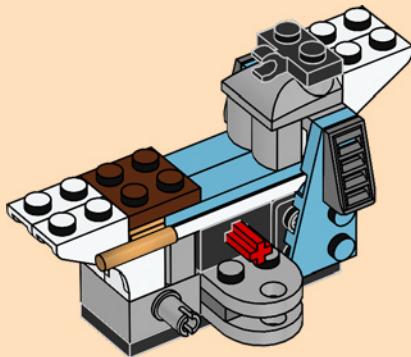

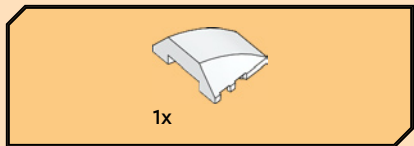

23

1

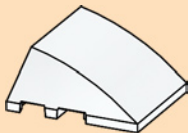

2

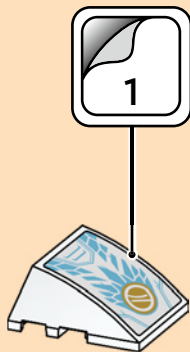

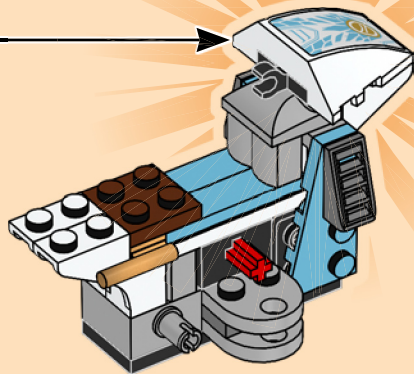



1x

24

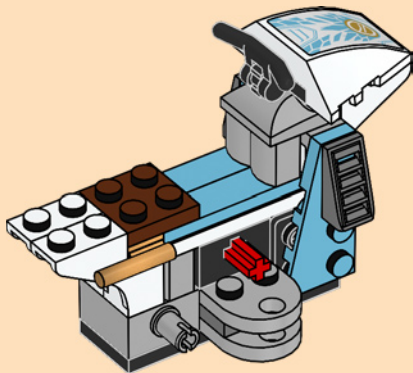



1x



2x

# 25

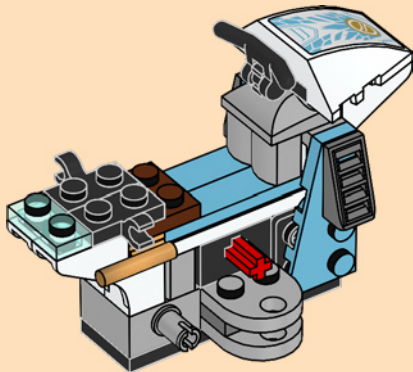



1x

26

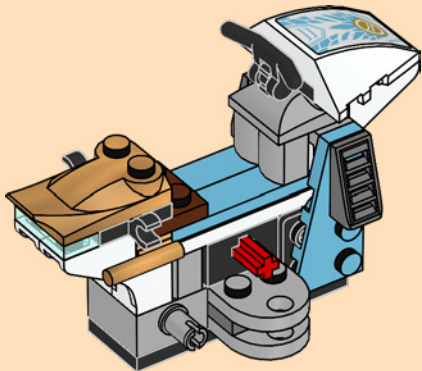



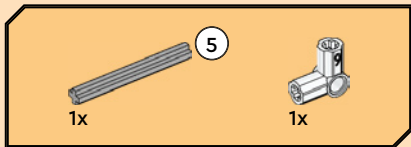
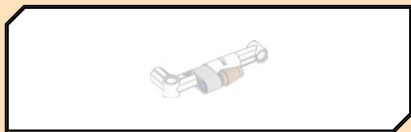

27

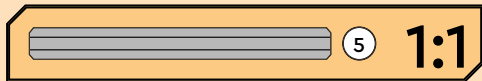
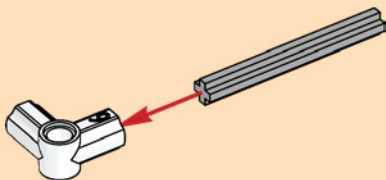

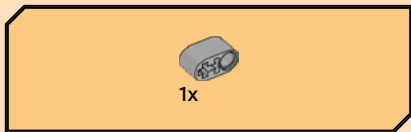

28

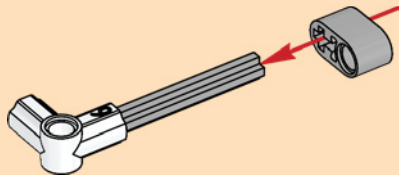

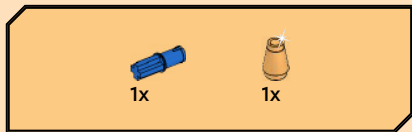

29

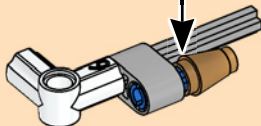
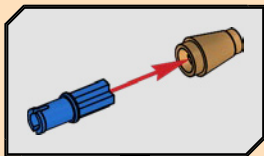



1x



1x

# 30

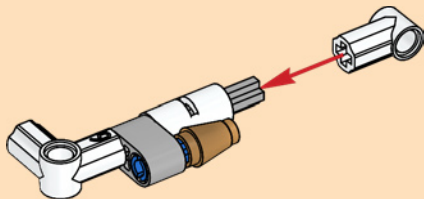

31

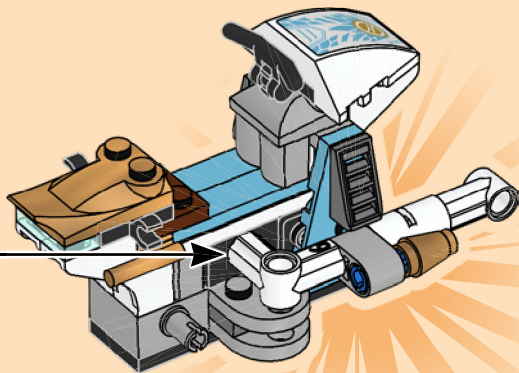

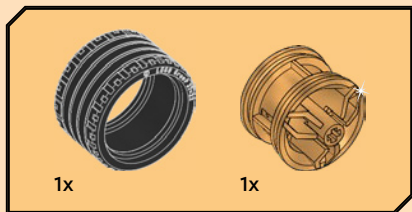

32

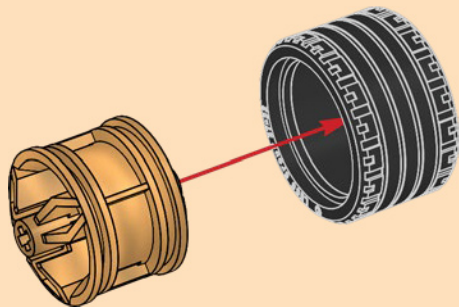



2x

# 33

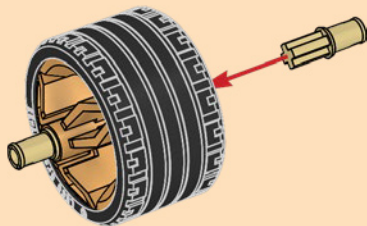

34

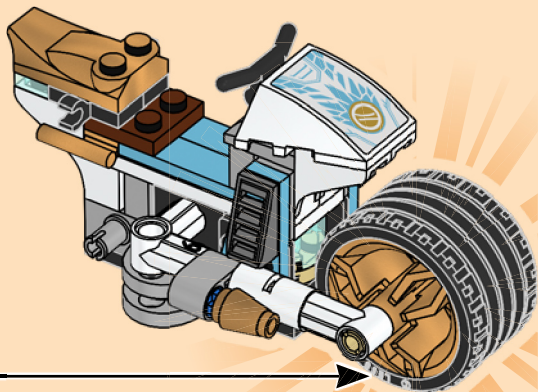



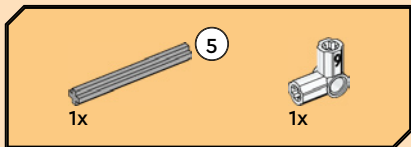
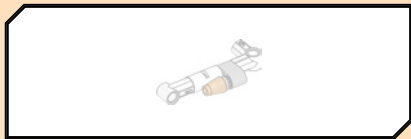

35

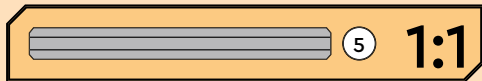
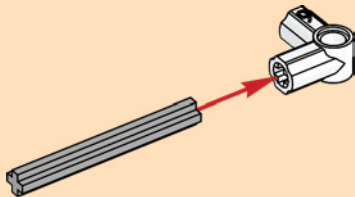

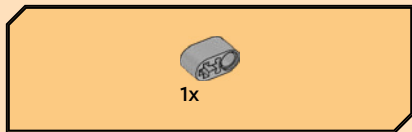

36

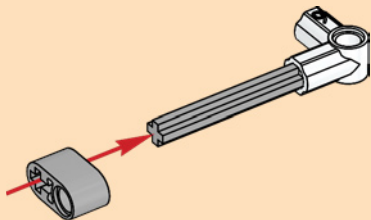

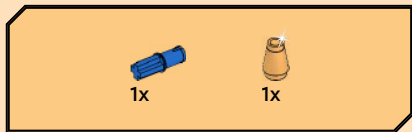

37

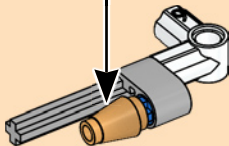
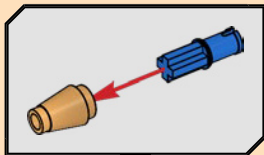



1x



1x

# 38

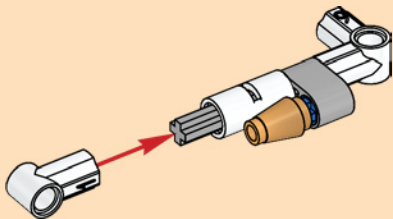

39

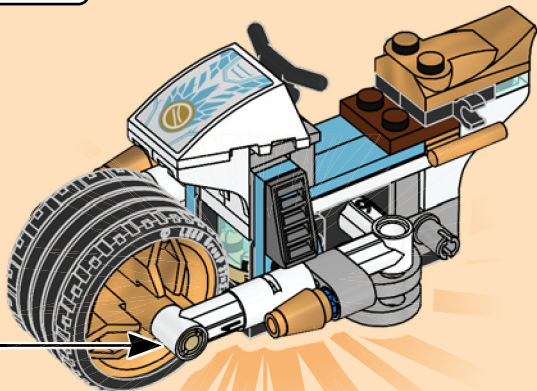

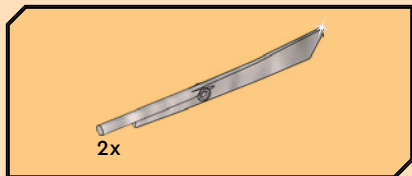

40

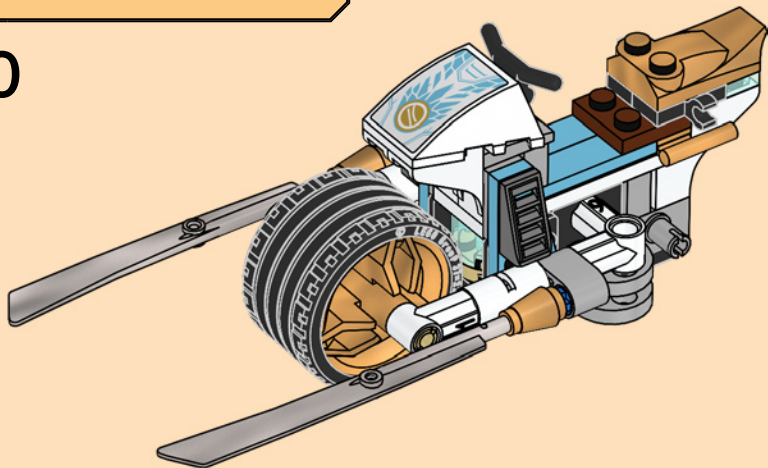



2x

41

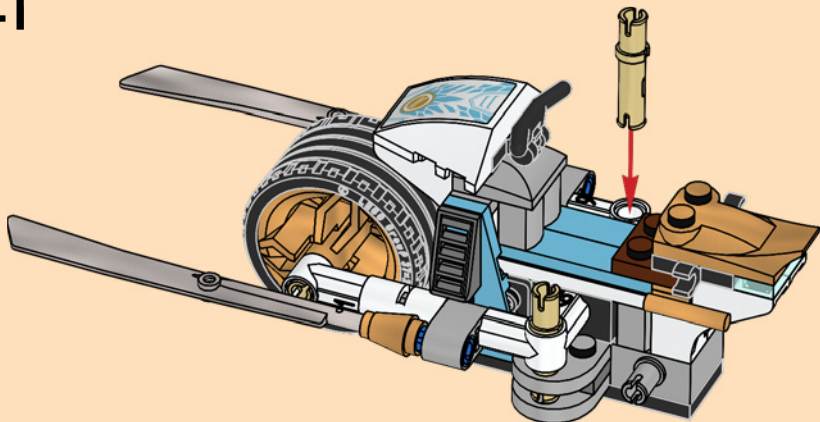

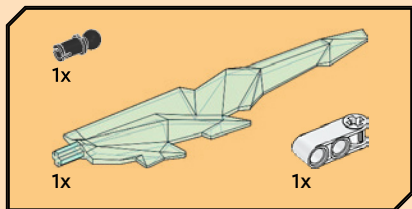

# 42

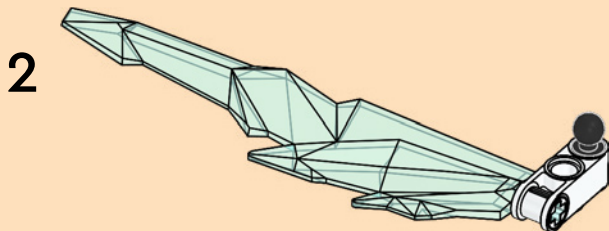
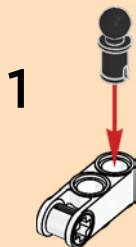



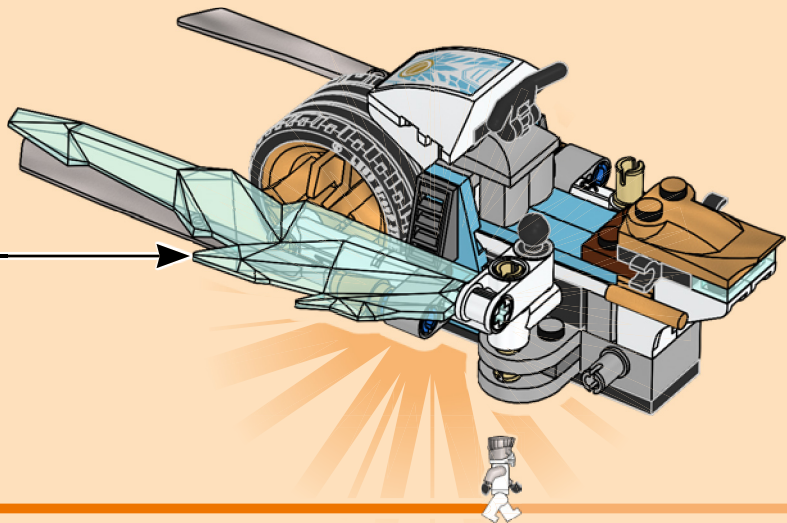

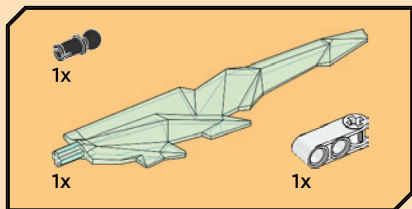

43

1



2

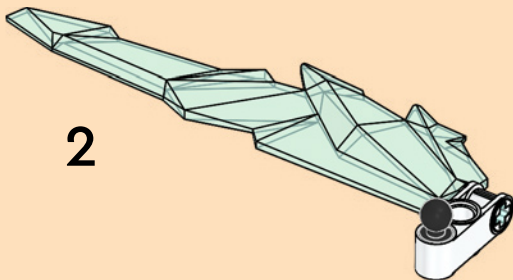

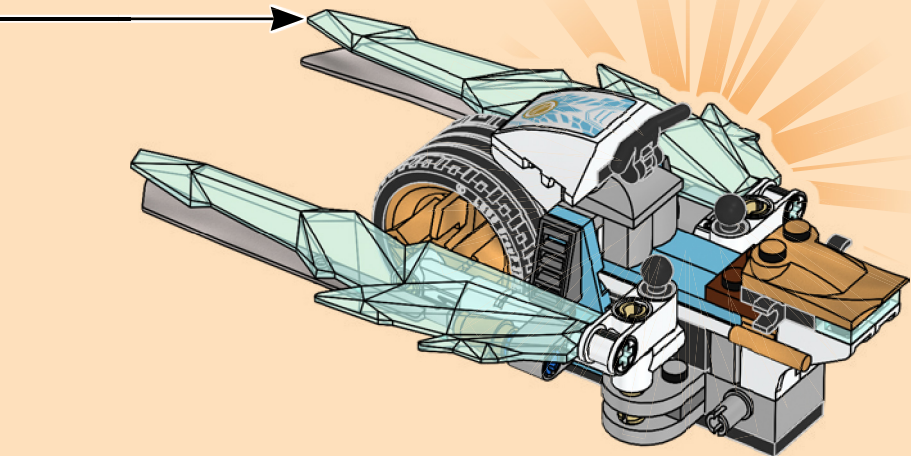

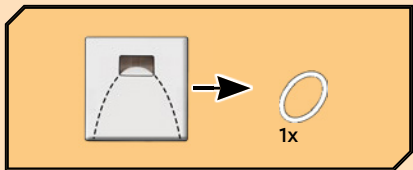

44

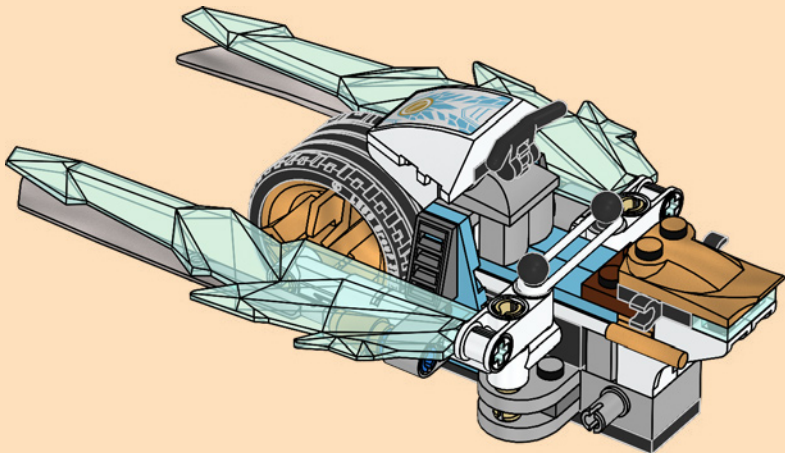

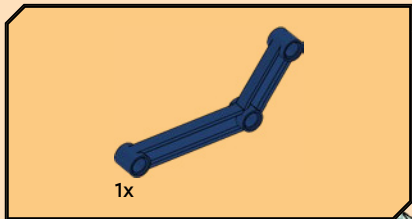

45

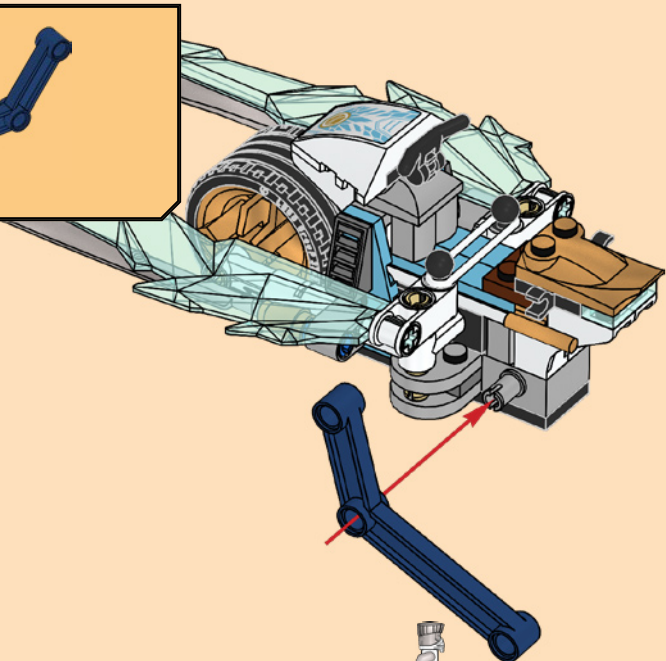

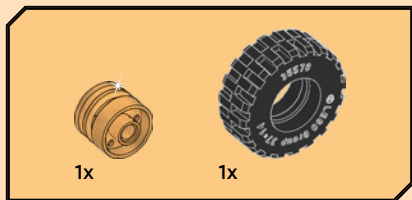

46

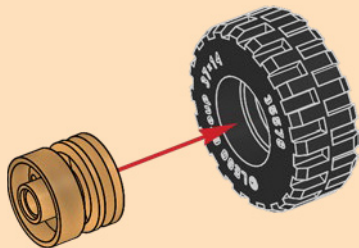



2x

47

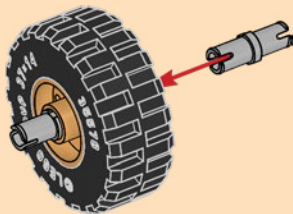

48

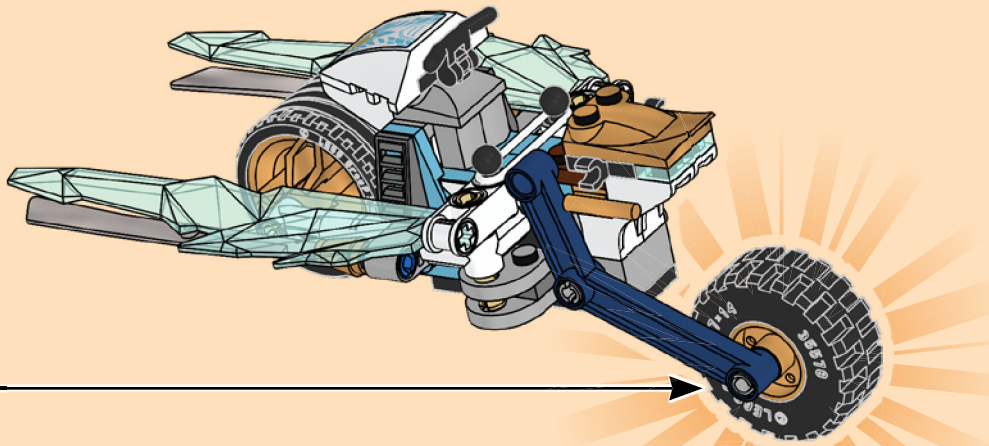

56



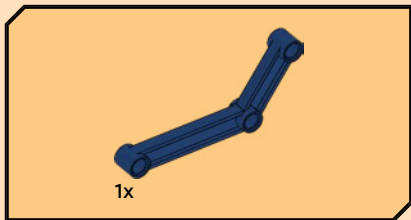

49

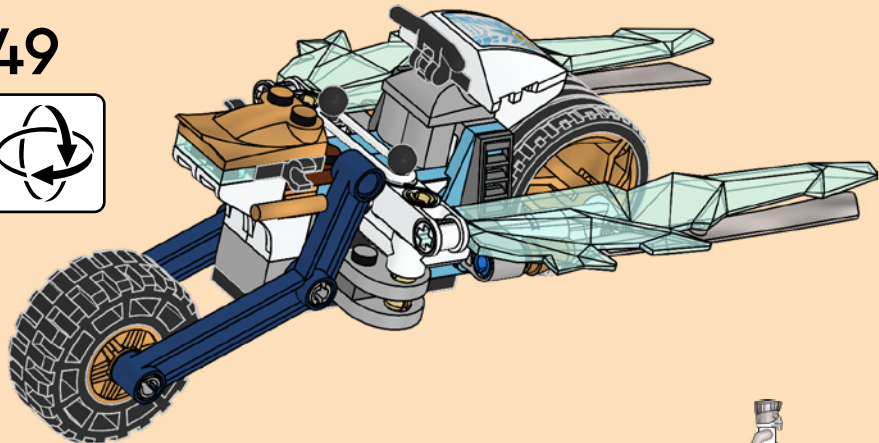



1x

50

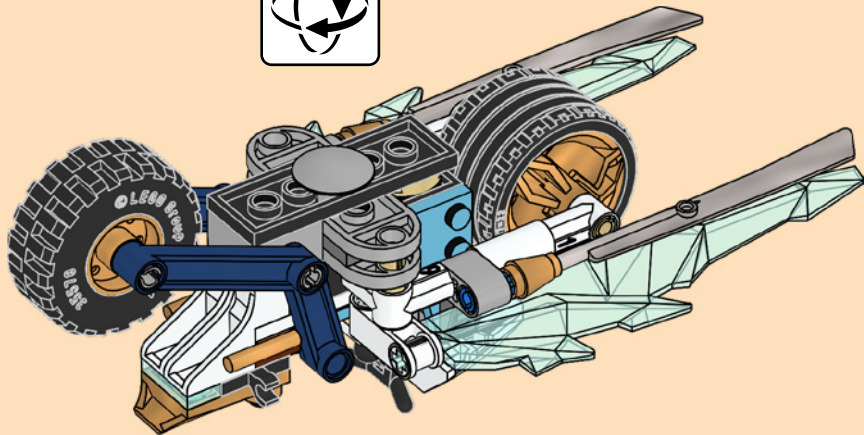

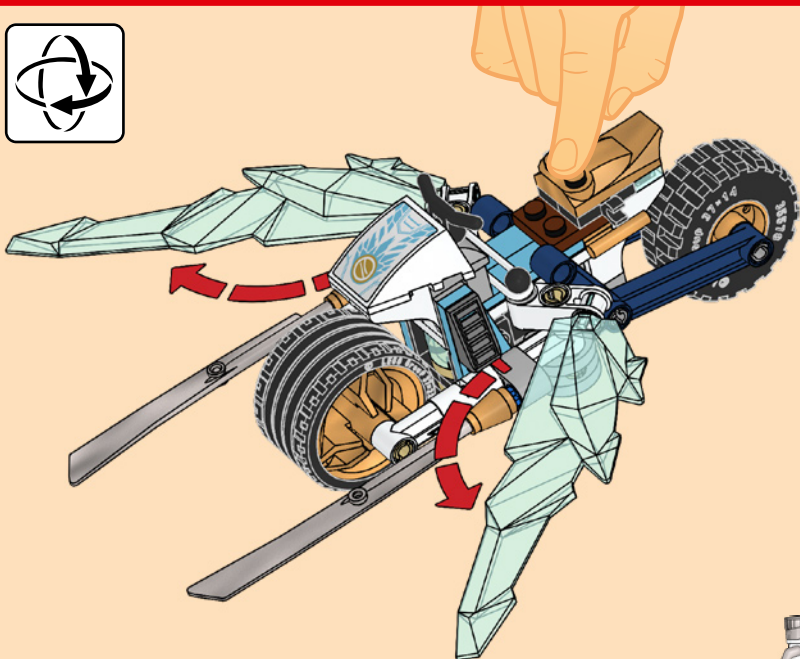

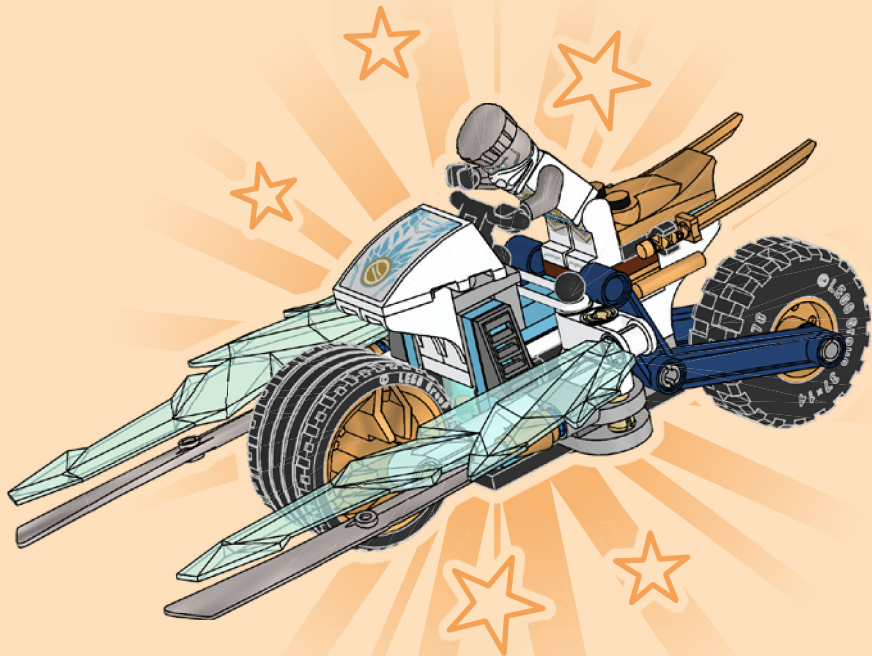

**LEGO**



**71816**



**71820**



**71821**



**71818**



**71822**



**71814**



2x  
6332573



1x  
6487241



1x  
4544140



2x  
6450588



1x  
6484844



2x  
6173116



2x  
6330960



4x  
4568956



1x  
6487242



1x  
4567878



1x  
379501



2x  
6178922



2x  
6000650



1x  
3003126



2x  
4206482



2x  
6344752



3x  
6313116



1x  
6248793



1x  
4499234



1x  
379526



1x  
6273153



1x  
6240222

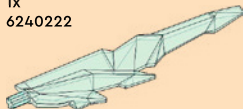

2x  
6427391



2x  
6396289



2x  
4666579



2x  
4140562



2x  
6321305



2x  
6362975



2x  
4550325



2x  
4529247



2x  
6252704



1x  
6215718



1x  
4278273



2x  
6265089



1x  
6109685



1x  
6296847



1x  
6320779



2x  
4211807



1x  
4494475



1x  
6337403



1x  
6296848



2x  
6378729



2x  
4540386



1x  
6356172



1x  
6357918



1x  
4211065



4x  
4211419



1x  
6305023



1x  
4216695



1x  
6129995

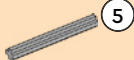

2x  
4211639



2x  
6116596



[LEGO.com/service](https://www.lego.com/service)

# FEEDBACK & REWARD



Scan this QR code or go to **LEGO.COM/PRODUCTSURVEY** and share your feedback about this LEGO® set. You will receive a free digital reward at the end of the survey via download link.

**EN: FEEDBACK AND REWARD.** Share your feedback and receive a free digital reward. **DE: FEEDBACK MIT BONUS.** Teile dein Feedback und erhalte einen digitalen Bonus geschenkt. **FR: AVIS ET RÉCOMPENSE.** Donnez votre avis et recevez une récompense numérique gratuite. **IT: DAI LA TUA OPINIONE E VINCI.** Condividi il tuo feedback e ricevi un premio digitale gratuito. **ES: RECOMPENSAMOS TU OPINIÓN.** Comparte tu opinión y recibe una recompensa digital gratis. **PT: DÊ O SEU FEEDBACK E GANHE RECOMPENSAS.** Partilhe o seu feedback e receba uma recompensa digital gratuita. **ZH: 反馈有奖.** 分享您的反馈意见, 获取免费数字奖励. **PL: WYRAŻ OPINIĘ, ODBIERZ NAGRODĘ.** Podziel się swoją opinią i odbierz cyfrową nagrodę zupełnie za darmo. **CS: ODMĚNA ZA ZPĚTNOU VAZBU.** Podělte se o zpětnou vazbu a obdržíte bezplatnou digitální odměnu. **SK: ODMENA ZA SPÄTNÚ VÄZBU.** Podel'te sa o svoj názor a získajte bezplatnú digitálnu odmenu. **HU: VISSZAJELZÉS ÉS JUTALOM.** Oszd meg véleményed az ingyenes digitális jutalomért! **RO: FEEDBACK ŞI RECOMPENSĂ.** Trimite feedback şi primeşte o recompensă digitală gratuită. **BG: ОТЗИВИ И НАГРАДИ.** Споделете вашите отзиви и получите безплатна дигитална награда. **LV: ATSAUKSMES UN BALVAS.** Sniedz savu atsauksmi un saņem bezmaksas digitālo balvu. **ET: TAGASISIDE JA PREEMIA.** Jaga oma tagasisidet ja saad kingituseks digitaalse preemia. **LT: ATSLIEPIMAI IR ATLYGIS.** Bendrinkite savo atsiliepimą ir gaukite nemokamą skaitmeninį atlygį.