



40692





LEGO.com/sustainable-packaging



FR
DONNEZ
OU
RECYCLEZ

 OU  OU 

ASSOCIATION MAGASIN DÉCHÈTERIE

Adresses sur quefairedemesdechets.fr

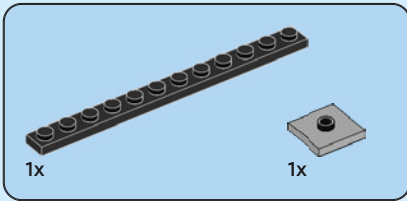

1

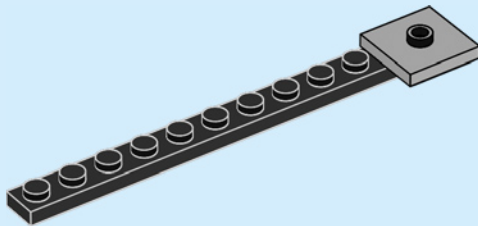

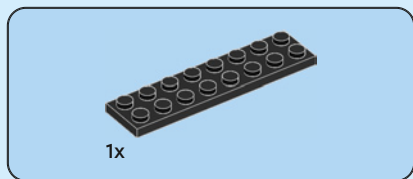

2

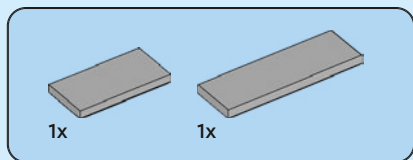
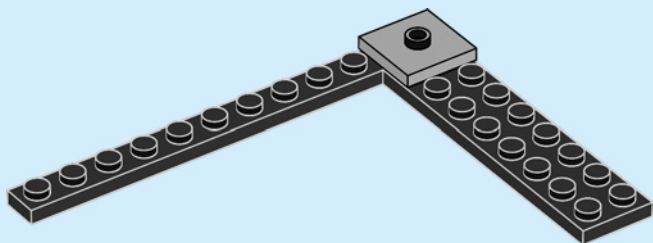

3

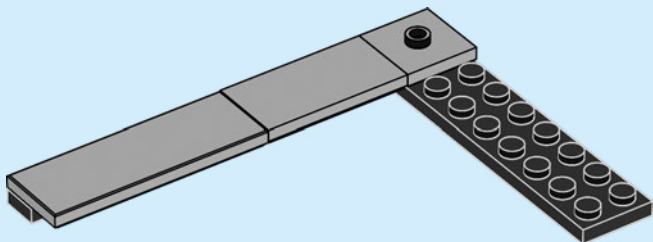

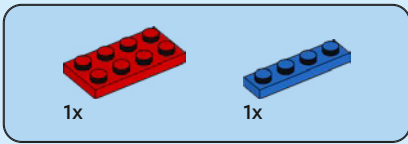

4

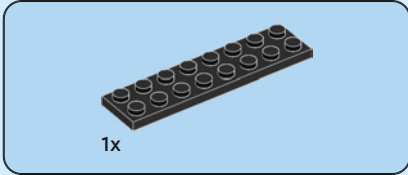
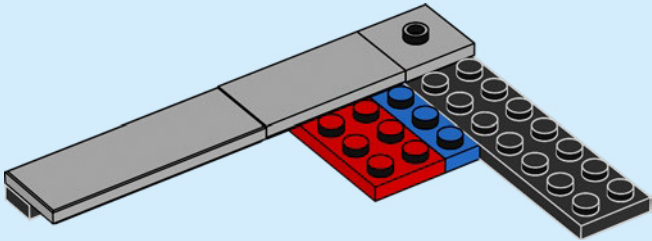

5

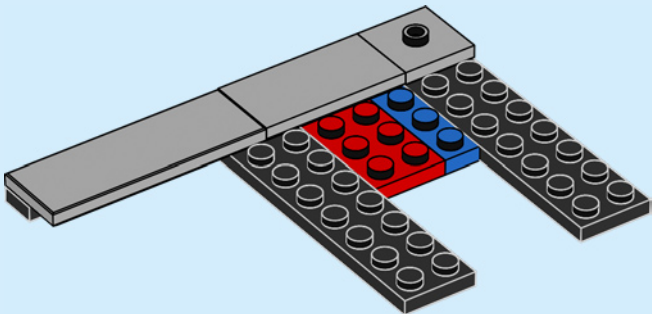

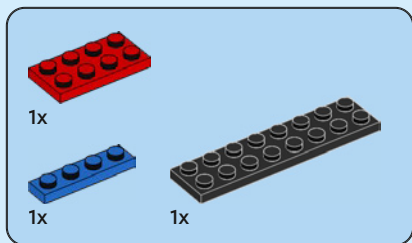

6

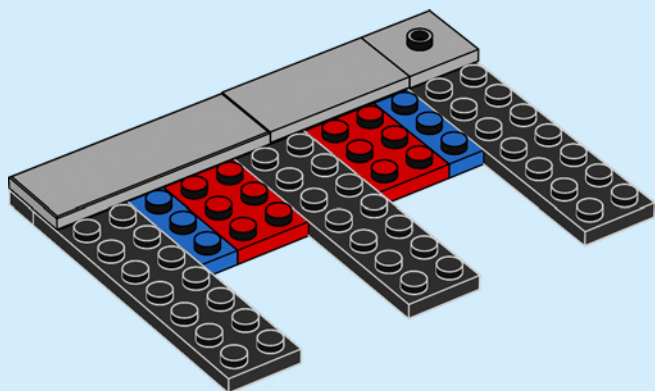

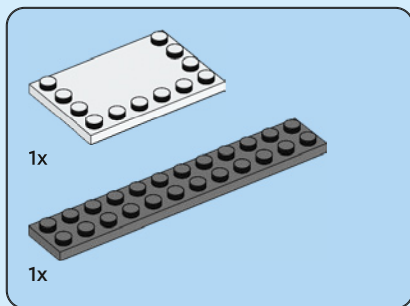

7

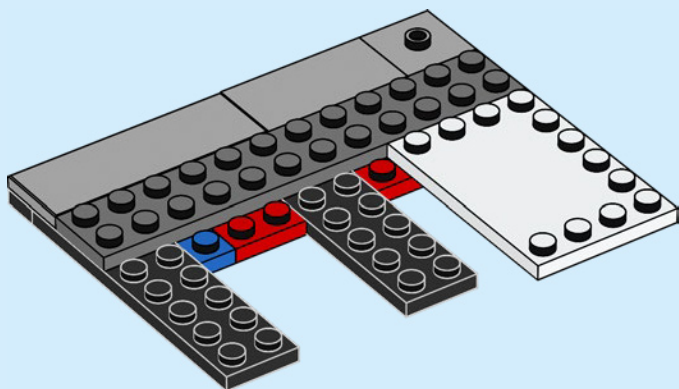

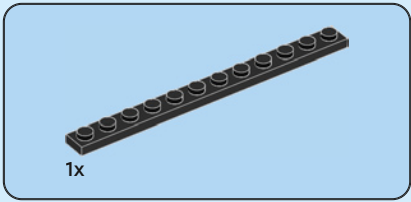

8

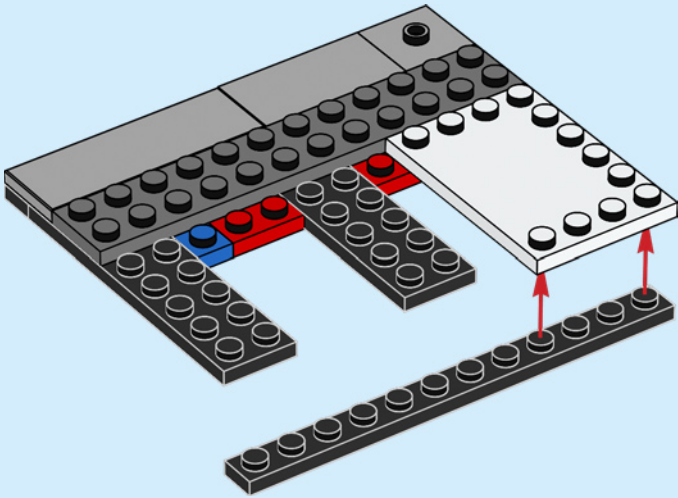

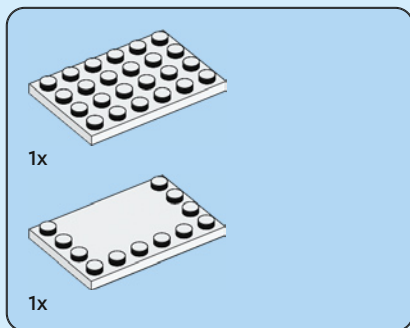

9

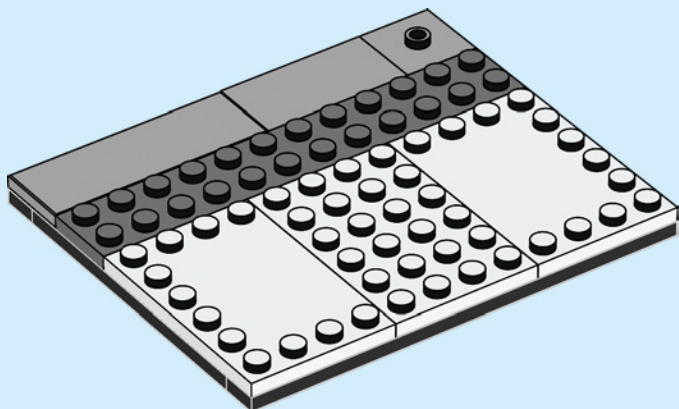

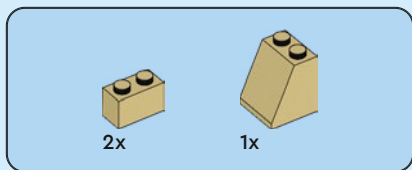

10

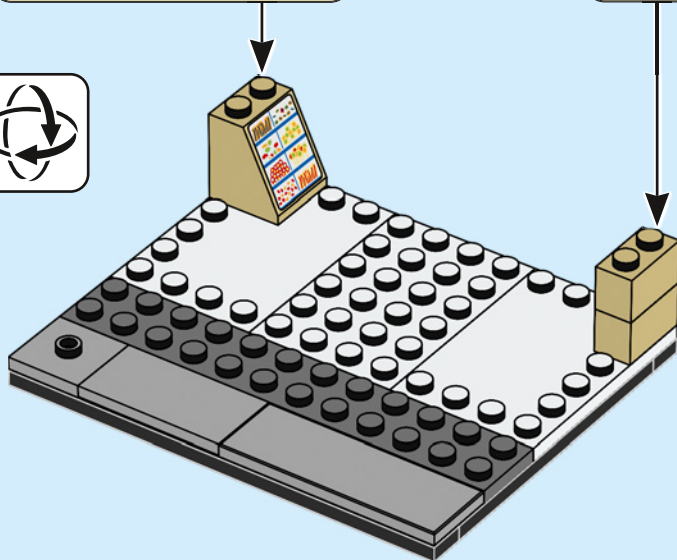
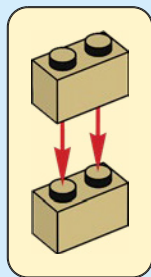
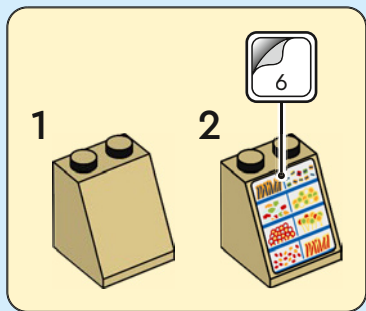

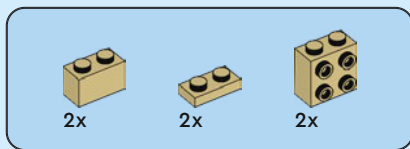

11

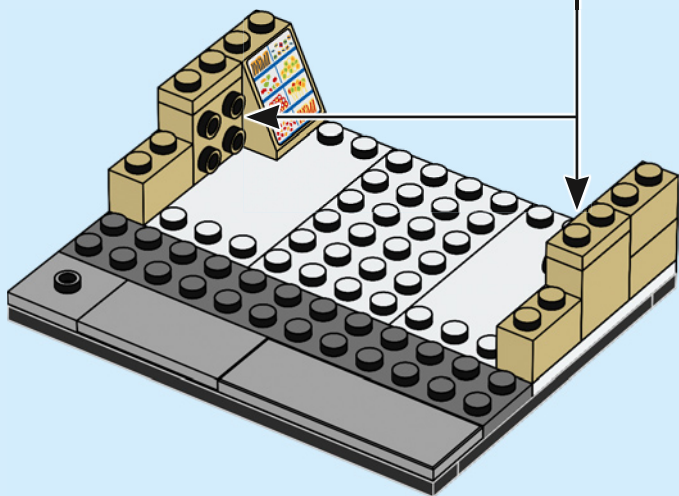
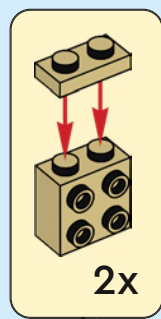



2x



4x



2x

12

1

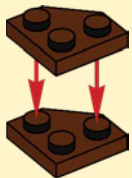

2

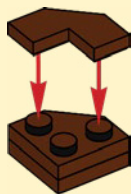

3

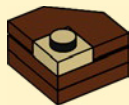

2x

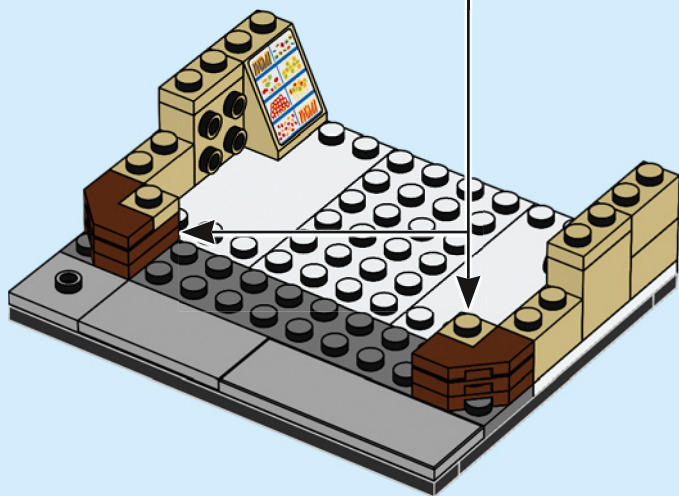



2x



2x



2x

14

1

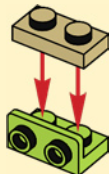

2



2x

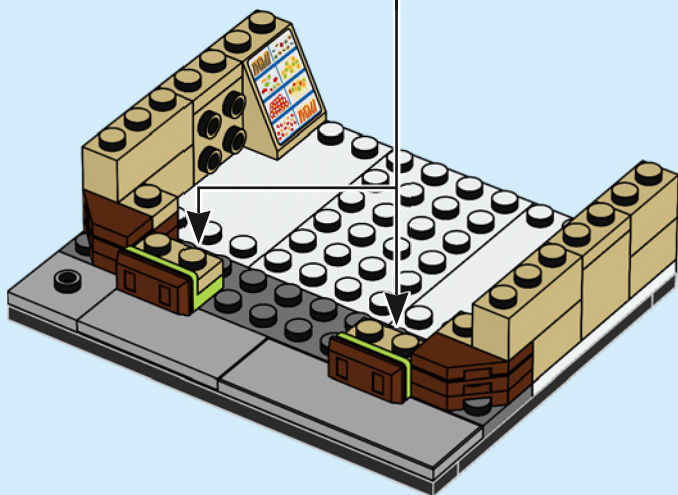



2x



4x



2x



1x

15

1

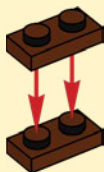

2

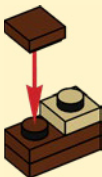

2x

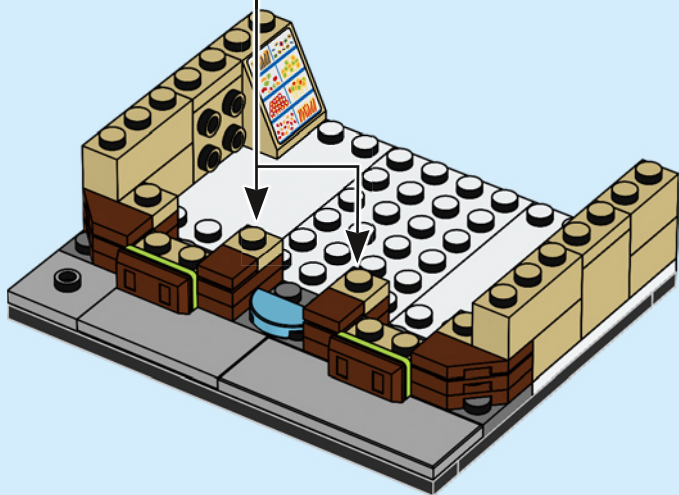



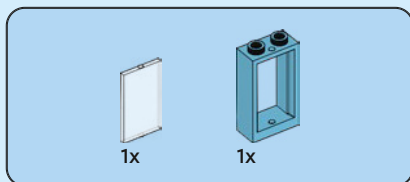

16

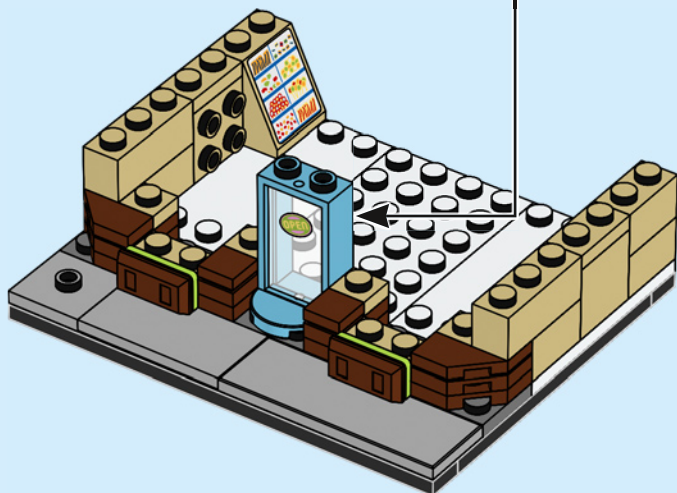
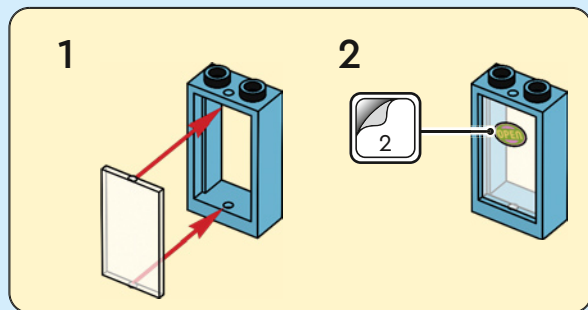



4x



4x



4x

17



2x



2x

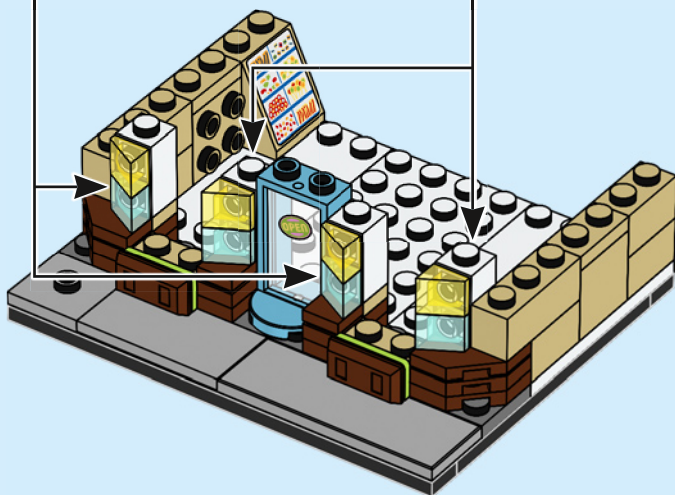



2x

18

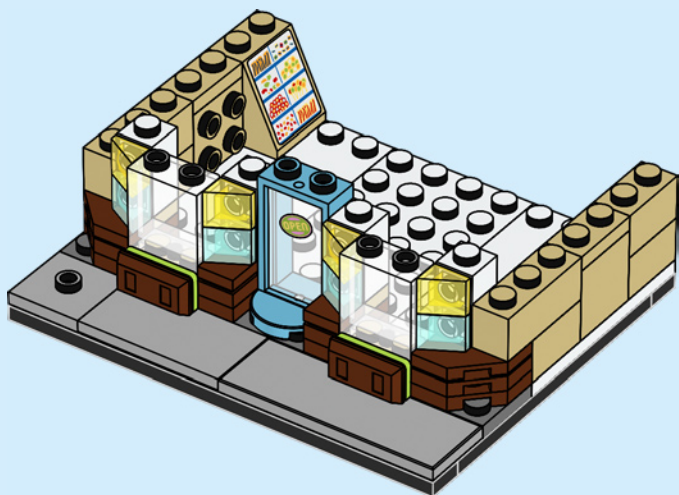



4x



1x

19

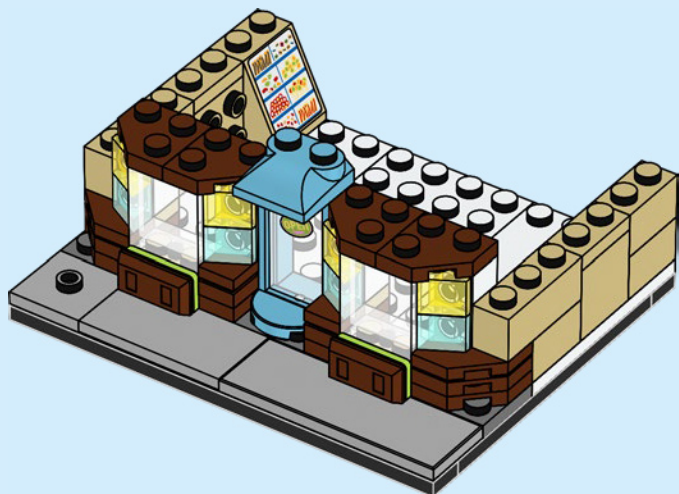



2x



2x

20

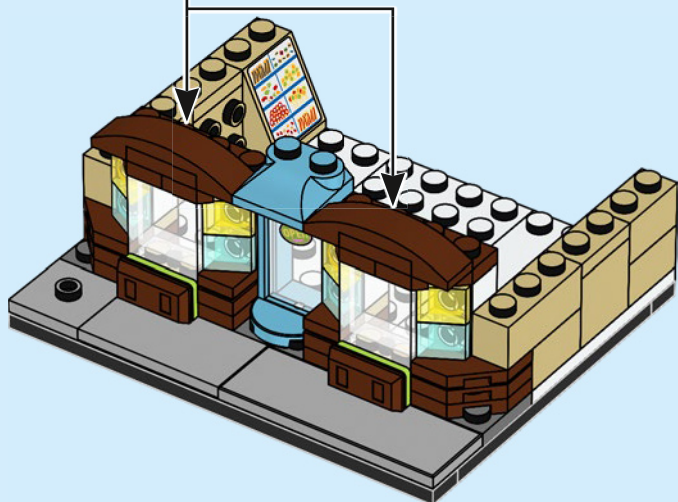
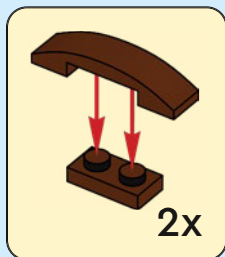



2x

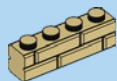

2x

21

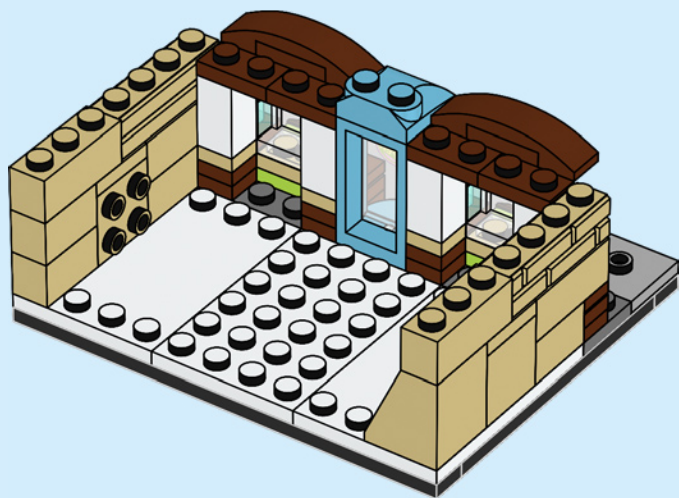

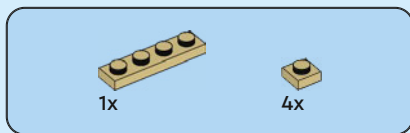

22

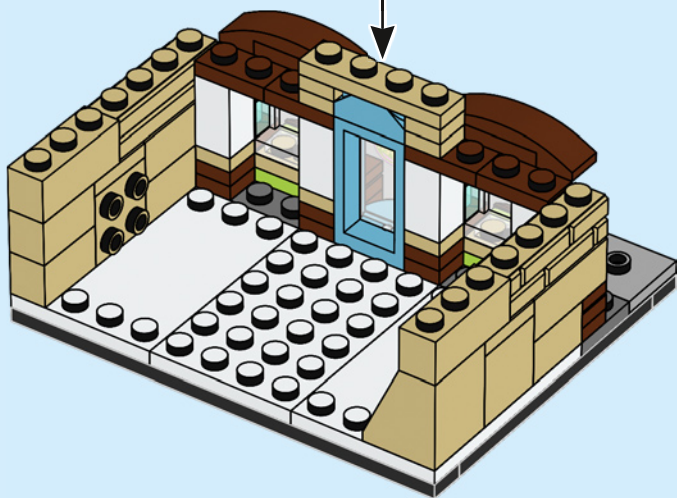
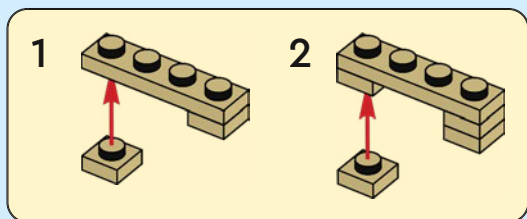



4x



2x



2x

23

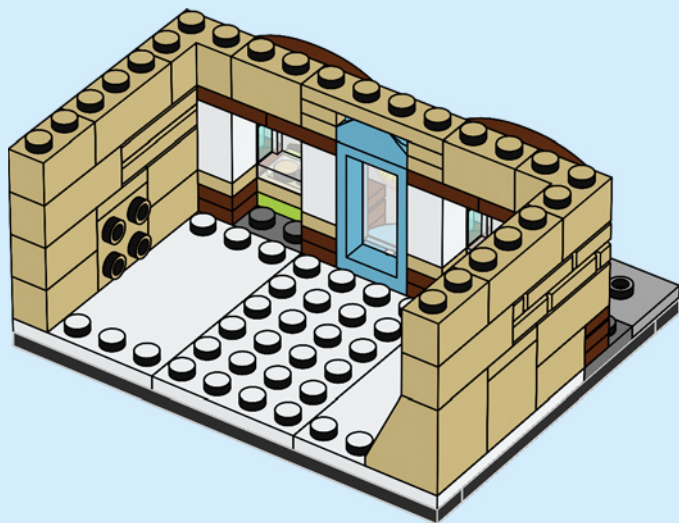



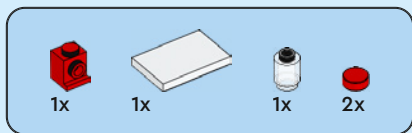

24

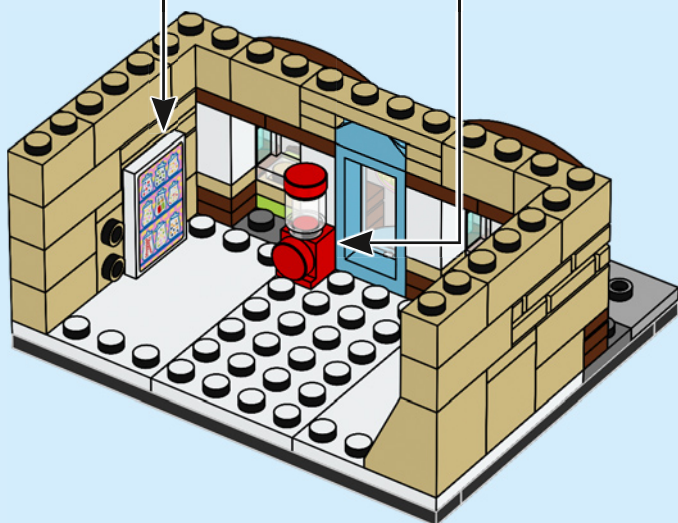
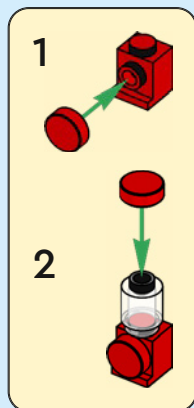
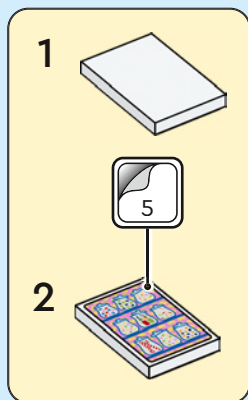



1x



1x



1x



1x

25

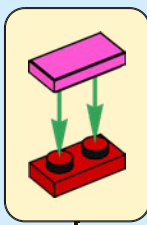
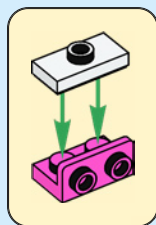

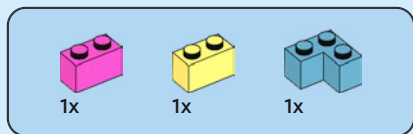

26





27

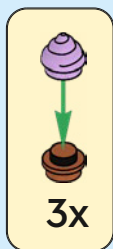



1x



2x



1x

28



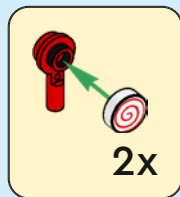
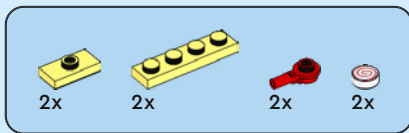

29

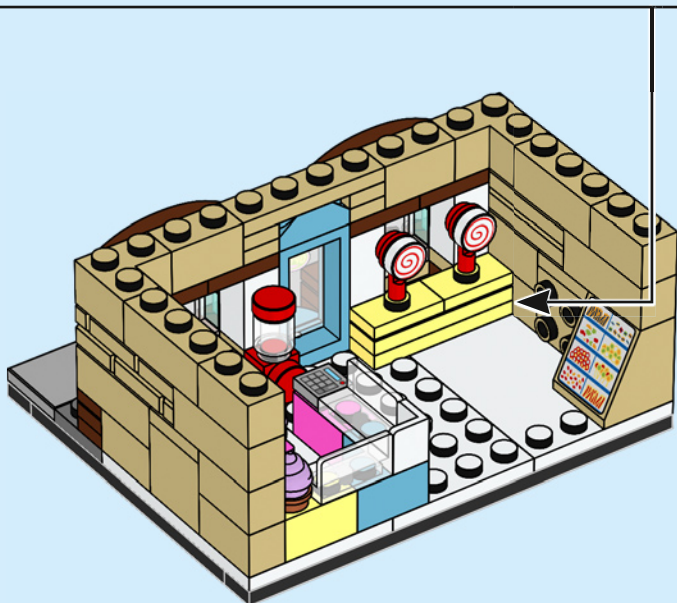
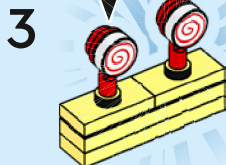
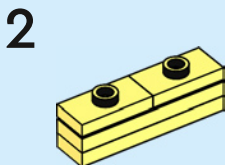
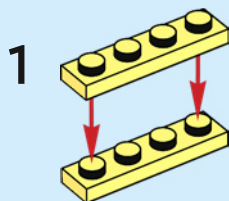



2x



1x

30

1

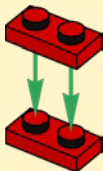

2

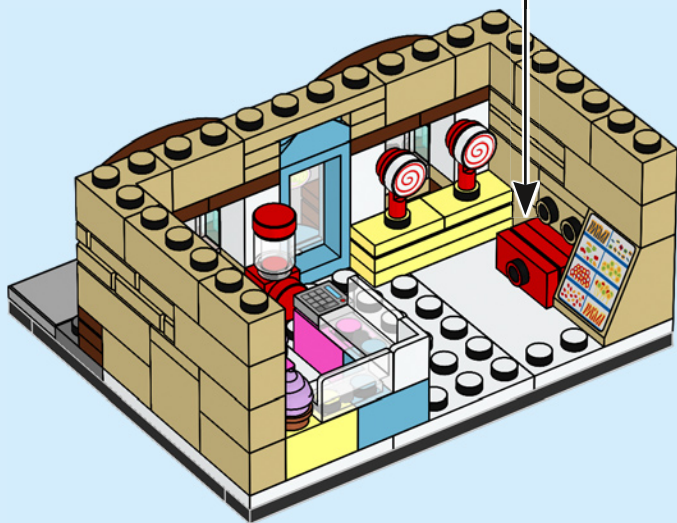
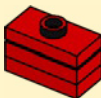

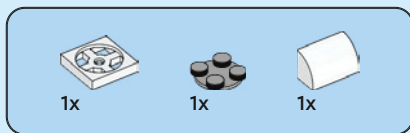

31

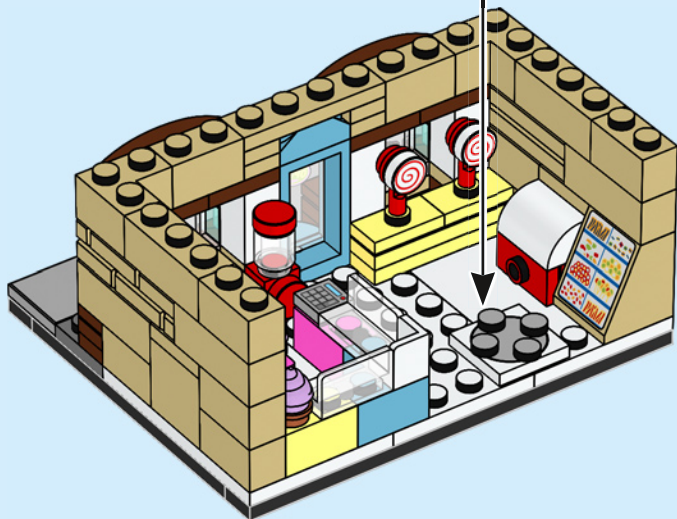
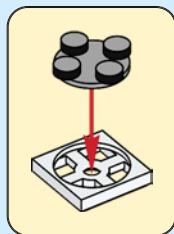

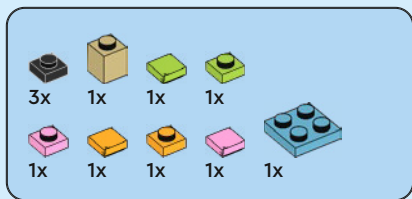

32

1

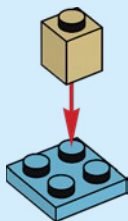

2

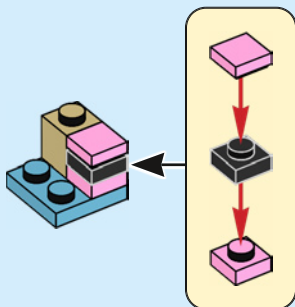

3

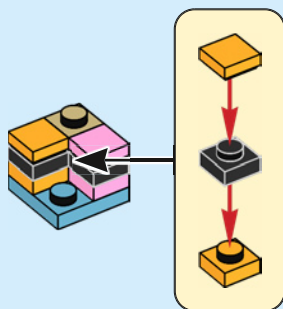

4

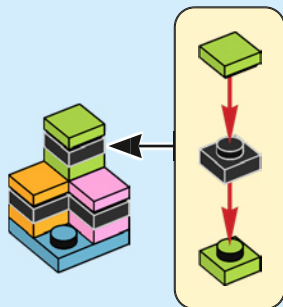





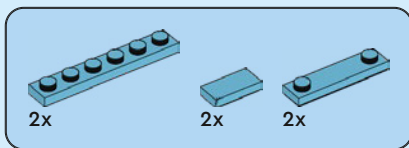

33

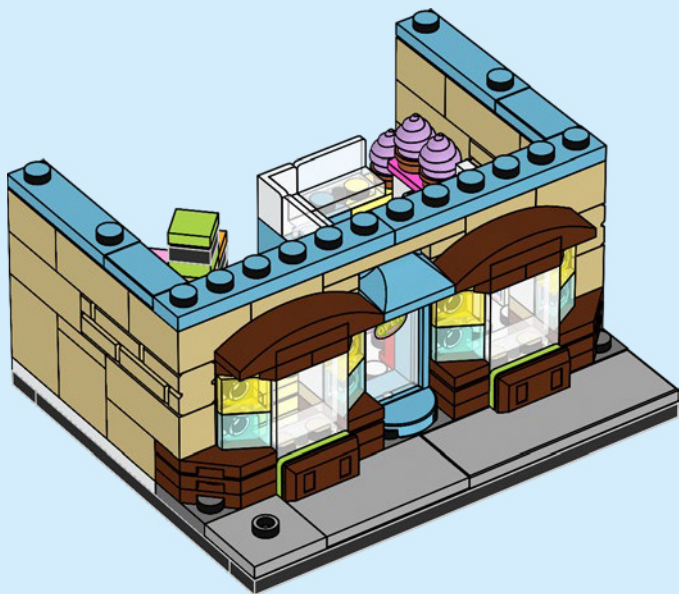

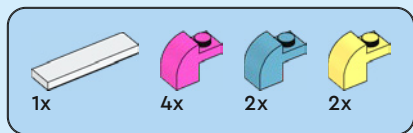

34

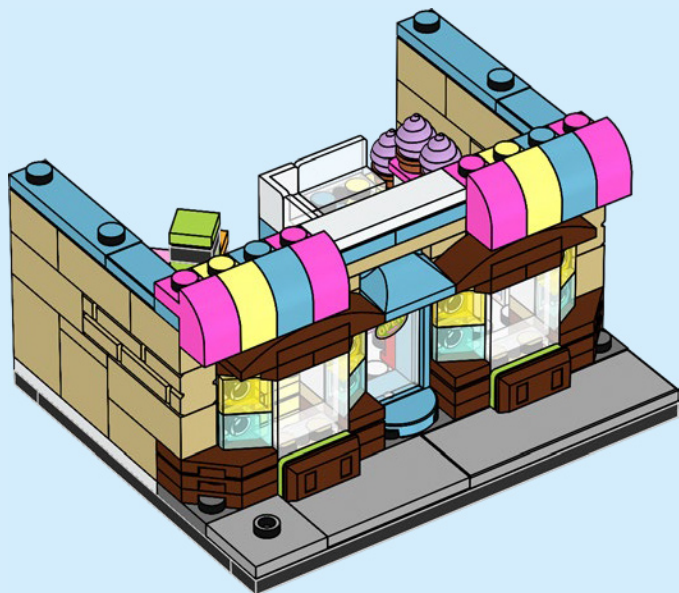



2x



4x



2x

35

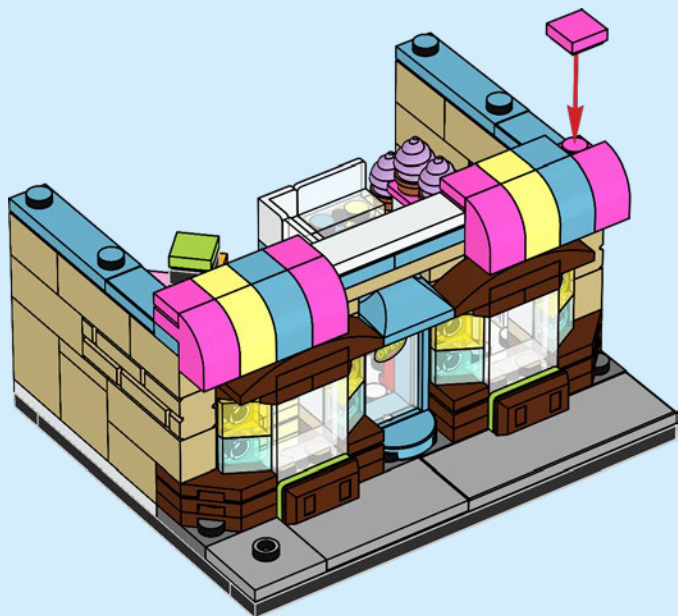

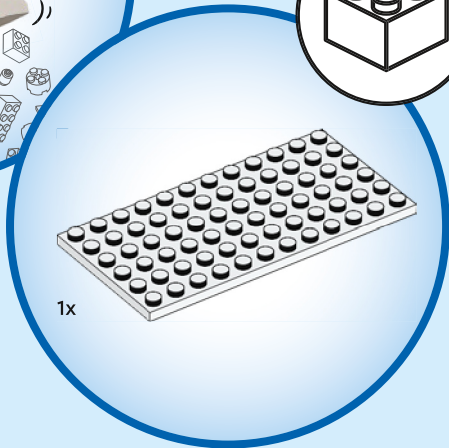
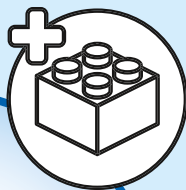

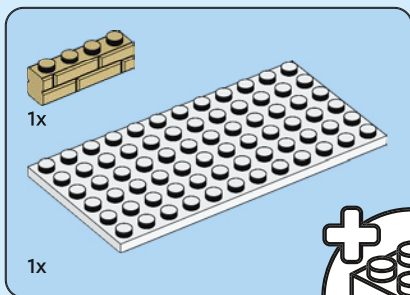

1x

1x

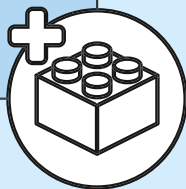

36

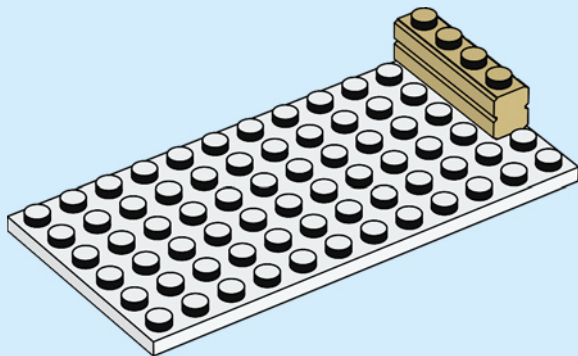

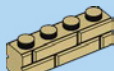

1x



2x

37

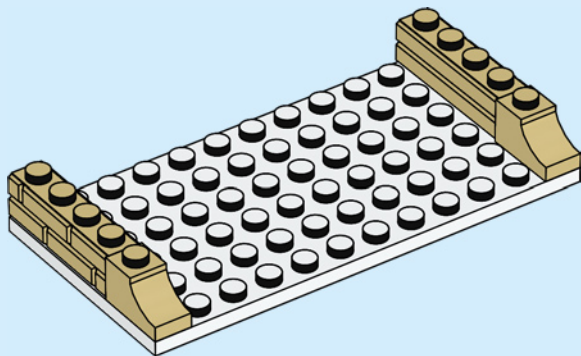

2x



2x

38

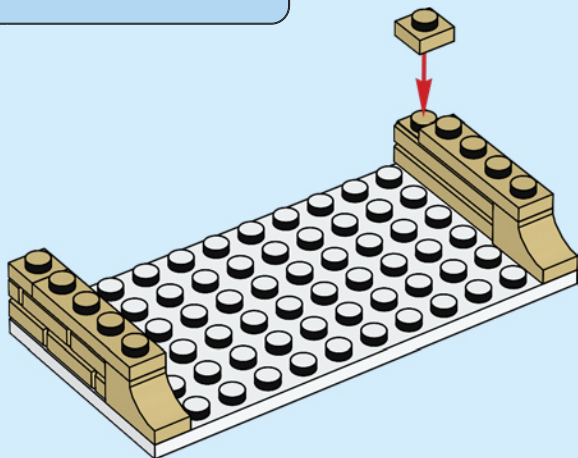

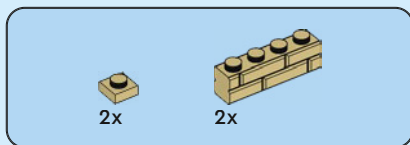

39

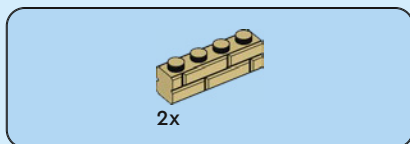
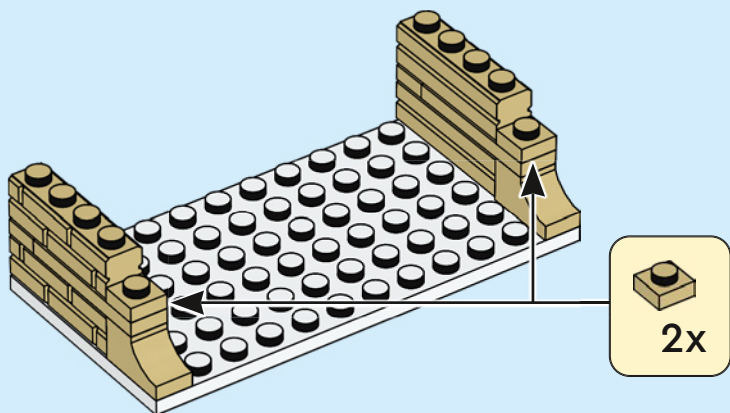

40

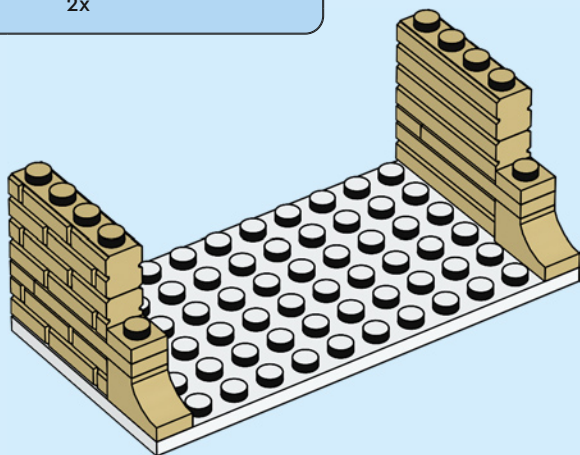



41

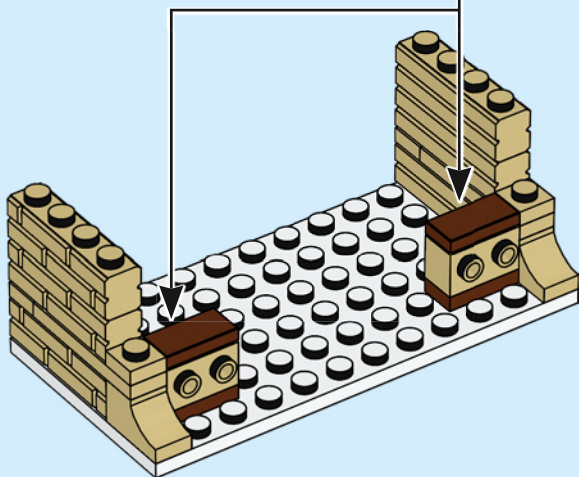
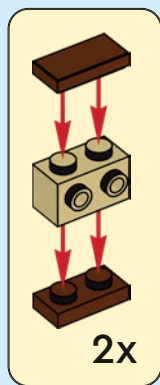



2x



4x



2x

42

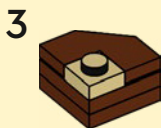
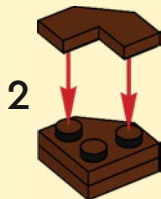
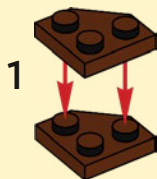

2x

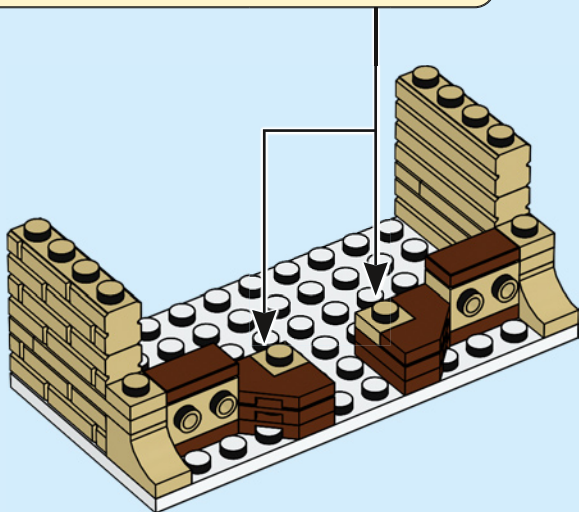

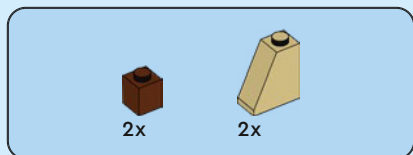

43

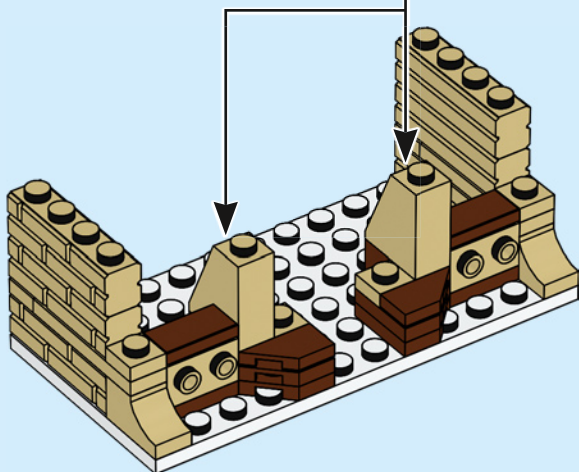
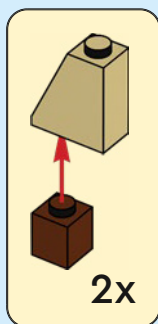



2x



2x



2x



2x



2x

44

1

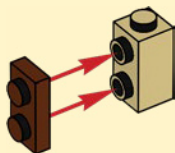

2



3



2x

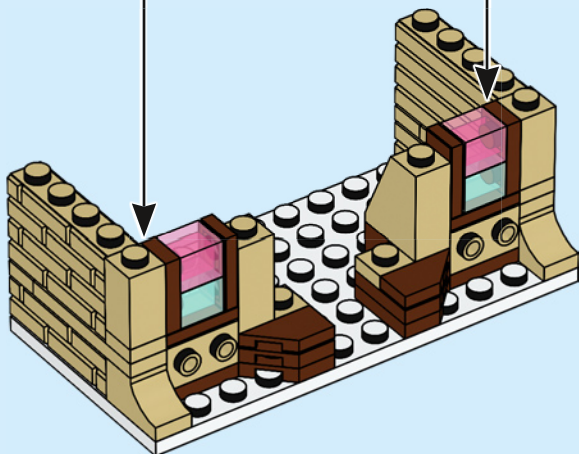



1x



1x

45

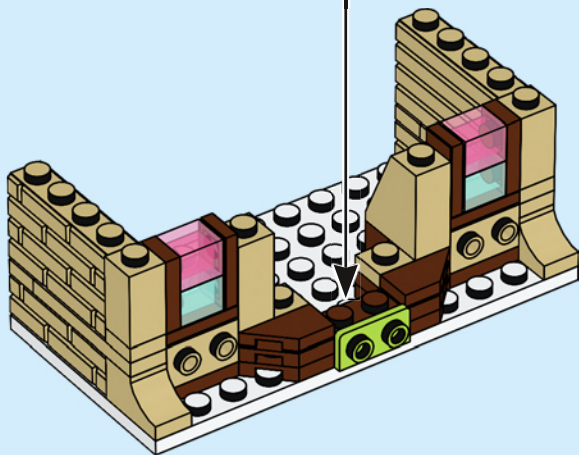
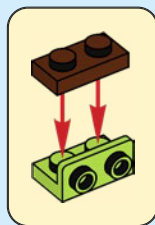



2x



2x



2x

46

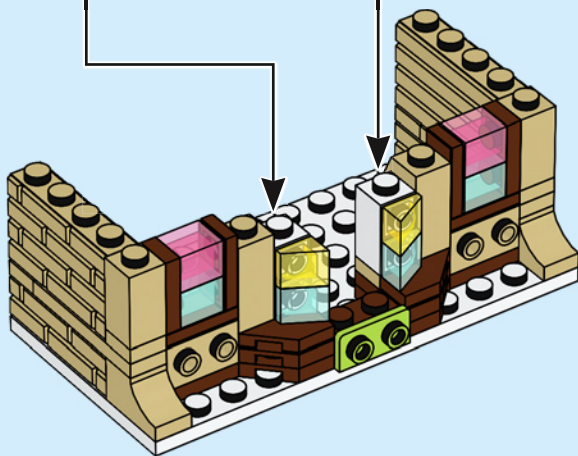
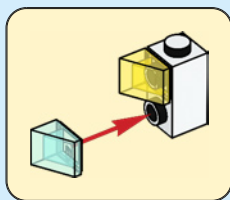
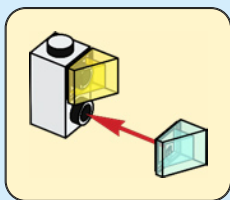



1x

47

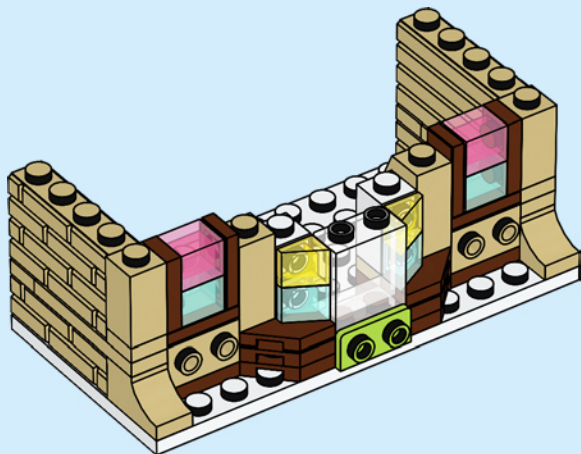



2x

48

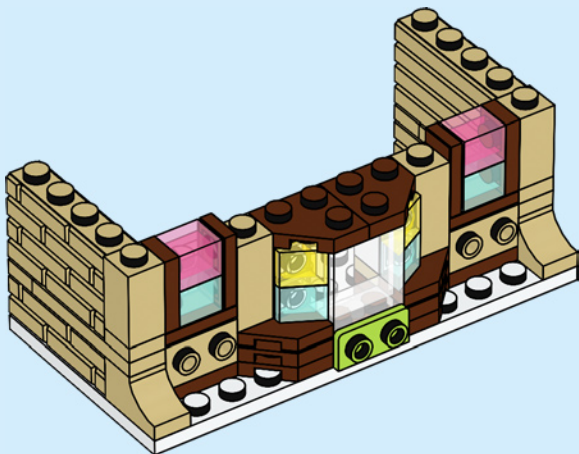

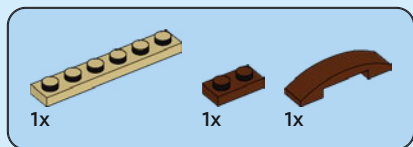

49

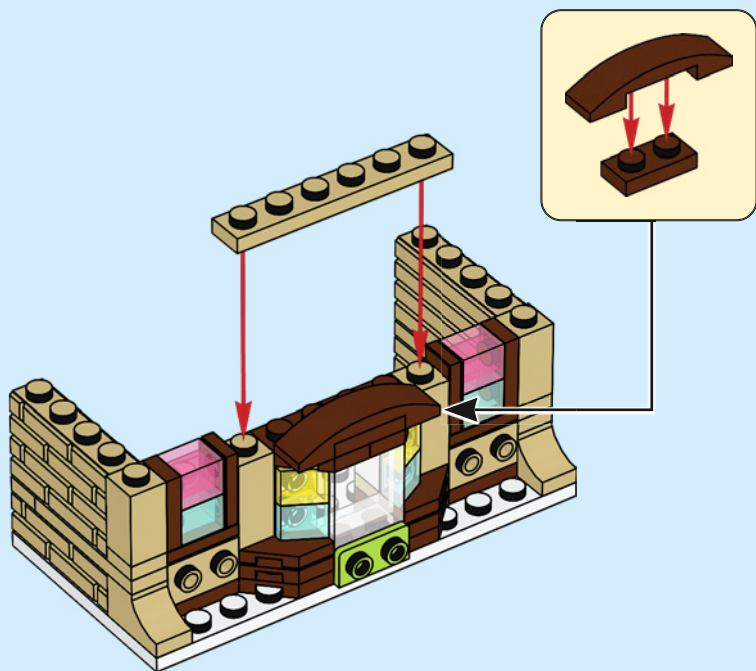



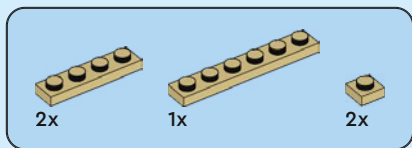

50

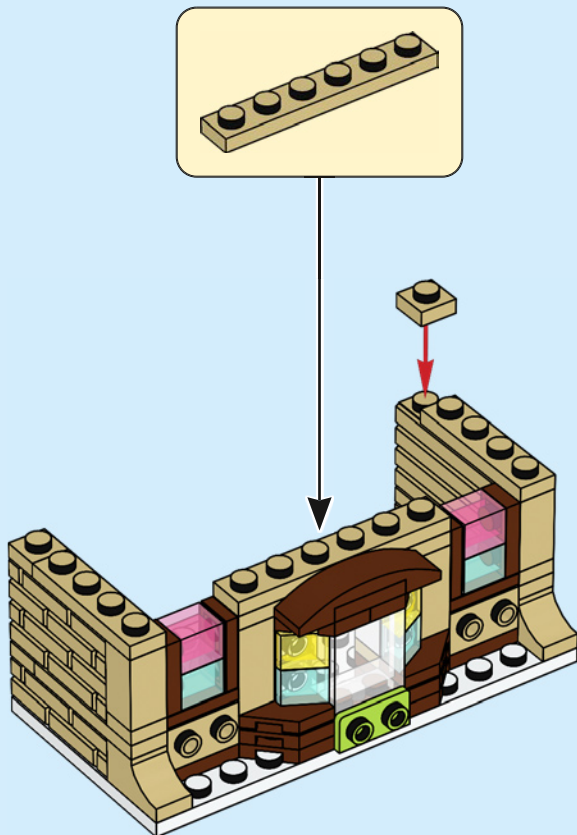

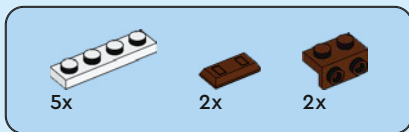

51

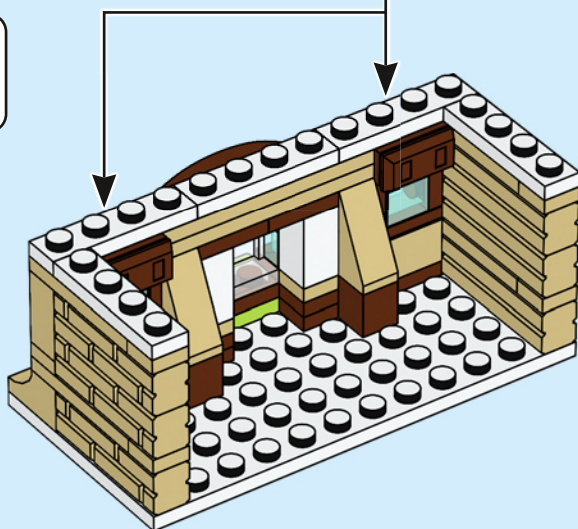
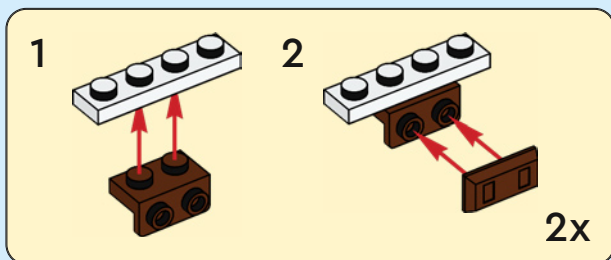

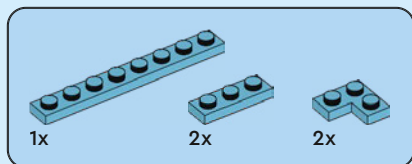

52

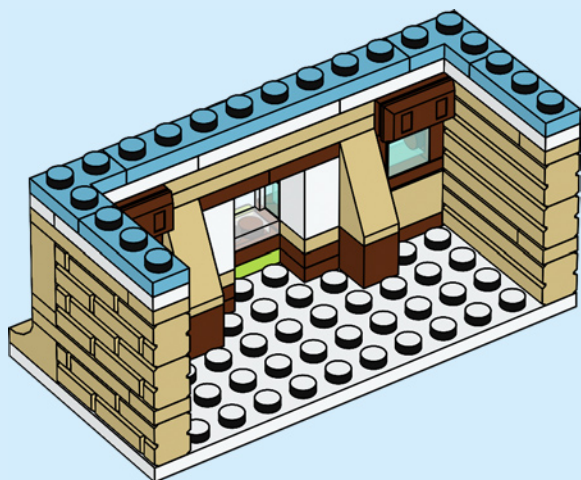



2x



2x

53

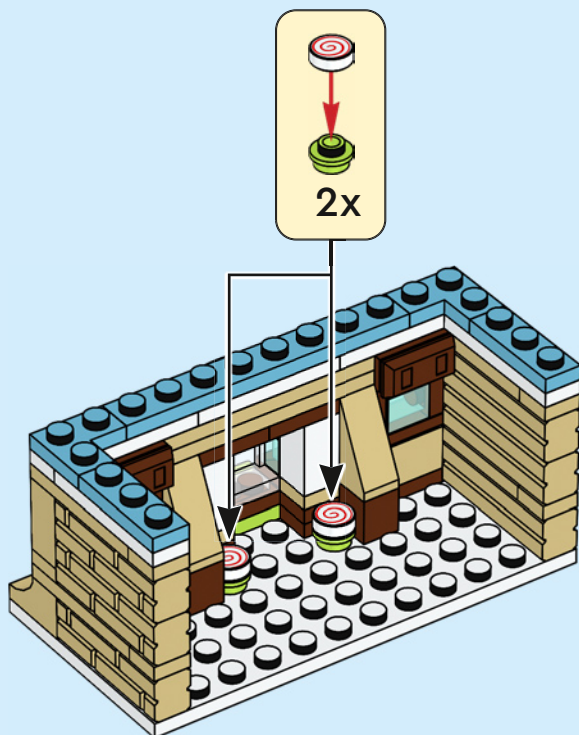



1x



1x



1x

54

1



2



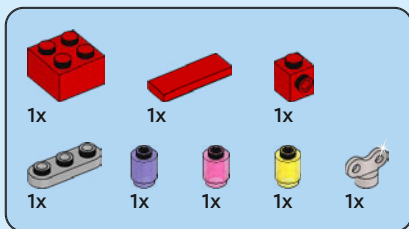

55

1

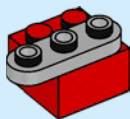

2

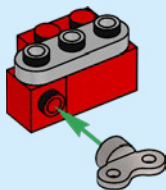

3





56

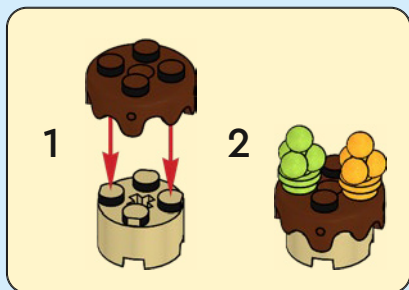

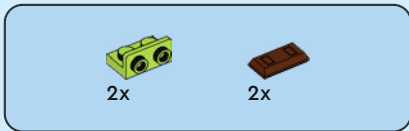

57

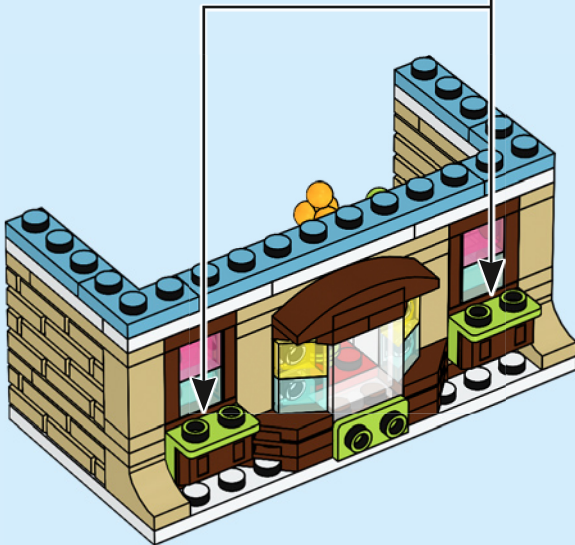
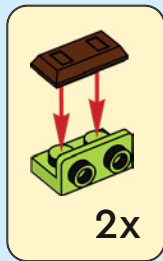



1x



1x



1x

58

1

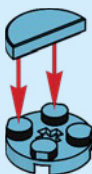

3



2



4

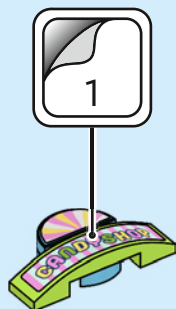

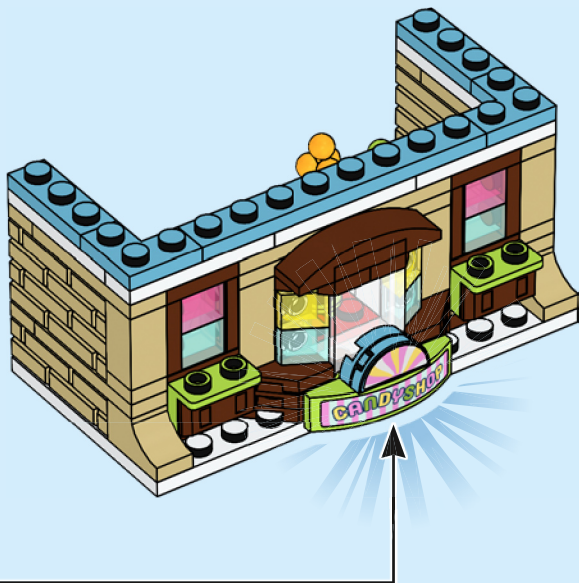



2x



2x



4x

59



2x



2x

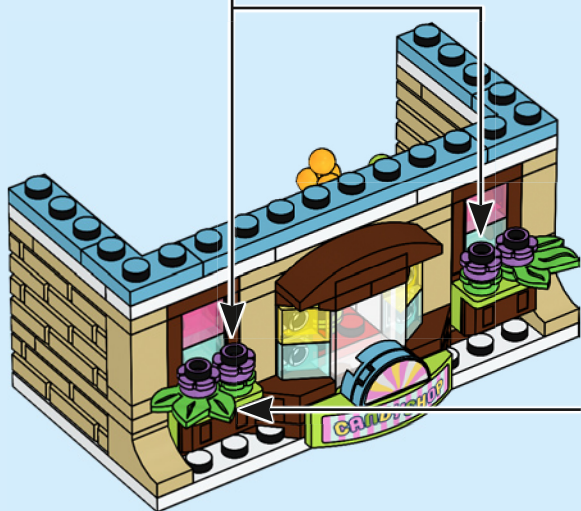





4x



4x



4x

60





4x



4x



4x

61

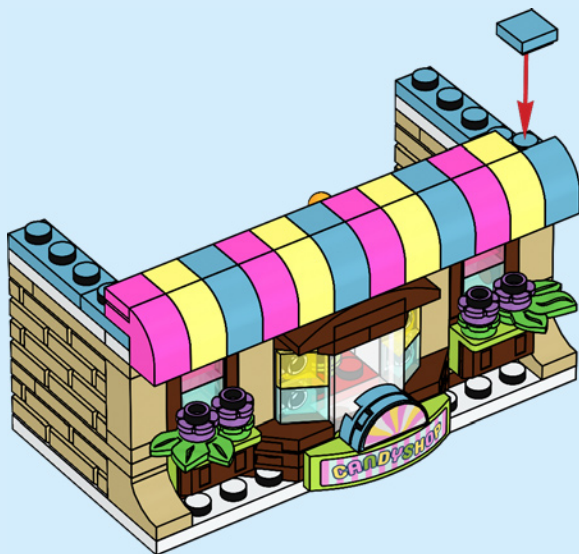

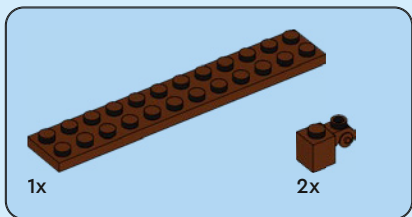
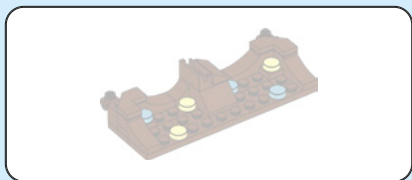

62

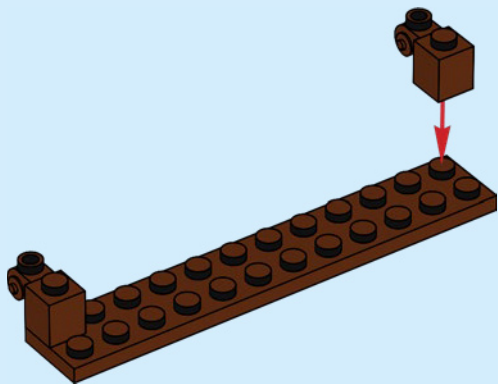



2x

63

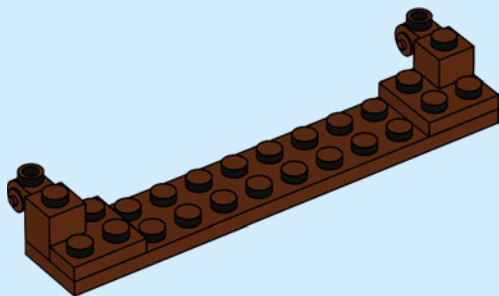

2x



2x

64

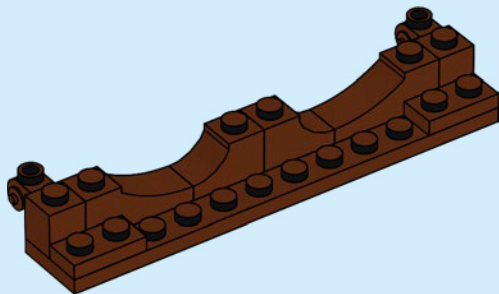



1x



2x

65

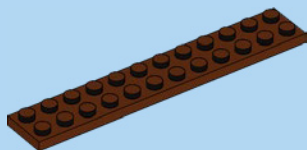
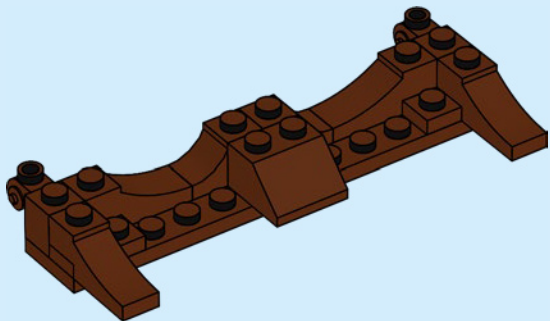

1x

66

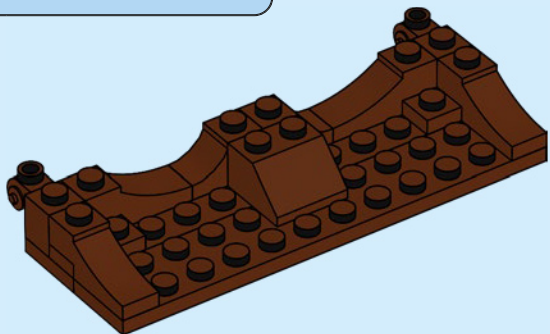



67

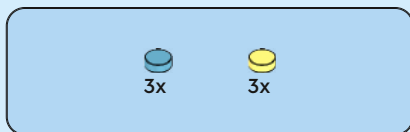
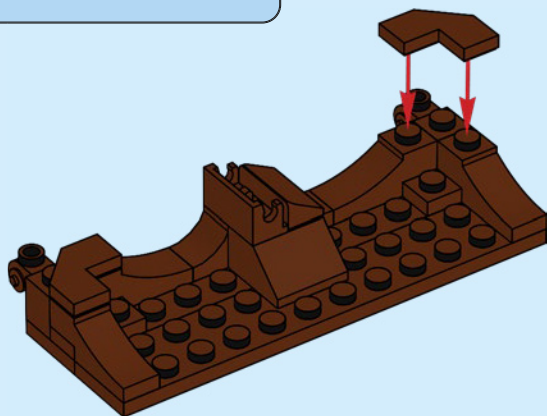

68

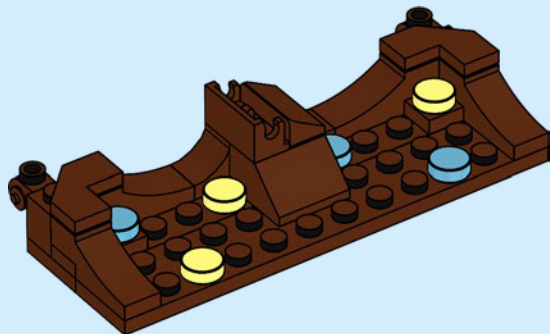

69



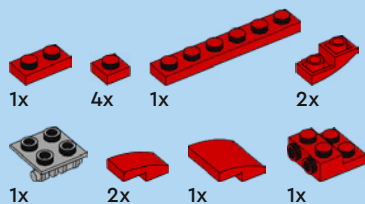

70

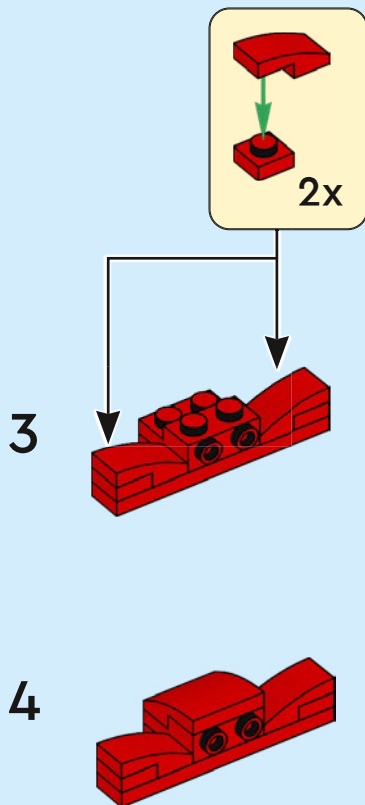
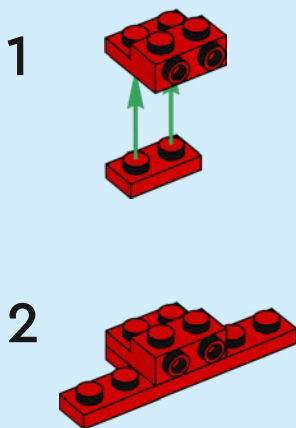



5

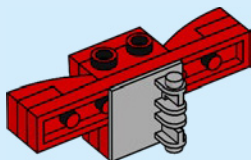

6

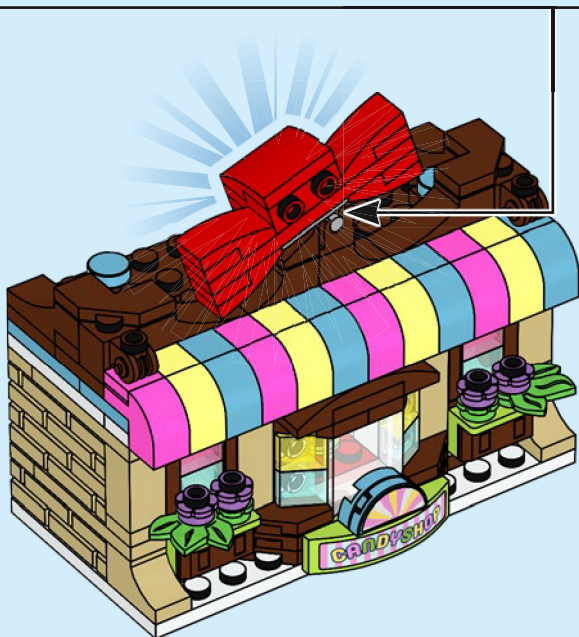
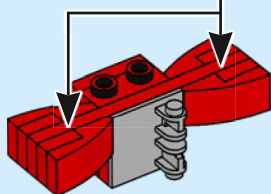

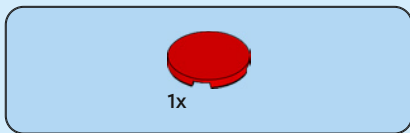

71





2x



2x

72

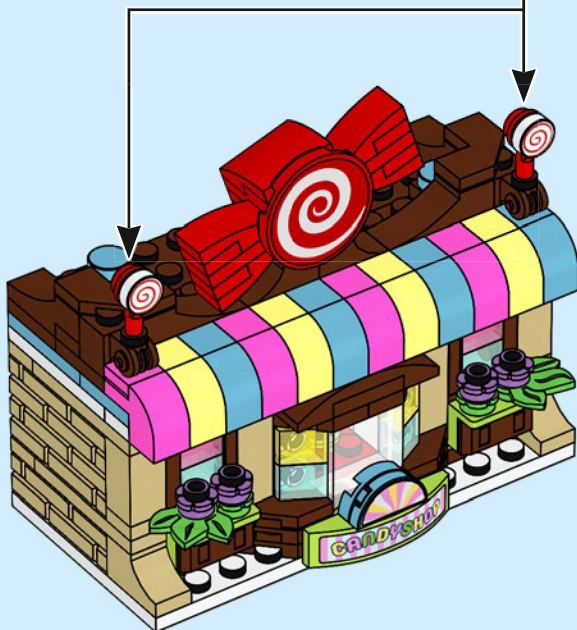
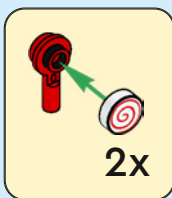

73



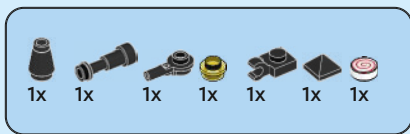

74

1



2



3



4

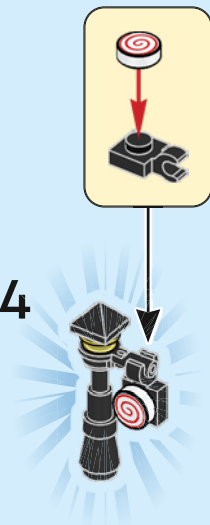





7x
6411552

6x
6218841

1x
623101

1x
6248827

1x
6051511

1x
368001



1x
6156667

5x
371001

1x
243101

1x
303201

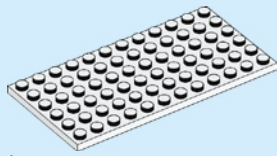
2x
4163986

1x
4120020

16x
4159553

2x
6232135

1x
4113915

1x
4125220

2x
4626200

8x
4109995

4x
4113917

2x
6214334

2x
6024495

2x
6383295



1x
6391522

2x
4124455

6x
4162465

5x
4113233

8x
6232136

2x
4124067

2x
6284574

1x
407021

1x
4558886

4x
302421

4x
6384112

4x
302321

1x
6092565

2x
6029946

2x
6186398

2x
300321

1x
6105976

1x
6469446

1x
6331874

1x
4533742

2x
302021

1x
366621

2x
371023

2x
6206150

1x
6488792

2x
6182261

3x
6315782



1x
6223655



1x
6252258



3x
6253231



2x
6246888



6x
6245277



2x
6240551



1x
6240216



6x
6245272



2x
6240553



3x
6190251



1x
6061678



1x
4621557



1x
4537251



5x
6218266



1x
4617069



1x
4286789



1x
6073040



1x
6065504



1x
6329583



1x
4540203



1x
6446028



1x
6126082



1x
4211881



1x
4560183

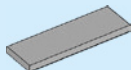

1x
6318584



2x
4211242



2x
4211288



1x
6035291



2x
6172757



6x
6261744



14x
6218366



12x
4211150



4x
4211151



2x
6365885



1x
6186045



2x
6443654



1x
6286644



6x
6295302



1x
4211202



2x
4211257



4x
6452321



3x
4658005

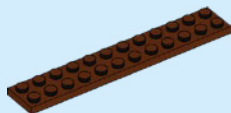

2x
4225700

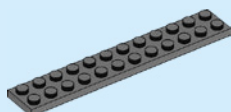

1x
4211067



3x
303426



2x
4514845



1x
4529236



1x
6312449



3x
302426



1x
6308000



1x
6196548



1x
4538456



8x
6133726



1x
4621545



8x
6184801



1x
6056381



1x
6099449



1x
6031883



1x
6251940



3x
6343806



6x
6275877



1x
6022083



2x
6195266



6x
6411364



2x
6248756



1x
6363150



3x
6322819



6x
4655243



2x
6445337



1x
6109752



1x
6468358



2x
4649741



6x
6335566



2x
6293739



1x
6439273



1x
6353496



1x
4625032



2x
6119107



2x
6252704



1x
6074793



2x
4625036



4x
6209684



3x
6492250



1x
6473803



1x
6464814



1x
6484194



LEGO.com/service

YOU COULD

WIN



Scan this QR code or go to **LEGO.COM/PRODUCTFEEDBACK** and give us your short feedback about this LEGO® set for a chance to win a cool LEGO prize.

Terms and Conditions apply*

EN: YOU COULD WIN. Terms and Conditions apply* **DE: Du könntest GEWINNEN.** Es gelten die Teilnahmebedingungen* **FR: Tu pourrais GAGNER.** Des conditions s'appliquent* **IT: Potresti VINCERE tu.** Termini e condizioni sono applicabili* **ES: Puedes GANAR.** Aplican términos y condiciones* **PT: Poderá GANHAR.** Aplicam-se termos e condições* **ZH: 轻松获奖. 条款和条件适用*** **PL: Szansa na WYGRANĄ.** Obowiązują warunki korzystania* **CS: Máte šanci VYHRÁT.** Platí všeobecné smluvní podmínky* **SK: Máte šancu VYHRAŤ.** Platia všeobecné zmluvné podmienky* **HU: TE IS NYERHETSZ.** Felhasználási feltételek érvényesek* **RO: Ai putea CÂȘTIGA.** Se aplică termeni și condiții* **BG: Можете да СПЕЧЕЛИТЕ.** Има определени правила и условия* **LV: Tu vari LAIMĒT.** Ir spēkā noteikumi un nosacījumi.* **ET: Sul on võimalus VÕITA.** Kehtivad tingimused* **LT: Jūs galite LAIMĖTI.** Taikomos sąlygos*

*[LEGO.com/productfeedback-terms](https://www.lego.com/productfeedback-terms)

LEGO and the LEGO logo are trademarks of the LEGO Group. ©2024 The LEGO Group.