



Disney

43276



WARNING: CHOKING HAZARD.
Toy contains small parts and a small ball.
Not for children under 3 years.



LEGO® Builder



Get excited about our new packaging!

We're switching from plastic to paper-based packaging. That's why you might find a mix of paper and plastic in our boxes!

Nos nouveaux emballages vous emballeront !

Nous passons des emballages en plastique aux emballages à base de papier. C'est pourquoi vous pourriez trouver un mélange de papier et de plastique dans nos boîtes !

¡Te presentamos nuestros nuevos empaques!

Estamos sustituyendo las bolsas de plástico por bolsas con base de papel. ¡Por eso, puedes encontrar una mezcla de papel y de plástico en nuestras cajas!

[LEGO.com/sustainable-packaging](https://www.lego.com/sustainable-packaging)

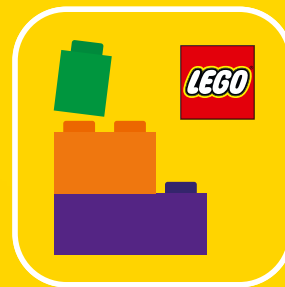

🔍 LEGO® Builder

BUILDER

Download on the
App Store

GET IT ON
Google Play

腾讯应用宝
安卓应用商店

Apple and the Apple logo are trademarks of Apple Inc., registered in the U.S. and other countries and regions. App Store is a service mark of Apple Inc. Google Play and the Google Play logo are trademarks of Google LLC. Tencent and the Tencent logo are trademarks of Tencent Inc.

🔍 LEGO.com/devicecheck

EN Ask parents' permission before going online | DE Eltern um Erlaubnis bitten, bevor du online gehst | FR Demande l'autorisation d'un parent avant d'aller en ligne | IT Chiedi il permesso ai tuoi genitori prima di andare online | ES Pídeles permiso a tus papás antes de conectarte a Internet | PT Peça autorização aos pais antes de acederes online | ZH 上网前应先征得父母的同意 | PL Poproś rodziców o zgodę, zanim wejdiesz do Internetu | CS Než půjdeš na internet, požádej rodiče o svolení | SK Skôr než pôjdeš na internet, vypýtaj si povolenie od rodičov | HU Kérj szülői engedélyt, mielőtt online csatlakoznál! | RO Cere permisiunea părinților înainte de a te conecta online | BG Поискайте разрешение от родител, преди да влезете онлайн | LV Pirms došanās tiešsaistē palūdz atļauju vecākiem | ET Enne Interneti kasutamist küsi vanematelt luba | LT Prieš prisijungdami prie interneto, atsklauskite tėvų

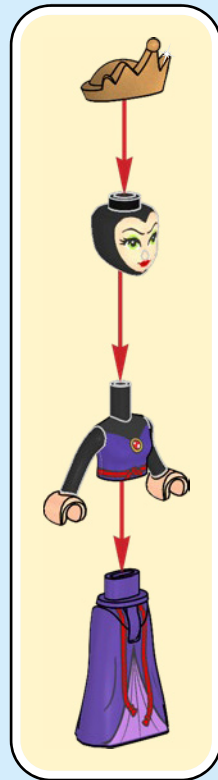
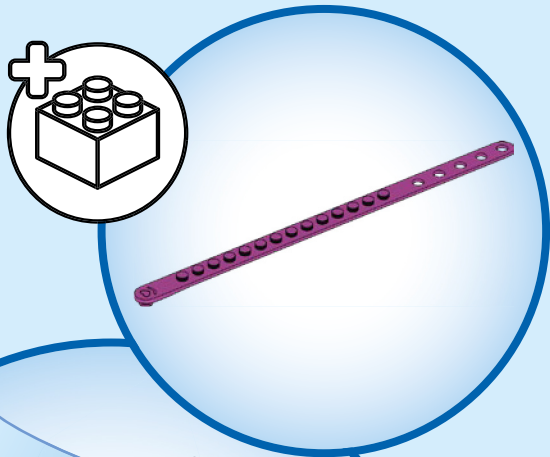



AVERTISSEMENT : RISQUE D'ÉTOUFFEMENT.

Le jouet contient des petites pièces ainsi qu'une petite boule.
Il ne convient pas aux enfants de moins de 3 ans.



ADVERTENCIA: PELIGRO DE ASFIXIA.

Juguete que contiene partes pequeñas y una pelota pequeña.
No recomendado para niños menores de 3 años.

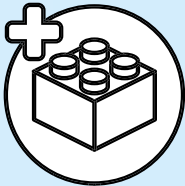

1

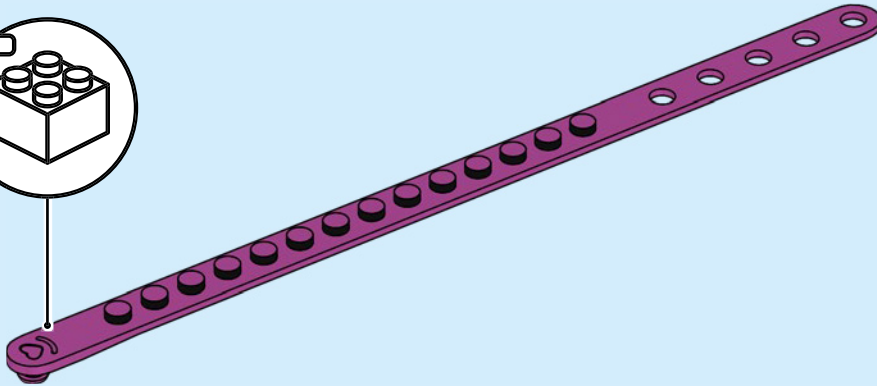

2

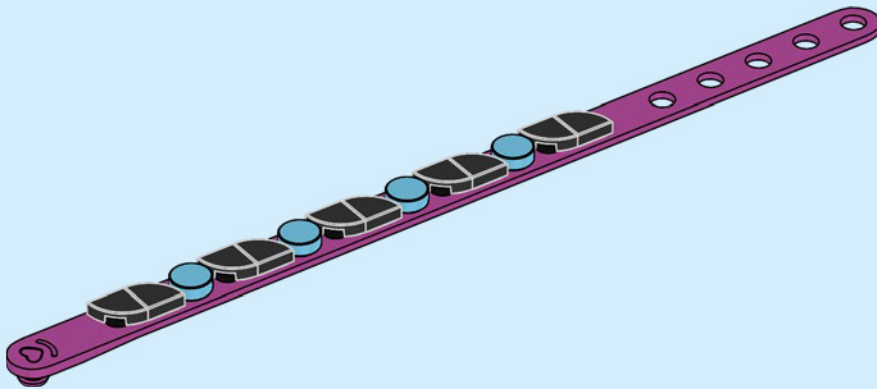

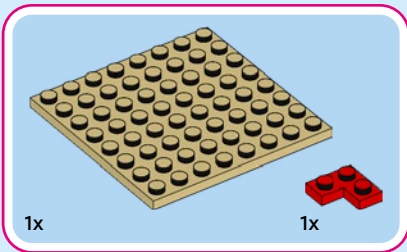
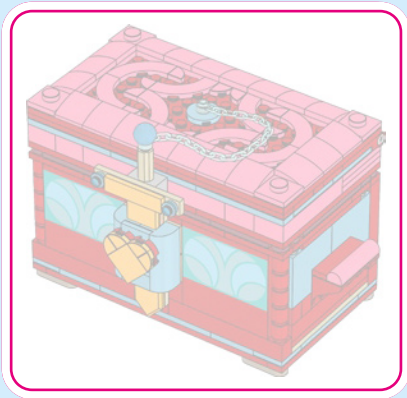

1

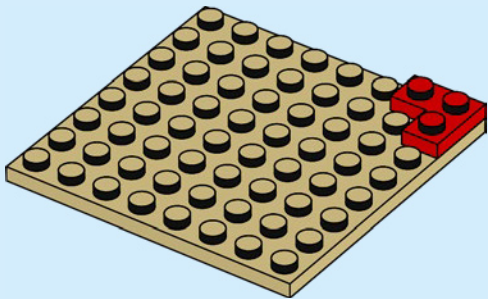

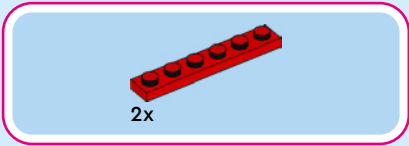

2

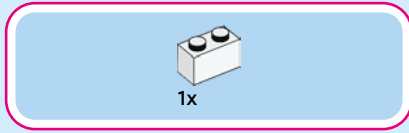
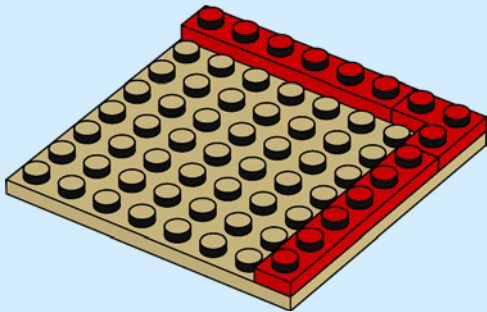

3

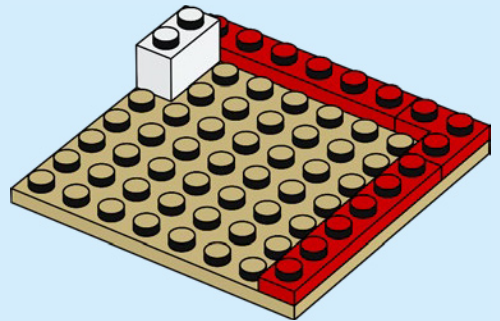

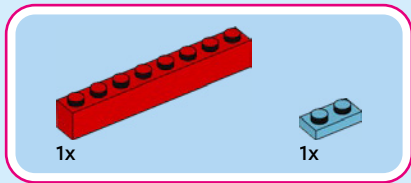

4

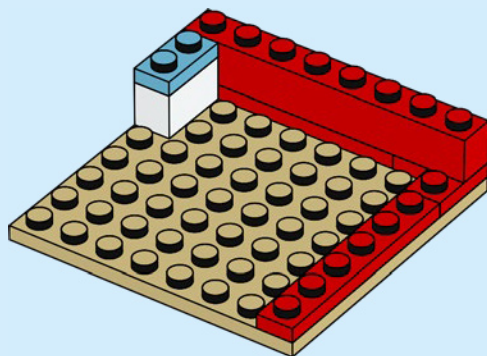

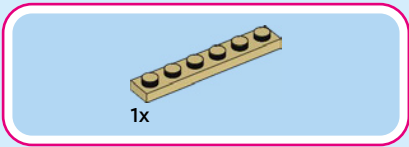

5

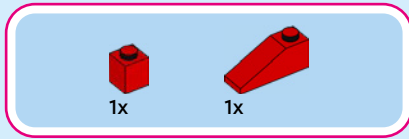
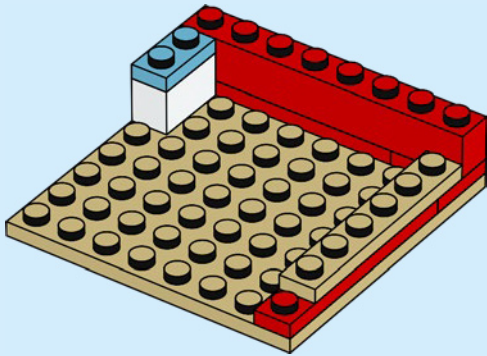

6

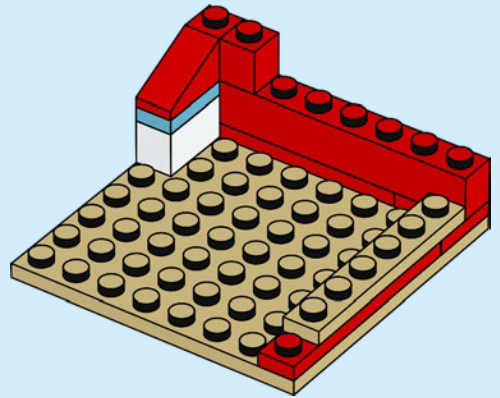

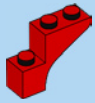

4x

7

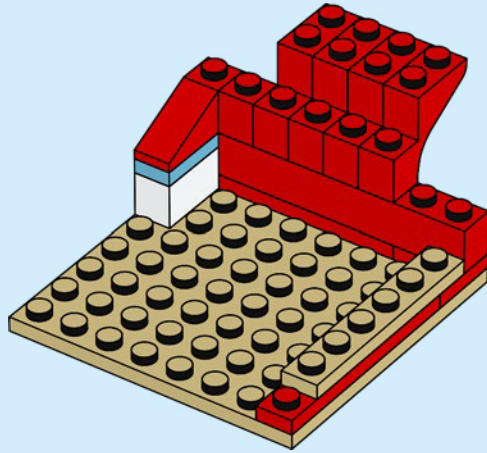

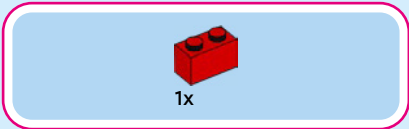

8

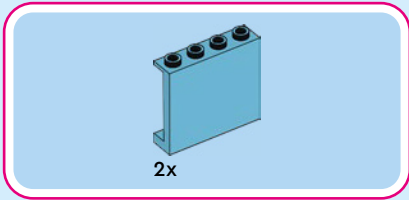
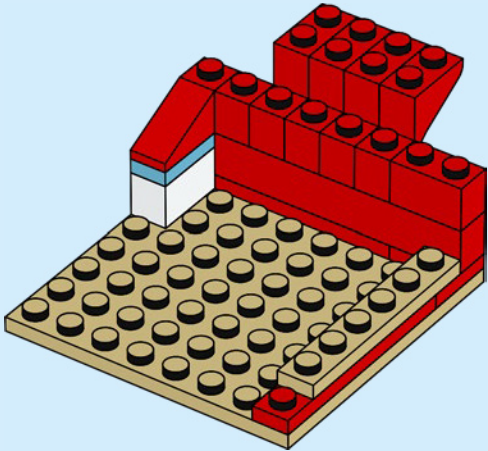

9

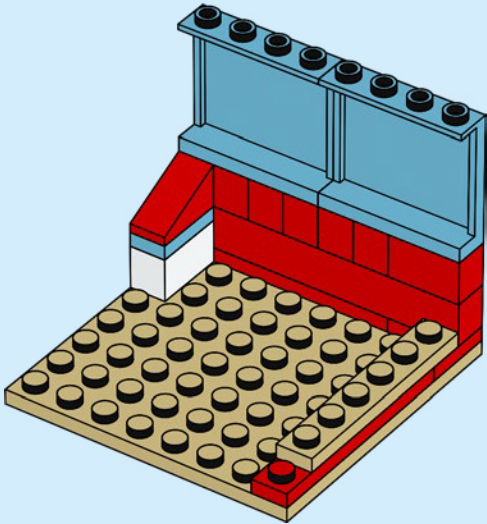

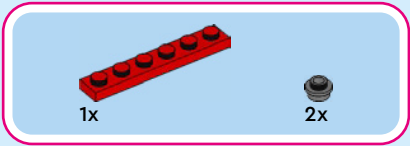

10

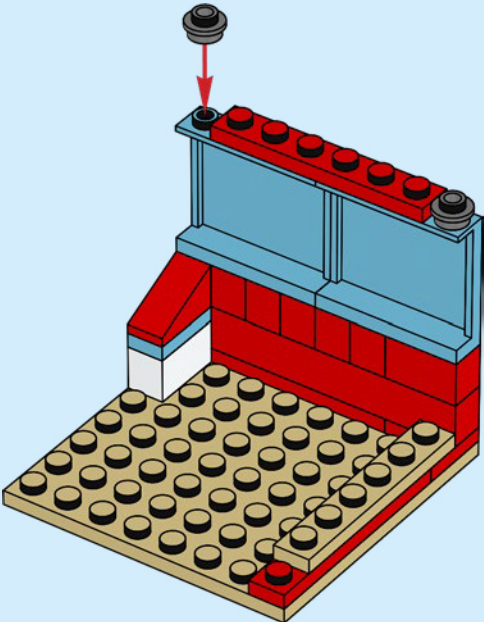

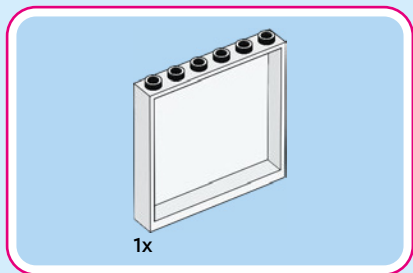

11

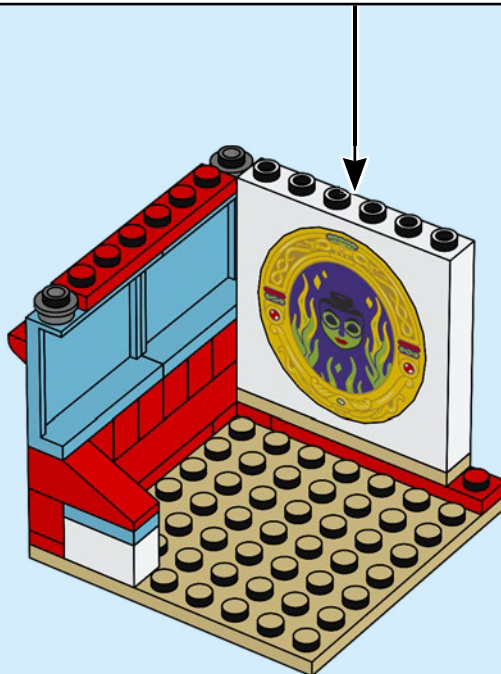
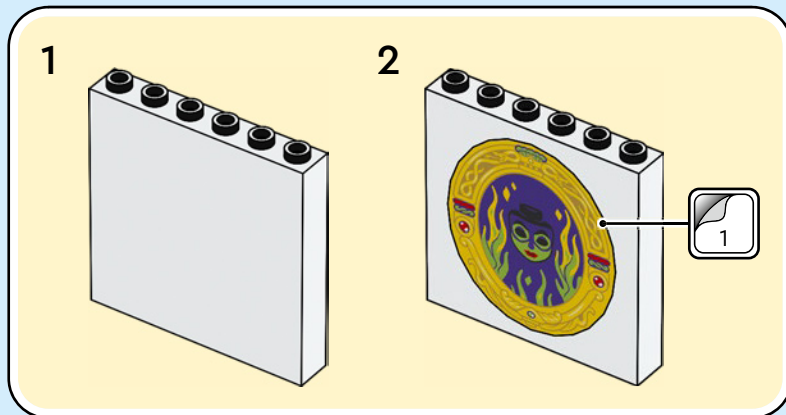

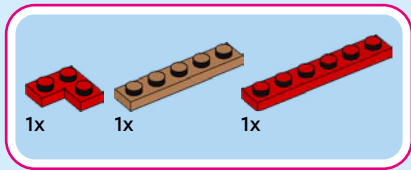

12



2x

13

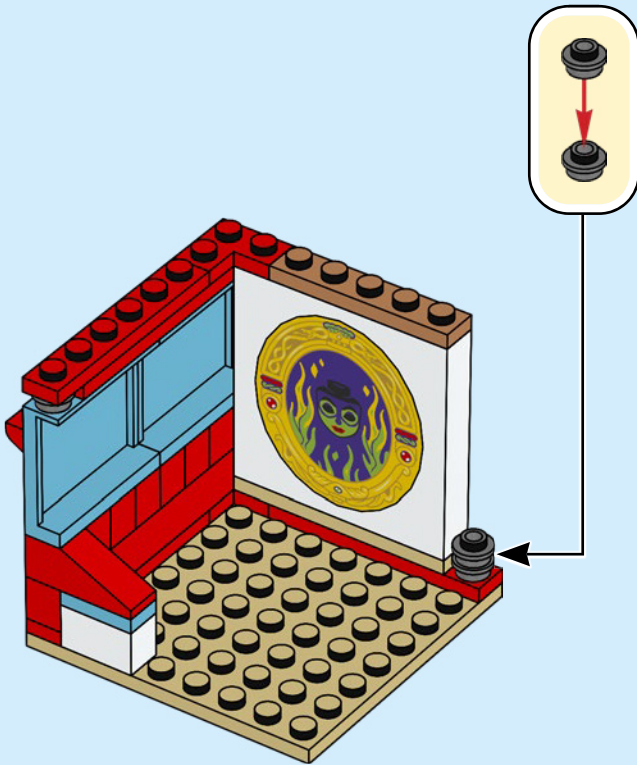

1x

14



1x



1x

15



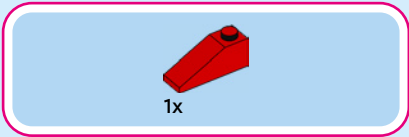

16





1x



1x

17

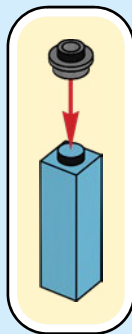



1x

18

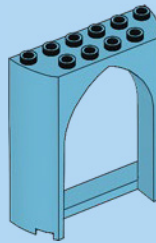

1x

19

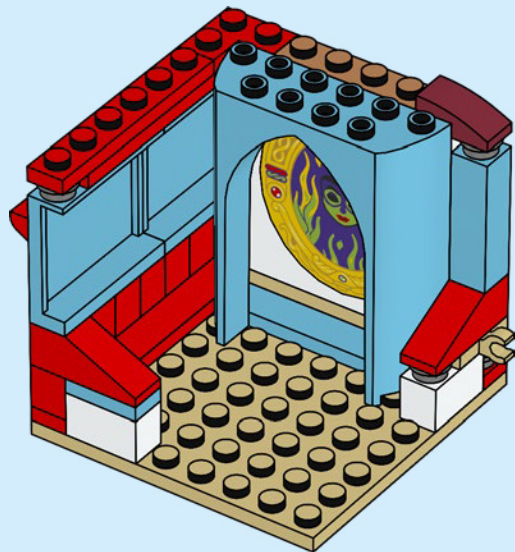



2x

20



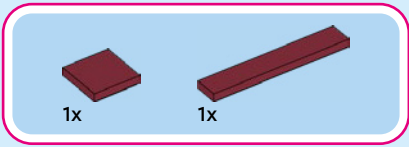

21





1x

22

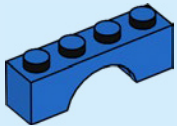

2x

23

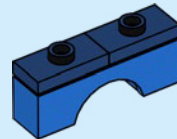



2x

24

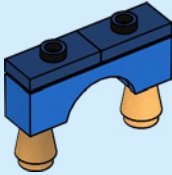

1x



1x



1x



1x

25

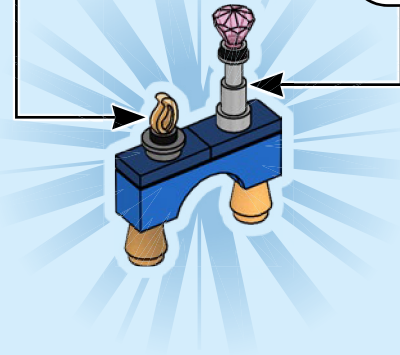
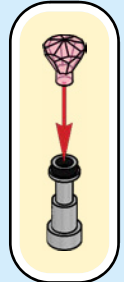
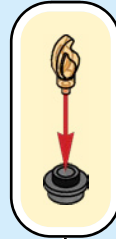



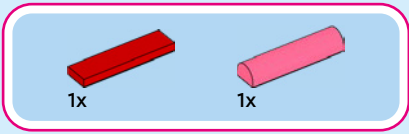

27





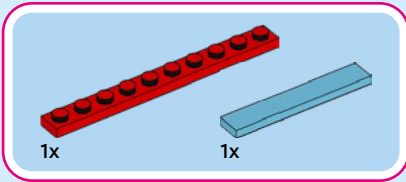
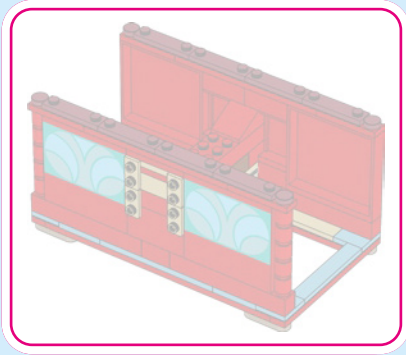

28

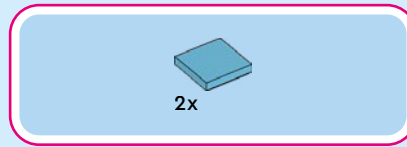
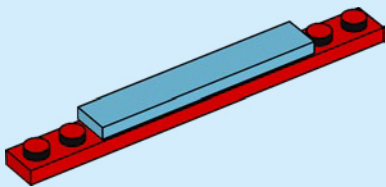

29

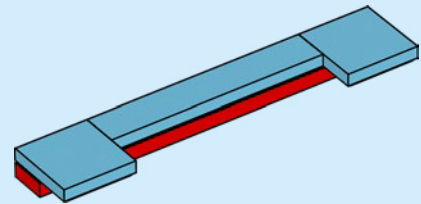

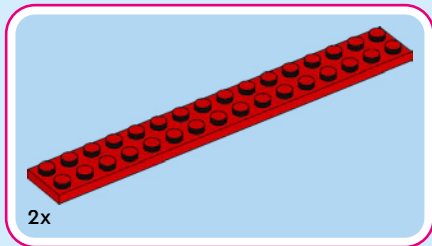

30

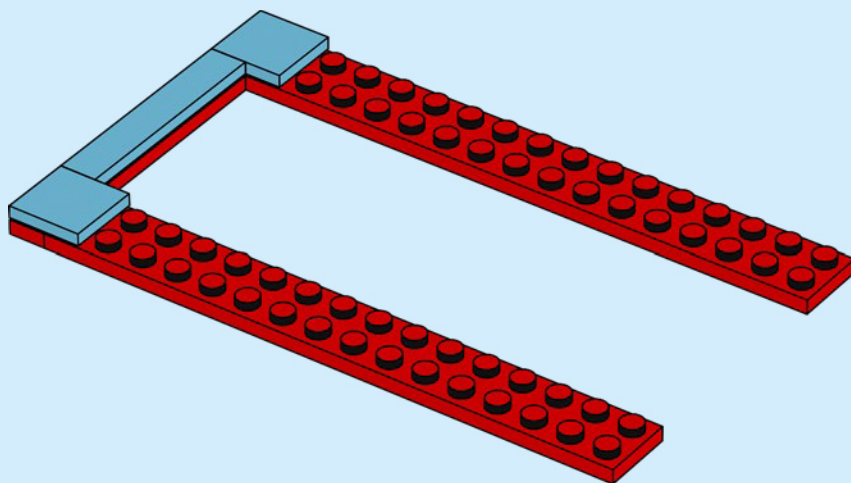

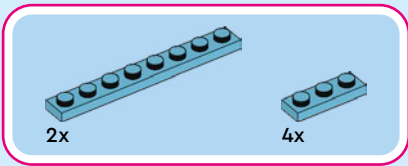

31

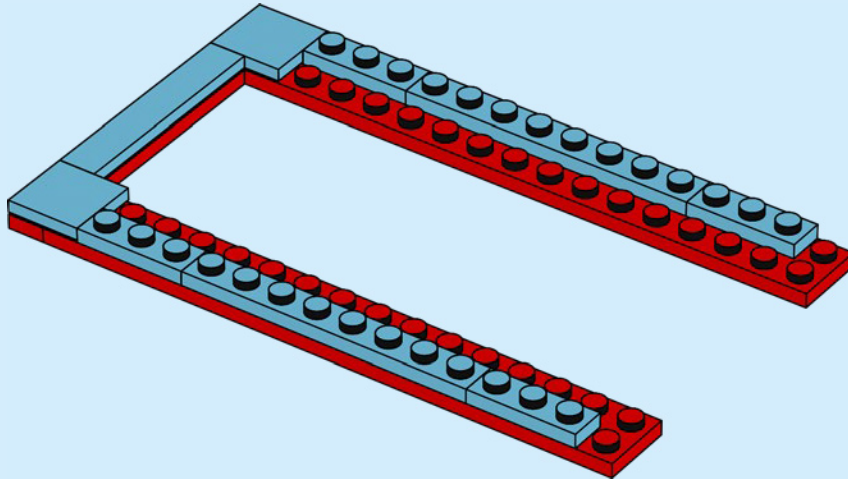

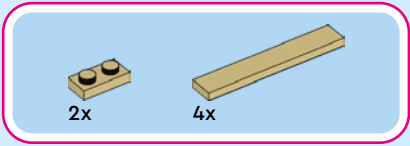

32

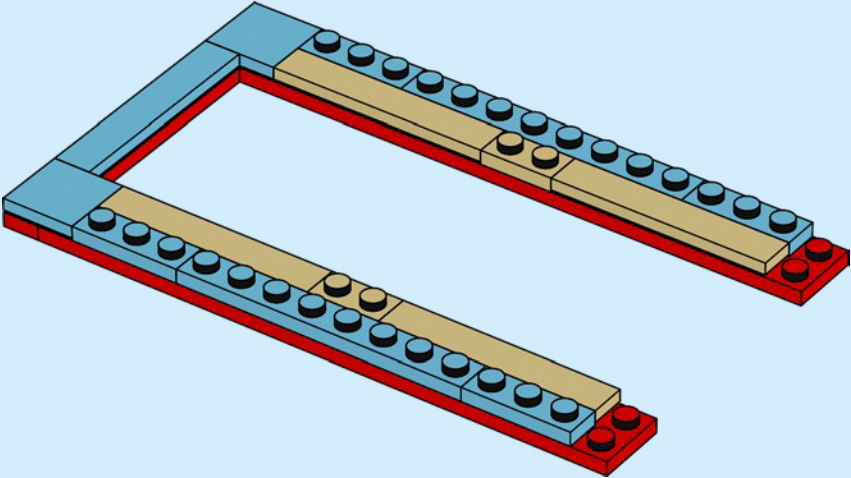



2x

33

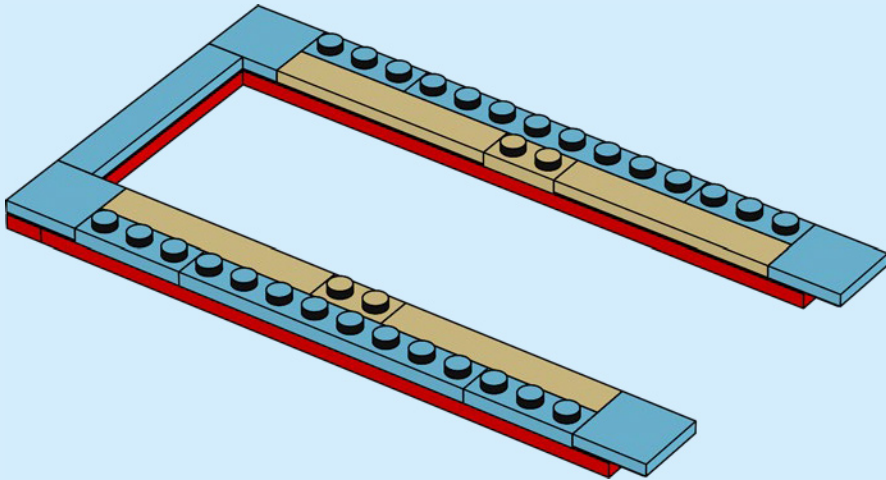

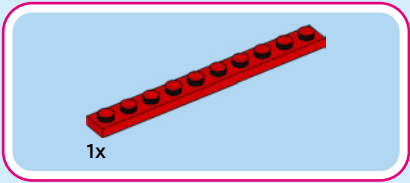

34

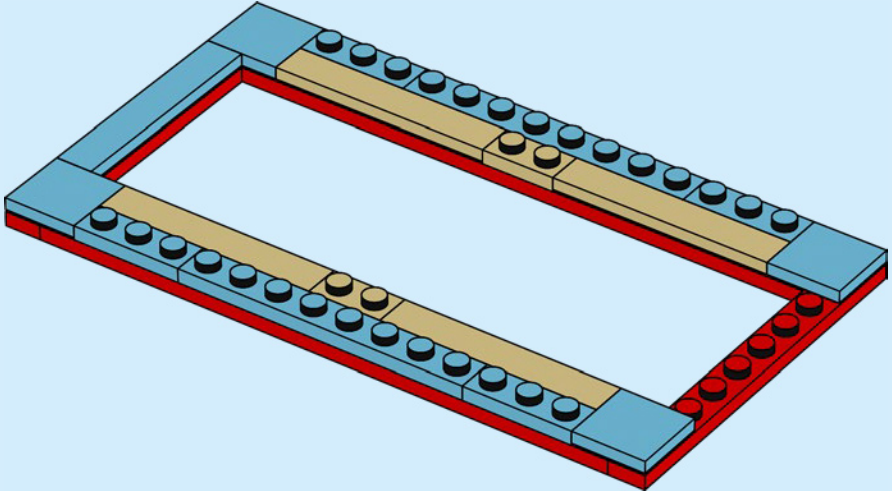

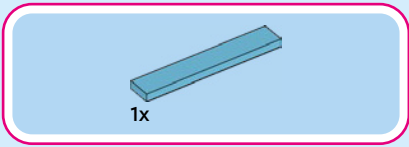

35

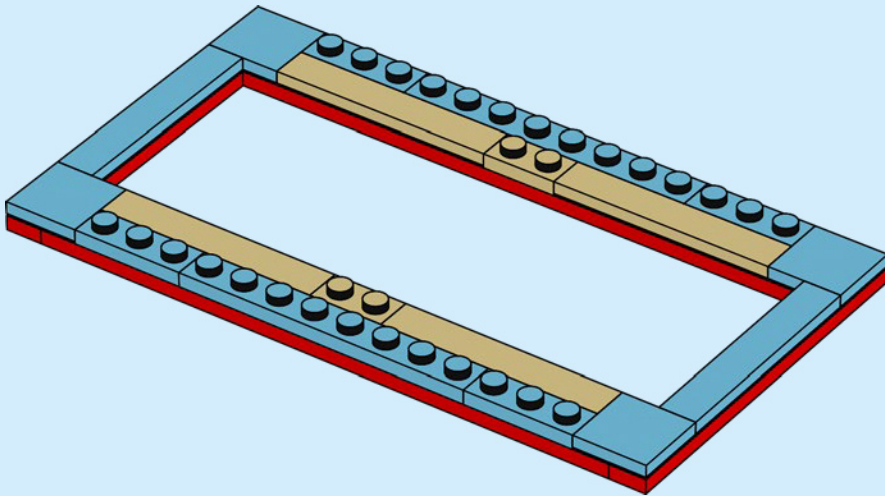

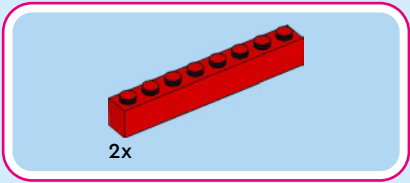

36

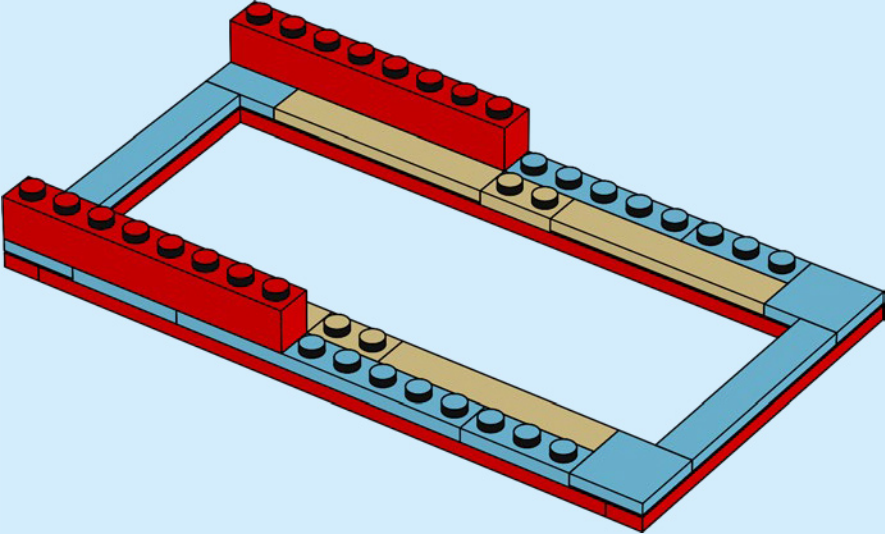

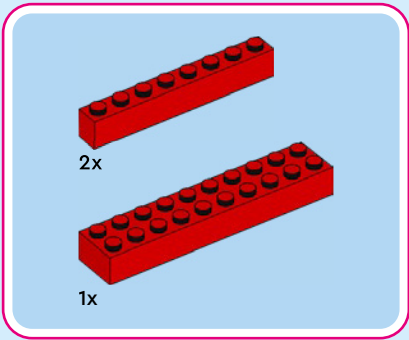

37

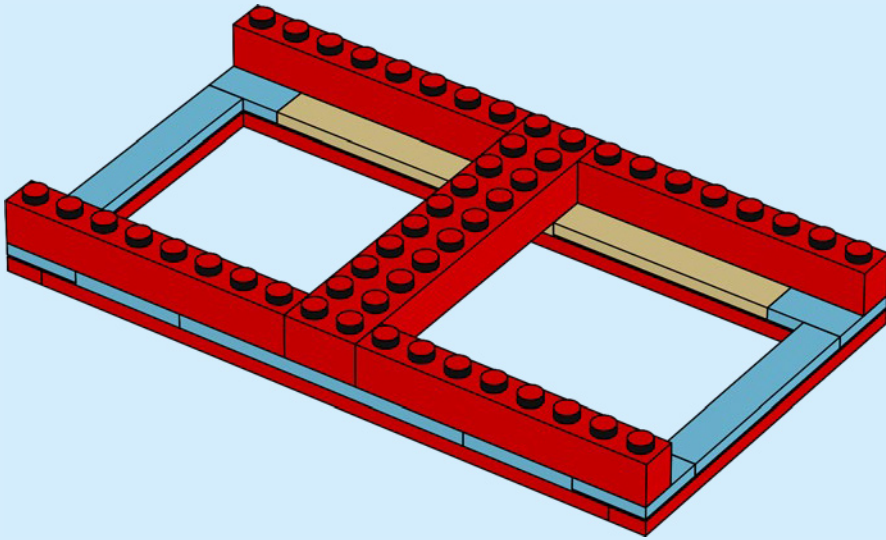



2x

38

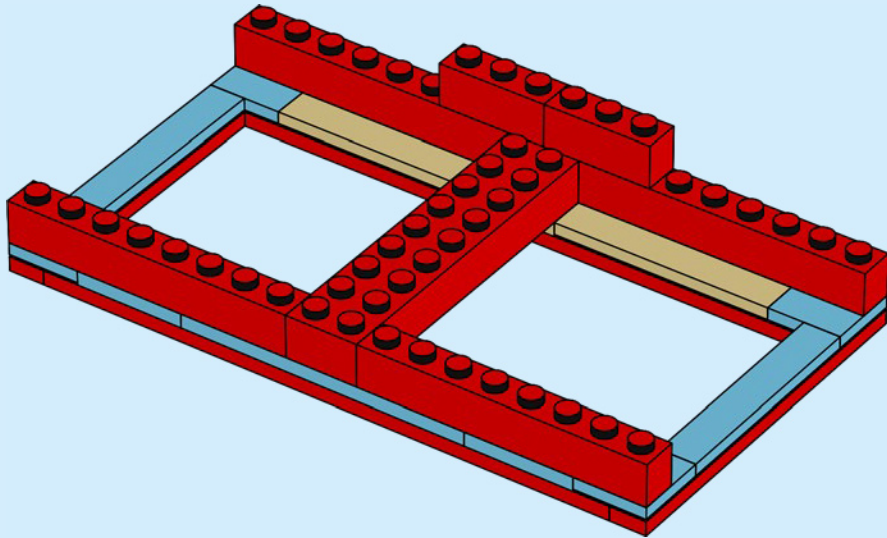



2x



1x

39

1



2

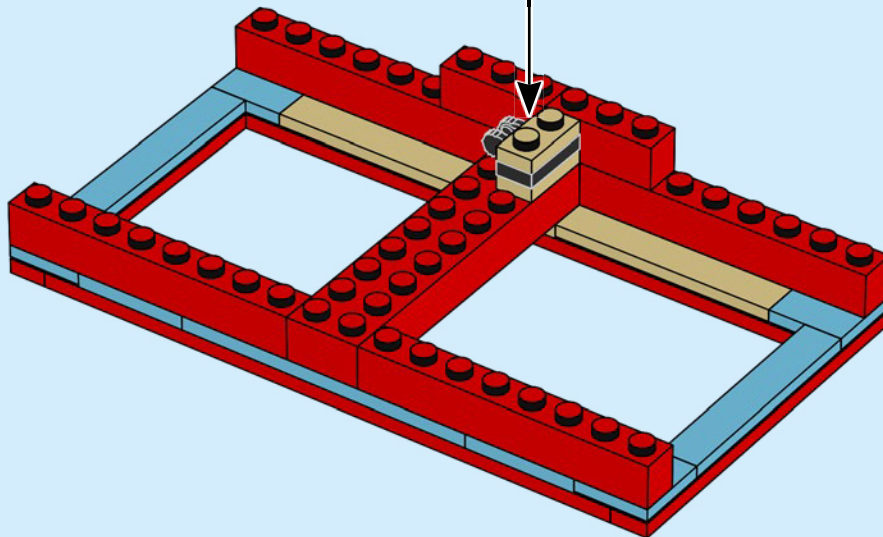

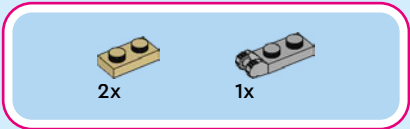

40

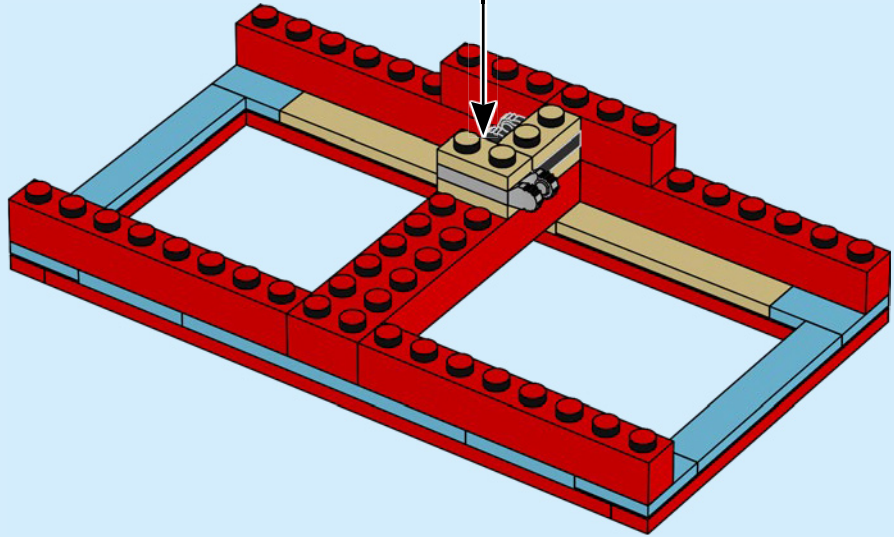
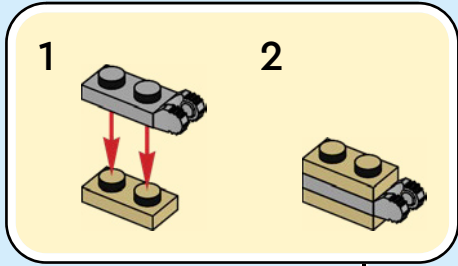

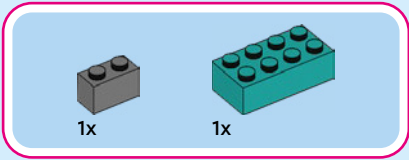

41

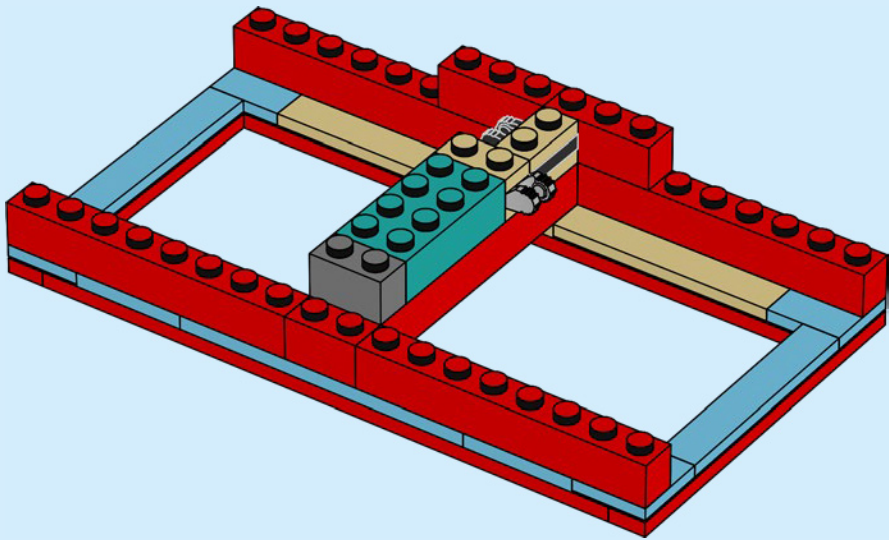

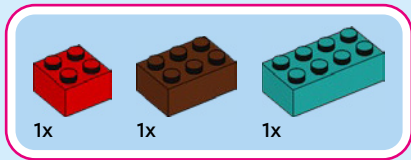

42

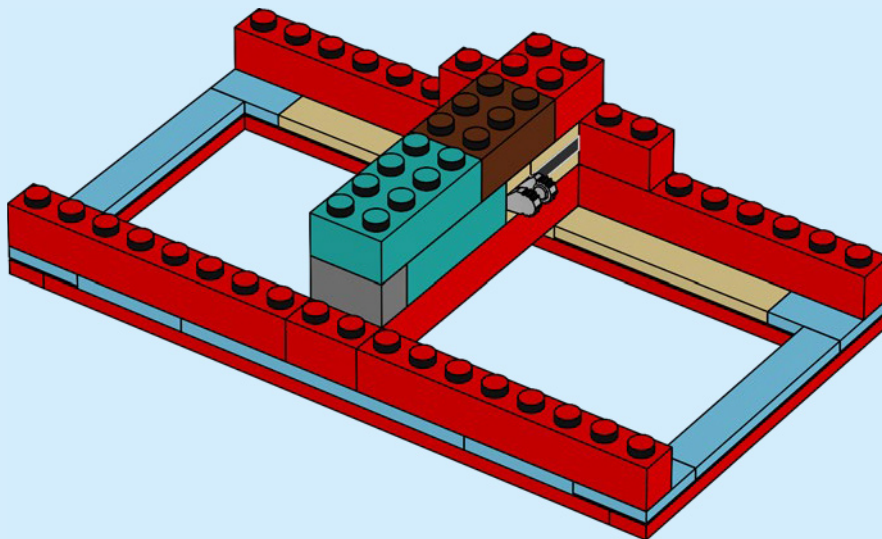

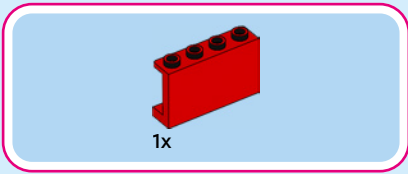

43

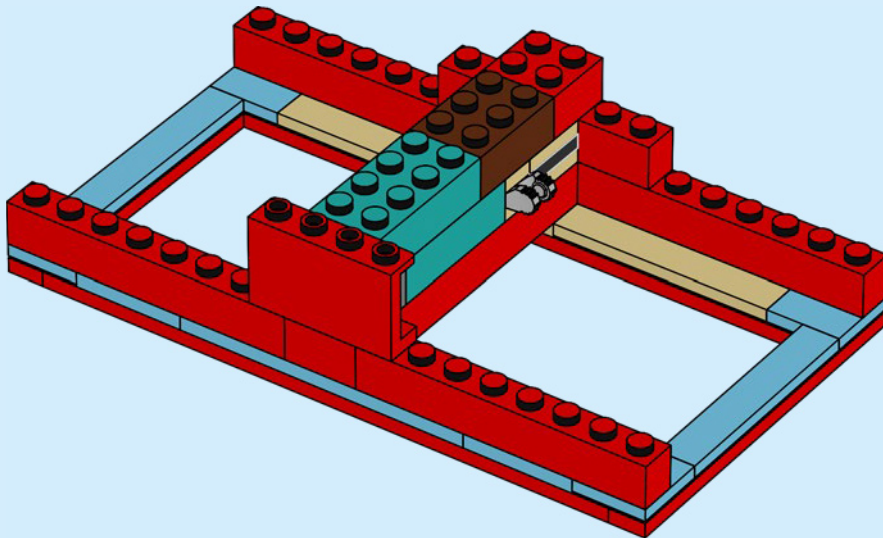

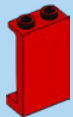

2x

44

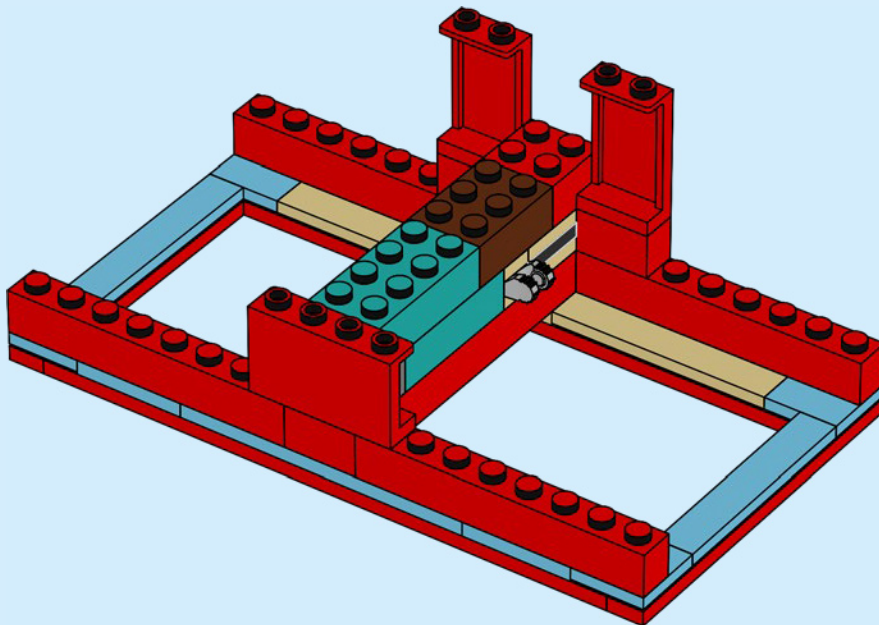

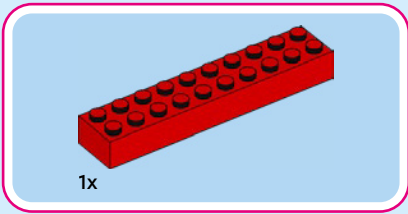

45

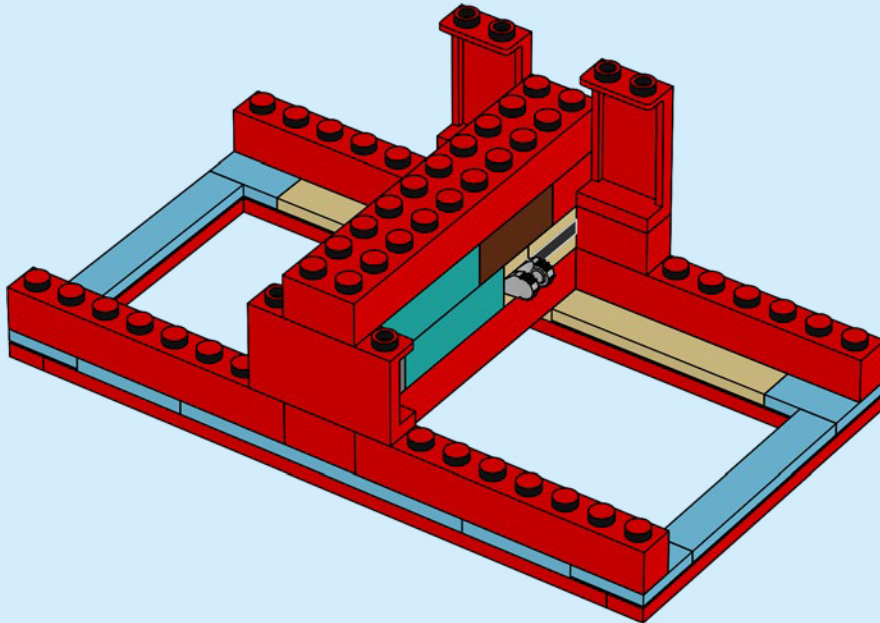



1x

46

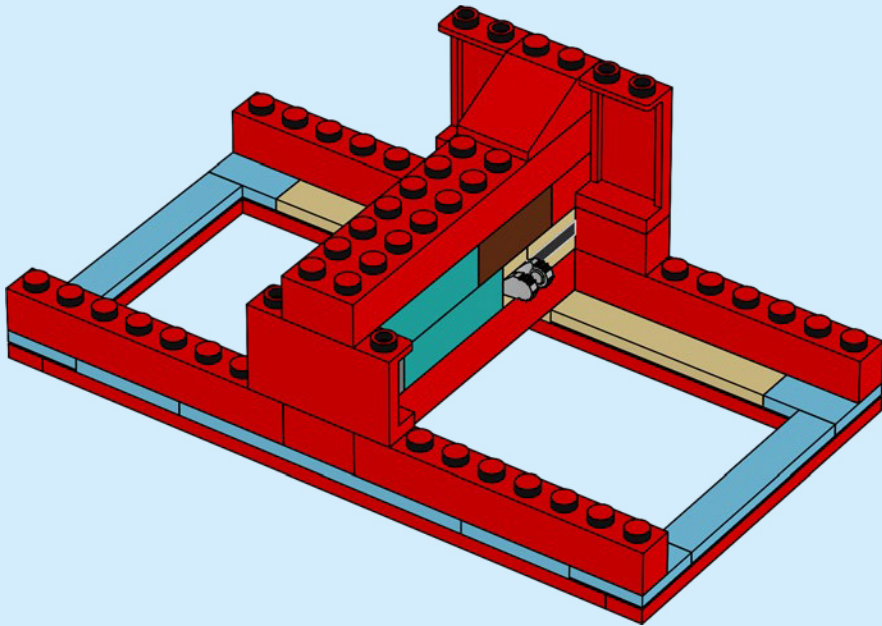



2x

47

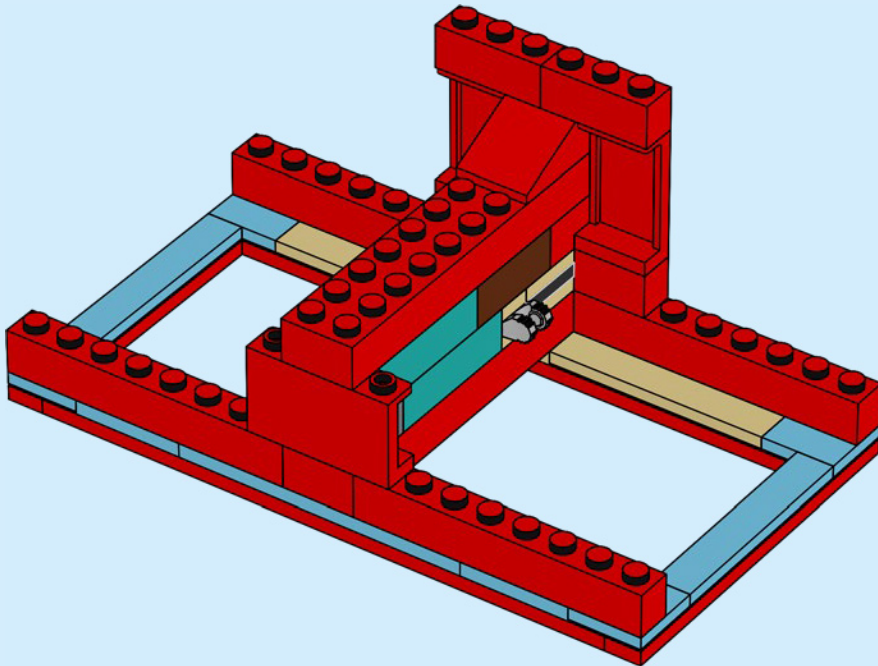



2x

48

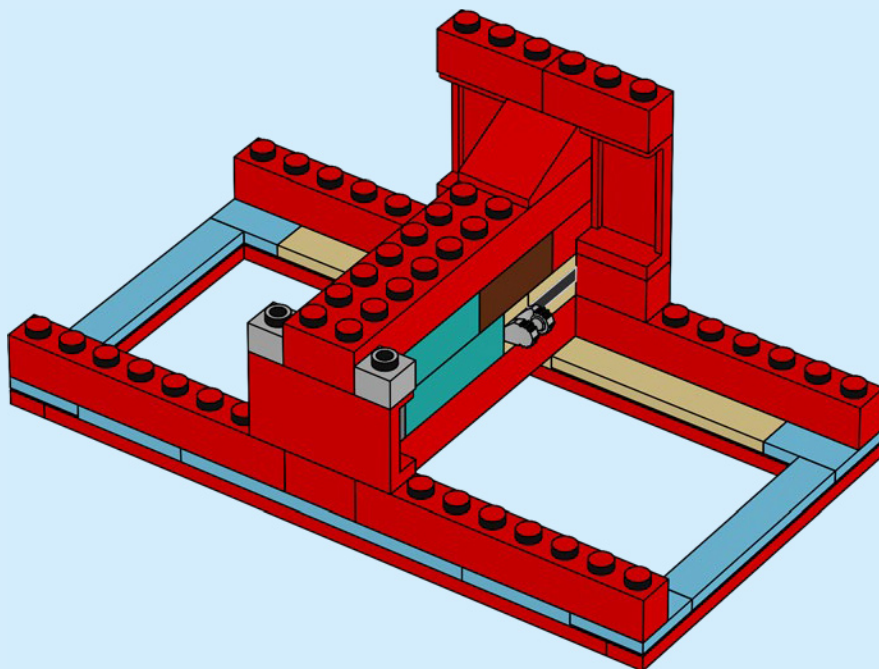



2x

49

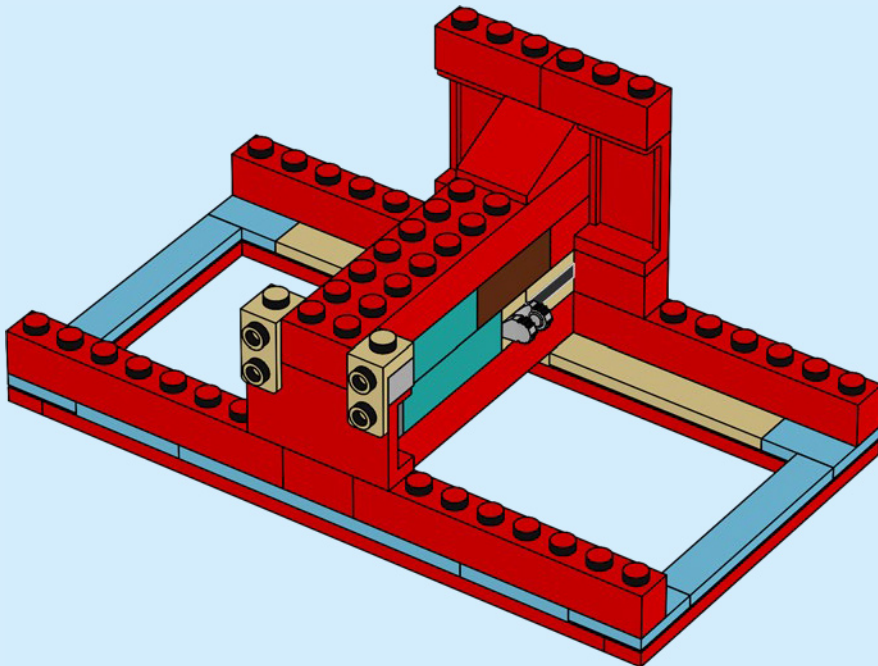

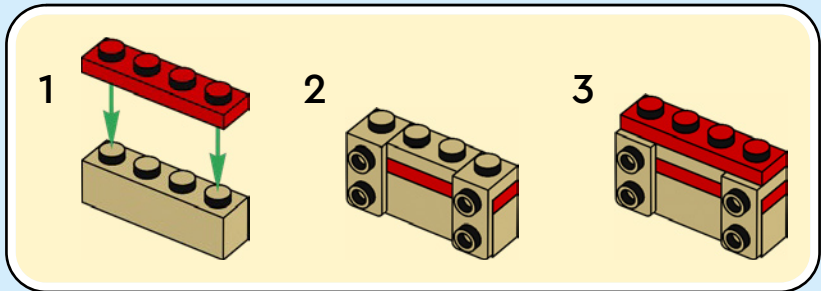
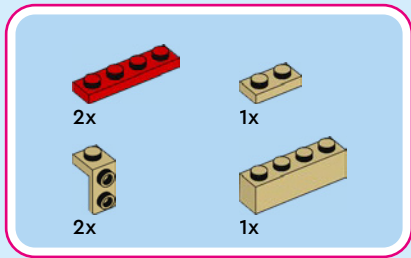

50

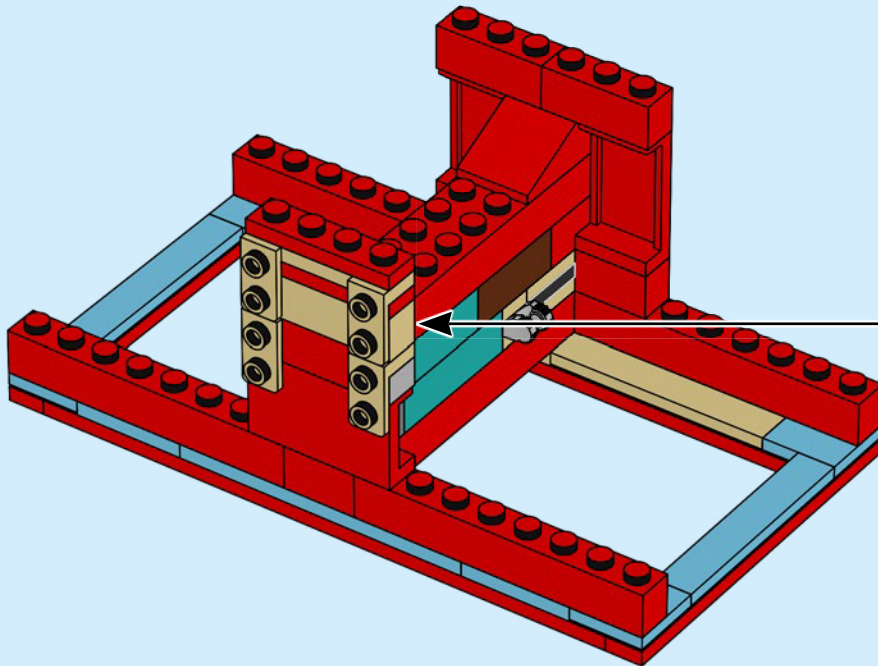

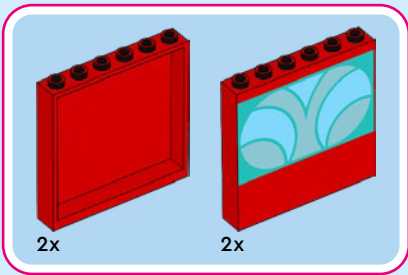

51

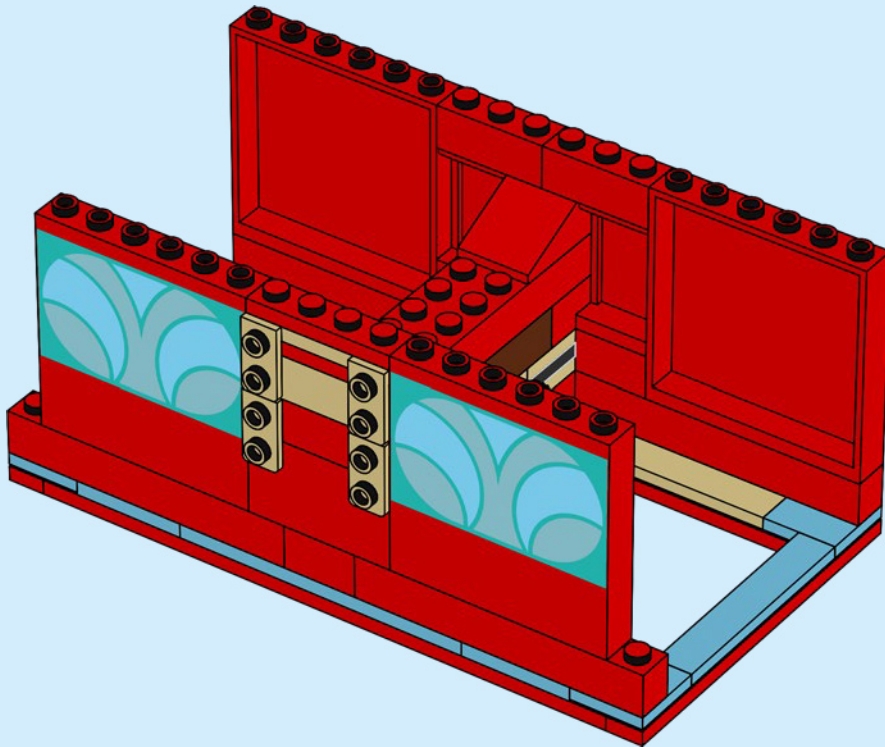

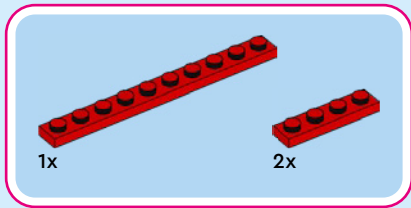

52

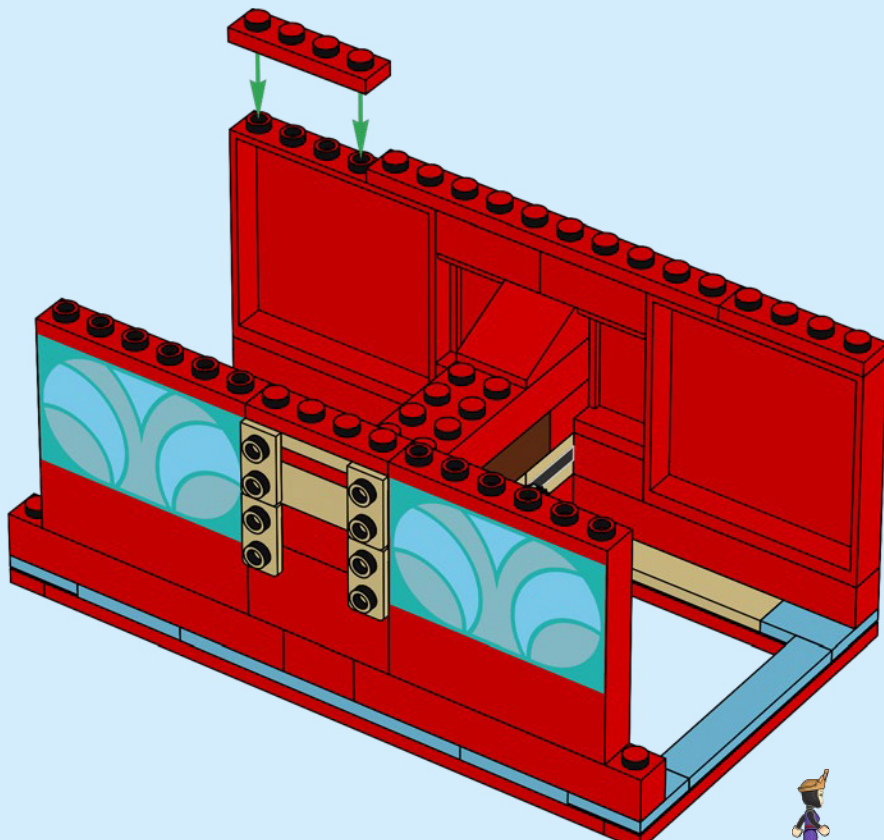



10x

53



2x

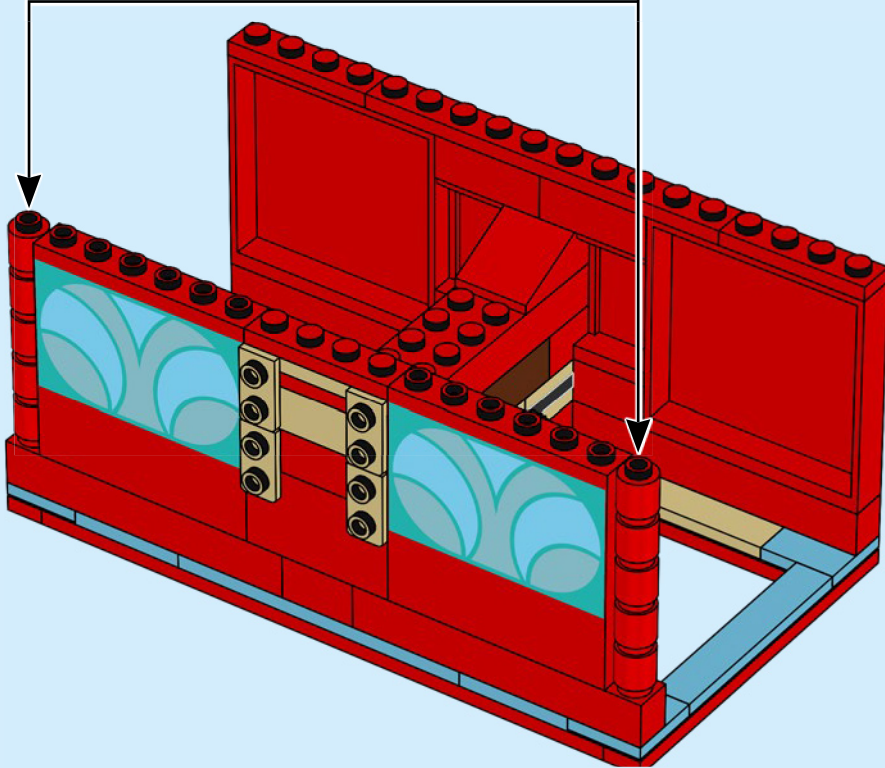

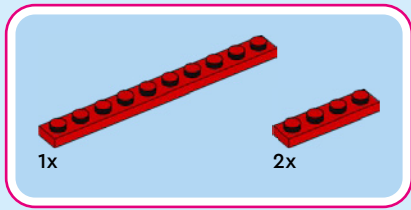

54

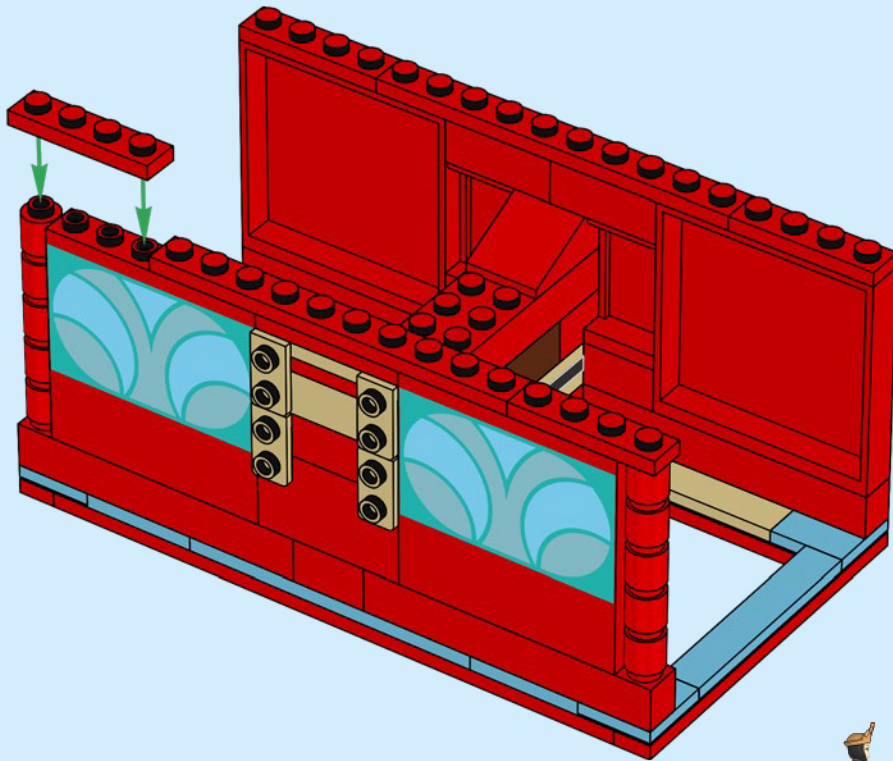



4x

55

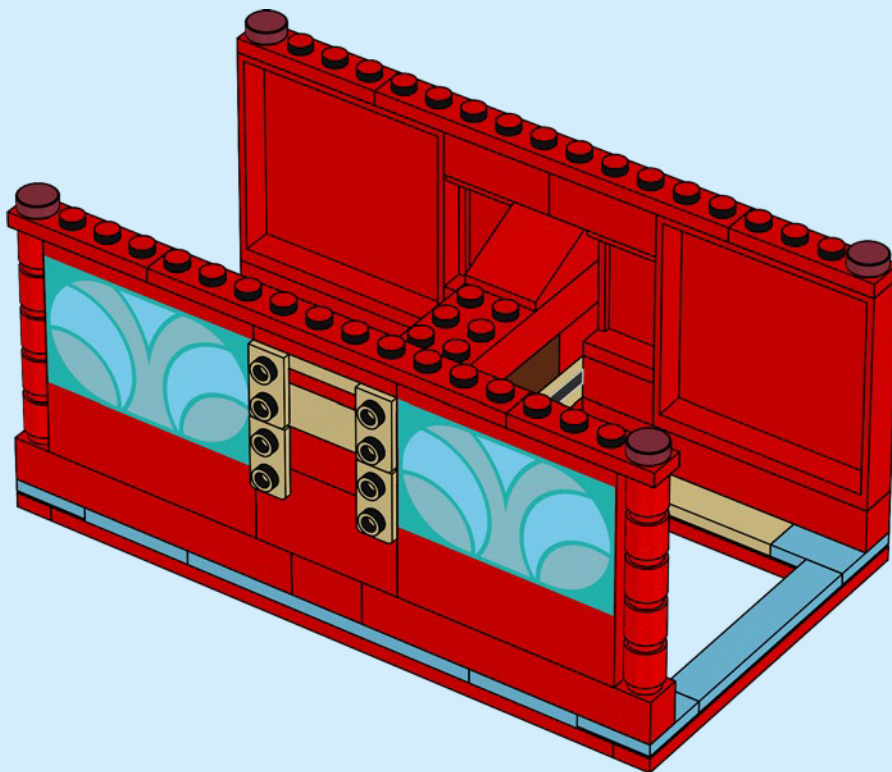



8x

56

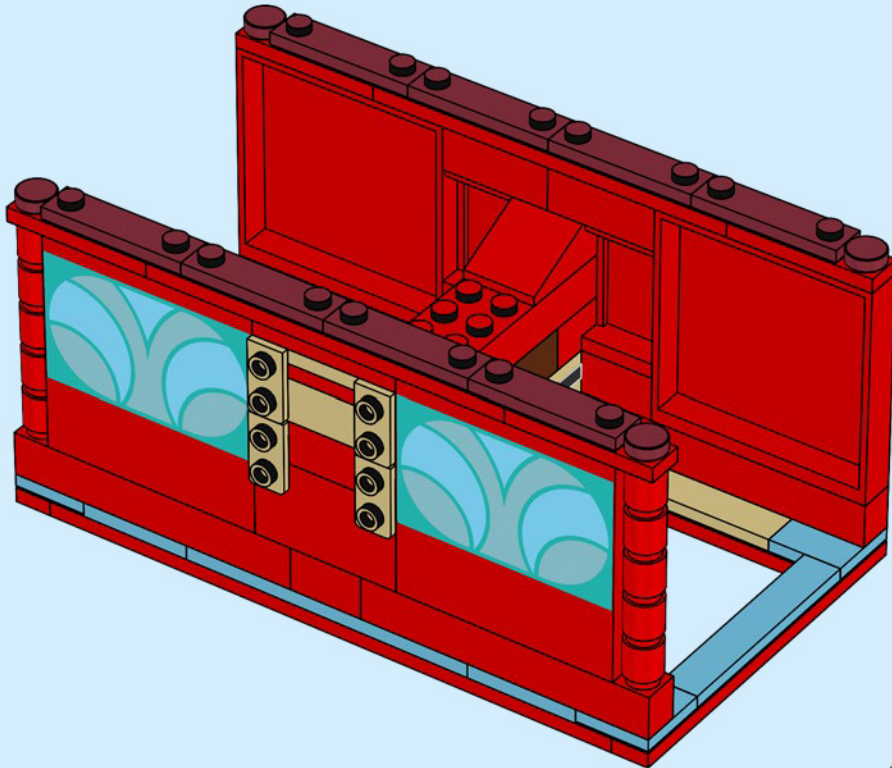

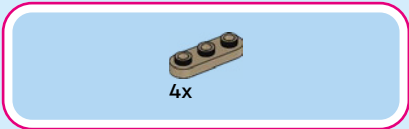

57

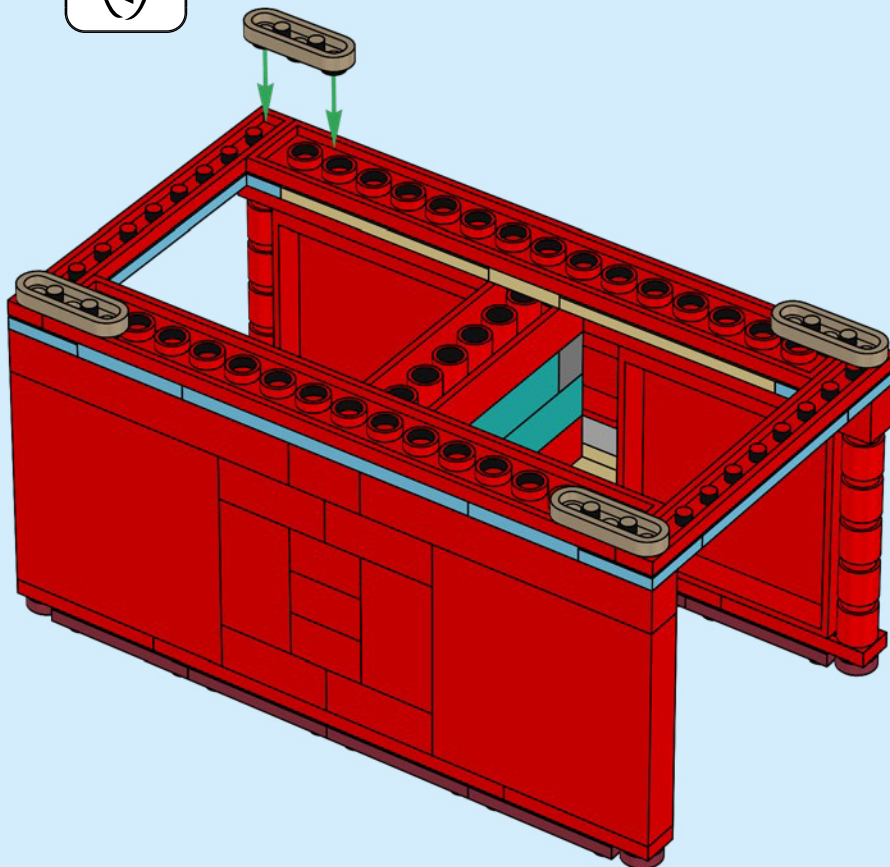

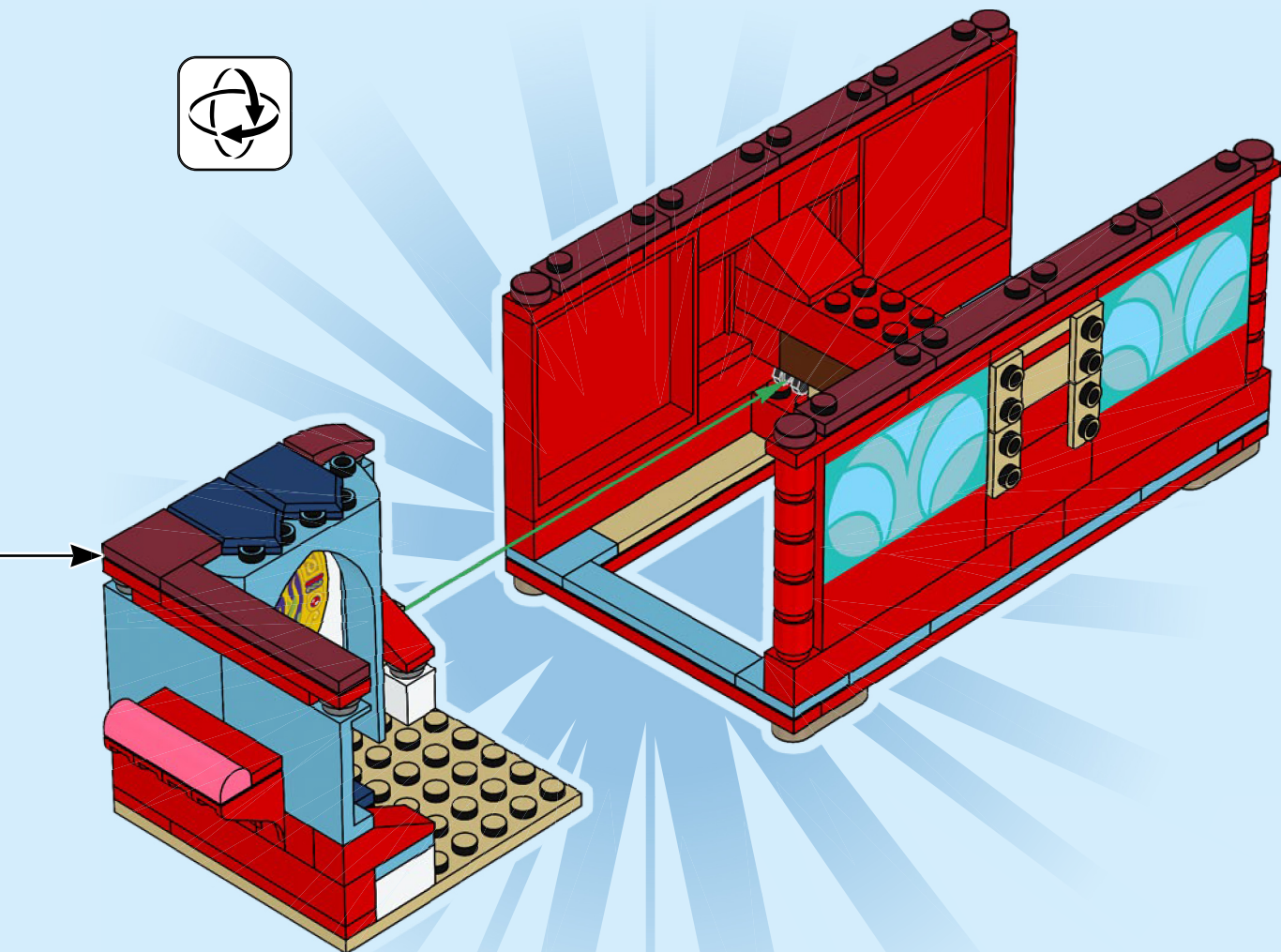

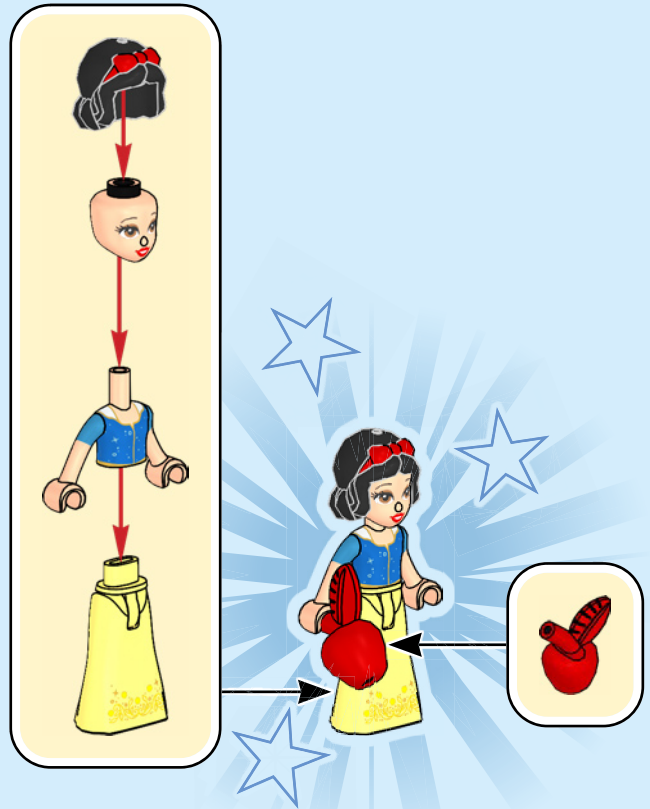

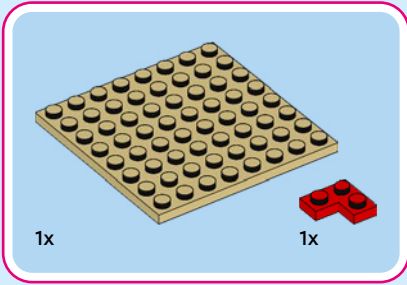
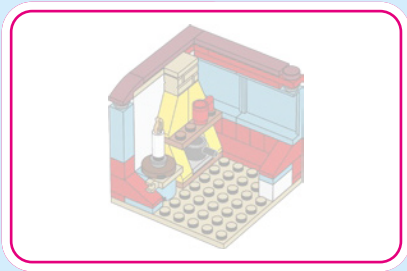

59

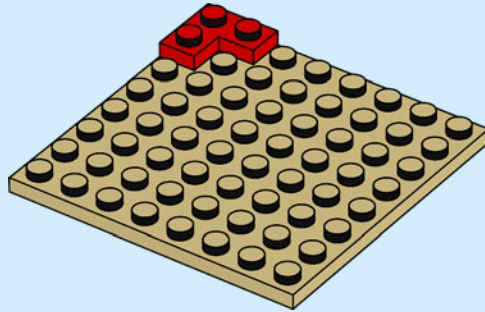

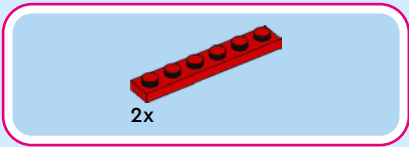

60

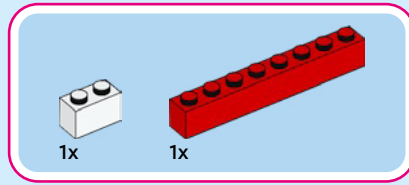
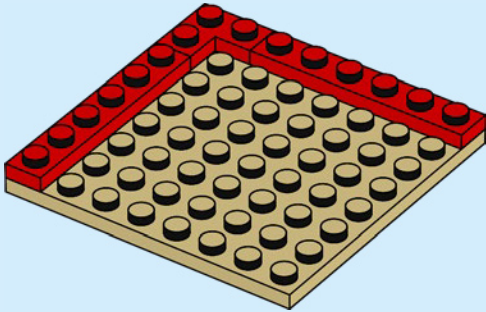

61

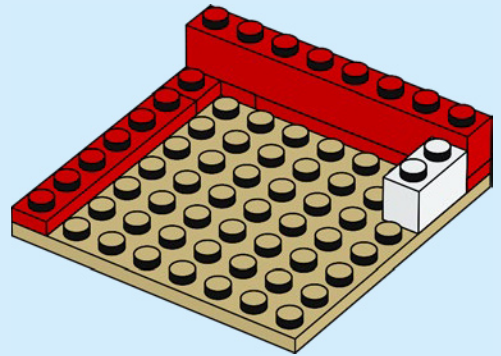



2x

62

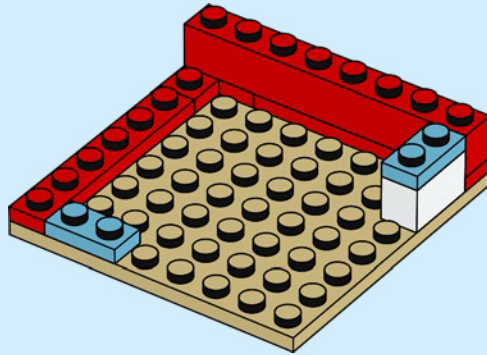

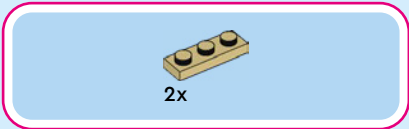

63

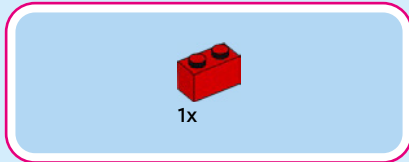
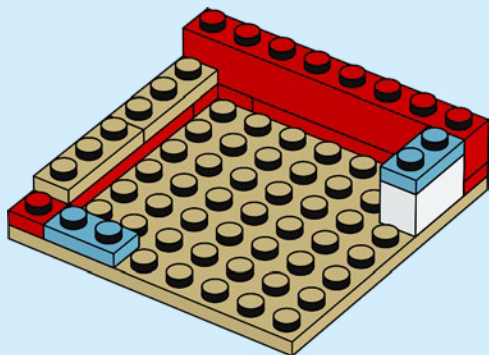

64

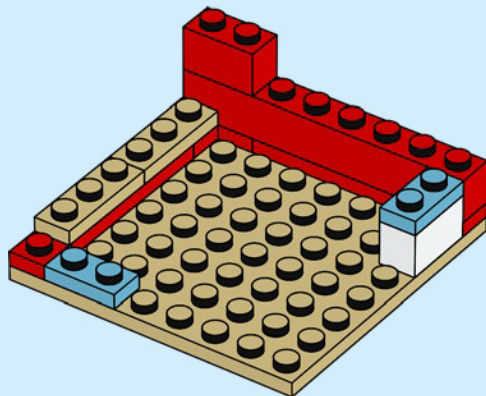

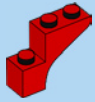

4x

65

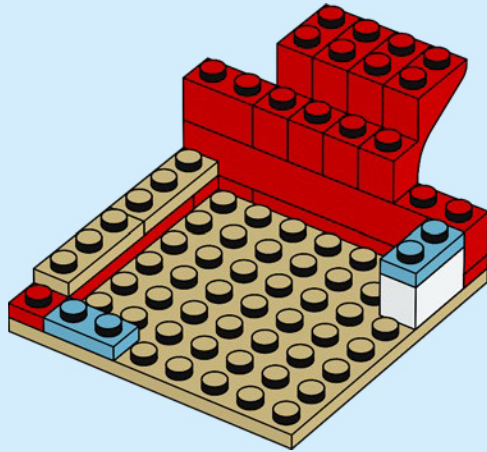

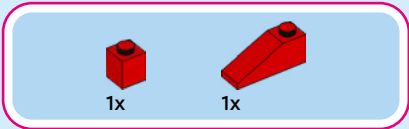

66

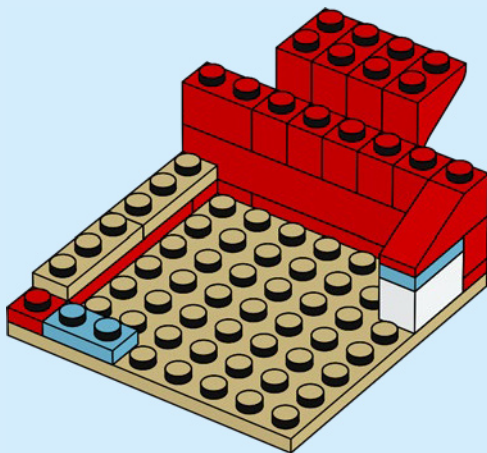

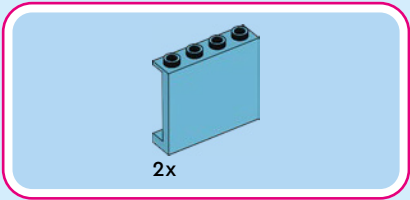

67

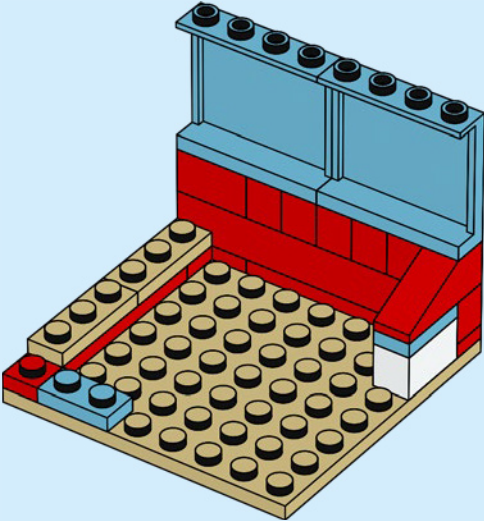

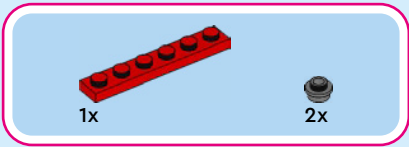

68

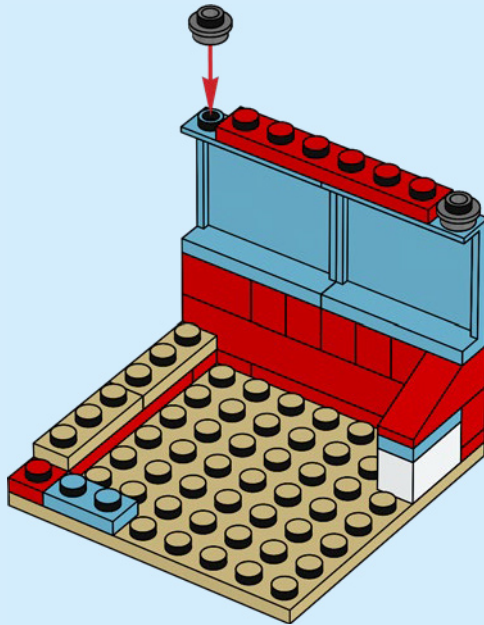

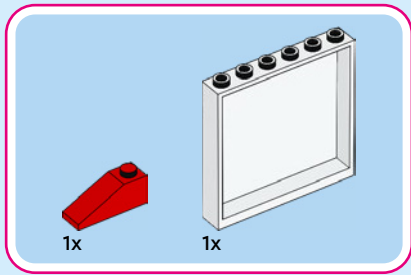

69

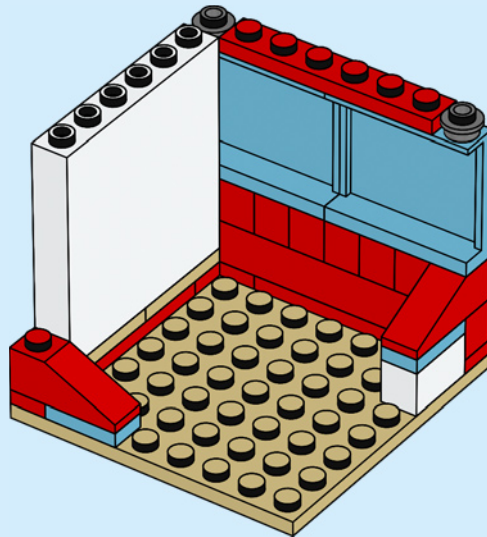

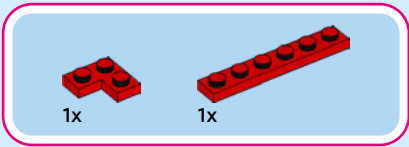

70

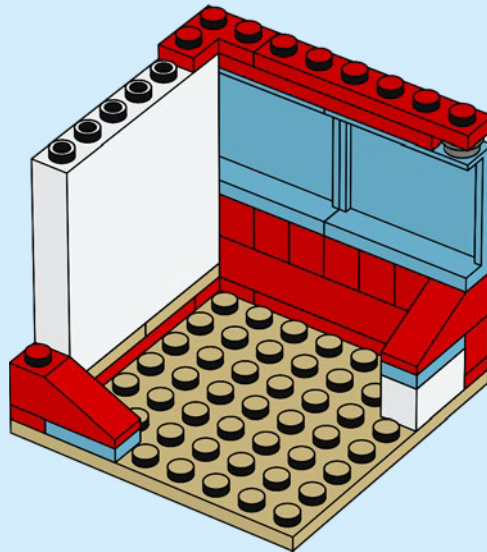

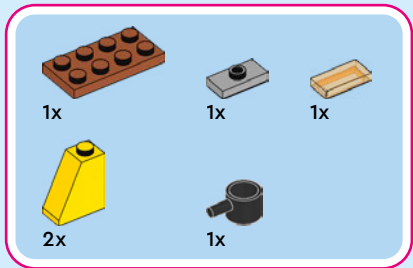

71

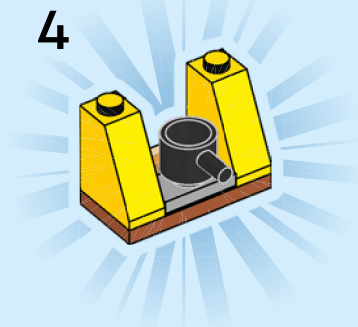
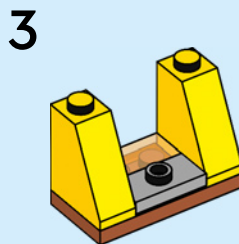
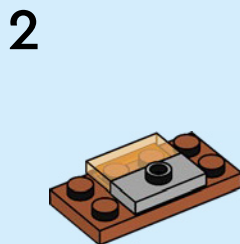
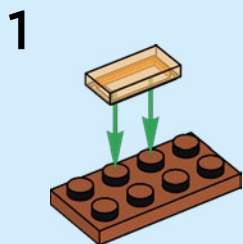

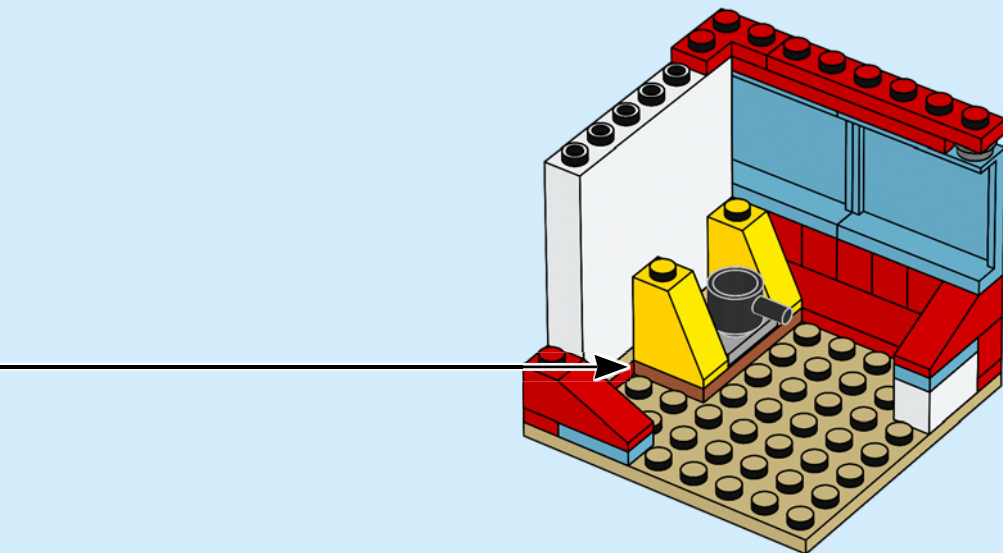

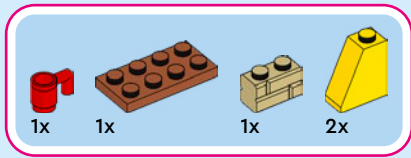

72

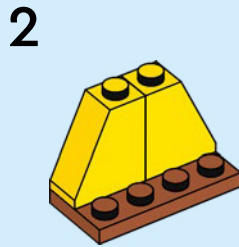
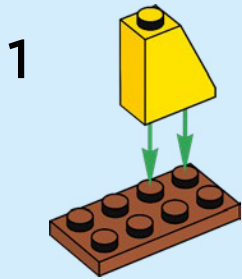

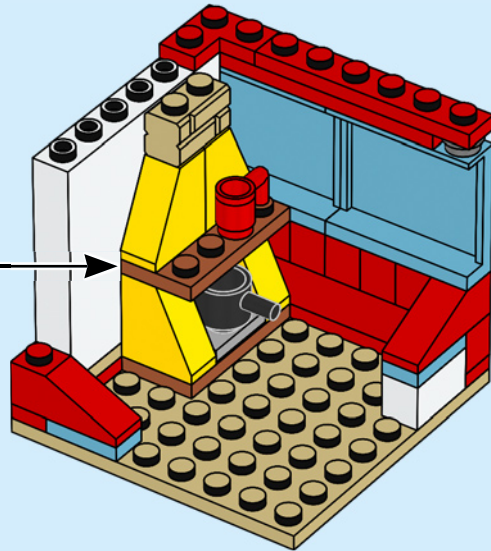

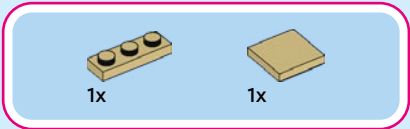

73

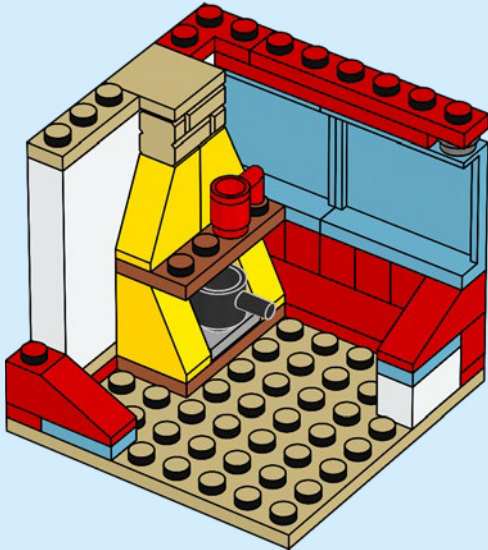

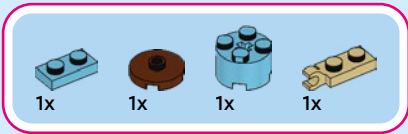

74

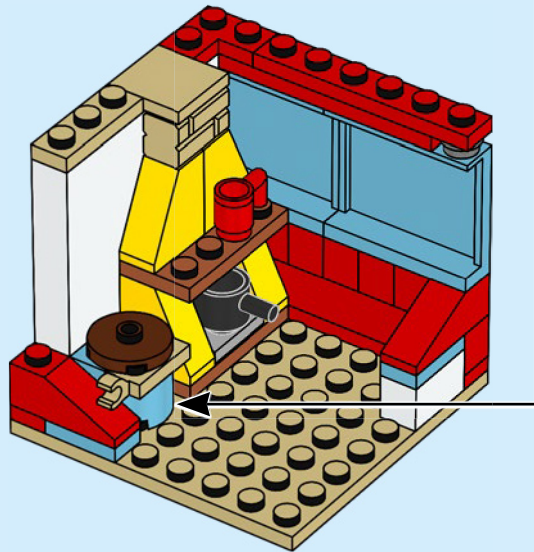
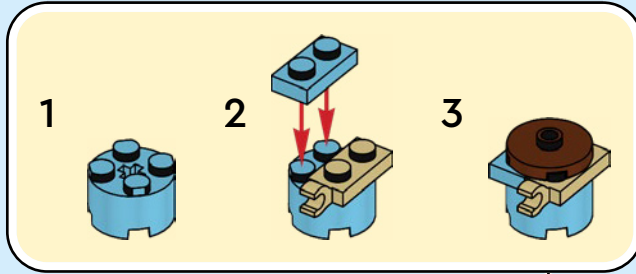



1x



1x



1x

75

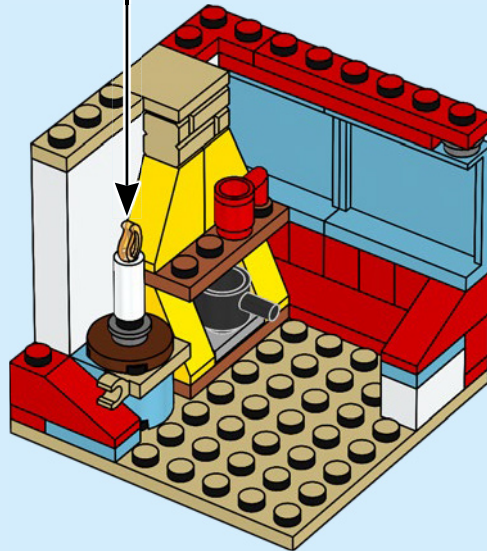
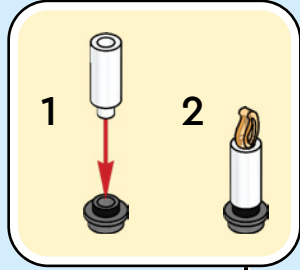



1x

76

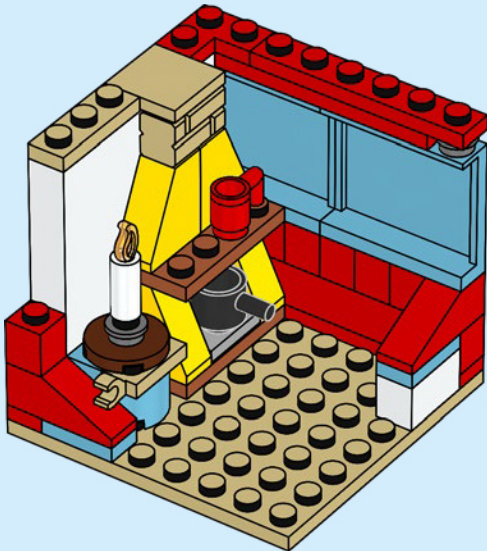

1x



1x

77

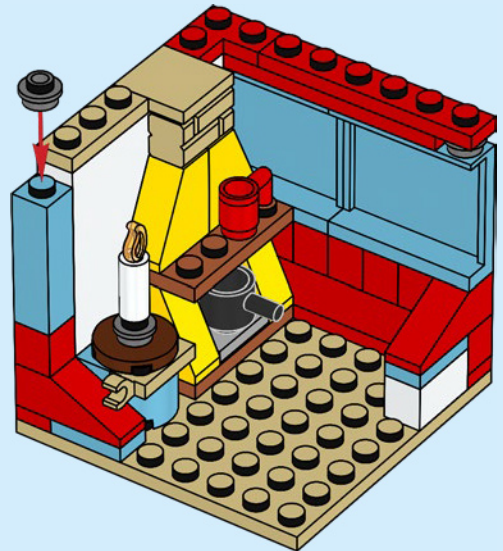



1x

78



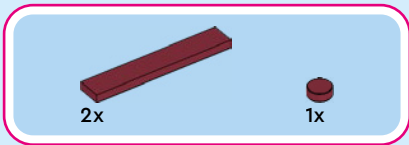

79

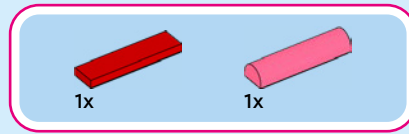

80

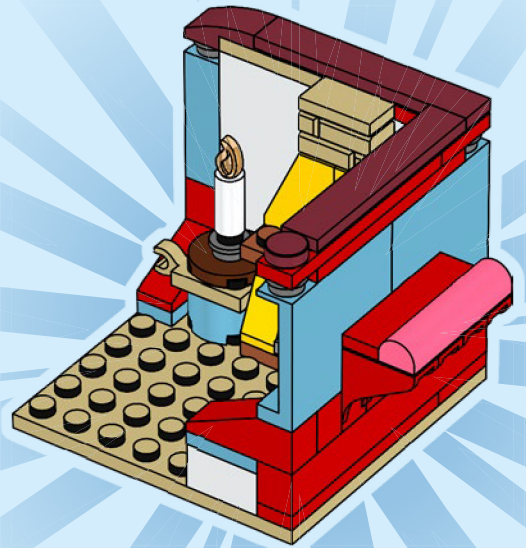
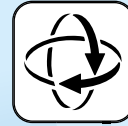

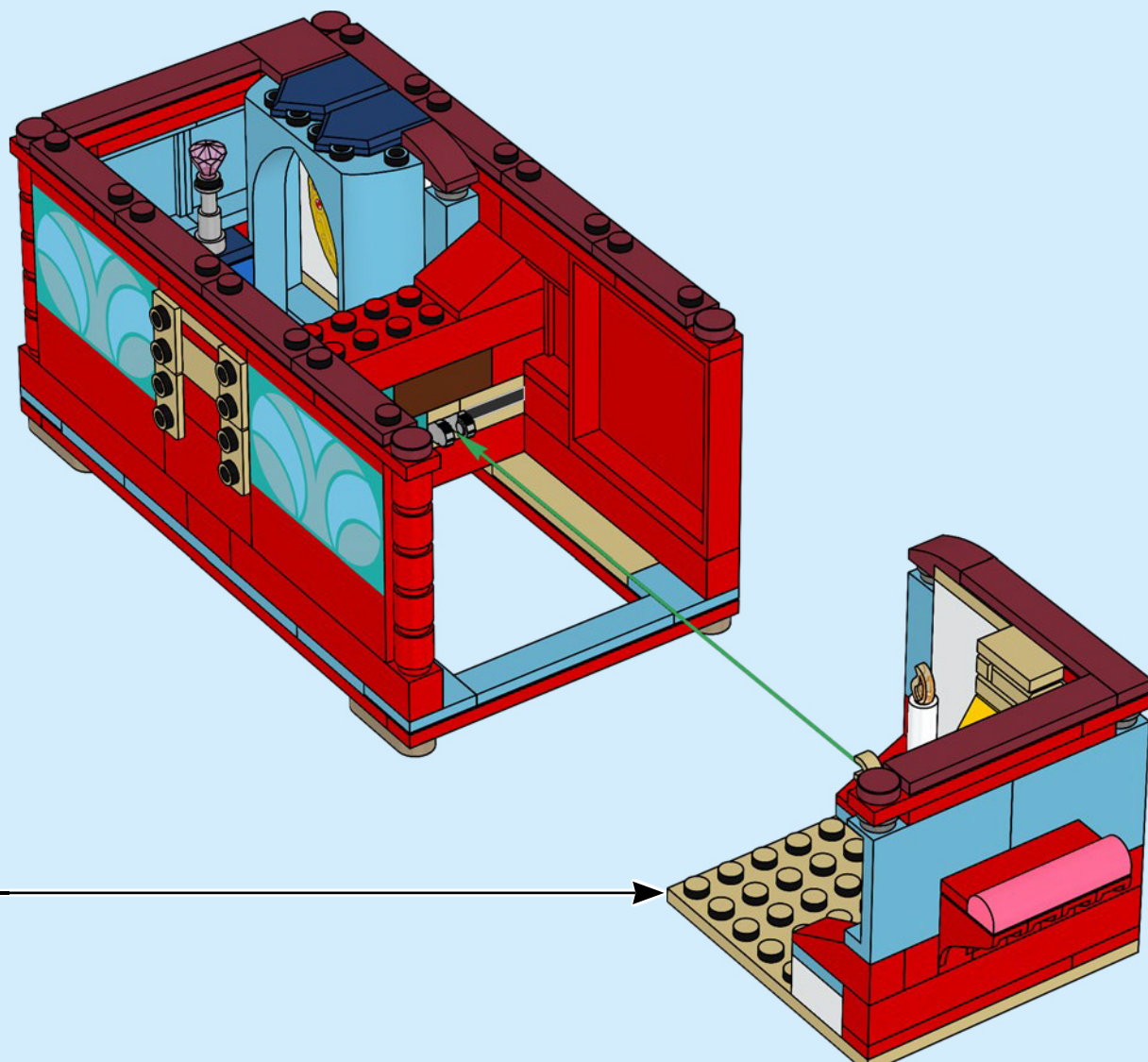

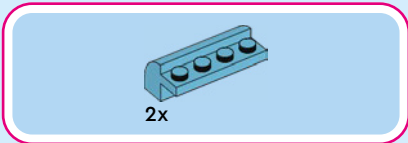

82

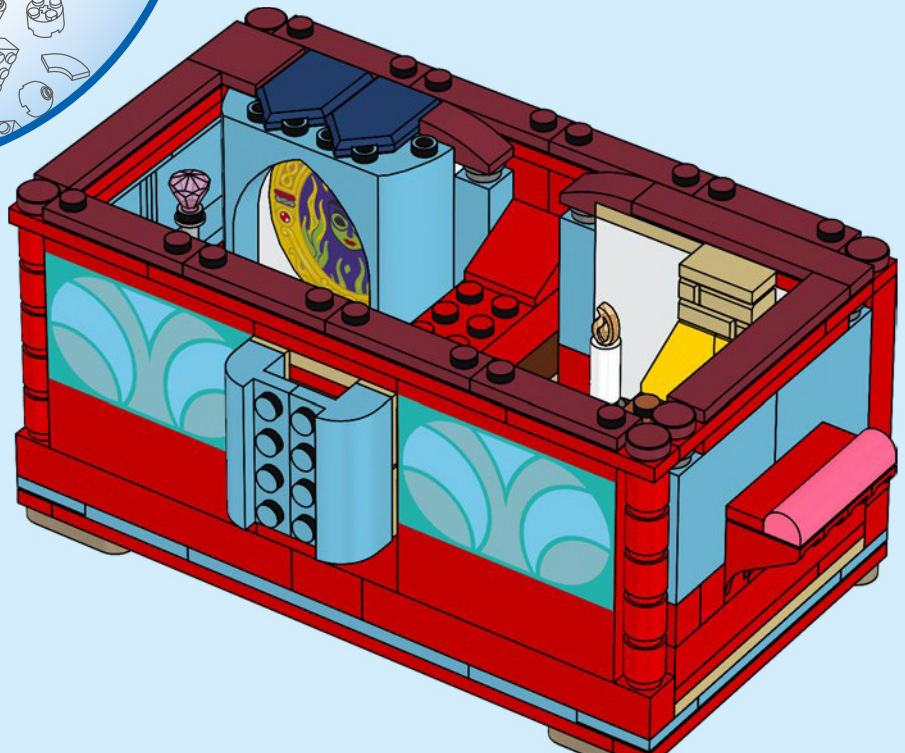



2x



1x

83

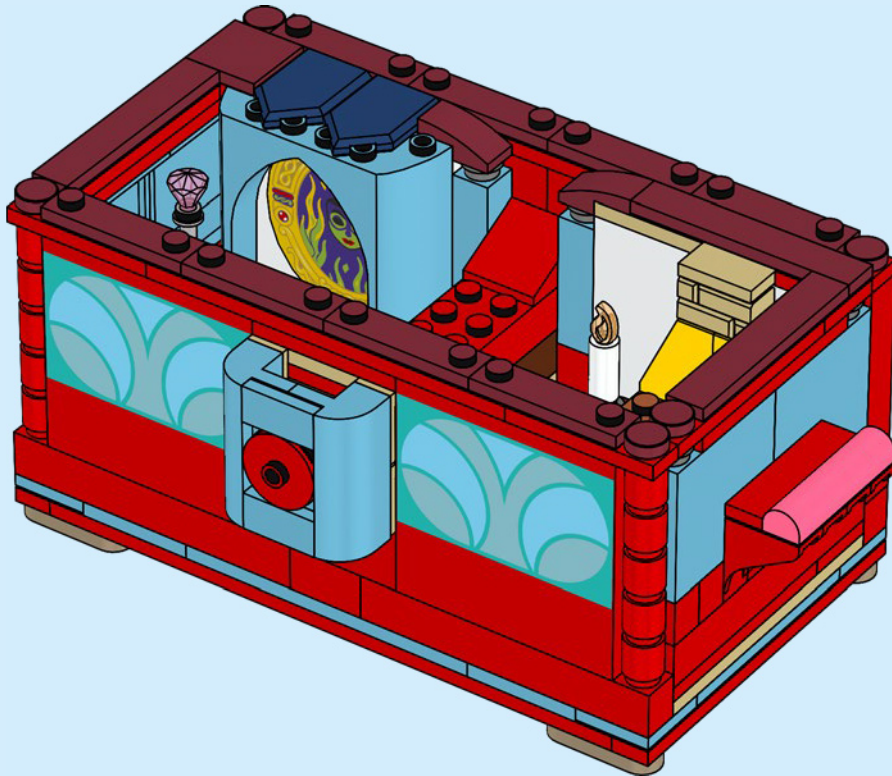

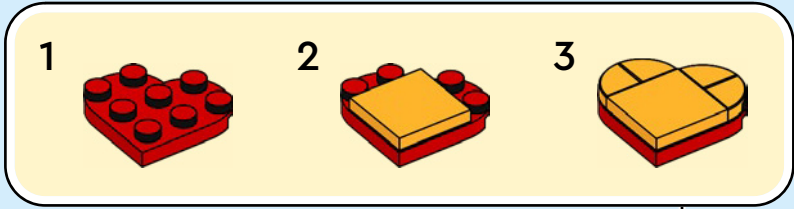
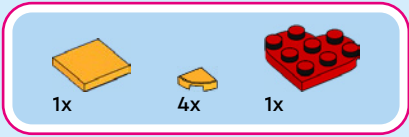

84

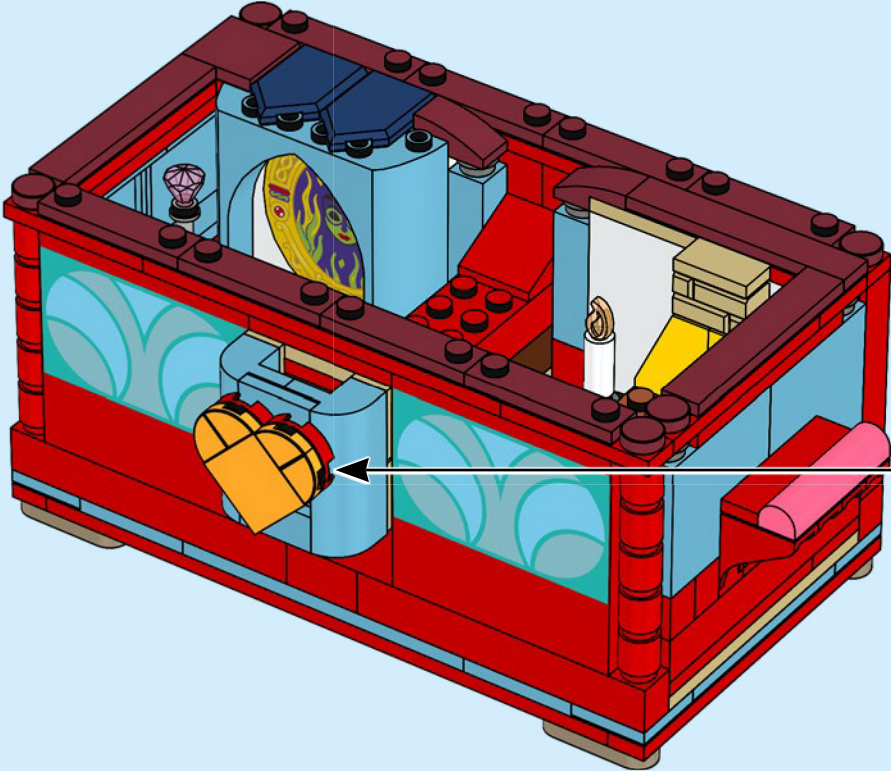

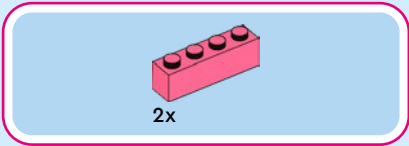

86

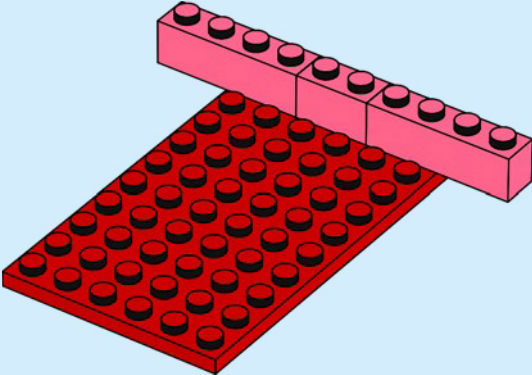

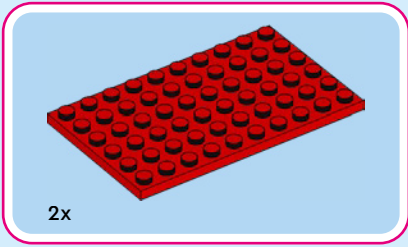

87

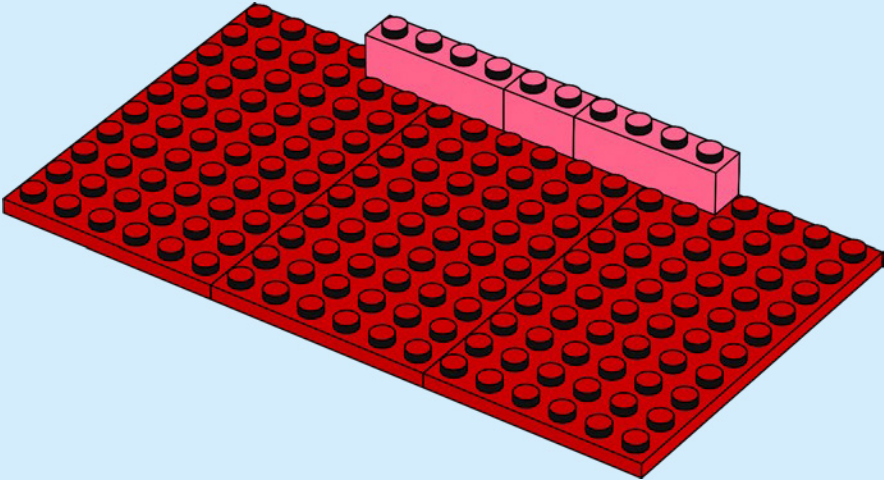



2x

88

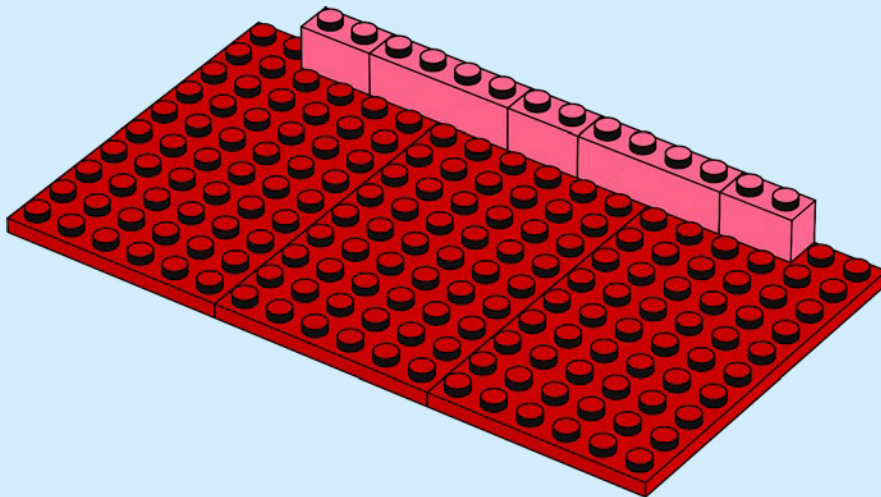

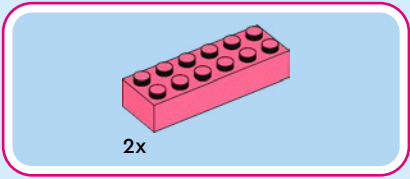

89

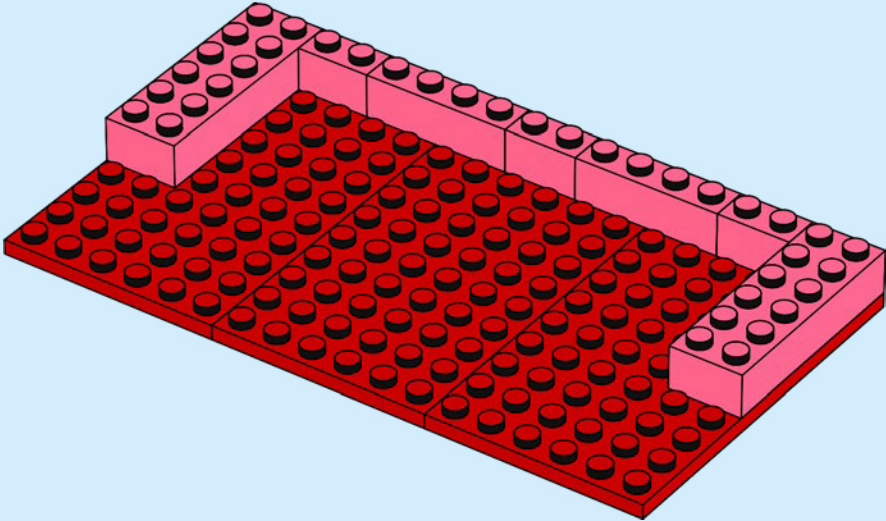

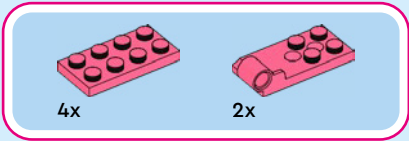

90

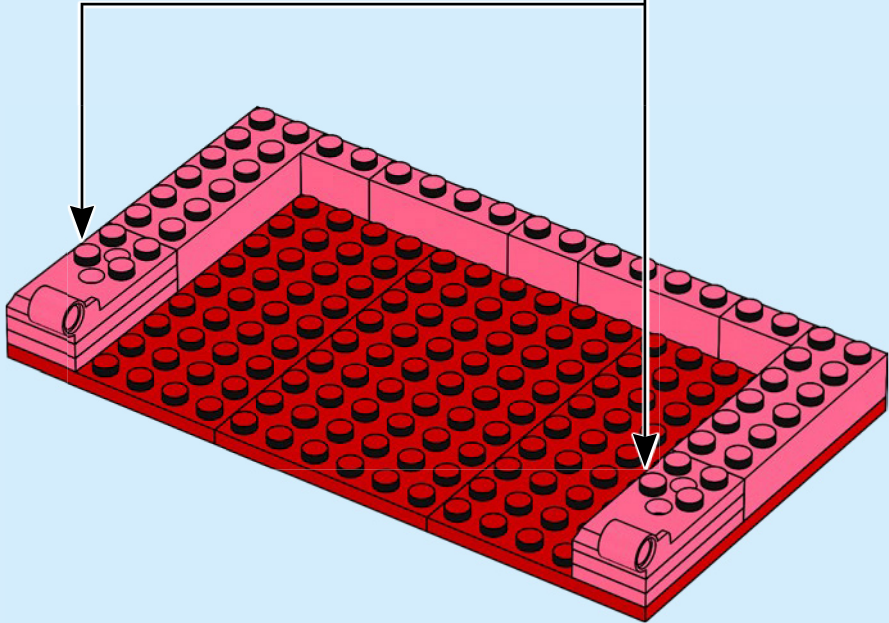
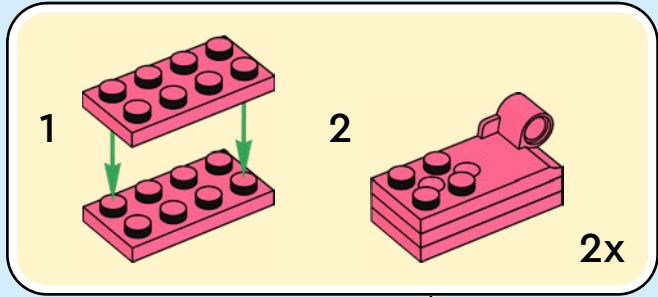

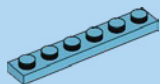

3x

91

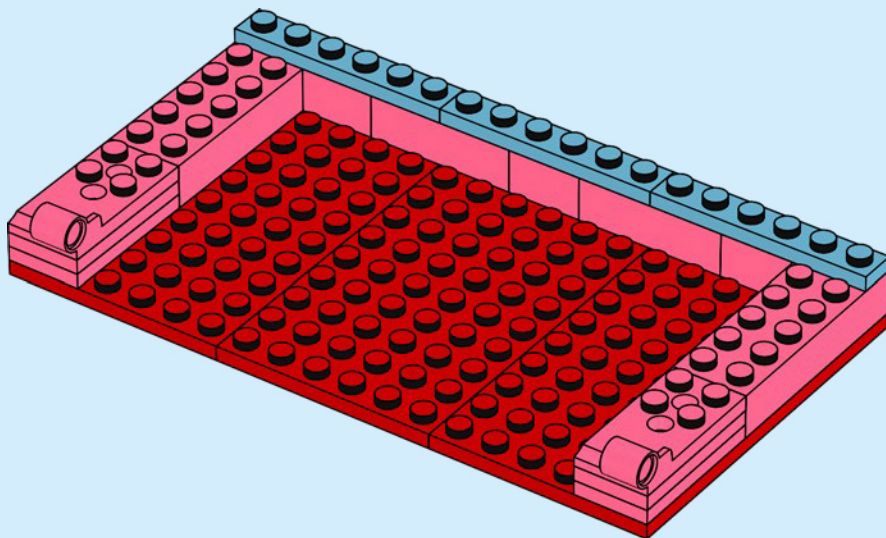

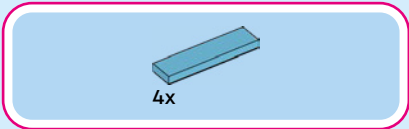

92

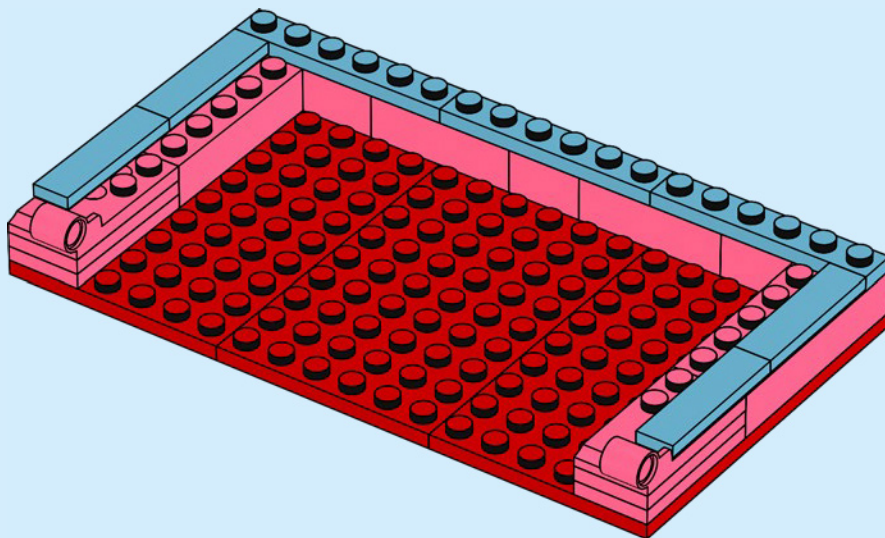

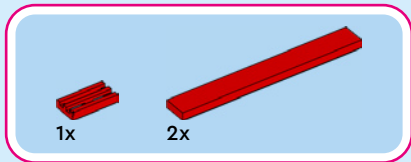

93

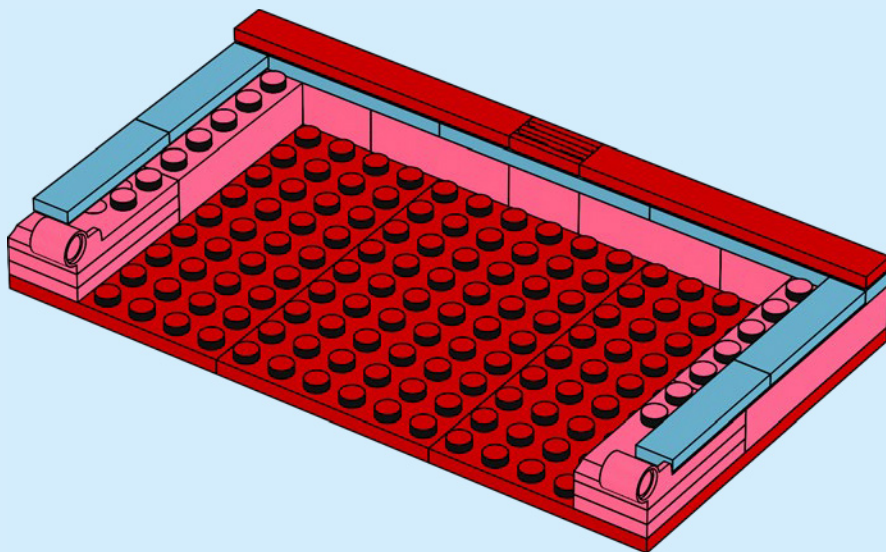

2x



4x



94

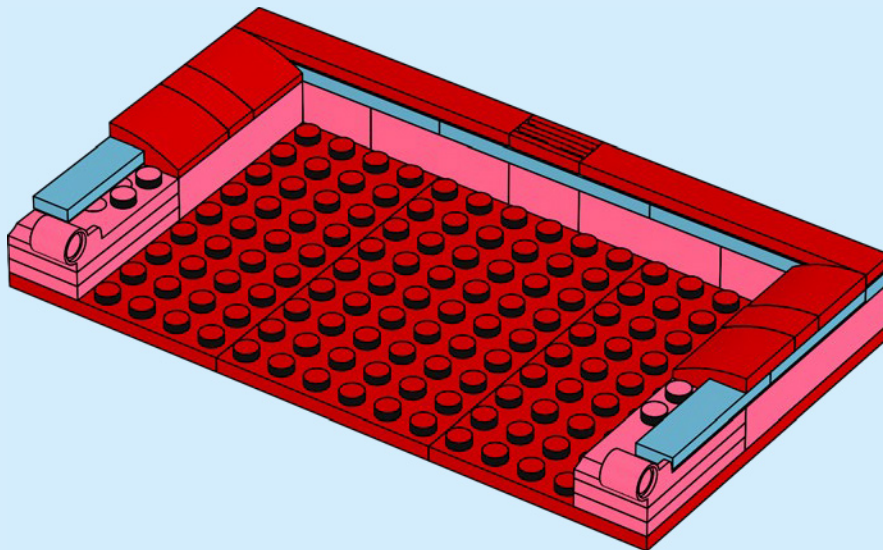



2x

95

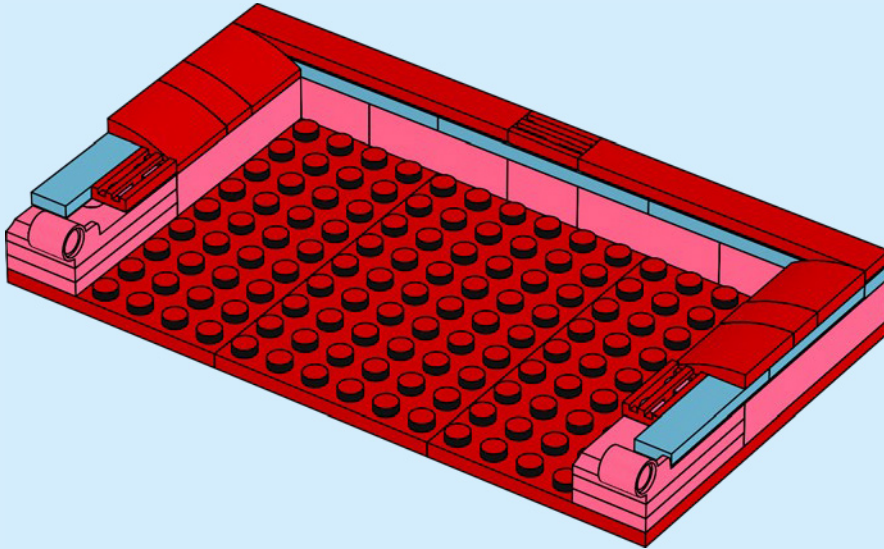

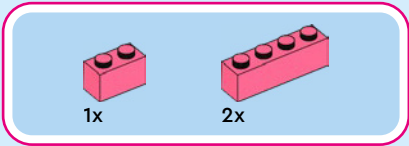

96

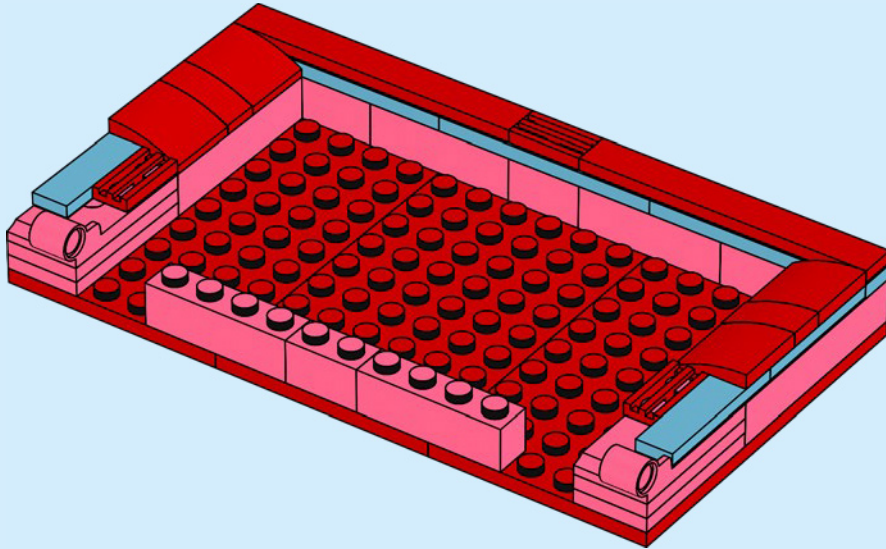



97

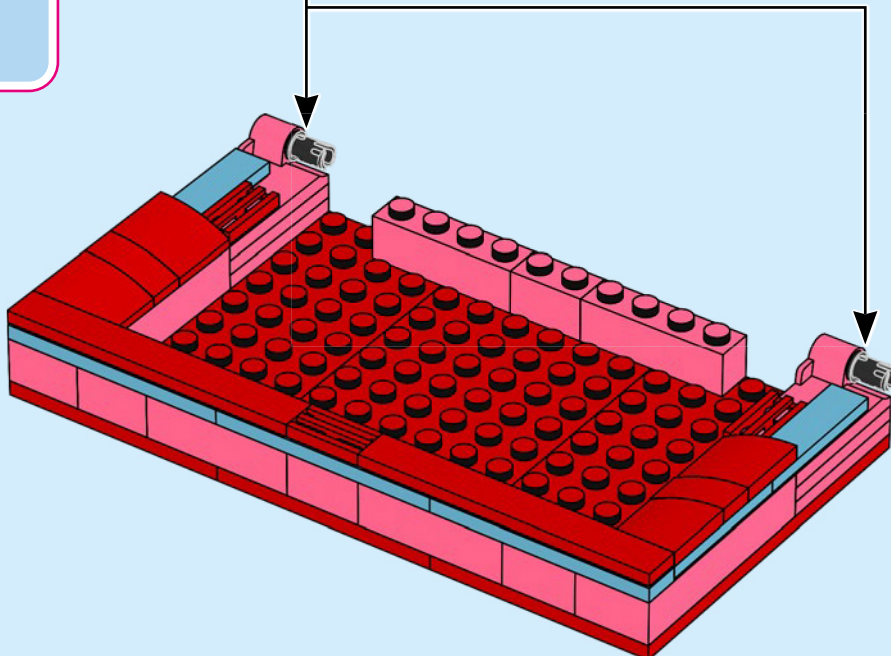

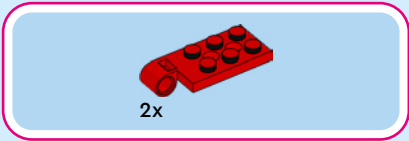

98

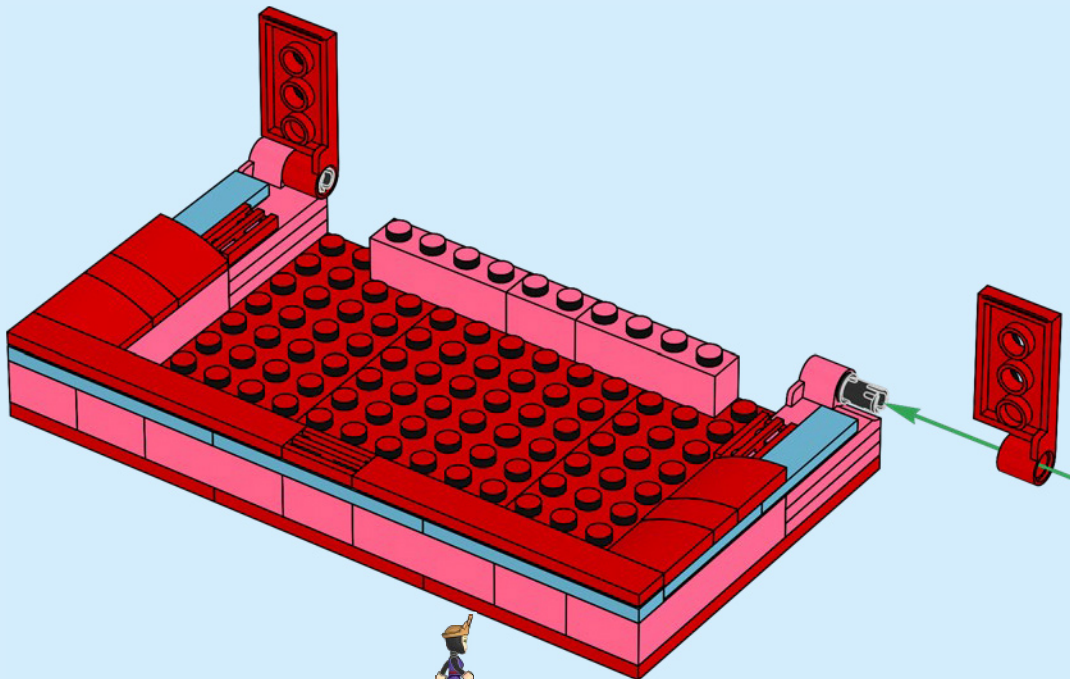

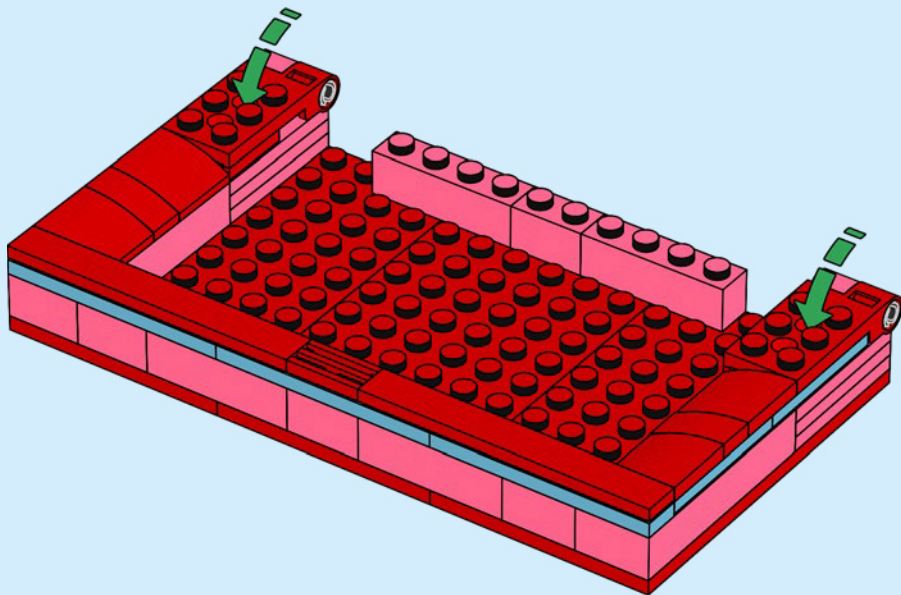



2x

100

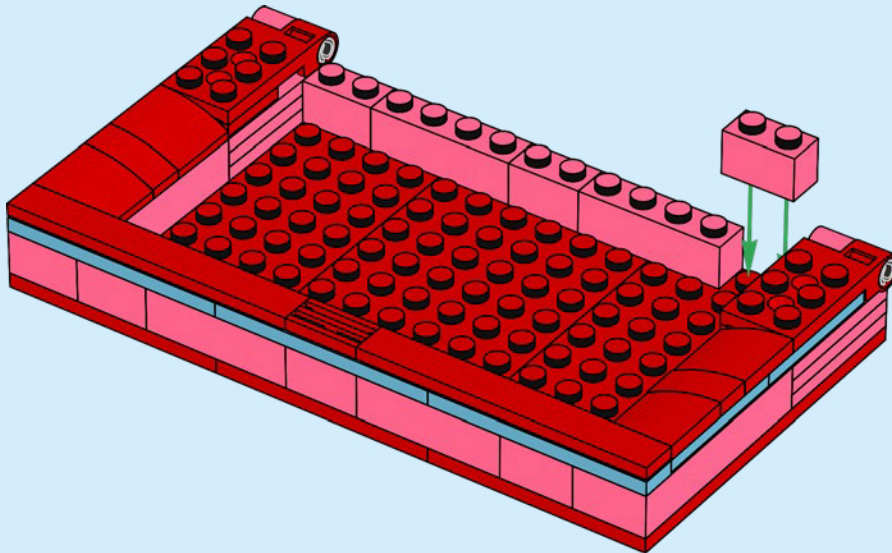

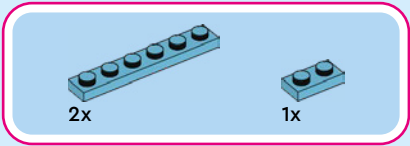

101

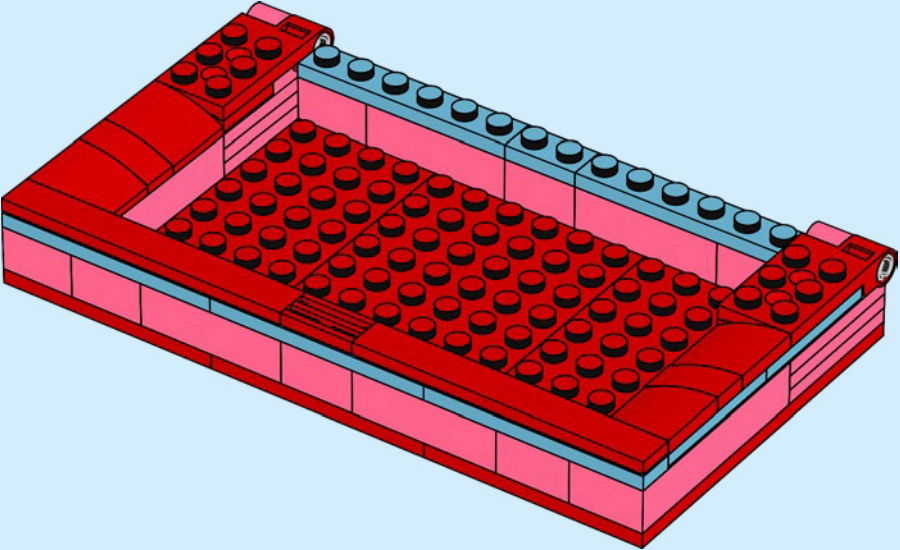

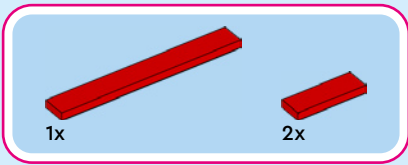

102

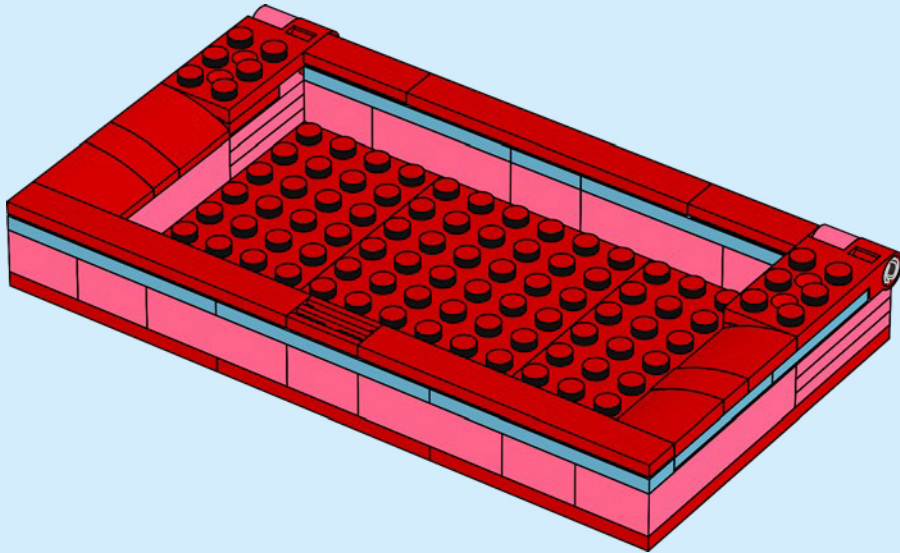

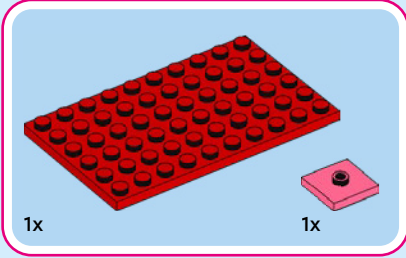
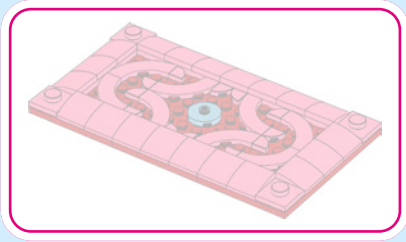

103

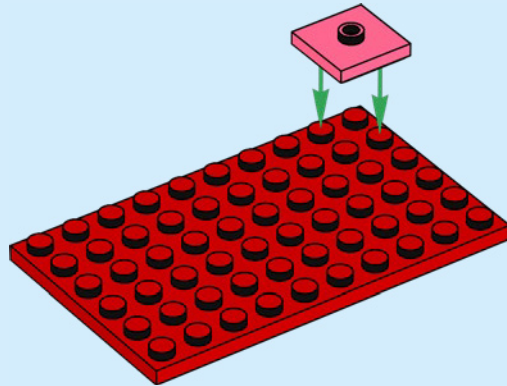

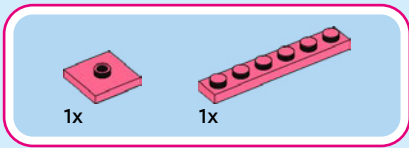

104

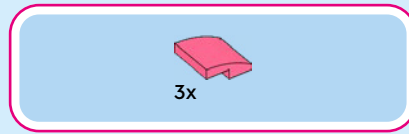
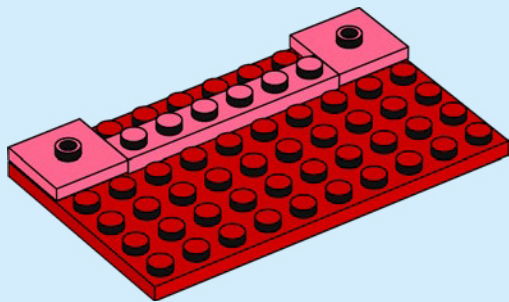

105

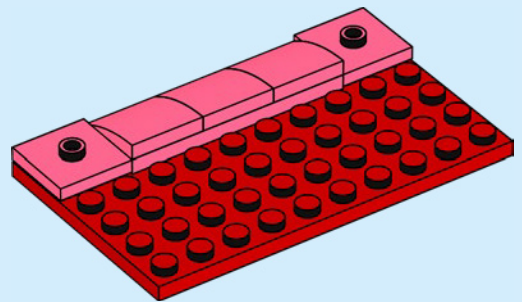

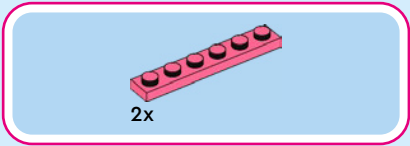

106

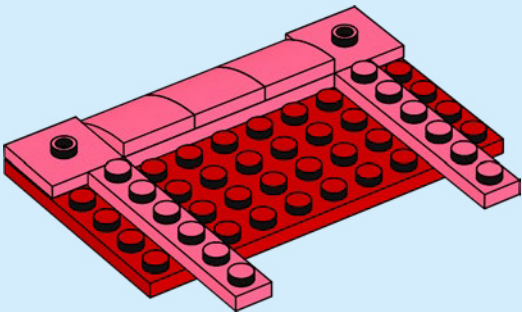

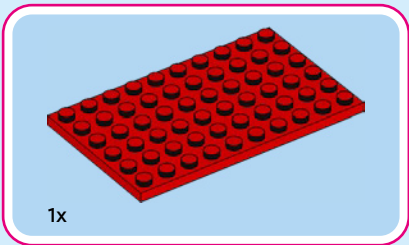

107

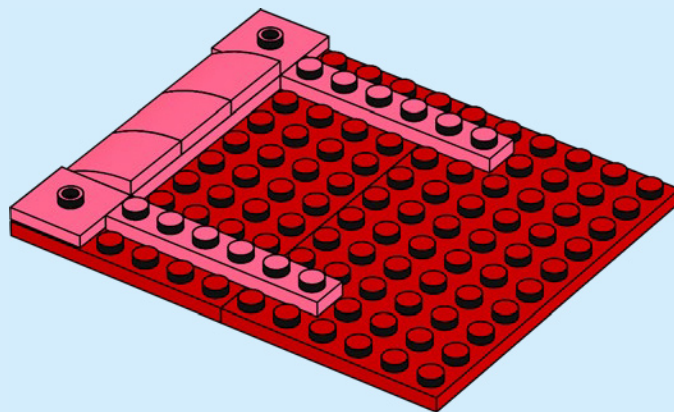

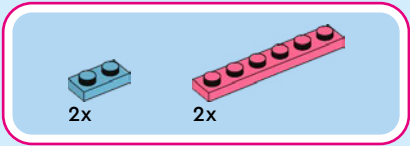

108

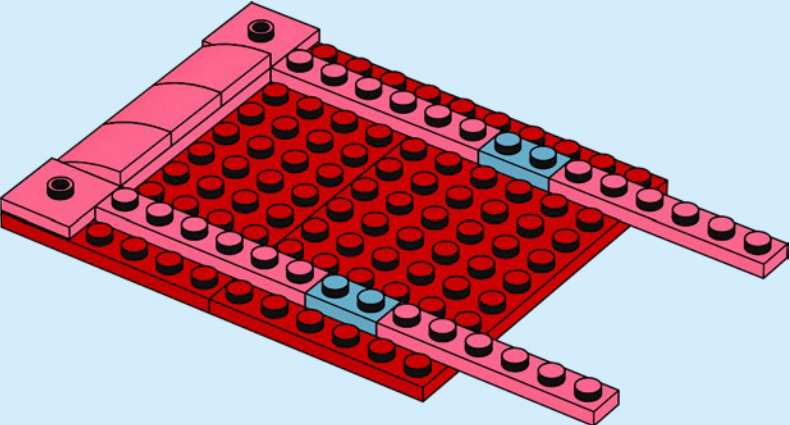

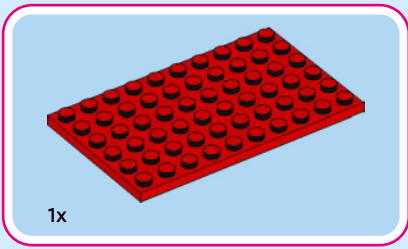

109

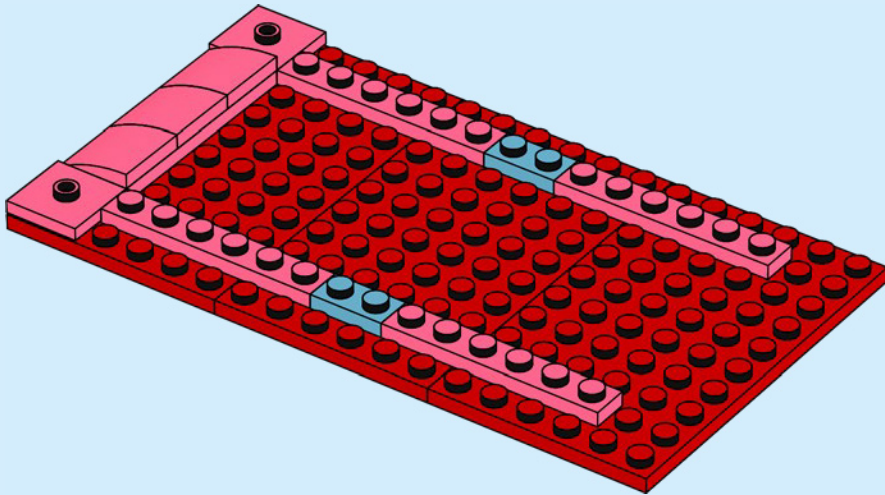

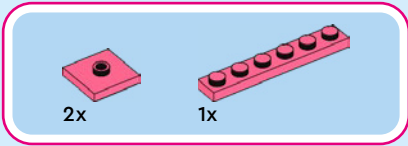

110

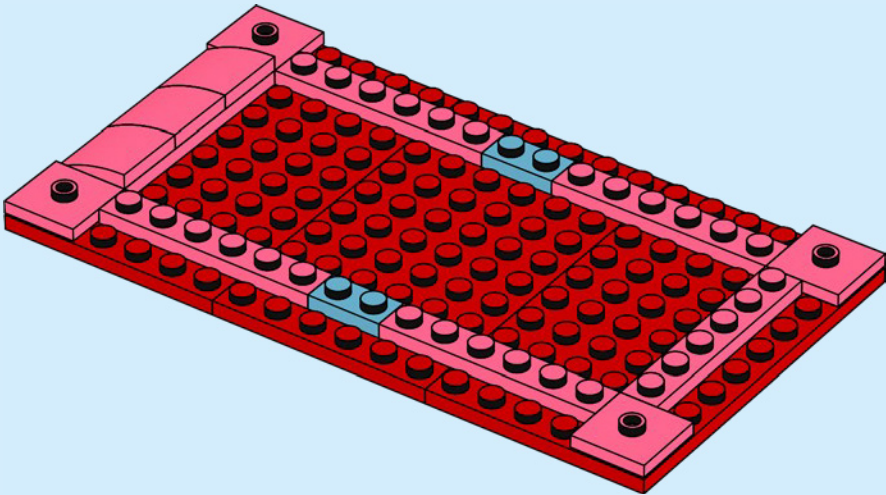



3x

111

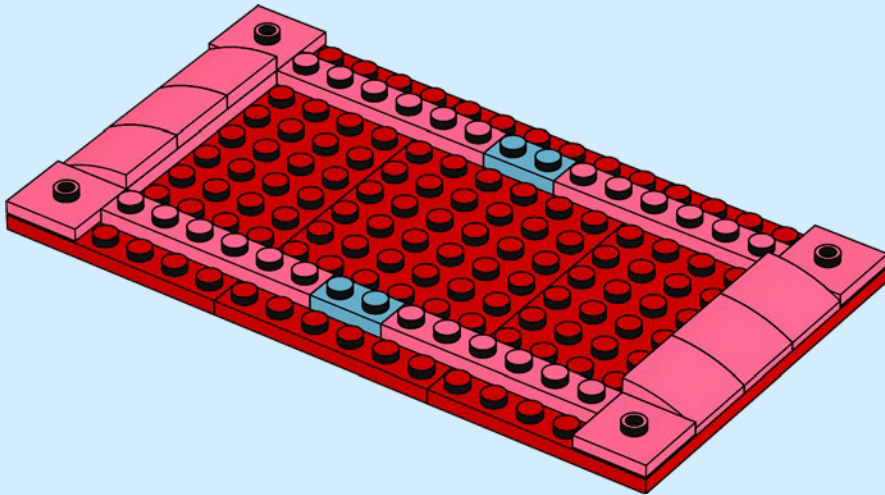



4x

112

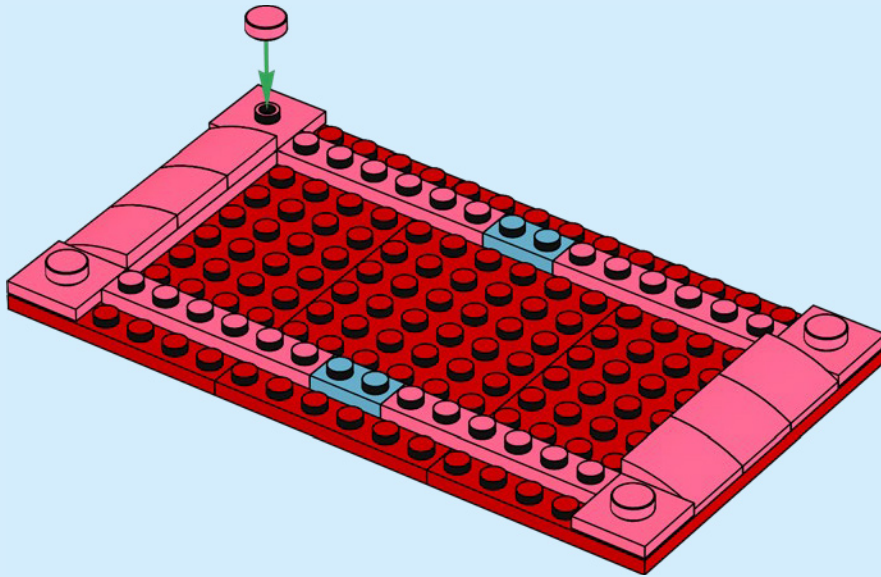



4x

113

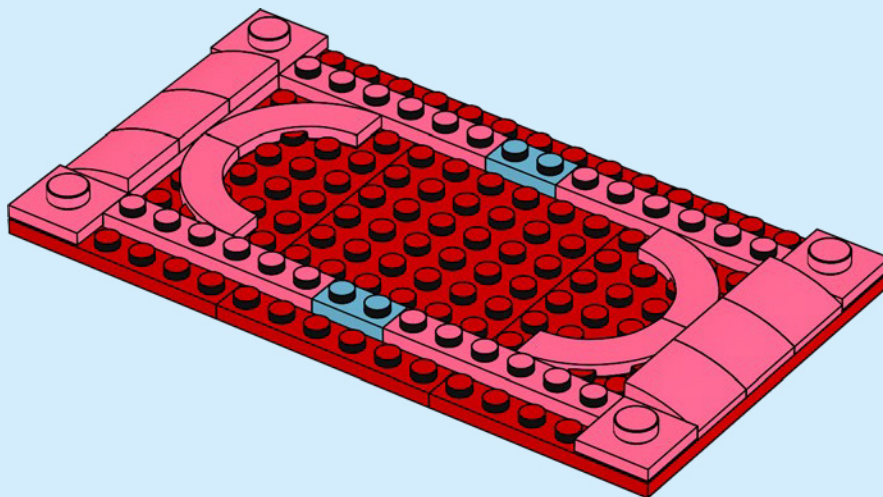



4x

114

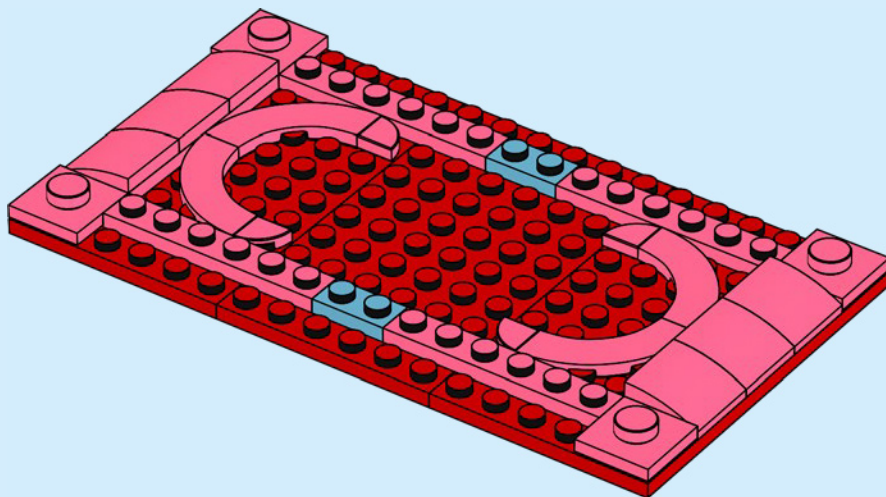



4x

115

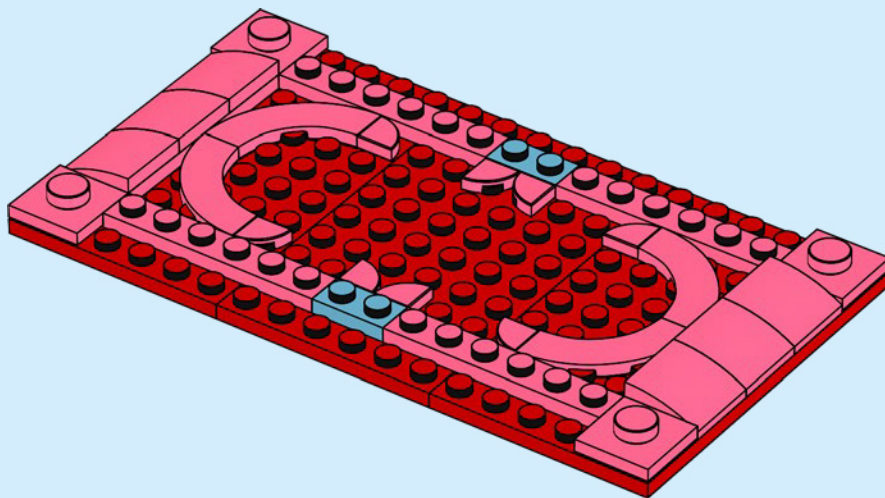



4x

116

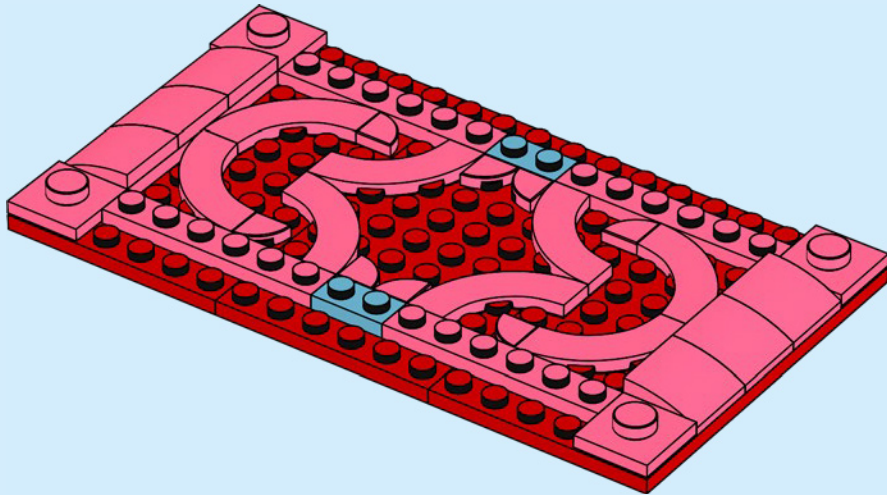



4x

117

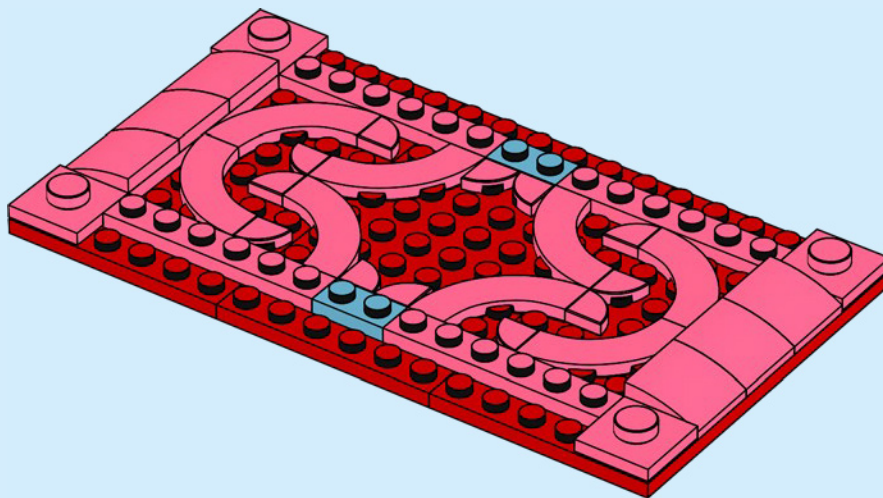



14x

118

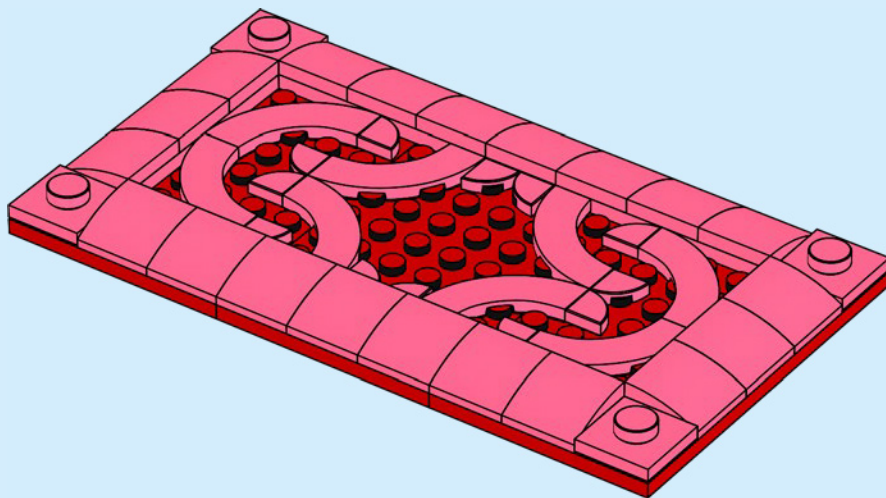



1x

119

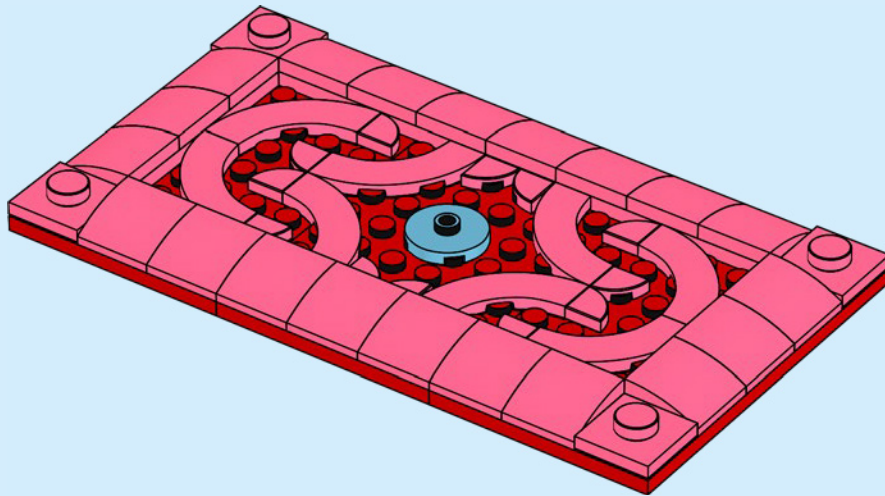

120

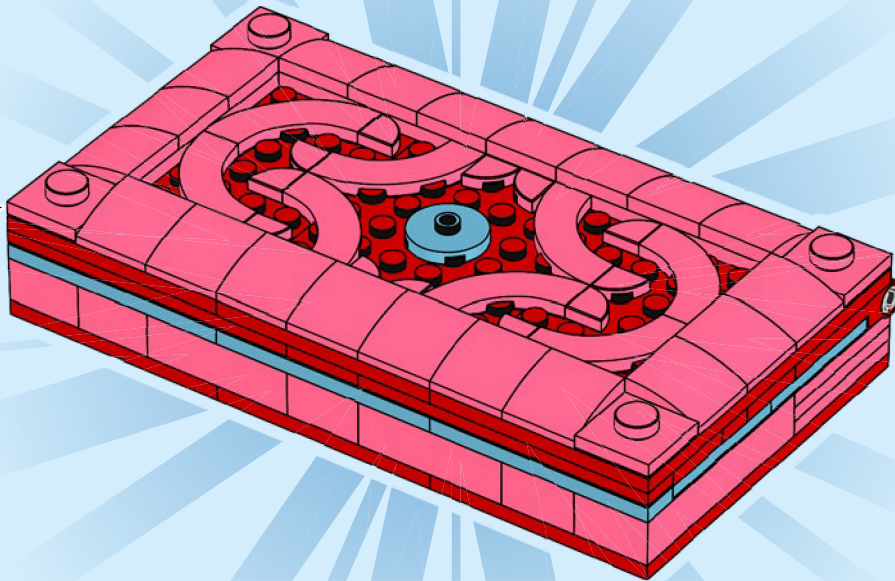

121

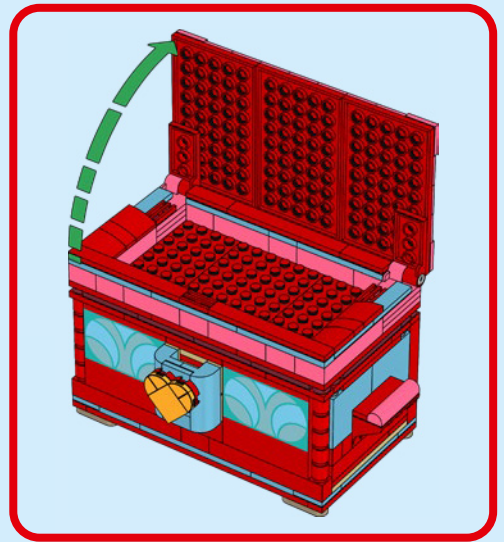
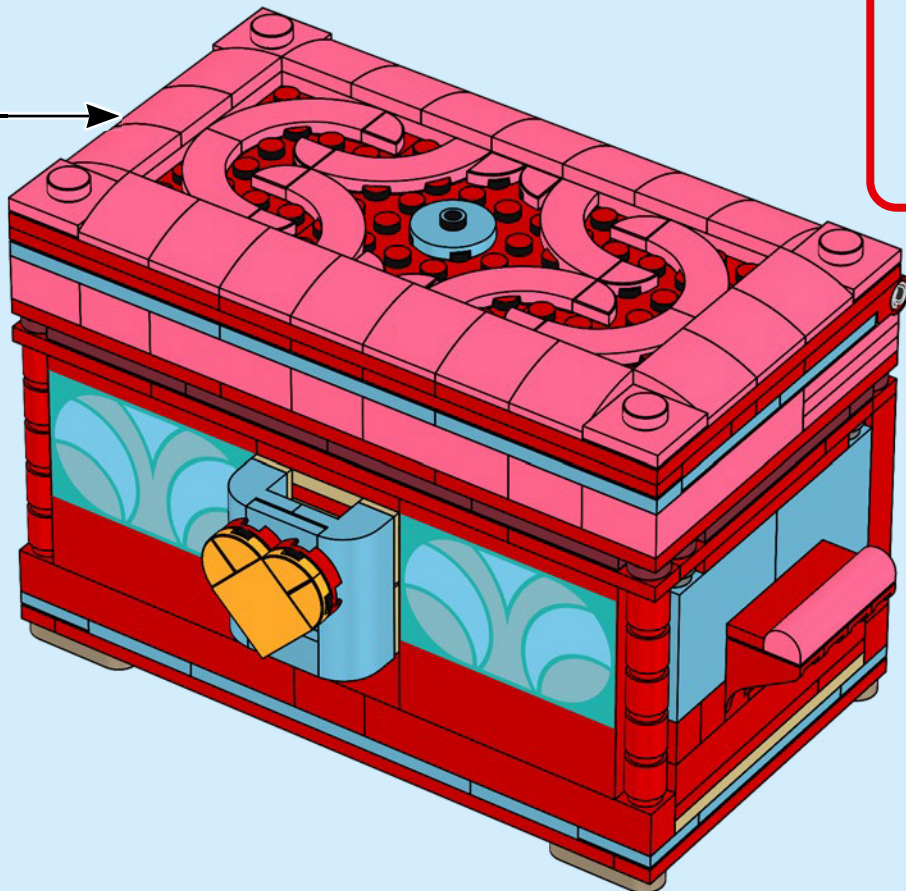

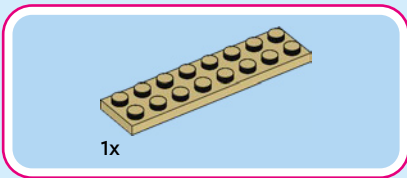
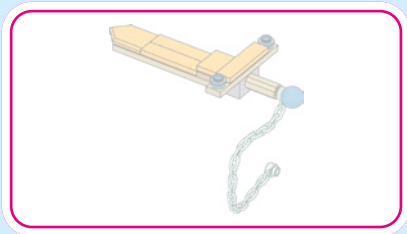

1x

122

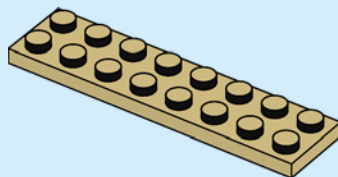



1x

123

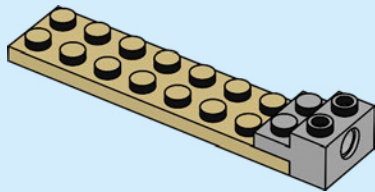

1x

124

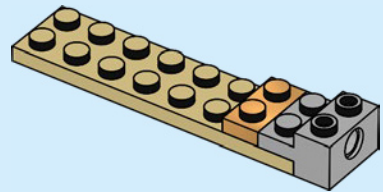

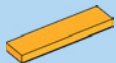

2x



1x

125

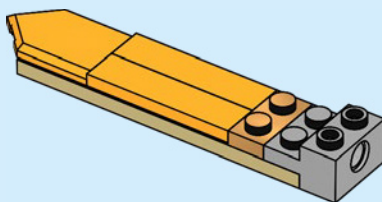

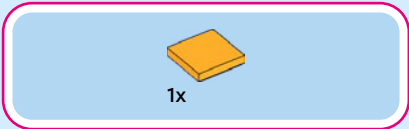

126

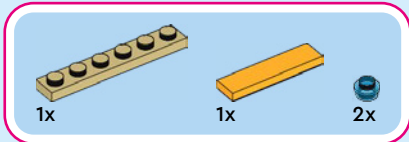
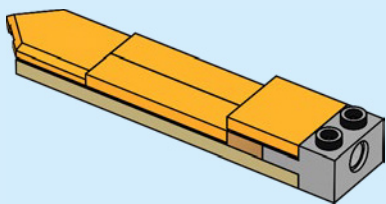

127

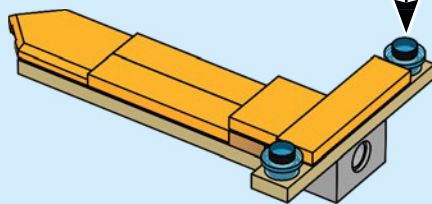
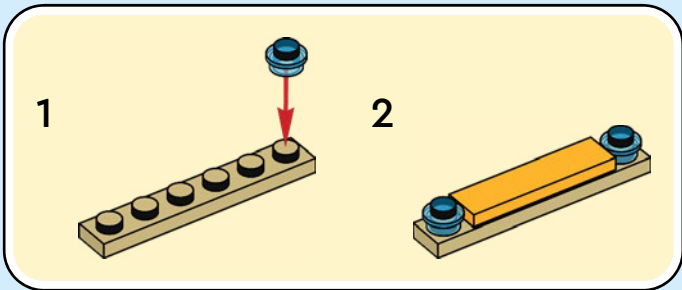



1x

128

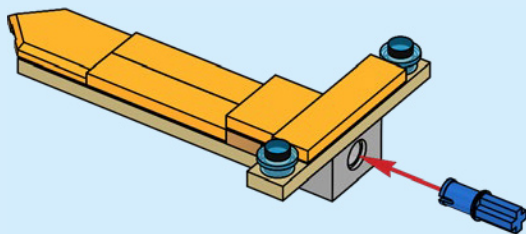



1x

129

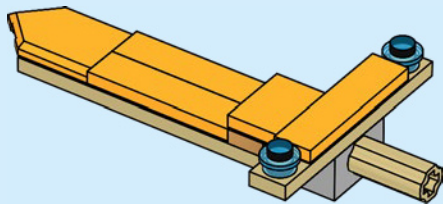

1x

130

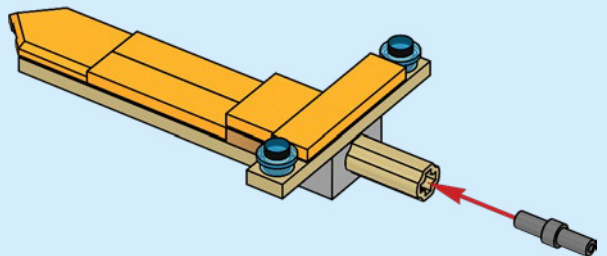

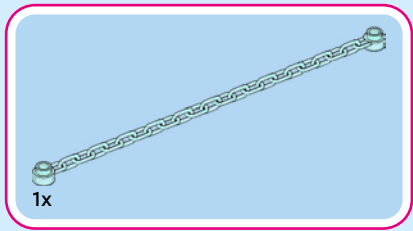

131

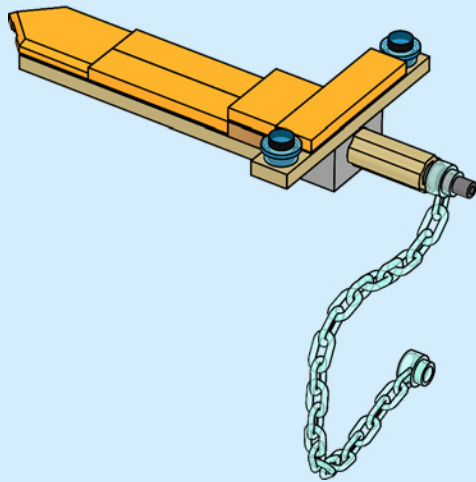



132

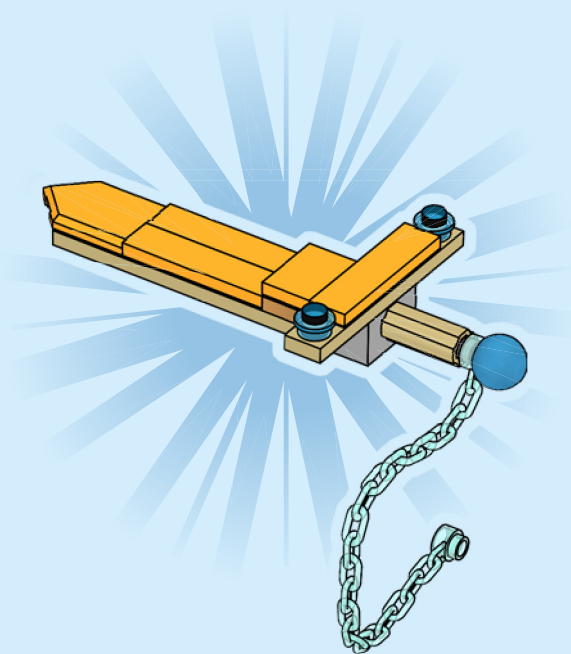

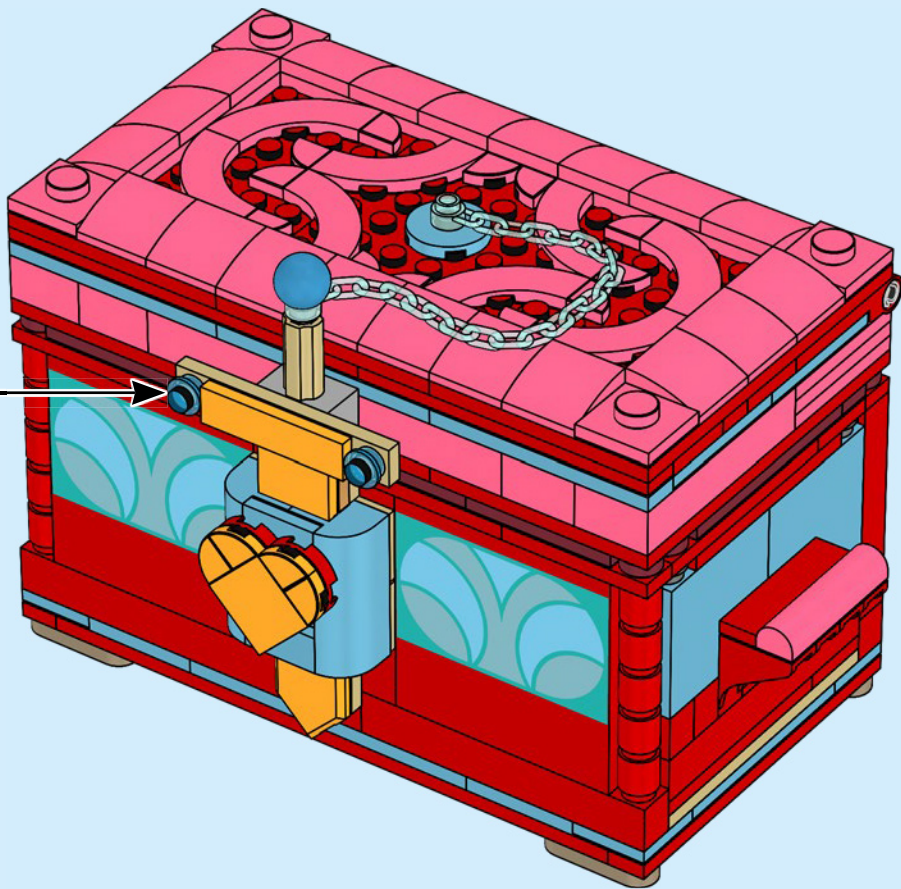





Disney





43245



43276



43243



1x
6234807



3x
300401

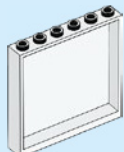

2x
4504228



4x
6374151



1x
6262188



1x
6148262



7x
4113917



1x
6313119



1x
6374166



1x
4185177



3x
4121921



1x
4113916



2x
4124067



4x
4157277



1x
4113988

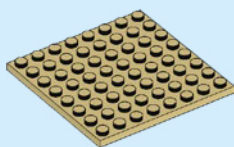

2x
4624223



10x
306221



3x
300521



1x
389921



1x
6054438



1x
6132541



2x
300421



2x
6249891



3x
241221



2x
6029946



4x
242021



1x
300321



4x
6105976



8x
6056816



4x
428621



4x
362221



2x
4533742



1x
6276193



1x
329821



2x
243121



6x
371021



1x
6049737



2x
6509005



8x
366621

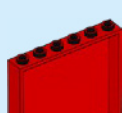

2x
6433222



2x
6508530

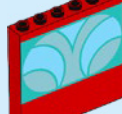

6x
300821

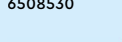

3x
416221



4x
447721



2x
4617857

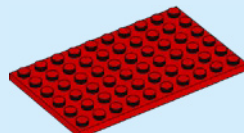

6x
6509008

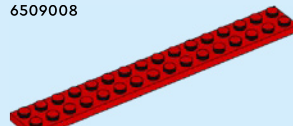

2x
428221



1x
6365807

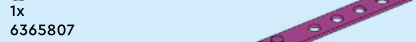

1x
6484840

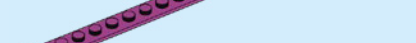

1x
6508392

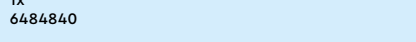

10x
6172383

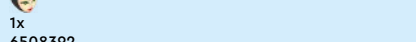

1x
6390775

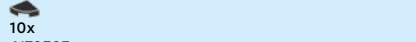

1x
452926

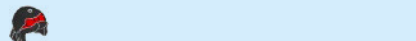

2x
6279875

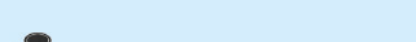

1x
6266207

4x
6441088

2x
6240214

1x
6247796

4x
6449564

1x
4206482

1x
6320045

2x
6092588

2x
6245268



2x
4535928

5x
6284585

2x
6173168

1x
4539105

8x
6257594

3x
4650865

2x
6357747

1x
6251306

4x
6214457

2x
6020147

1x
6340721

3x
6072668

1x
6102360

1x
4216668

2x
6401023

1x
6066097

1x
4657366

1x
6326478

1x
6267048

11x
6231765

1x
6350724

1x
4211088

1x
6302240

1x
6508380

1x
6508378

1x
6407812

1x
6509259

2x
4529247



1x
6218047

1x
6509133

1x
6343854

1x
6412745

4x
6322819

2x
6149781

1x
6224282

1x
6136419

7x
6097419



2x
4649741



4x
6060857

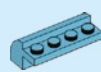

4x
6119107

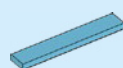

4x
6509004



4x
4624705

2x
6345200

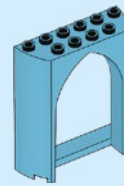
2x
6185309

5x
4625036

1x
6393924

2x
6074793



4x
6311436



12x
6250022



6x
6258572



20x
6371787

4x
6287638

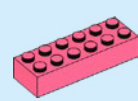
2x
6422238

6x
6422379



2x
6422922

4x
6422918



8x
6509011

2x
6509007

4x
6305455

2x
6249422

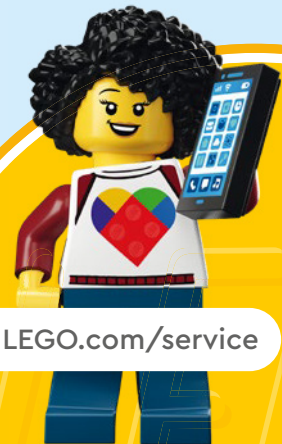
 LEGO.com/service



YOU COULD **WIN**



Scan this QR code or go to
LEGO.COM/PRODUCTFEEDBACK and give us
your short feedback about this LEGO® set for a
chance to win a cool LEGO prize.

Terms and Conditions apply*

EN: YOU COULD WIN. Terms and Conditions apply* **DE: Du könntest GEWINNEN.** Es gelten die Teilnahmebedingungen* **FR: Tu pourrais GAGNER.** Des conditions s'appliquent* **IT: Potresti VINCERE tu.** Termini e condizioni sono applicabili* **ES: Puedes GANAR.** Aplican términos y condiciones* **PT: Poderá GANHAR.** Aplicam-se termos e condições* **ZH: 轻松获奖. 条款和条件适用*** **PL: Szansa na WYGRANĄ.** Obowiązują warunki korzystania* **CS: Máte šanci VYHRÁT.** Platí všeobecné smluvní podmínky* **SK: Máte šancu VYHRAŤ.** Platia všeobecné zmluvné podmienky* **HU: TE IS NYERHETSZ.** Felhasználási feltételek érvényesek* **RO: Ai putea CÂȘTIGA.** Se aplică termeni și condiții* **BG: Можете да СПЕЧЕЛИТЕ.** Има определени правила и условия* **LV: Tu vari LAIMĒT.** Ir spēkā noteikumi un nosacījumi.* **ET: Sul on võimalus VÕITA.** Kehtivad tingimused* **LT: Jūs galite LAIMĖTI.** Taikomos sąlygos*

*[LEGO.com/productfeedback-terms](https://www.lego.com/productfeedback-terms)