



Harry Potter



76434



Q LEGO® Builder



Get excited about our new packaging!

We're switching from plastic to paper-based packaging. That's why you might find a mix of paper and plastic in our boxes!

Nos nouveaux emballages vous emballeront !

Nous passons des emballages en plastique aux emballages à base de papier. C'est pourquoi vous pourriez trouver un mélange de papier et de plastique dans nos boîtes !

¡Te presentamos nuestros nuevos empaques!

Estamos sustituyendo las bolsas de plástico por bolsas con base de papel. ¡Por eso, puedes encontrar una mezcla de papel y de plástico en nuestras cajas!

[LEGO.com/sustainable-packaging](https://www.lego.com/sustainable-packaging)

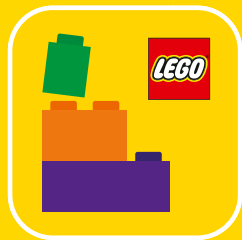

Q LEGO® Builder

BUILDER



Apple and the Apple logo are trademarks of Apple Inc., registered in the U.S. and other countries and regions. App Store is a service mark of Apple Inc. Google Play and the Google Play logo are trademarks of Google LLC. Tencent and the Tencent logo are trademarks of Tencent Inc.

Q [LEGO.com/devicecheck](https://www.lego.com/devicecheck)

EN Ask parents' permission before going online | **DE** Eltern um Erlaubnis bitten, bevor du online gehst | **FR** Demande l'autorisation d'un parent avant d'aller en ligne | **IT** Chiedi il permesso ai tuoi genitori prima di andare online | **ES** Pídeles permiso a tus papás antes de conectarte a Internet | **PT** Pede autorização aos pais antes de acederes online | **ZH** 上网前应先征得父母的同意 | **PL** Poproś rodziców o zgodę, zanim wejdziesz do Internetu | **CS** Než půjdeš na internet, požádej rodiče o svolení | **SK** Skôr než pôjdeš na internet, vypýtaj si povolenie od rodičov | **HU** Kérj szülői engedélyt, mielőtt online csatlakoznál! | **RO** Cere permisiunea părinților înainte de a te conecta online | **BG** Поискайте разрешение от родител, преди да влезете онлайн | **LV** Pirms došanās tiešsaistē palūdz atļauju vecākiem | **ET** Enne Interneti kasutamist küsi vanematelt luba | **LT** Prieš prisijungdami prie interneto, atsiklauskite tėvų

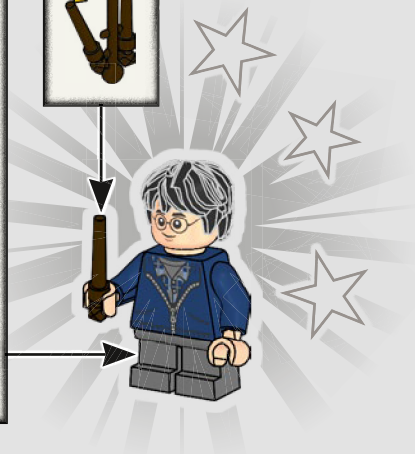
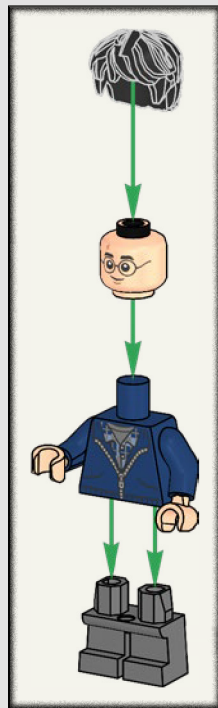

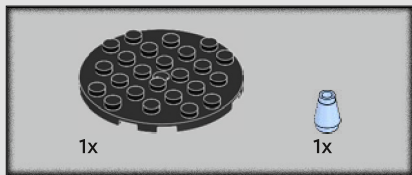

1

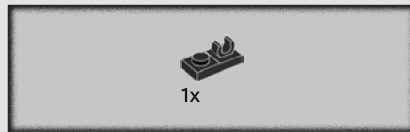
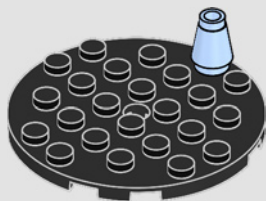

2

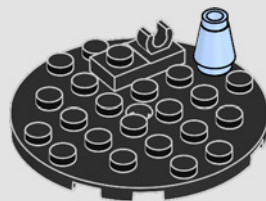

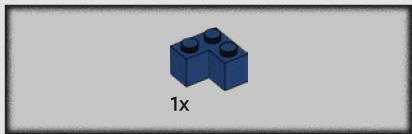

3

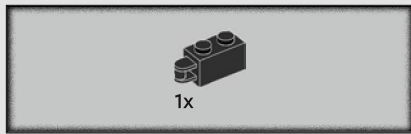
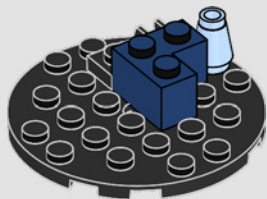

4

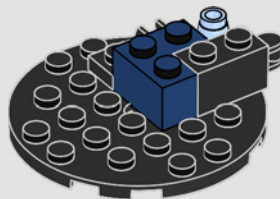

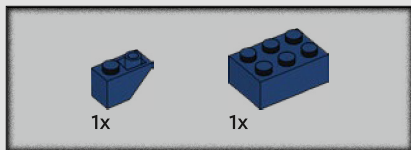

5

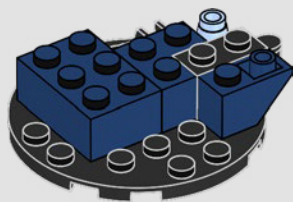

6

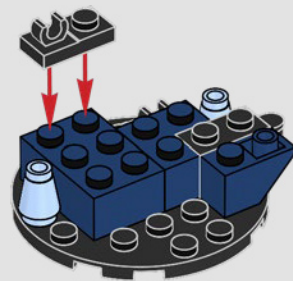



7

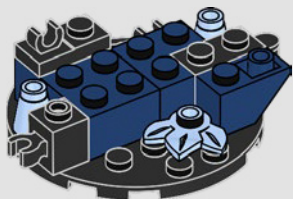

8

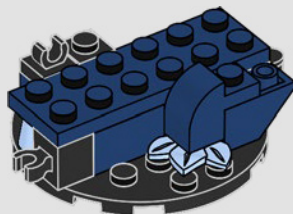

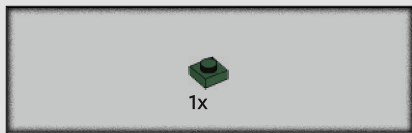

9

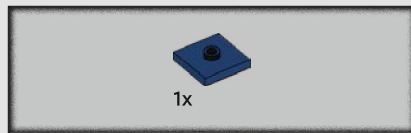
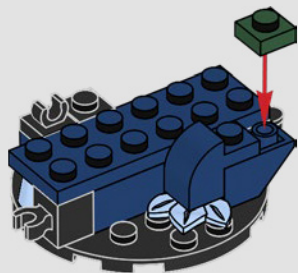

10

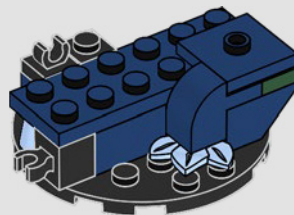



2x



2x

11

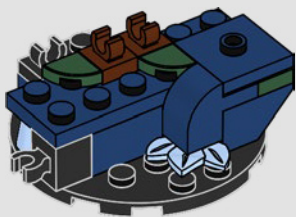

1x



1x

12





13

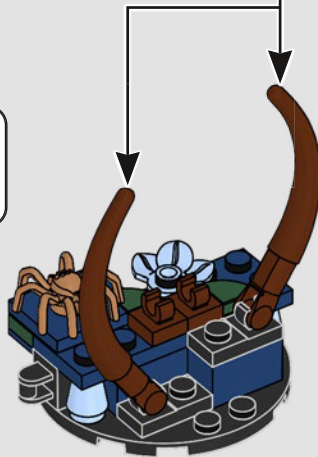
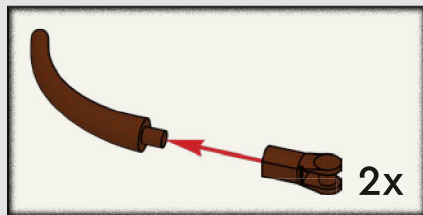



14

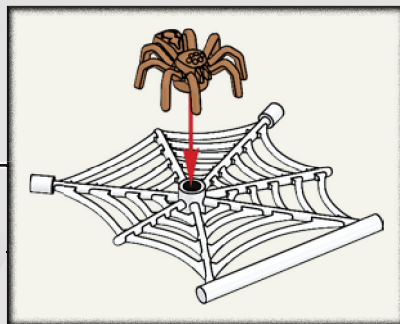

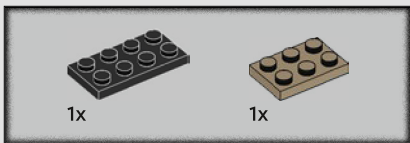

1

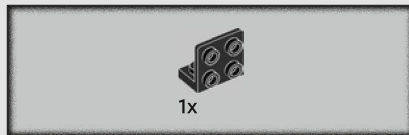
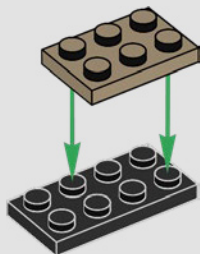

2

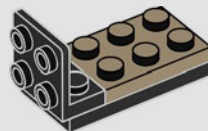

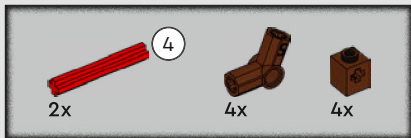

3

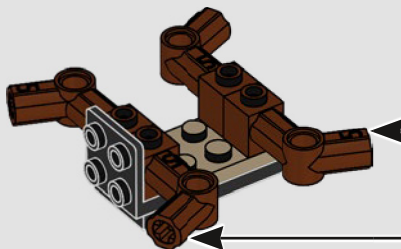
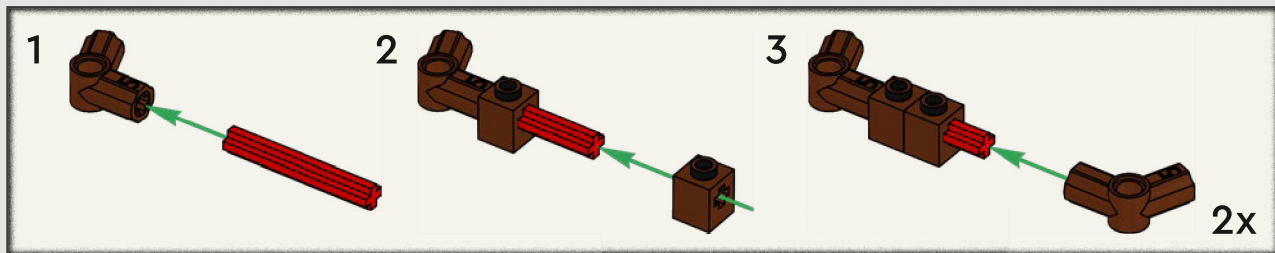



4

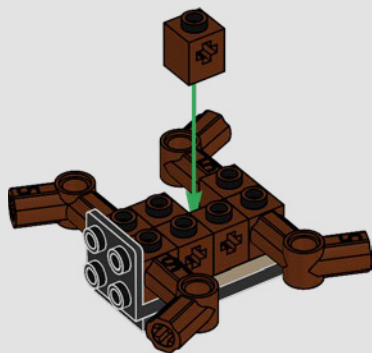

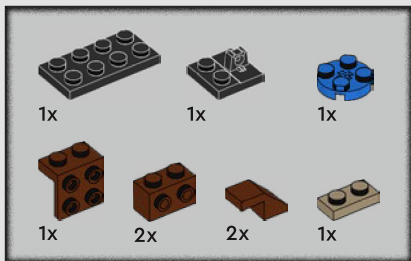

5

1

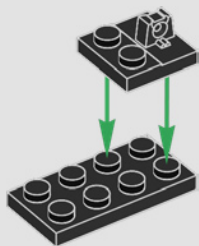

2

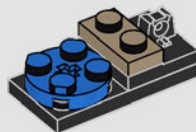

3

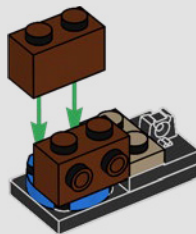

4

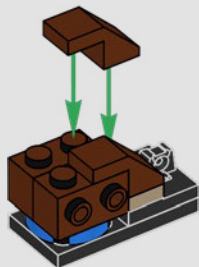

5

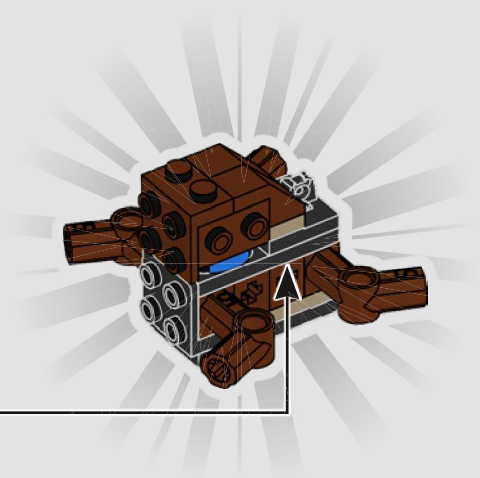
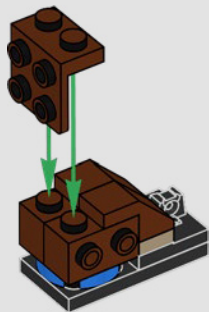



6

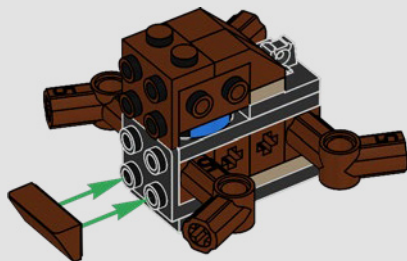



7

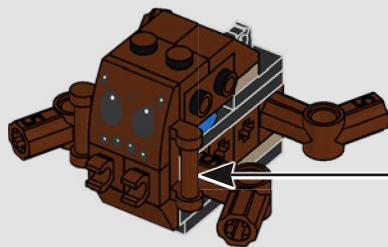
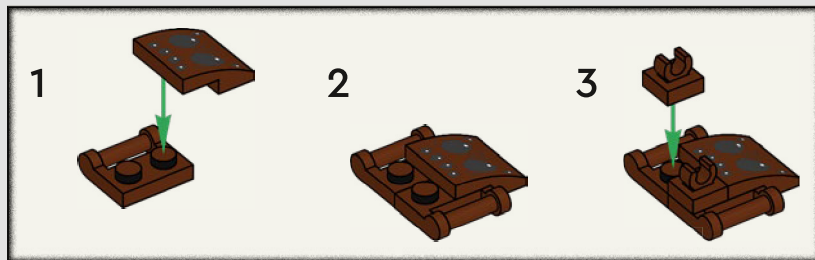



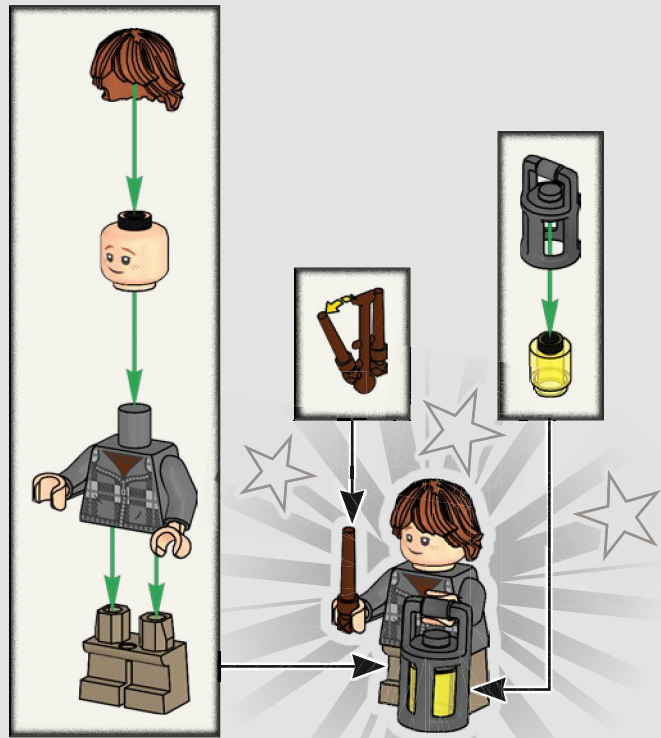

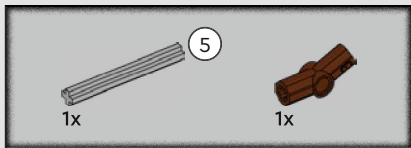

8

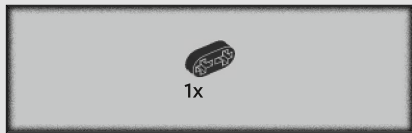
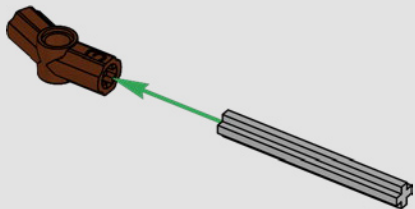

9

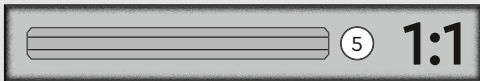
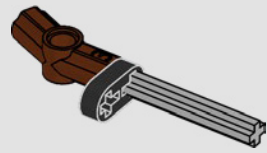

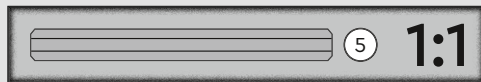
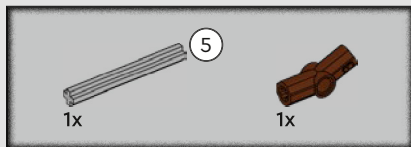

10

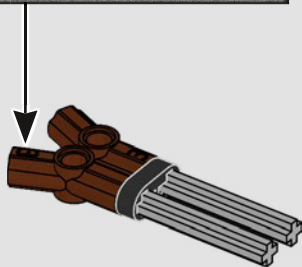
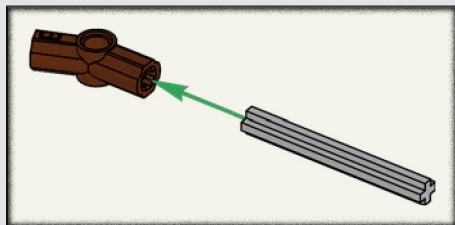

11

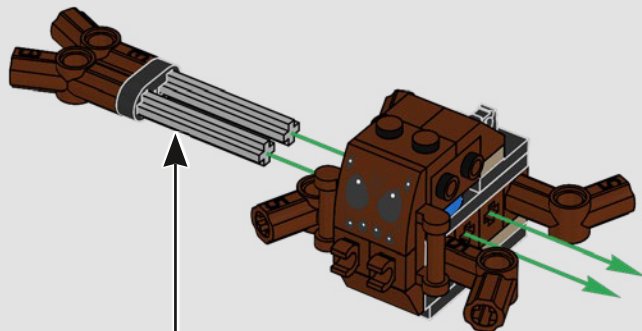

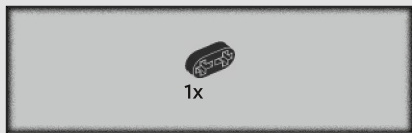

12

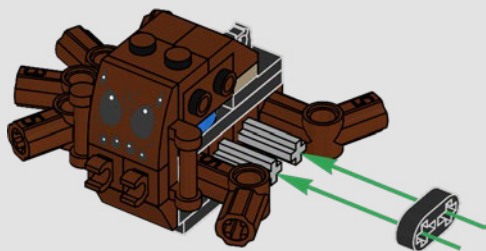

13

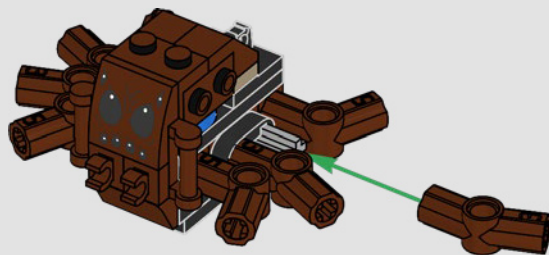

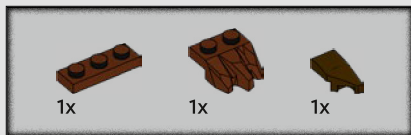

14

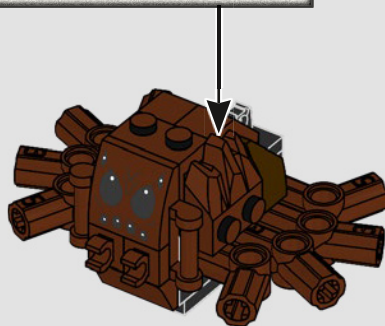
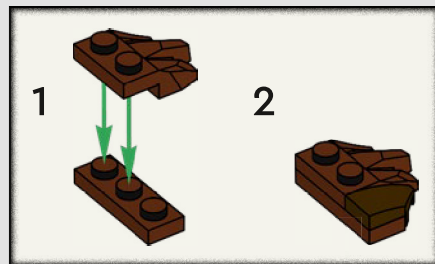

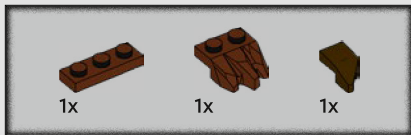

15

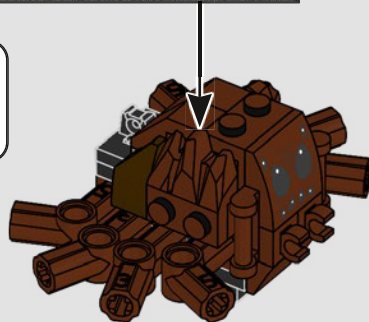
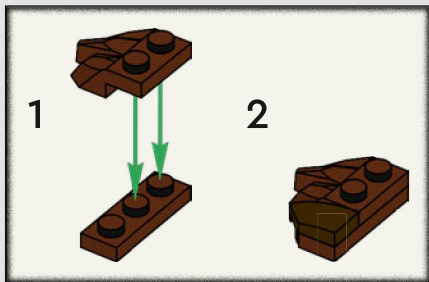

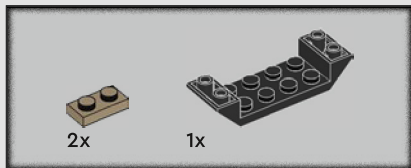

16

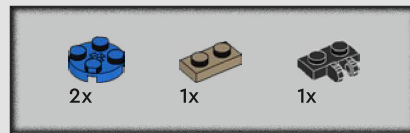
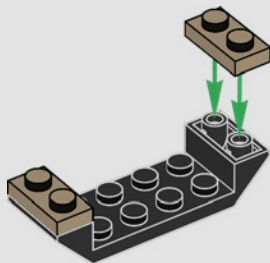

17

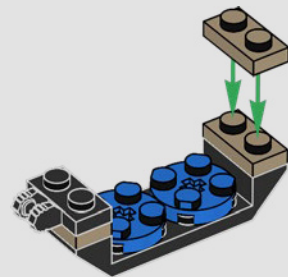

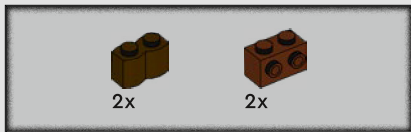

18

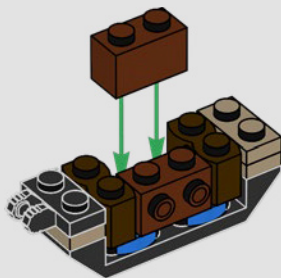

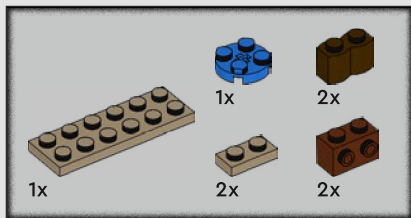

19

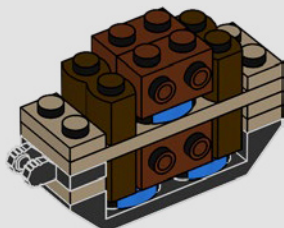
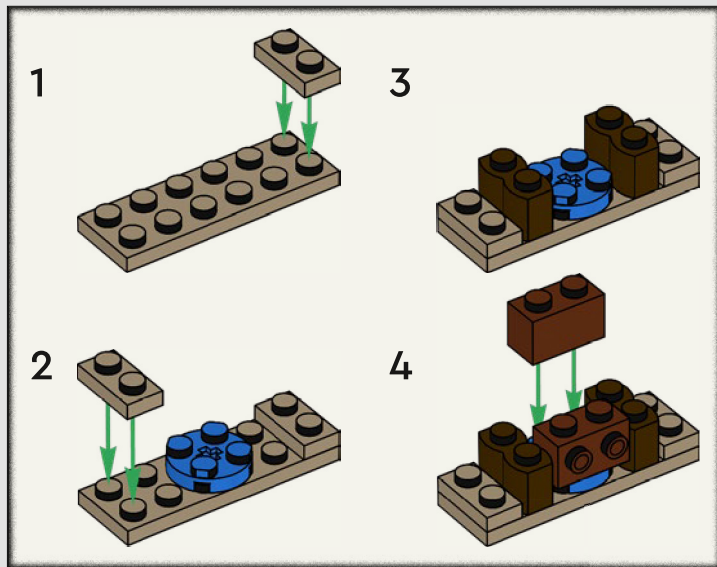

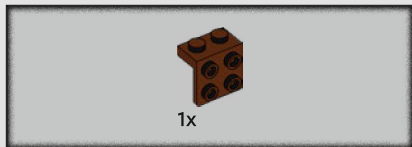

20

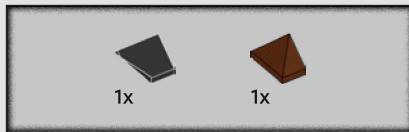
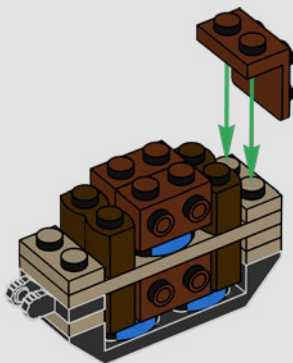

21

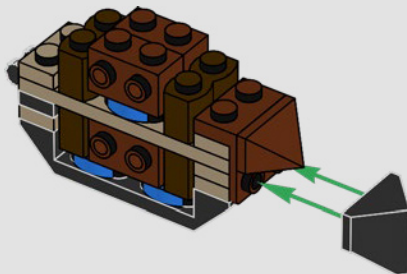

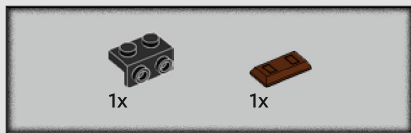

22

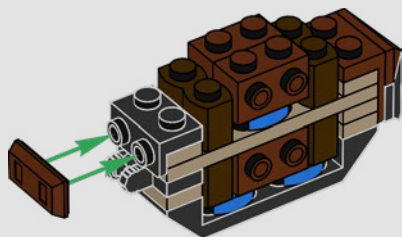

23

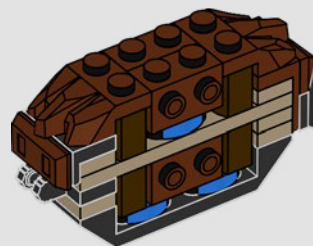

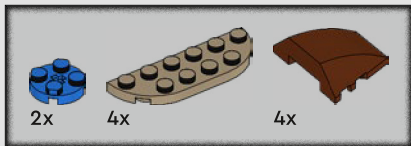

24

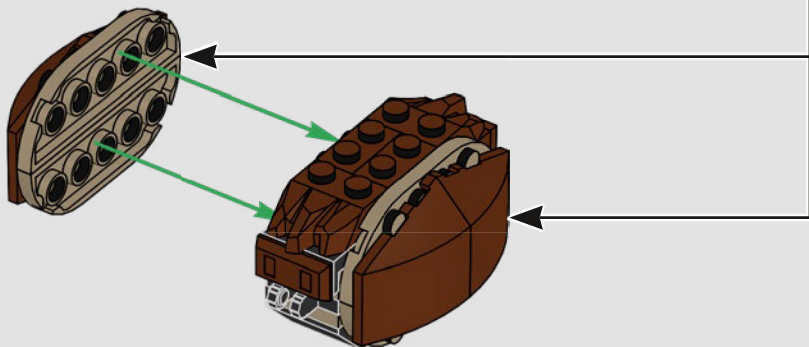
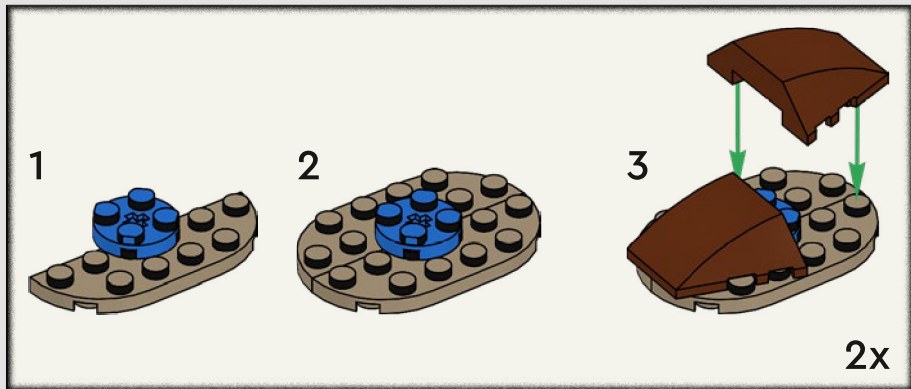

25

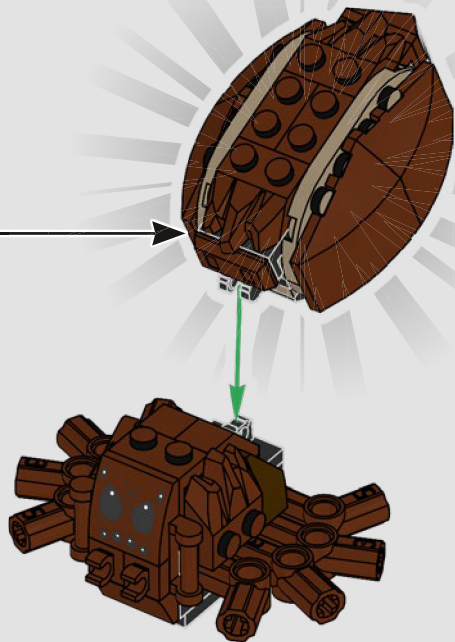



2x



2x

26

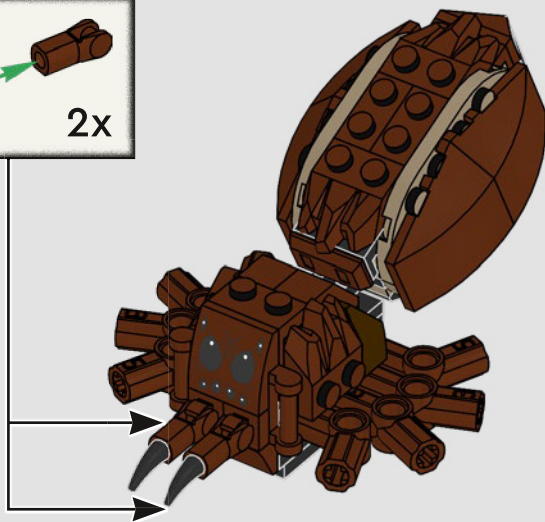
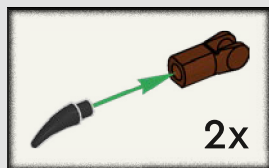



27

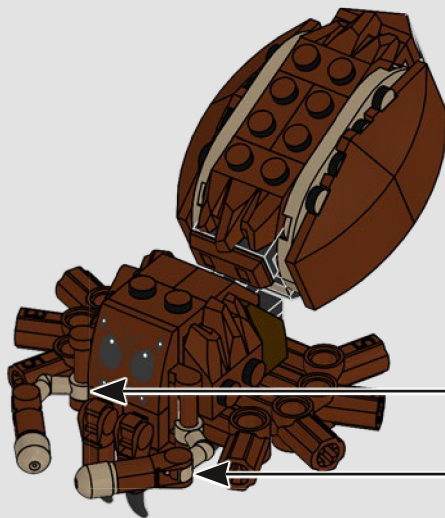
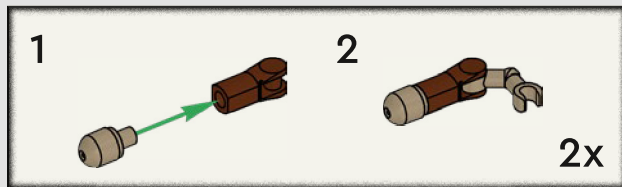

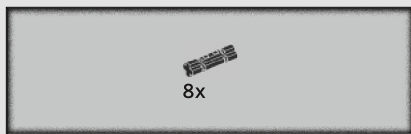

28

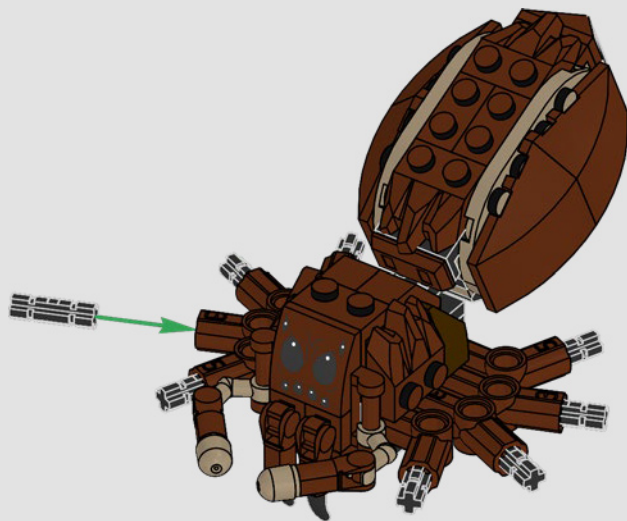



29

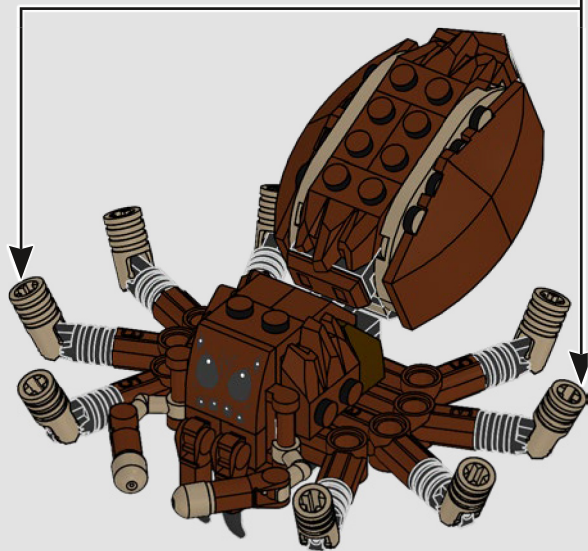
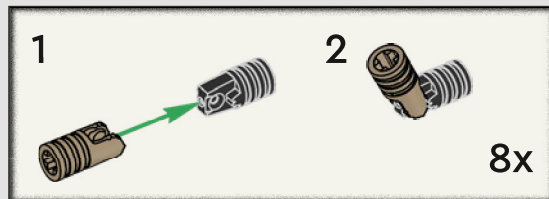

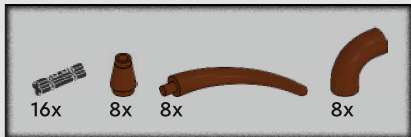

30

1

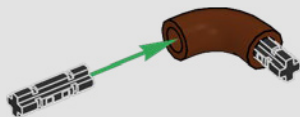

2

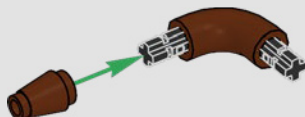

3

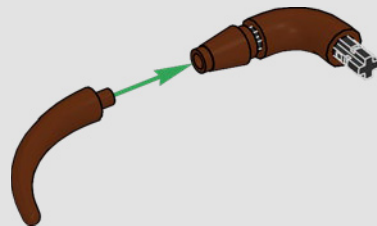

8x

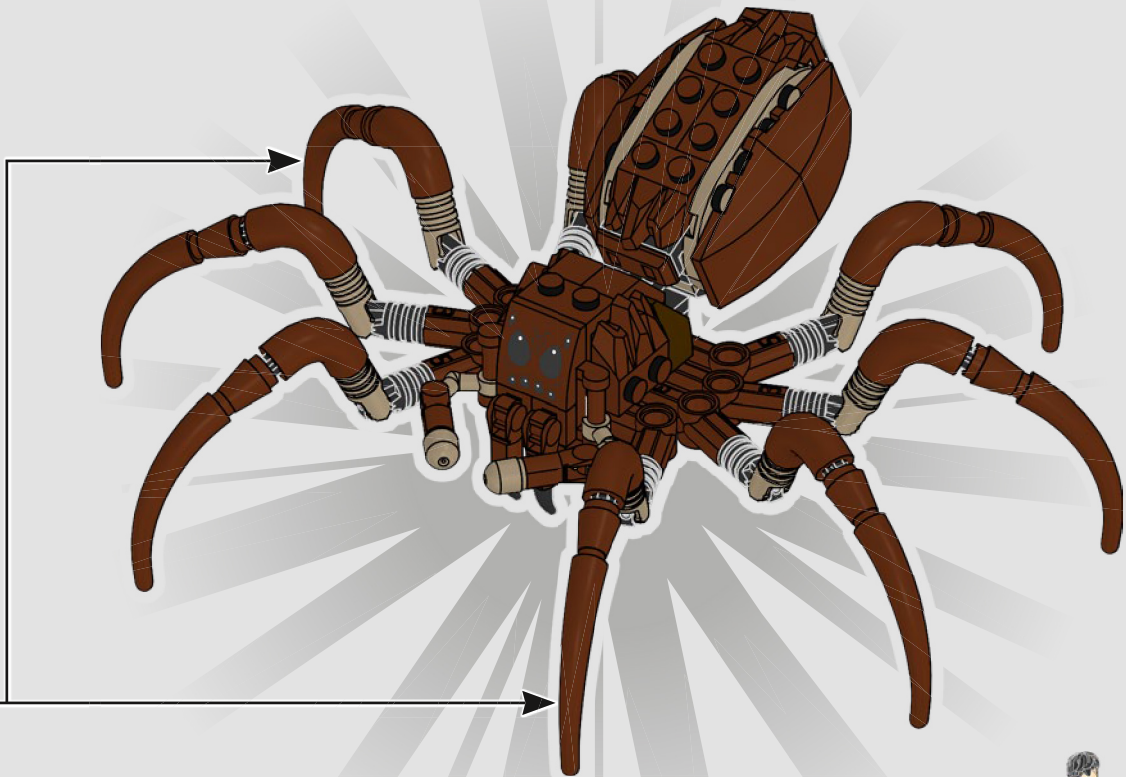

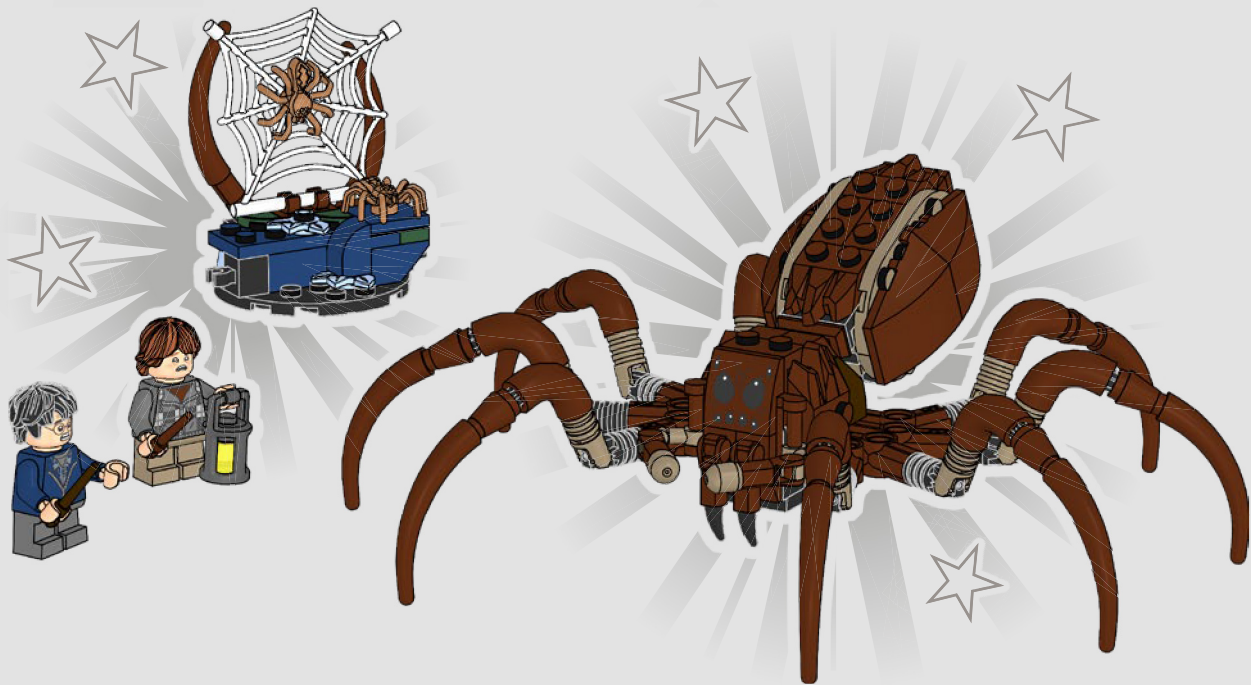



1x
6006221



2x
6129995



6x
403223



2x
6270103



1x
6336977



8x
6265699



1x
6233922



2x
6338428



24x
4109810



1x
4220539



2x
6347310



1x
6266207



1x
6000650



1x
6016172



1x
6391341



1x
6265730



2x
302026



1x
6187587



1x
6131571



1x
6125719



1x
6238674



8x
6441240



1x
6016059



6x
4528604



2x
6484017



2x
6484410



1x
6035540



4x
6167854



1x
4550329



1x
4097420



2x
6315608



1x
6055169



1x
6097498



1x
6411363



1x
6228123



1x
6389696



1x
6035291



1x
6452539



1x
6407771



6x
6407771



6x
6397820



2x
6248854



6x
6476174



8x
4529242



1x
6270028



4x
6348057



8x
6397610



1x
6035291



1x
6452539



1x
6407771



8x
6407771



6x
6397820



2x
6248854



1x
6261744



2x
6248854



1x
6261744



2x
6117976



4x
6271351



4x
6251403



2x
6236915



1x
6485920



4x
6261388



2x
4211152



4x
6484016



10x
6372430



2x
4211639



1x
6233908

1x
6488619

2x
6383141

2x
6420914



4x
6484016



10x
6372430



2x
4211639



1x
6233908



1x
6488619



2x
6383141



2x
6420914



2x
6420914



2x
6420914



2x
6420914



2x
6420914



2x
6420914



2x
6420914



1x
6270032



1x
6258952



1x
6258950



4x
4519970



2x
6234805



2x
6234805



2x
6234805



2x
6234805



2x
6234805



2x
6234805



2x
6234805



2x
6234805



2x
6234805



1x
6234116



1x
6233913



1x
6233910



1x
6233910



1x
6233910



1x
6233910



1x
6233910



1x
6233910



1x
6233910



1x
6233910



1x
6233910



1x
6233910



1x
6233910

[LEGO.com/service](https://www.lego.com/service)

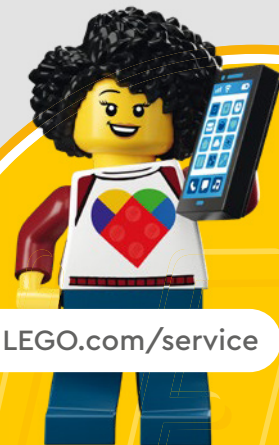



Harry Potter

WIZARDING
WORLD



76435



Each set sold separately and available for different periods of time

Les ensembles sont vendus séparément et à des périodes différentes.

Cada set se vende por separado y está disponible durante un cierto período de tiempo.



76426



Build the most detailed
HOGWARTS™
CASTLE

Construisez
**LE CHÂTEAU
DE POUDLARD**
le plus détaillé

Construye
**EL CASTILLO
DE HOGWARTS™**
más detallado



76430



76431

YOU COULD
WIN



Scan this QR code or go to
LEGO.COM/PRODUCTFEEDBACK and give
us your short feedback about this LEGO® set
for a chance to win a cool LEGO prize.

Terms and Conditions apply*

EN: YOU COULD WIN. Terms and Conditions apply* **DE: Du könntest GEWINNEN.** Es gelten die Teilnahmebedingungen* **FR: Tu pourrais GAGNER.** Des conditions s'appliquent* **IT: Potresti VINCERE tu.** Termini e condizioni sono applicabili* **ES: Puedes GANAR.** Aplican términos y condiciones* **PT: Poderá GANHAR.** Aplicam-se termos e condições* **ZH: 轻松获奖. 条款和条件适用*** **PL: Szansa na WYGRANĄ.** Obowiązują warunki korzystania* **CS: Máte šanci VYHRÁT.** Platí všeobecné smluvní podmínky* **SK: Máte šancu VYHRAŤ.** Platia všeobecné zmluvné podmienky* **HU: TE IS NYERHETSZ.** Felhasználási feltételek érvényesek* **RO: Ai putea CÂȘTIGA.** Se aplică termeni și condiții* **BG: Можете да СПЕЧЕЛИТЕ.** Има определени правила и условия* **LV: Tu vari LAIMĒT.** Ir spēkā noteikumi un nosacījumi.* **ET: Sul on võimalus VÕITA.** Kehtivad tingimused* **LT: Jūs galite LAIMĖTI.** Taikomos sąlygos*

*[LEGO.com/productfeedback-terms](https://www.lego.com/productfeedback-terms)

LEGO and the LEGO logo are trademarks of the/son des marques de commerce du/son marcas registradas de LEGO Group. ©2024 The LEGO Group.

WIZARDING WORLD and all related trademarks, characters, names, and indicia are © & ™ Warner Bros. Entertainment Inc. Publishing Rights © JKR. (s24)

6520765