



Harry Potter



76431



LEGO® Builder



LEGO.com/sustainable-packaging



FR
DONNEZ
OU
RECYCLEZ



ASSOCIATION

OU



MAGASIN

OU



DÉCHÈTERIE

Adresses sur quefairedemesdechets.fr

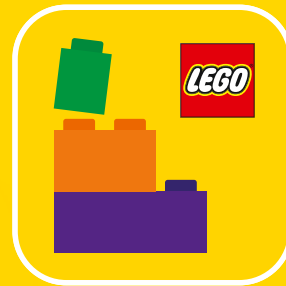

BUILDER



Apple and the Apple logo are trademarks of Apple Inc., registered in the U.S. and other countries and regions. App Store is a service mark of Apple Inc. Google Play and the Google Play logo are trademarks of Google LLC. Tencent and the Tencent logo are trademarks of Tencent Inc.

LEGO.com/devicecheck

EN Ask parents' permission before going online | DE Eltern um Erlaubnis bitten, bevor du online gehst | FR Demande l'autorisation d'un parent avant d'aller en ligne | IT Chiedi il permesso ai tuoi genitori prima di andare online | ES Pídeles permiso a tus papás antes de conectarte a Internet | PT Pede autorização aos pais antes de acederes online | ZH 上网前应先征得父母的同意 | PL Poproś rodziców o zgodę, zanim wejdiesz do Internetu | CS Než půjdeš na internet, požádej rodiče o svolení | SK Skôr než pôjdeš na internet, vypýtaj si povolenie od rodičov | HU Kérj szülői engedélyt, mielőtt online csatlakoznál! | RO Cere permisiunea părinților înainte de a te conecta online | BG Поискайте разрешение от родител, преди да влезете онлайн | LV Pirms došanās tiešsaistē palūdz atļauju vecākiem | ET Enne Interneti kasutamist küsi vanematelt luba | LT Prieš prisijungdami prie interneto, atsiklauskite tėvų

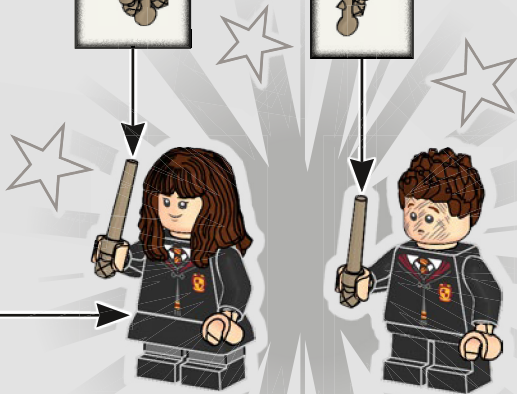
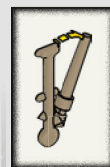
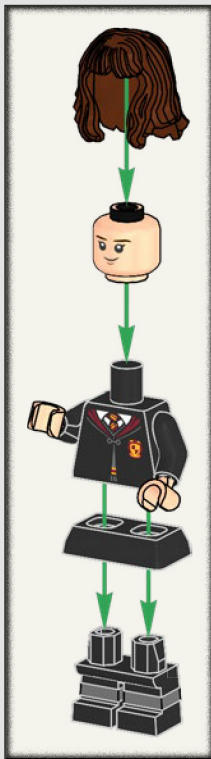

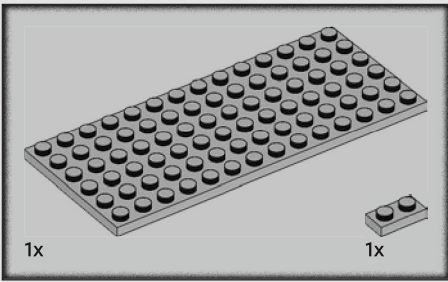

1

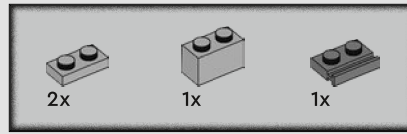
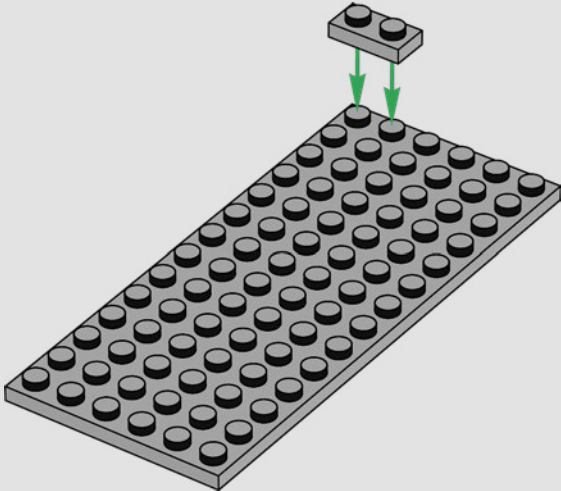

2

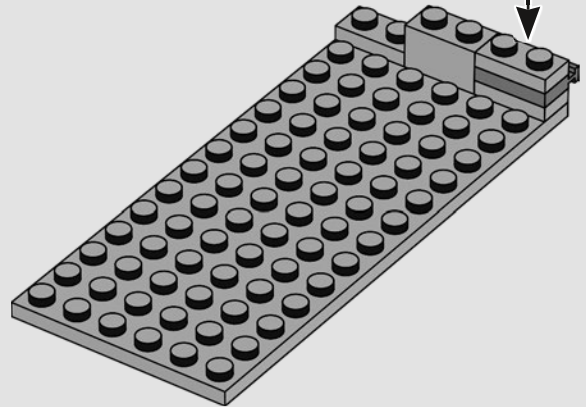
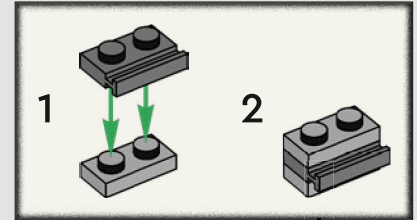

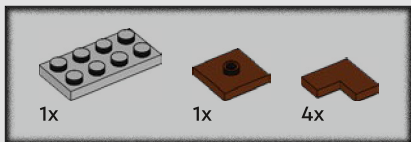

3

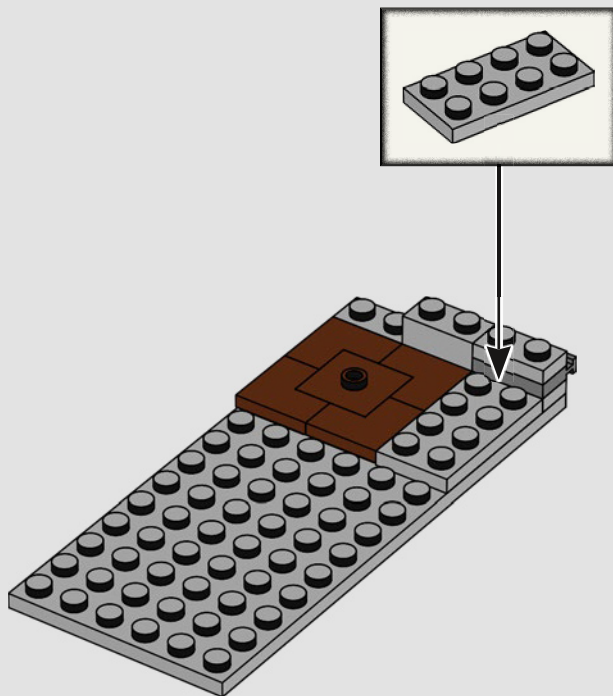

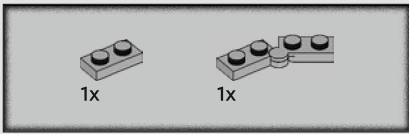

4

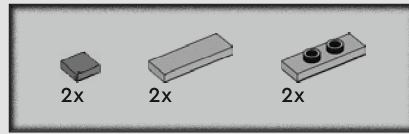
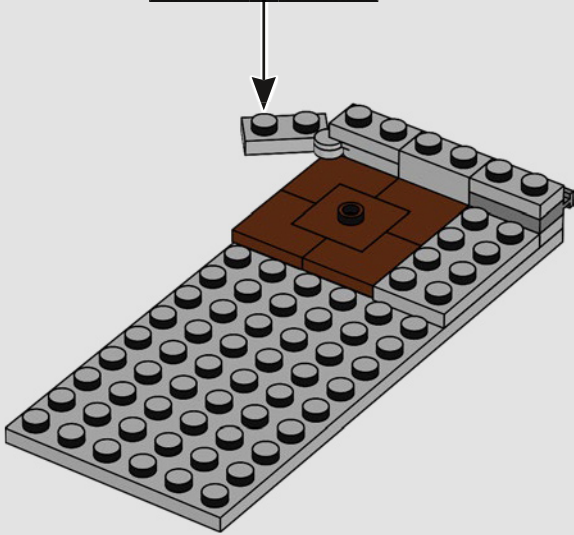
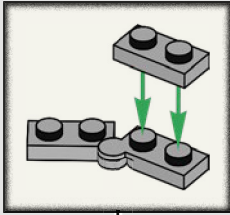

5

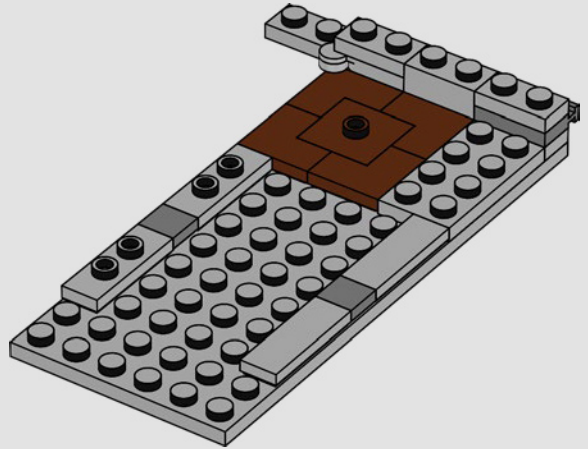

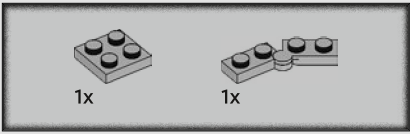

6

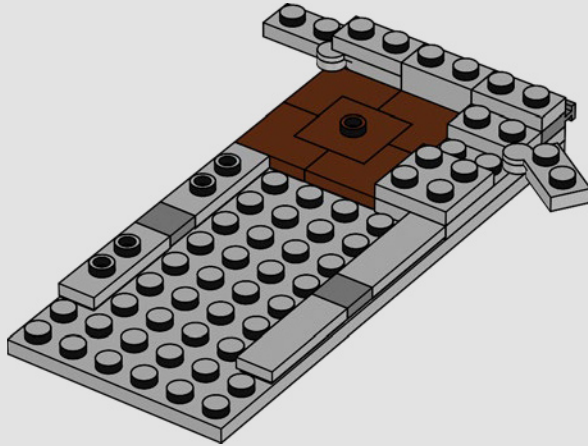

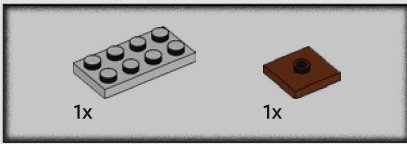

7

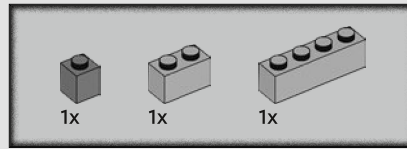
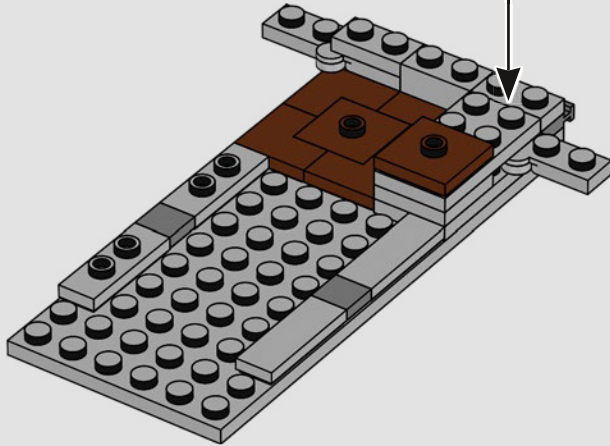
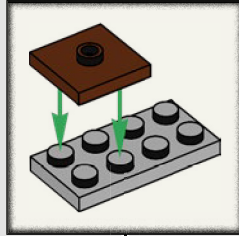

8

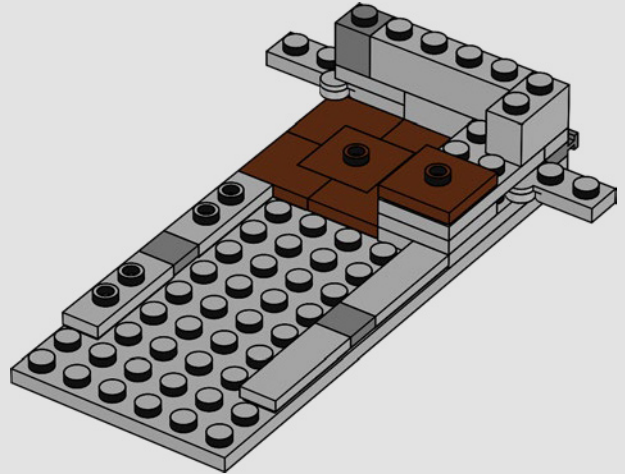

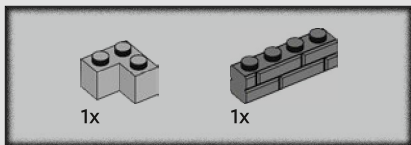

9

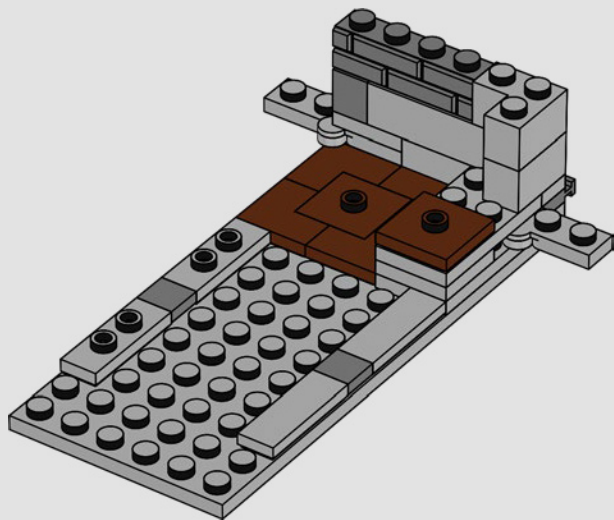

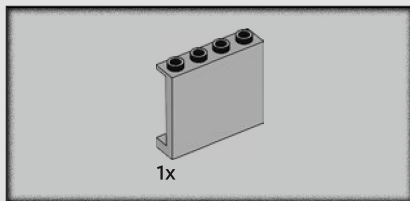

10

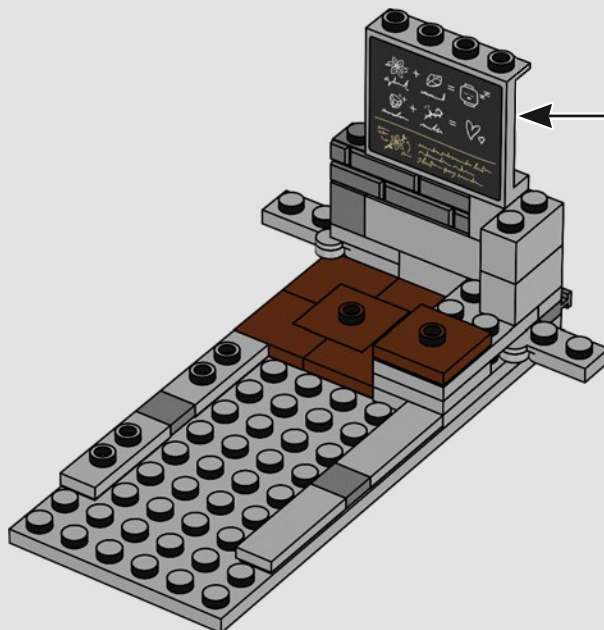
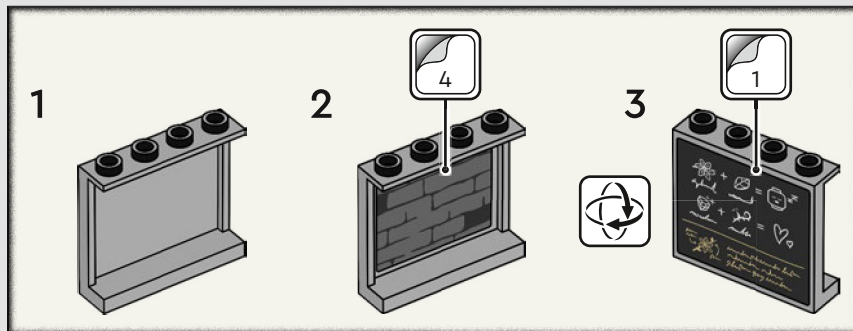

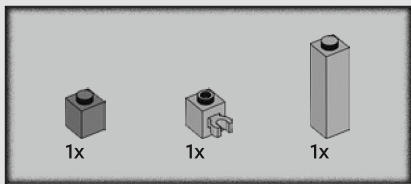

11

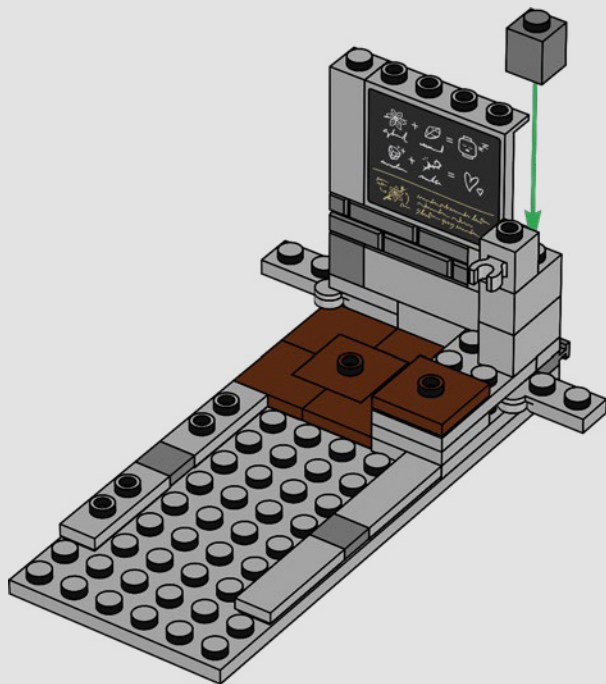

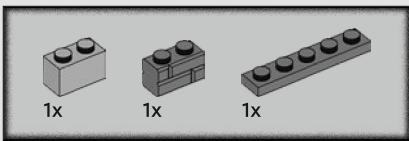

12

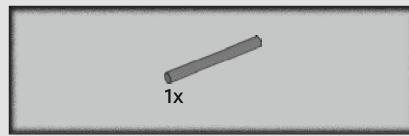
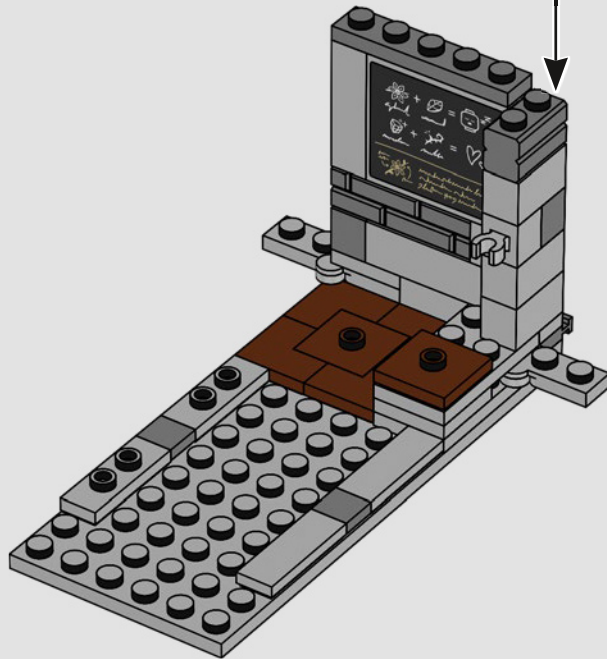
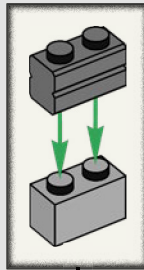

13

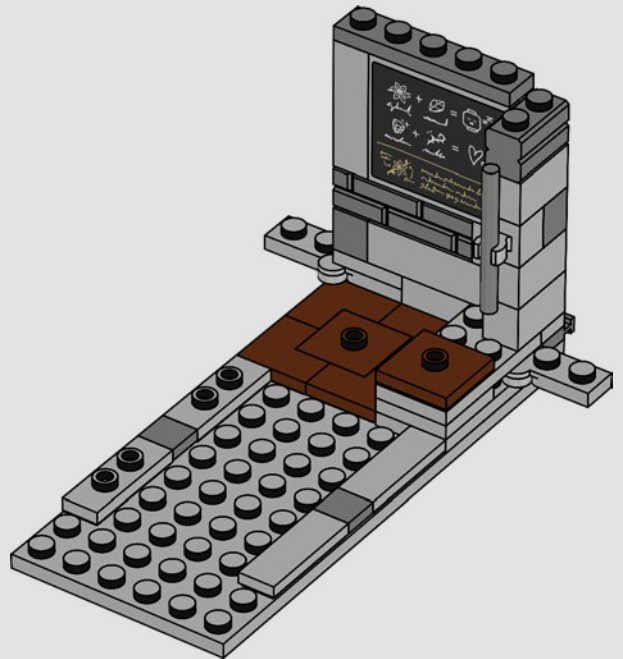

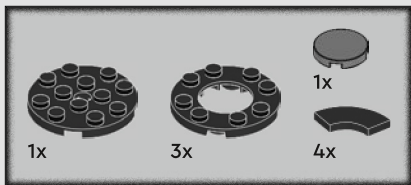

14

1

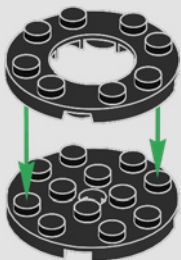

2

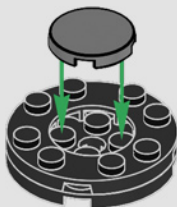

3

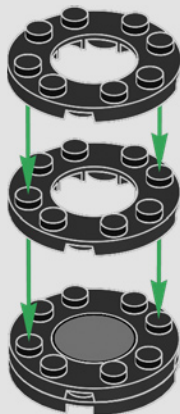

4

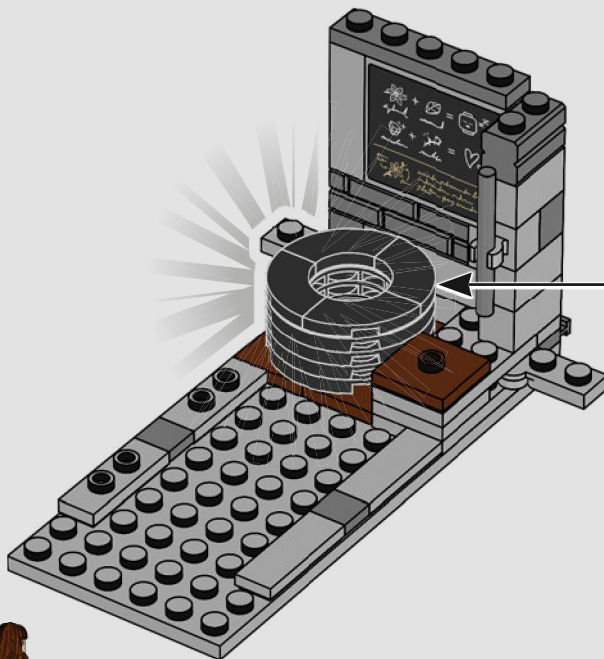
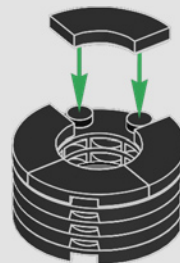

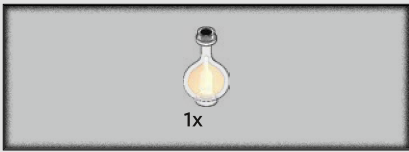

15

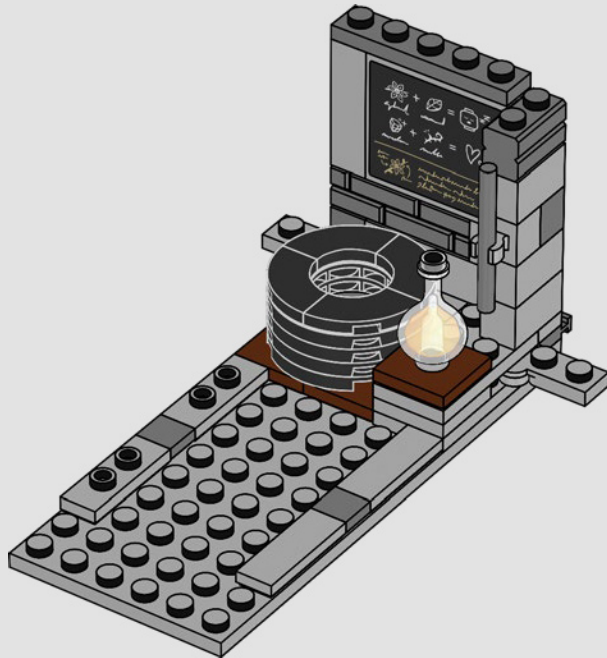

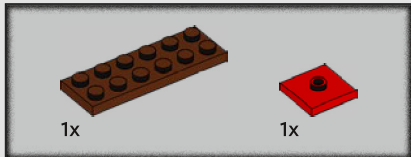

16

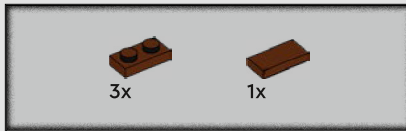
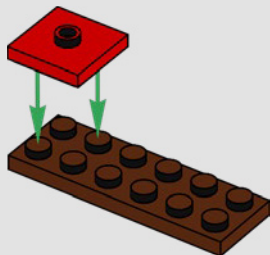

17

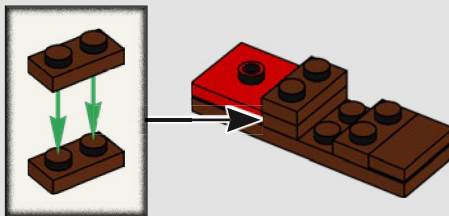

18

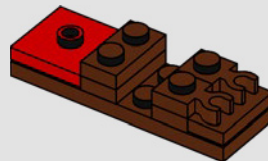

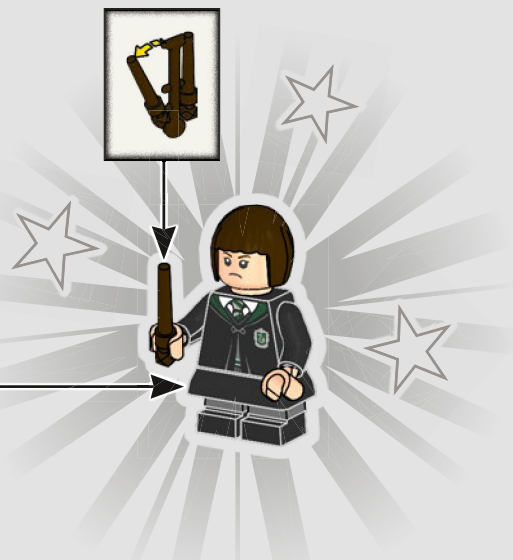
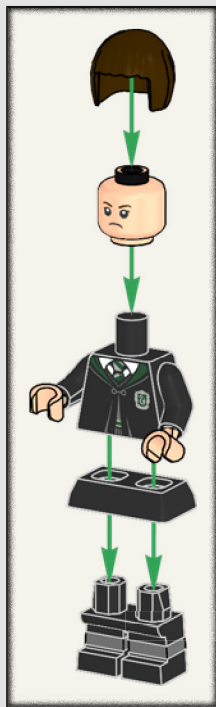

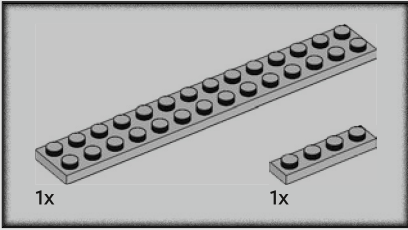
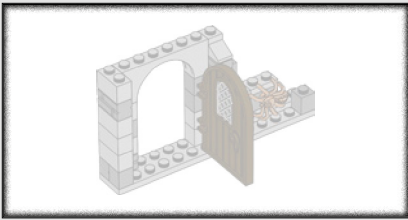

22

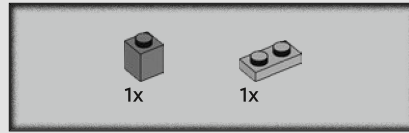
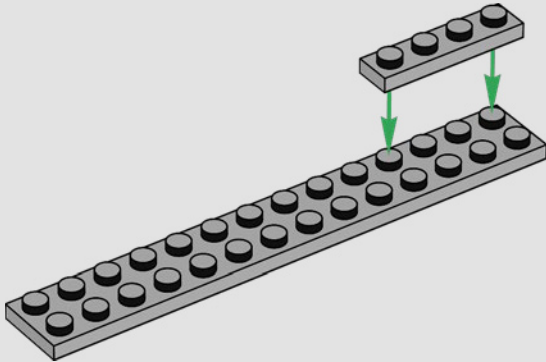

23

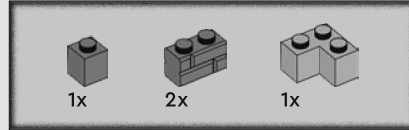
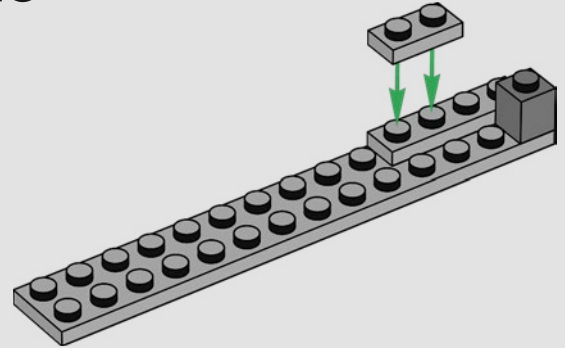

24

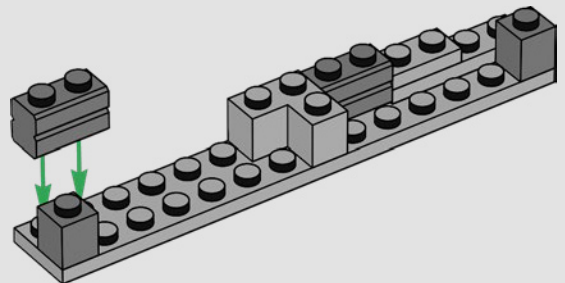

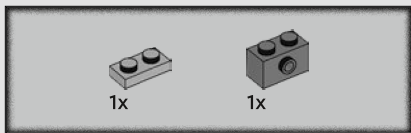

25

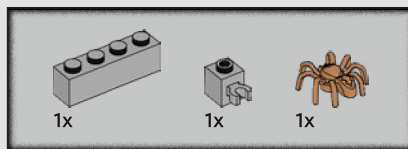
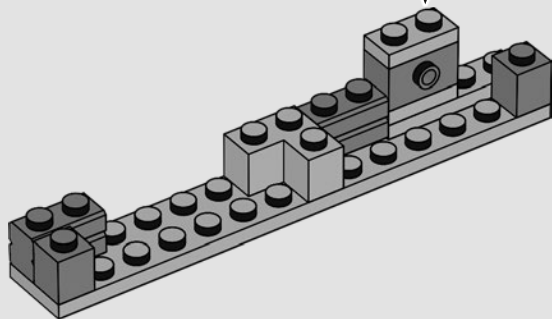
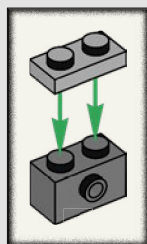

26

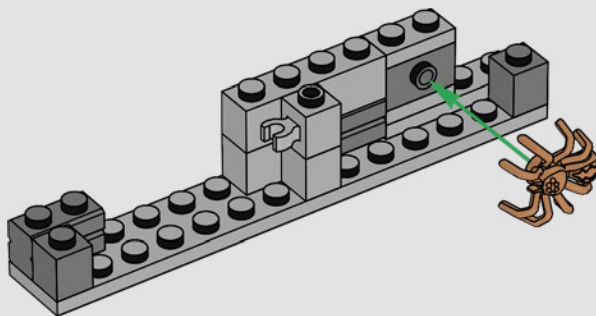

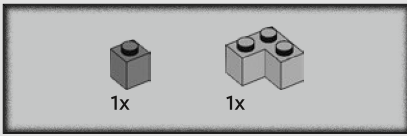

27

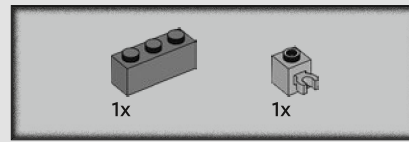
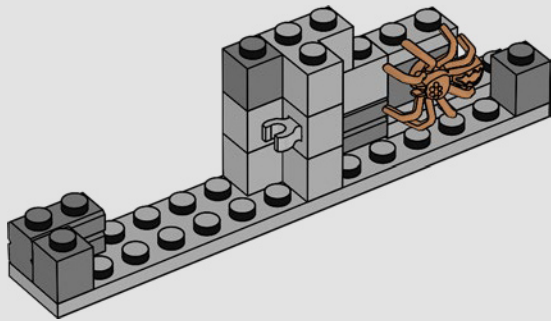

28

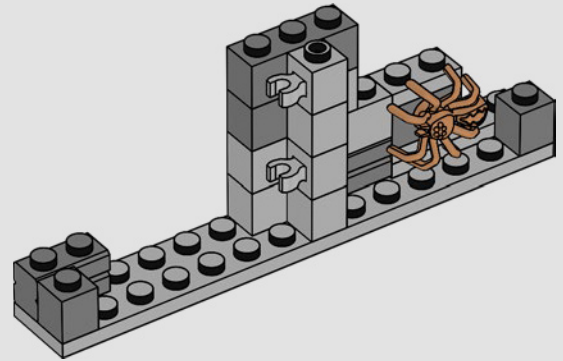

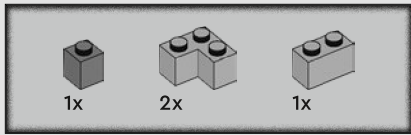

29

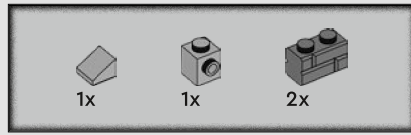
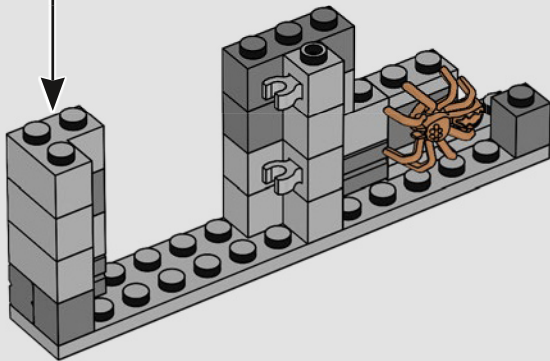
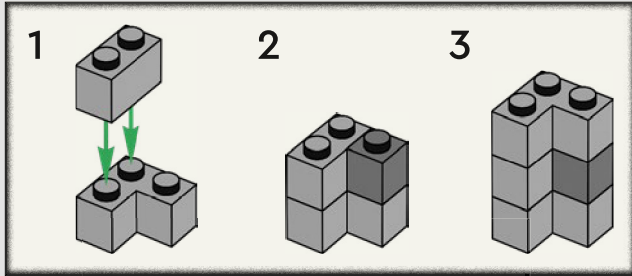

30

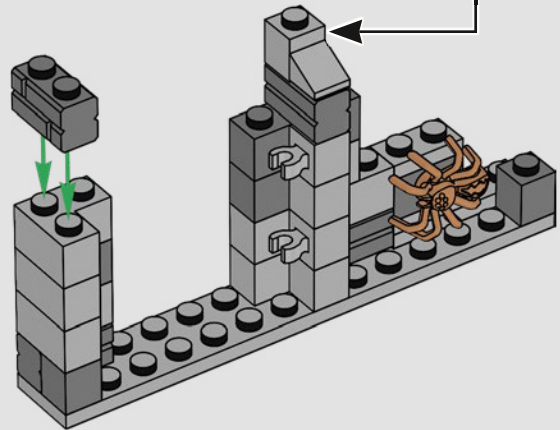
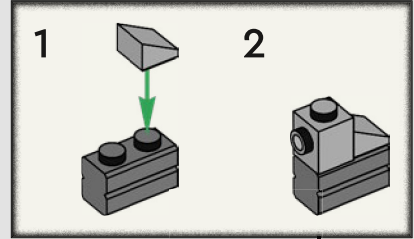

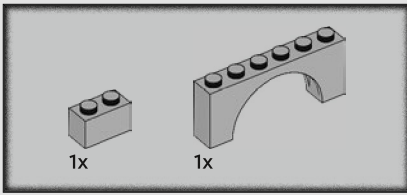

31

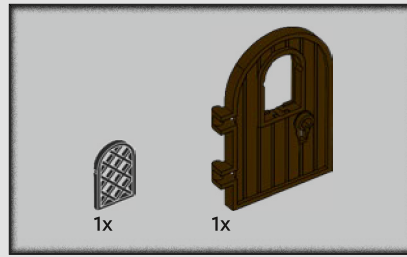
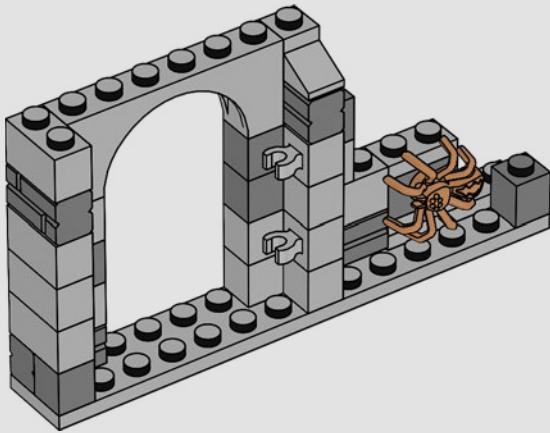

32

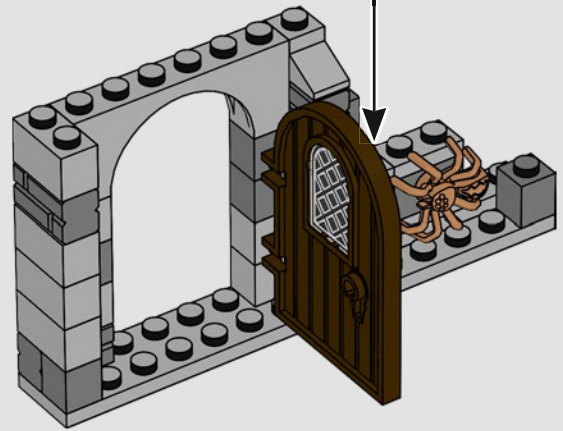
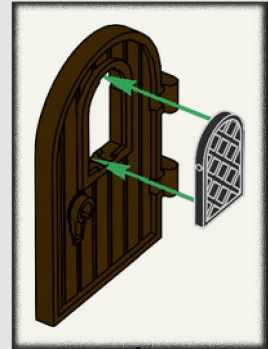

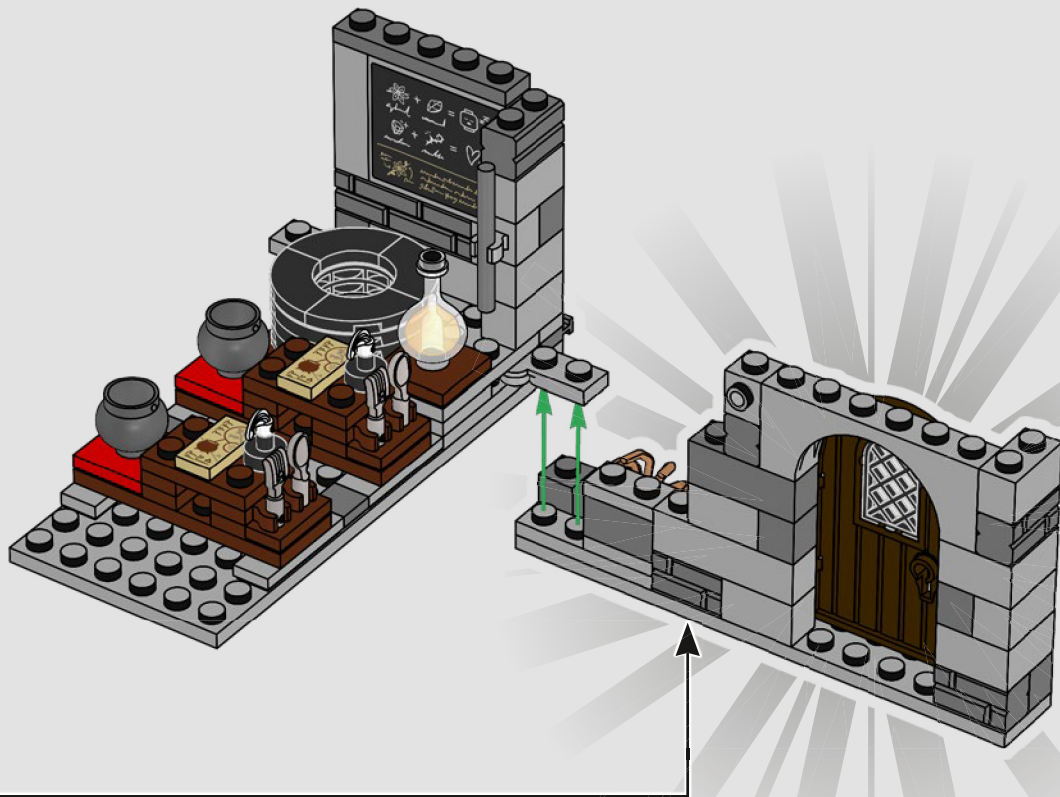

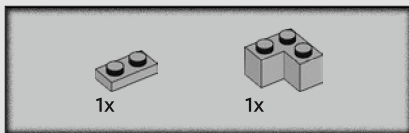

34

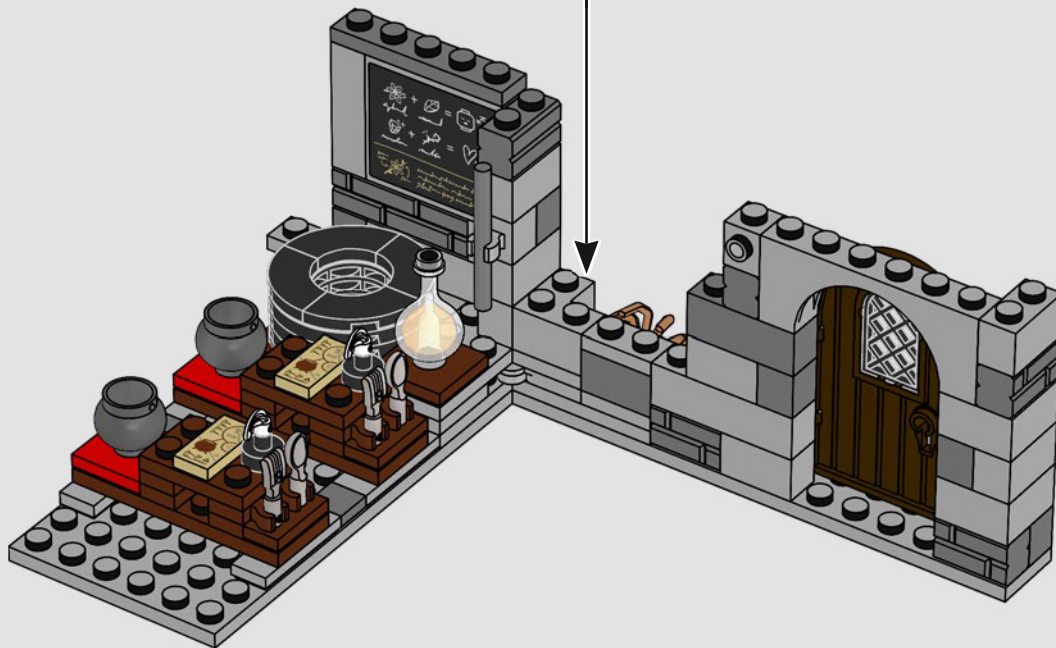
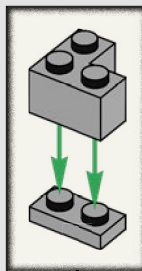

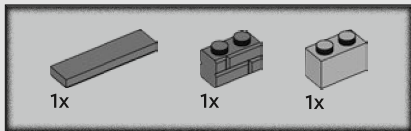

35

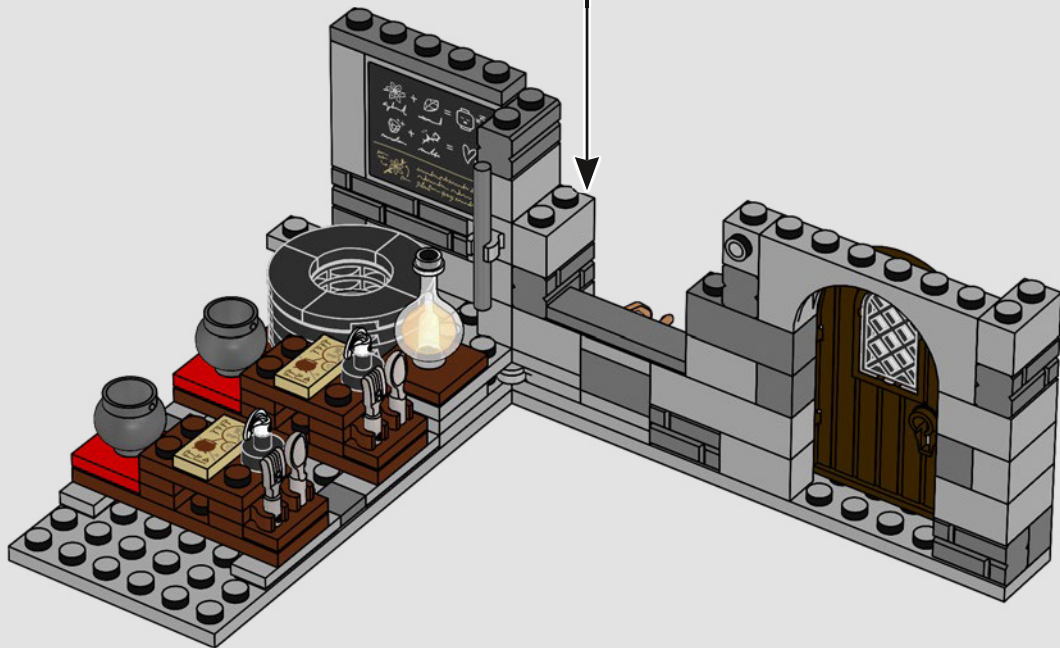
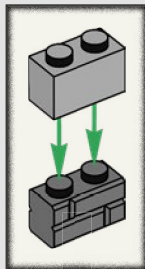

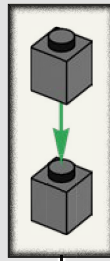
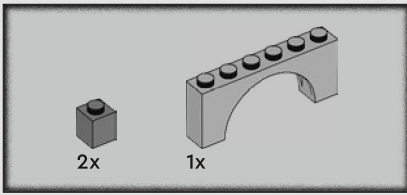

36

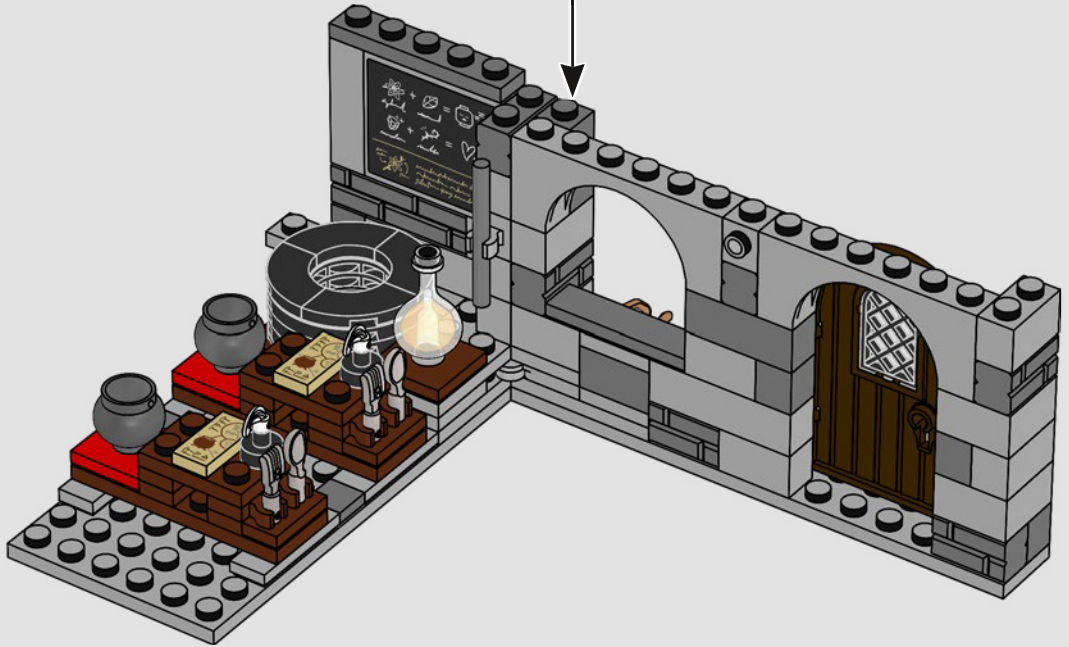

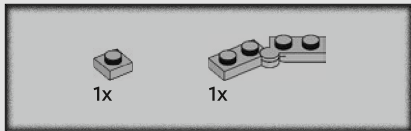

37



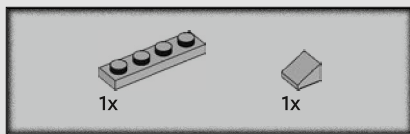

38



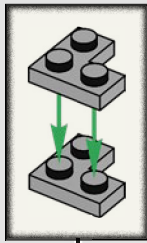
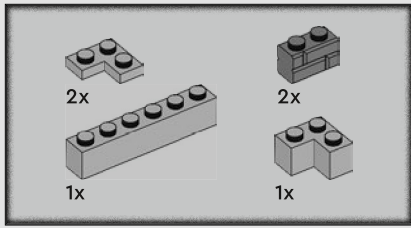

39

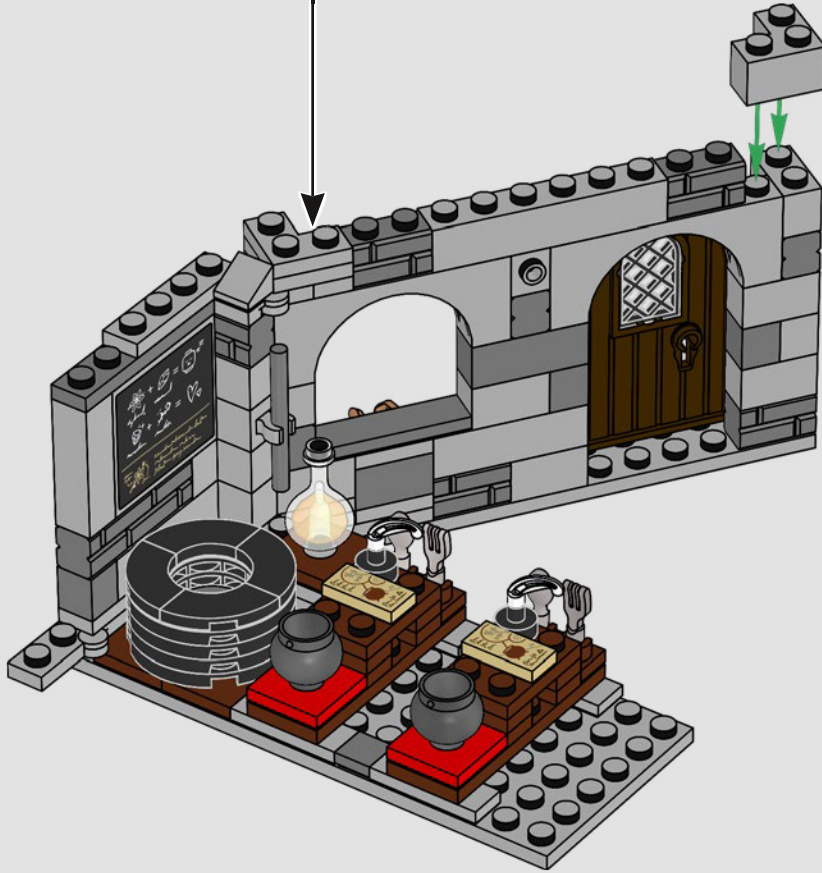

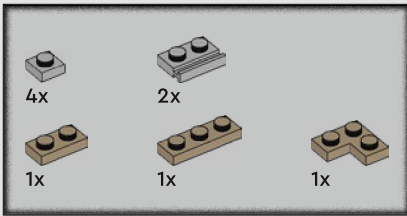

40

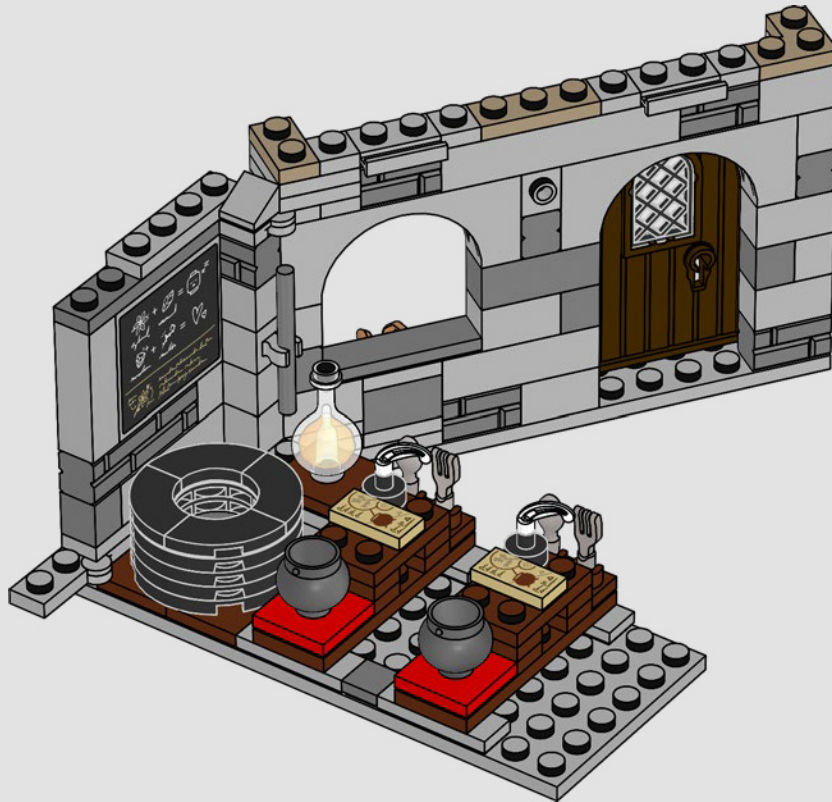

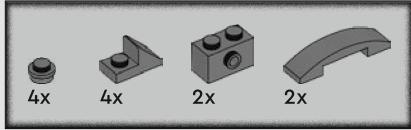

41

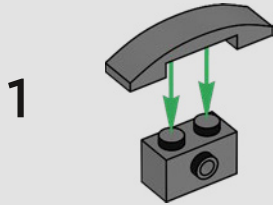

2

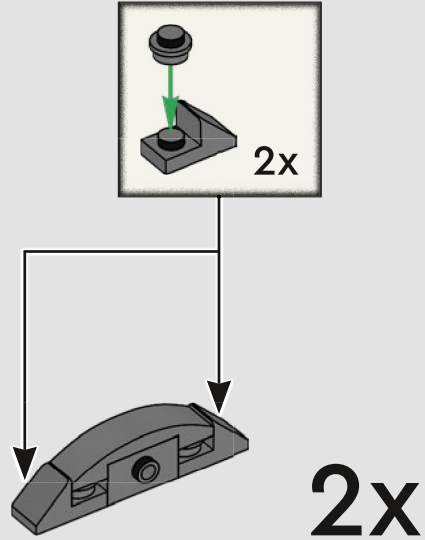

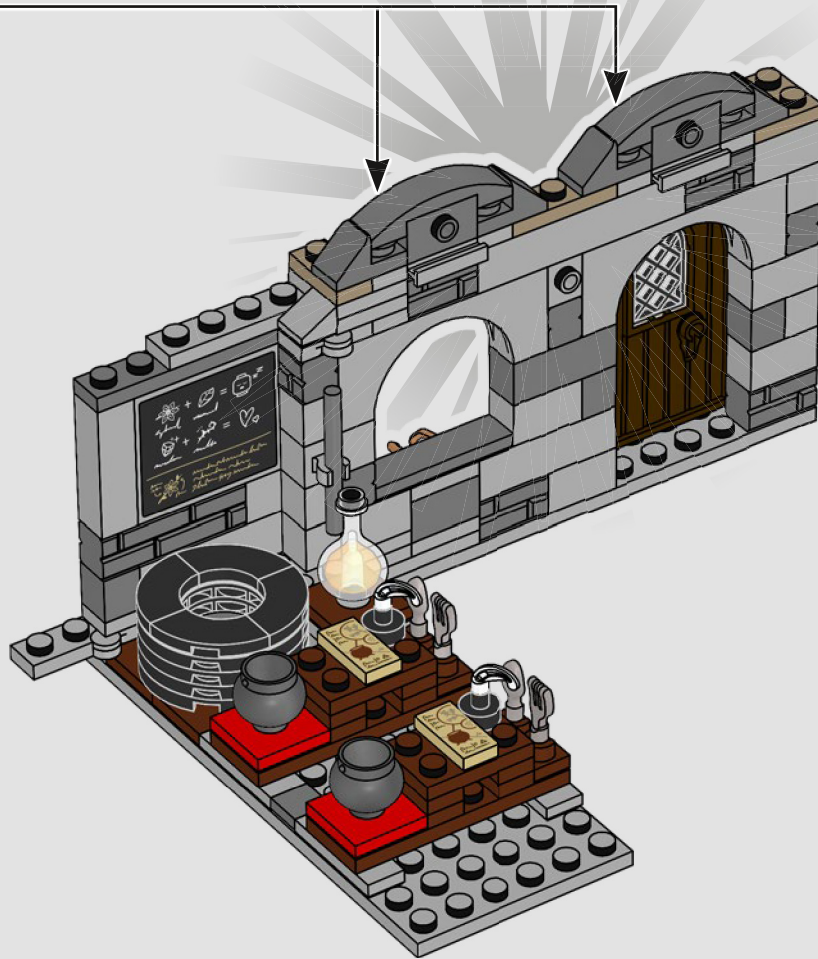

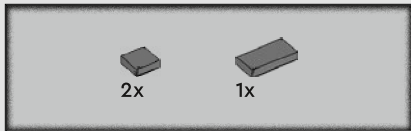

42

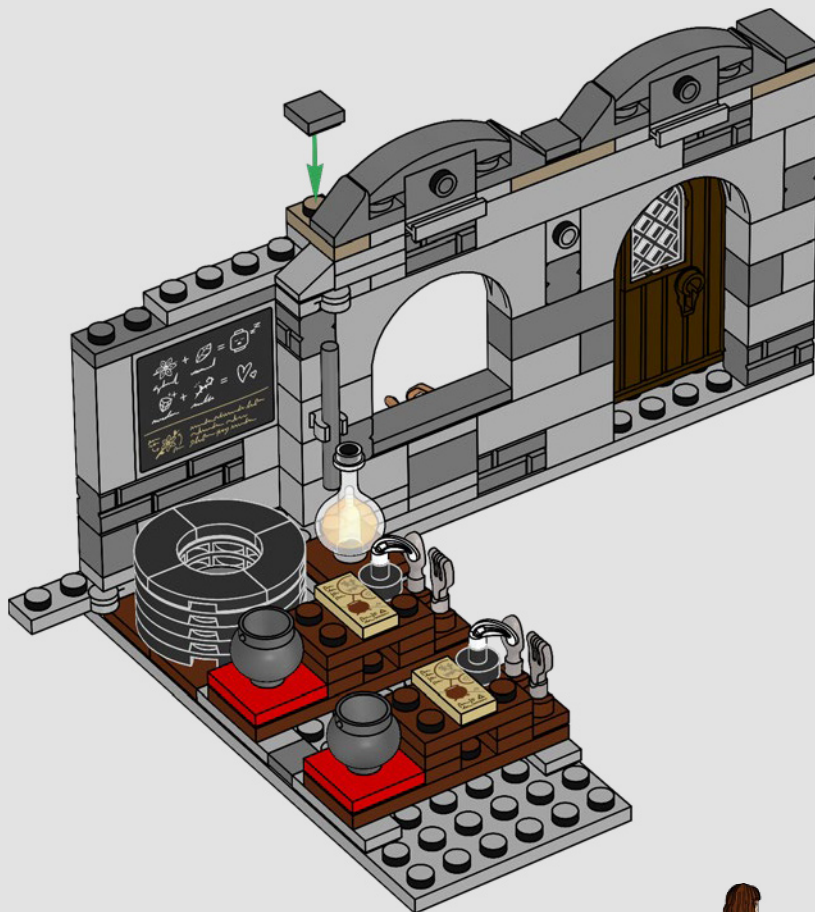

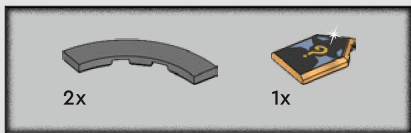

43

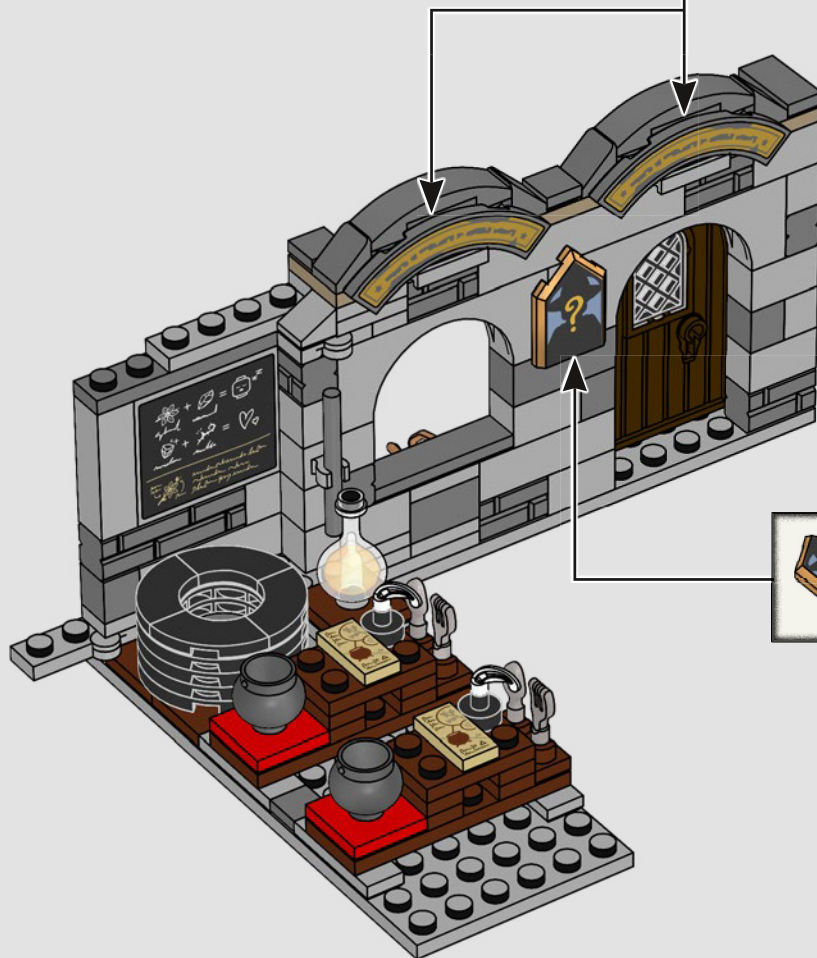
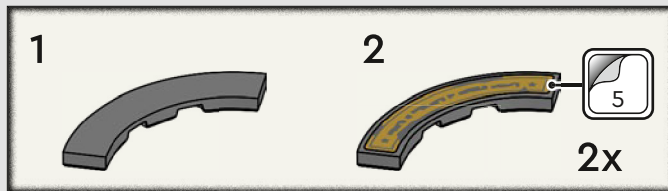

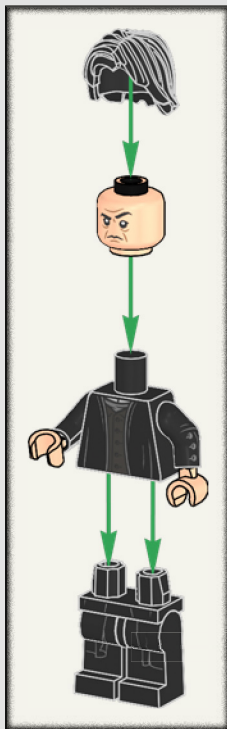

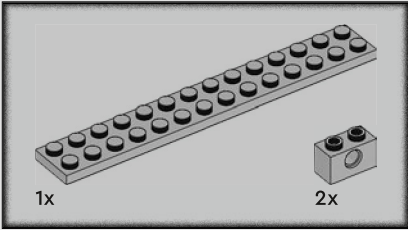
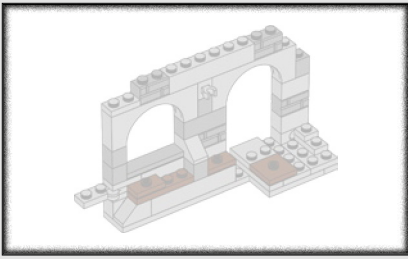

44

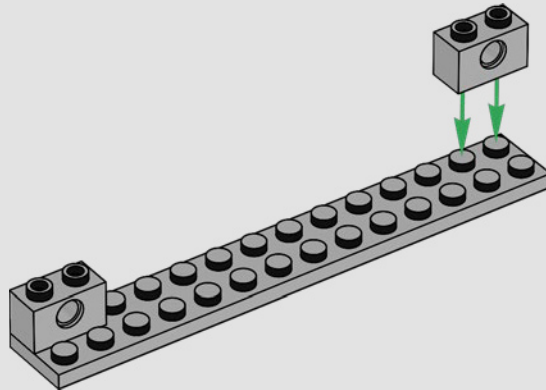

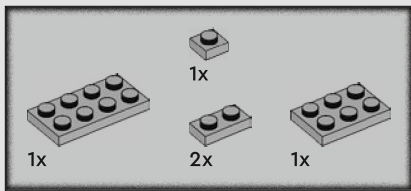

45

1

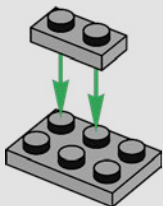

2

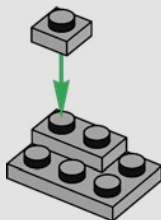

3

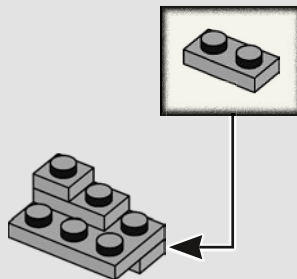

4

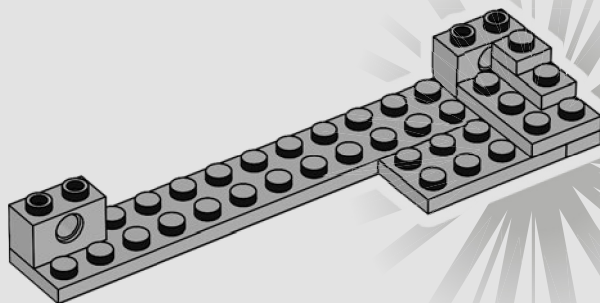
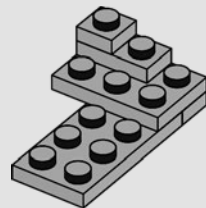

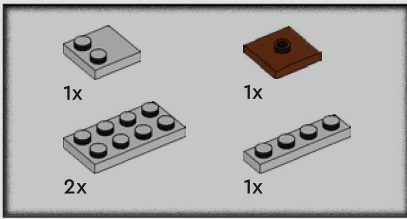

46

1

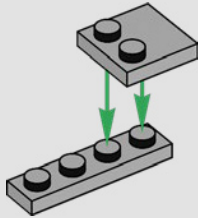

2

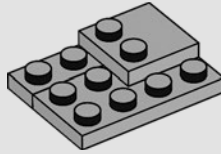

3

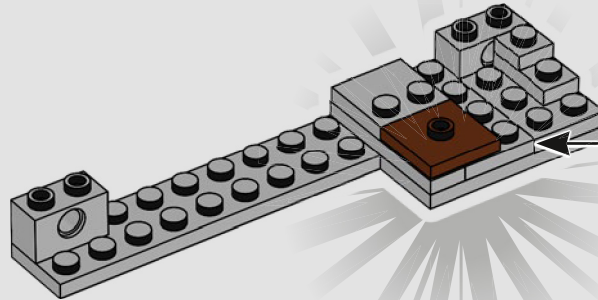
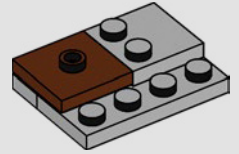

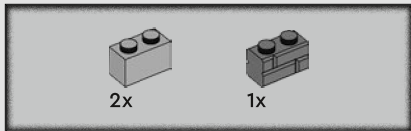

47

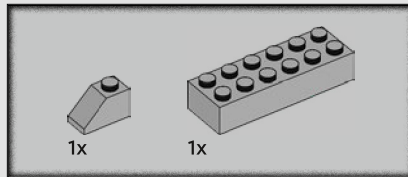
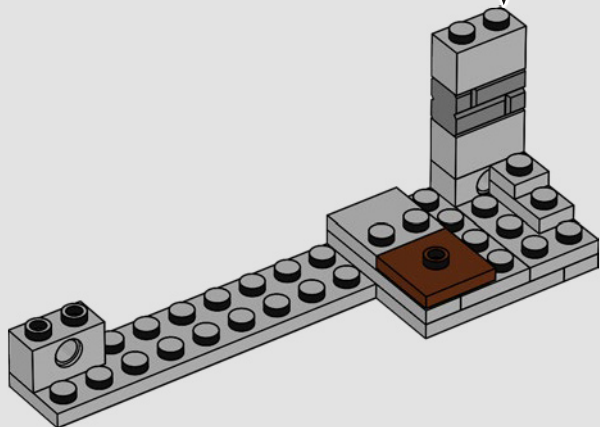
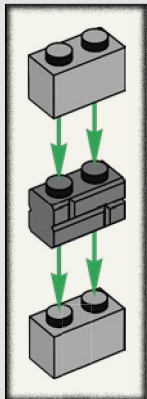

48

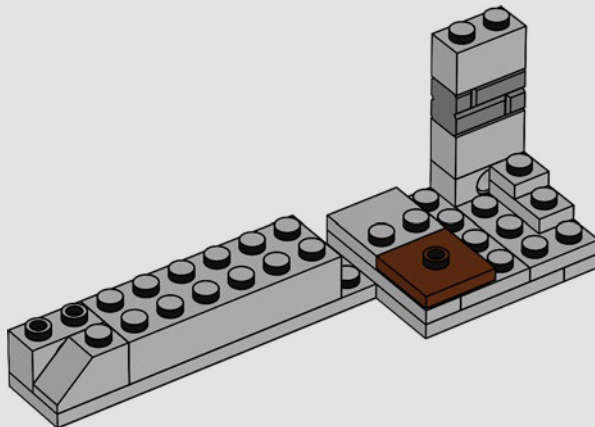

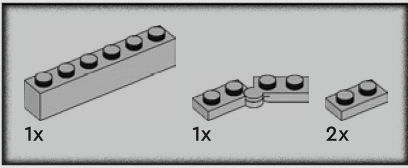

49

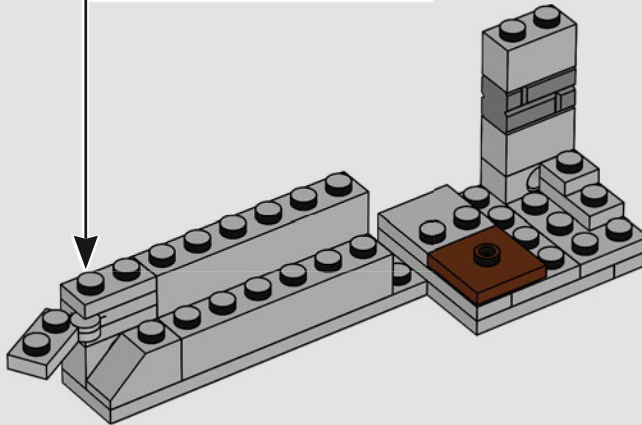
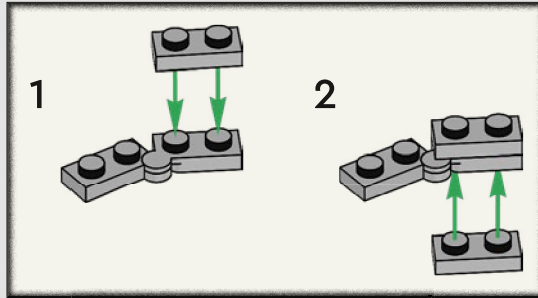

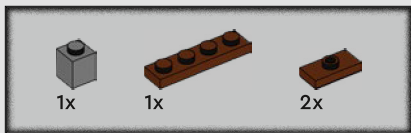

50

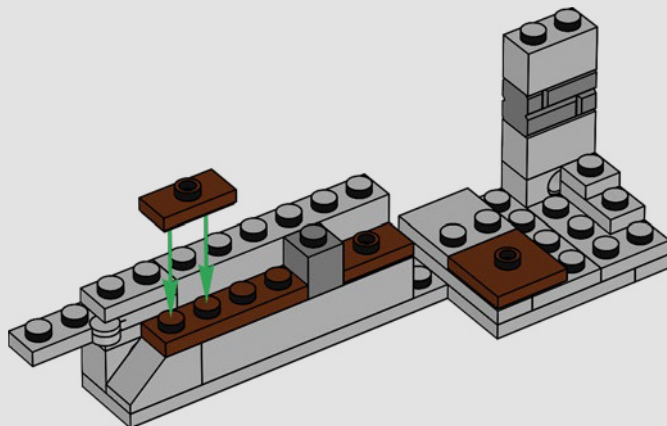

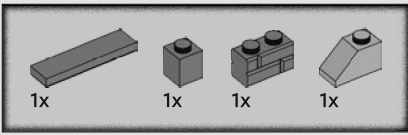

51

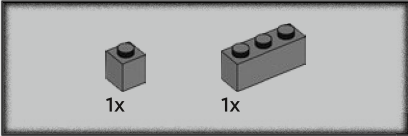
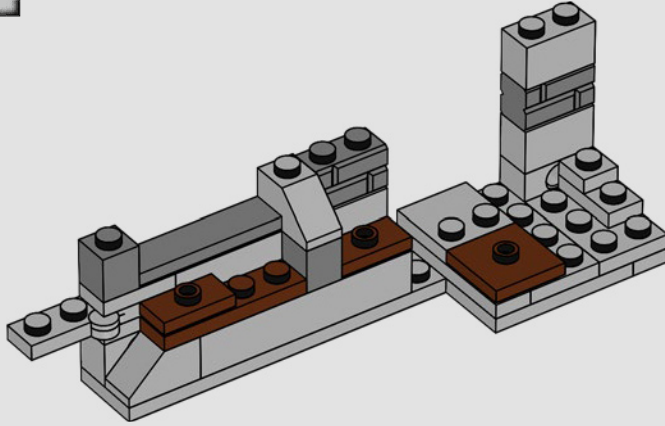

52

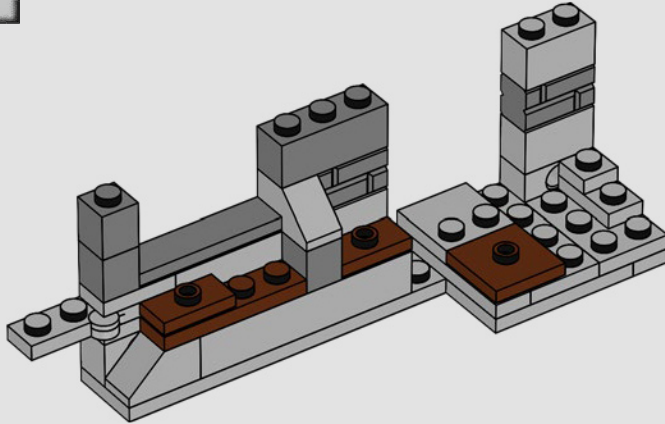

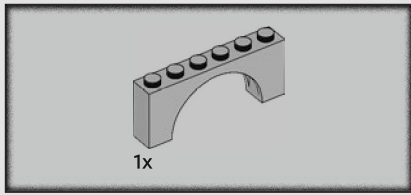

53

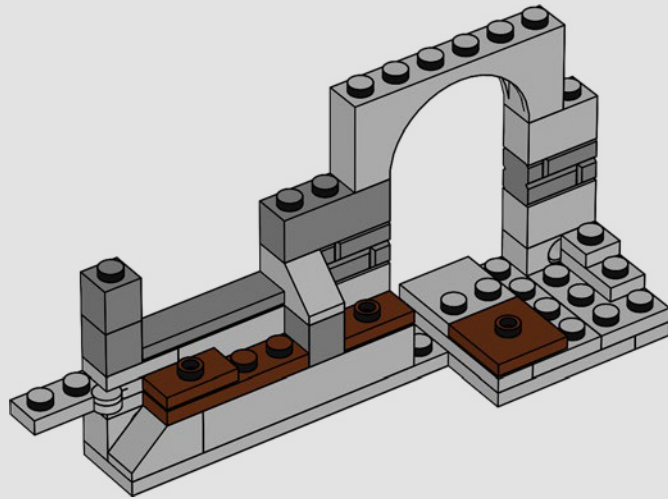

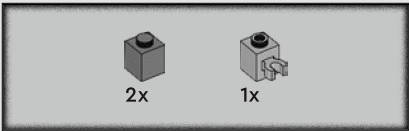

54

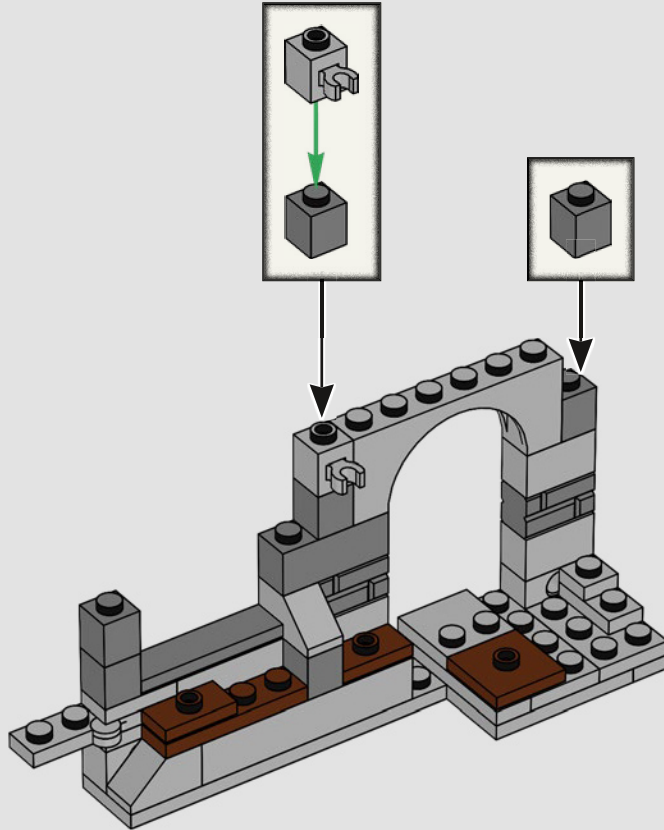

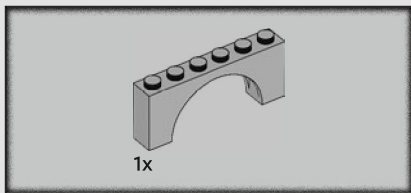

55

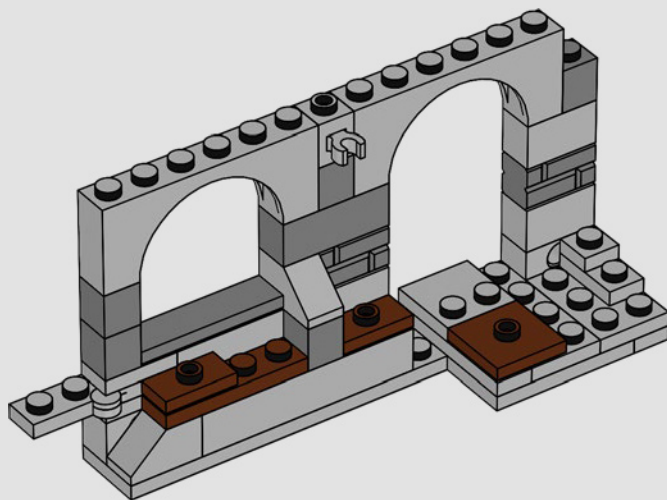

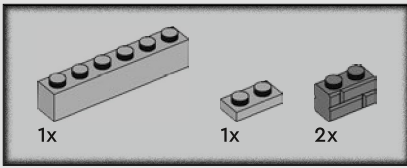

56

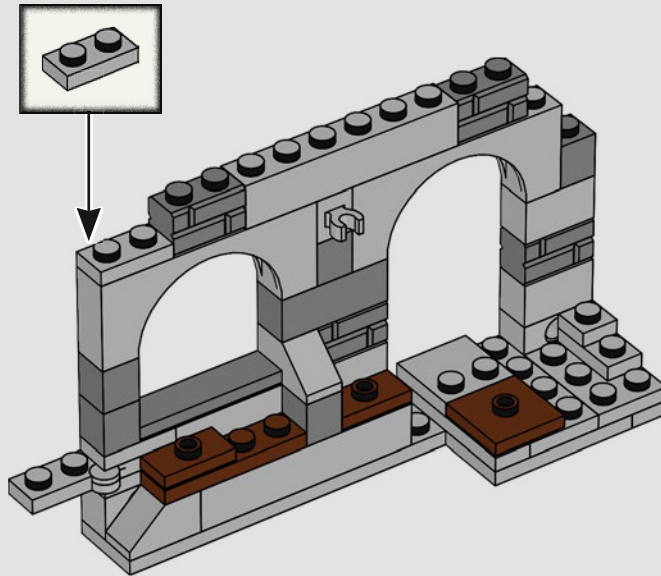

57

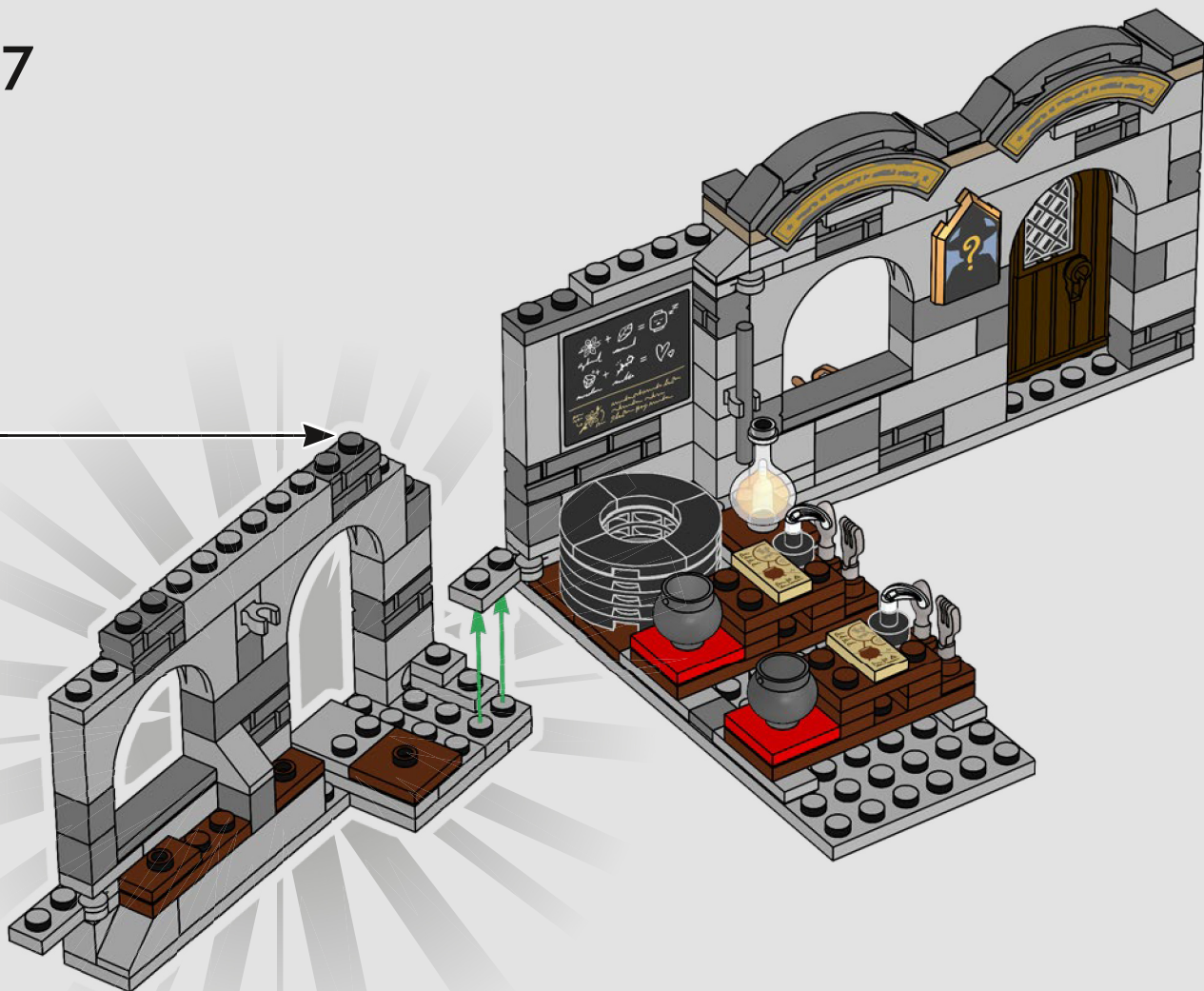



1x

58

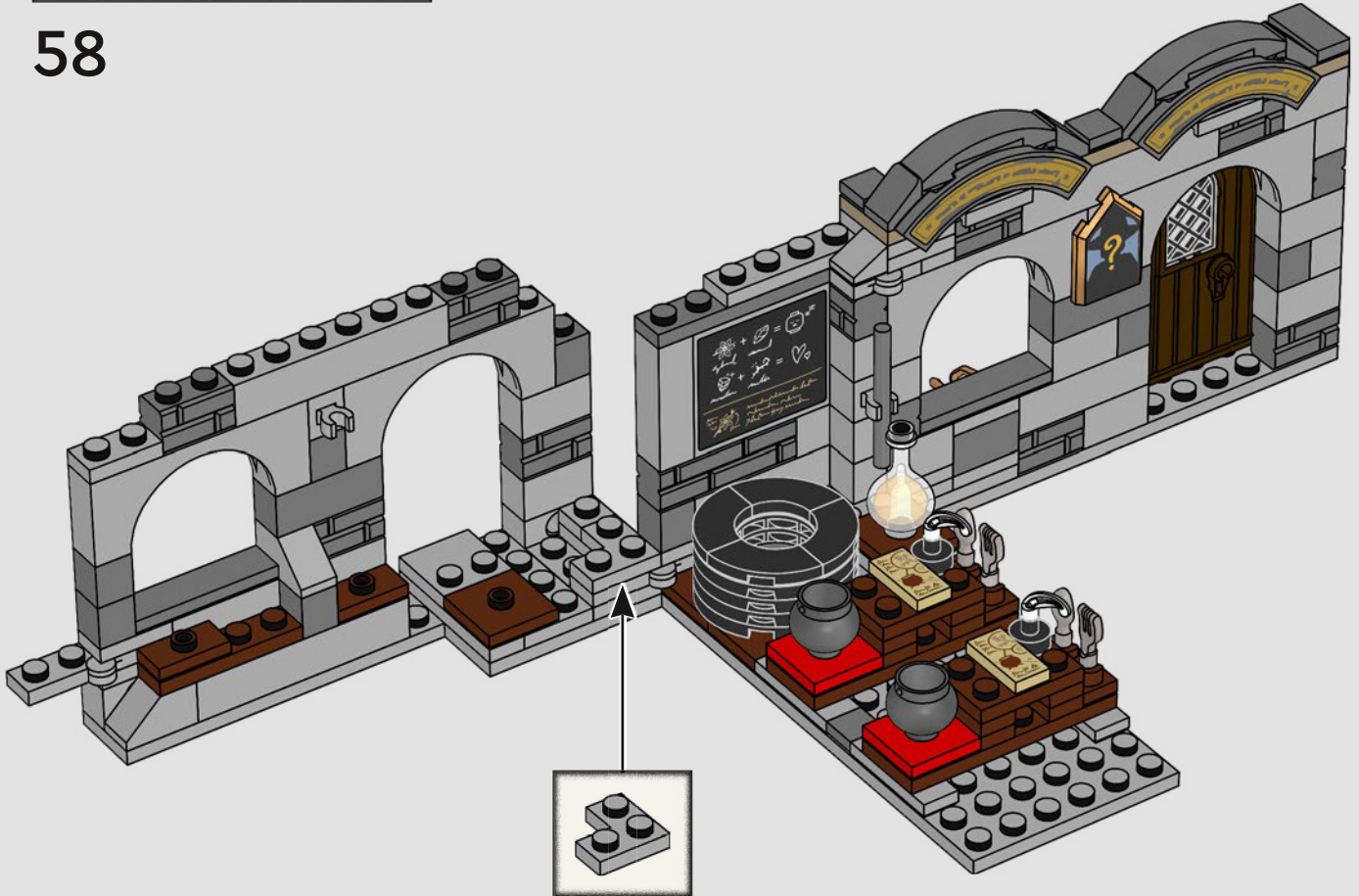

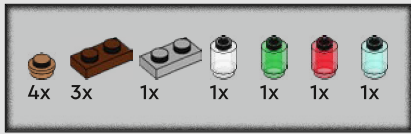

59

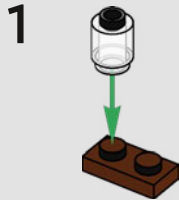

3



4

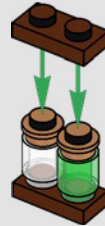

5



6



7



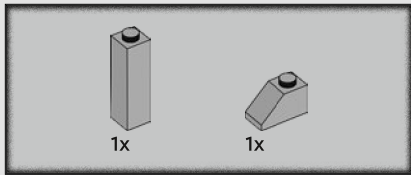

60

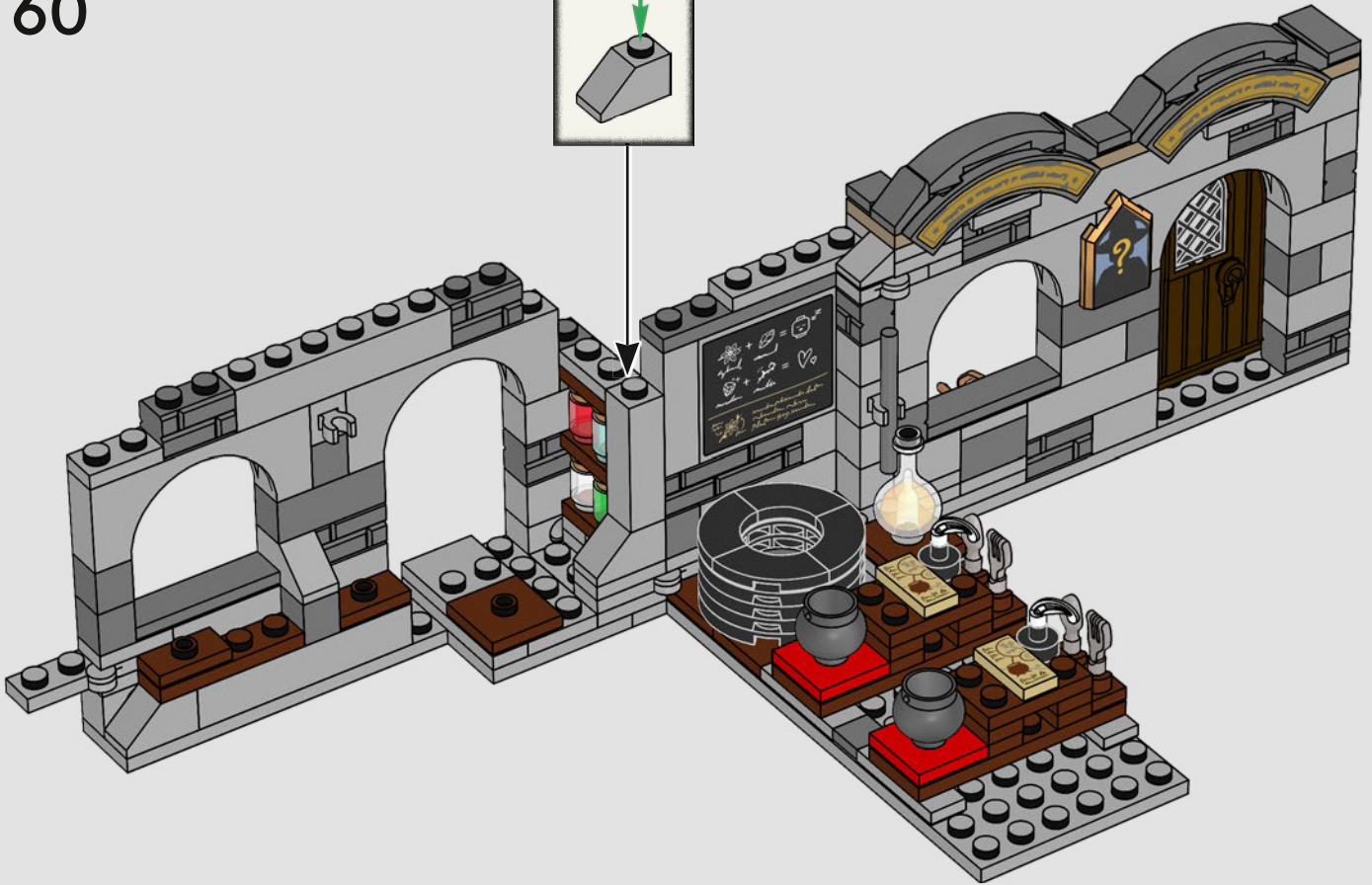
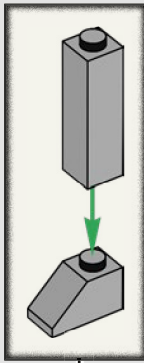

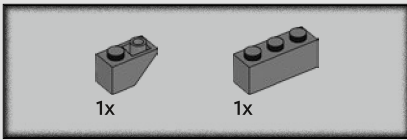

61

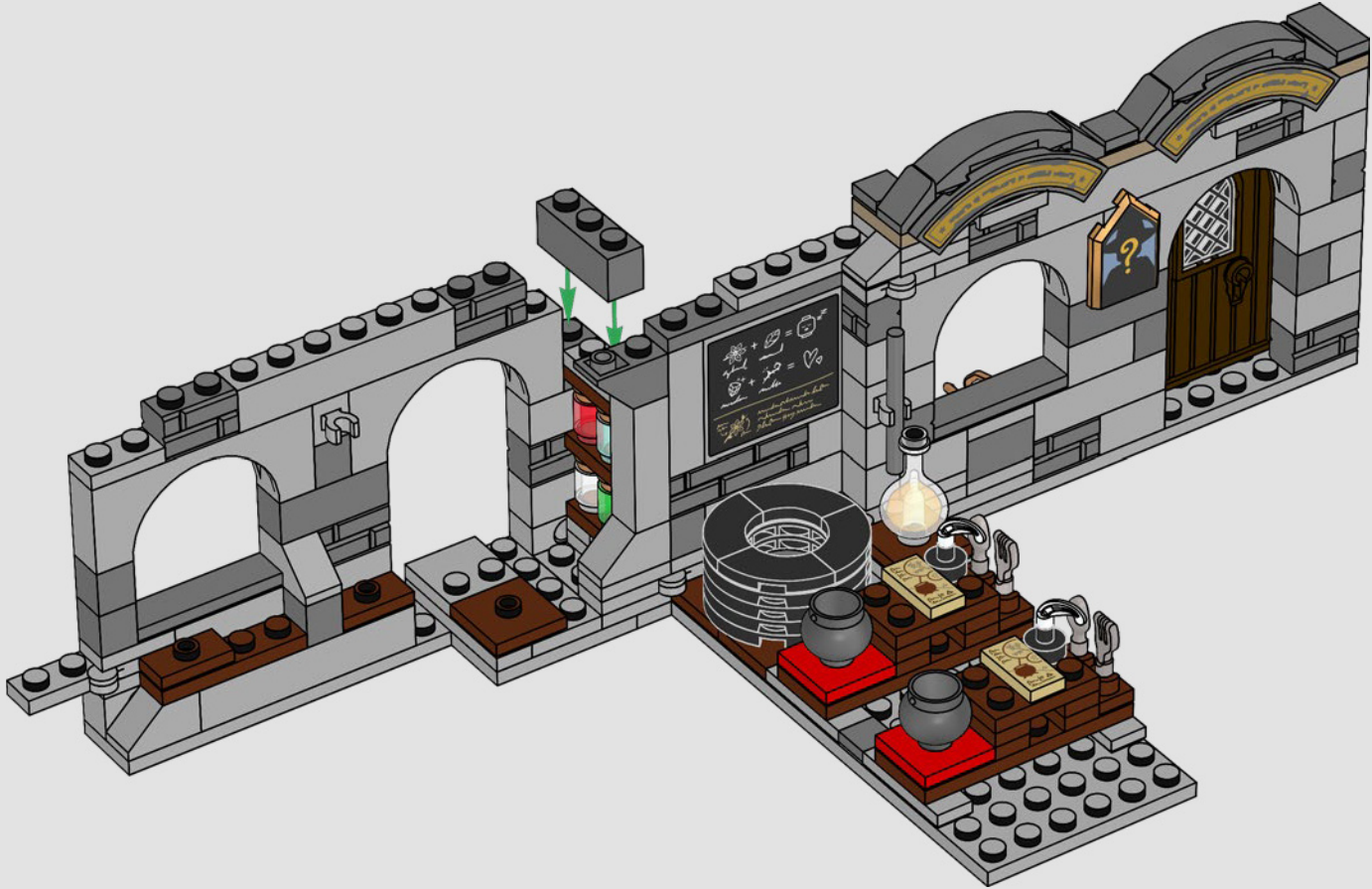

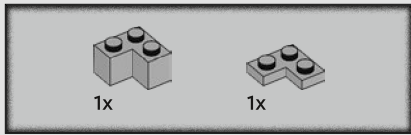

62



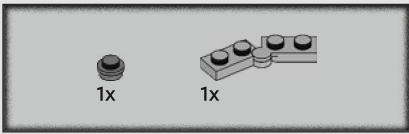

63



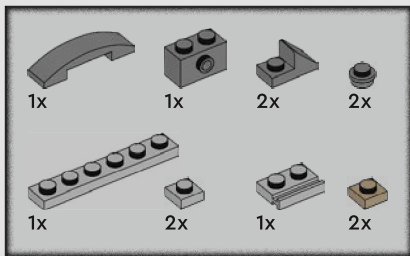

64

1

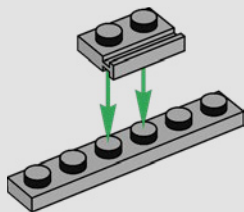

2

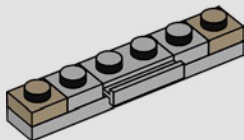

3

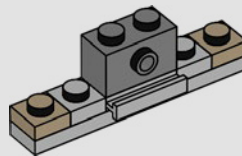

4

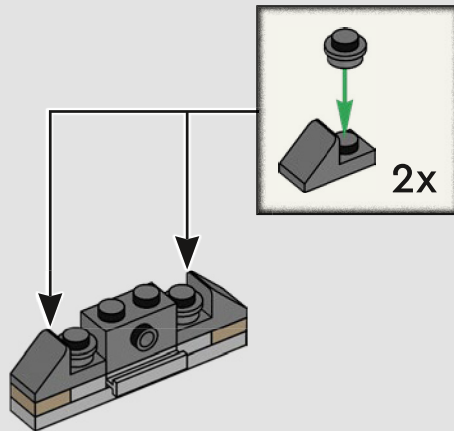

5

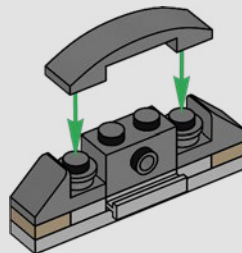

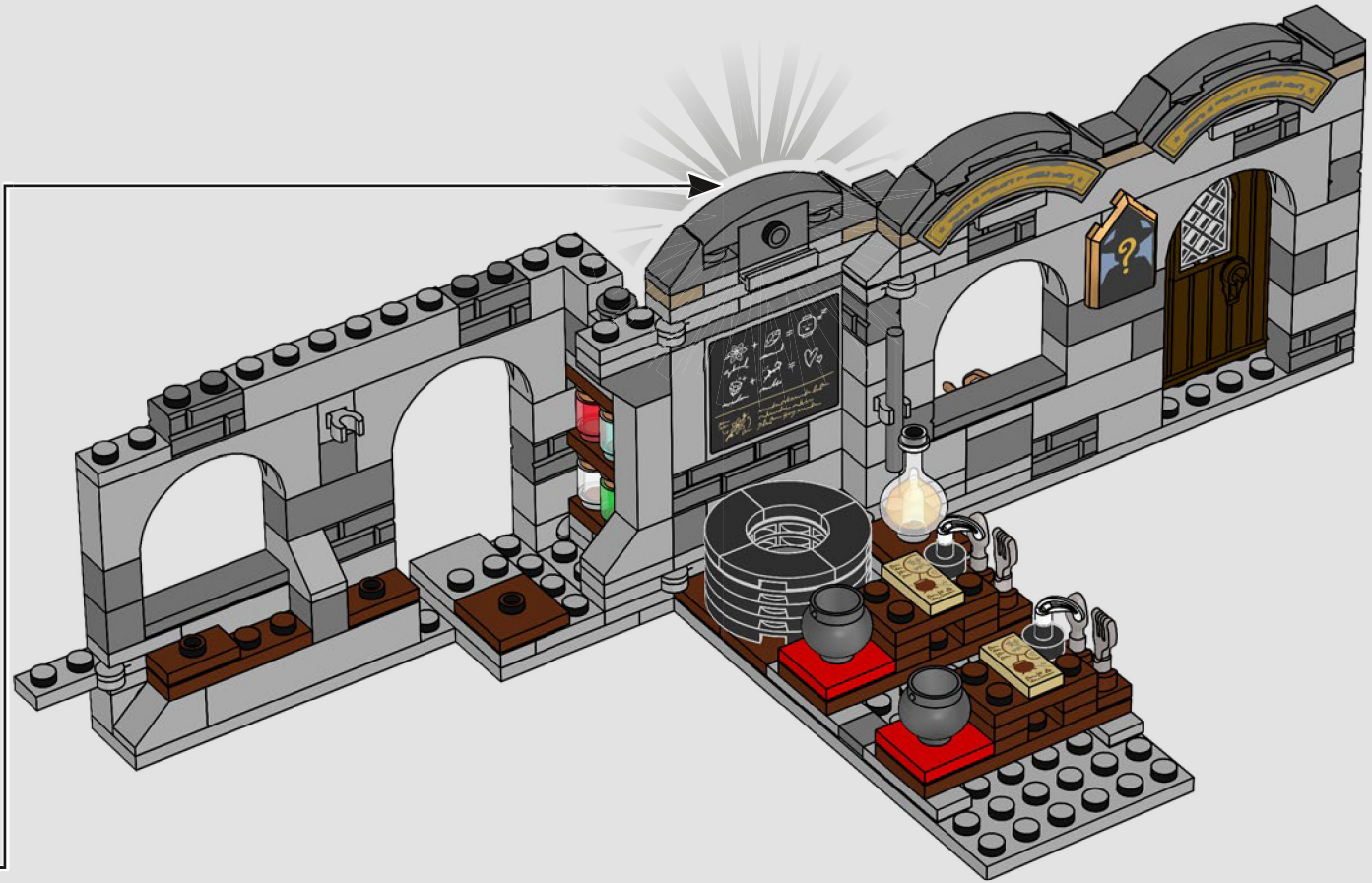

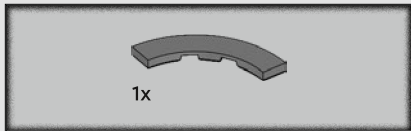

65

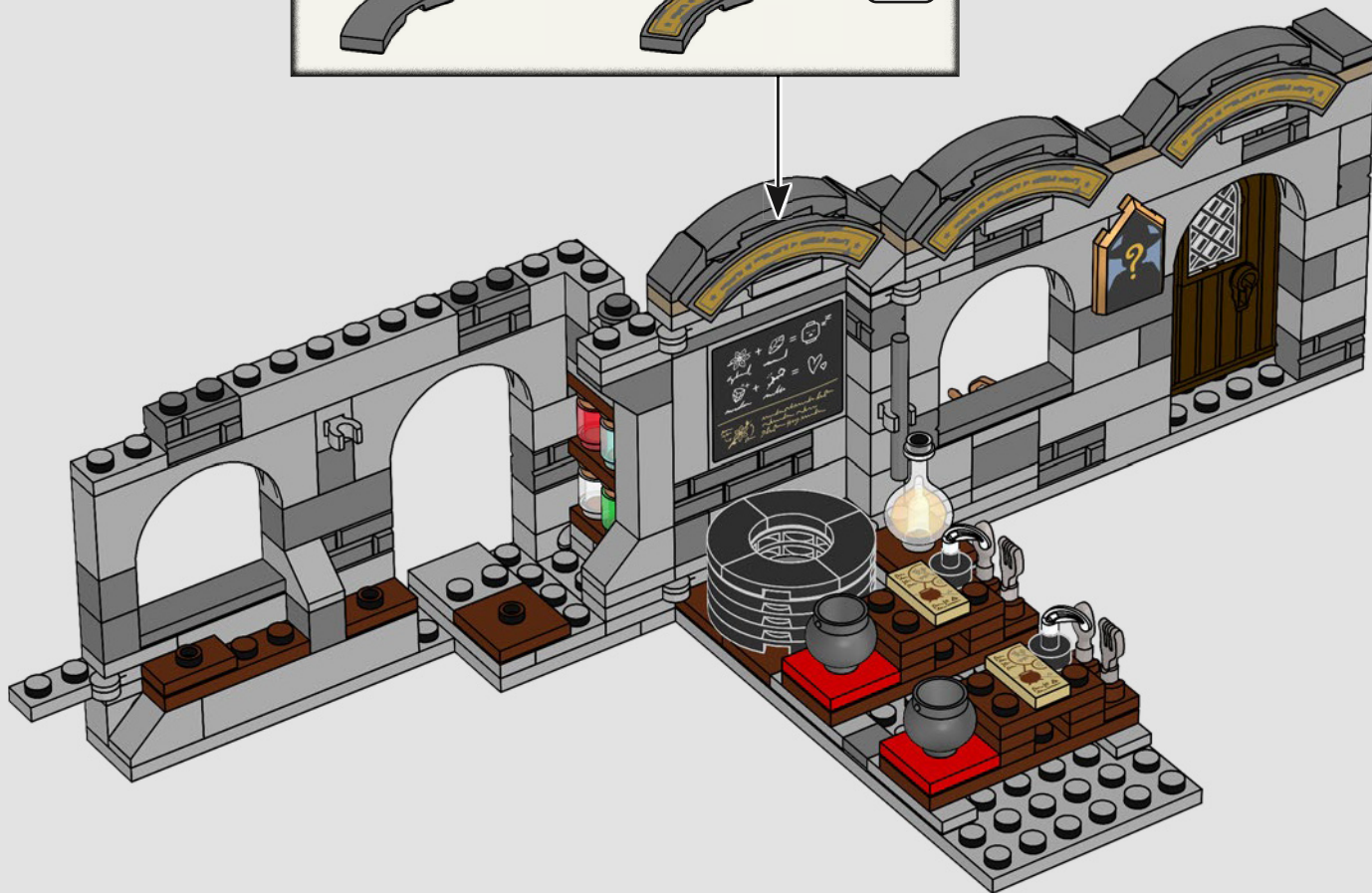
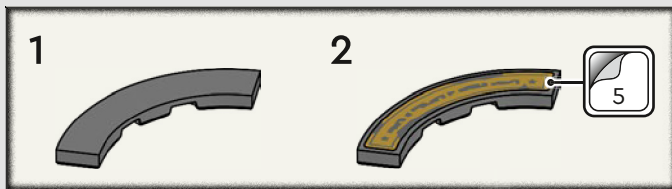

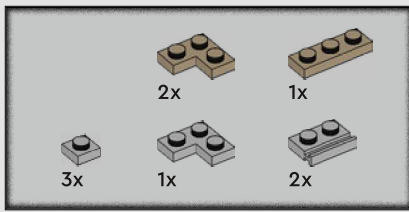

66

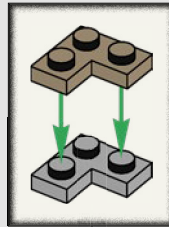

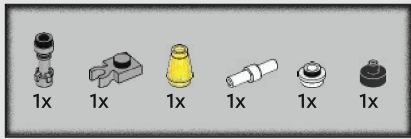

67

1



2



3



1



2

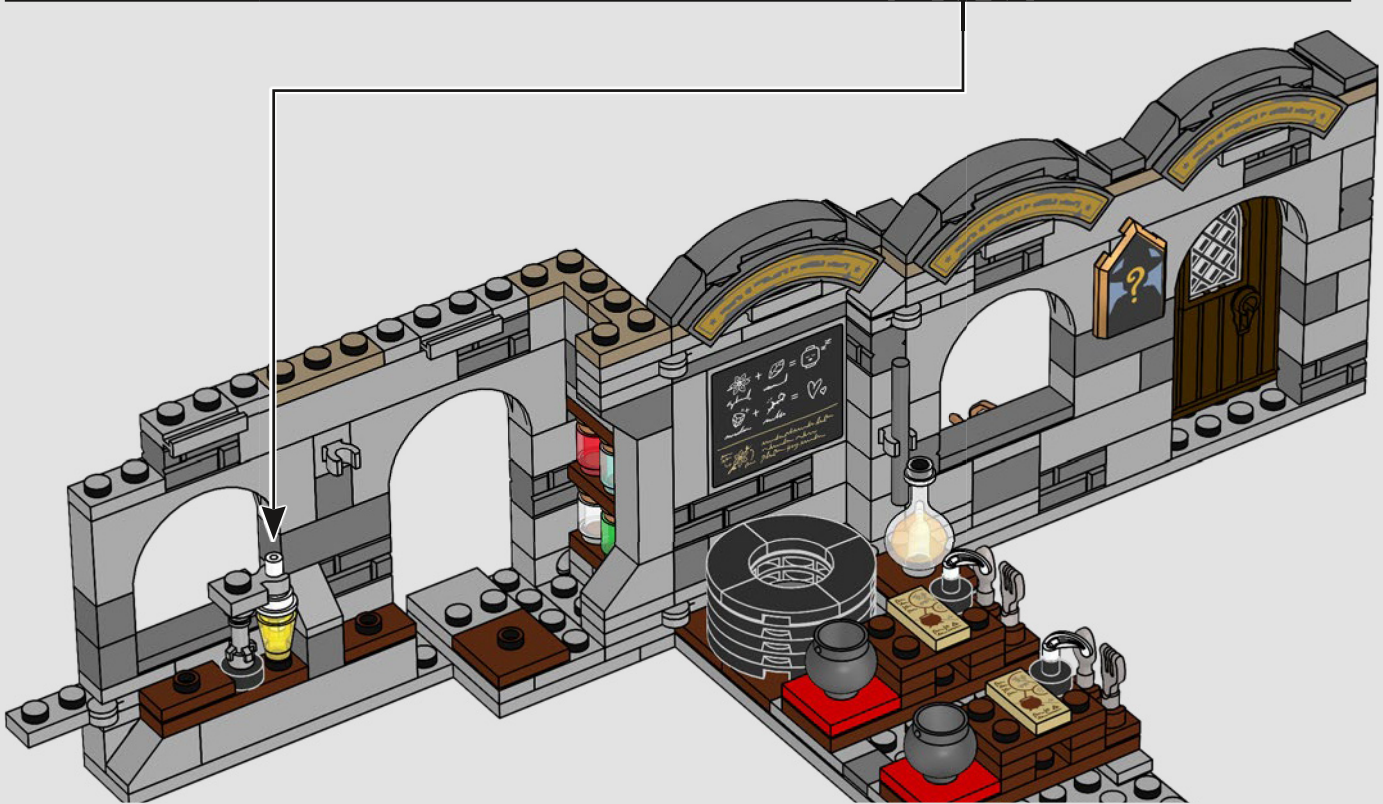



68



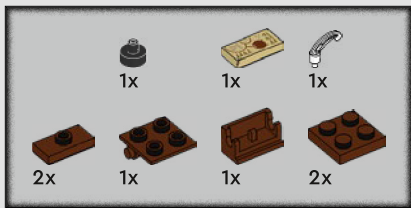

69

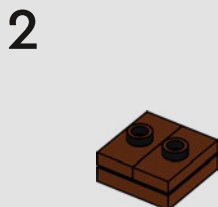
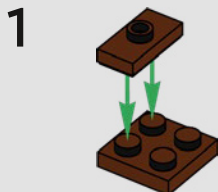

3

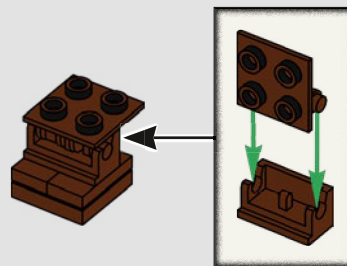

4

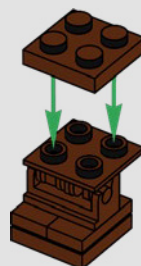

5



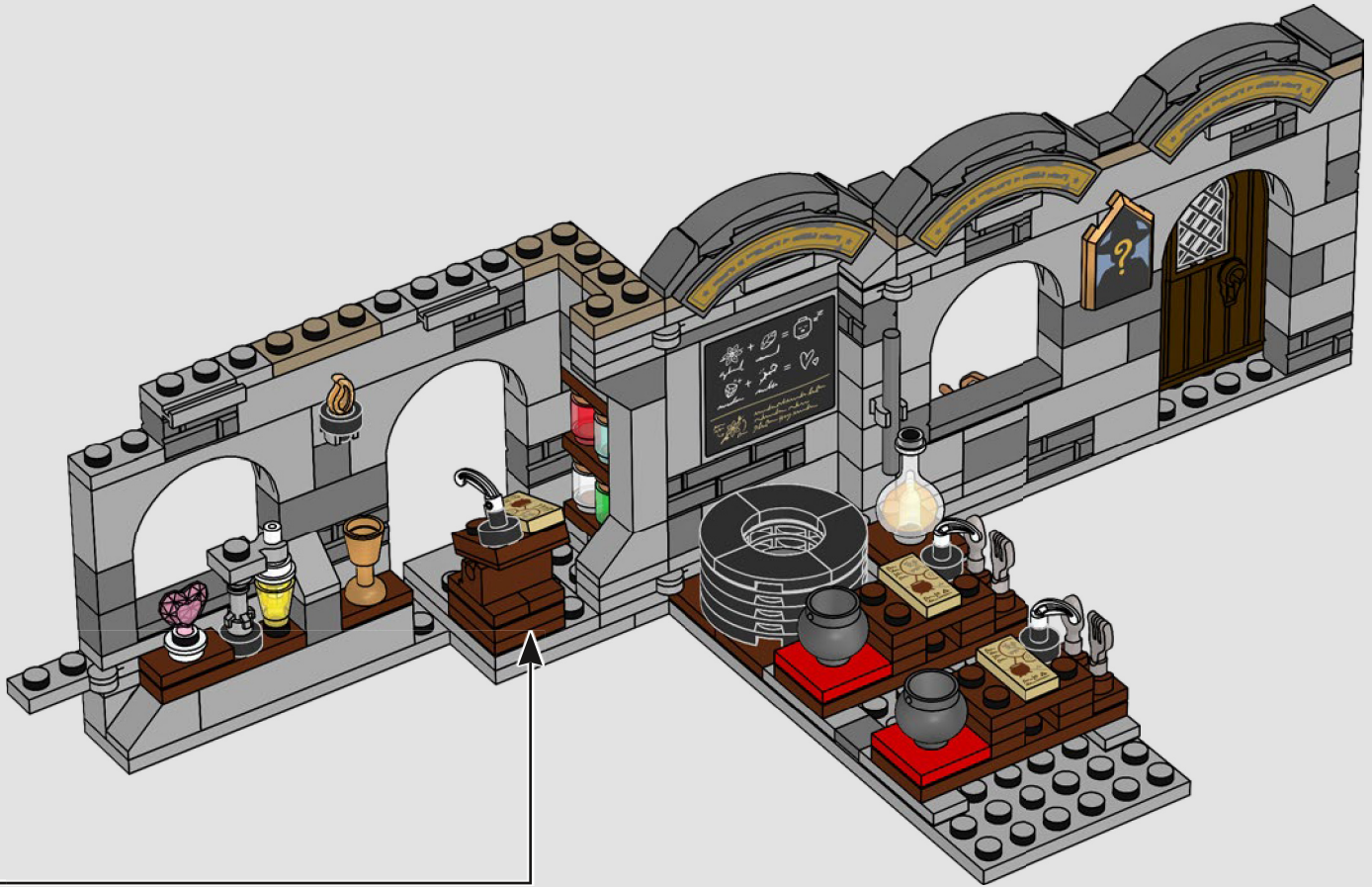

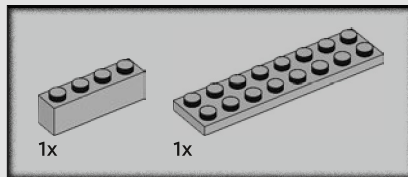
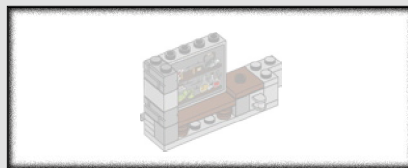

70

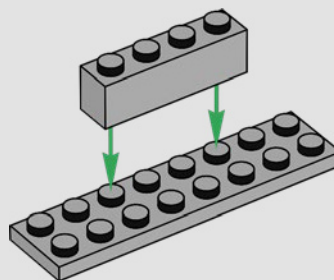

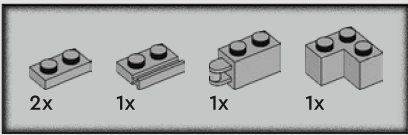

71

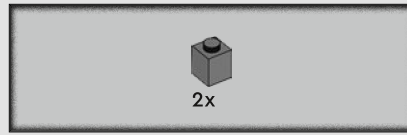
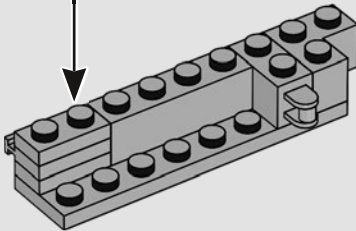
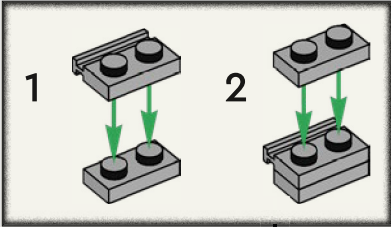

72

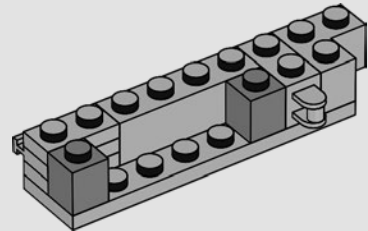

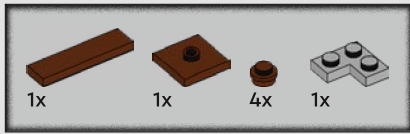

73

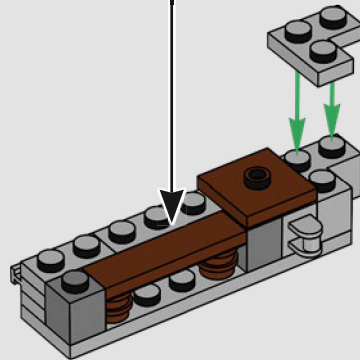
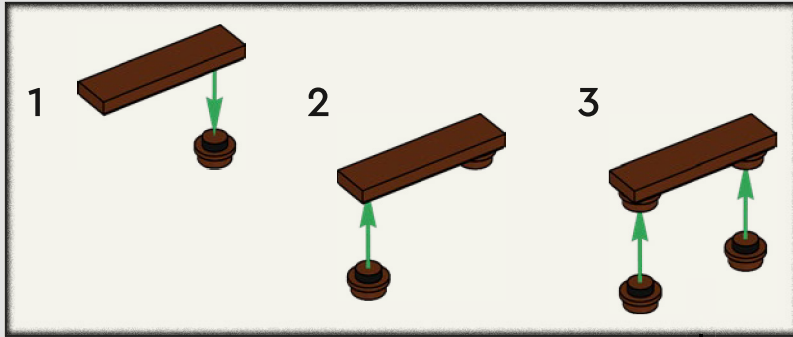

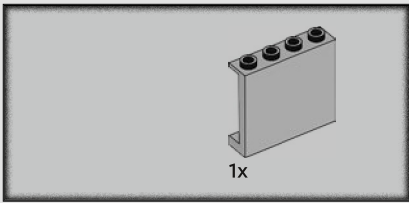

74

1

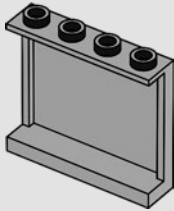

2



3

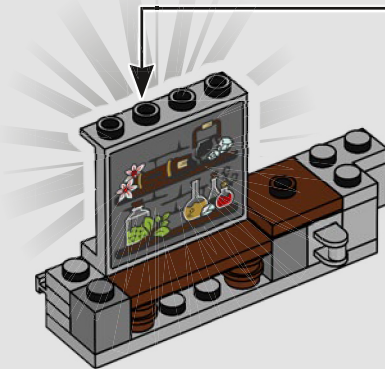

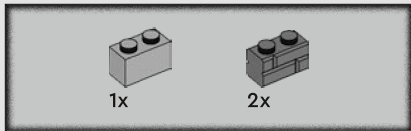

75

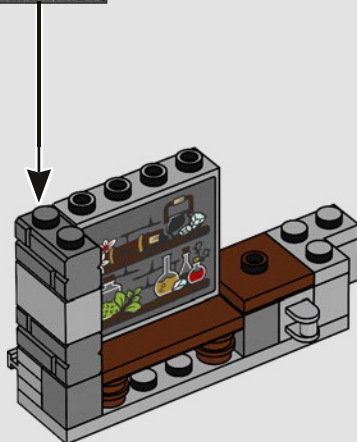
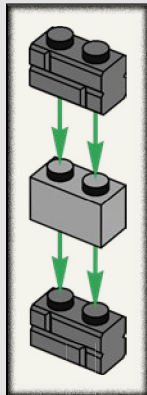

76

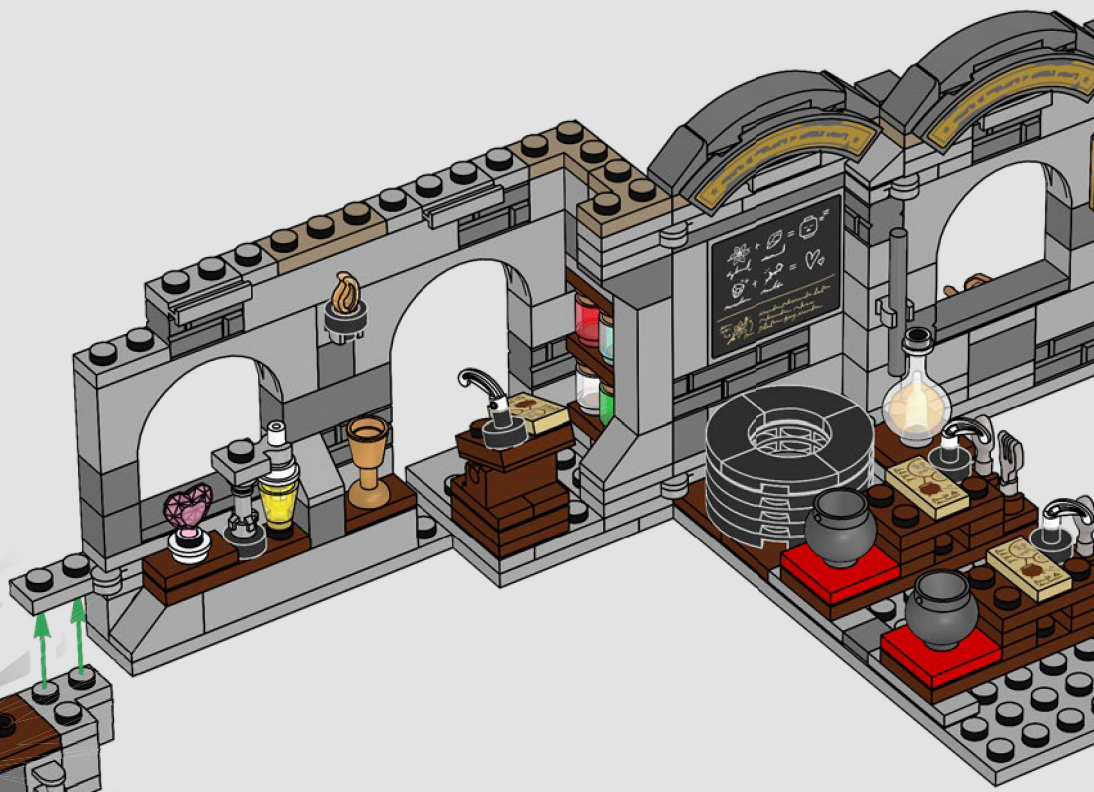



1x

77



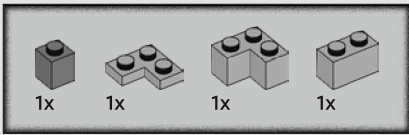

78

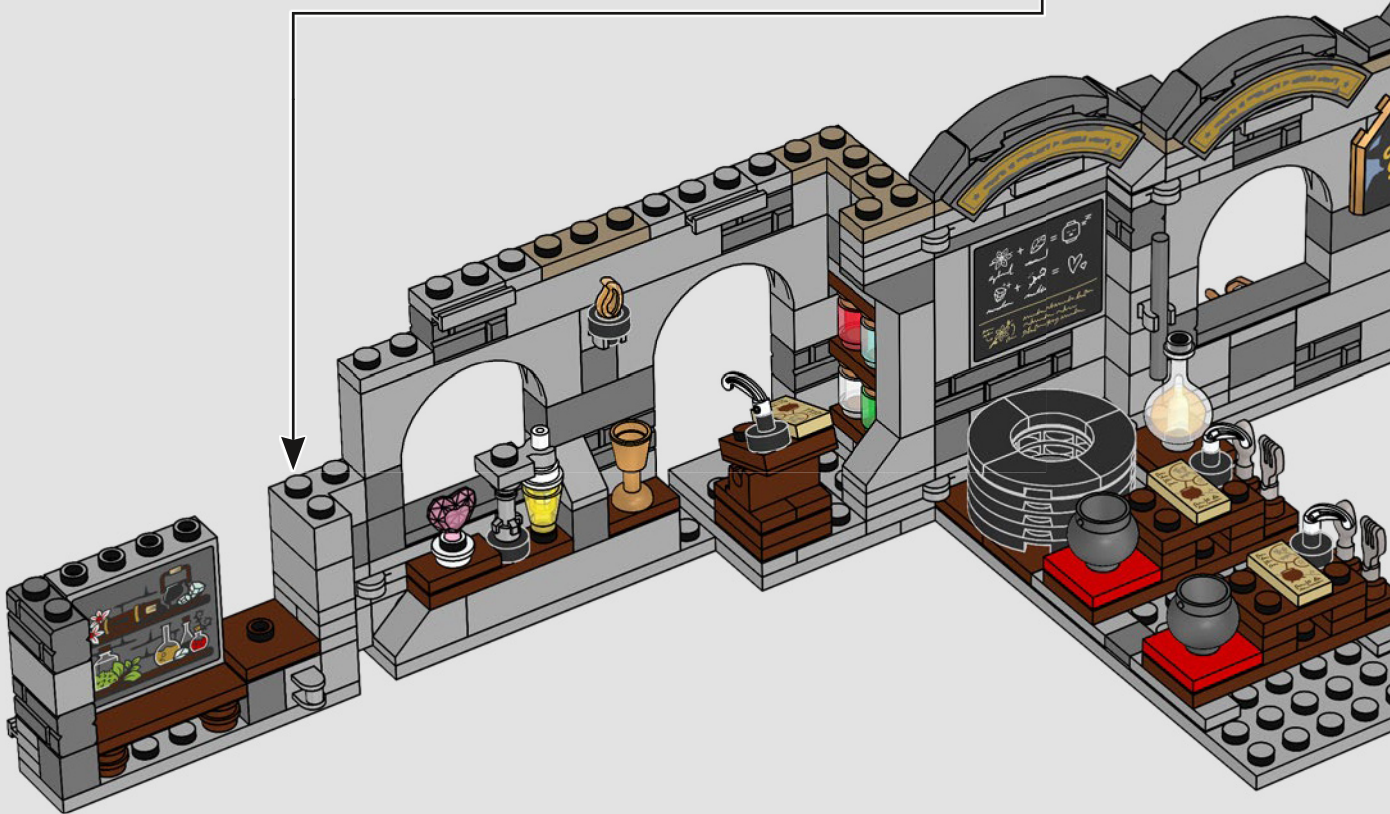
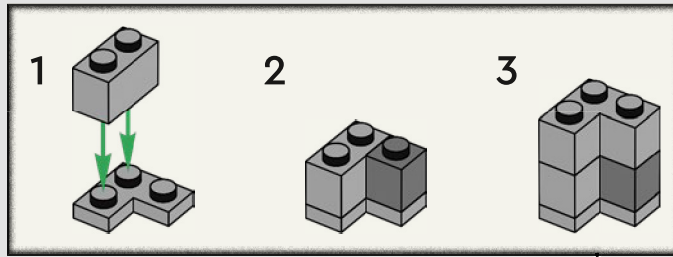

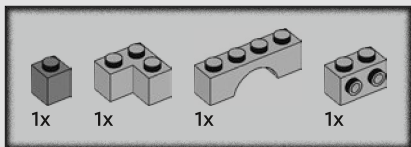

79

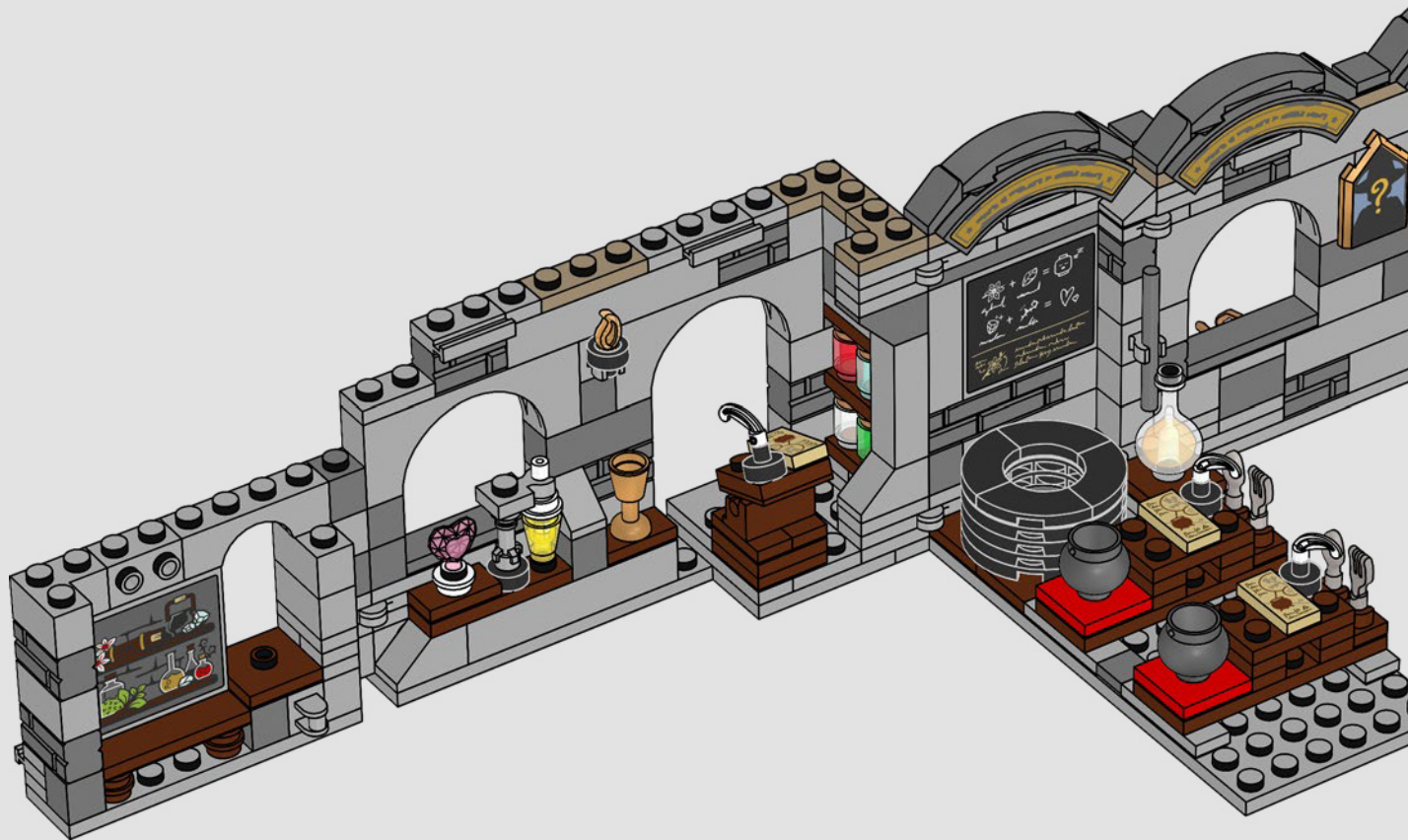

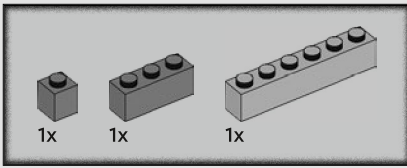

80

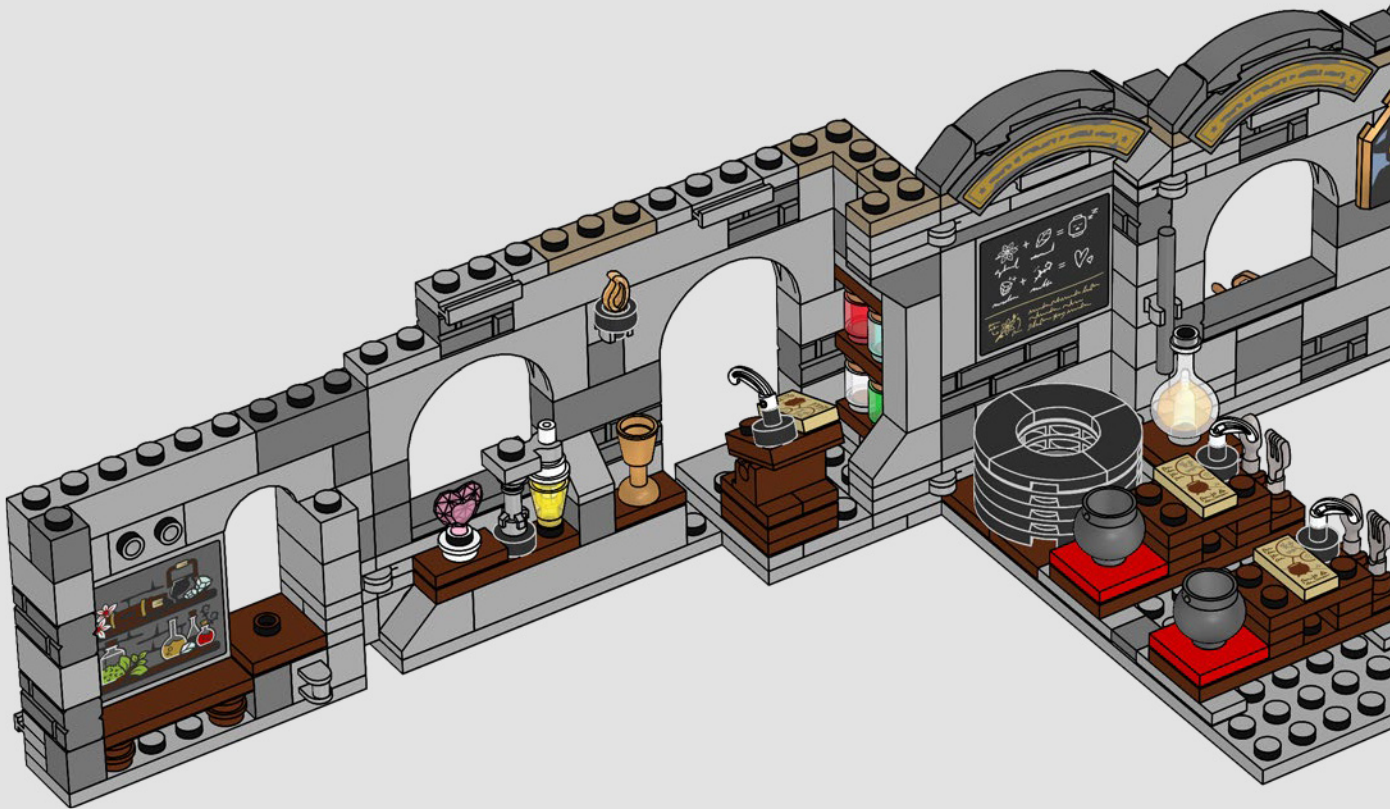

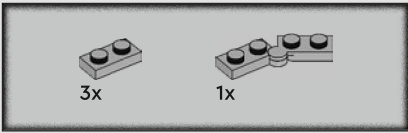

81

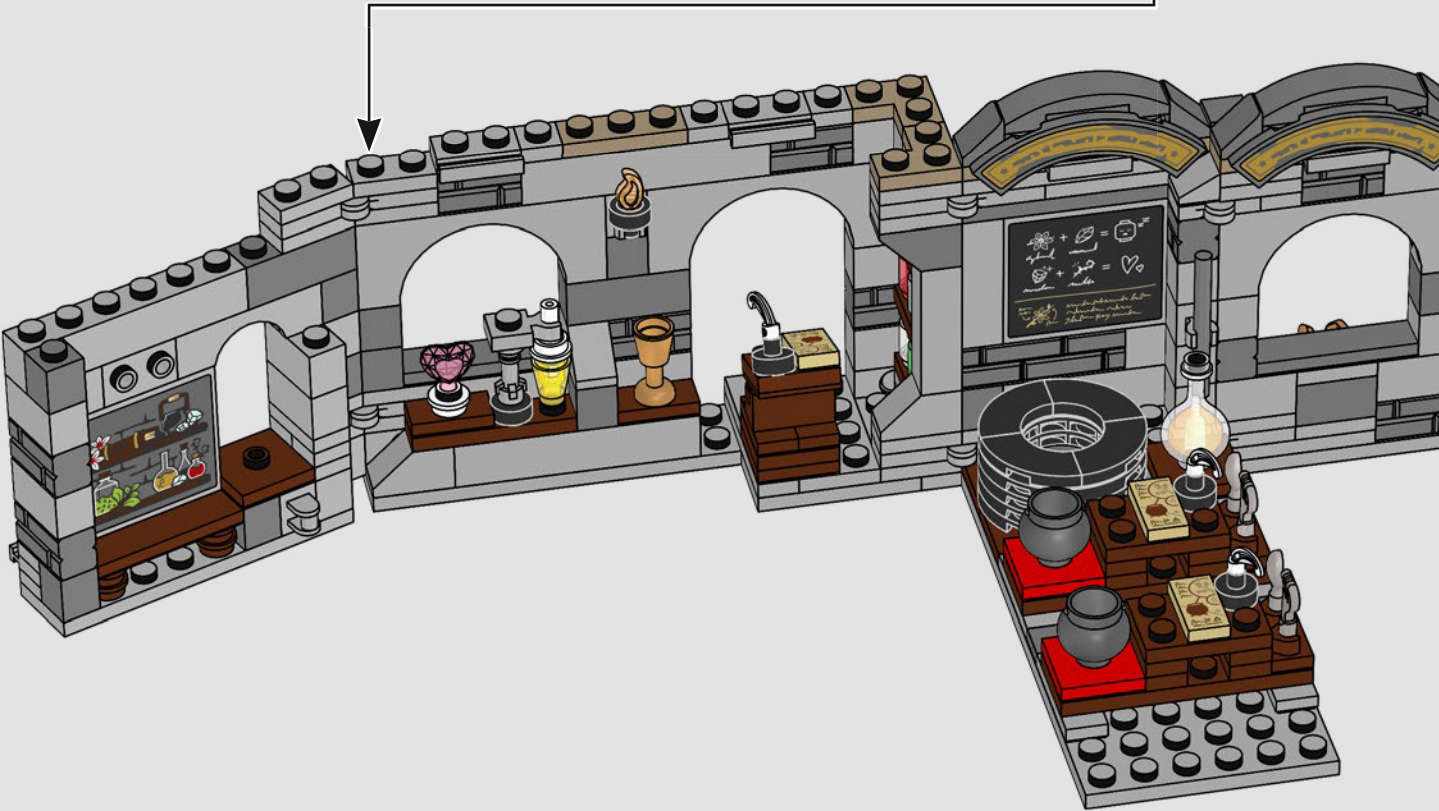
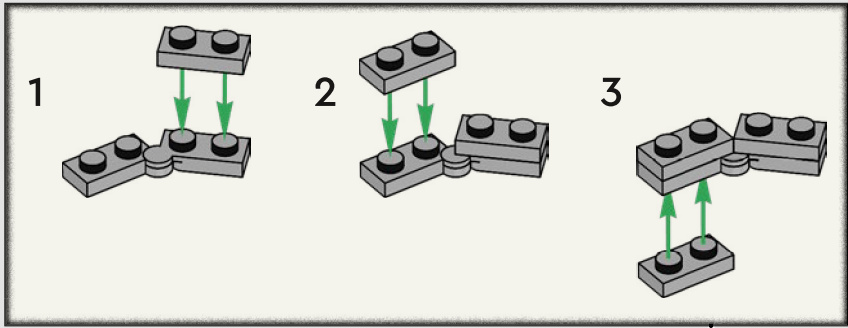

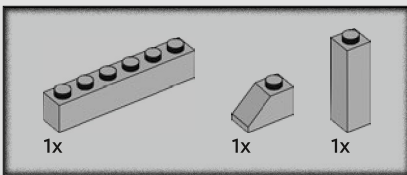

82

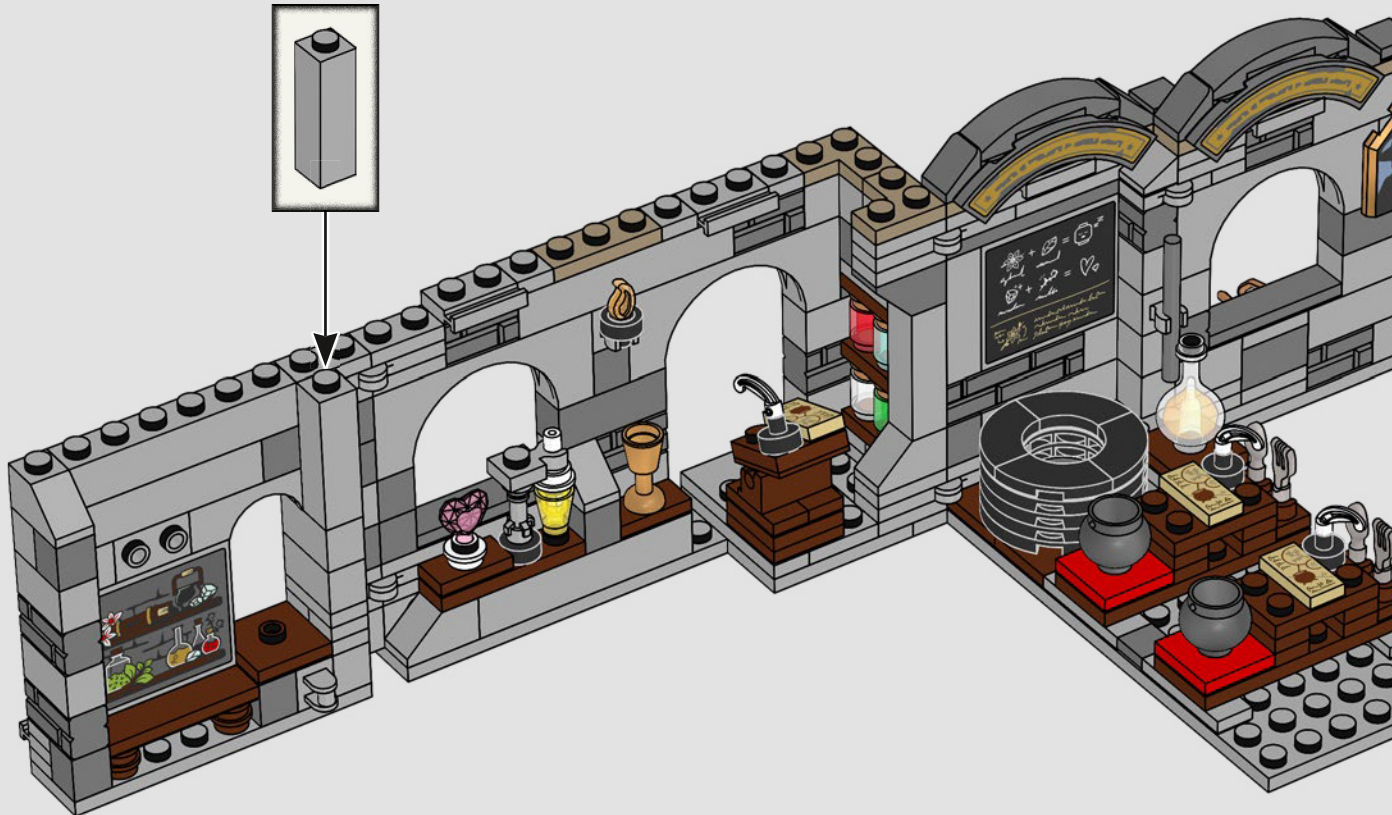
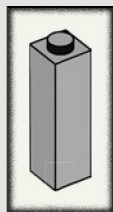

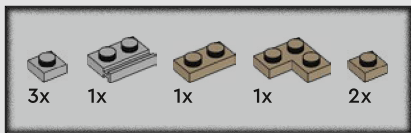

83

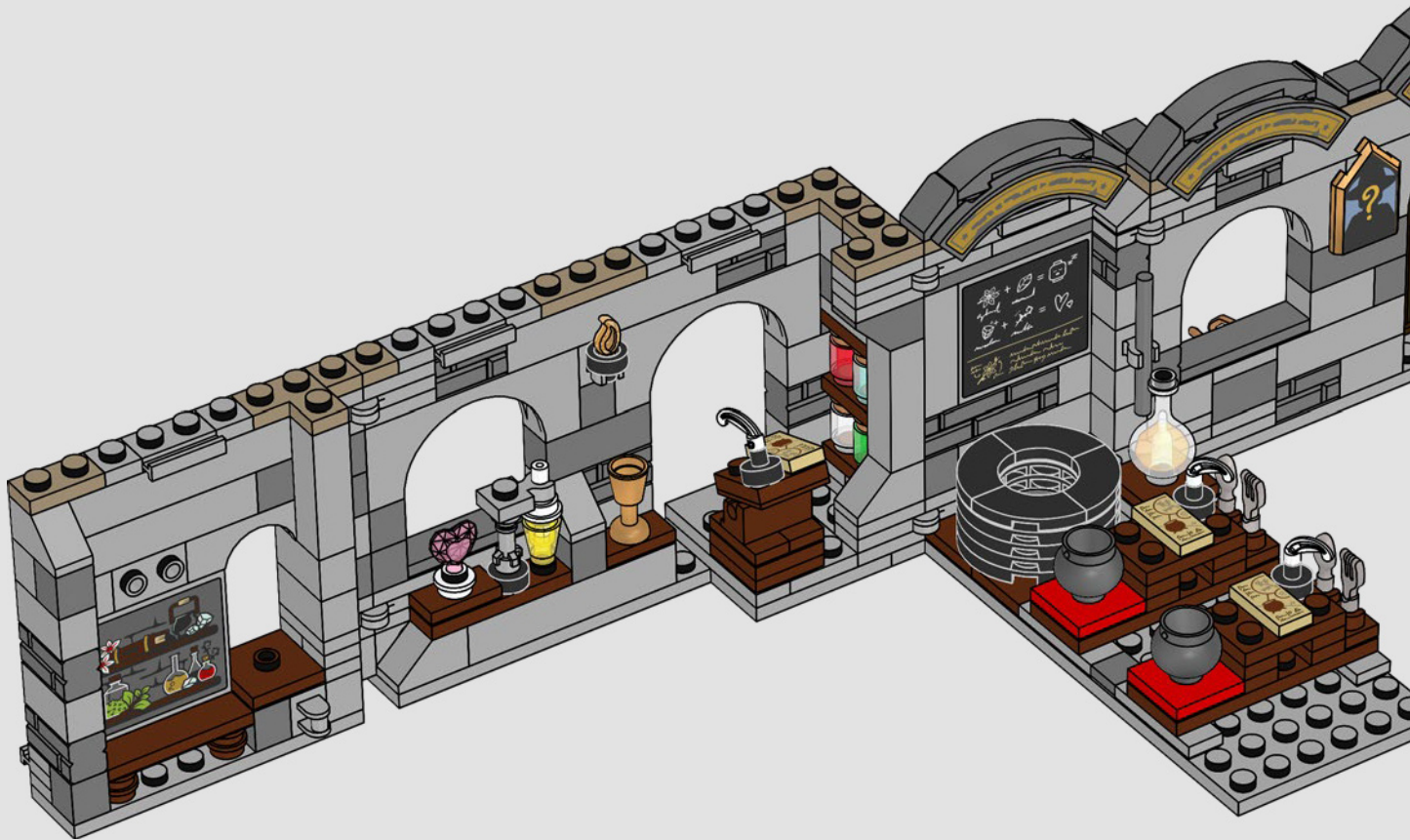

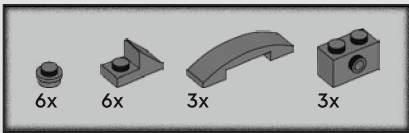

84

1

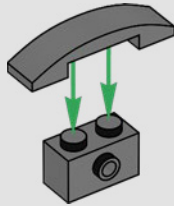

2

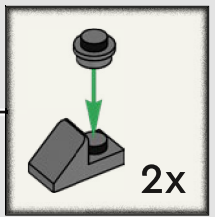
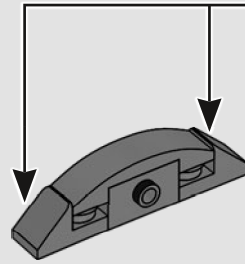

3x



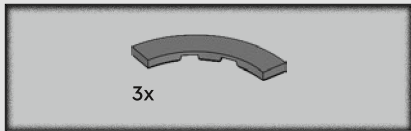

85

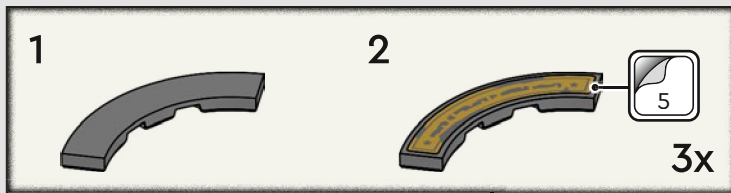

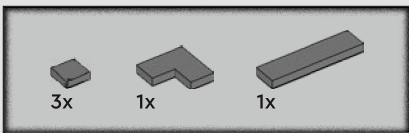

86



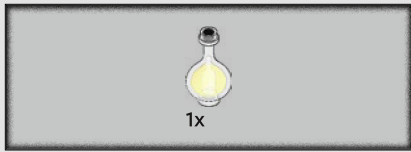

87



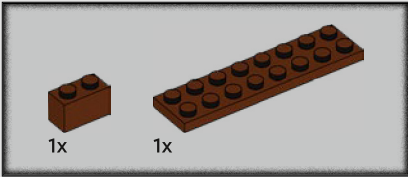

88

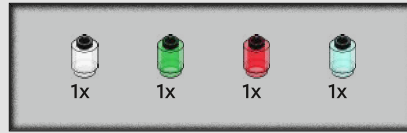
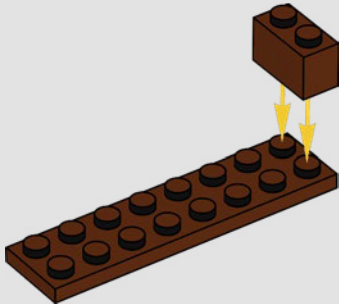

89

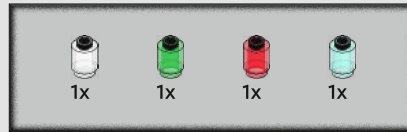
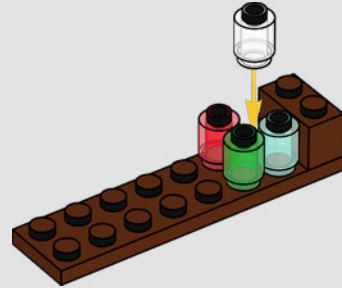

90

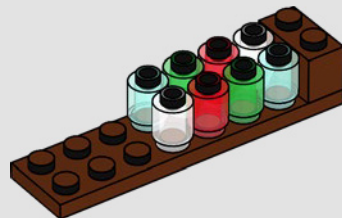

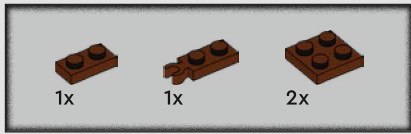

91

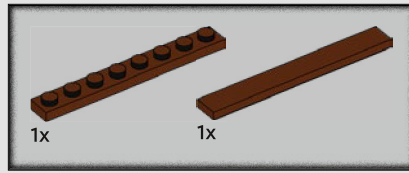
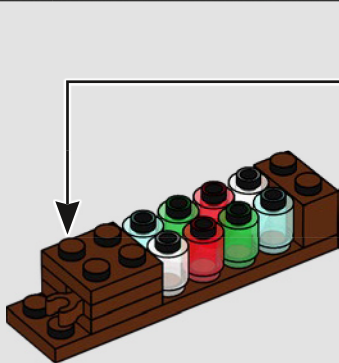
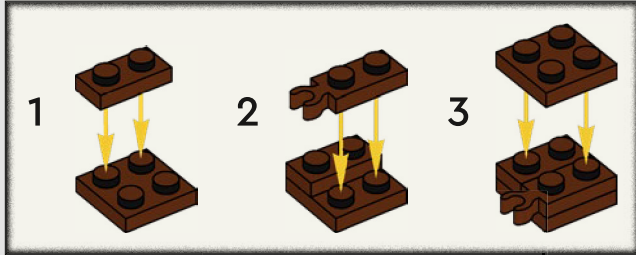

92

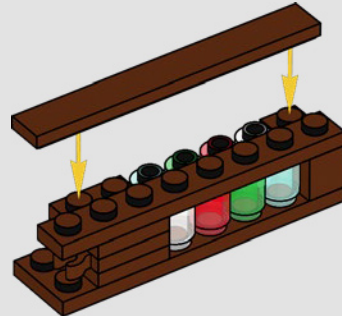

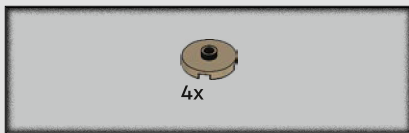

93

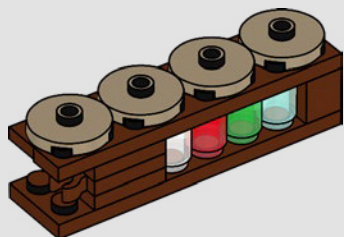

94

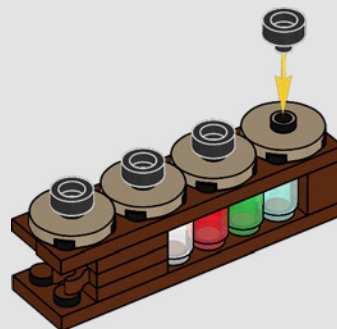

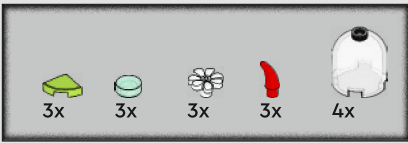

95

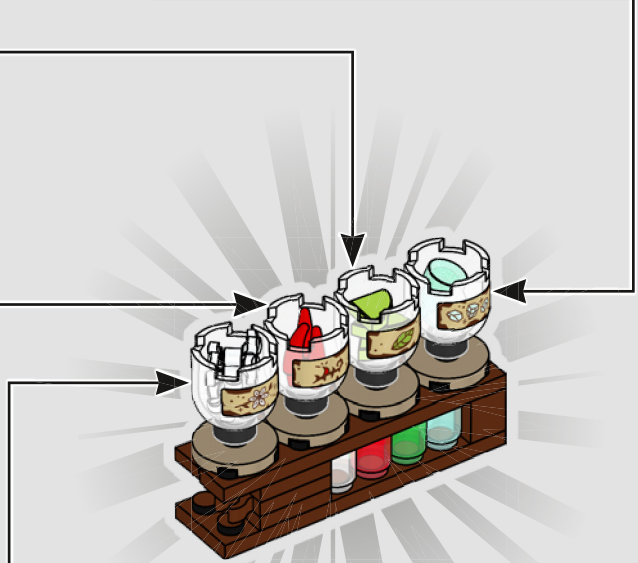
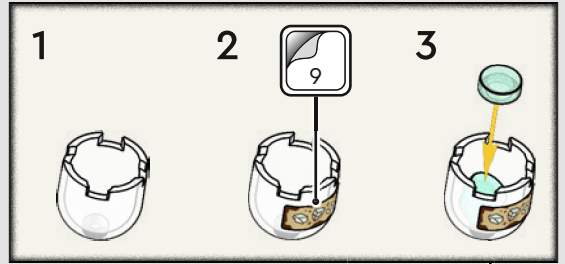
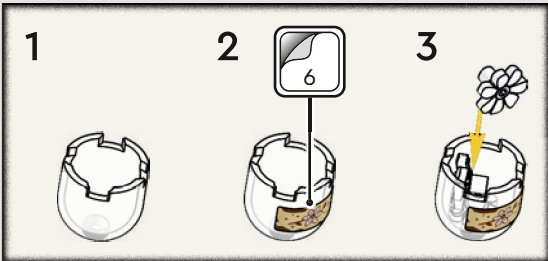
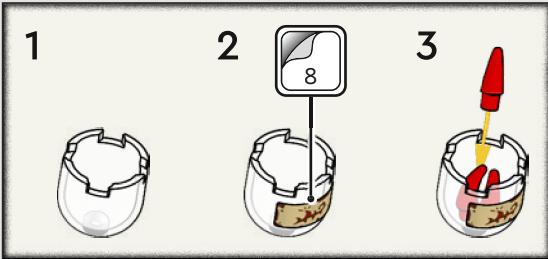
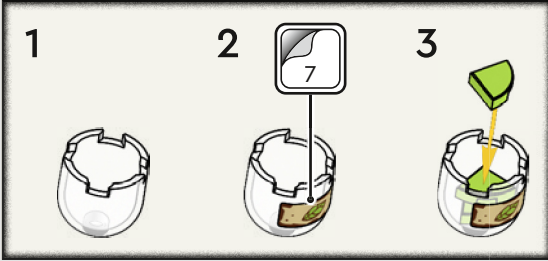





97



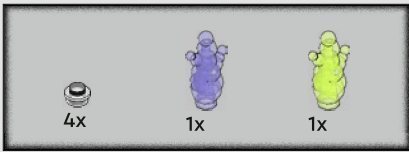

98

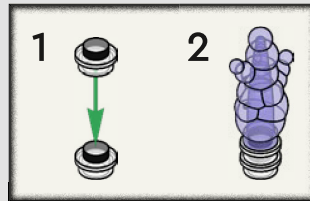
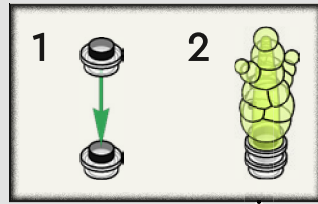











Harry Potter

WIZARDING
WORLD



76435



76426



Each set sold separately and available for different periods of time /
Jedes Set ist separat und in unterschiedlichen Zeiträumen erhältlich.
/ Chaque set est vendu séparément et sera disponible à des périodes
différentes. / Ogni set è venduto separatamente ed è disponibile per
periodi di tempo diversi. / Cada set se vende por separado y está
disponible durante un cierto período de tiempo. / Os sets são vendidos
separadamente e estão disponíveis por diferentes períodos de tempo.
/ 每款套装于不同时间段单独出售。 / Zestawy są sprzedawane
osobno i są dostępne w różnym czasie / Každá stavebnice se prodává
samostatně a je k dispozici v různých časových obdobích / Každá
stavebnice sa predáva samostatne a je k dispozícii v rôznych časových
obdobiach / Minden egyes készlet külön-külön és más-más időszokban
kapható. / Seturile se vând separat și sunt disponibile pentru perioade
diferite de timp / Всеки комплект се продава отделно и е наличен
за различен период от време. / Katrs komplekts tiek pārdots
atsevišķi, un to pieejamības periodi atšķiras. / Kõik komplektid on
müügil eraldi ja saadaval erinevates ajavahemikes. / Kiekvienas rinkinys
parduodamas atskirai ir tik ribotą laiką



Build the most detailed HOGWARTS™ CASTLE



76430

76431

Baue das detailreiche Schloss Hogwarts™ / Construisez le château de Poudlard le plus détaillé / Costruisci il Castello di Hogwarts™ più dettagliato di sempre / Construye el Castillo de Hogwarts™ más detallado / Construa o mais detalhado Castelo de Hogwarts™ / 拼搭精美的霍格沃茨™城堡 / Zbuduj najbardziej szczegółowy zamek Hogwarts™ / Postavte si ten najdetailnejší Bradavický hrad / Postavte si najdetailnejší Rokfortský hrad / Építsd meg a legrészletgazdagabb Roxfort™ kastélyt! / Construieste cel mai detaliat Castel Hogwarts™ / Постройте най-детальнату версію на замька Хорьопре / Uzbüve visdetałizētako Čūkkārpas pili / Pane kokku kõige üksikasjalikum Sigatüüka™ loss / Sukonstruokite neparastai detaļiā Hogvartso piļi

9x
6186675

1x
6270027

1x
6173105

1x
4568933

1x
4596914

2x
6378773

1x
6308975

2x
6359881

4x
6191630

1x
6323536

2x
6353176

1x
6488941

94

3x
6167800

1x
4515350

1x
6270031

4x
4549436

4x
6132767

2x
4528604

4x
4550168

2x
6132768

1x
6270032

1x
6266865

1x
6254792

1x
4539481

3x
6061702

15x
4211399

1x
4558953

4x
6345426

1x
6296894

18x
4211398

2x
4211440

4x
4211614

10x
4211388

1x
6015344

7x
4211568

1x
6198932

7x
4211353

1x
6212077

11x
4211349

1x
4211397

2x
6211969

2x
4558169

1x
4211396

3x
4211445

1x
4211435

3x
4211394

2x
6059033

2x
4521921

6x
6416524

4x
4211395

4x
6106189

5x
4211393

1x
4211438

1x
4211795

1x
4211406

2x
4662161

1x
4293831

13x
4210633

18x
4211098

7x
4210848

1x
6056296

7x
6473748

14x
6000311

1x
4211096

12x
6069164

1x
4211052

1x
4543086

1x
6247784

4x
4211104

1x
6378143

3x
4211053

6x
4648256

1x
6055310

1x
6413109

6x
6458171

4x
4216581

1x
6112609

4x
6337003

1x
6403106

4x
6092590

1x
6186045

1x
4211149

4x
6221608

10x
4211150

2x
4211151

1x
6459597

4x
4565394

4x
4216695

1x
6167644

2x
4211189

1x
4211190

1x
4211194

2x
4211247

1x
4216945

1x
4585337

1x
4211211

3x
6211875

2x
6168642

3x
6406415

3x
6452532

1x
6357680

3x
6329369

3x
6270107

2x
6126048

1x
6486012

1x
6486013

1x
6235092

1x
6236271

4x
6240030

3x
6223655

4x
6286876

3x
6238673

3x
6238677

1x
6337597

1x
6357747

3x
6299900

3x
6238046

1x
6240042

1x
6475330

1x
6490873

1x
6477295

1x
6490522

1x
4505990

2x
6478297

4x
6167641

1x
6234805

2x
6363148

2x
6361354

2x
6363146

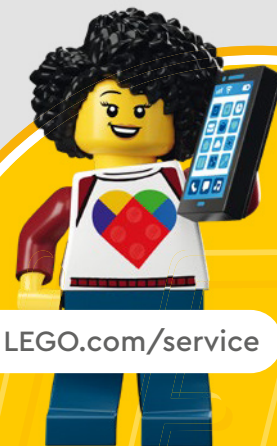

 [LEGO.com/service](https://www.LEGO.com/service)

FEEDBACK & REWARD

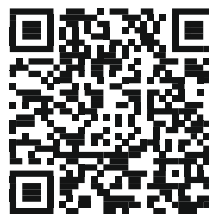

Scan this QR code or go to **LEGO.COM/PRODUCTSURVEY** and share your feedback about this LEGO® set. You will receive a free digital reward at the end of the survey via download link.



EN: FEEDBACK AND REWARD. Share your feedback and receive a free digital reward. **DE: FEEDBACK MIT BONUS.** Teile dein Feedback und erhalte einen digitalen Bonus geschenkt. **FR: AVIS ET RÉCOMPENSE.** Donnez votre avis et recevez une récompense numérique gratuite. **IT: DAI LA TUA OPINIONE E VINCI.** Condividi il tuo feedback e ricevi un premio digitale gratuito. **ES: RECOMPENSAMOS TU OPINIÓN.** Comparte tu opinión y recibe una recompensa digital gratis. **PT: DÊ O SEU FEEDBACK E GANHE RECOMPENSAS.** Partilhe o seu feedback e receba uma recompensa digital gratuita. **ZH: 反馈有奖。** 分享您的反馈意见, 获取免费数字奖励。 **PL: WYRAŻ OPINIĘ, ODBIERZ NAGRODĘ.** Podziel się swoją opinią i odbierz cyfrową nagrodę zupełnie za darmo. **CS: ODMĚNA ZA ZPĚTNOU VAZBU.** Podělte se o zpětnou vazbu a obdržíte bezplatnou digitální odměnu. **SK: ODMENA ZA SPĚTNÚ VÄZBU.** Podel'te sa o svoj názor a získajte bezplatnú digitálnu odmenu. **HU: VISSZAJELZÉS ÉS JUTALOM.** Oszd meg véleményed az ingyenes digitális jutalomért! **RO: FEEDBACK ȘI RECOMPENSĂ.** Trimite feedback și primește o recompensă digitală gratuită. **BG: ОТЗИВИ И НАГРАДИ.** Споделете вашите отзиви и получите безплатна дигитална награда. **LV: ATSAUKSMES UN BALVAS.** Sniedz savu atsauksmi un saņem bezmaksas digitālo balvu. **ET: TAGASISIDE JA PREEMIA.** Jaga oma tagasisidet ja saad kingituseks digitaalse preemia. **LT: ATSLIEPIMAI IR ATLYGIS.** Bendrinkite savo atsiliepimą ir gaukite nemokamą skaitmeninį atlygį.

LEGO and the LEGO logo are trademarks of the LEGO Group. ©2024 The LEGO Group.

WIZARDING WORLD and all related trademarks, characters, names, and indicia are © & ™ Warner Bros. Entertainment Inc. Publishing Rights © JKR. (s24)