



# MINECRAFT

21262



2

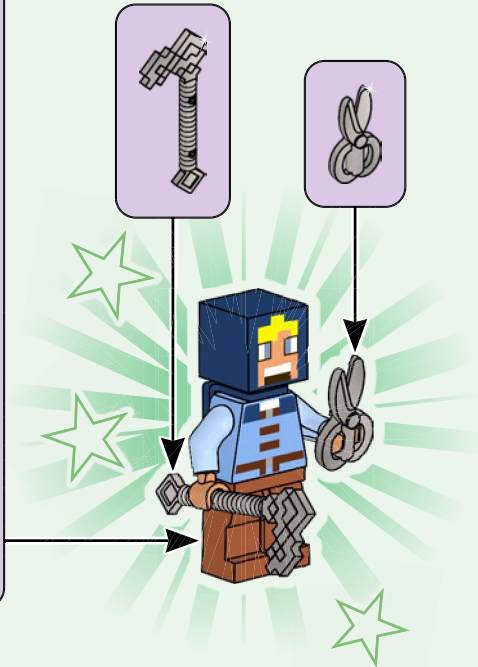
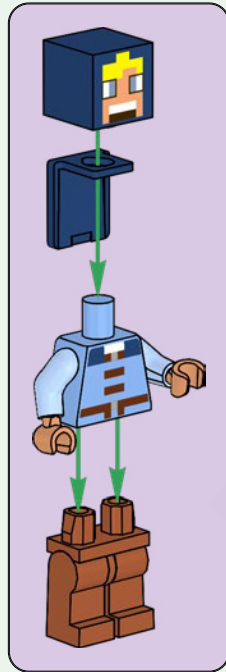

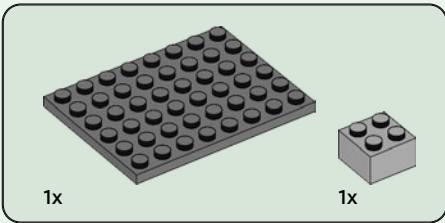
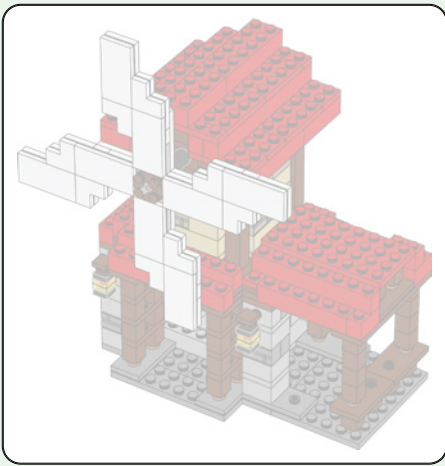

1

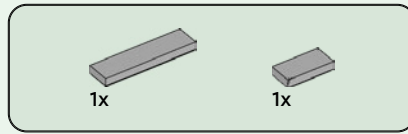
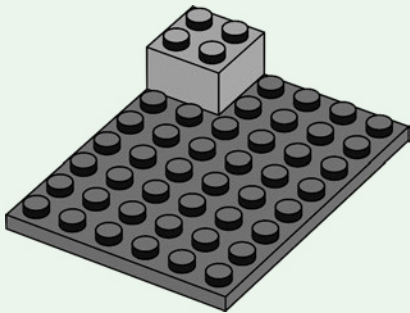

2

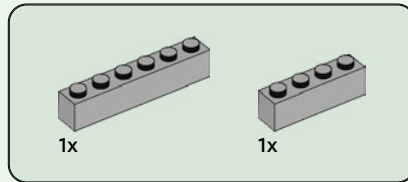
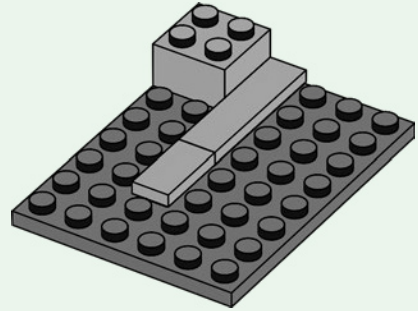

3

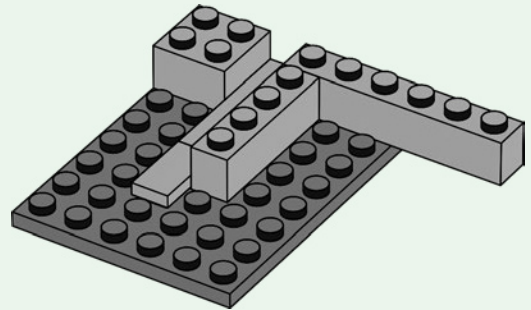

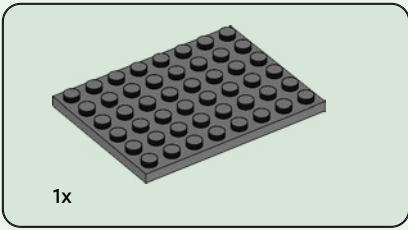

4

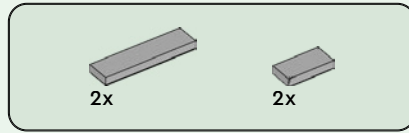
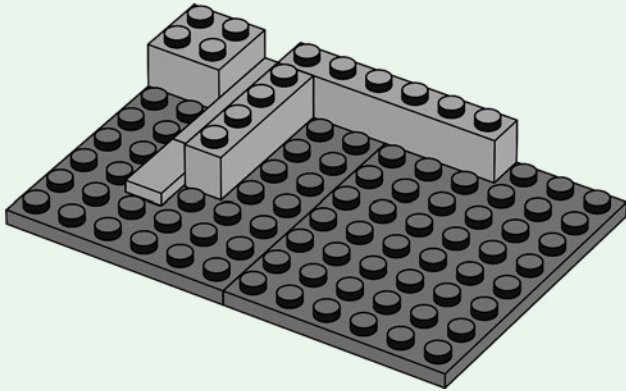

5

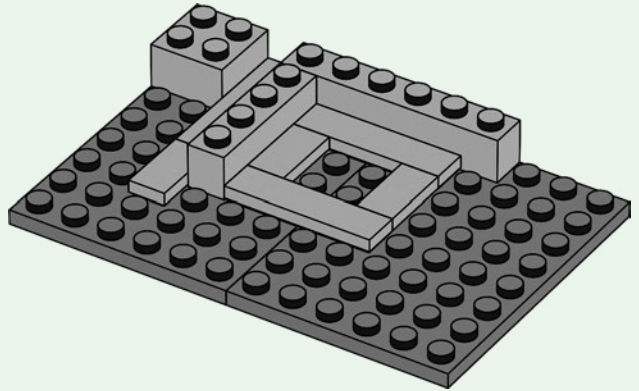



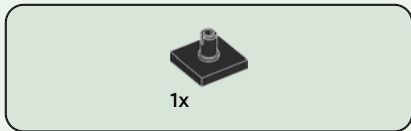

6

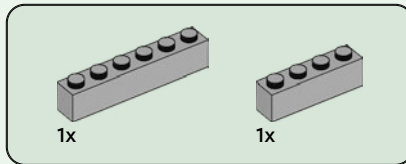
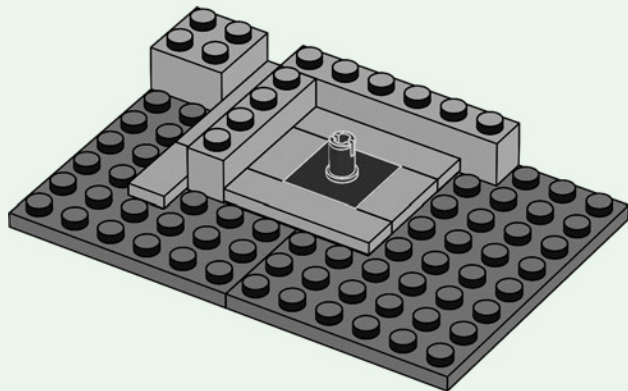

7

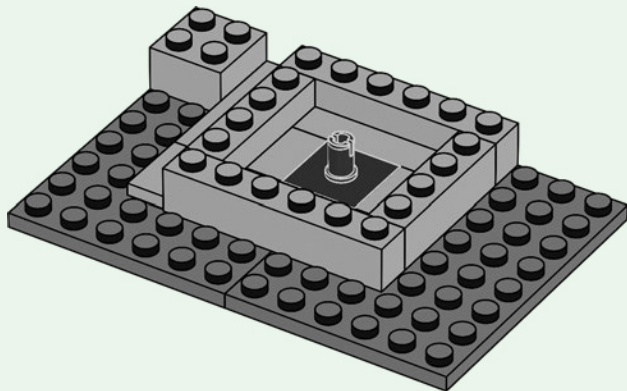

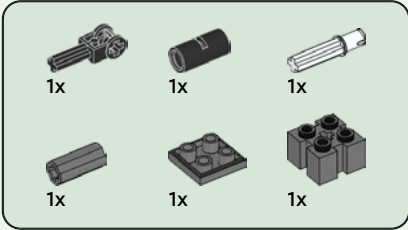

# 8

1

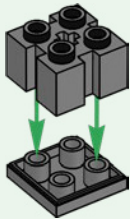

2

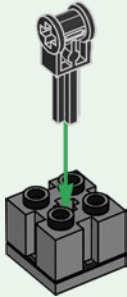

3

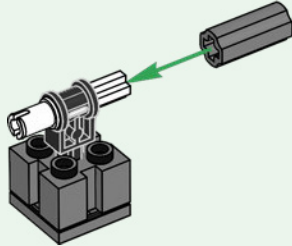

4

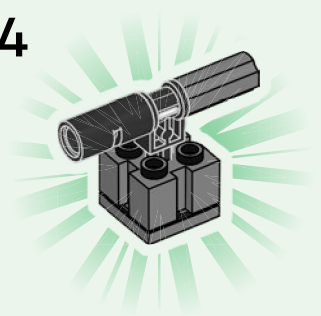

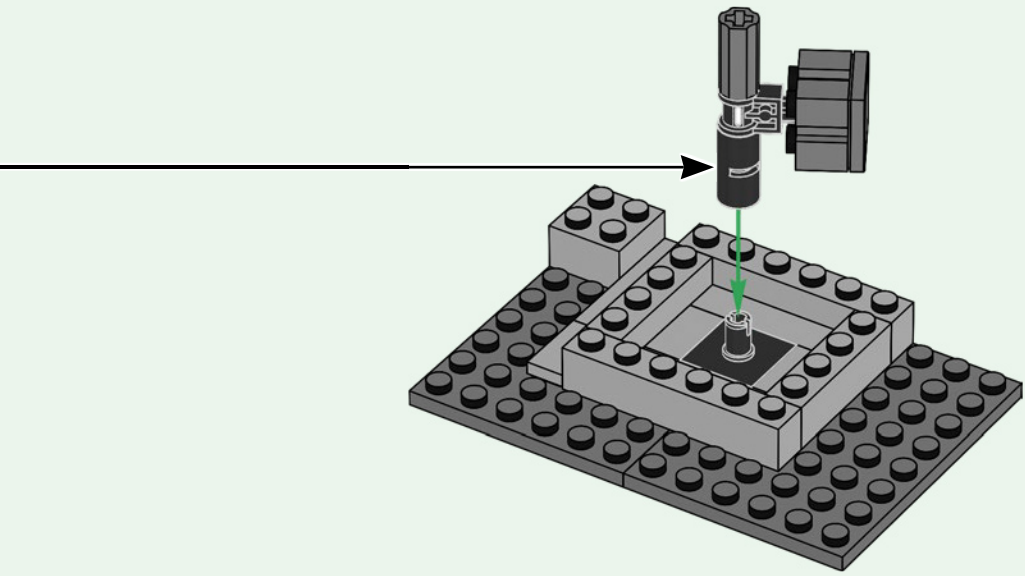

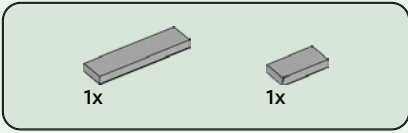

9

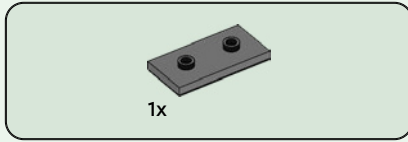
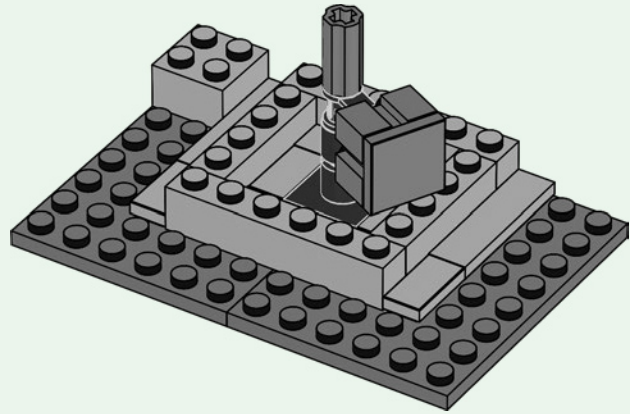

10

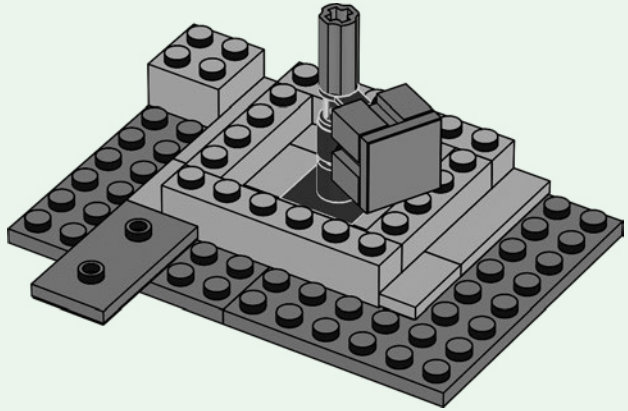

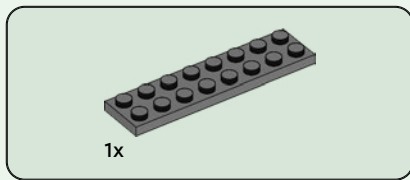

11

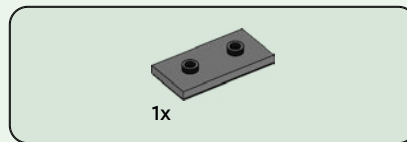
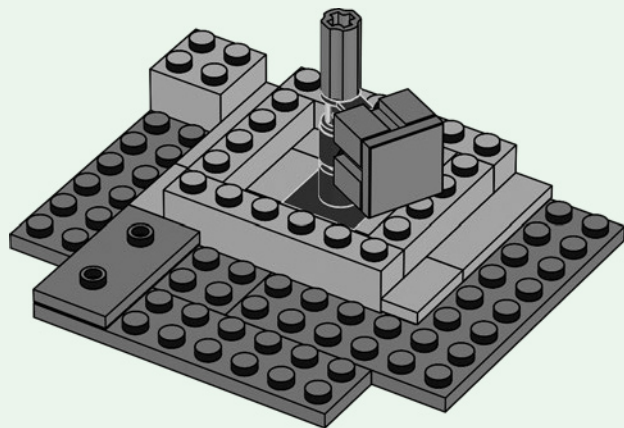

12

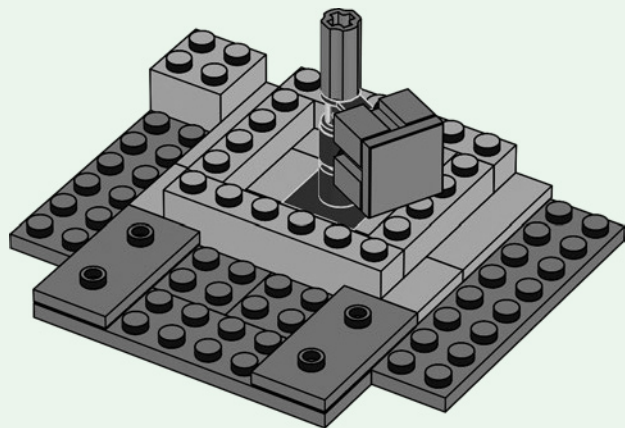

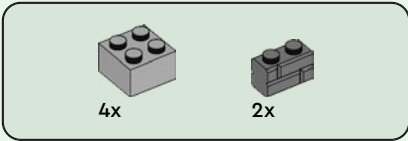

# 13

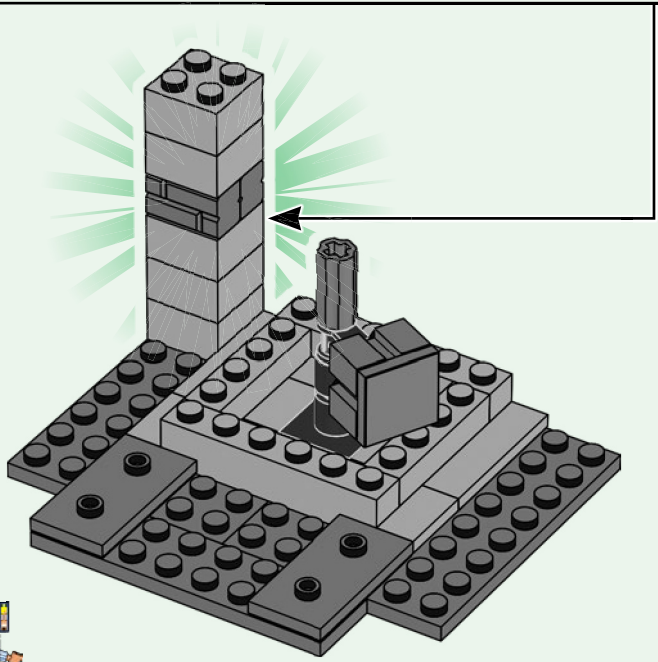
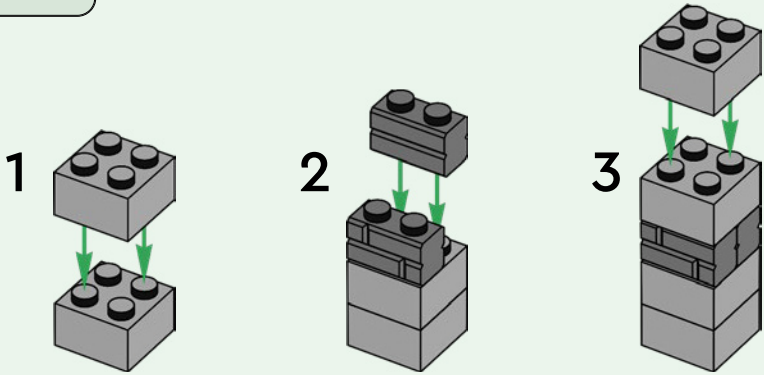



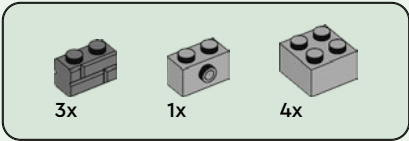

14

1

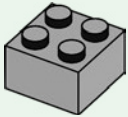

2

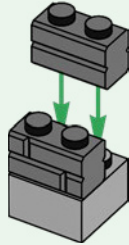

3

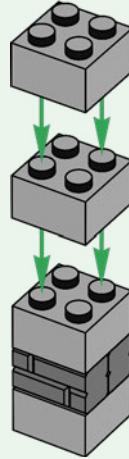

4

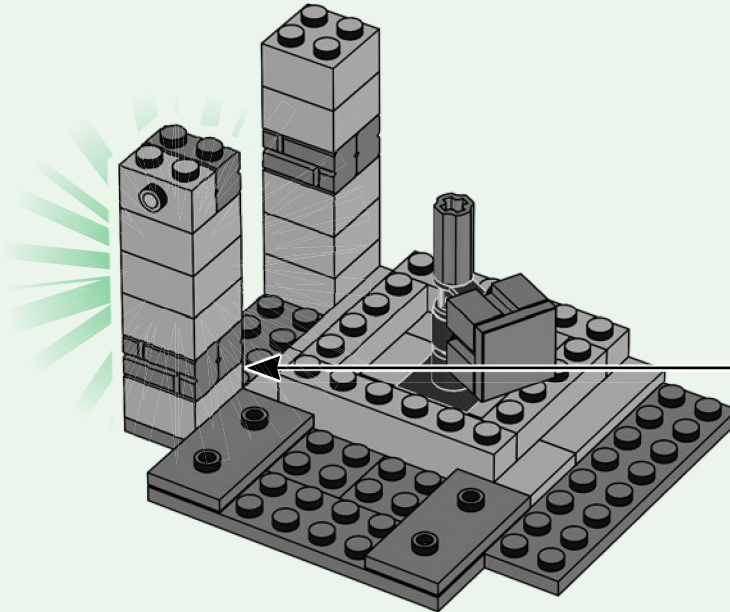
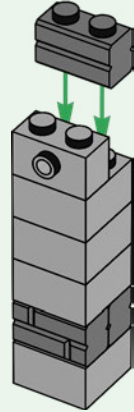

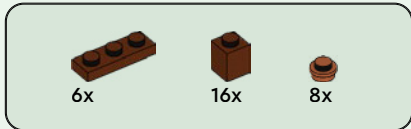

15

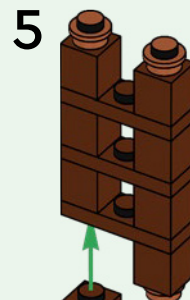
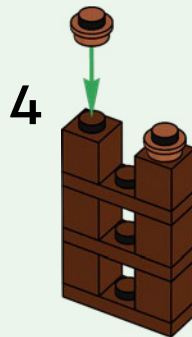
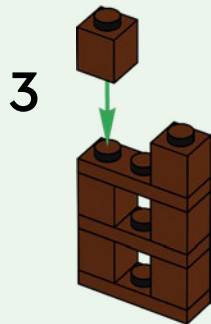
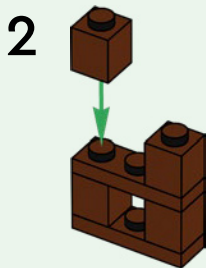
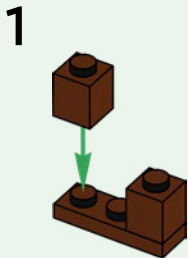

2x

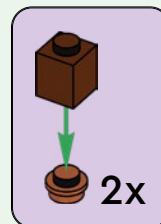

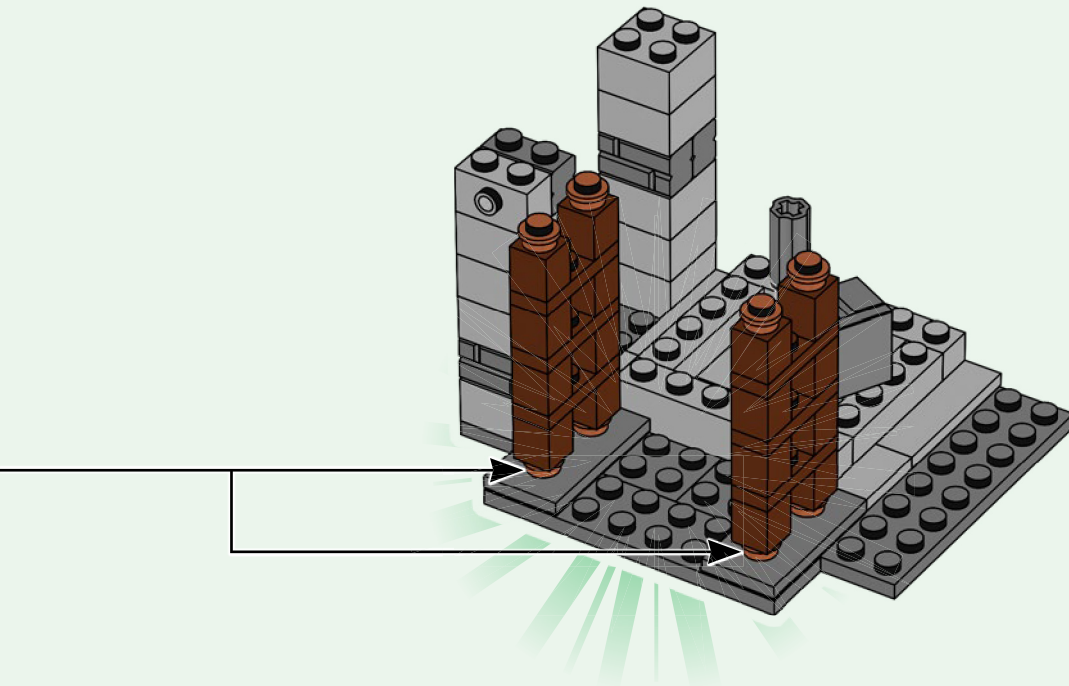

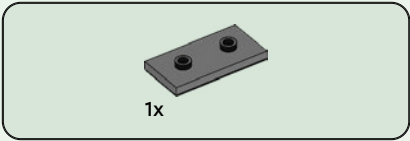

16

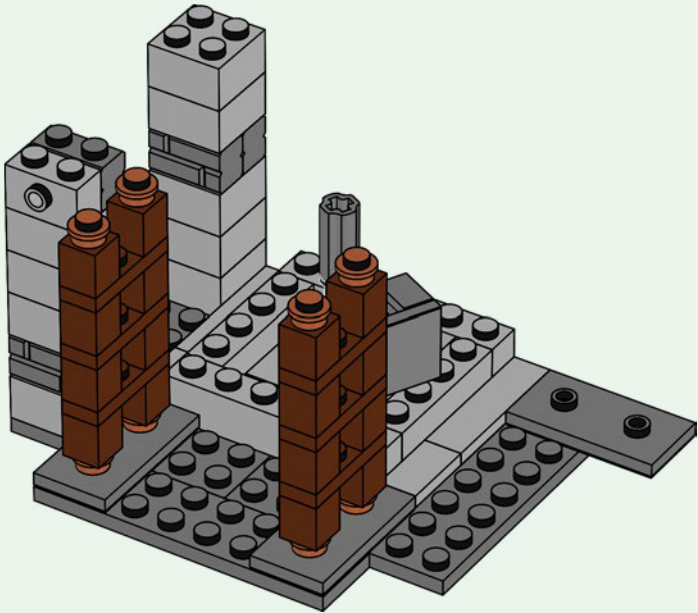



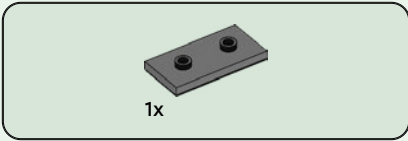

18

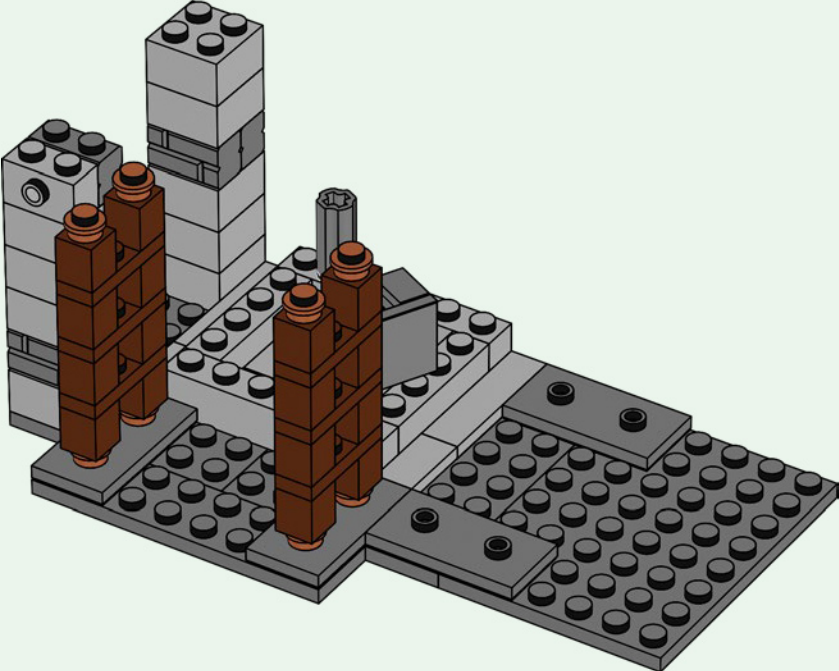



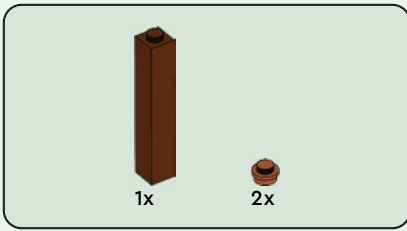

19

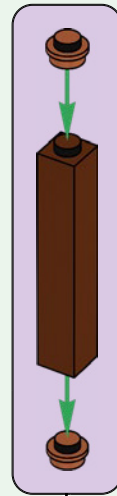
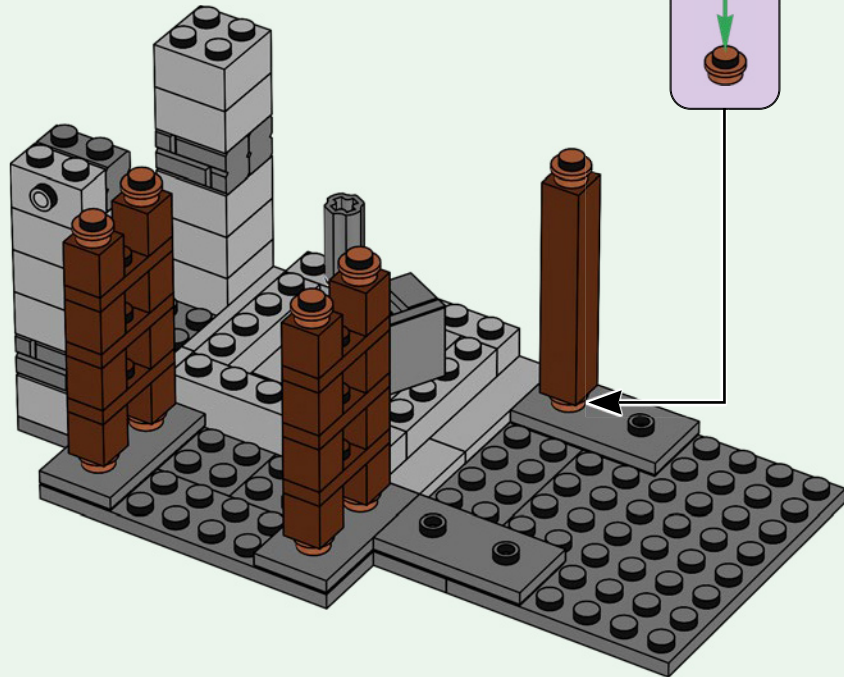

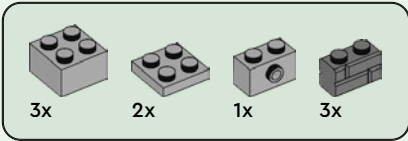

20

1

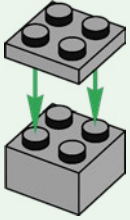

2

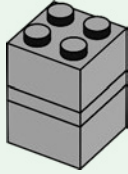

3

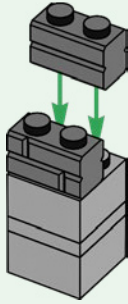

4

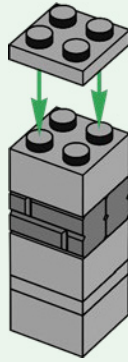

5

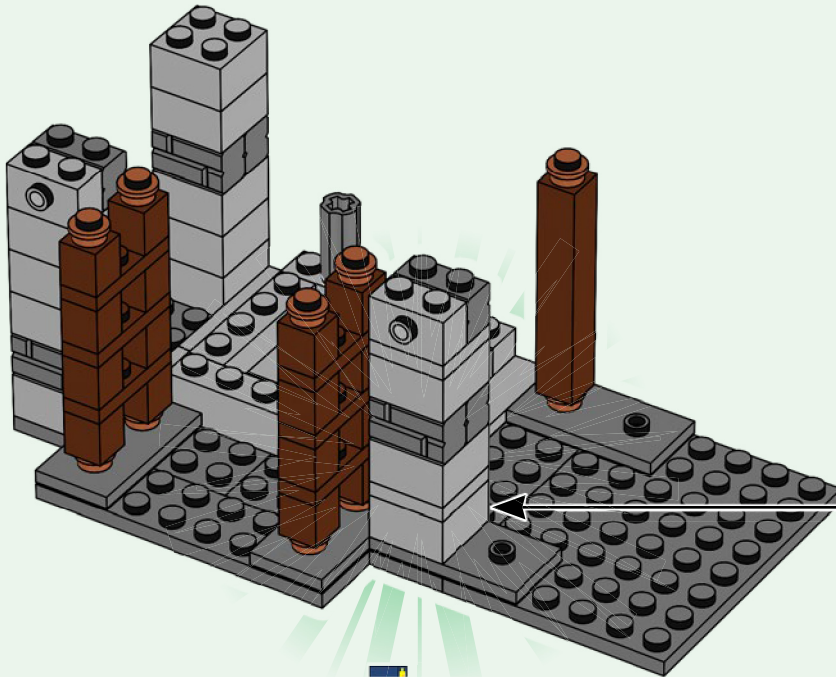
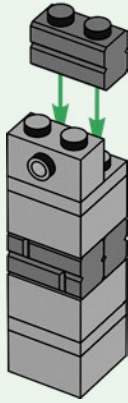

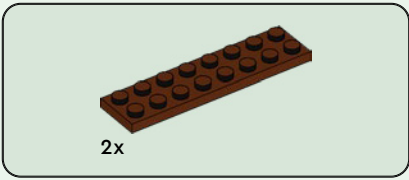

21

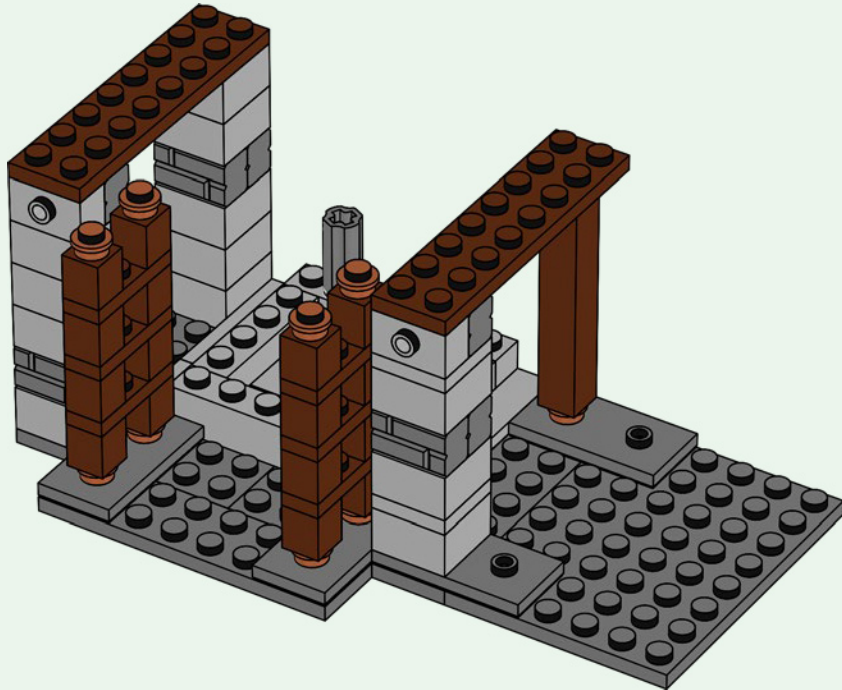

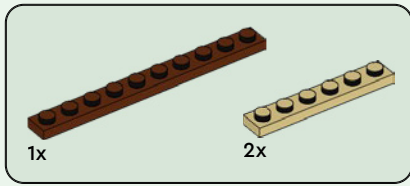

22

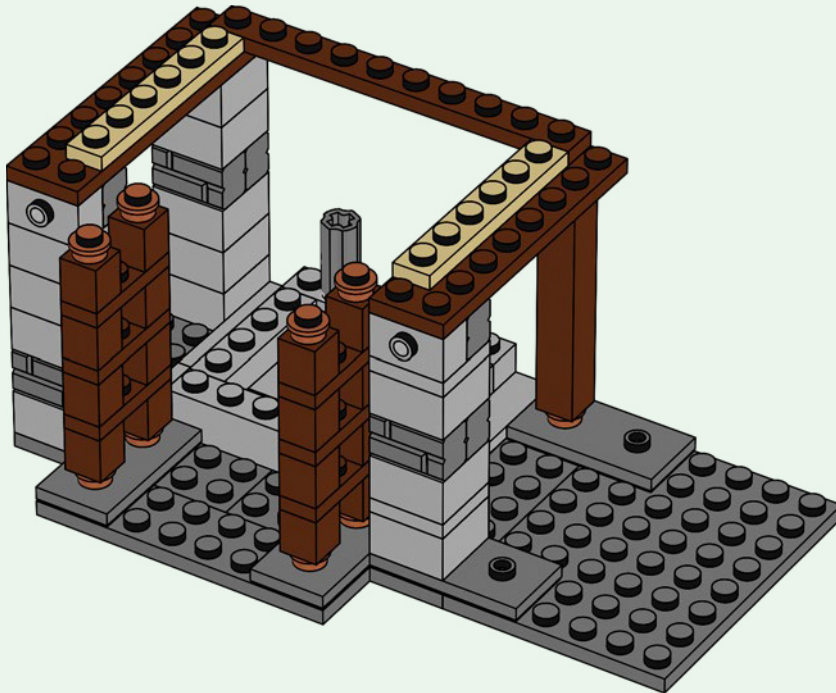



23

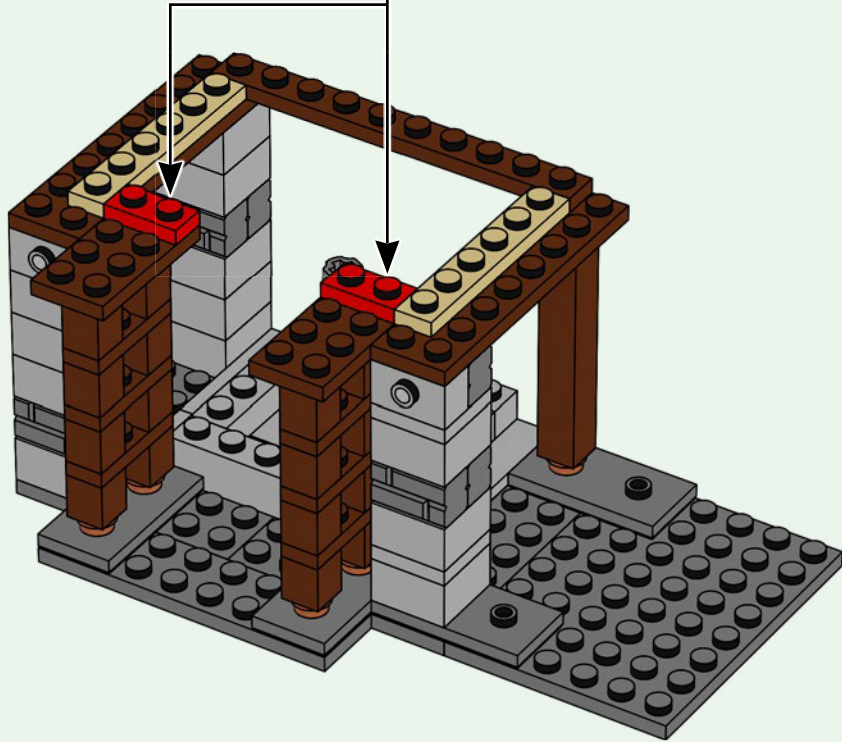
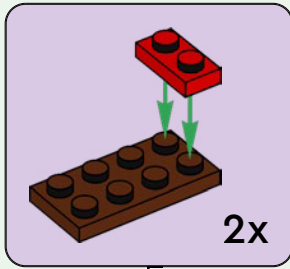

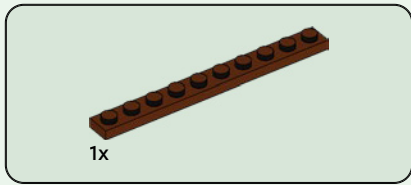

24

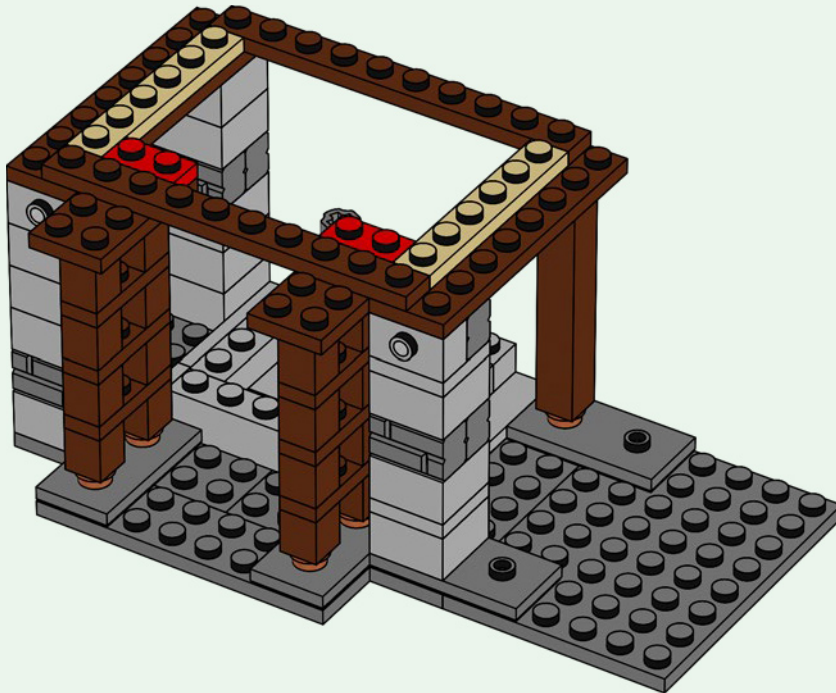



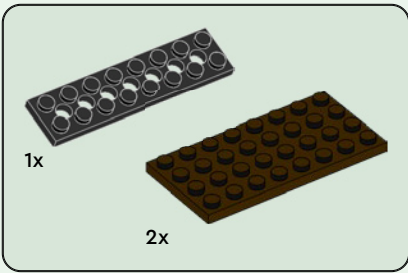

25

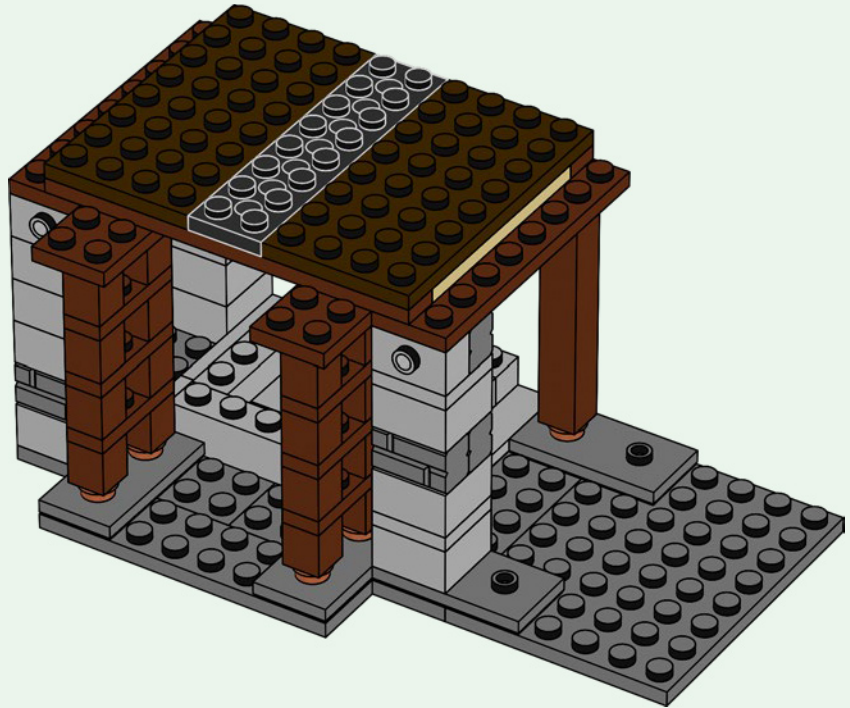



# 26

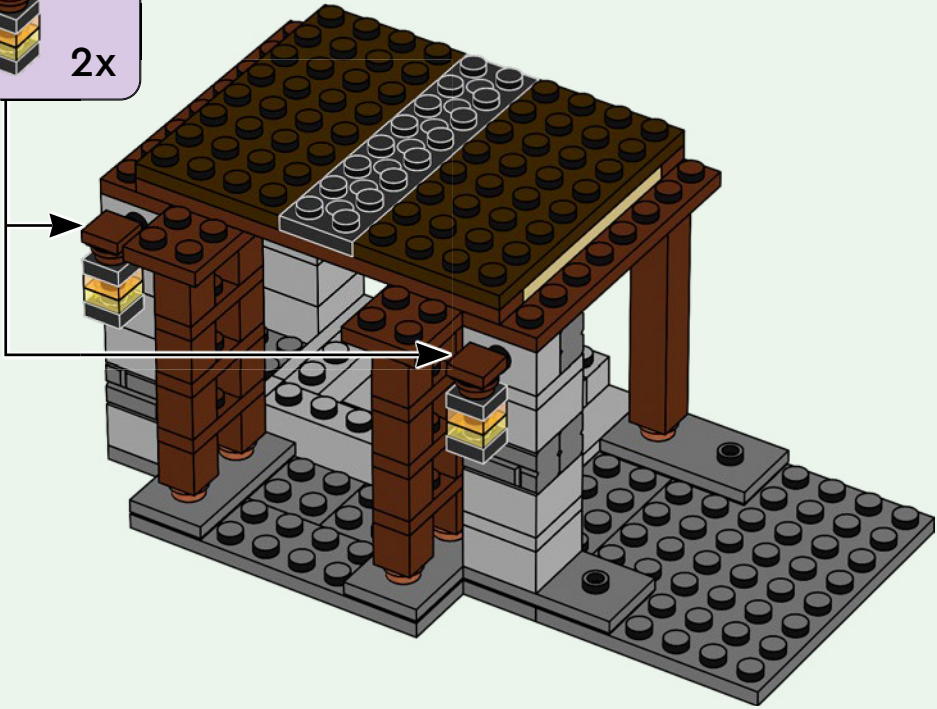
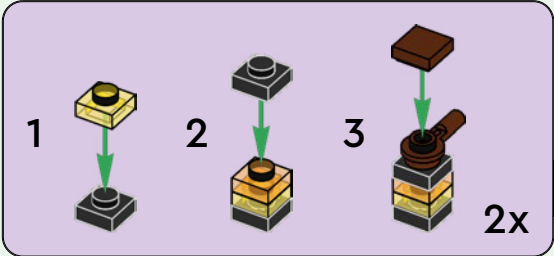

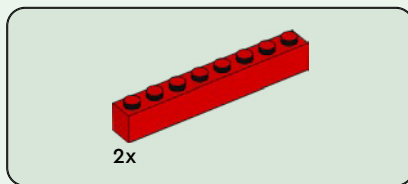

27

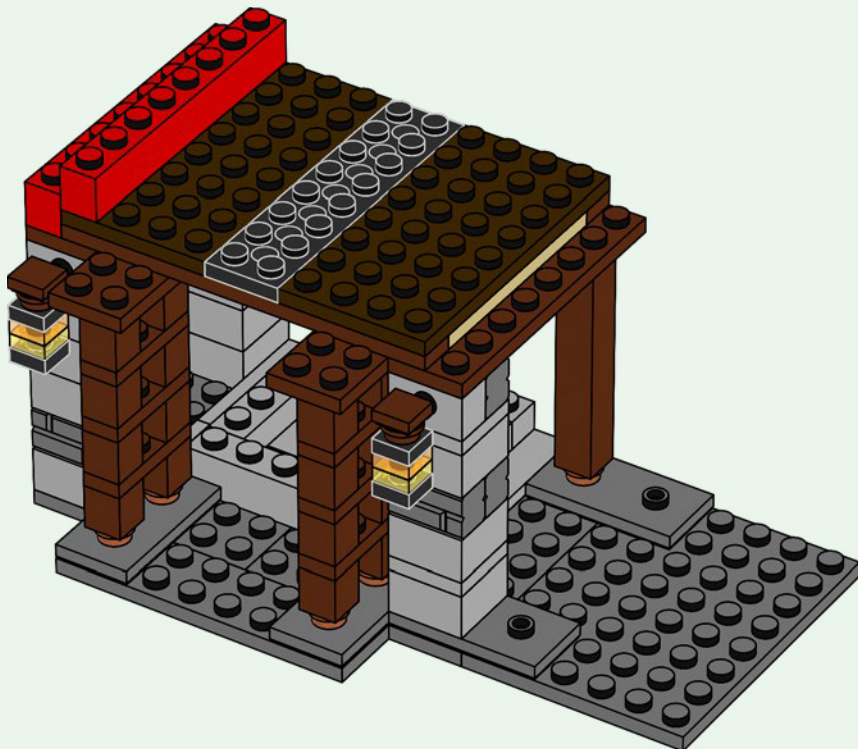

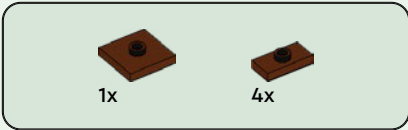

28

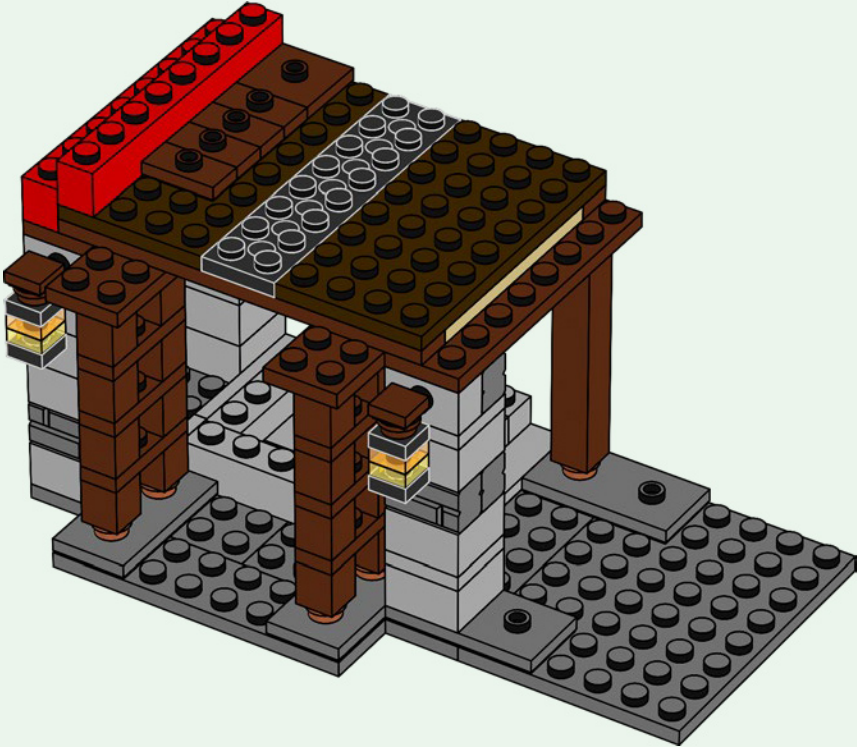

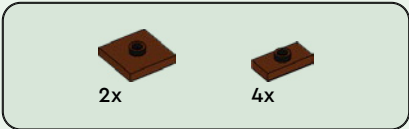

29

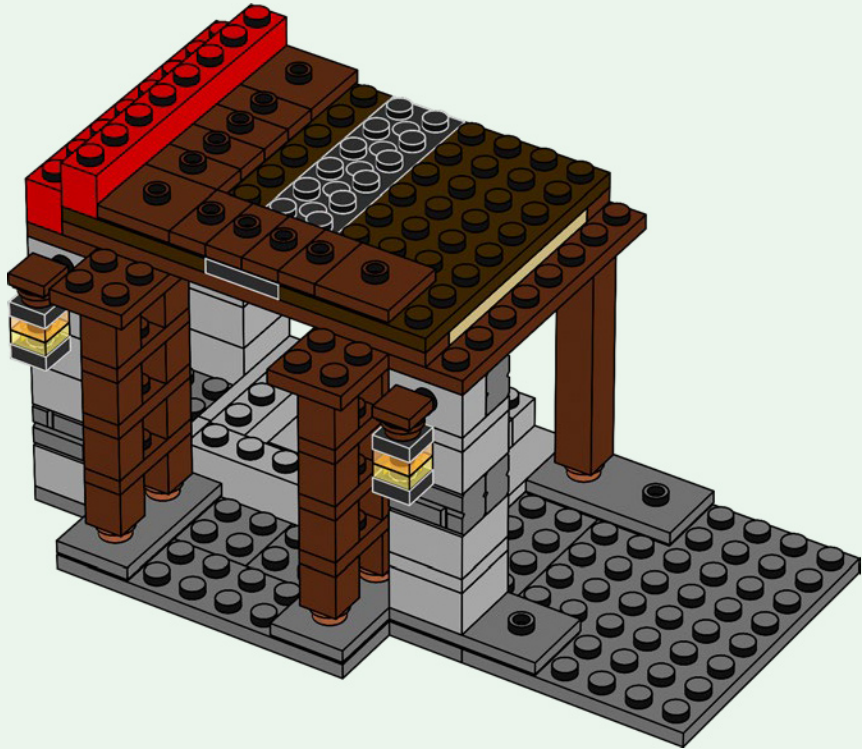



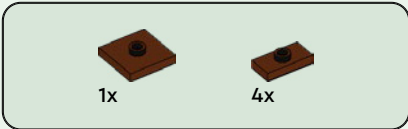

30

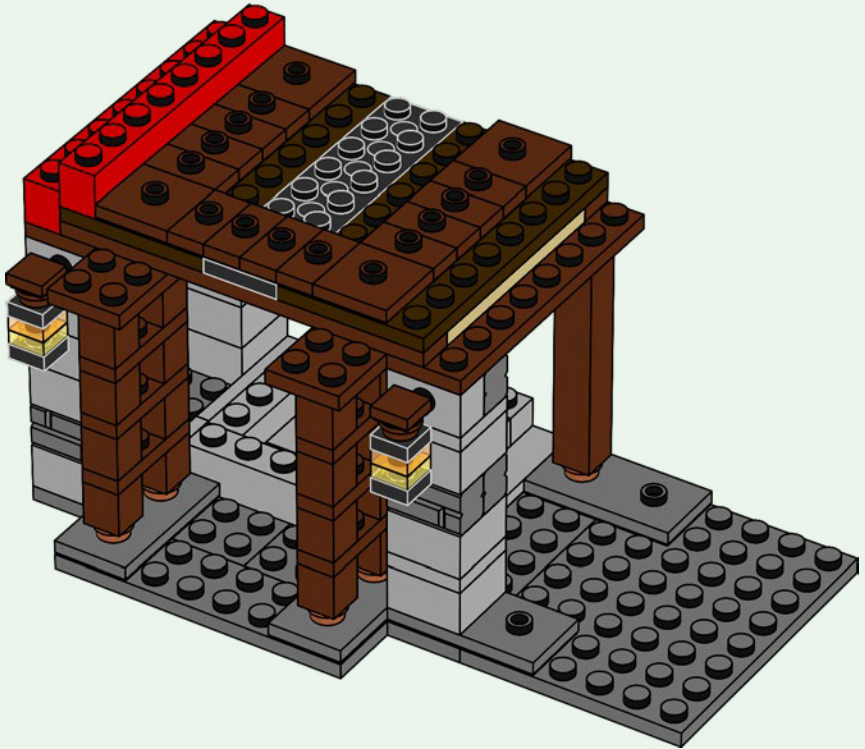



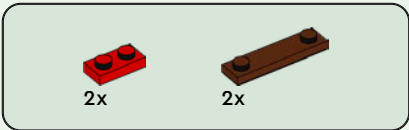

31

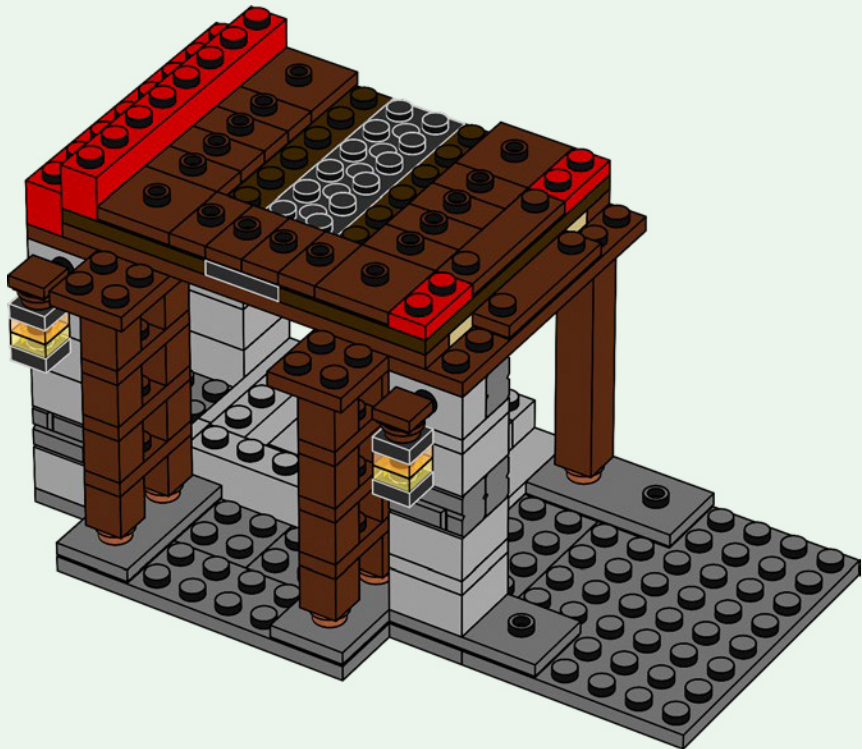

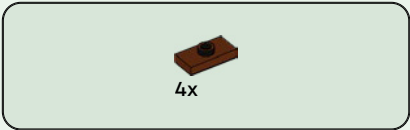

32

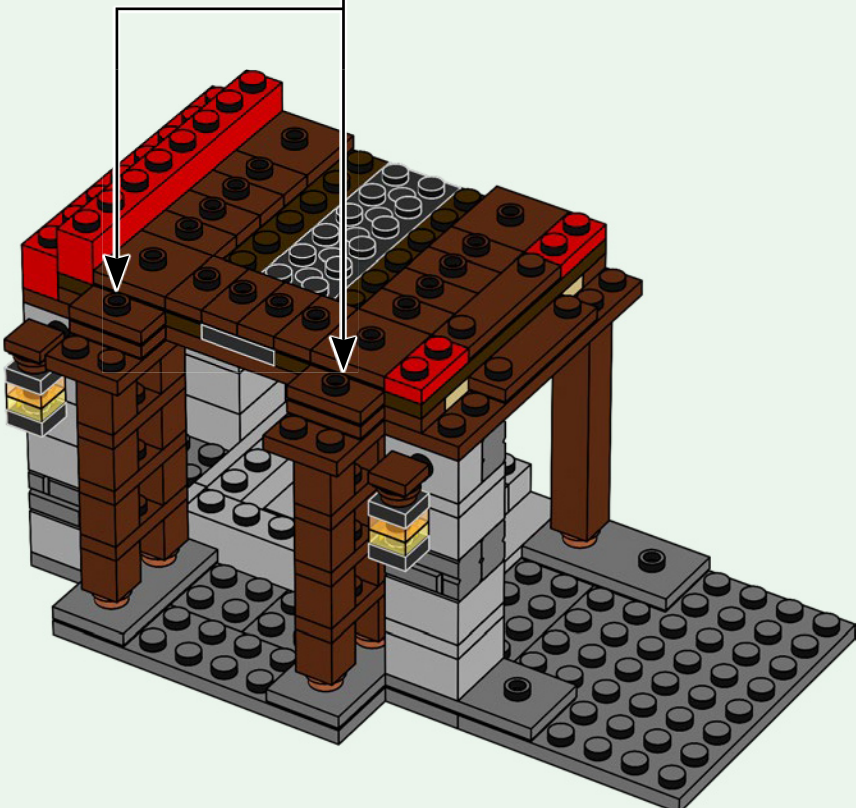
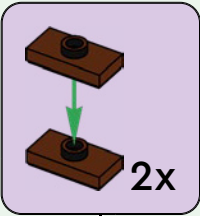

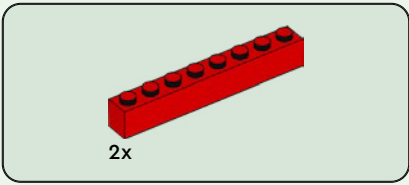

33

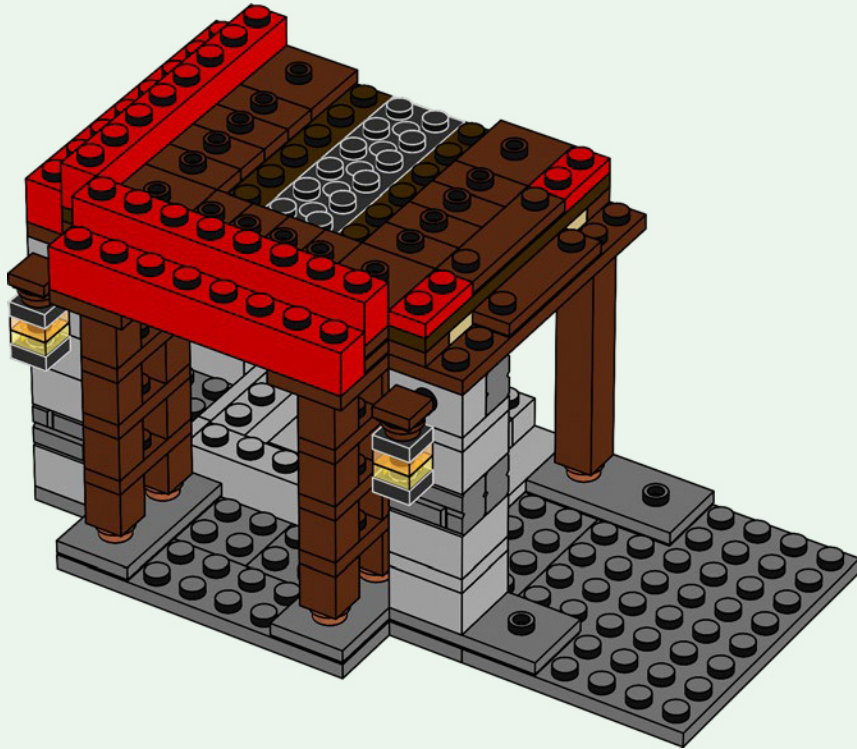



2x

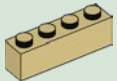

4x



2x



4x



4x



2x

34

1

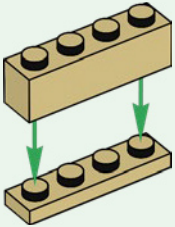

2

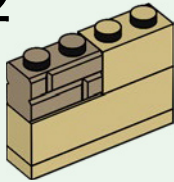

3

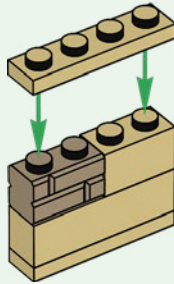

4

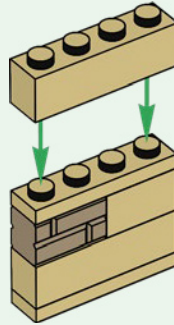

5

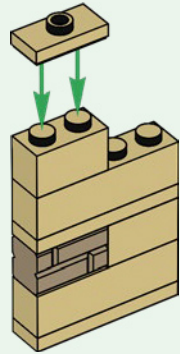

2x



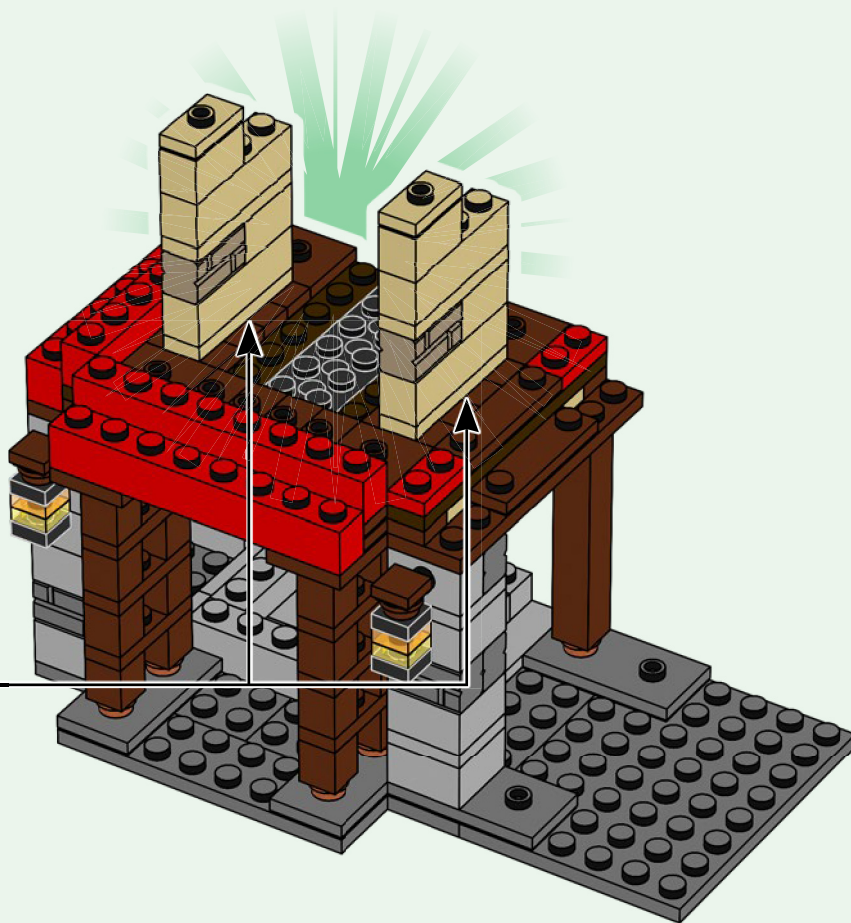

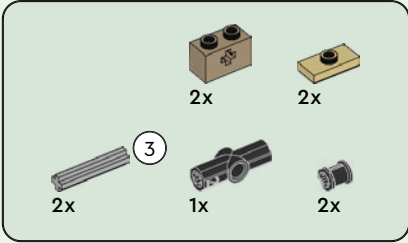
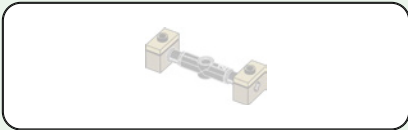

# 35

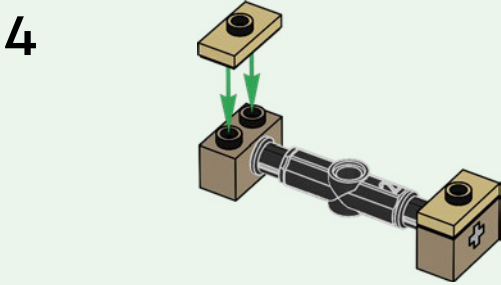
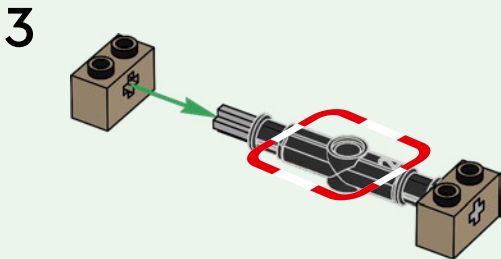
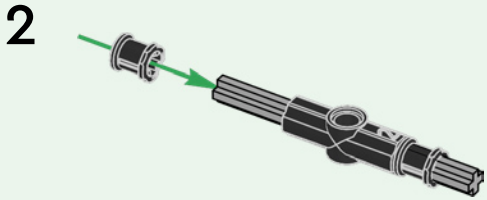
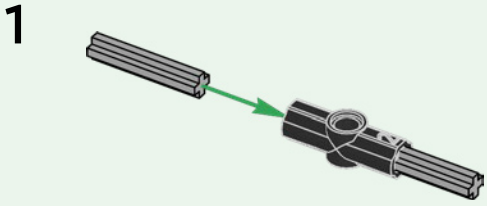



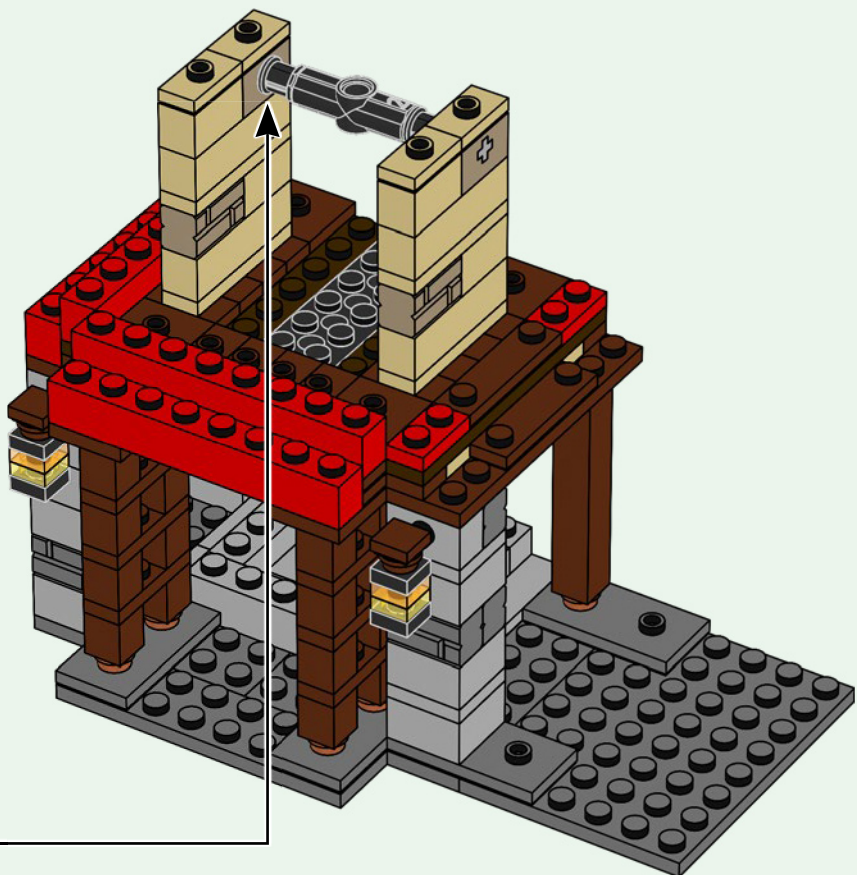

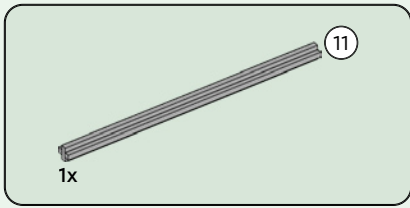

36

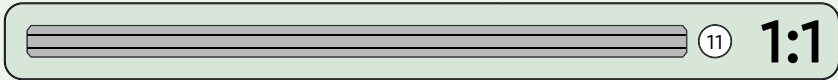
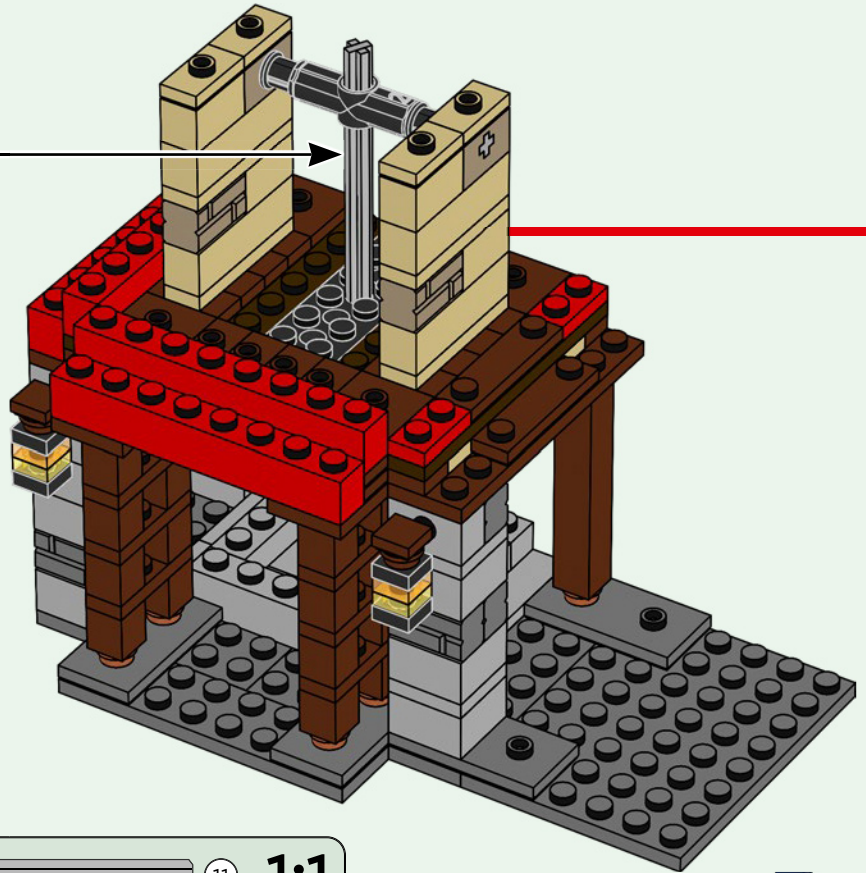
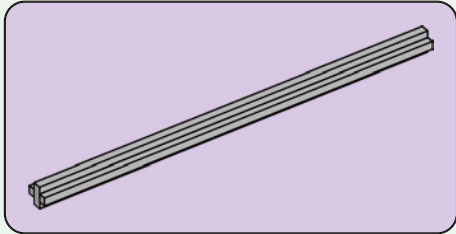



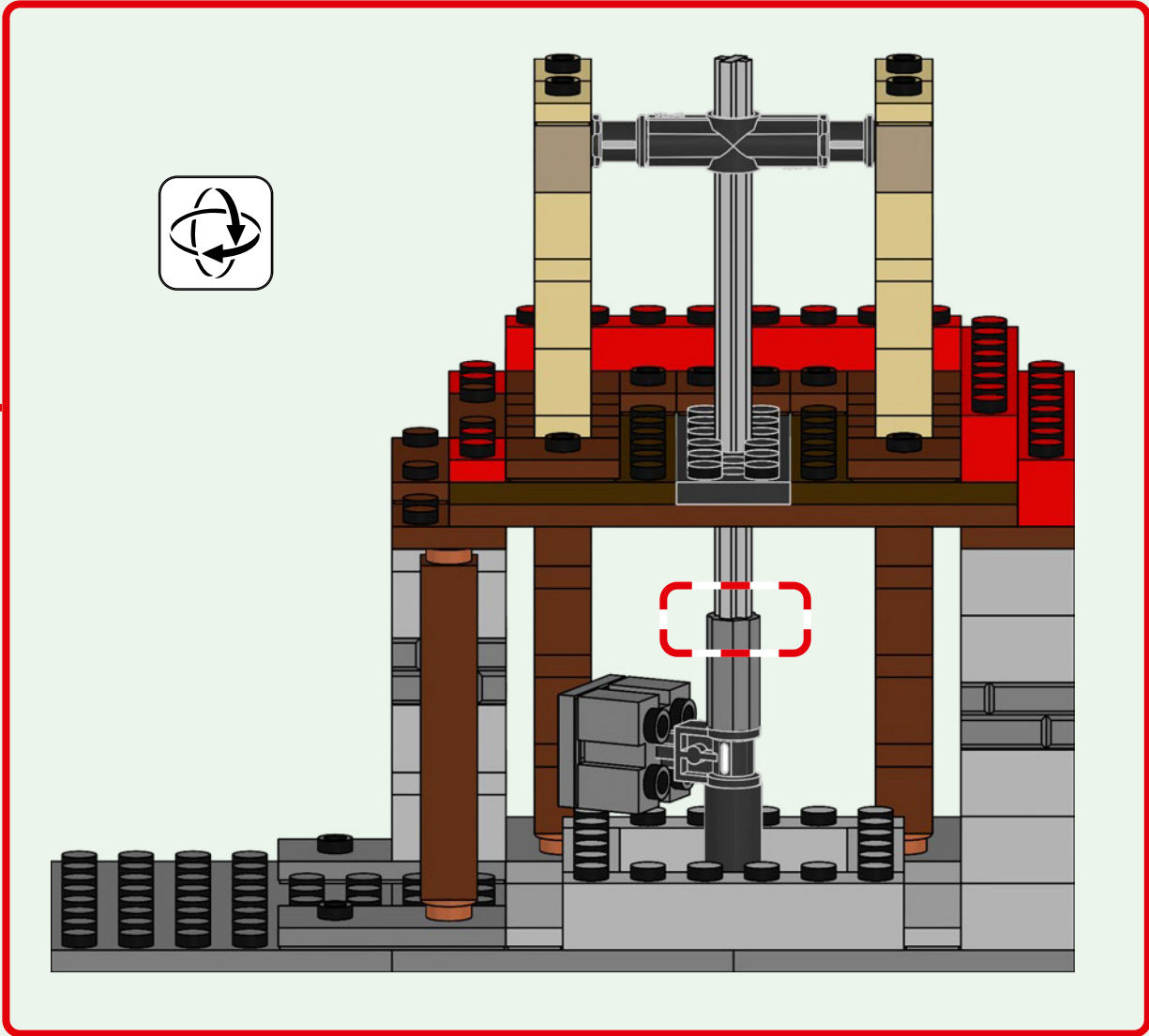



1x



1x

37

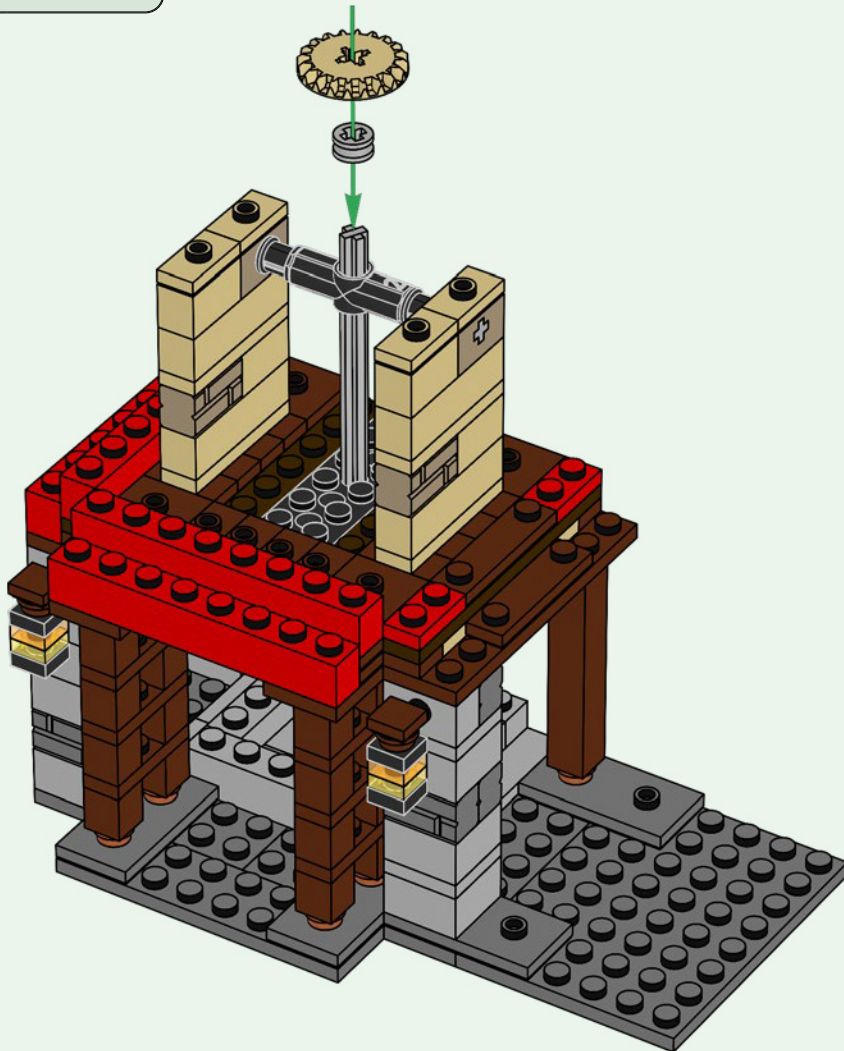

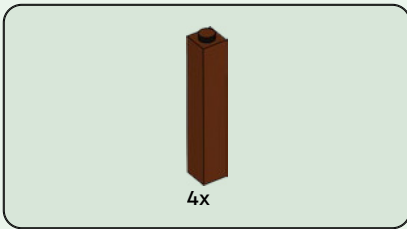

38

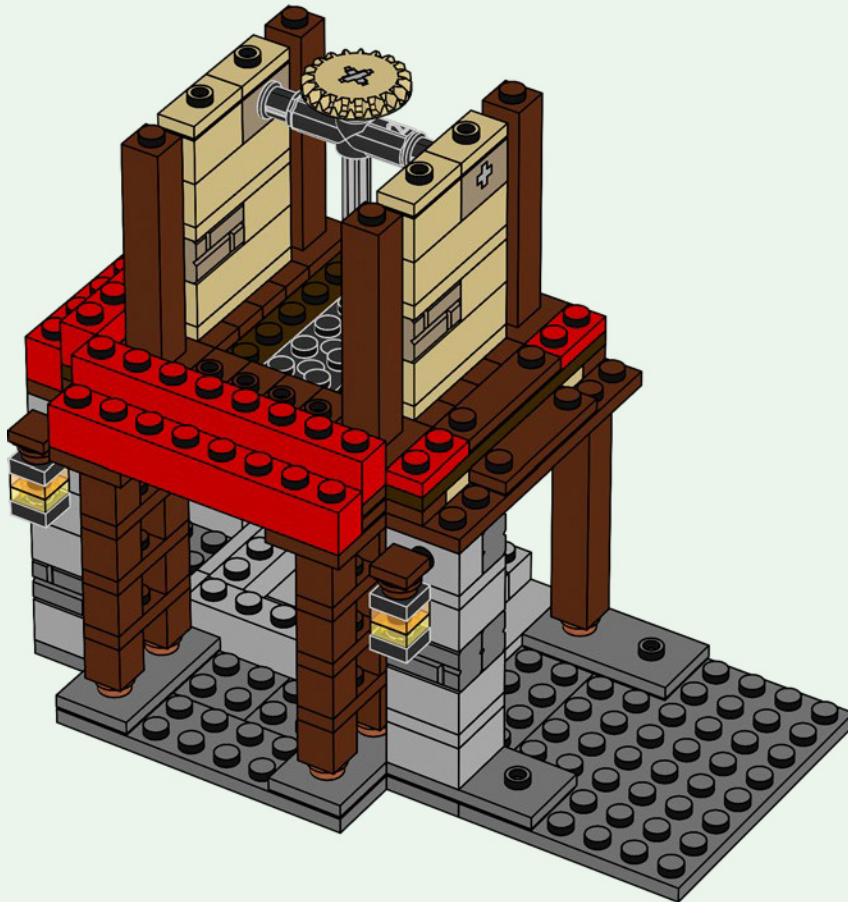

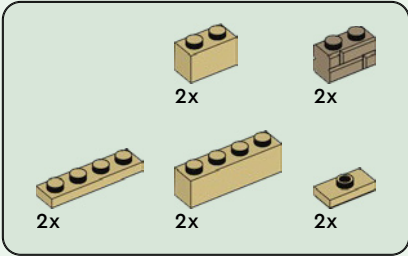
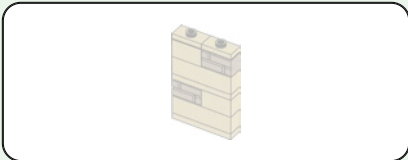

# 39

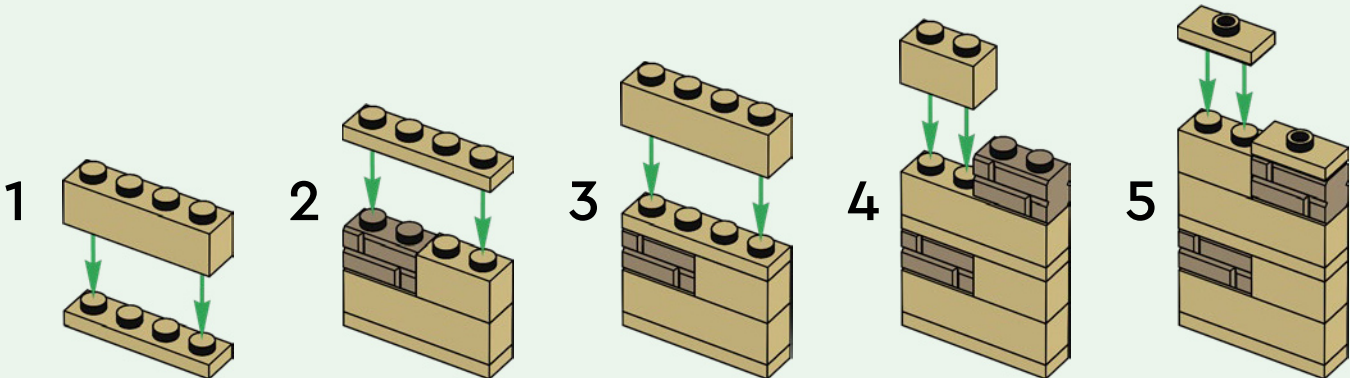

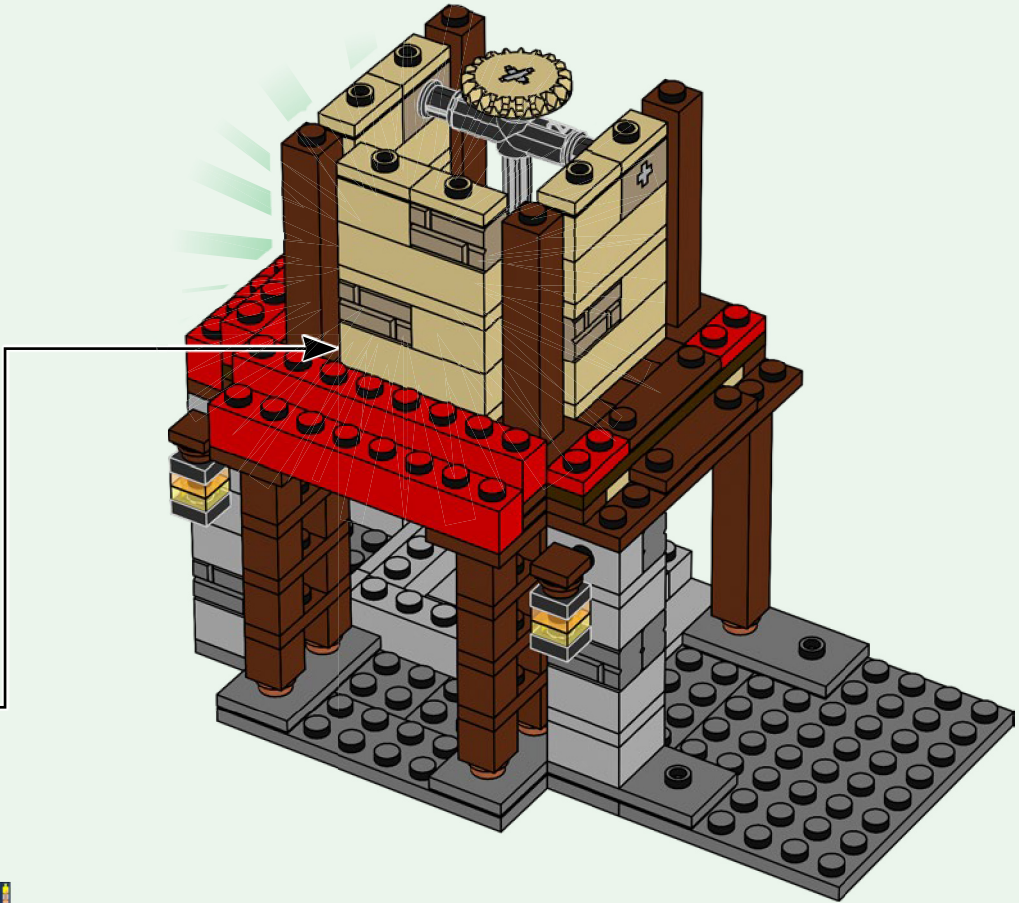

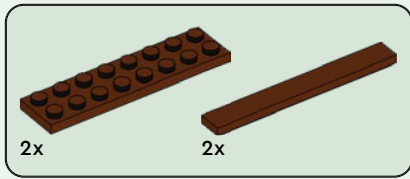

40

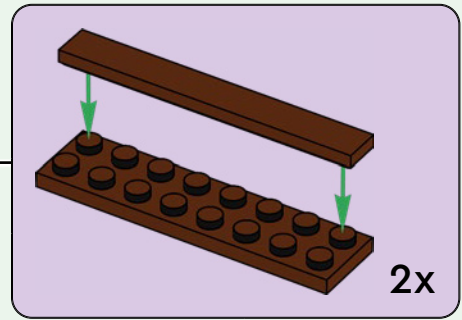
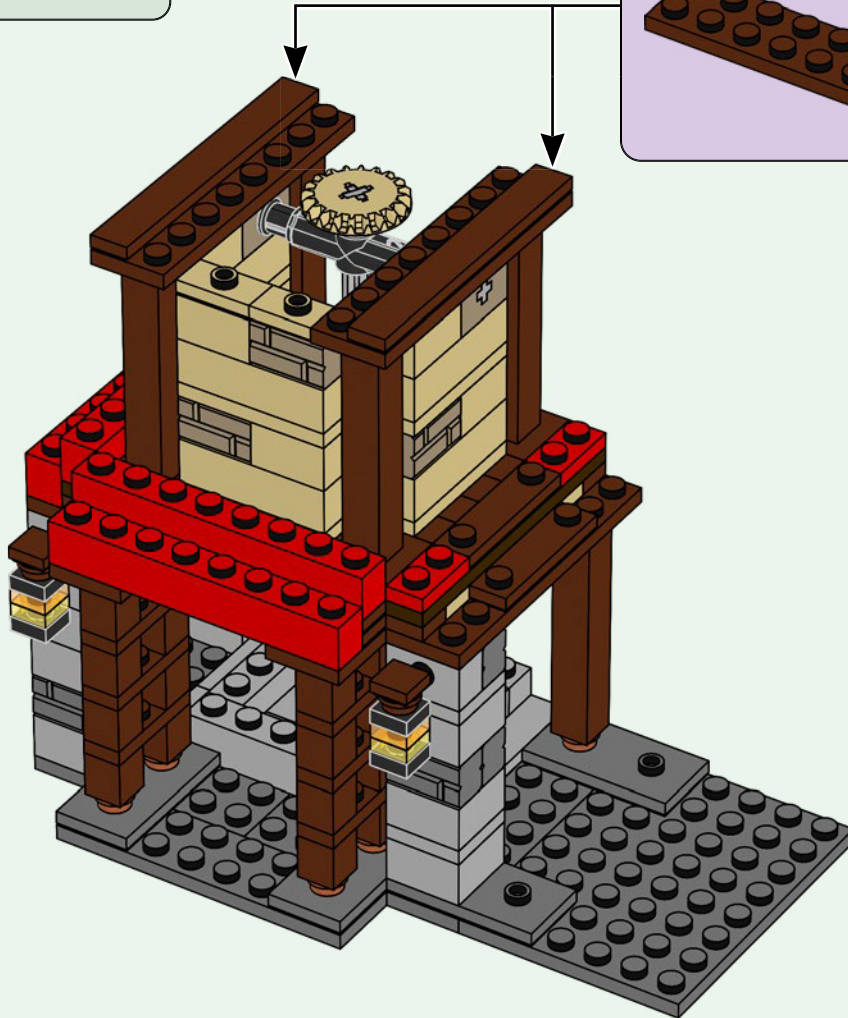





2x

41

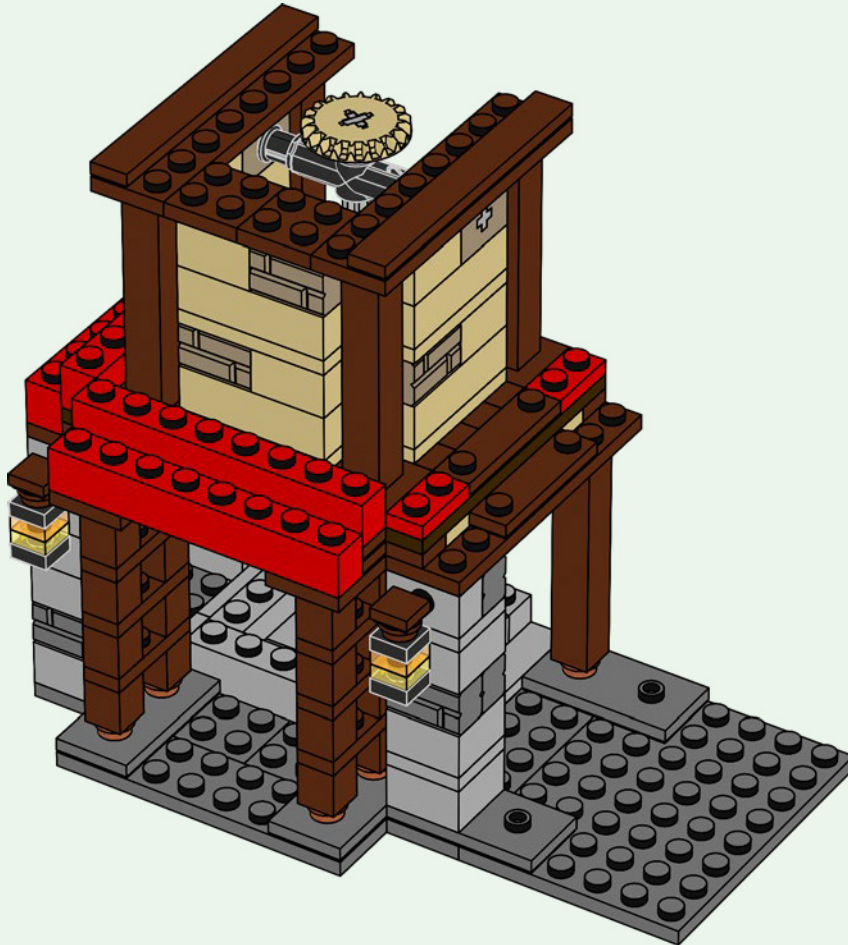





2x

42

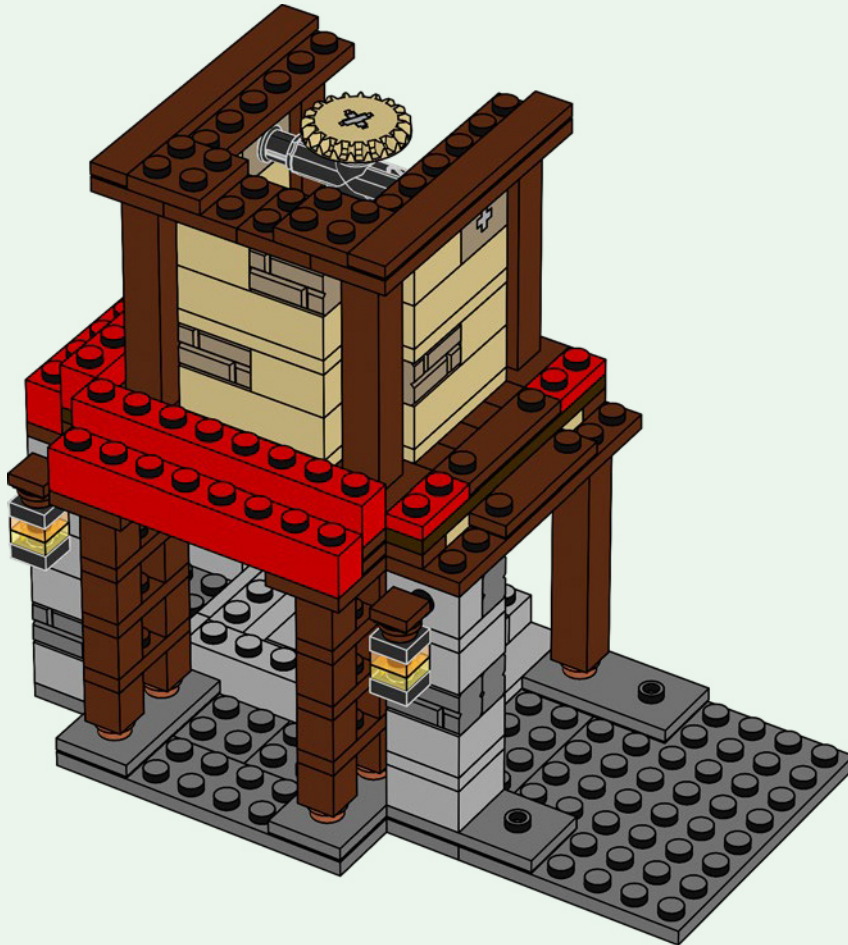



1x



1x

# 43

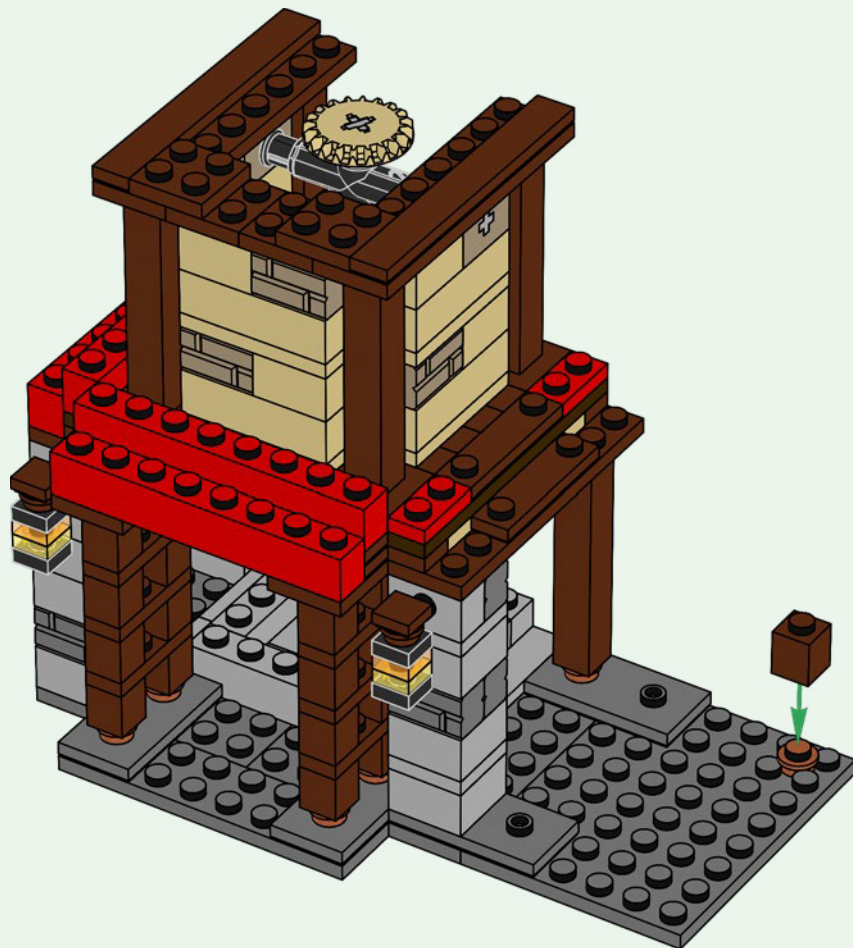



3x



3x

44

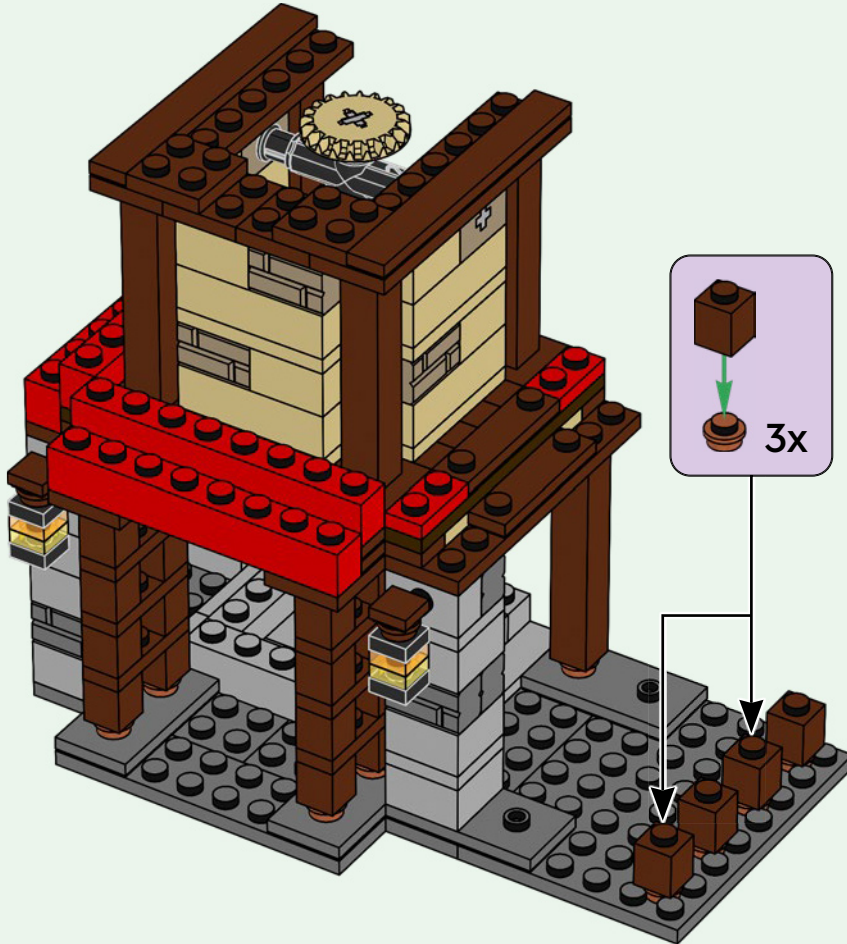



2x

45

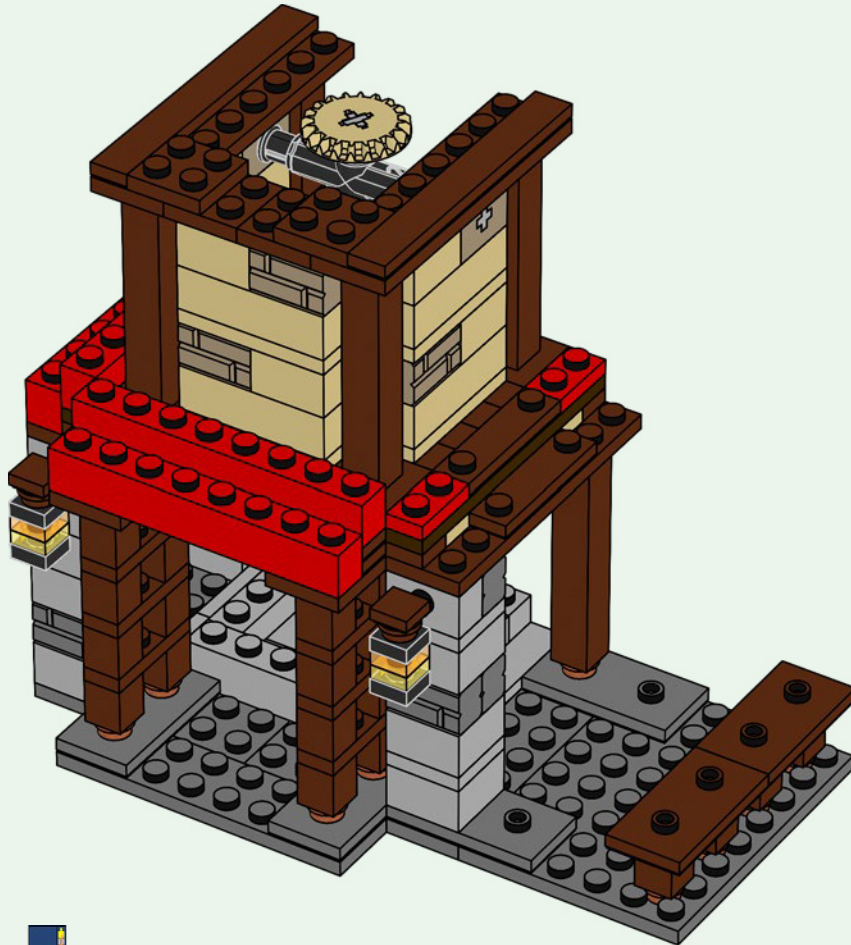



8x



2x

46

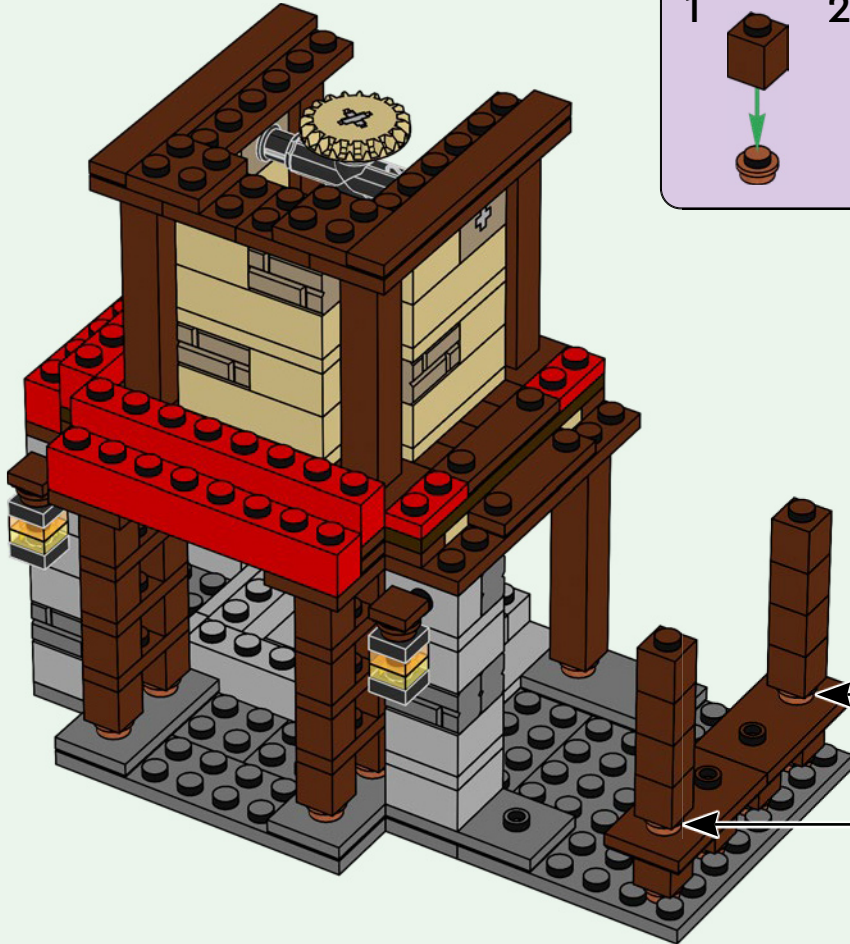

1

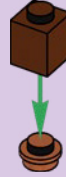

2

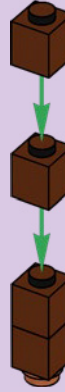

2x



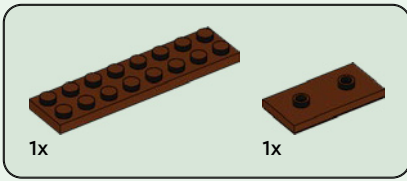

47

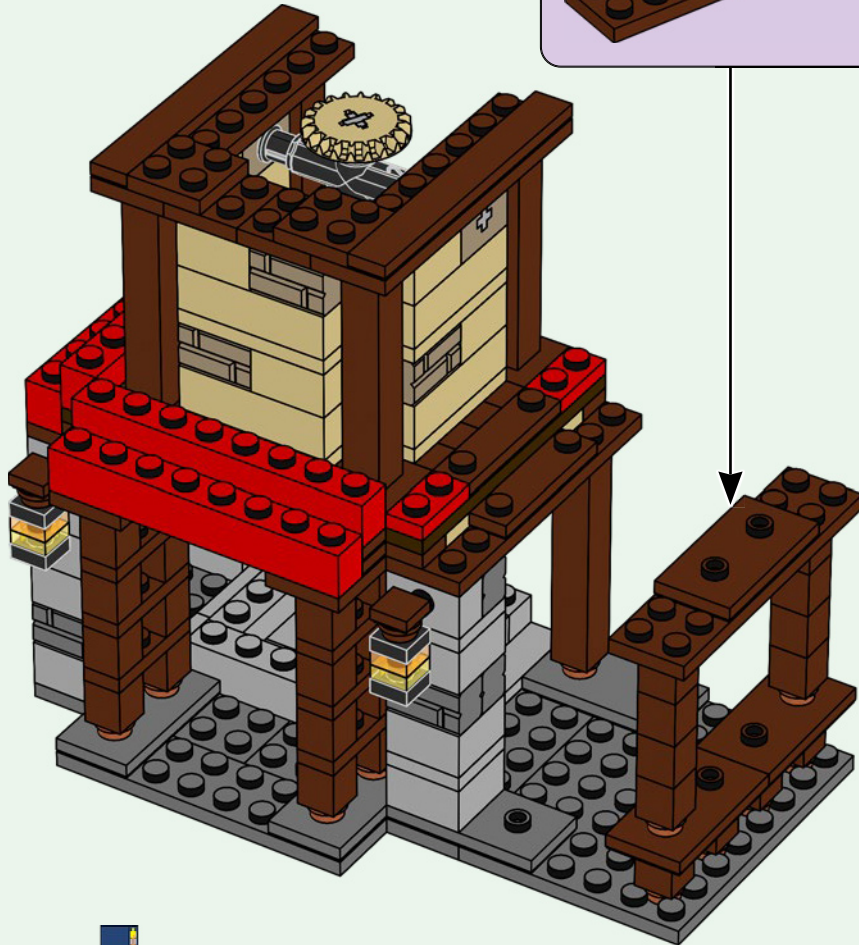
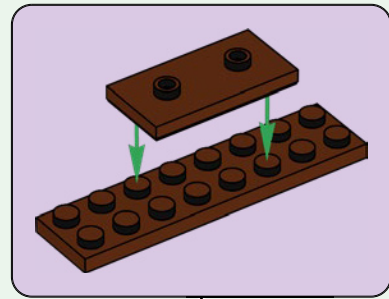

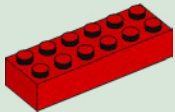

1x

48

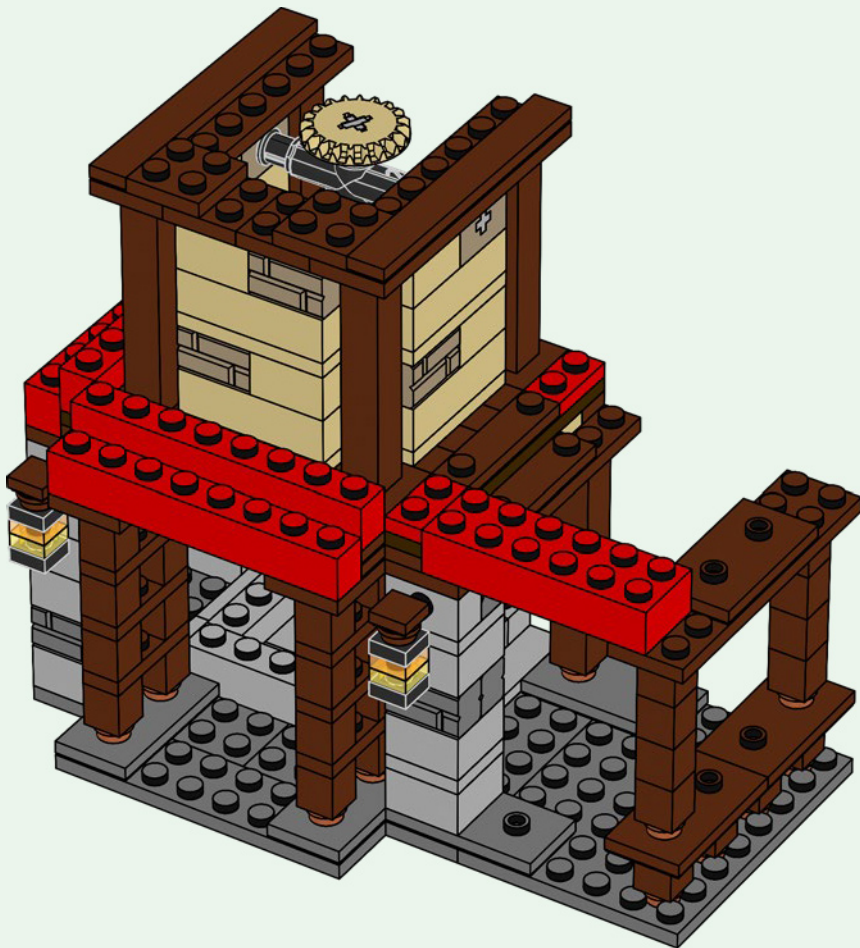





1x



2x

49

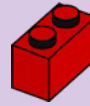

2x

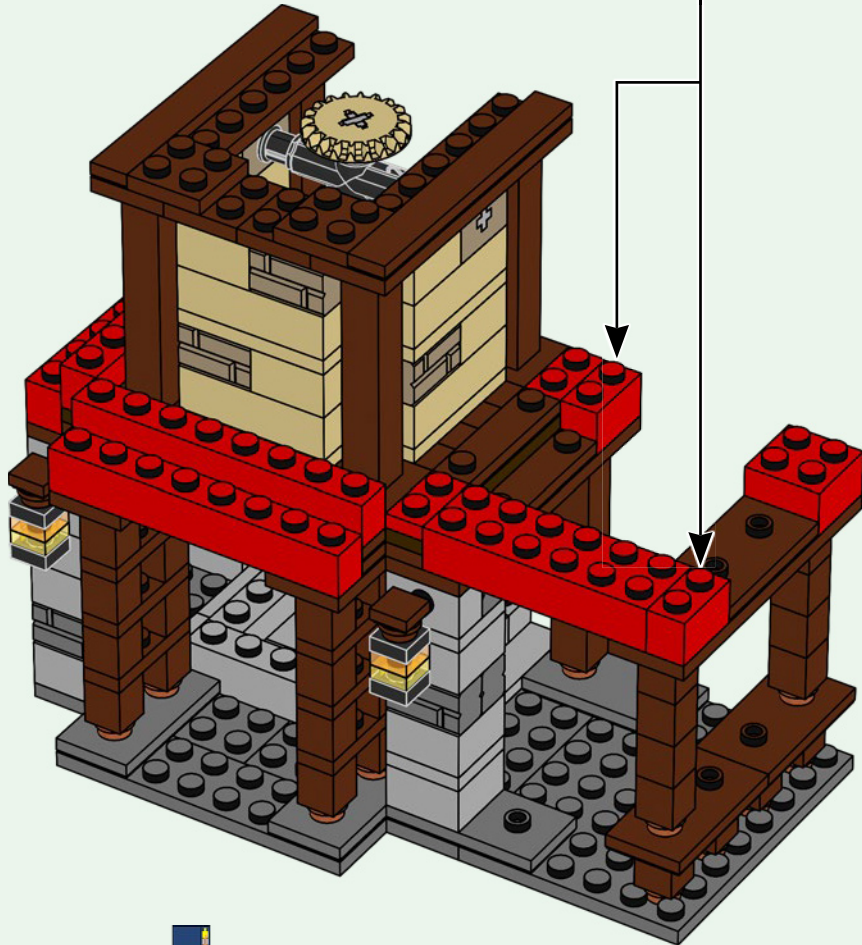



2x



4x

50

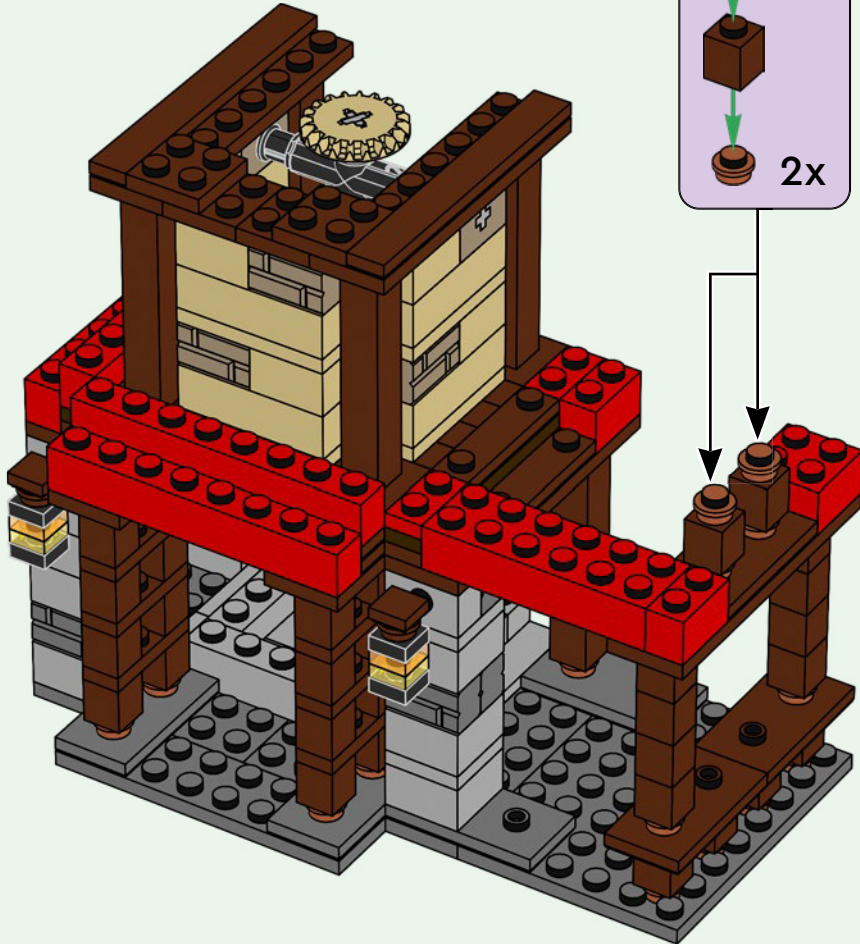

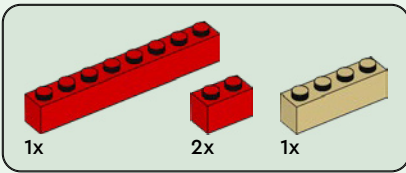

51

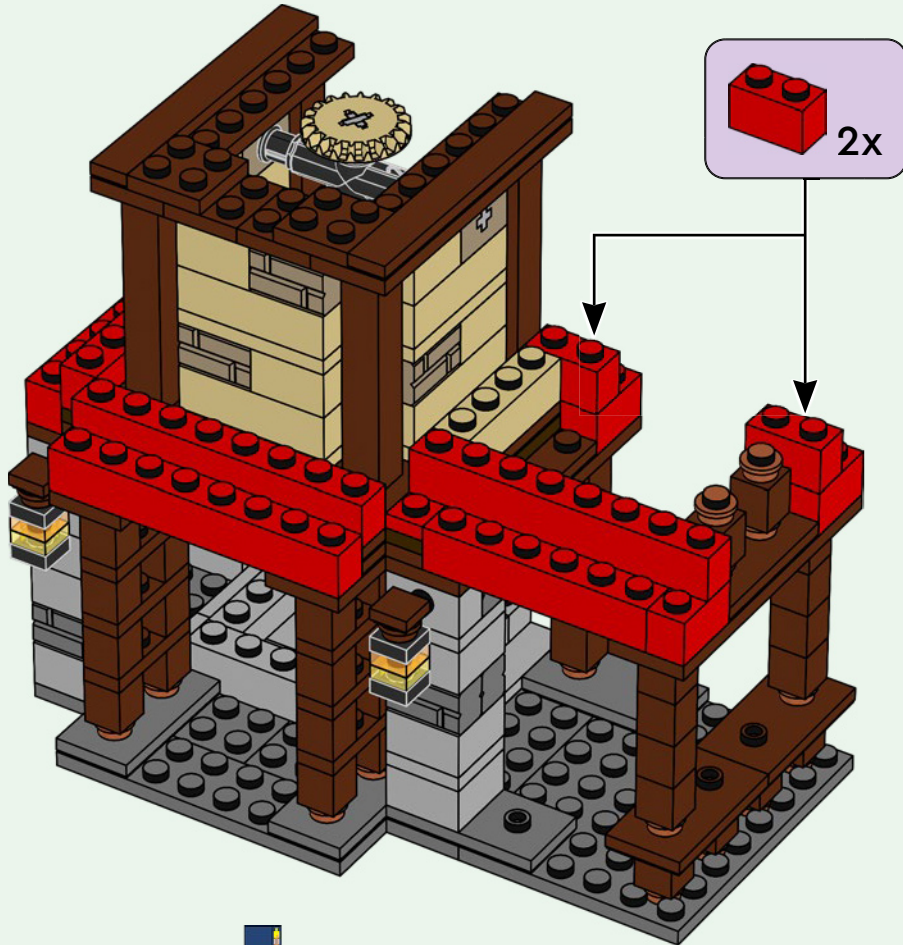

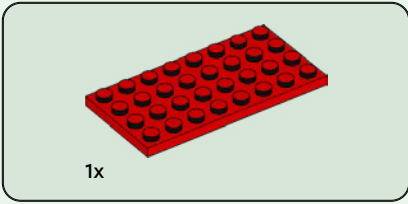

52

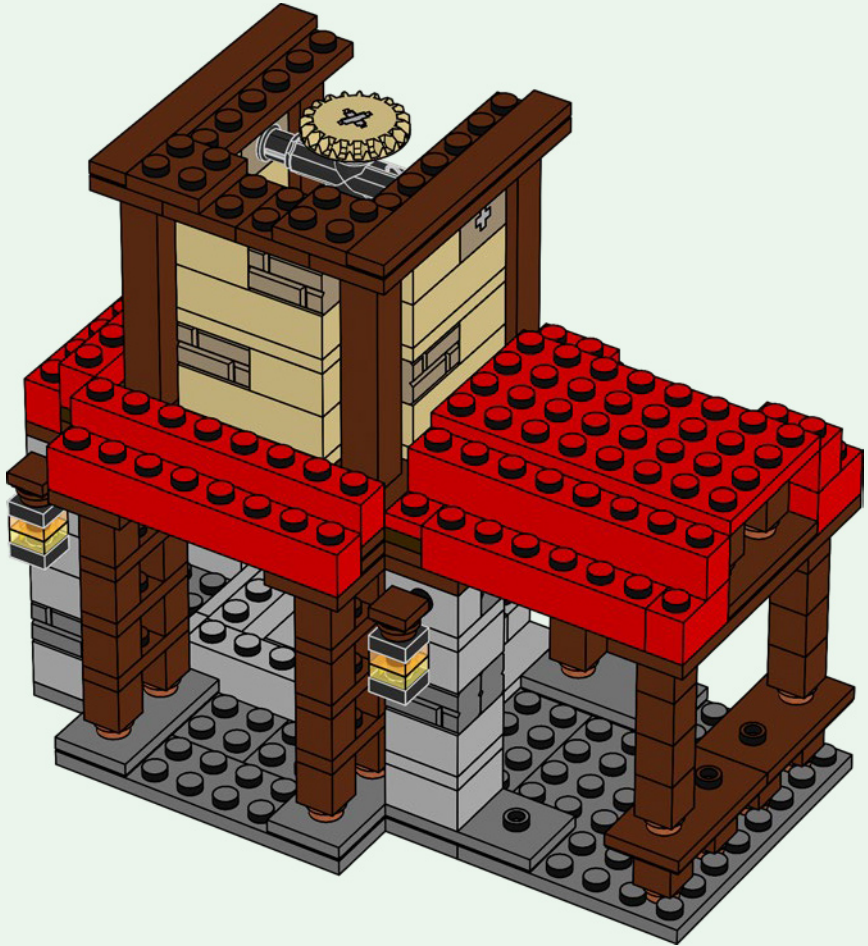

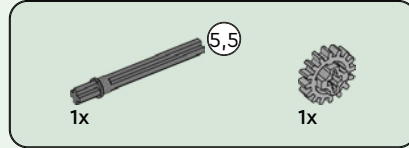
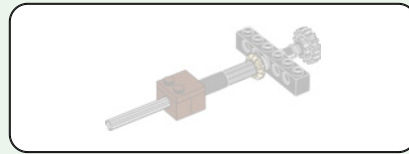

53

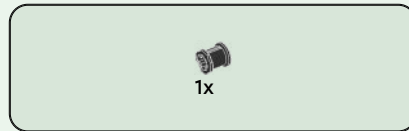
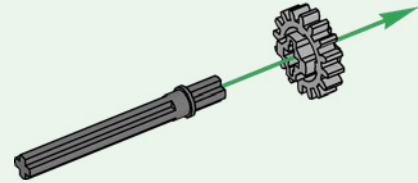

54

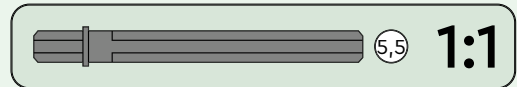
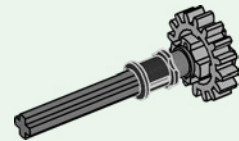



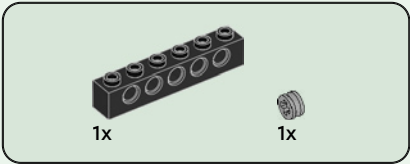

55

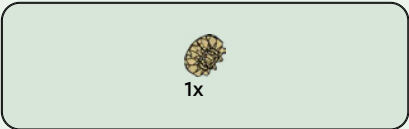
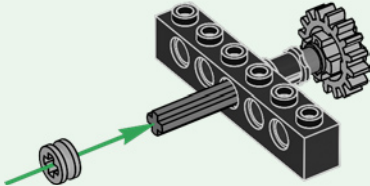

56

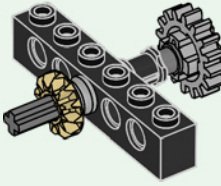

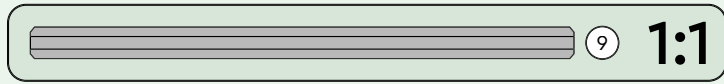
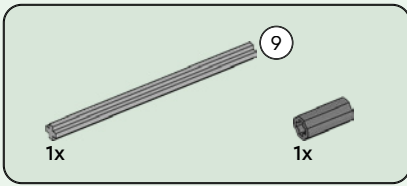

57

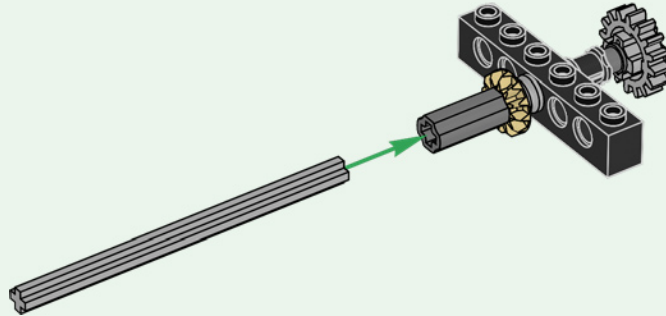





1x

58

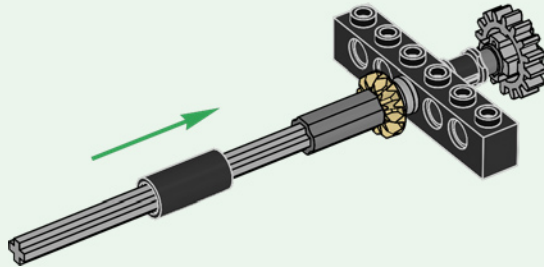

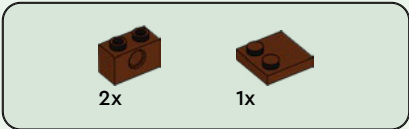

59

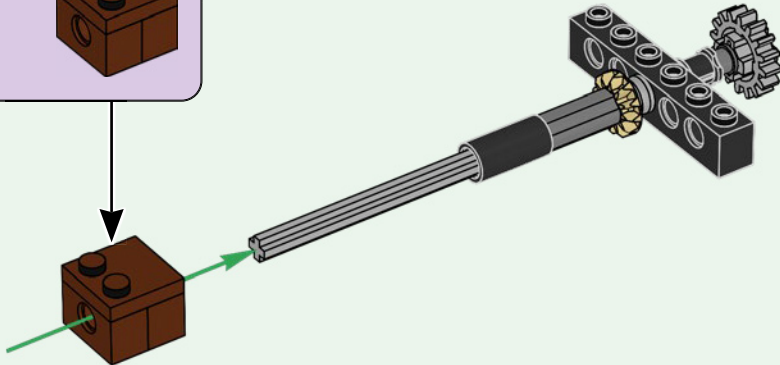
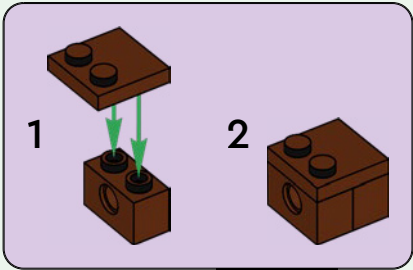

60

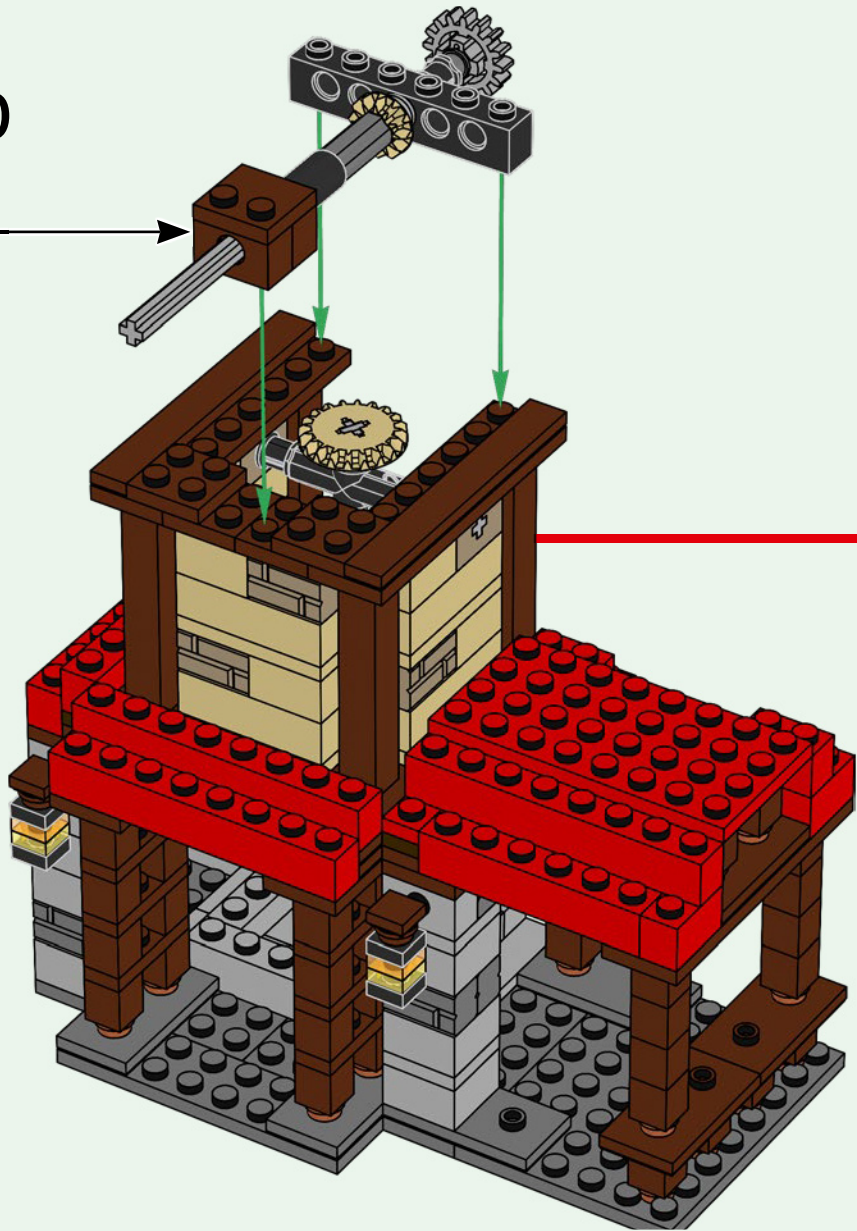

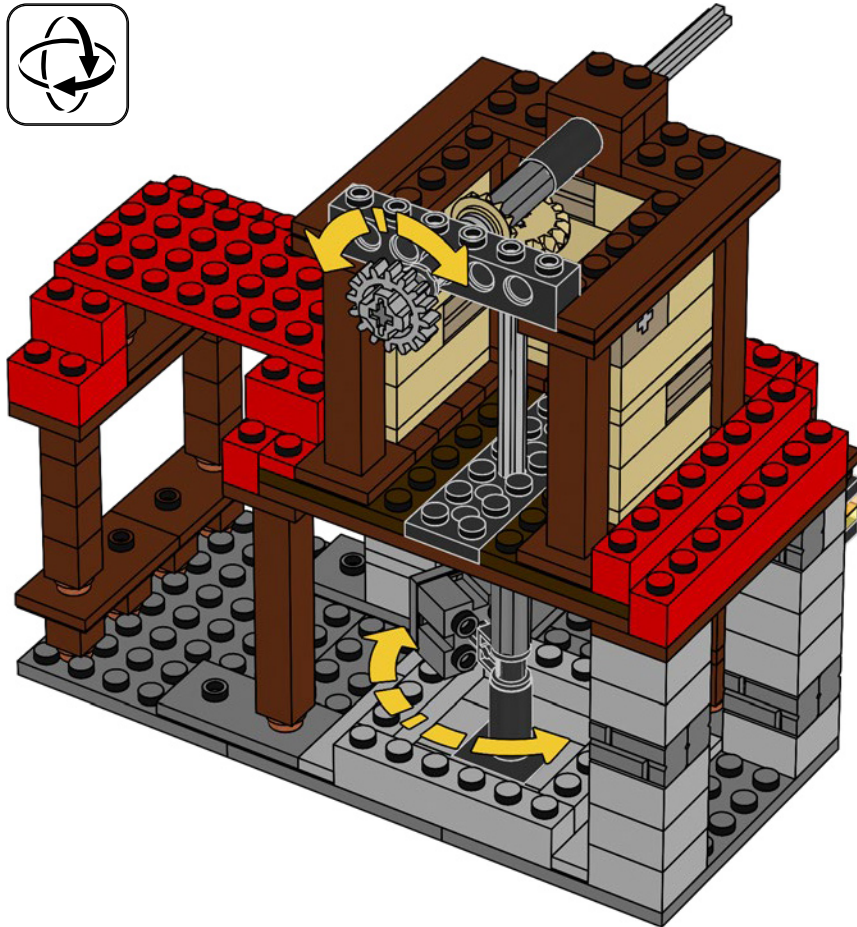



2x

61

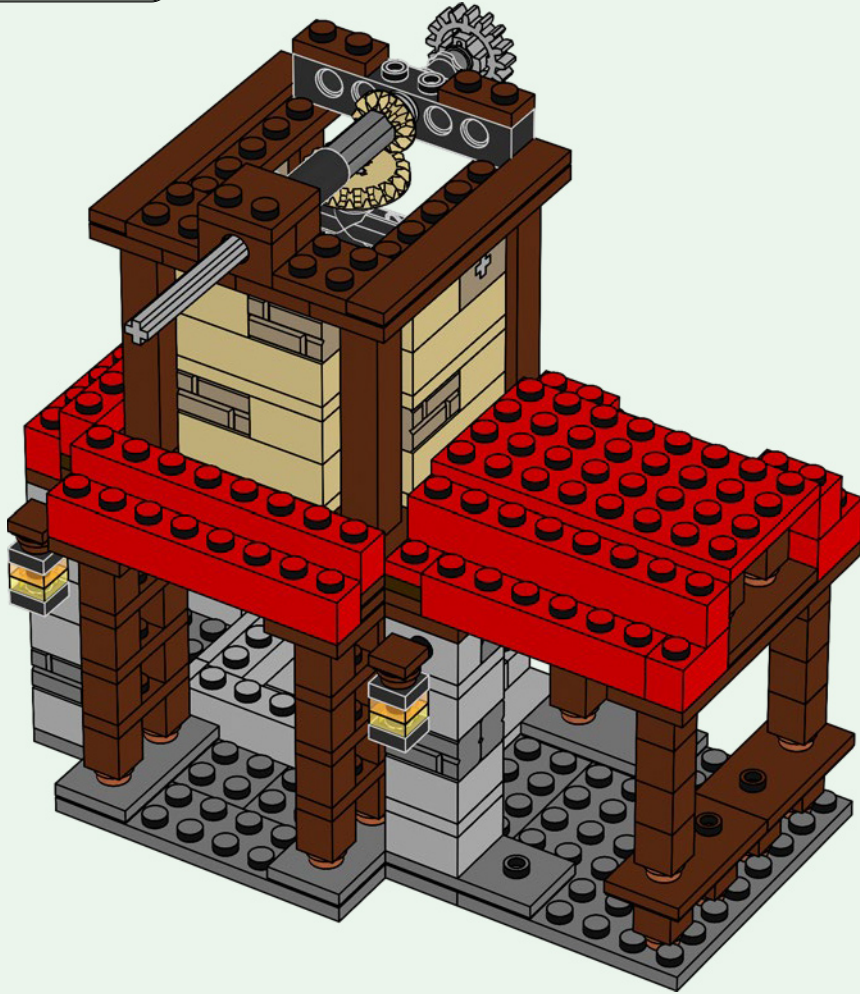





2x

62

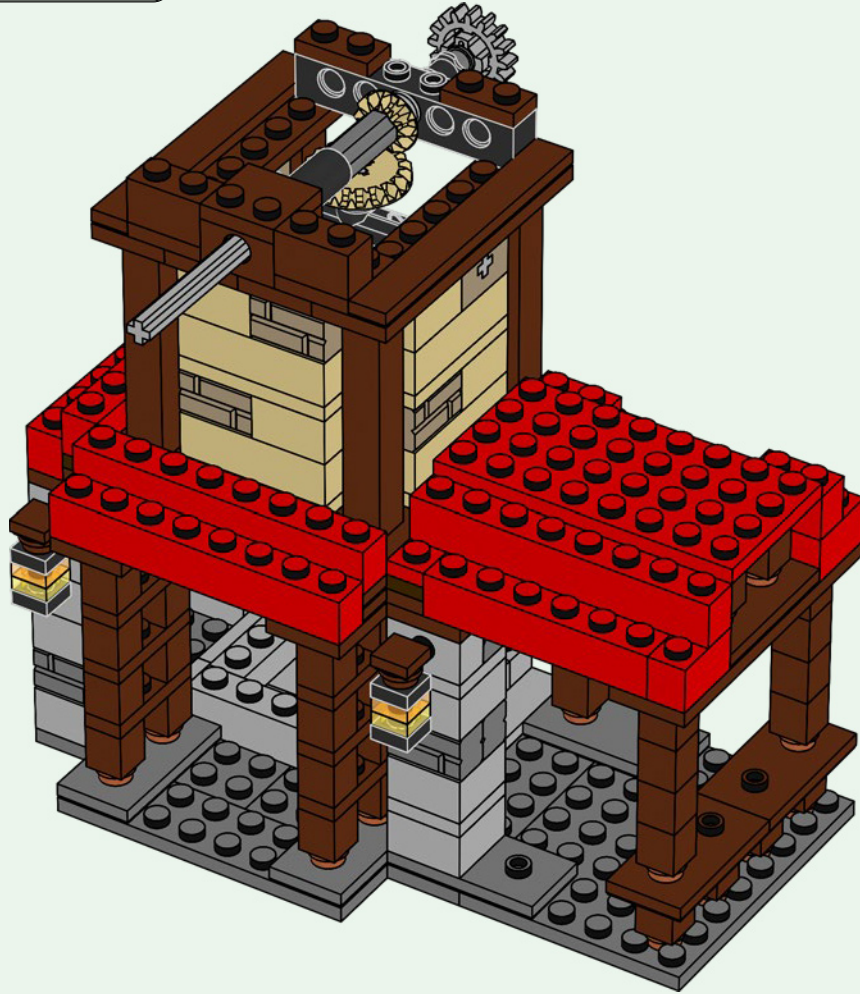



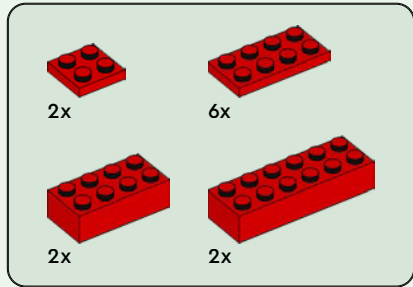
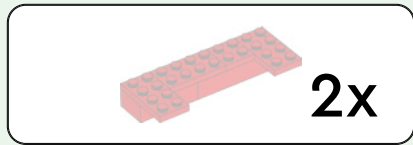

63

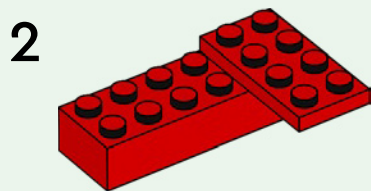
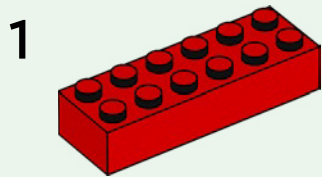

3

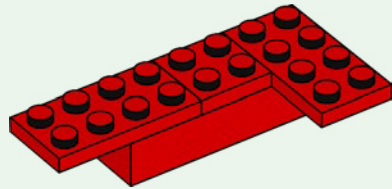

4

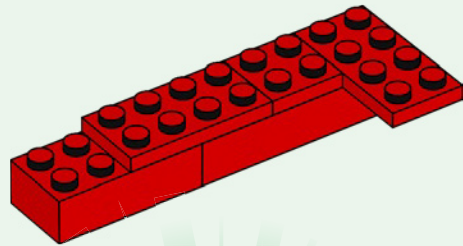

5

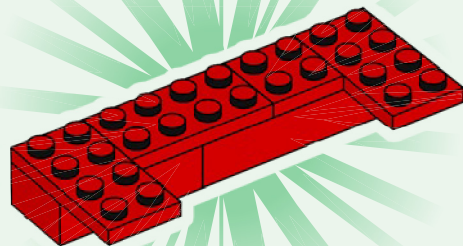

2x

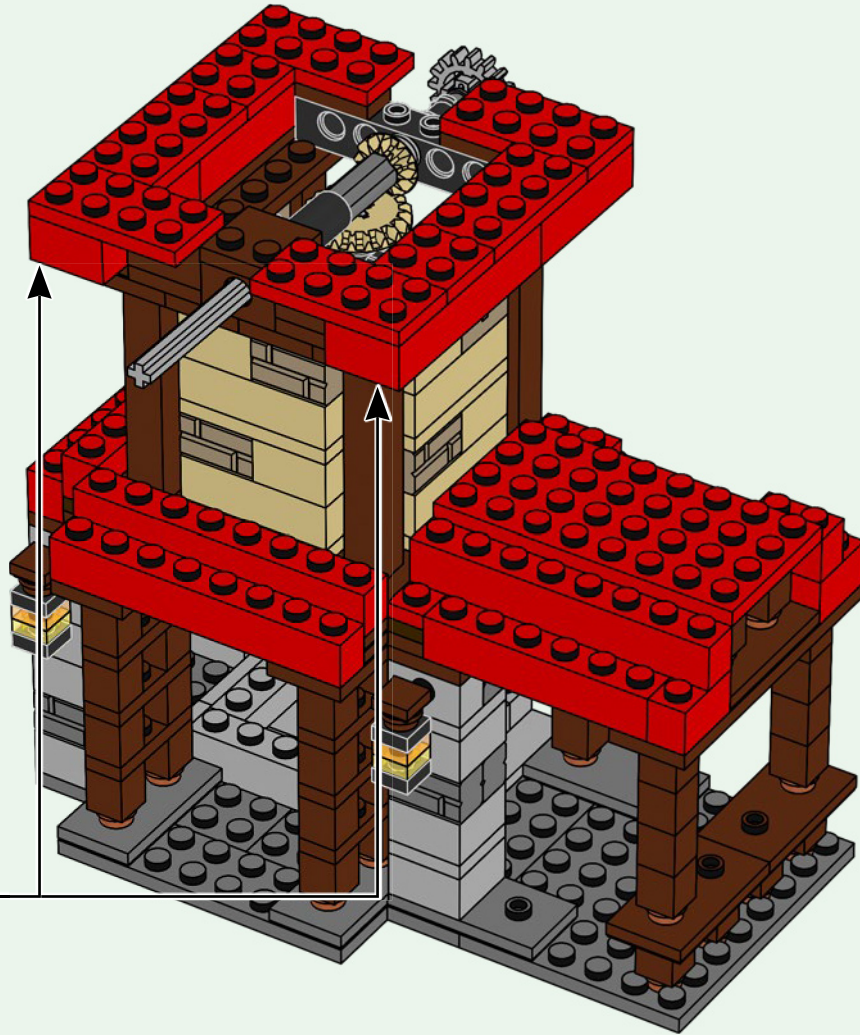

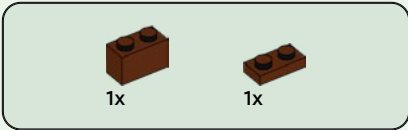

64

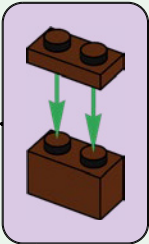

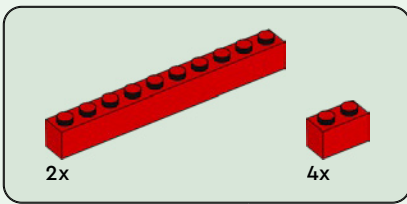

65

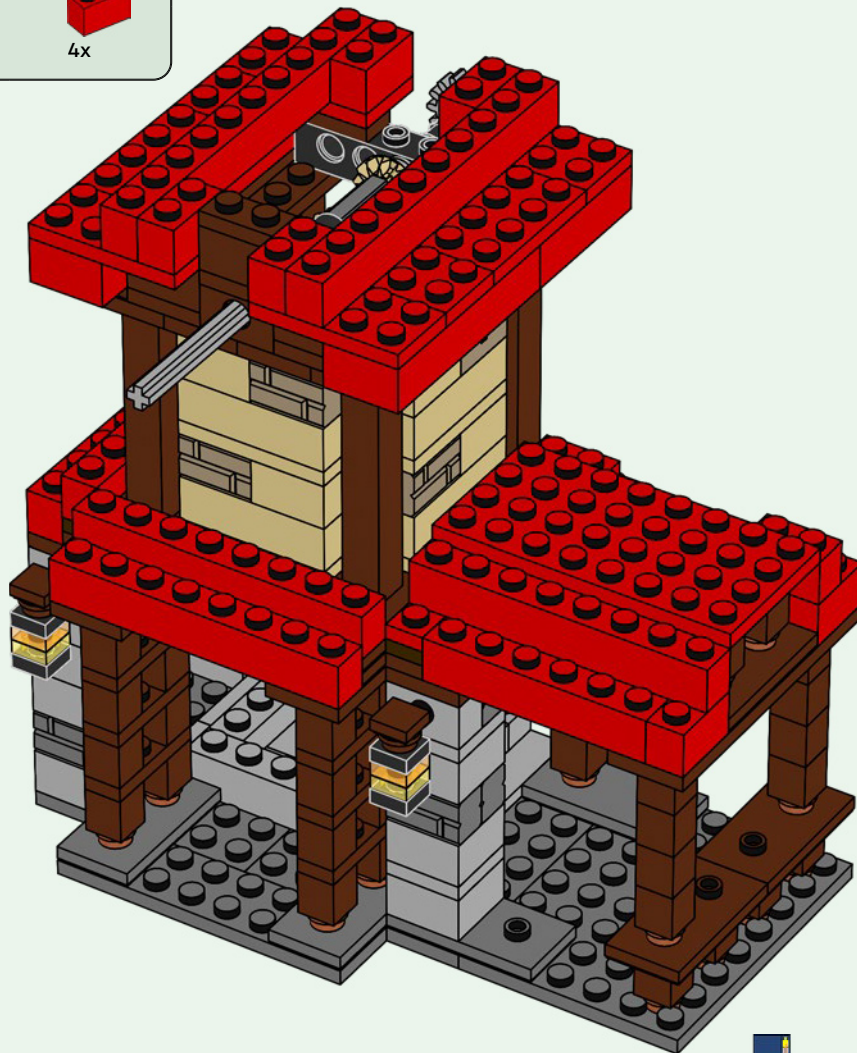



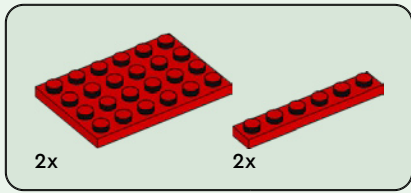

66

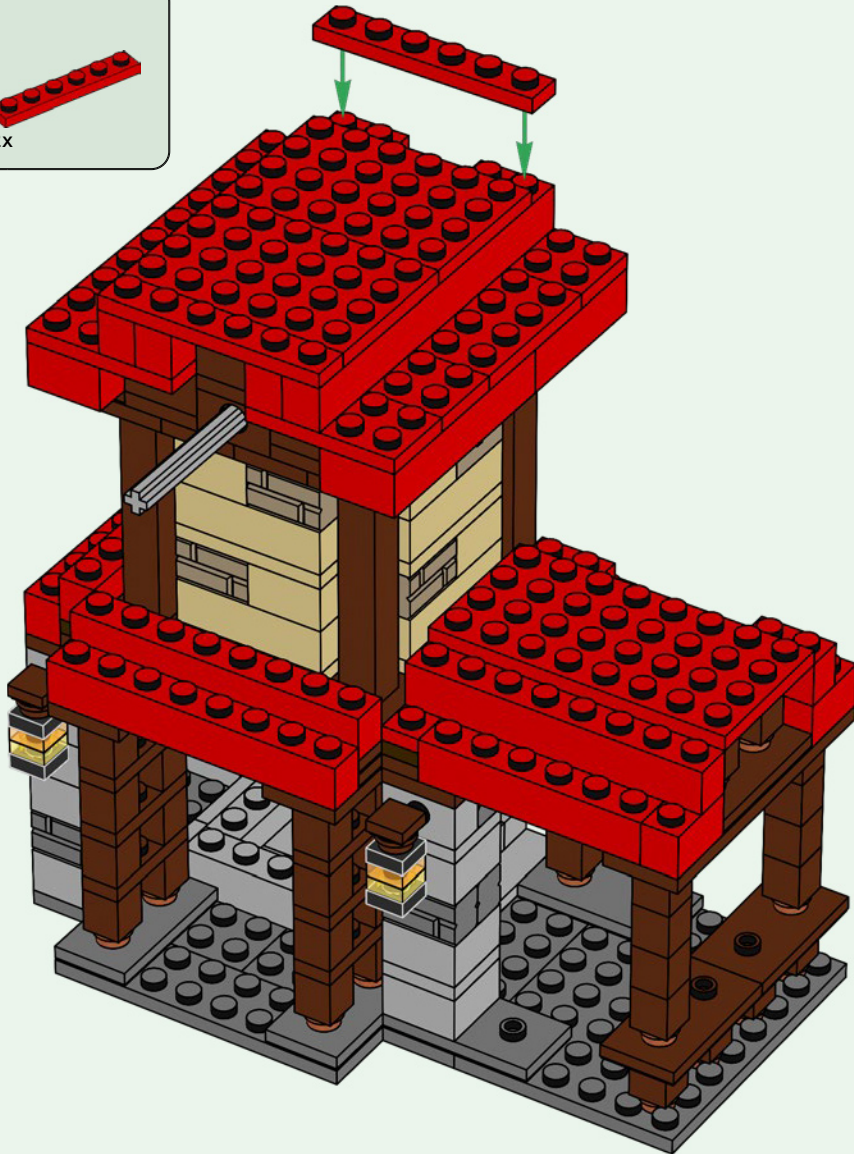

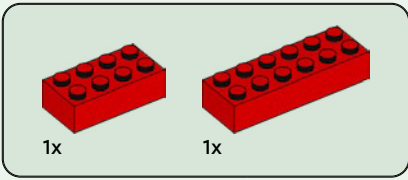

67

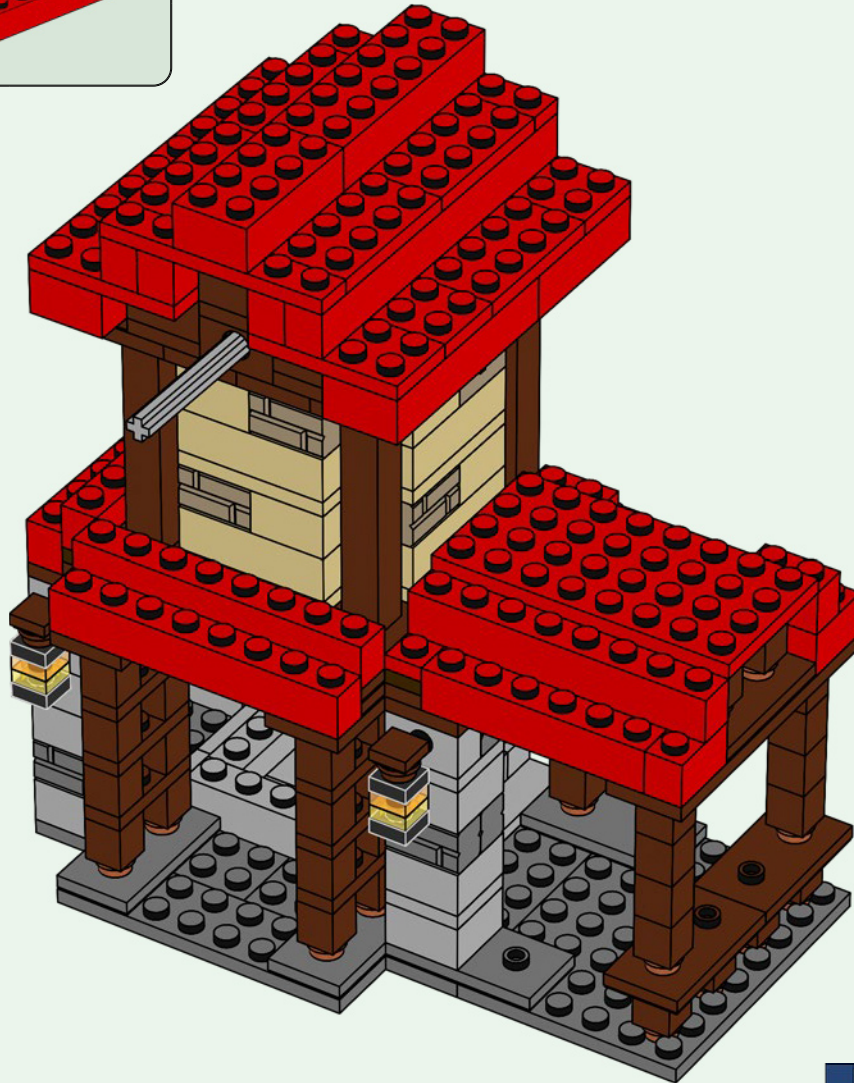





1x

68

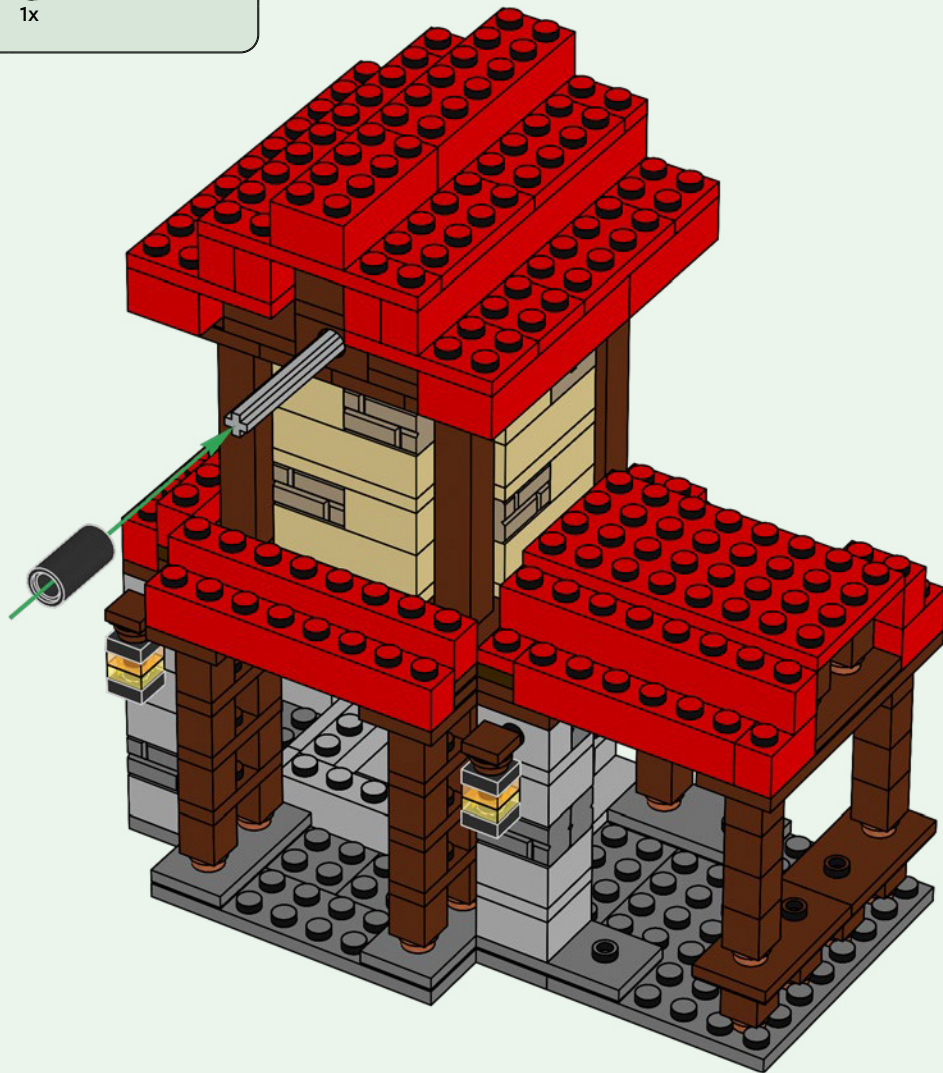

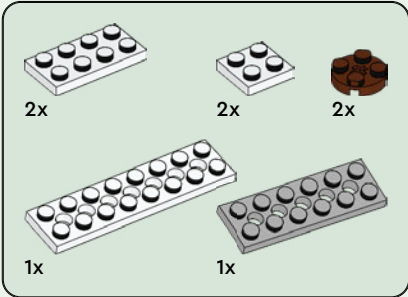
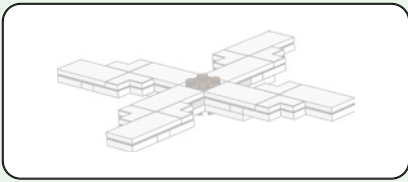

69

1

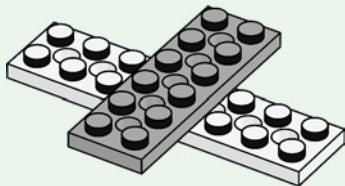

2

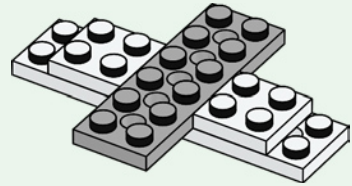

3

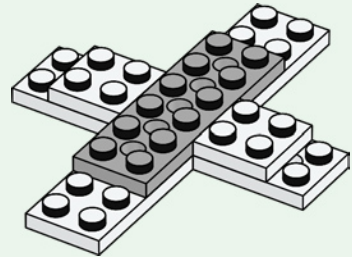

4

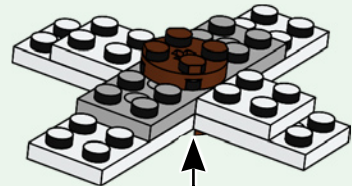

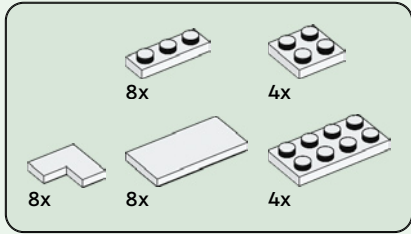
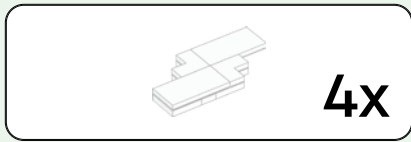

70

1



2

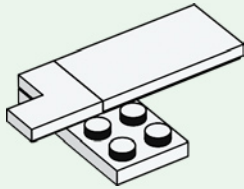

3

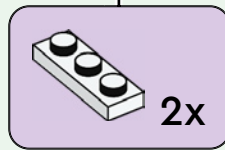
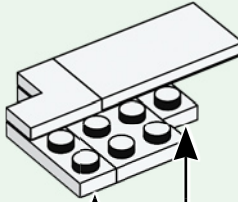

4

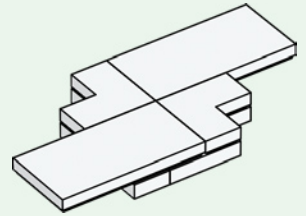

5

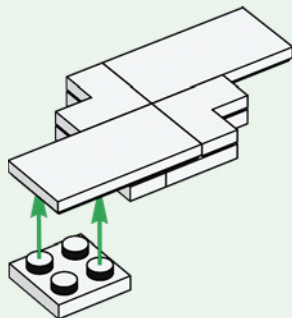

4x

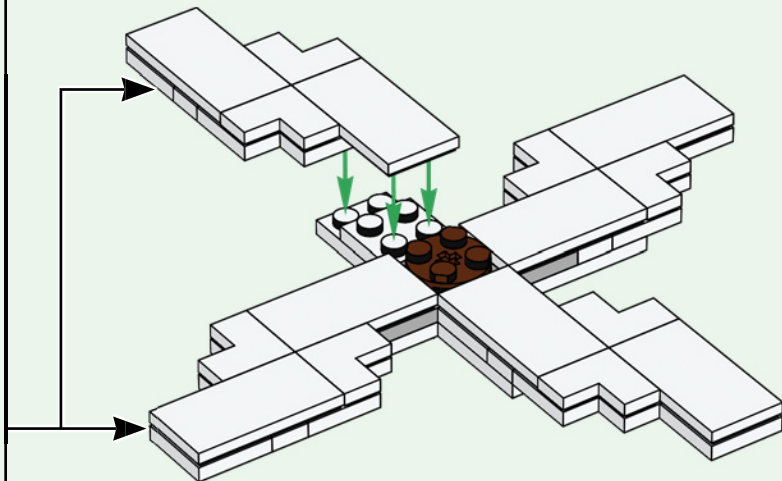

71

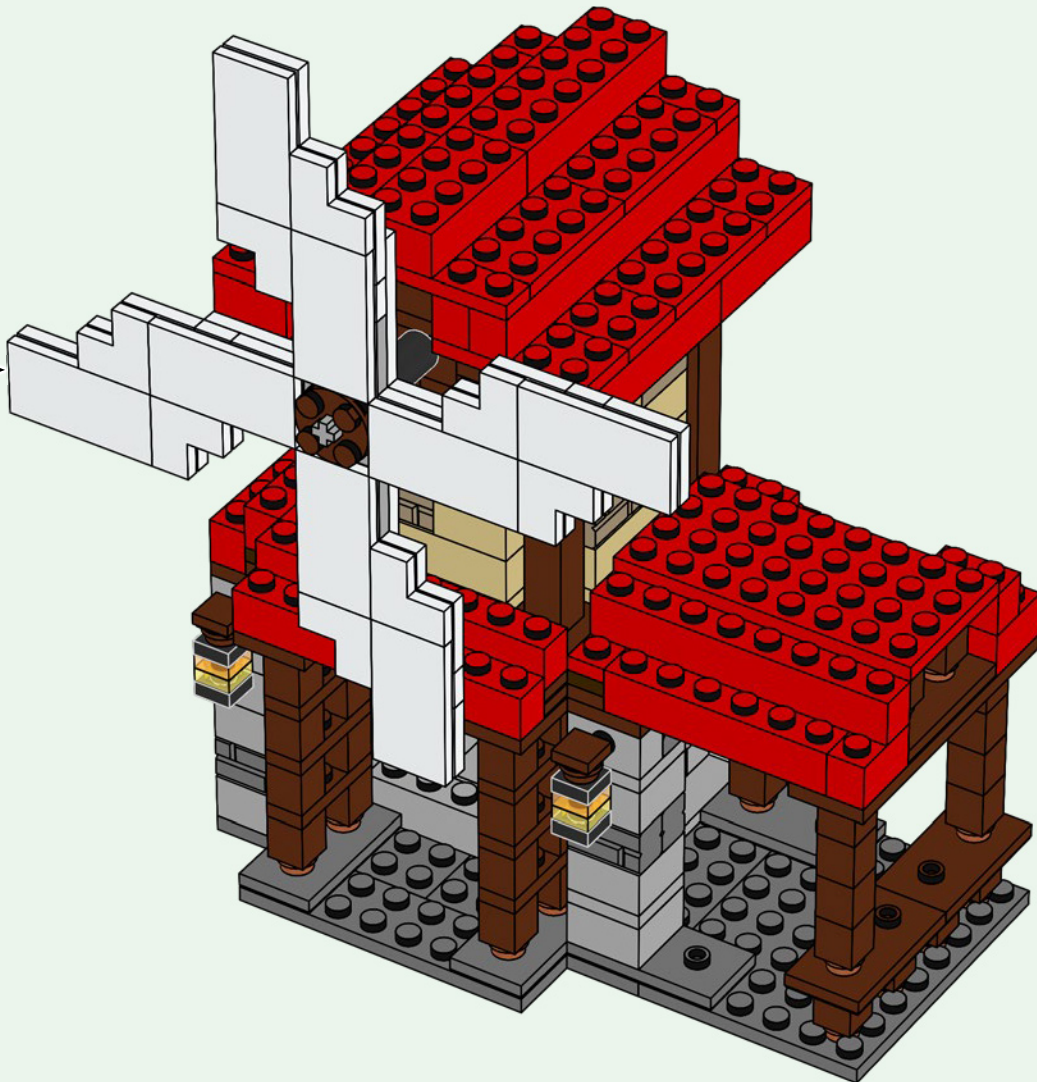









# MINECRAFT

21263



21261



21262



21264































21259



21260



 1x 614101	 4x 6103001	 4x 302321		 1x 6271869	 2x 6382575	 2x 4177932
 1x 6172366	 6x 4109995	 8x 300421	 1x 303521	 1x 389426	 1x 6162390	 1x 6481473
 1x 6296995	 6x 6092587	 1x 300321	 2x 6299764	 1x 373826	 20x 6315782	 1x 4153825
 6x 302201	 1x 6481471	 3x 302221	 2x 302324	 1x 6340684	 1x 6172566	 5x 4153827
 8x 6058329	 1x 6481471	 3x 302221	 1x 6481472		 2x 4570877	 4x 4212454
 4x 300301	 1x 6031962	 3x 300121	 6x 300324		 1x 4615606	 1x 6245275
 2x 235701	 4x 6117975	 6x 302021	 1x 6126050		 1x 6480462	 4x 4646577
 1x 6289797	 1x 6174925	 2x 366621	 2x 302224		 1x 6480462	 2x 6310833
 8x 362301	 2x 4114306	 4x 4181138	 3x 6332148		 2x 6240215	 2x 6310833
 6x 302001	 2x 4118790	 5x 300821	 4x 302426		 1x 6499253	 1x 6464593
 8x 4560178	 7x 4113916	 1x 403226	 2x 300526		 1x 6244887	 1x 6481476
 6x 302001	 6x 4113233	 2x 303221	 1x 403226		 2x 6476399	 3x 6252040
 1x 4527945	 2x 4124067	 1x 6173119	 3x 6173119		 3x 6252045	 5x 6096682
 1x 6264077	 1x 6481474	 1x 6313191	 1x 6313191		 1x 6491607	 30x 4211242
 1x 4565452	 1x 6481474	 2x 611121	 1x 4107765		 2x 4157103	 2x 4211288

5x  
4226966

2x  
6306775

2x  
4211159

16x  
6092590

3x  
4211149

3x  
4211150

2x  
4211252

1x  
6481475

4x  
4565394

7x  
4216695

1x  
6196221

4x  
4211257

1x  
4211210

1x  
4520638

6x  
4211152

2x  
6257604

3x  
4211190

3x  
4211186

3x  
6307618

2x  
4585337

7x  
4211211

2x  
4223683

2x  
6271165

1x  
6057487

1x  
4640536

2x  
6383177

4x  
4211414

3x  
4211388

3x  
4211397

15x  
4211387

2x  
4211815

7x  
4211356

2x  
4211394

2x  
4211393

1x  
4211542

1x  
4535768

1x  
6178172

3

5,5

9

11

2x  
4516546

11x  
6000311

1x  
6013082

1x  
6236949

2x  
6126083

4x  
6307616

1x  
4508553

1x  
4210997

3x  
4210794

2x  
6195315

1x  
4586410

1x  
6005225

1x  
4538950

2x  
6447571

1x  
6507790

2x  
6097024

1x  
6097003

1x  
6096993

1x  
6421061

2x  
4619636

1x  
6104065

1x  
6192828

1x  
6070757

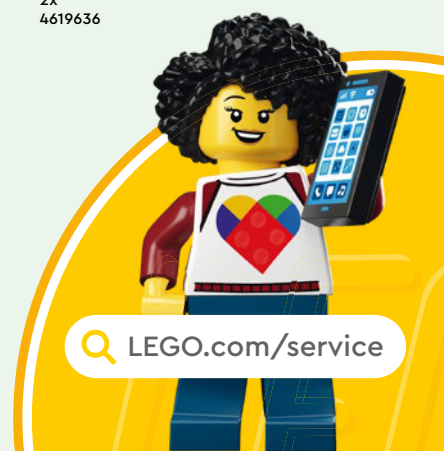

 [LEGO.com/service](https://www.LEGO.com/service)

YOU COULD **WIN**

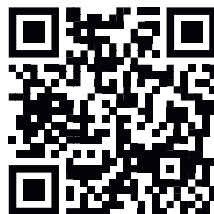

Scan this QR code or go to **LEGO.COM/PRODUCTFEEDBACK** and give us your short feedback about this LEGO® set for a chance to win a cool LEGO prize.

Terms and Conditions apply\*

**EN: YOU COULD WIN.** Terms and Conditions apply\* **DE: Du könntest GEWINNEN.** Es gelten die Teilnahmebedingungen\* **FR: Tu pourrais GAGNER.** Des conditions s'appliquent\* **IT: Potresti VINCERE tu.** Termini e condizioni sono applicabili\* **ES: Puedes GANAR.** Aplican términos y condiciones\* **PT: Poderá GANHAR.** Aplicam-se termos e condições\* **ZH: 轻松获奖. 条款和条件适用\*** **PL: Szansa na WYGRANĄ.** Obowiązują warunki korzystania\* **CS: Máte šanci VYHRÁT.** Platí všeobecné smluvní podmínky\* **SK: Máte šancu VYHRAŤ.** Platia všeobecné zmluvné podmienky\* **HU: TE IS NYERHETSZ.** Felhasználási feltételek érvényesek\* **RO: Ai putea CÂȘTIGA.** Se aplică termeni și condiții\* **BG: Можете да СПЕЧЕЛИТЕ.** Има определени правила и условия\* **LV: Tu vari LAIMĒT.** Ir spēkā noteikumi un nosacījumi.\* **ET: Sul on võimalus VÕITA.** Kehtivad tingimused\* **LT: Jūs galite LAIMĖTI.** Taikomos sąlygos\*

\*[LEGO.com/productfeedback-terms](https://www.lego.com/productfeedback-terms)