



# MINECRAFT

21262



Q LEGO® Builder

1



### **Get excited about our new packaging!**

We're switching from plastic to paper-based packaging. That's why you might find a mix of paper and plastic in our boxes!

### **Nos nouveaux emballages vous emballeront !**

Nous passons des emballages en plastique aux emballages à base de papier. C'est pourquoi vous pourriez trouver un mélange de papier et de plastique dans nos boîtes !

### **¡Te presentamos nuestros nuevos empaques!**

Estamos sustituyendo las bolsas de plástico por bolsas con base de papel. ¡Por eso, puedes encontrar una mezcla de papel y de plástico en nuestras cajas!

**[LEGO.com/sustainable-packaging](https://www.lego.com/sustainable-packaging)**

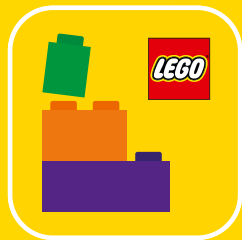

Q LEGO® Builder

# BUILDER



Apple and the Apple logo are trademarks of Apple Inc., registered in the U.S. and other countries and regions. App Store is a service mark of Apple Inc. Google Play and the Google Play logo are trademarks of Google LLC. Tencent and the Tencent logo are trademarks of Tencent Inc.

Q [LEGO.com/devicecheck](https://www.lego.com/devicecheck)

**EN** Ask parents' permission before going online | **DE** Eltern um Erlaubnis bitten, bevor du online gehst | **FR** Demande l'autorisation d'un parent avant d'aller en ligne | **IT** Chiedi il permesso ai tuoi genitori prima di andare online | **ES** Pídeles permiso a tus papás antes de conectarte a Internet | **PT** Pede autorização aos pais antes de acederes online | **ZH** 上网前应先征得父母的同意 | **PL** Poproś rodziców o zgodę, zanim wejdziesz do Internetu | **CS** Než půjdeš na internet, požádej rodiče o svolení | **SK** Skôr než pôjdeš na internet, vypýtaj si povolenie od rodičov | **HU** Kérj szülői engedélyt, mielőtt online csatlakoznál! | **RO** Cere permisiunea părinților înainte de a te conecta online | **BG** Поискайте разрешение от родител, преди да влезете онлайн | **LV** Pirms došanās tiešsaistē palūdz atļauju vecākiem | **ET** Enne Interneti kasutamist küsi vanematelt luba | **LT** Prieš prisijungdami prie interneto, atsiklauskite tėvų





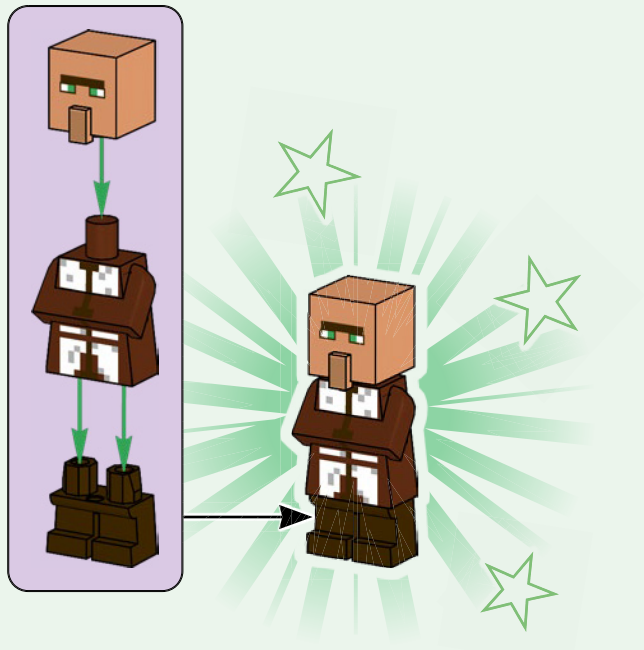

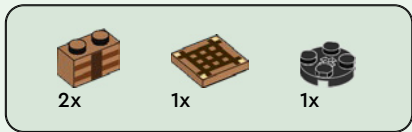

1

1



2

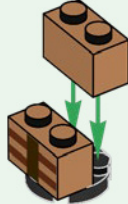

3





2

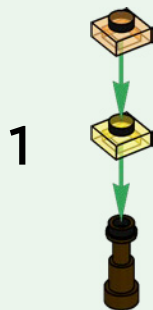

2

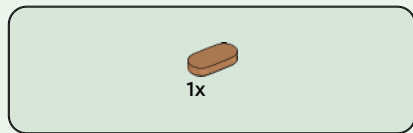

3



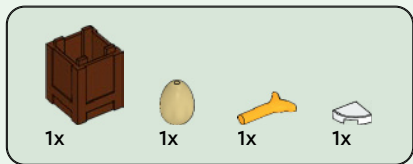
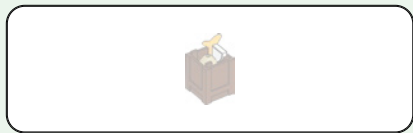

4

1



2

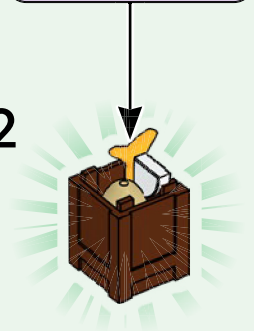
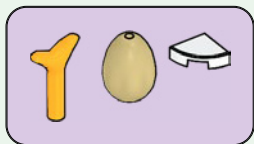

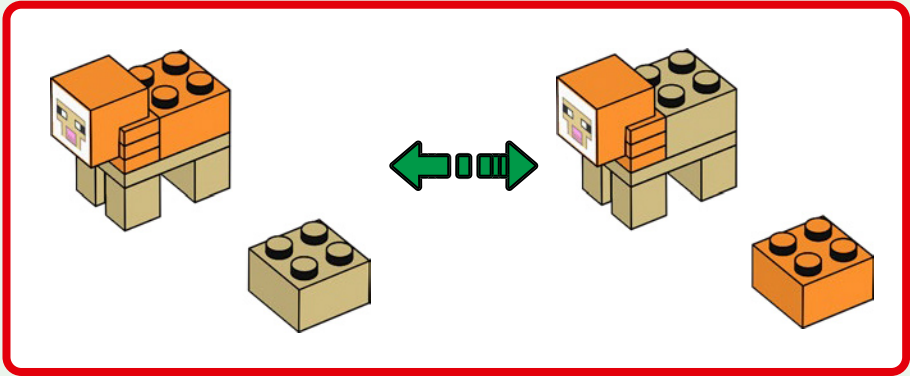
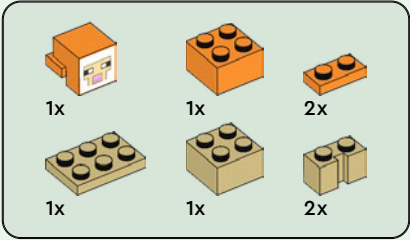
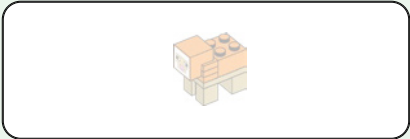

# 5

1

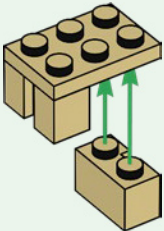

2

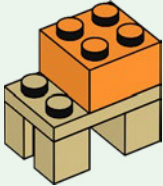

3

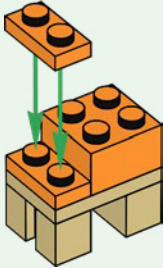

4

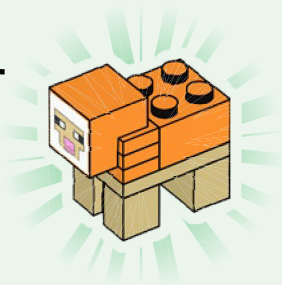





1x



2x



1x

# 6

## 1

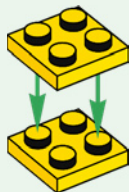

## 2

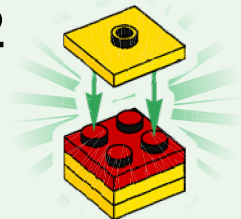

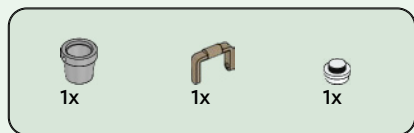

7

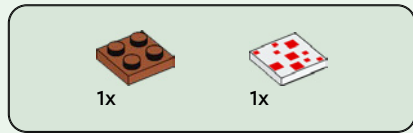

8

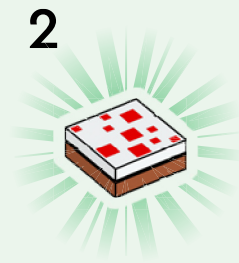
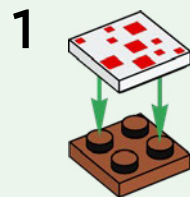

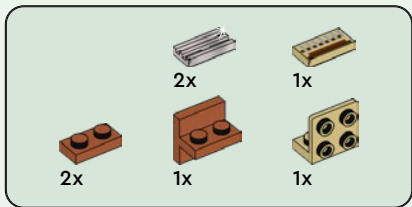

9

1

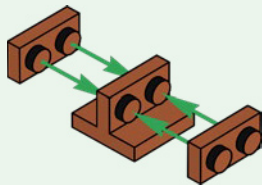

2

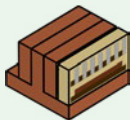

3



4



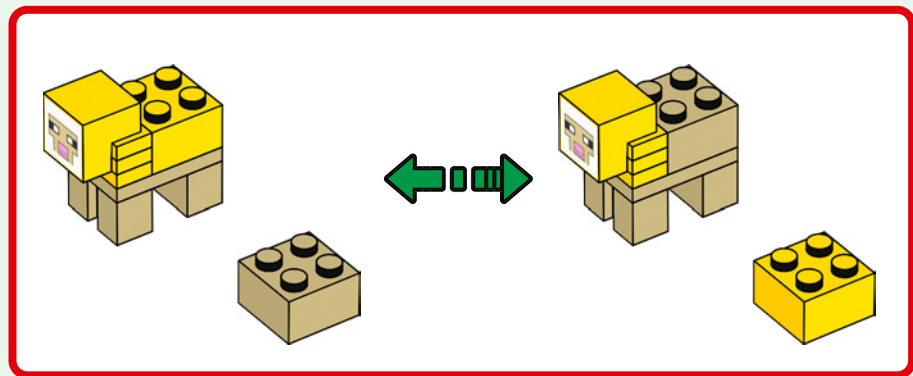
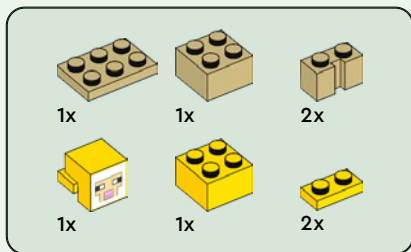

10

1

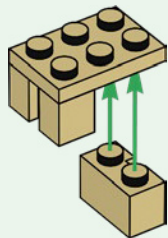

2

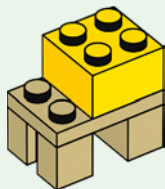

3

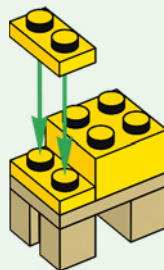

4



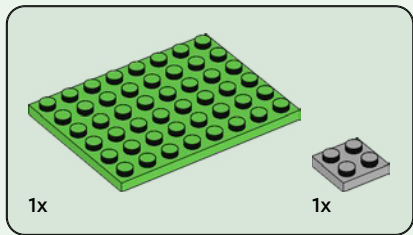
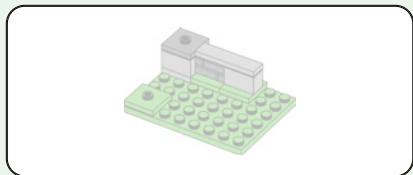

11

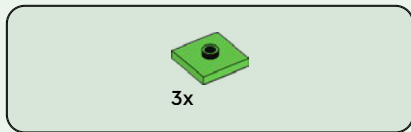
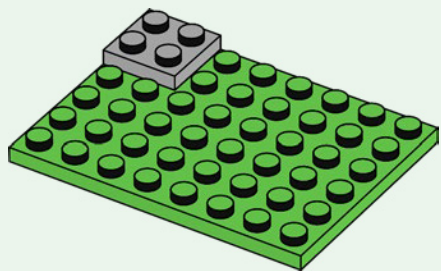

12

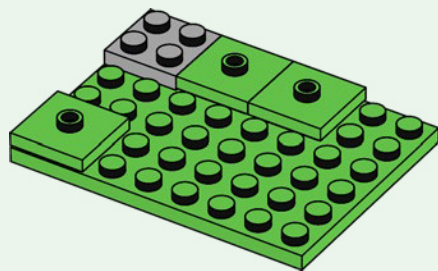



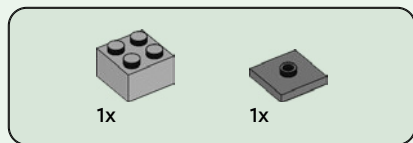

13

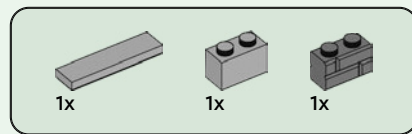
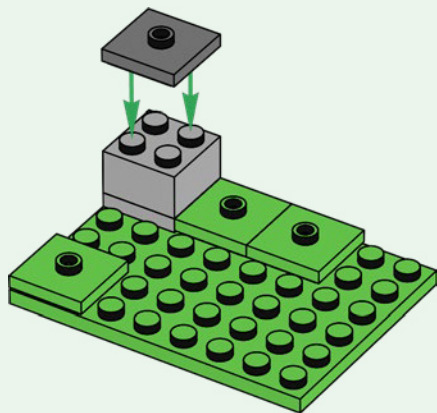

14

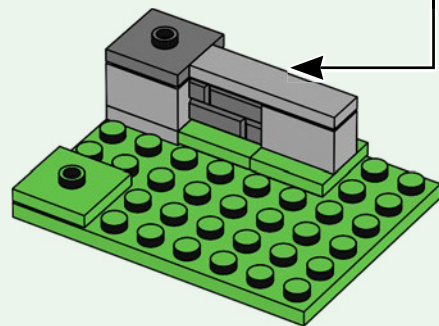
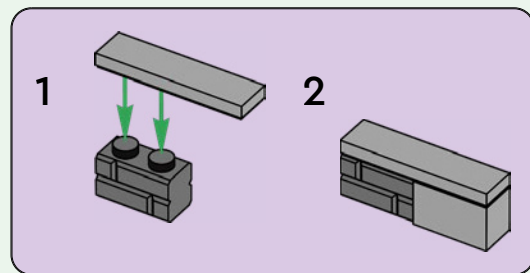

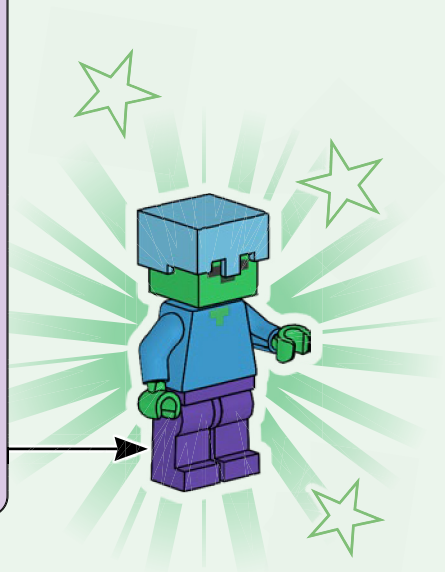
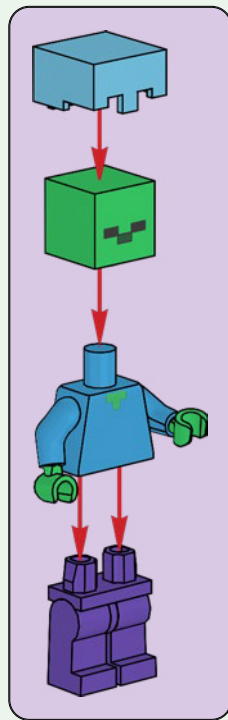

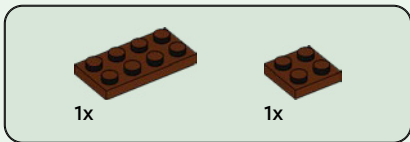
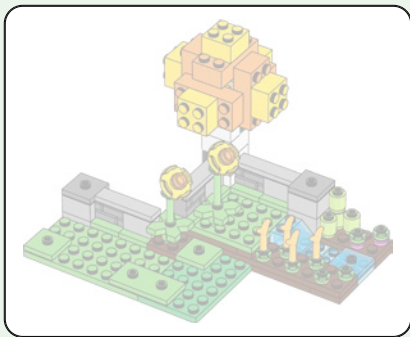

15

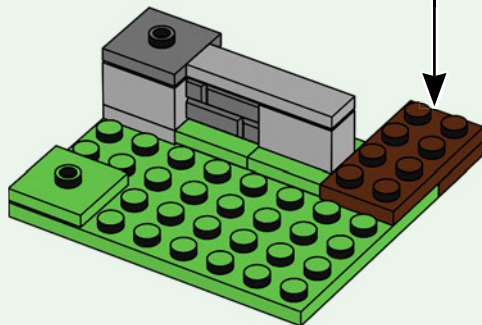
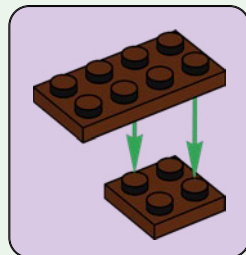



1x

16

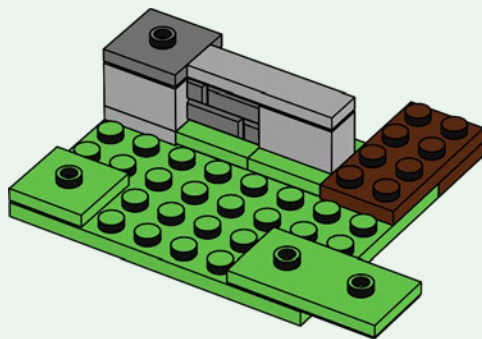

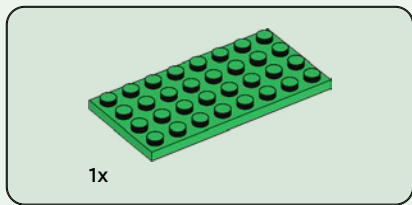

17

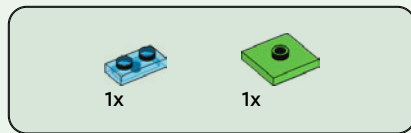
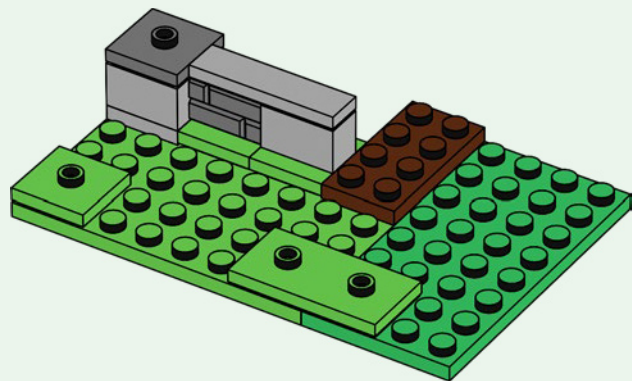

18

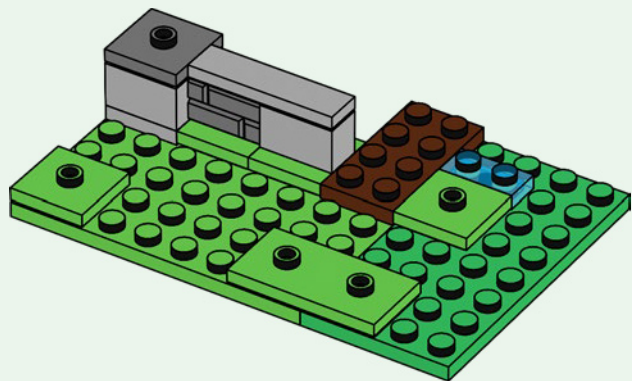



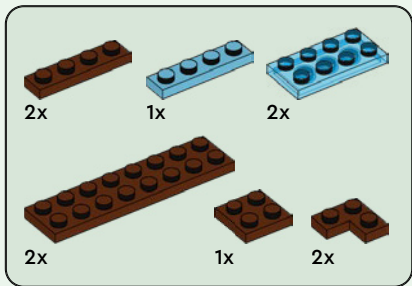
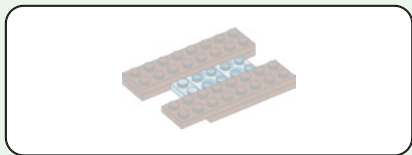

19

1

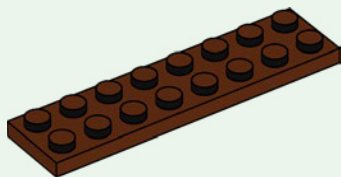

2

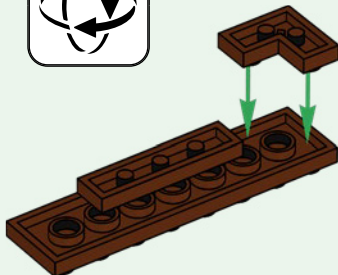

3

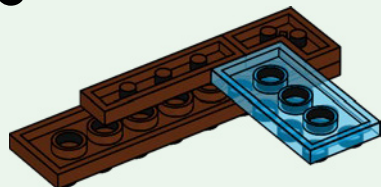

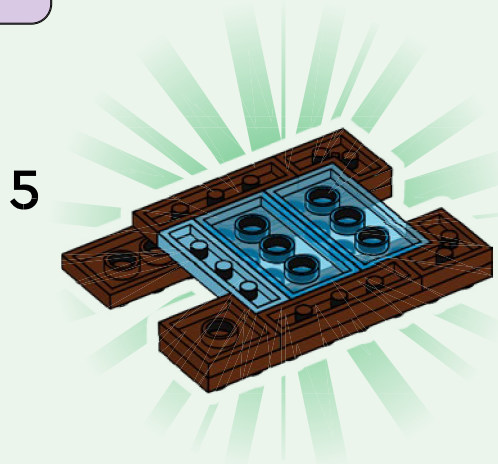
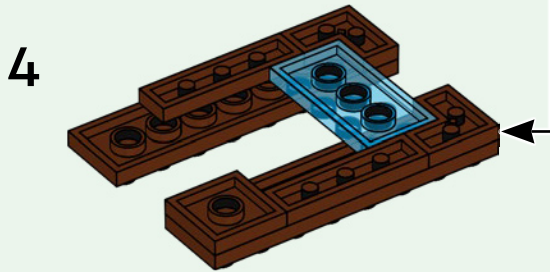
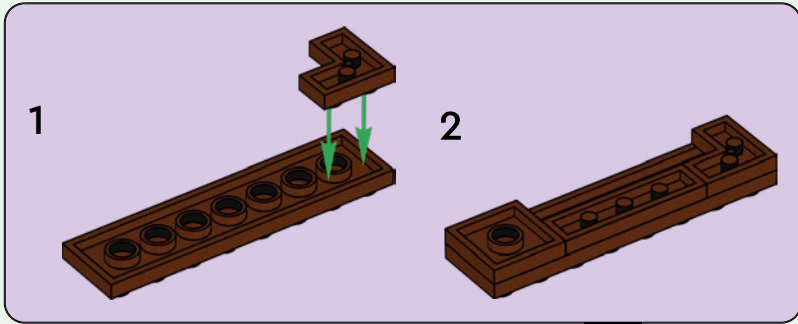

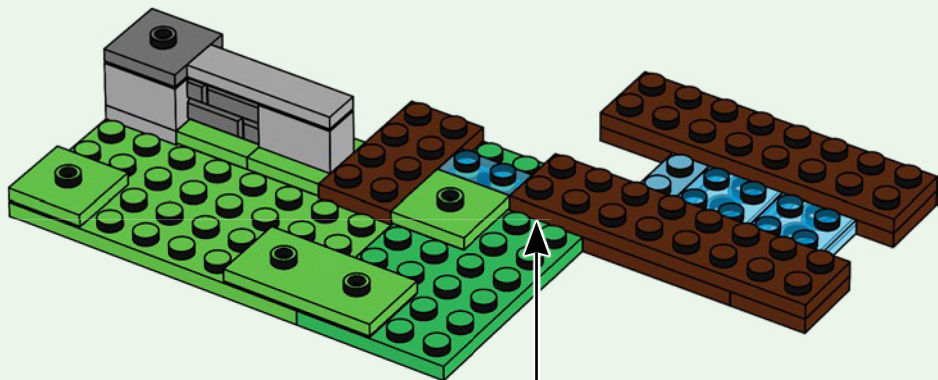



1x

20

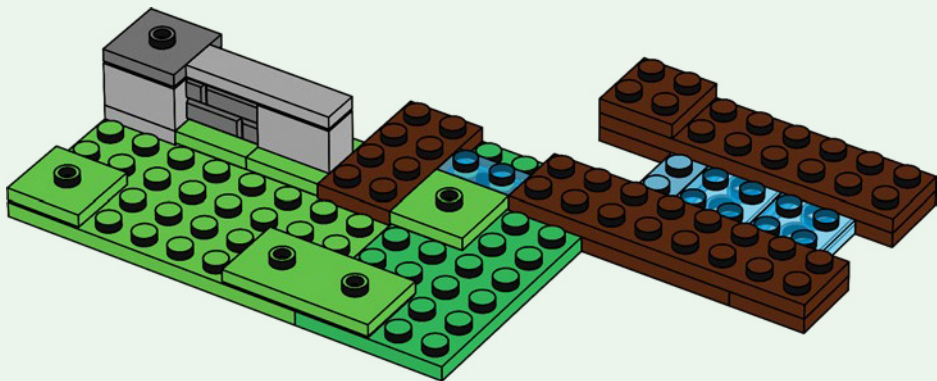

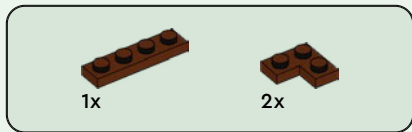

21

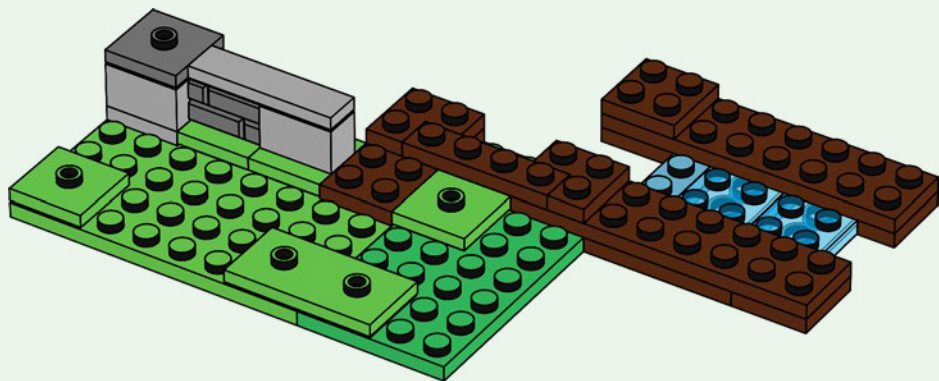





1x

22

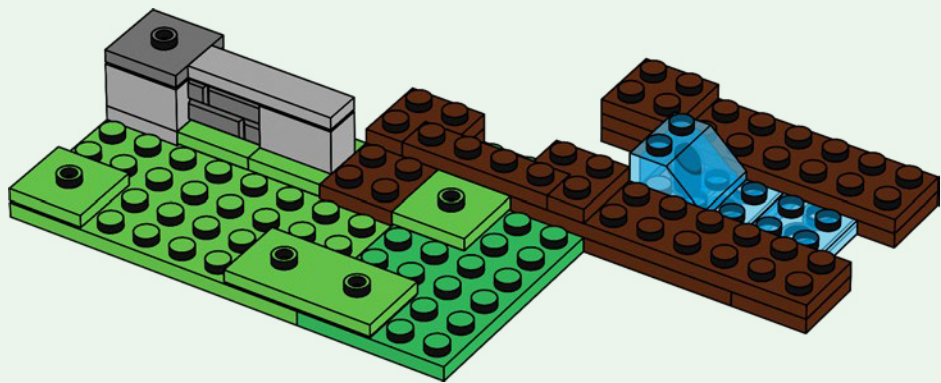



1x



1x

# 23

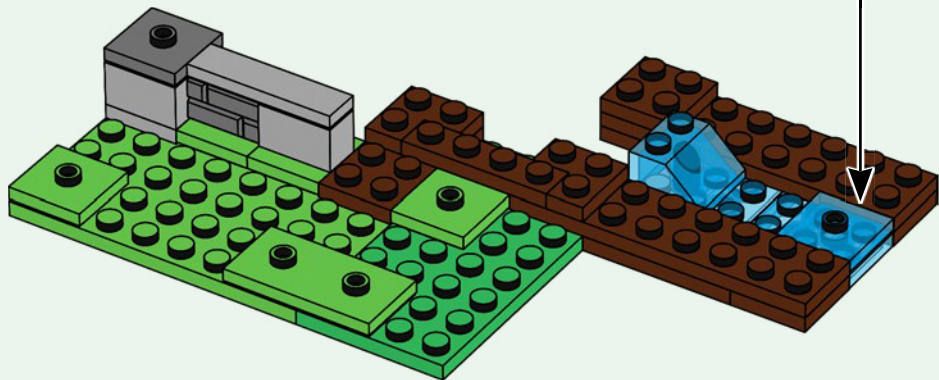
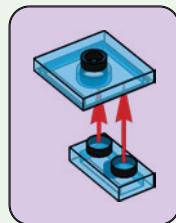

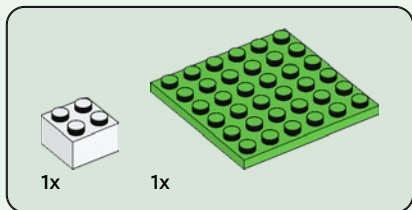
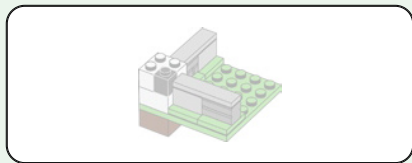

24

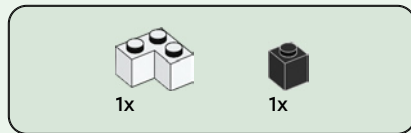
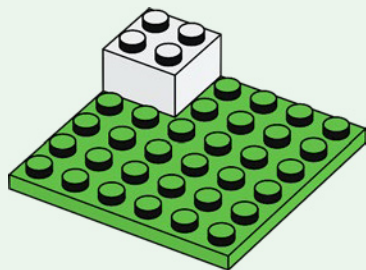

25

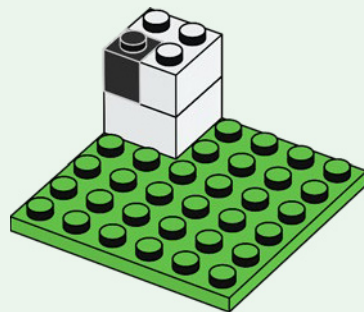



4x

26

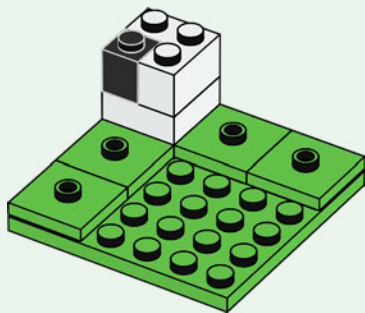

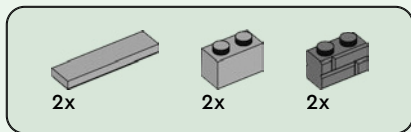

27

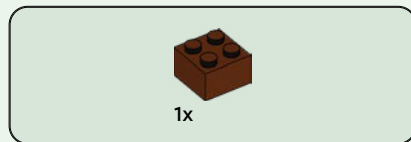
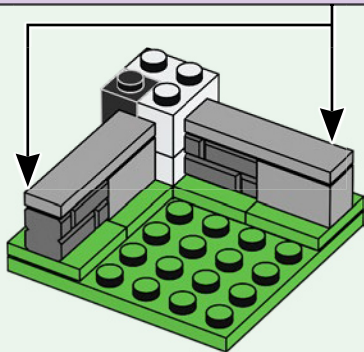
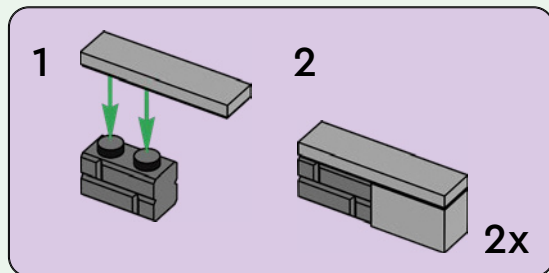

28

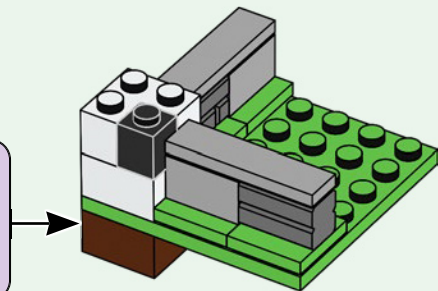
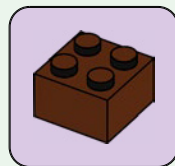

29

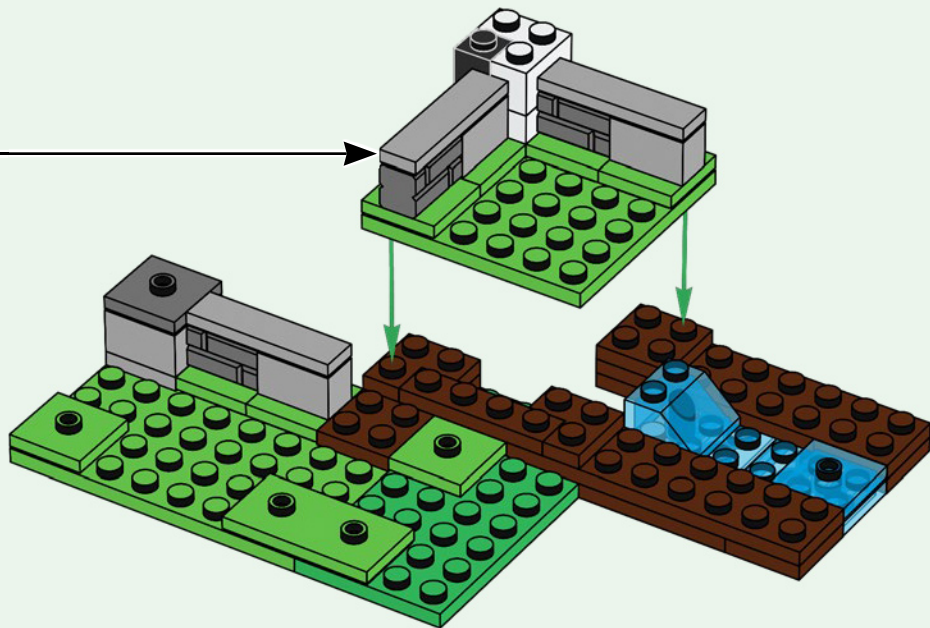

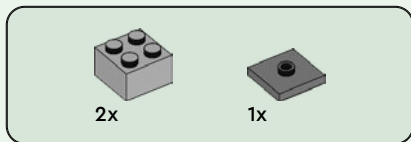

30

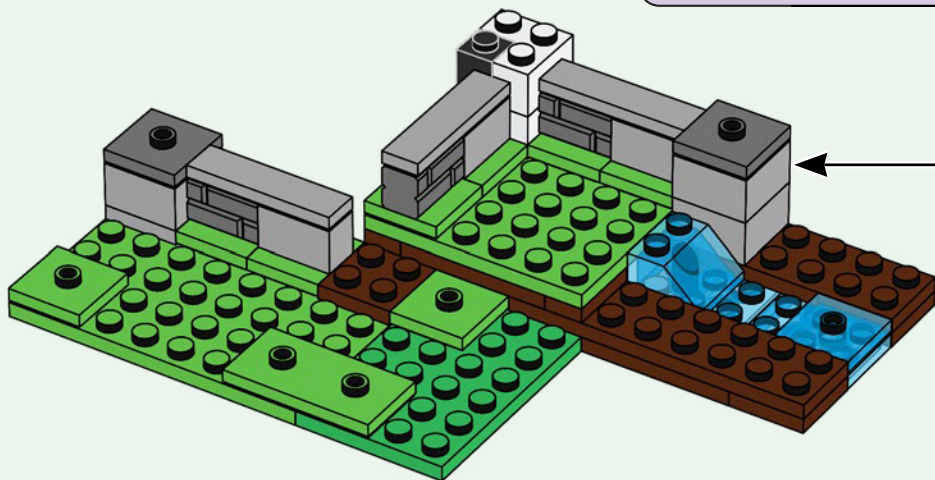
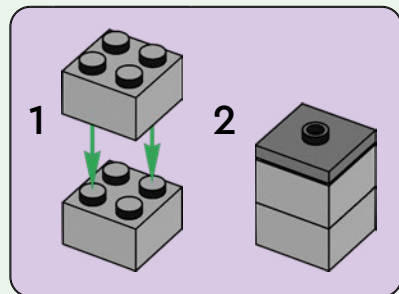



4x

31

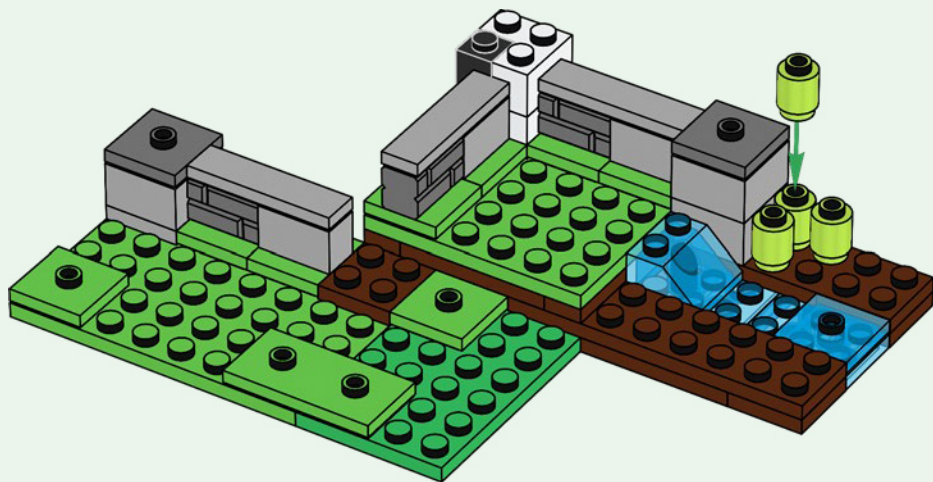



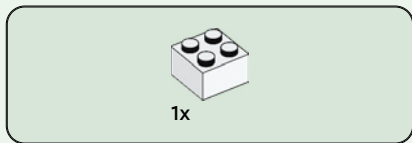
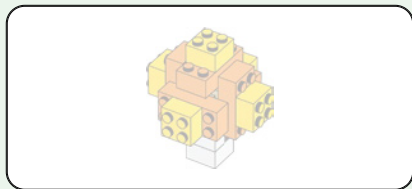

32

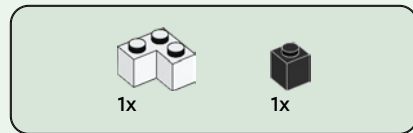
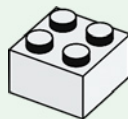

33

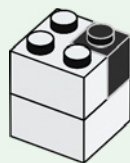



2x

34

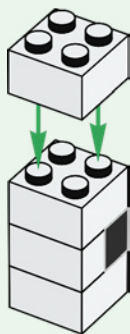

2x

35

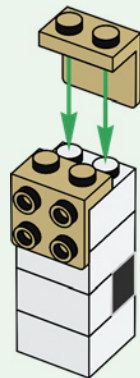

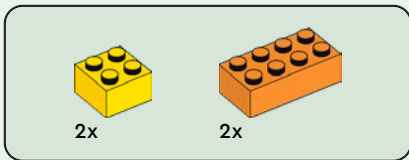

36

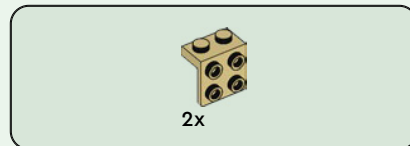
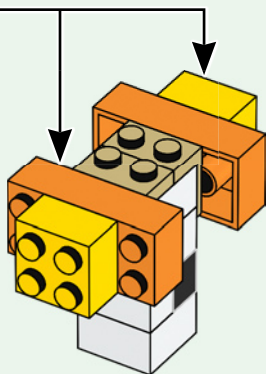
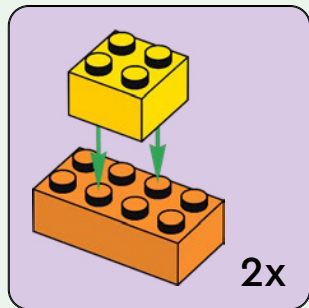

37

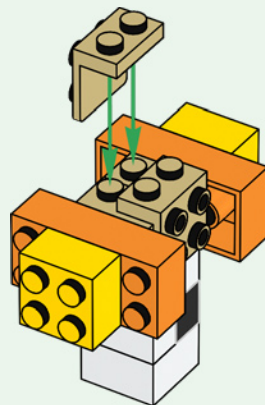

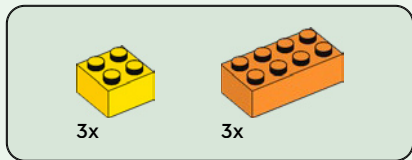

38

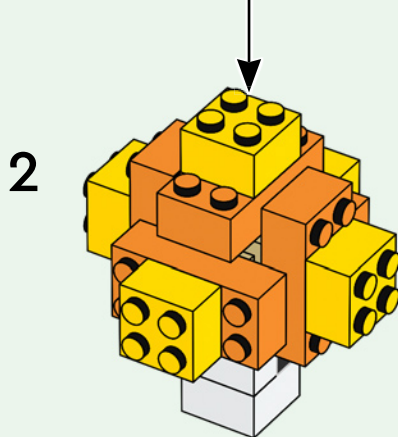
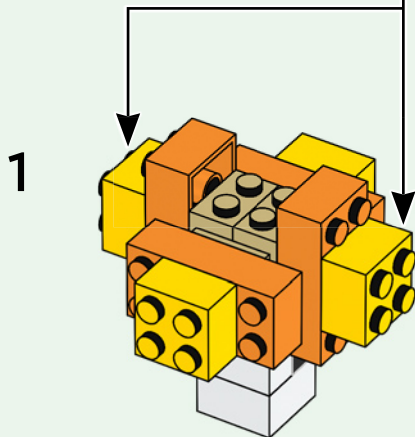
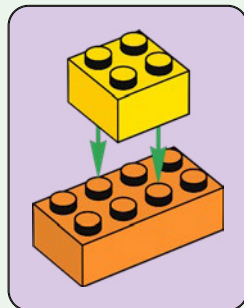
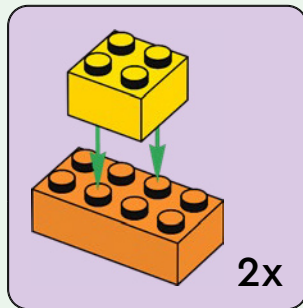

39

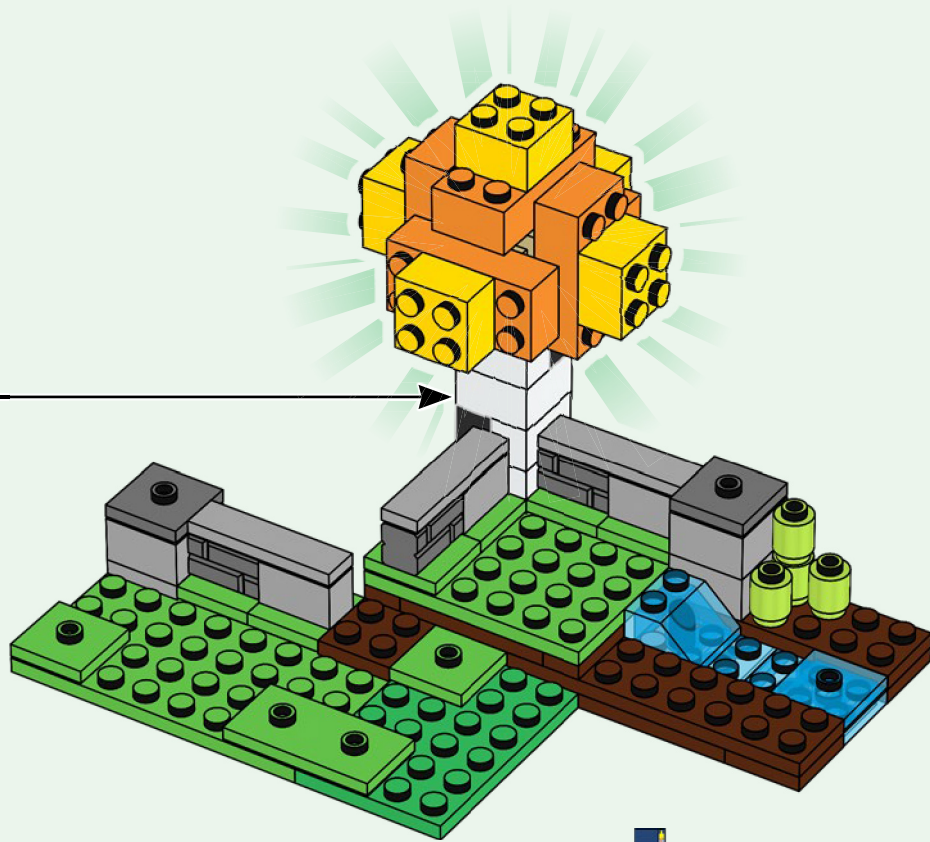



2x



2x

40

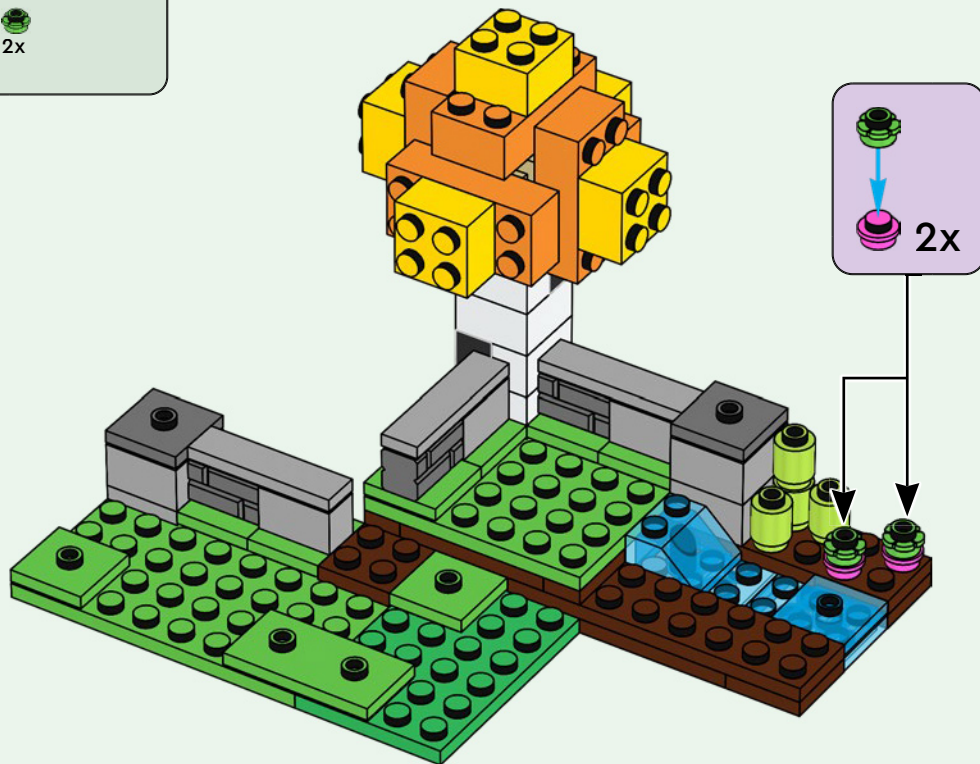

2x



2x

41



2x

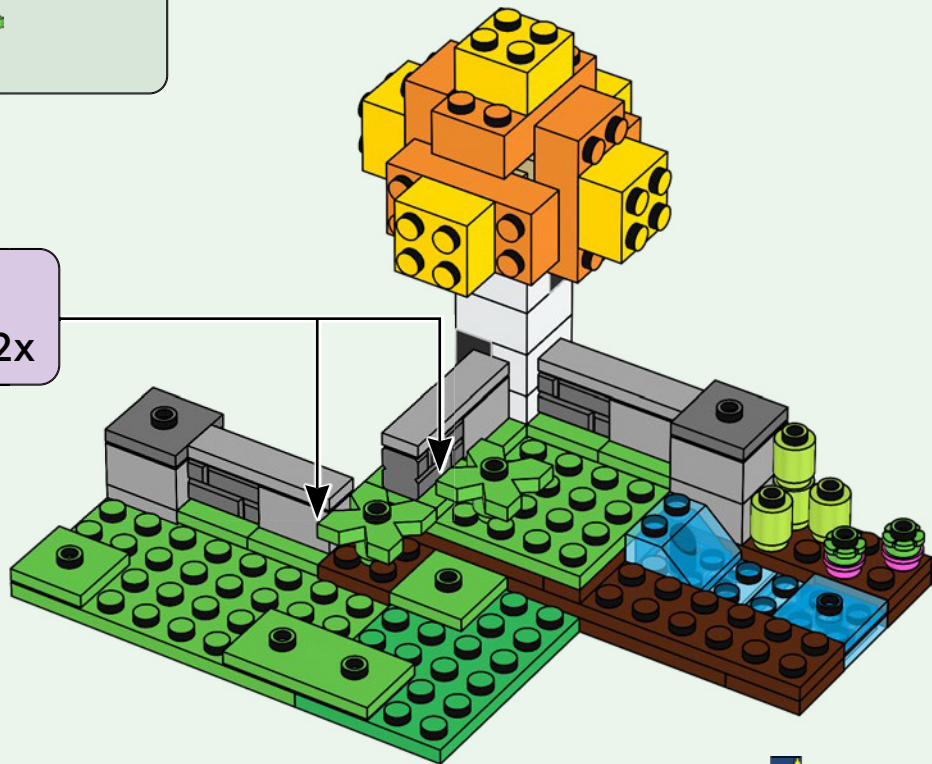

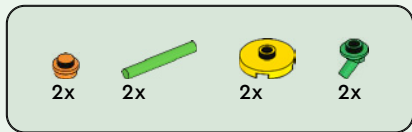

42

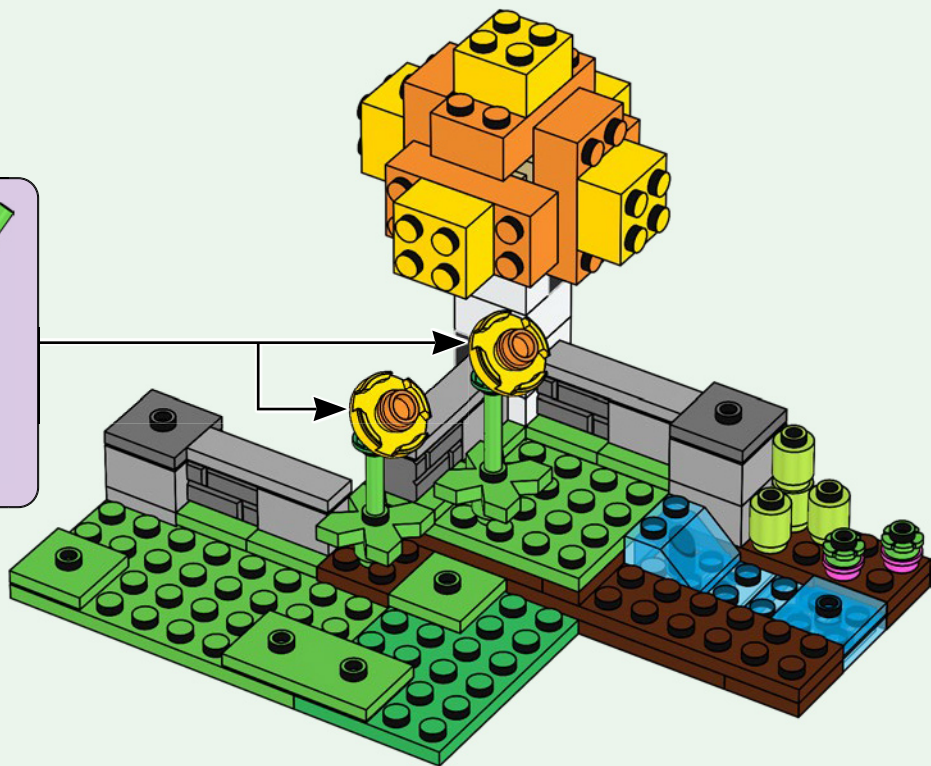
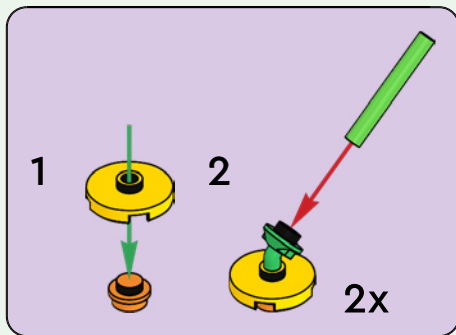





3x

43

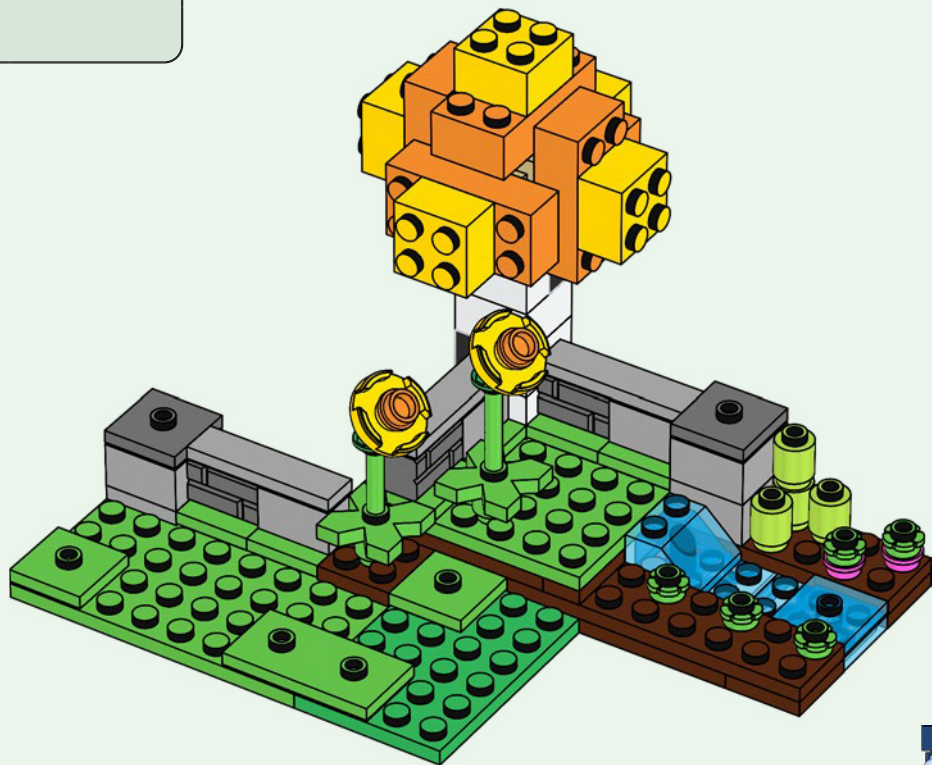



3x

44

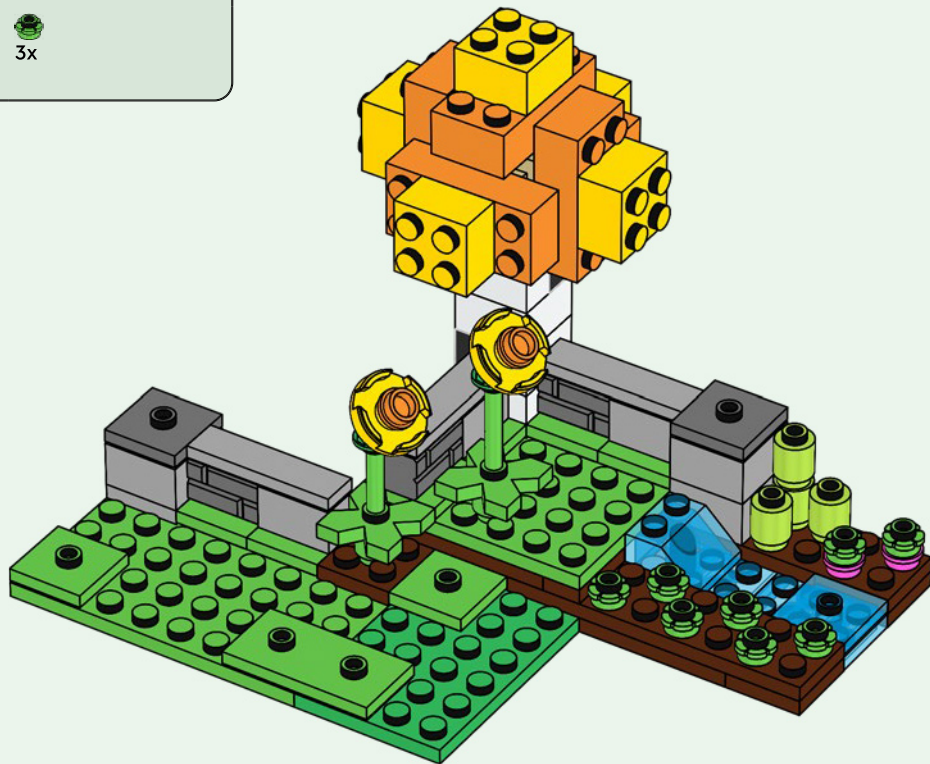



4x

45

