



MINECRAFT

21260



Q LEGO® Builder



Get excited about our new packaging!

We're switching from plastic to paper-based packaging. That's why you might find a mix of paper and plastic in our boxes!

Nos nouveaux emballages vous emballeront !

Nous passons des emballages en plastique aux emballages à base de papier. C'est pourquoi vous pourriez trouver un mélange de papier et de plastique dans nos boîtes !

¡Te presentamos nuestros nuevos empaques!

Estamos sustituyendo las bolsas de plástico por bolsas con base de papel. ¡Por eso, puedes encontrar una mezcla de papel y de plástico en nuestras cajas!

[LEGO.com/sustainable-packaging](https://www.lego.com/sustainable-packaging)

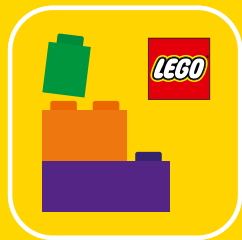

Q LEGO® Builder

BUILDER



Apple and the Apple logo are trademarks of Apple Inc., registered in the U.S. and other countries and regions. App Store is a service mark of Apple Inc. Google Play and the Google Play logo are trademarks of Google LLC. Tencent and the Tencent logo are trademarks of Tencent Inc.

Q LEGO.com/devicecheck

EN Ask parents' permission before going online | **DE** Eltern um Erlaubnis bitten, bevor du online gehst | **FR** Demande l'autorisation d'un parent avant d'aller en ligne | **IT** Chiedi il permesso ai tuoi genitori prima di andare online | **ES** Pídeles permiso a tus papás antes de conectarte a Internet | **PT** Pede autorização aos pais antes de acederes online | **ZH** 上网前应先征得父母的同意 | **PL** Poproś rodziców o zgodę, zanim wejdziesz do Internetu | **CS** Než půjdeš na internet, požádej rodiče o svolení | **SK** Skôr než pôjdeš na internet, vypýtaj si povolenie od rodičov | **HU** Kérj szülői engedélyt, mielőtt online csatlakoznál! | **RO** Cere permisiunea părinților înainte de a te conecta online | **BG** Поискайте разрешение от родител, преди да влезете онлайн | **LV** Pirms došanās tiešsaistē palūdz atļauju vecākiem | **ET** Enne Interneti kasutamist küsi vanematelt luba | **LT** Prieš prisijungdami prie interneto, atsiklauskite tėvų



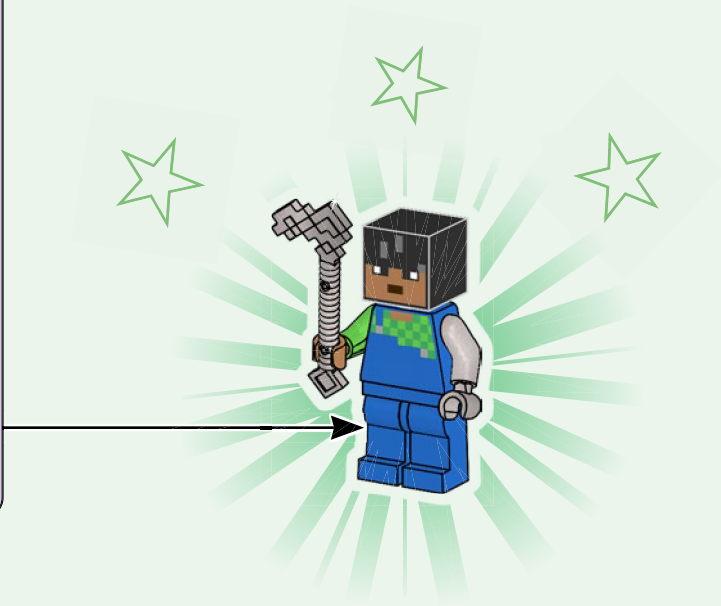
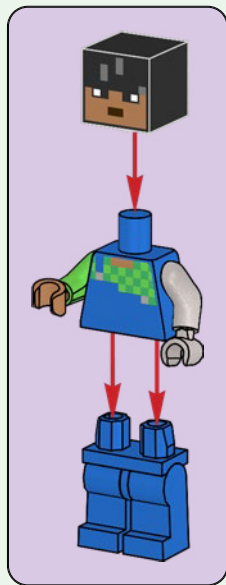

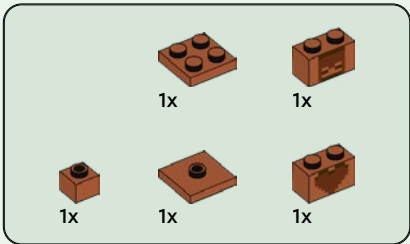
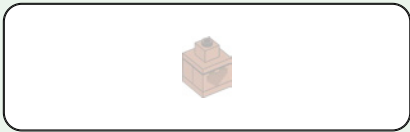

1



2



3

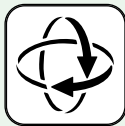

4



5

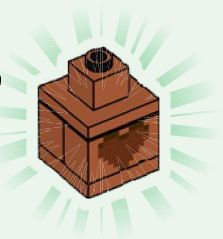

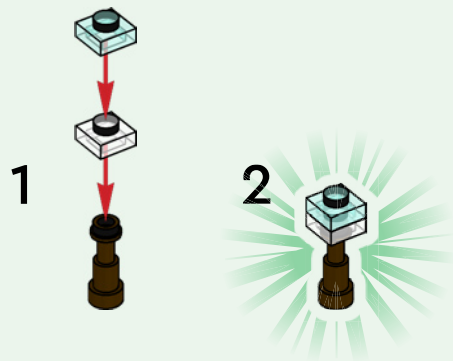
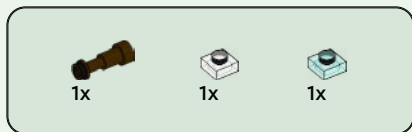
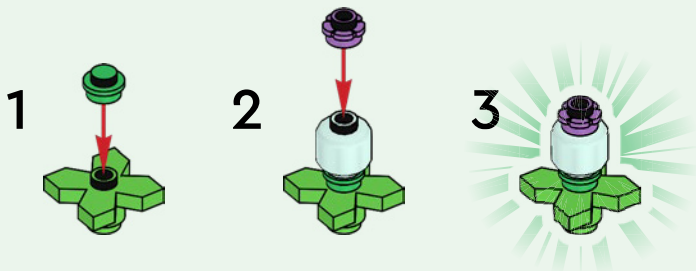
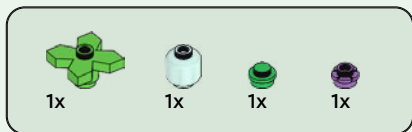

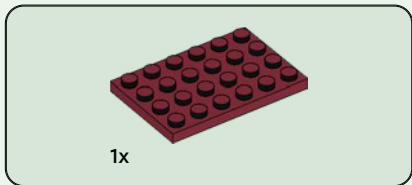
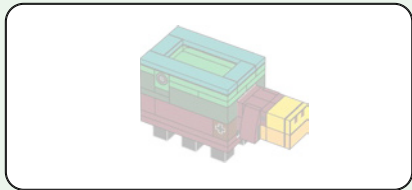

1x

1

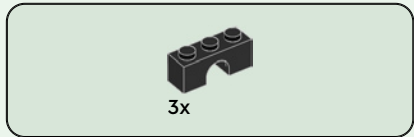
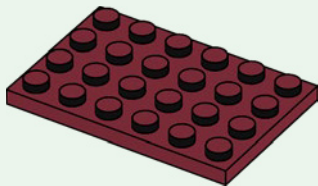

3x

2

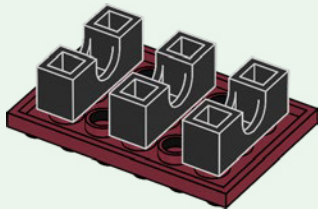

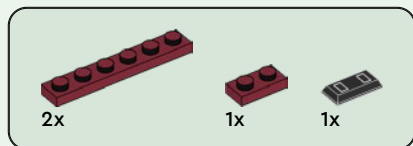

3

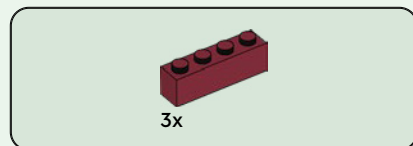
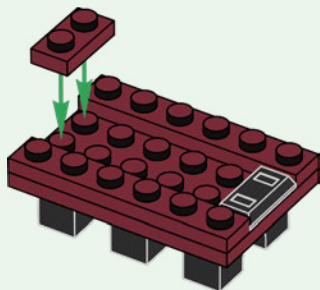

4

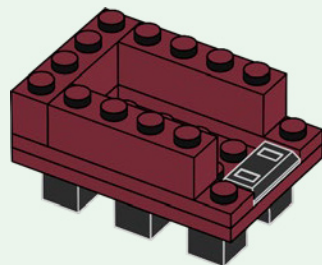



1x



1x

5

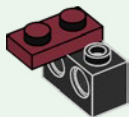

1x

6

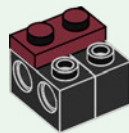

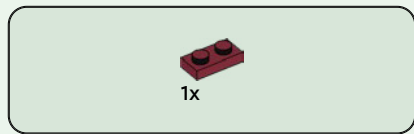

7

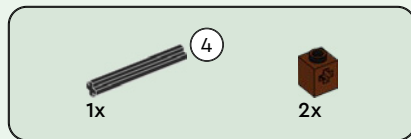

8

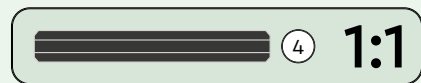
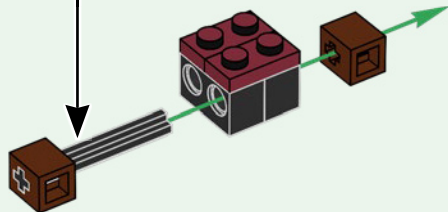
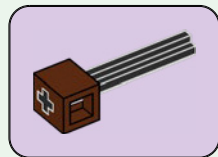



4x

9

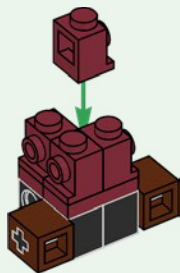

2x



2x

10

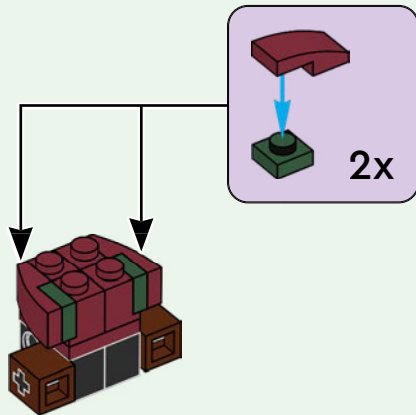



1x



2x

11

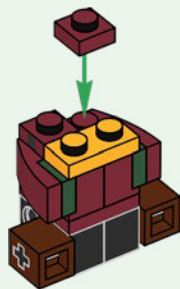

1x



1x

12



1x



1x

13





14

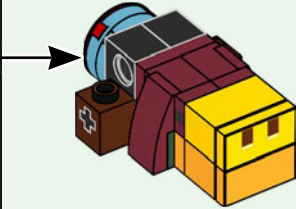
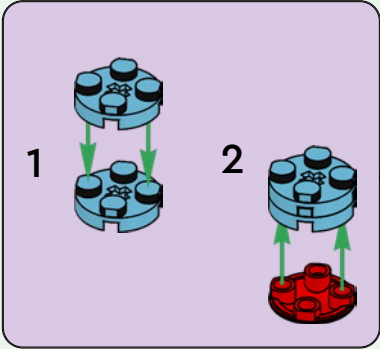

15

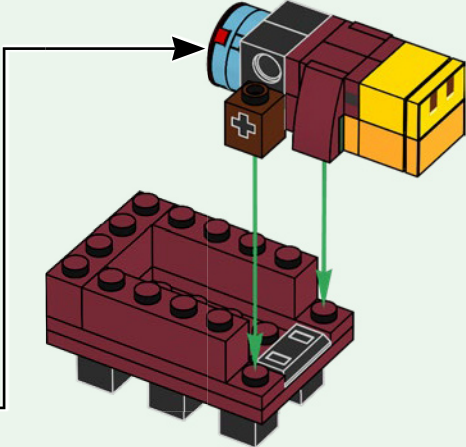



3x

16

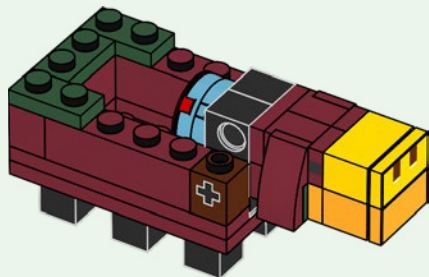

2x

17

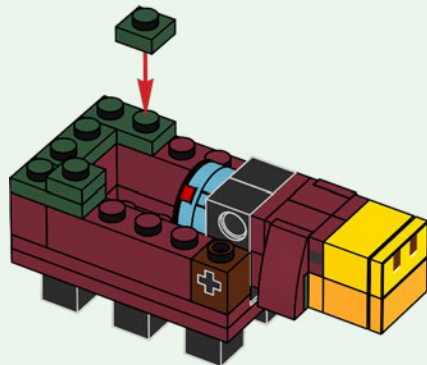



3x

18

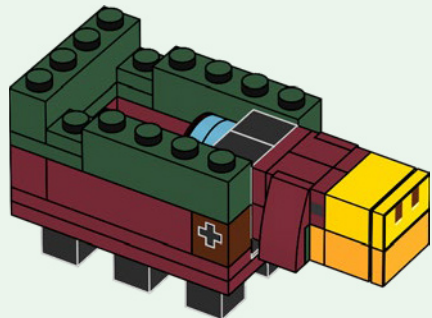

1x



2x

19

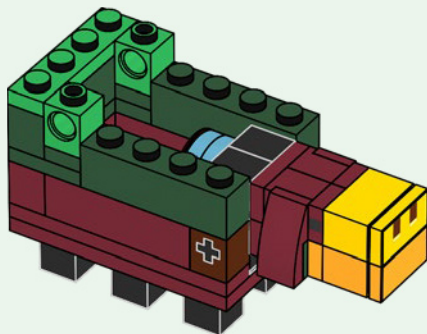

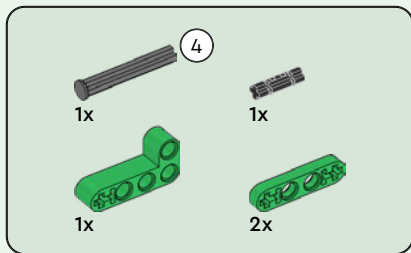

20

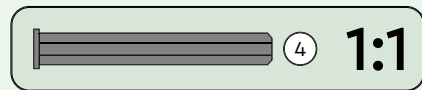
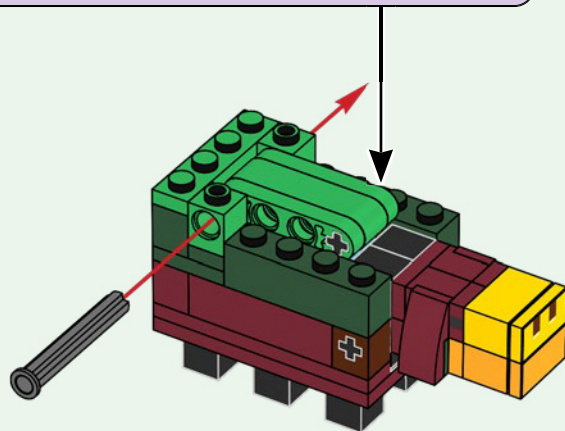
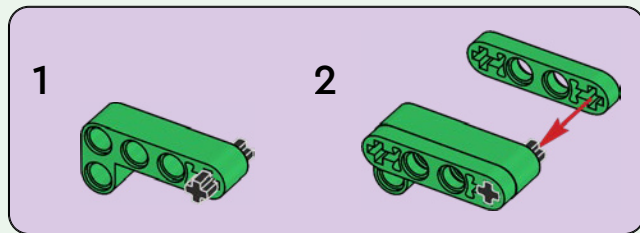



2x



2x

21

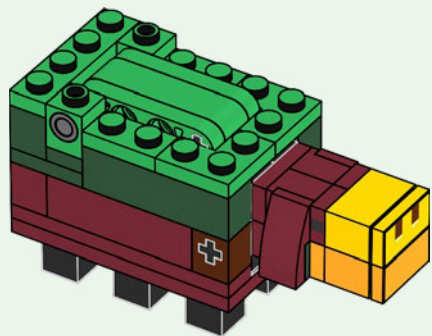

1x

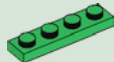

2x

22

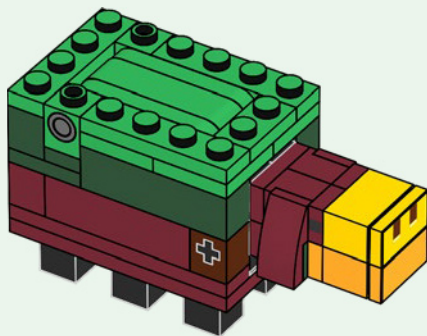

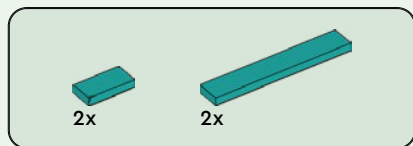

23

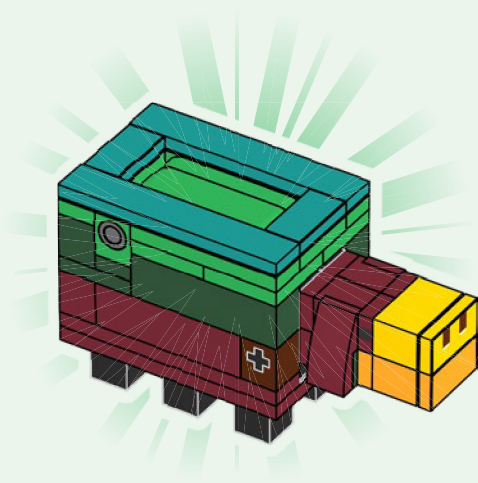

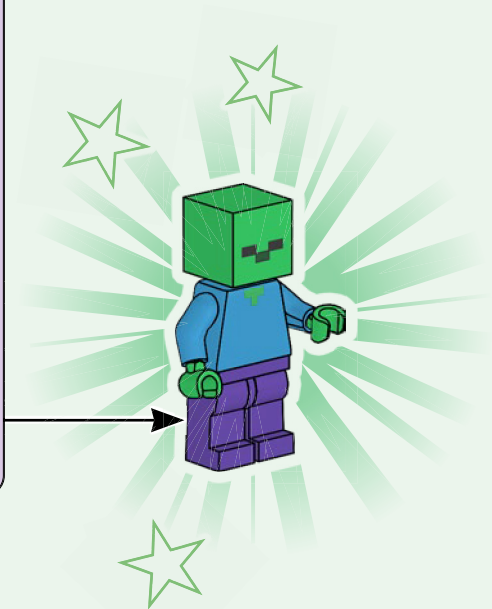
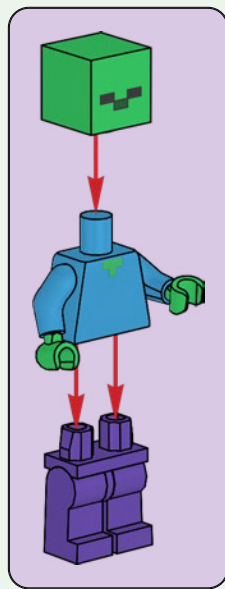

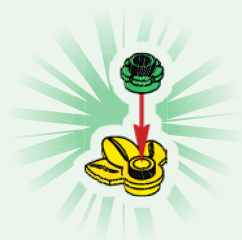
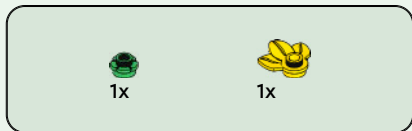



1x



1



6x

2

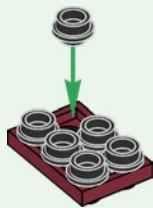



1x



1x

3

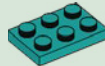
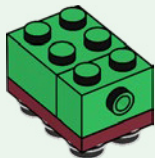

1x

4





1x

5

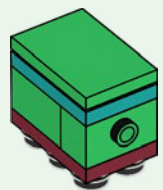

1x



1x



2x



1x

6

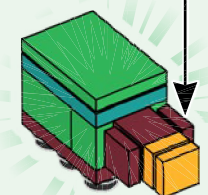
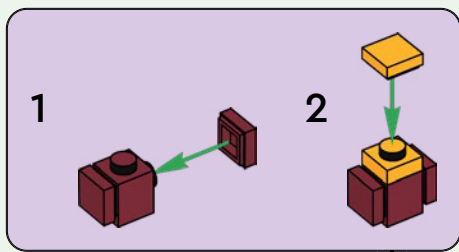



2x



2x



2x



2x



4x



2x



2x

1



2

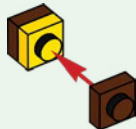

3



4

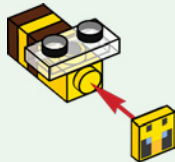

5



2x

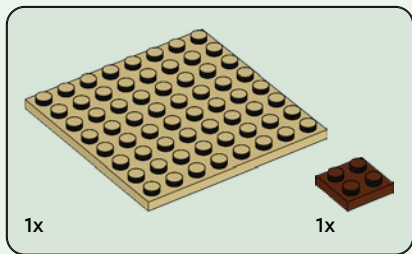
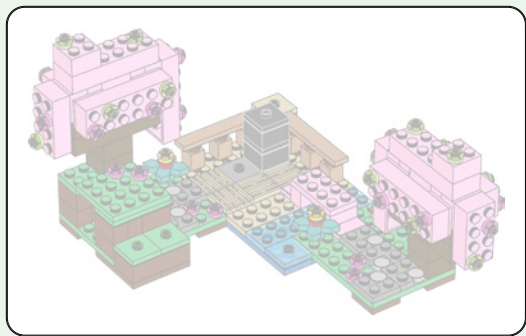

1

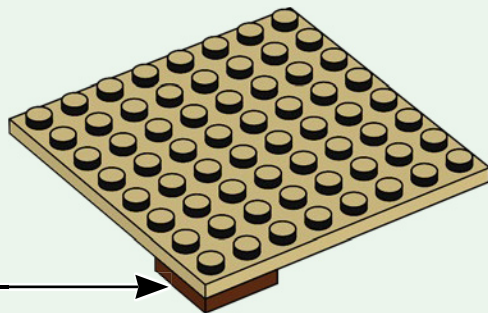

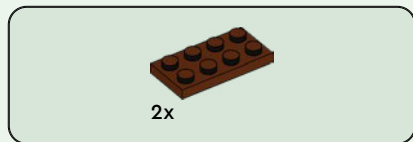

2

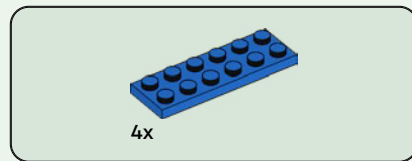
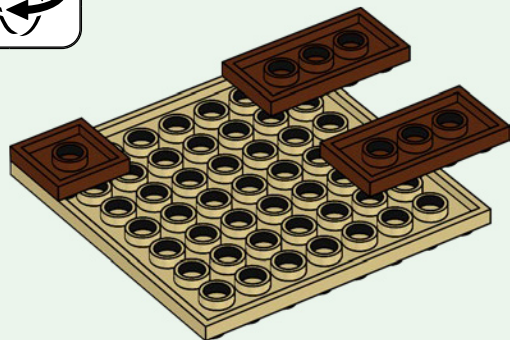

3

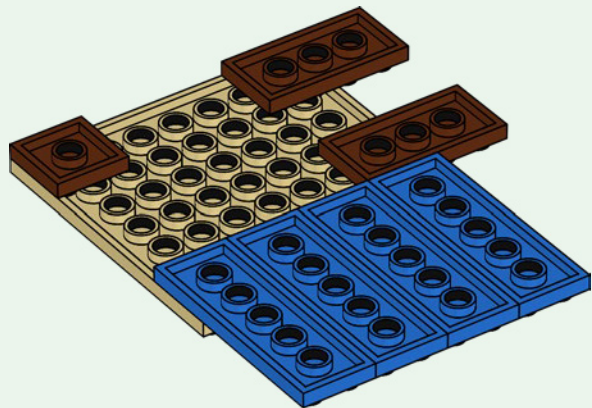

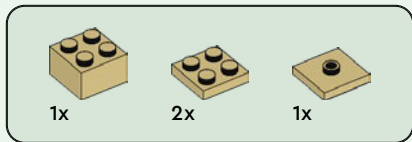

4

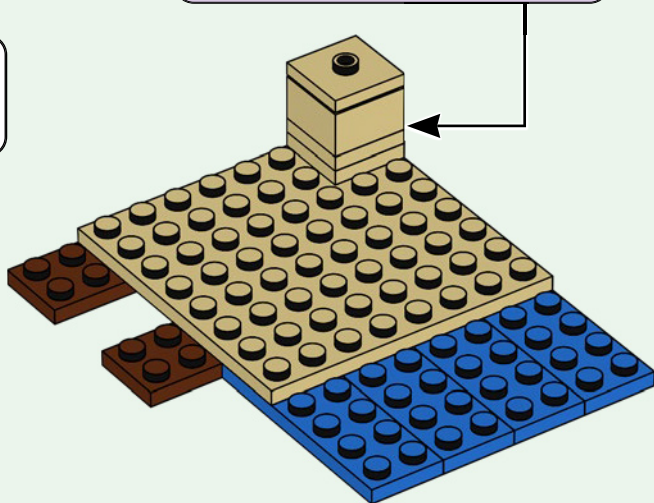
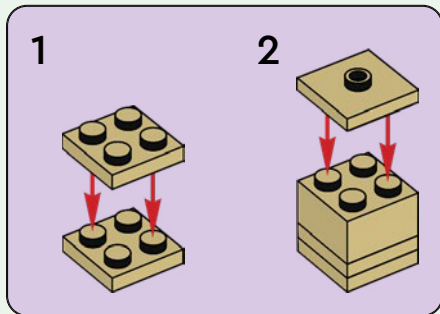



5

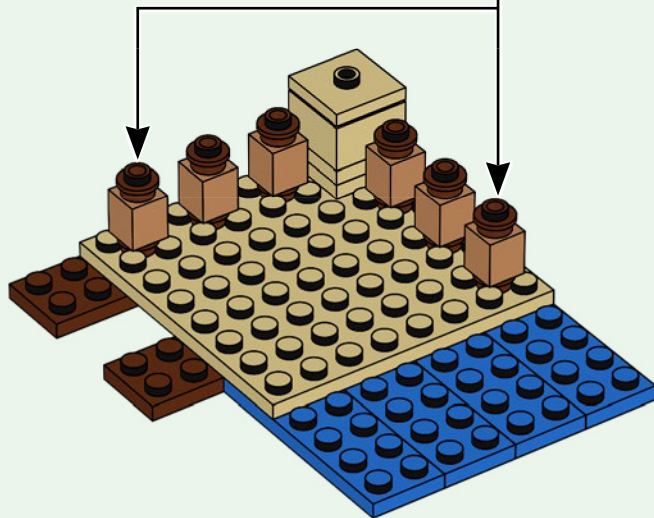
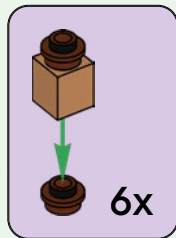

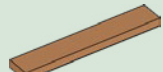

2x

6

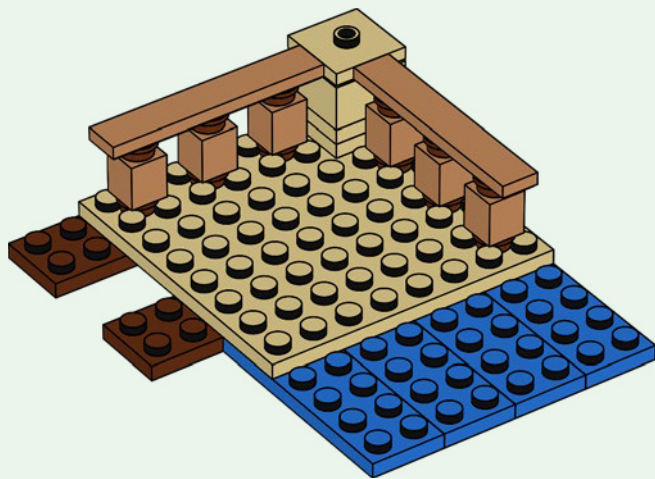



2x

7

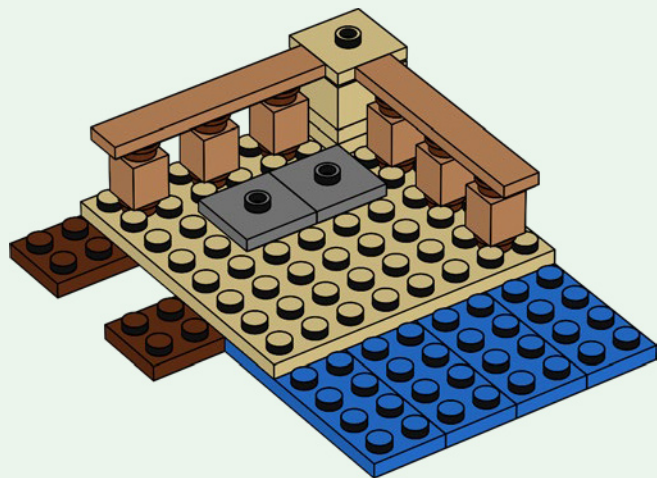



2x



1x

8

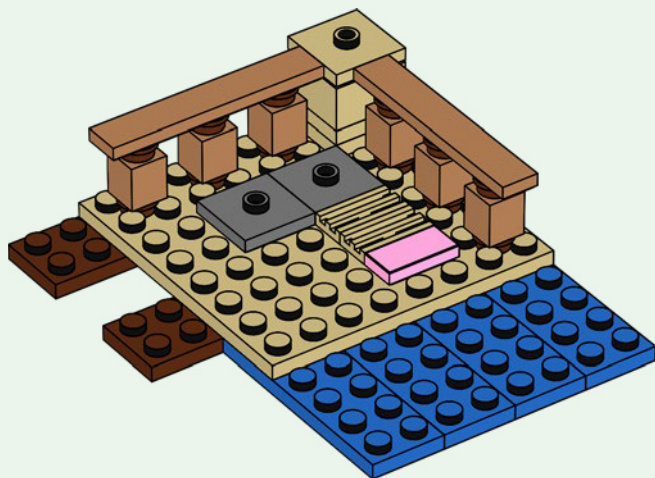



2x

9

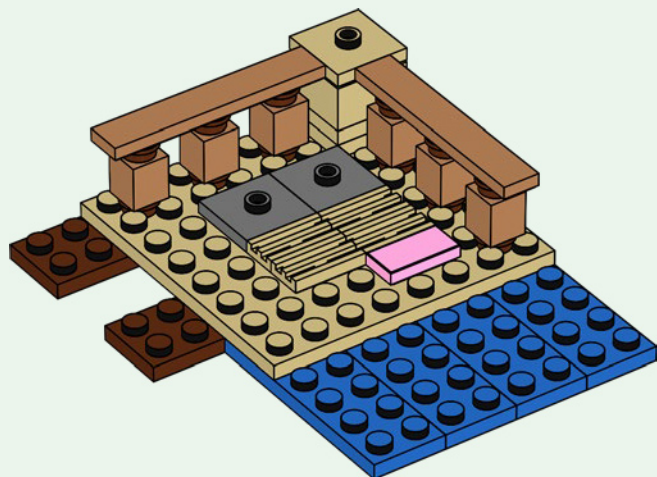



4x

10

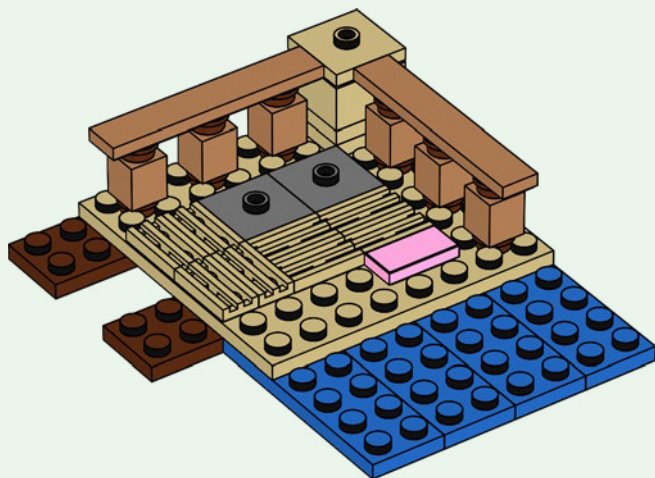



1x

11

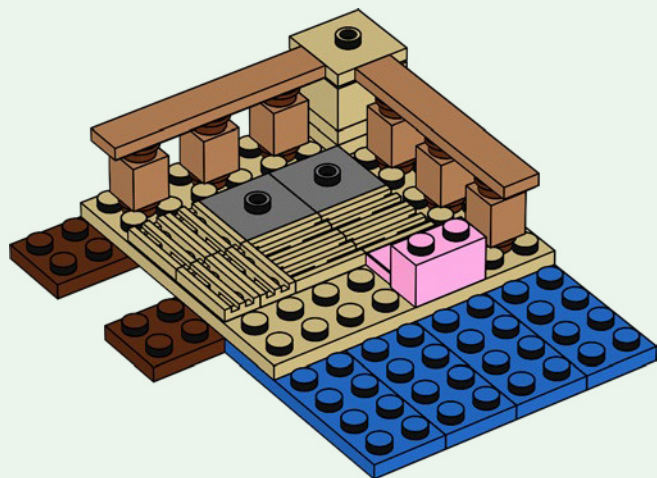

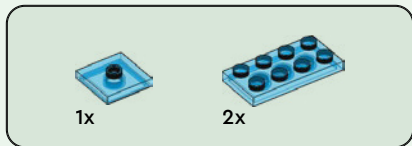

12

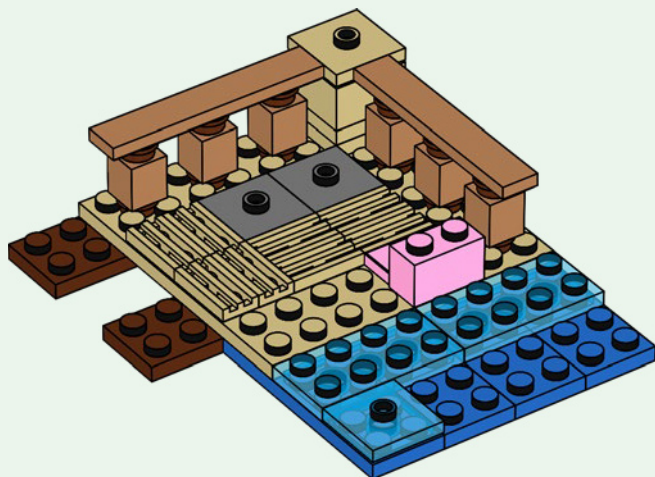

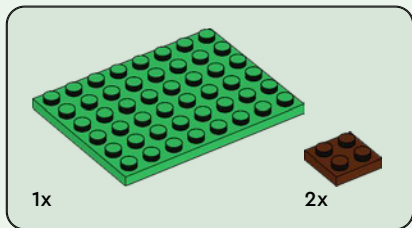
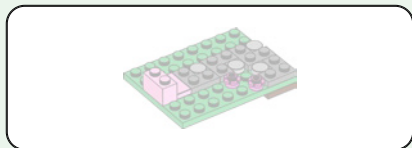

13

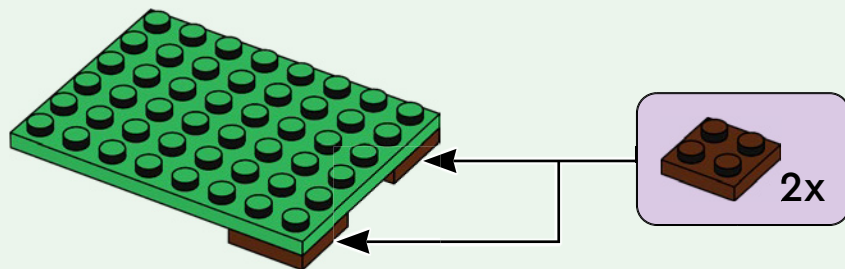



1x



1x

14

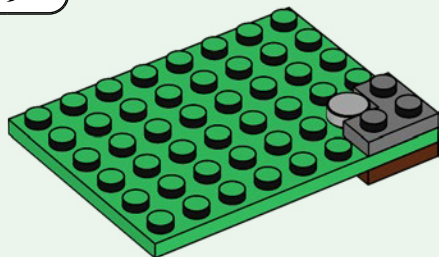

1x



1x

15

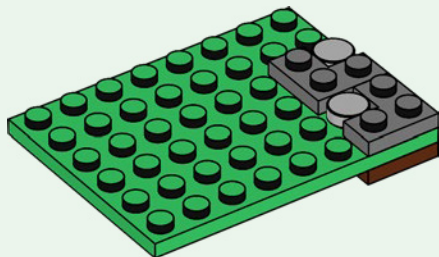



2x



2x

16

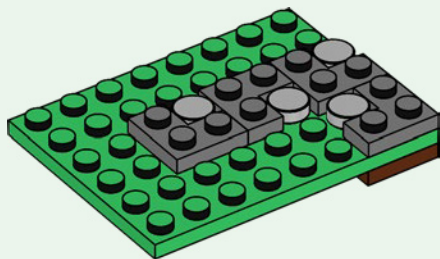

1x



1x



2x

17

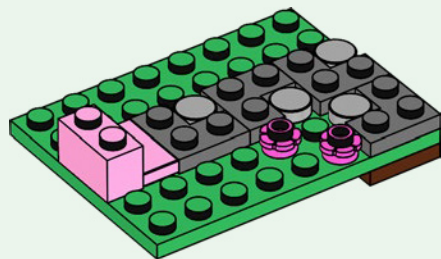

18

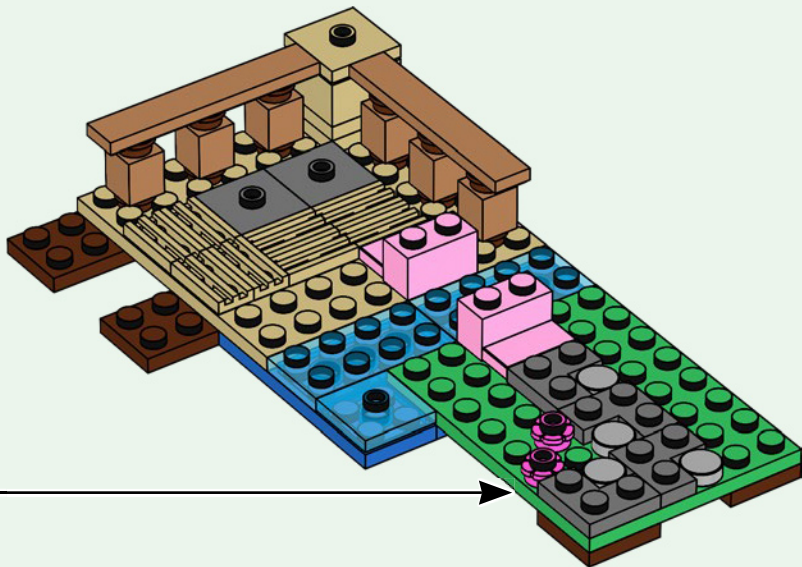

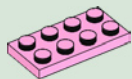

1x

19

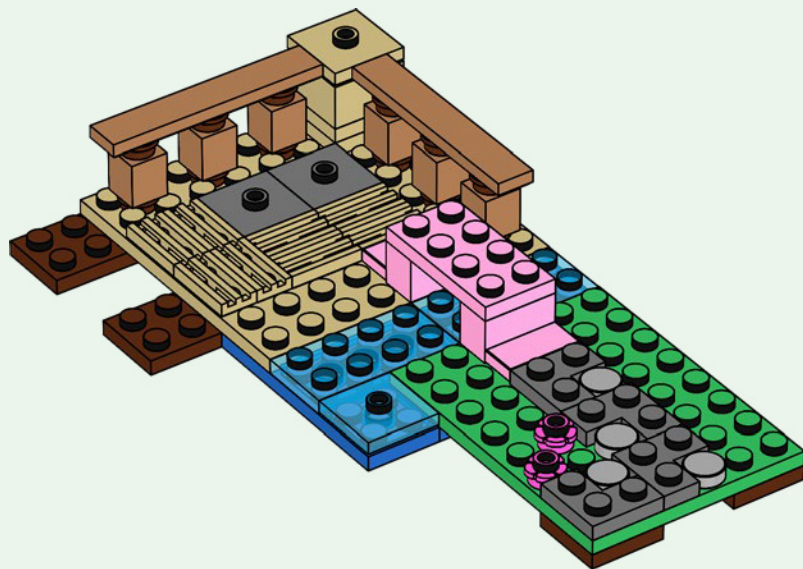

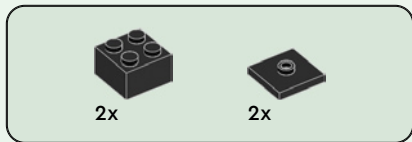

20

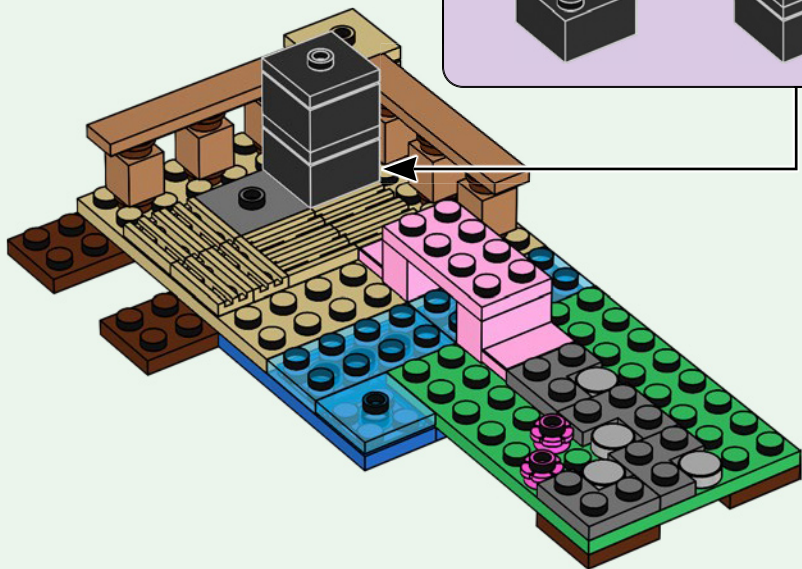
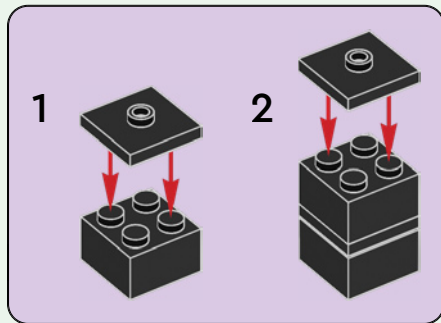





1

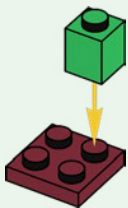

2

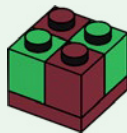

3



4

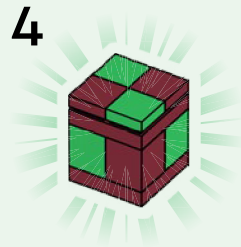

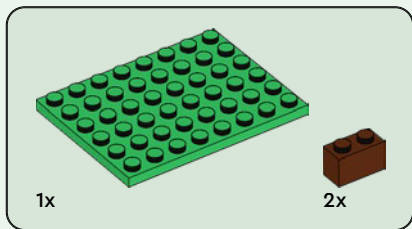
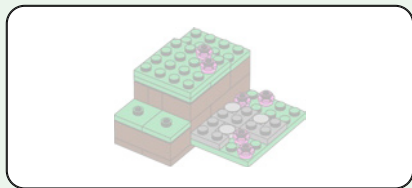

21

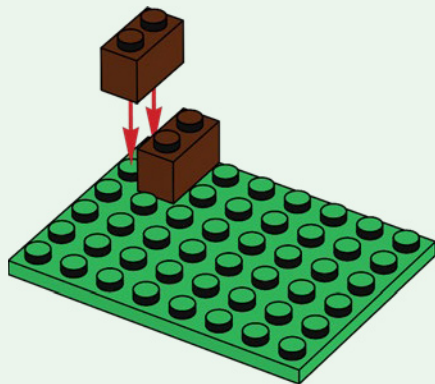



1x

22

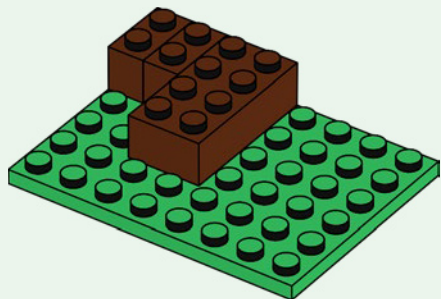

2x



2x



2x

23

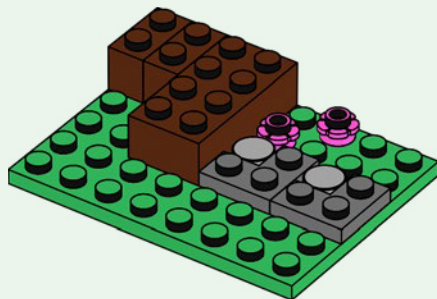



1x



2x



1x

24

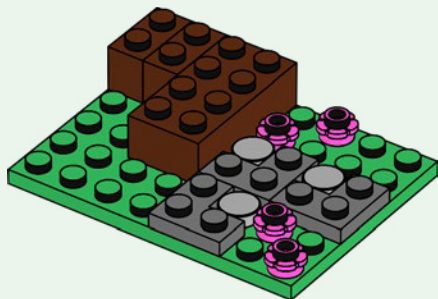

1x

25

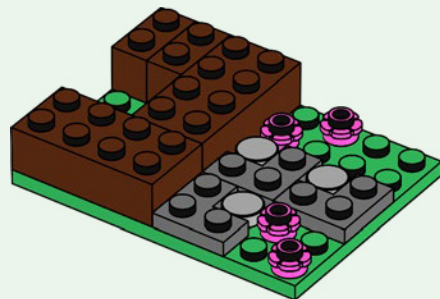

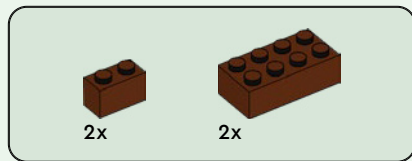

26

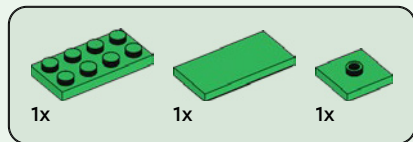
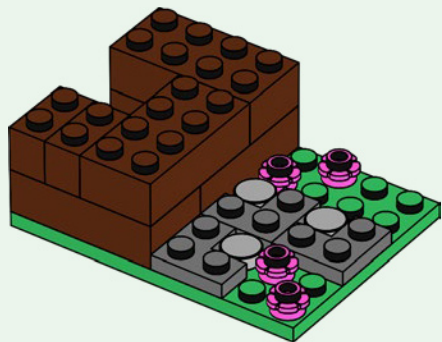

27

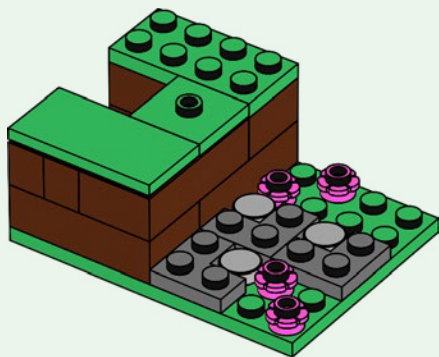

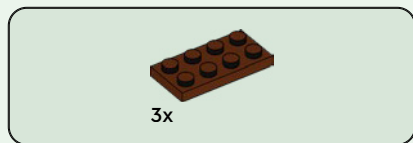

28

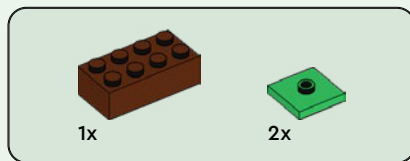
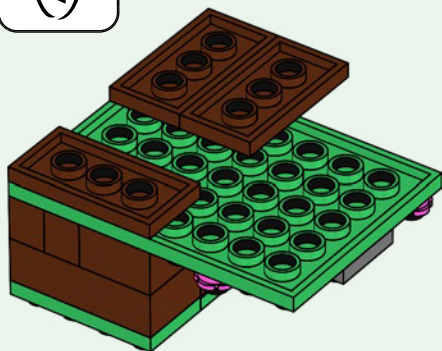

29

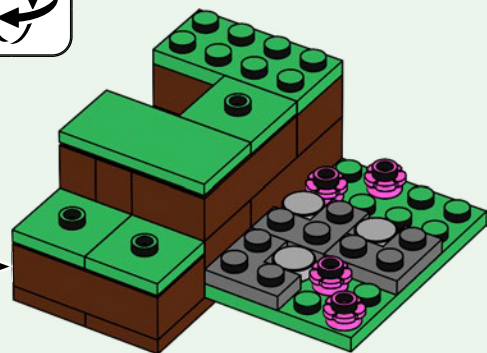
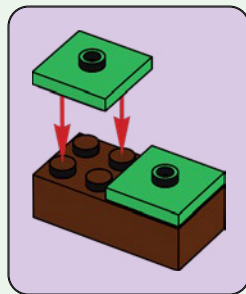
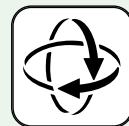

30

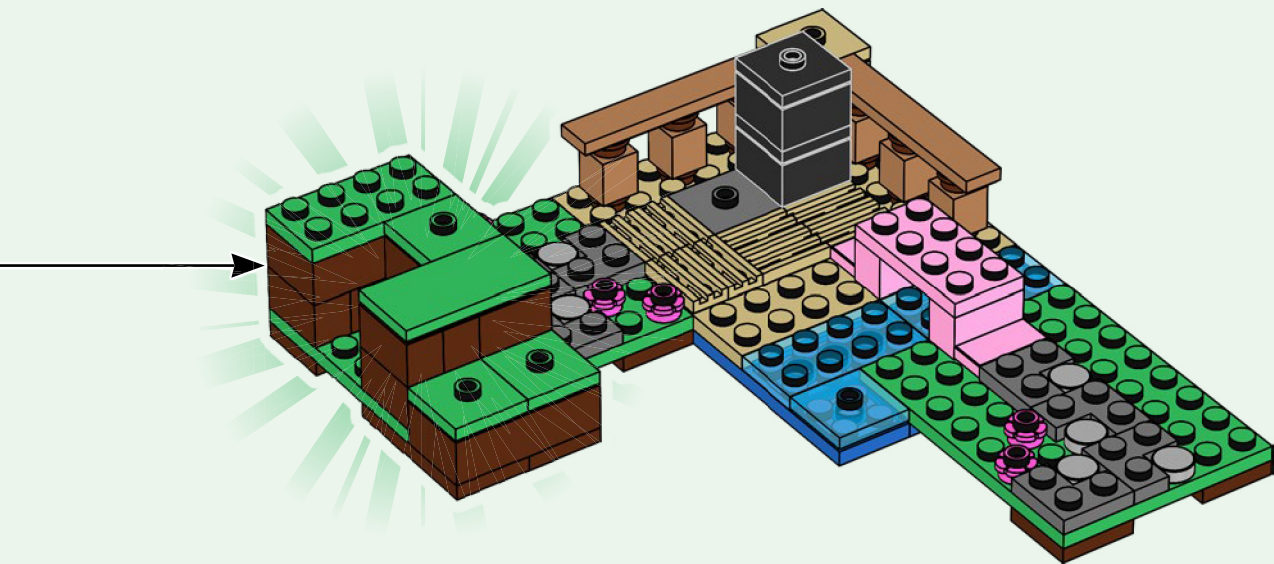

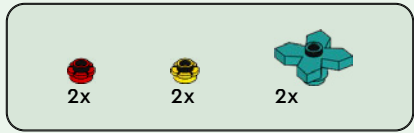

31

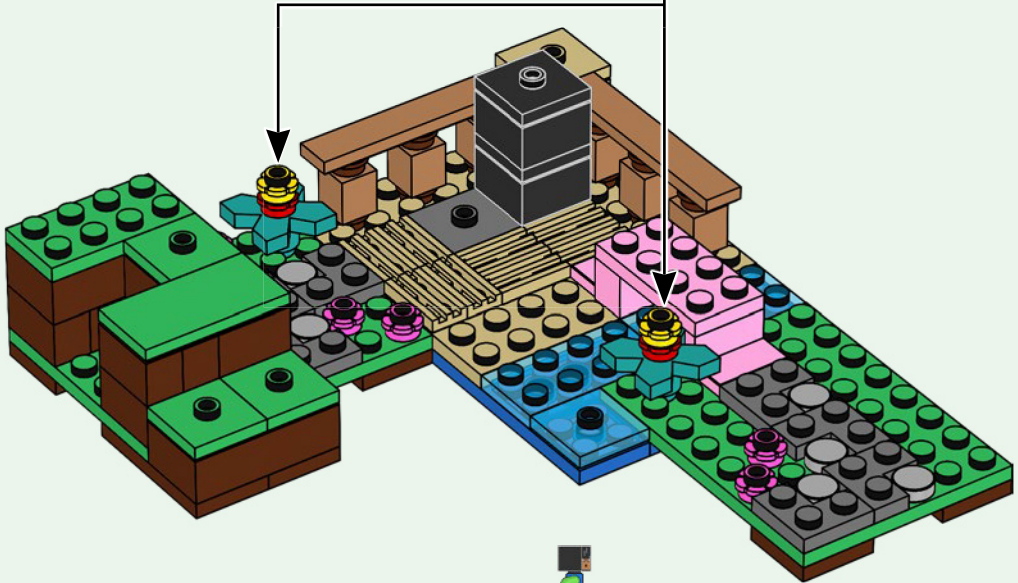
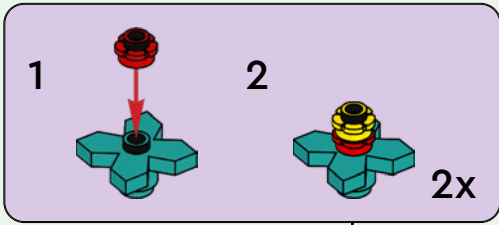

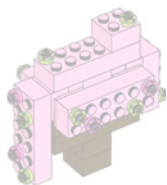

2x

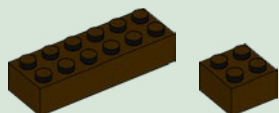

1x



2x

32

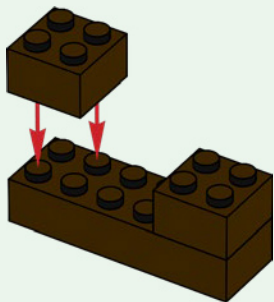

2x

33

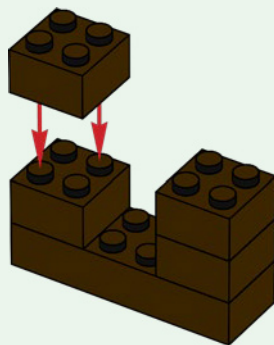



4x

34

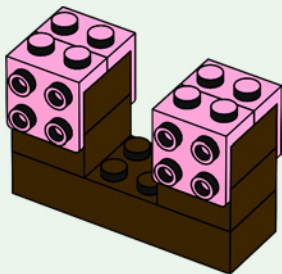

2x



2x

35

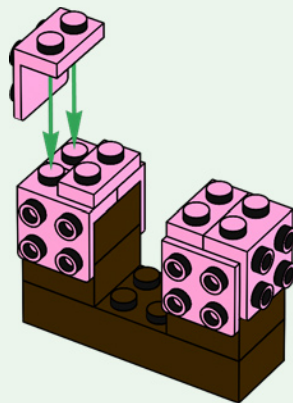

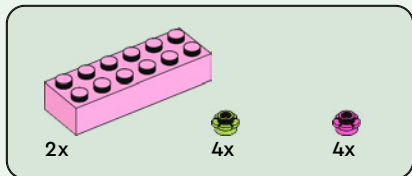

36

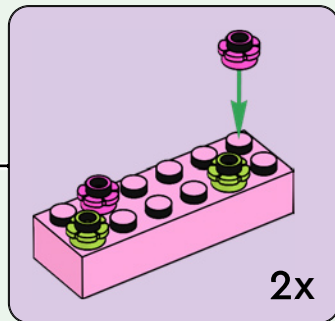
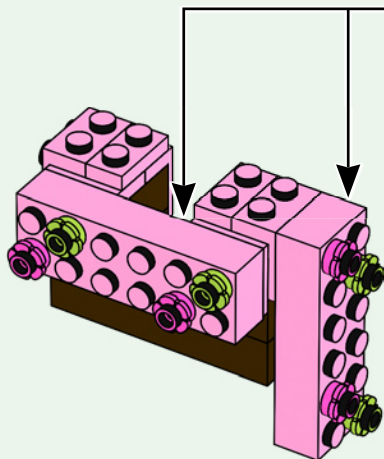

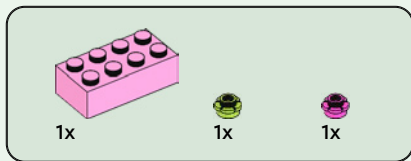

37

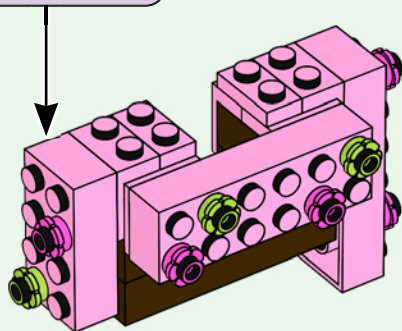
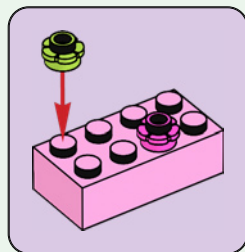

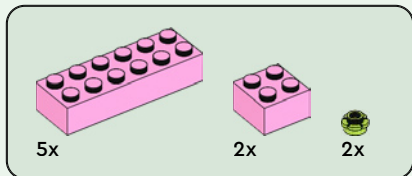

38

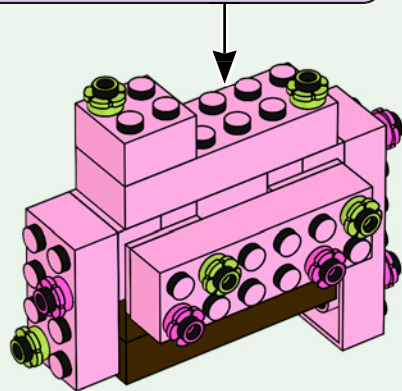
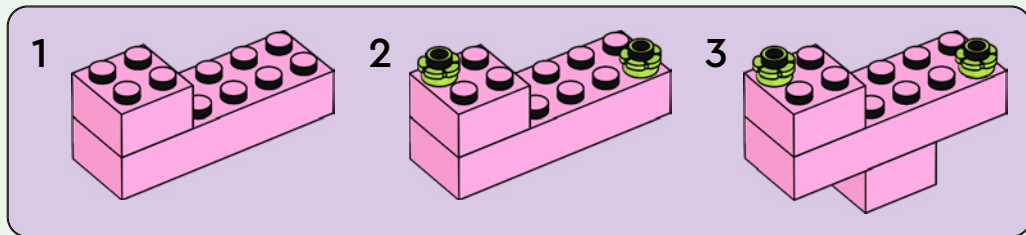

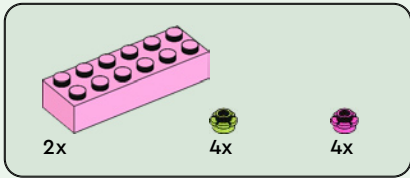

39

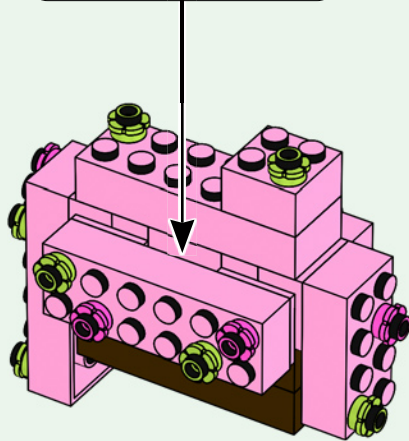
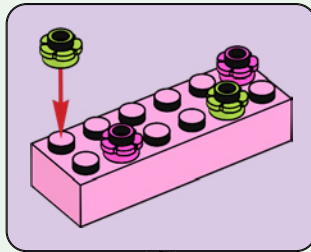
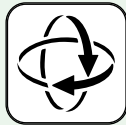



2x

40

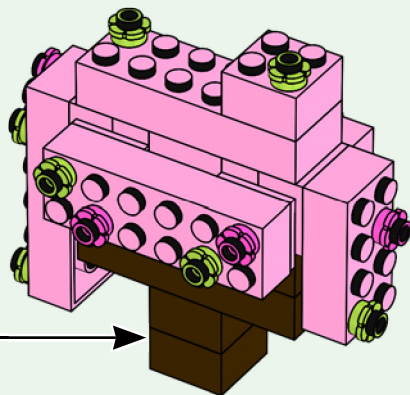
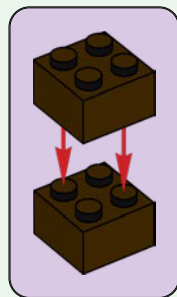

2x

41

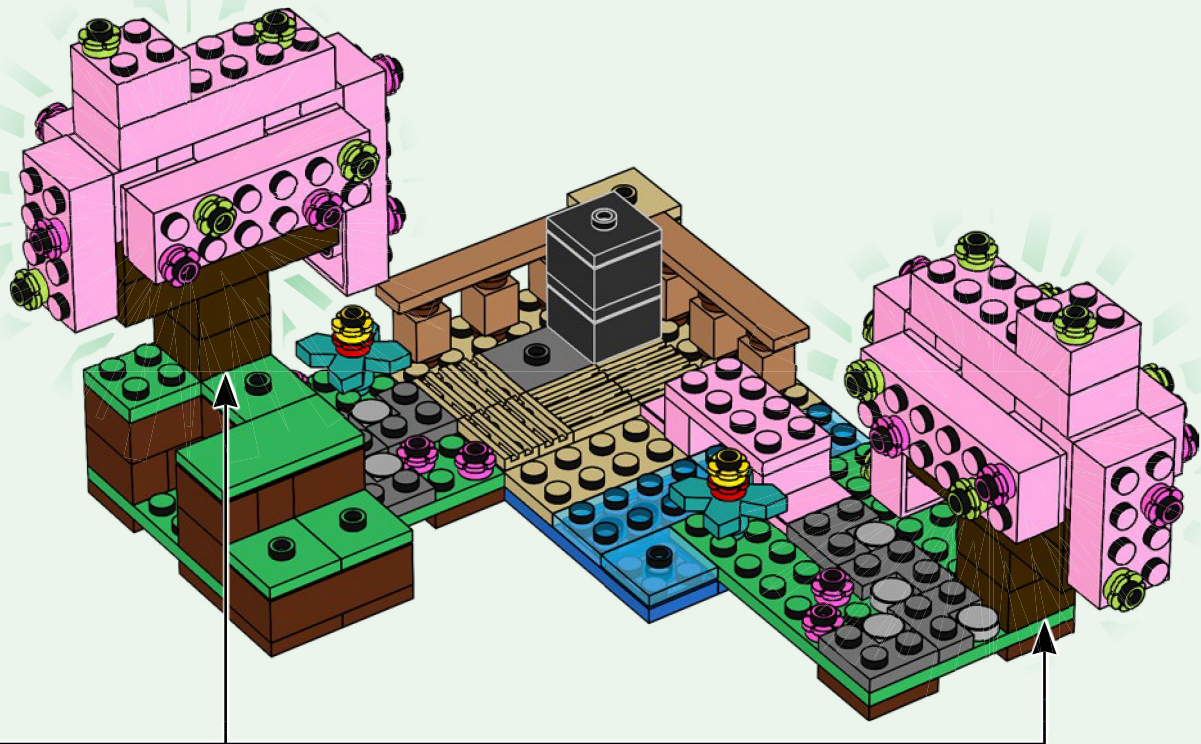

42

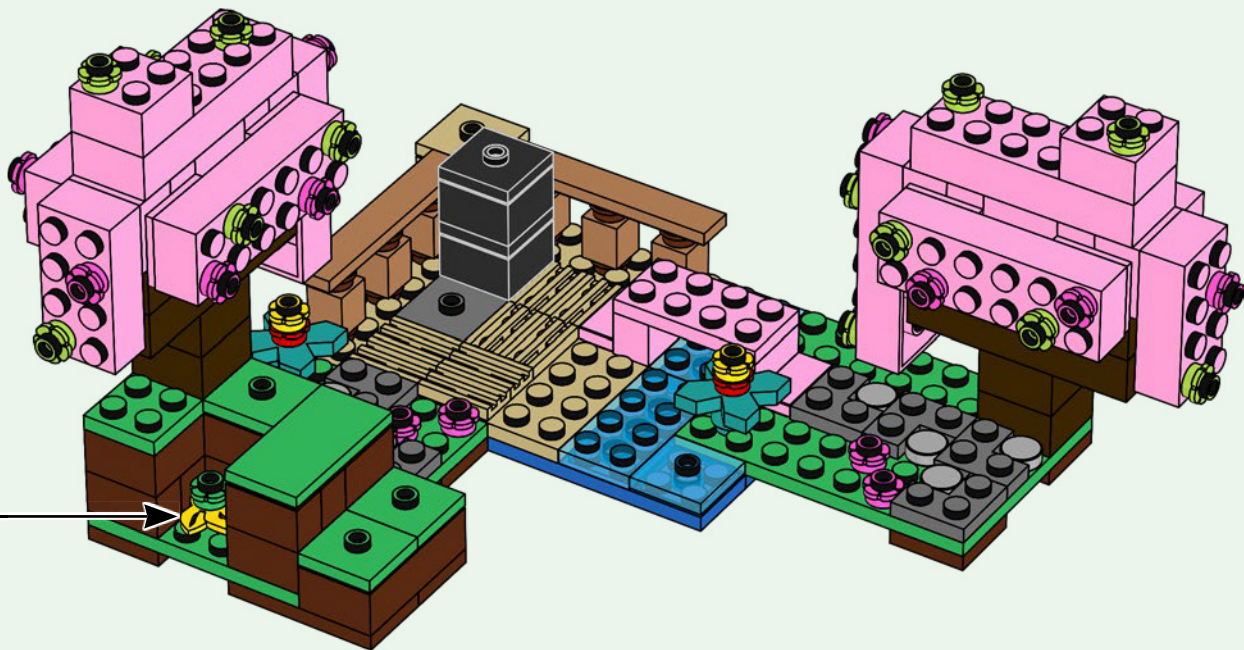

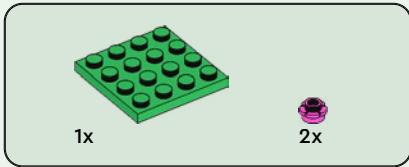

43

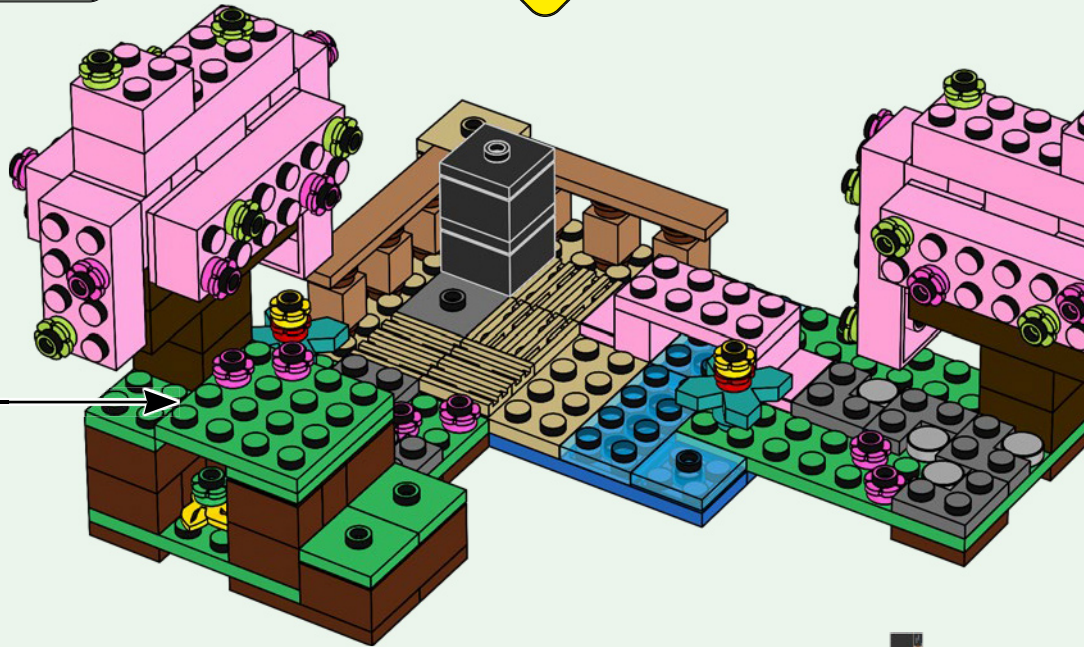
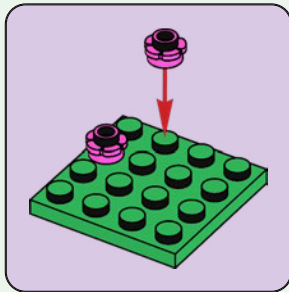

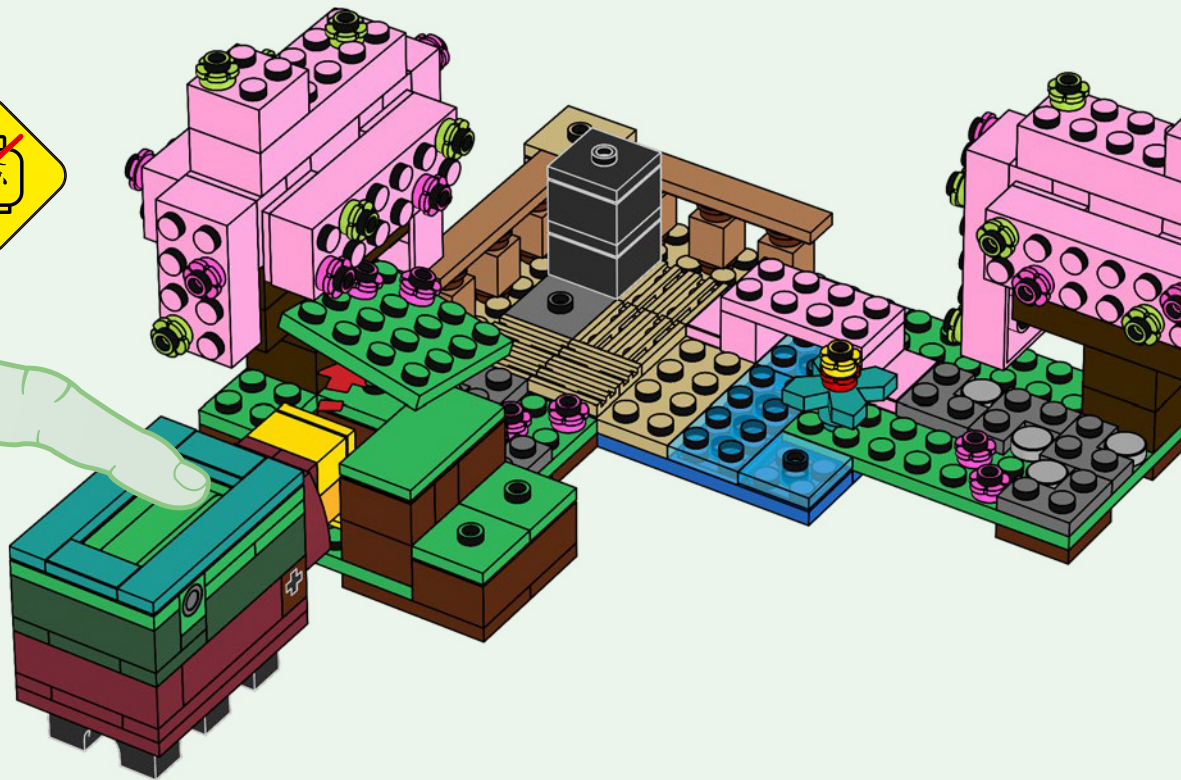
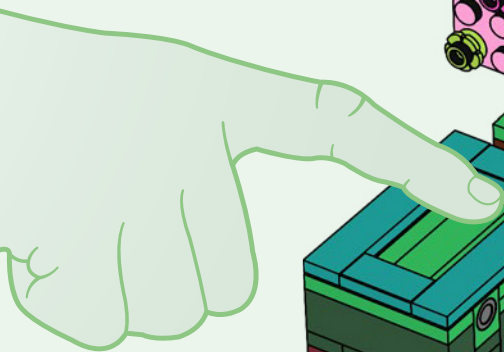





MINECRAFT

21263



21261



21262



21264



21259



21260





1x
6252041



2x
6240204



2x
6166111



2x
6213779



2x
6490210



1x
6249417

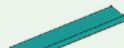

2x
6264986



6x
614126



1x
4109810



1x
6481442



2x
3200026



1x
6156991



2x
4565323



2x
300326



3x
4512727



1x
370526



2x
6299813



2x
407024



2x
6335369



2x
302424



1x
6286830



1x
300424



1x
6481444



1x
6104065



1x
4586410



1x
4143562



4x
6055169



3x
6013102



3x
4245571



1x
6382577



1x
6481446



1x
6481447



1x
6315197



1x
4615606



7x
6284071



1x
6421061



12x
6215659



4x
4221744



2x
6397610



4x
4211149



3x
4216695



5x
4211186



5x
4211201



2x
6109752



2x
4580010



2x
4517993



4x
4654128



12x
6490206



4x
4550359



1x
6204535



2x
4520632

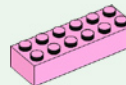

8x
6228963



2x
6206148



1x
4278275



8x
4124456



2x
4114084



1x
4114306



1x
4565387

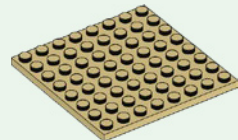

1x
4624223



2x
4507311

4

1x
4569058

2x
4522678

2x
300528

2x
4558593

1x
6162390

3x
302328

1x
6469903

2x
4157120

1x
300328

1x
6135287

3x
6389692

2x
6439557

1x
6288100

1x
6374069

3x
371028

1x
302028

1x
4566179

1x
4243821

2x
6481445

4x
4550169

3x
4539097

2x
6173168

2x
4585479

1x
6264030

3x
6052777

2x
4539062

1x
6020122

4x
4539092

2x
4541376

1x
6444266

1x
6065504

1x
6073040

1x
6028736

1x
4622062

1x
6003003

2x
6476399

18x
6209692

1x
6209684

22x
6209679

1x
6485114

1x
9341

4x
379523

2x
6126083

7x
4210635

1x
6083620

1x
6252043

1x
6454738

1x
4538950

12x
6092677

2x
6490208

1x
6499253

6x
6057986

2x
6102995



 [LEGO.com/service](https://www.LEGO.com/service)

YOU COULD

WIN

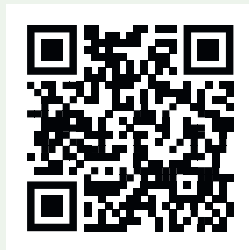

Scan this QR code or go to **LEGO.COM/PRODUCTFEEDBACK** and give us your short feedback about this LEGO® set for a chance to win a cool LEGO prize.

Terms and Conditions apply*

EN: YOU COULD WIN. Terms and Conditions apply* **DE: Du könntest GEWINNEN.** Es gelten die Teilnahmebedingungen* **FR: Tu pourrais GAGNER.** Des conditions s'appliquent* **IT: Potresti VINCERE tu.** Termini e condizioni sono applicabili* **ES: Puedes GANAR.** Aplican términos y condiciones* **PT: Poderá GANHAR.** Aplicam-se termos e condições* **ZH: 轻松获奖. 条款和条件适用*** **PL: Szansa na WYGRANĄ.** Obowiązują warunki korzystania* **CS: Máte šanci VYHRÁT.** Platí všeobecné smluvní podmínky* **SK: Máte šancu VYHRAŤ.** Platia všeobecné zmluvné podmienky* **HU: TE IS NYERHETSZ.** Felhasználási feltételek érvényesek* **RO: Ai putea CÂȘTIGA.** Se aplică termenii și condiții* **BG: Можете да СПЕЧЕЛИТЕ.** Има определени правила и условия* **LV: Tu vari LAIMĒT.** Ir spēkā noteikumi un nosacījumi.* **ET: Sul on võimalus VÕITA.** Kehtivad tingimused* **LT: Jūs galite LAIMĖTI.** Taikomos sąlygos*

*[LEGO.com/productfeedback/terms](https://www.lego.com/productfeedback/terms)

LEGO and the LEGO logo are trademarks of the/son des marques de commerce du/son marcas registradas de LEGO Group. ©2024 The LEGO Group.
© 2024 Mojang AB. All Rights Reserved. Minecraft, the Minecraft logo, the Mojang Studios logo and the Creeper logo are trademarks of the Microsoft group of companies.

6520684