



MINECRAFT

21259



Q LEGO® Builder



Get excited about our new packaging!

We're switching from plastic to paper-based packaging. That's why you might find a mix of paper and plastic in our boxes!

Nos nouveaux emballages vous emballeront !

Nous passons des emballages en plastique aux emballages à base de papier. C'est pourquoi vous pourriez trouver un mélange de papier et de plastique dans nos boîtes !

¡Te presentamos nuestros nuevos empaques!

Estamos sustituyendo las bolsas de plástico por bolsas con base de papel. ¡Por eso, puedes encontrar una mezcla de papel y de plástico en nuestras cajas!

[LEGO.com/sustainable-packaging](https://www.lego.com/sustainable-packaging)

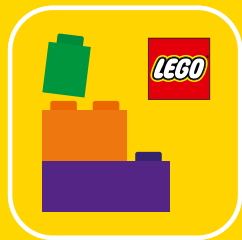

Q LEGO® Builder

BUILDER



Apple and the Apple logo are trademarks of Apple Inc., registered in the U.S. and other countries and regions. App Store is a service mark of Apple Inc. Google Play and the Google Play logo are trademarks of Google LLC. Tencent and the Tencent logo are trademarks of Tencent Inc.

Q LEGO.com/devicecheck

EN Ask parents' permission before going online | **DE** Eltern um Erlaubnis bitten, bevor du online gehst | **FR** Demande l'autorisation d'un parent avant d'aller en ligne | **IT** Chiedi il permesso ai tuoi genitori prima di andare online | **ES** Pídeles permiso a tus papás antes de conectarte a Internet | **PT** Pede autorização aos pais antes de acederes online | **ZH** 上网前应先征得父母的同意 | **PL** Poproś rodziców o zgodę, zanim wejdiesz do Internetu | **CS** Než půjdeš na internet, požádej rodiče o svolení | **SK** Skôr než pôjdeš na internet, vypýtaj si povolenie od rodičov | **HU** Kérj szülői engedélyt, mielőtt online csatlakoznál! | **RO** Cere permisiunea părinților înainte de a te conecta online | **BG** Поискайте разрешение от родител, преди да влезете онлайн | **LV** Pirms došanās tiešsaistē palūdz atļauju vecākiem | **ET** Enne Interneti kasutamist küsi vanematelt luba | **LT** Prieš prisijungdami prie interneto, atsiklauskite tėvų

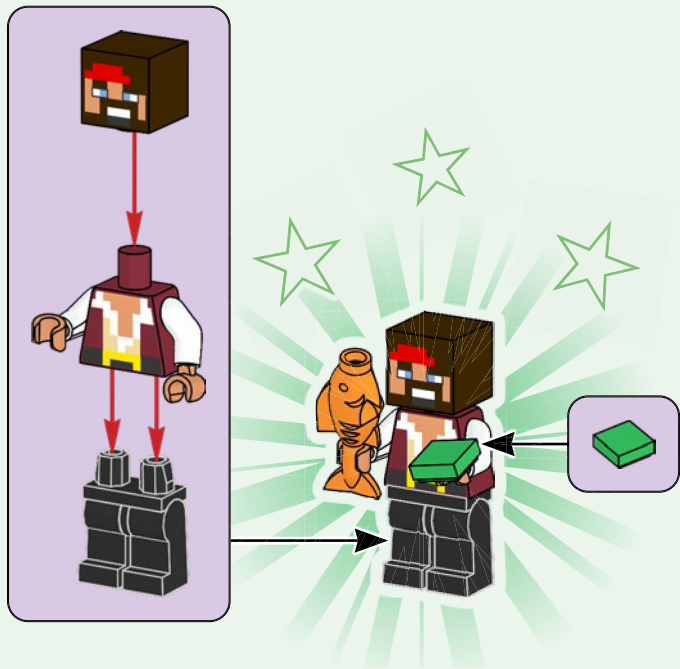

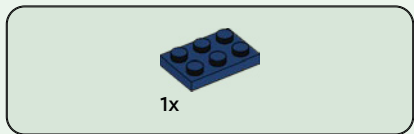
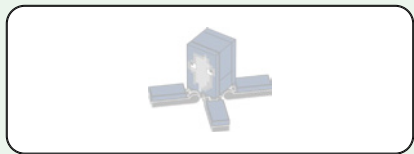

1

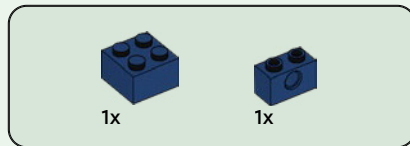

2

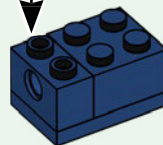
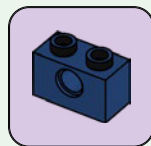



1x

3

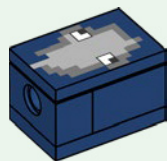

1x



1x

4

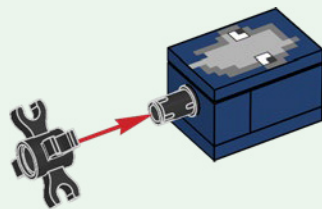

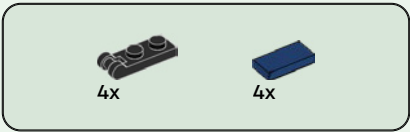

5

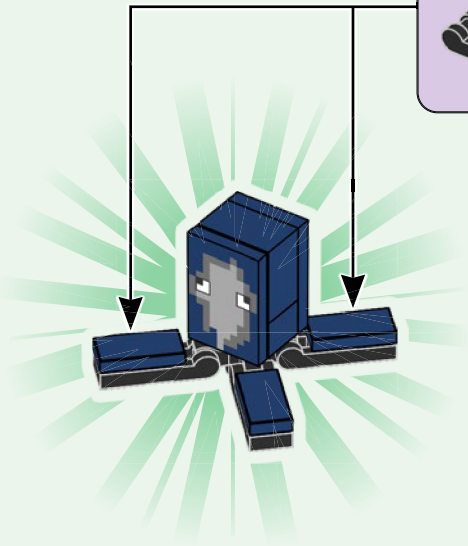
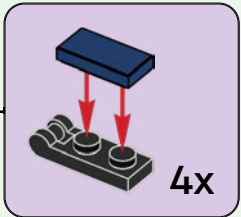

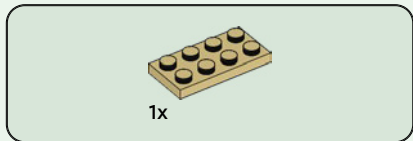
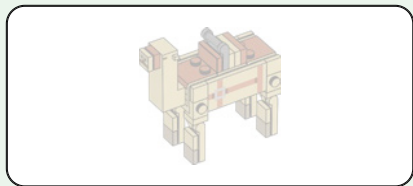

1x

1

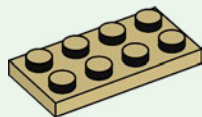

8

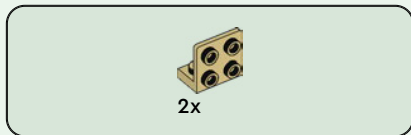

2x

2

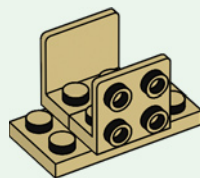

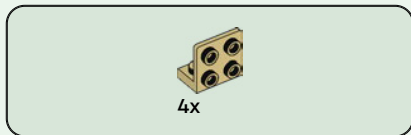

3

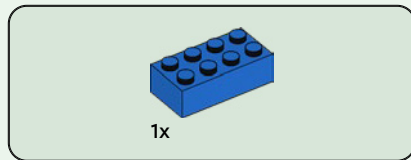
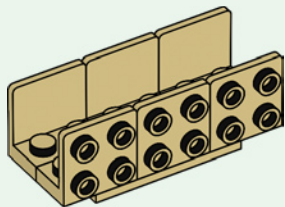

4





1x

5

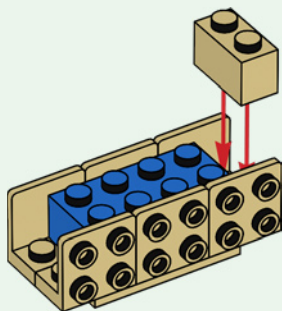

2x

6

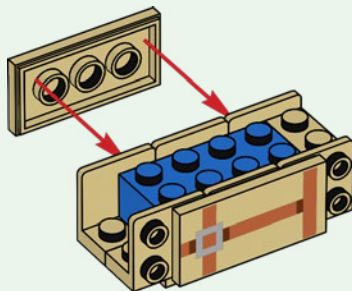



7

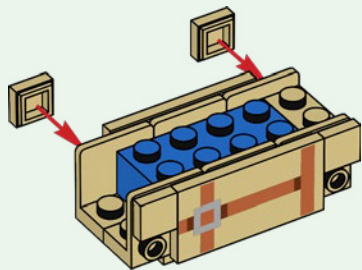

8

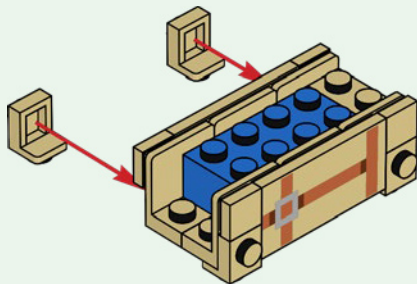

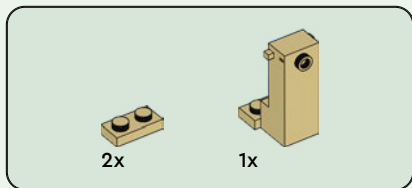

9

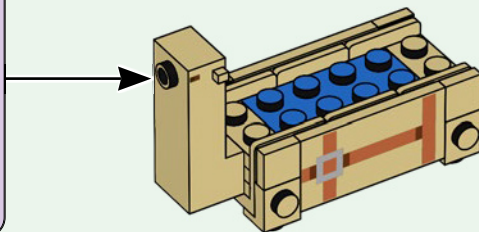
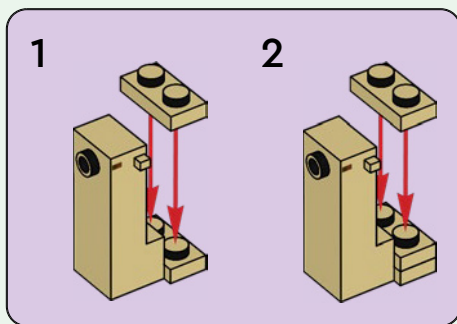

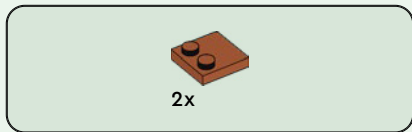

10

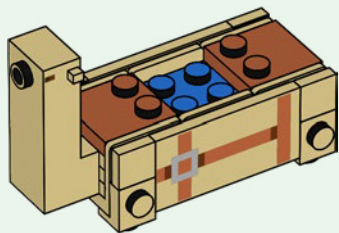

11

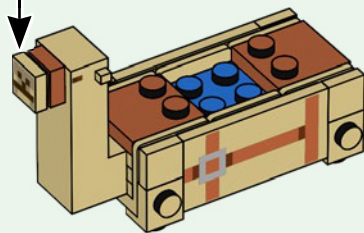
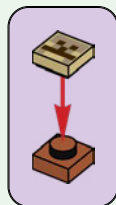

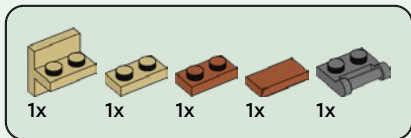

12

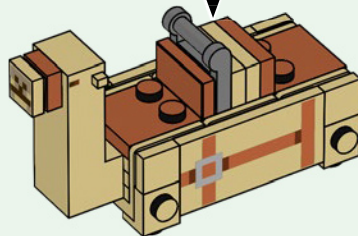
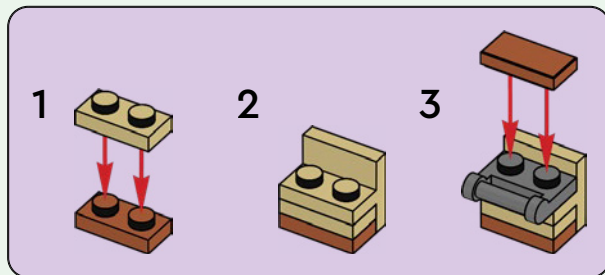

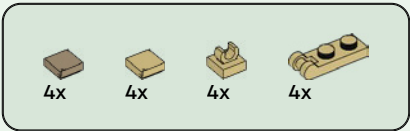

13

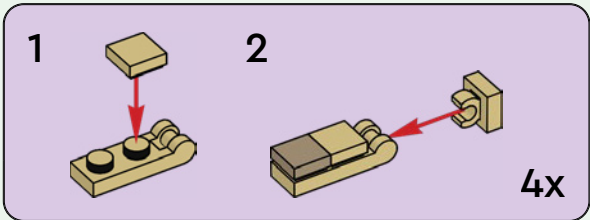
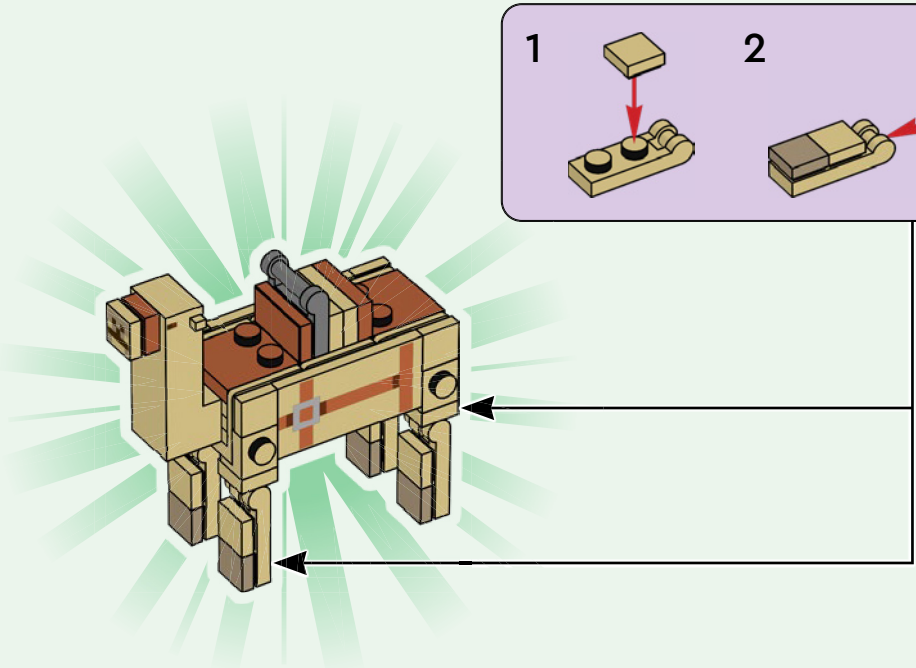

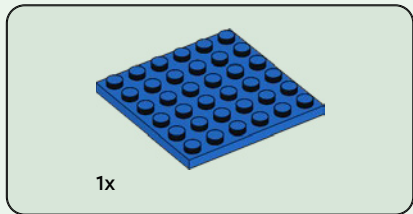
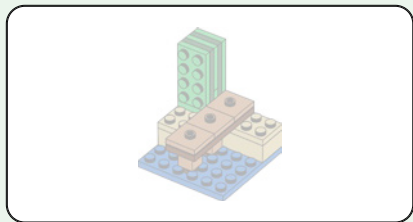

1

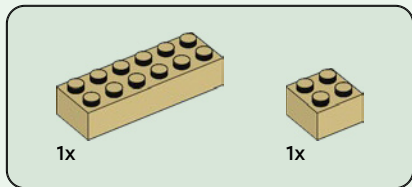
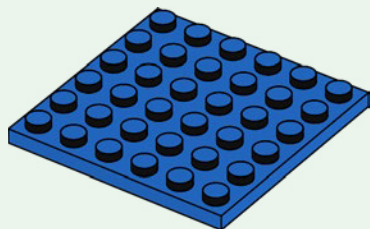

2

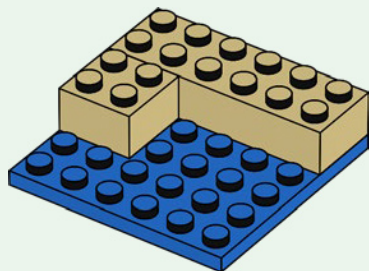

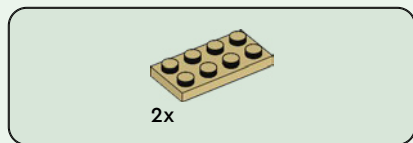

3

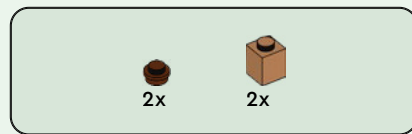
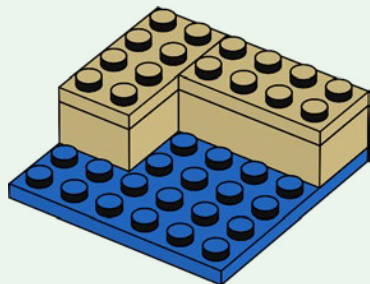

4

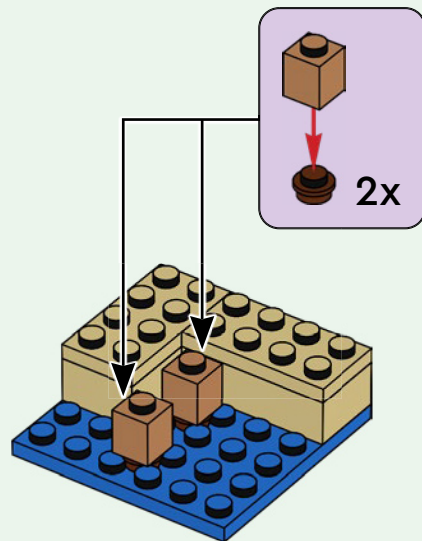

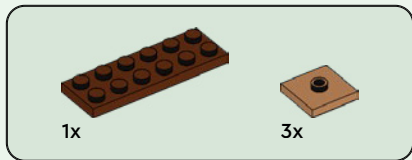

5

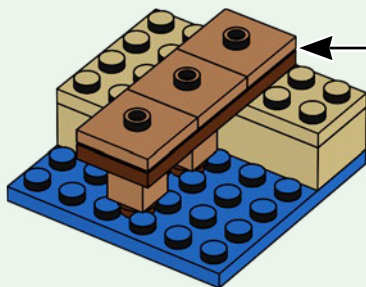
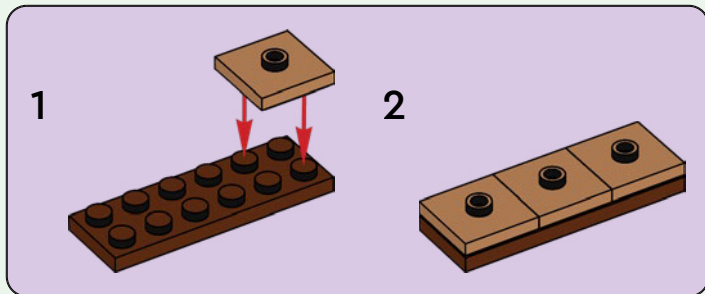



1x

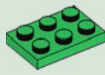

1x

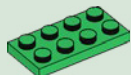

2x



2x

6

1

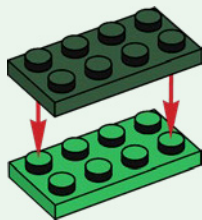

2

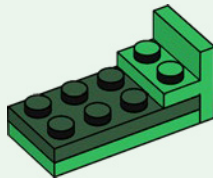

3

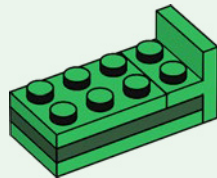

4

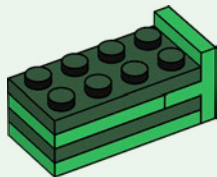

5

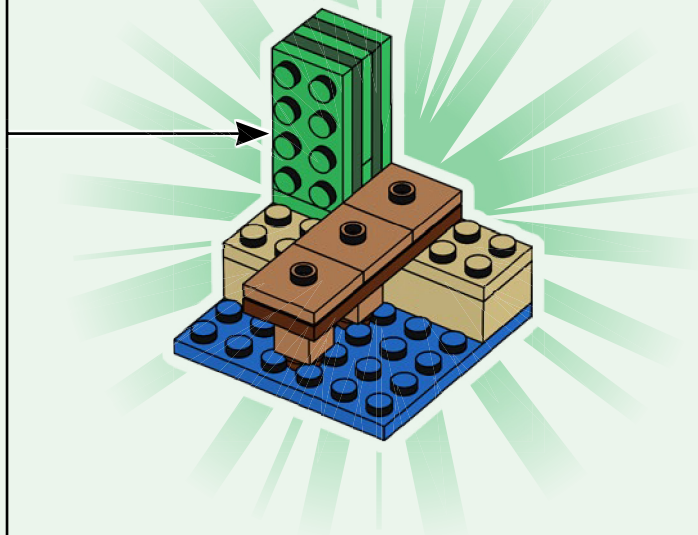
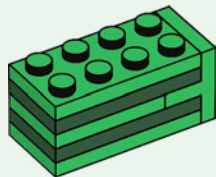

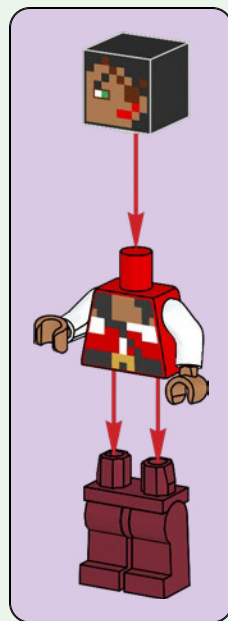

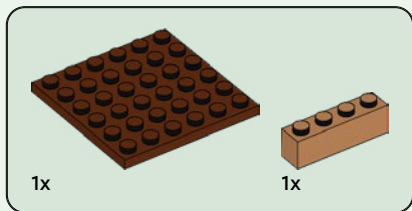
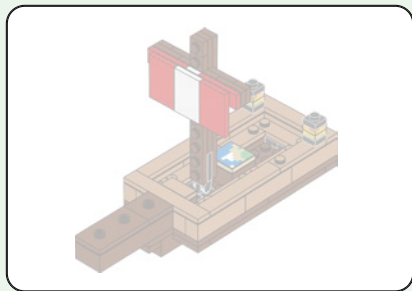

1

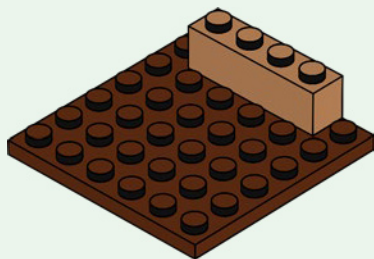



2x

2

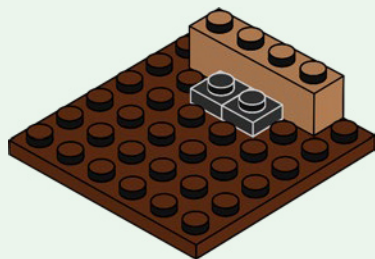

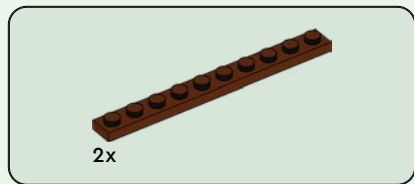

3

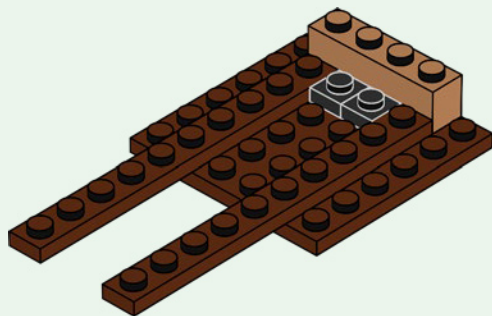

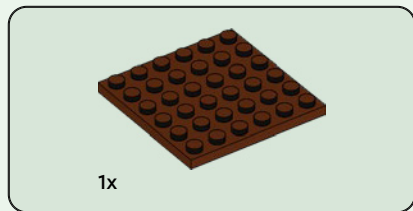

4

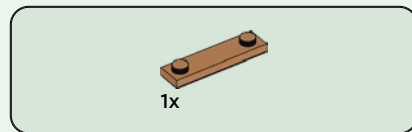
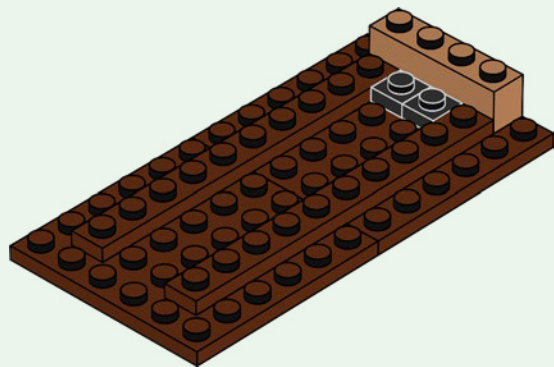

5

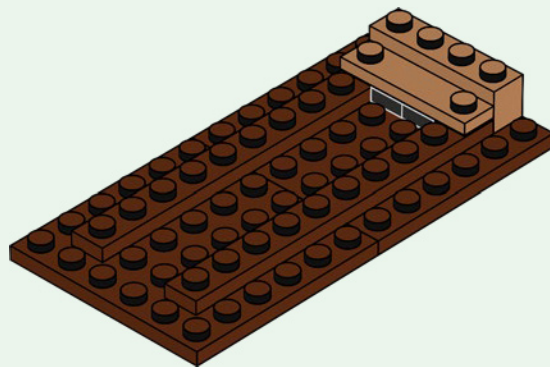

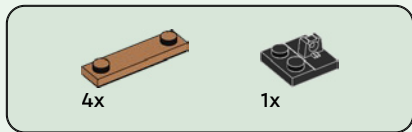

6

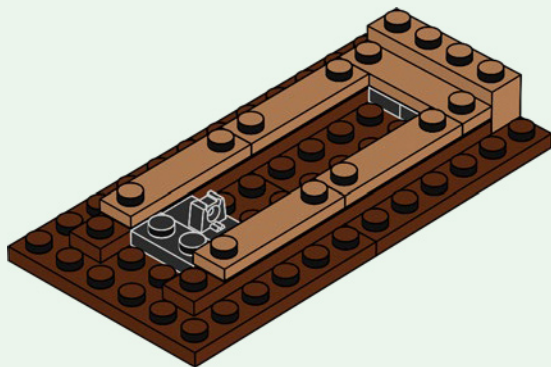



2x

7

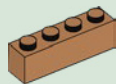
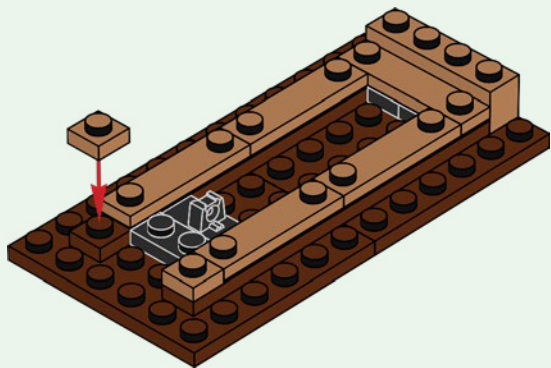

6x



2x

8

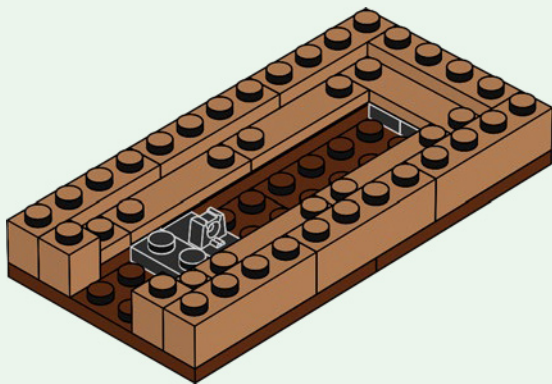

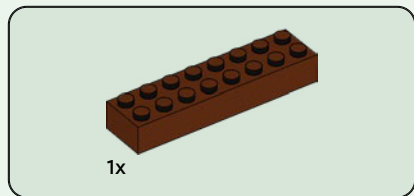

9

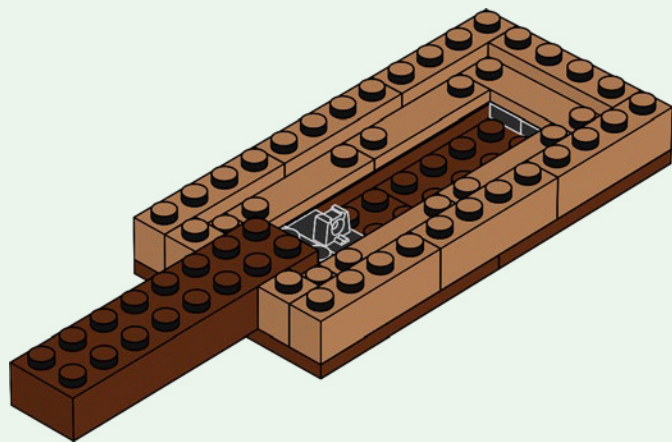

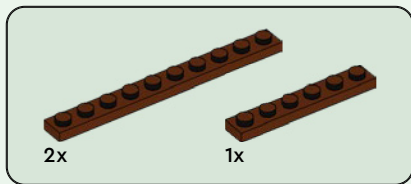

10

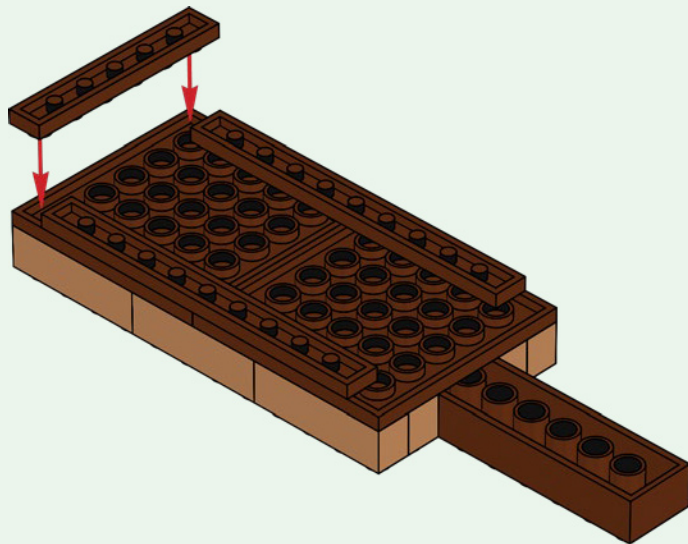



1x

11

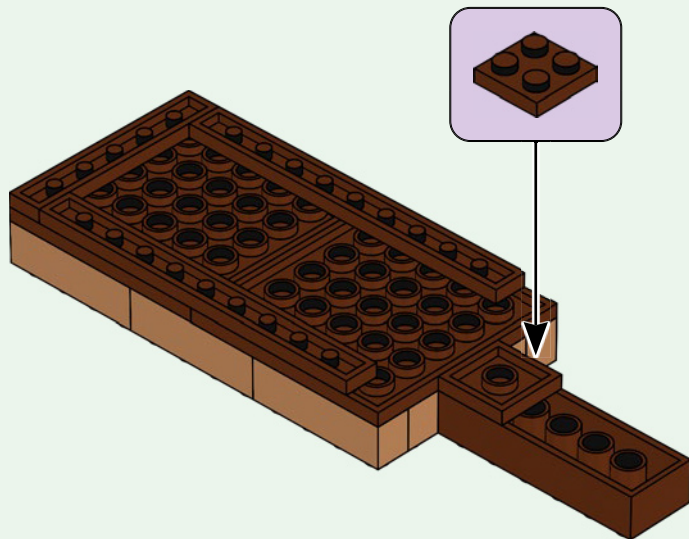



3x

12

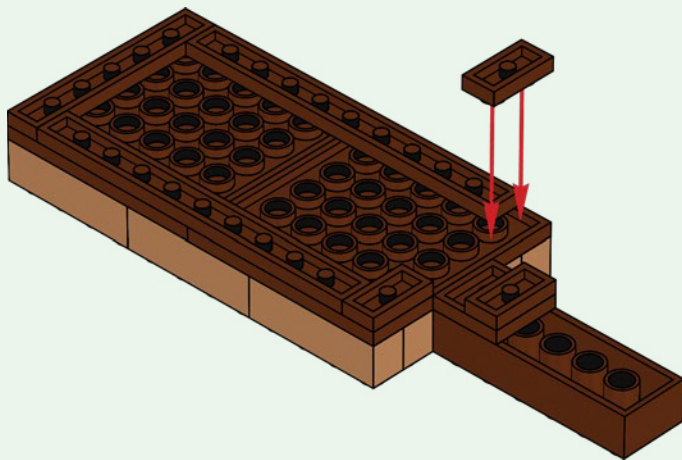



1x

13

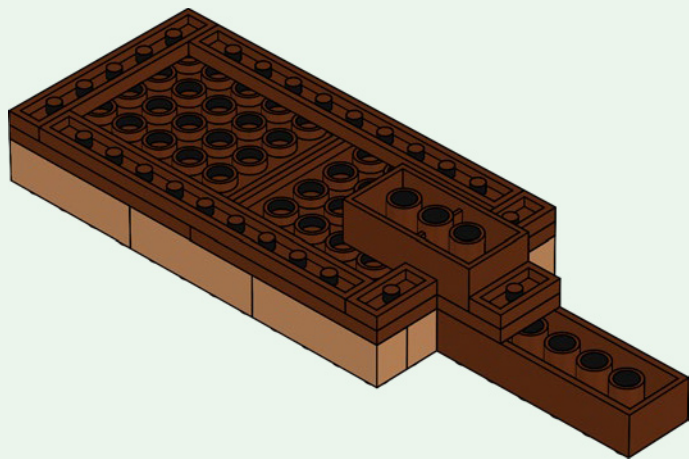

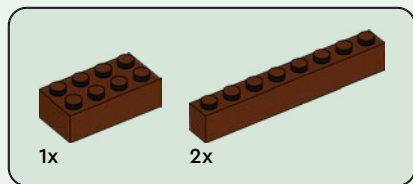

14

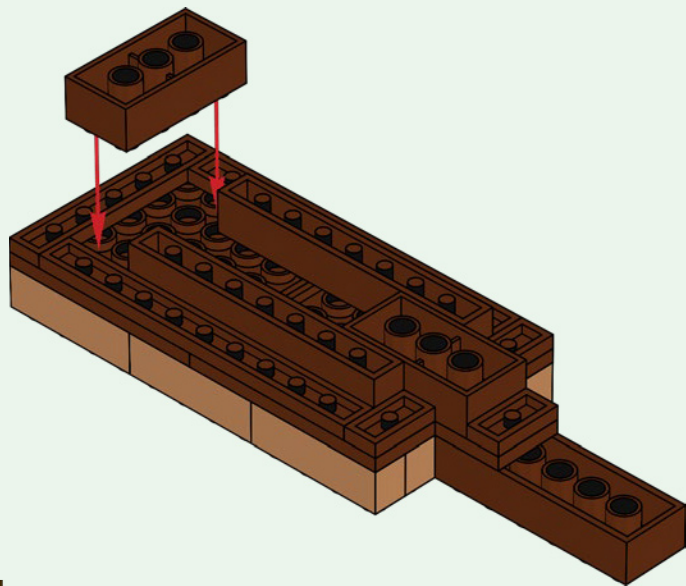



4x

15

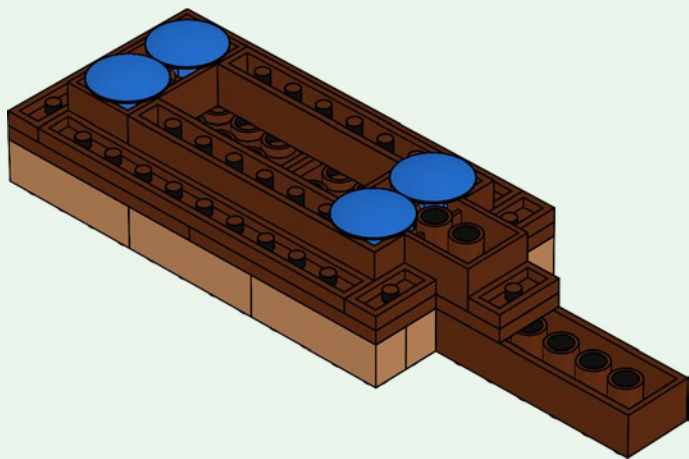

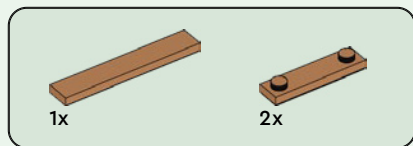

16

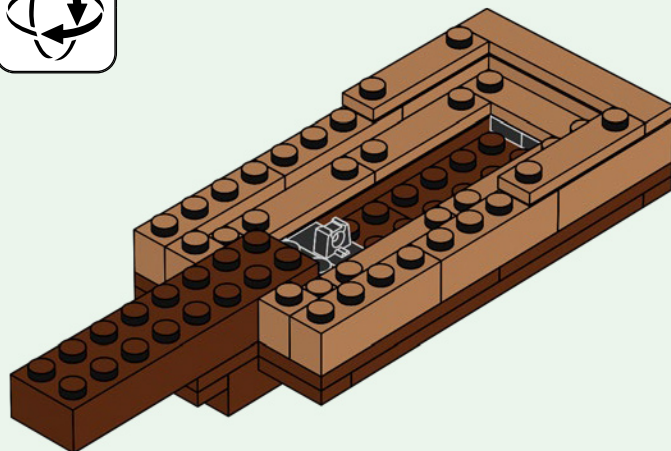

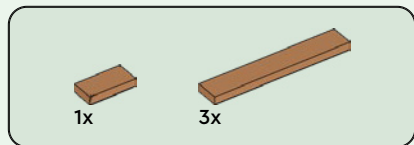

17

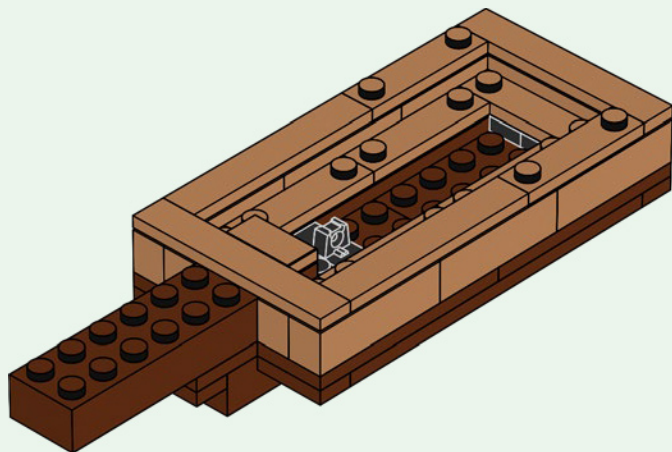

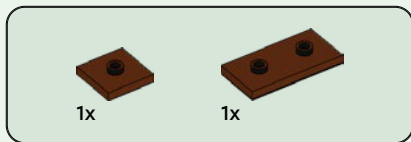

18

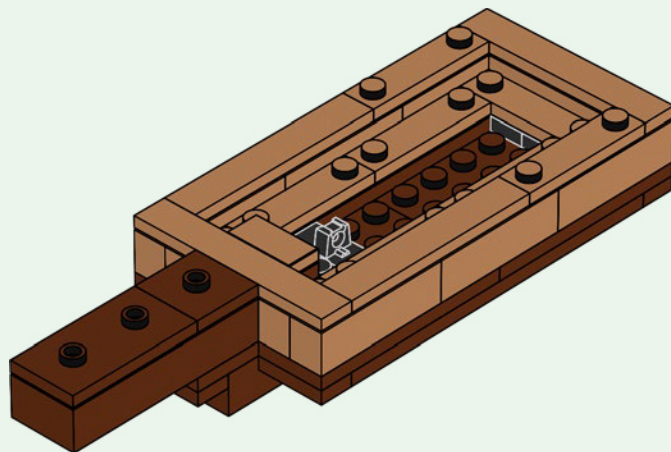



19

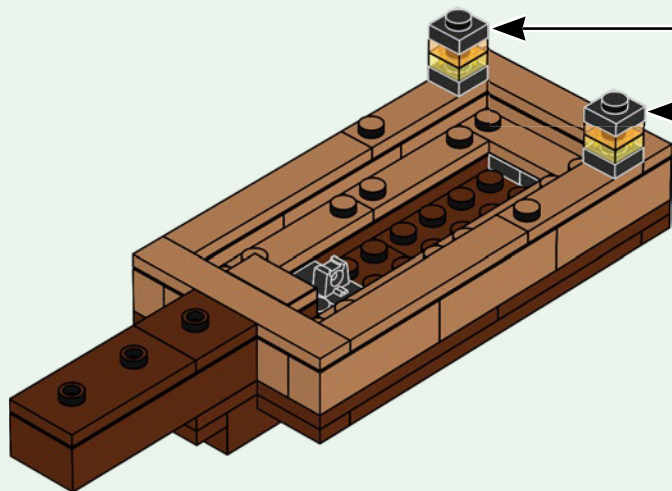
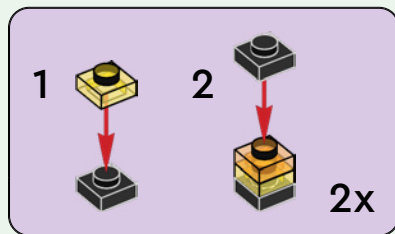

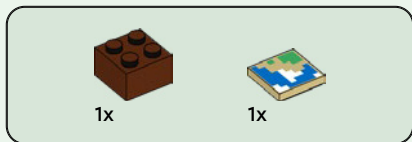

20

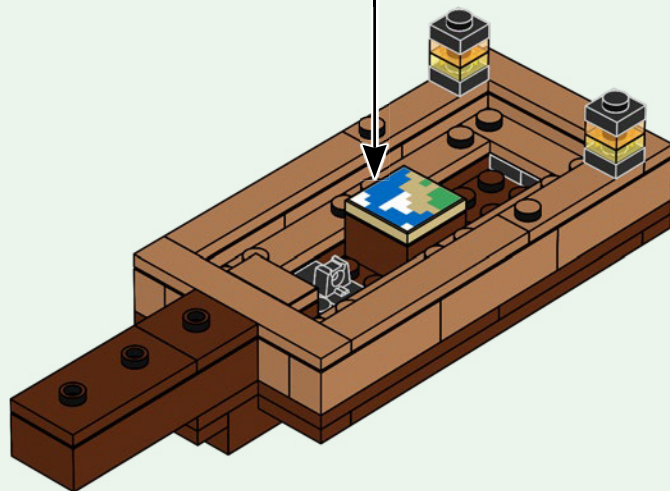
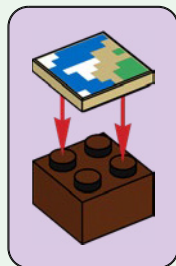

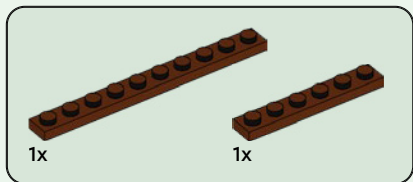
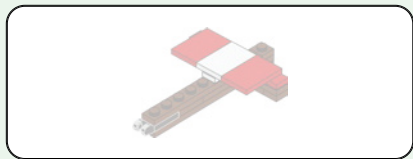

21

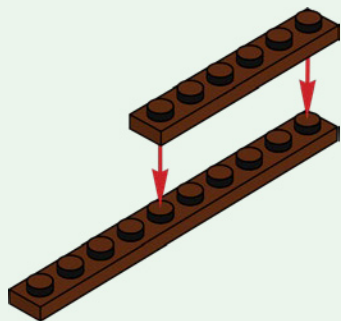



1x



1x

22

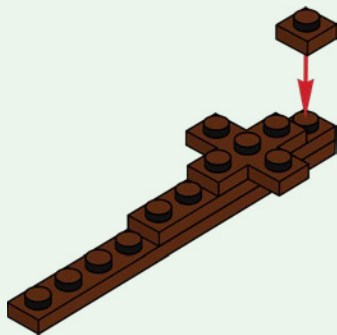

1x



1x

23

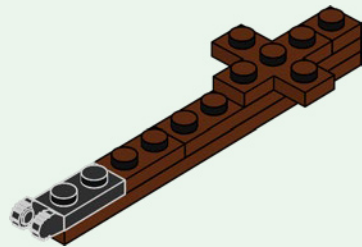

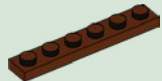

1x

24

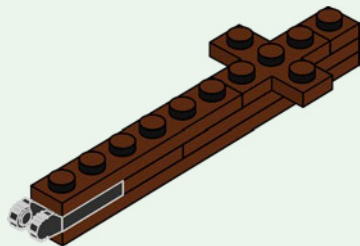



4x



2x

25

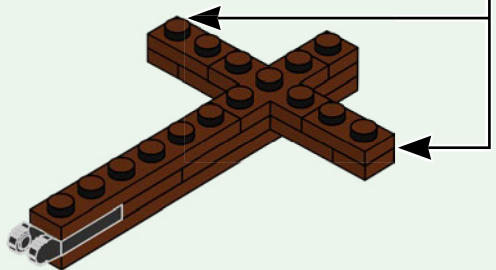
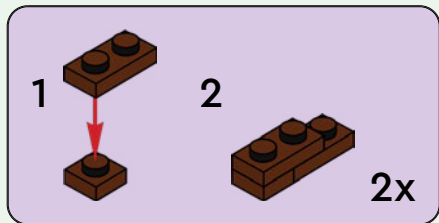

1x



2x

26

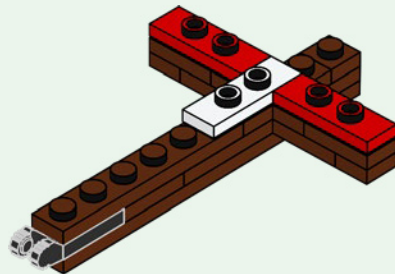



1x



2x

27

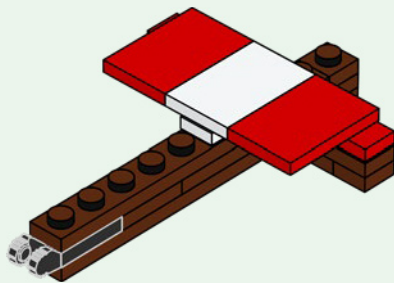

28

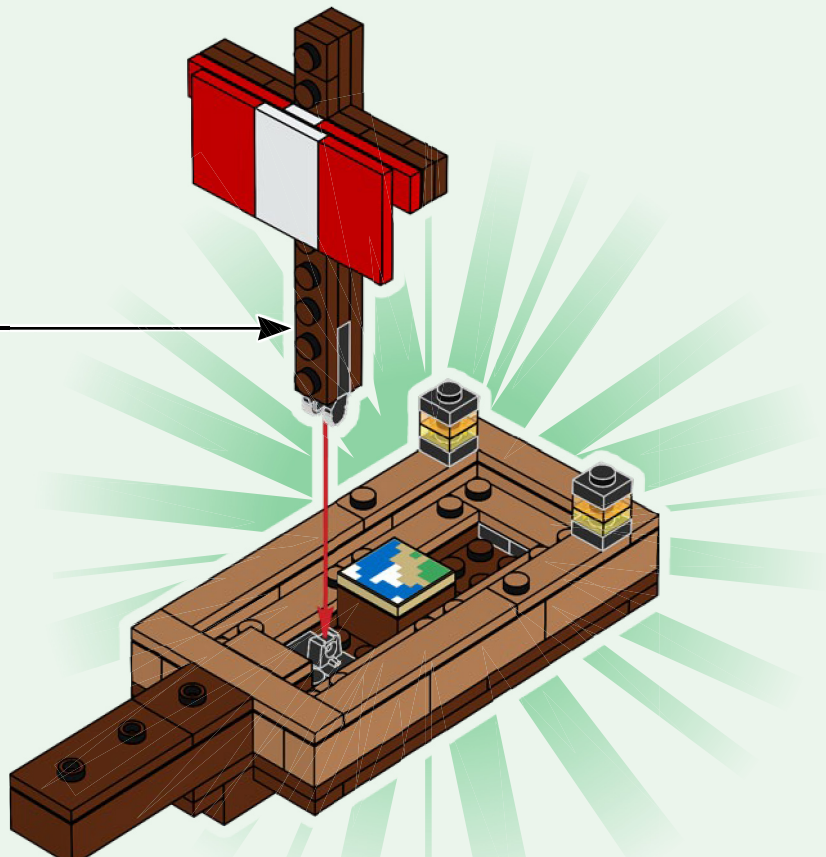

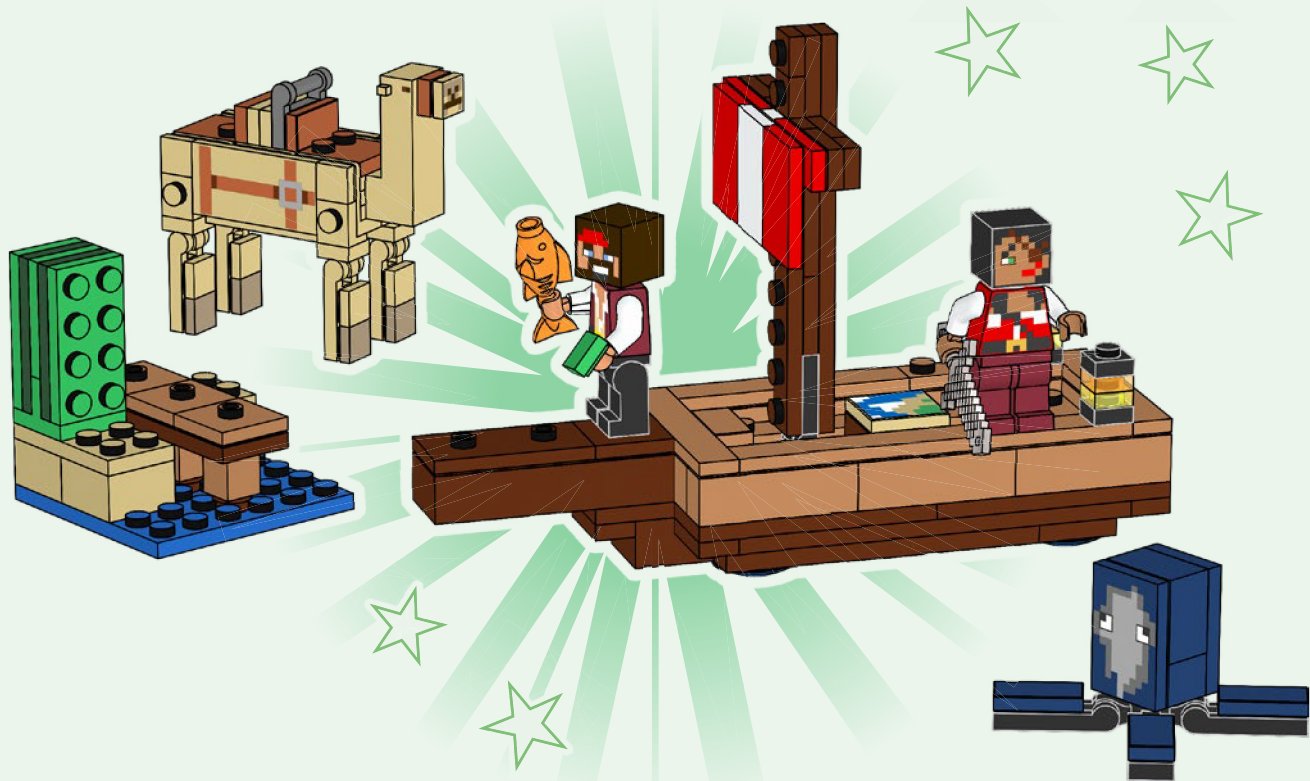



MINECRAFT



Combine sets to
expand your play!

Combiner les ensembles
pour encore plus de jeu !

¡Combina sets para
jugar mucho más!



MINECRAFT

21263



21261



21262



21264



21259



21260





1x
6195371



1x
6156667



4x
6360078



8x
4125253



1x
6468457



4x
6374192



1x
4109995



3x
4113917



6x
6174925



1x
6253003

50



1x
4114306



1x
6385114



1x
6468485



4x
6211975



3x
4114309



2x
6481438

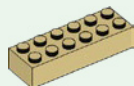

1x
4181134



2x
6251410



1x
6485119



2x
6189130



4x
4278276



1x
300123



1x
4199519



6x
302426



1x
6279875



1x
6481435



1x
9339



1x
6320293



1x
6265730



1x
6267045



4x
4515368



1x
4558593



1x
6352550



1x
302128



2x
302028



1x
6186012



1x
4570877



1x
4614158



2x
6394948



2x
6252045



1x
4623481



4x
6055172



4x
4528488



1x
4296785



1x
6480279



1x
4530028



1x
6481439



2x
4586057



1x
4541496



1x
6485113



2x
6252040



2x
4216581



3x
4221744



8x
4211150



1x
4565394



1x
4216695



1x
4211210



1x
6050918



1x
6307618



2x
4211201



3x
4221590



1x
4211247



2x
4263776



1x
6096701



2x
4217848



5x
4223683



1x
6146321



1x
6481433



4x
6057986



2x
6215606



1x
6021997



3x
6102994



7x
6223183



7x
6257605



4x
6102995



1x
6089098

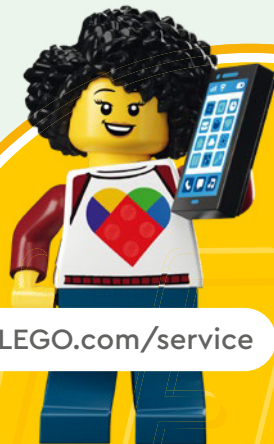

[LEGO.com/service](https://www.lego.com/service)

YOU COULD
WIN

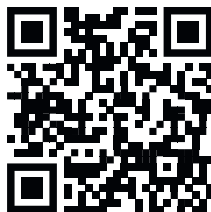

Scan this QR code or go to
LEGO.COM/PRODUCTFEEDBACK and give
us your short feedback about this LEGO® set
for a chance to win a cool LEGO prize.

Terms and Conditions apply*

EN: YOU COULD WIN. Terms and Conditions apply* **DE: Du könntest GEWINNEN.** Es gelten die Teilnahmebedingungen* **FR: Tu pourrais GAGNER.** Des conditions s'appliquent* **IT: Potresti VINCERE tu.** Termini e condizioni sono applicabili* **ES: Puedes GANAR.** Aplican términos y condiciones* **PT: Poderá GANHAR.** Aplicam-se termos e condições* **ZH: 轻松获奖. 条款和条件适用*** **PL: Szansa na WYGRANĄ.** Obowiązują warunki korzystania* **CS: Máte šanci VYHRÁT.** Platí všeobecné smluvní podmínky* **SK: Máte šancu VYHRÁŤ.** Platia všeobecné zmluvné podmienky* **HU: TE IS NYERHETSZ.** Felhasználási feltételek érvényesek* **RO: Ai putea CÂȘTIGA.** Se aplică termenii și condiții* **BG: Можете да СПЕЧЕЛИТЕ.** Има определени правила и условия* **LV: Tu vari LAIMĒT.** Ir spēkā noteikumi un nosacījumi.* **ET: Sul on võimalus VÕITA.** Kehtivad tingimused* **LT: Jūs galite LAIMĖTI.** Taikomos sąlygos*

*[LEGO.com/productfeedback-terms](https://www.lego.com/productfeedback-terms)

LEGO and the LEGO logo are trademarks of the/son des marques de commerce du/son marcas registradas de LEGO Group. ©2024 The LEGO Group.

© 2024 Mojang AB. All Rights Reserved. Minecraft, the Minecraft logo, the Mojang Studios logo and the Creeper logo are trademarks of the Microsoft group of companies.

6520683