



JURASSIC WORLD

76962



LEGO® Builder



LEGO.com/sustainable-packaging



 ^{FR} **DONNEZ
OU
RECYCLEZ**  OU  OU 
ASSOCIATION MAGASIN DÉCHÈTERIE

Adresses sur quefairedemesdechets.fr

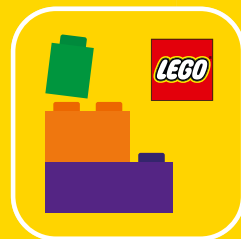

BUILDER



Apple and the Apple logo are trademarks of Apple Inc., registered in the U.S. and other countries and regions. App Store is a service mark of Apple Inc. Google Play and the Google Play logo are trademarks of Google LLC. Tencent and the Tencent logo are trademarks of Tencent Inc.

[LEGO.com/devicecheck](https://www.lego.com/devicecheck)

EN Ask parents' permission before going online | **DE** Eltern um Erlaubnis bitten, bevor du online gehst | **FR** Demande l'autorisation d'un parent avant d'aller en ligne | **IT** Chiedi il permesso ai tuoi genitori prima di andare online | **ES** Pídeles permiso a tus papás antes de conectarte a Internet | **PT** Pede autorização aos pais antes de acederes online | **ZH** 上网前应先征得父母的同意 | **PL** Poproś rodziców o zgodę, zanim wejdiesz do Internetu | **CS** Než půjdeš na internet, požádej rodiče o svolení | **SK** Skôr než pôjdeš na internet, vypýtaj si povolenie od rodičov | **HU** Kérj szülői engedélyt, mielőtt online csatlakoznál! | **RO** Cere permisiunea părinților înainte de a te conecta online | **BG** Поискайте разрешение от родител, преди да влезете онлайн | **LV** Pirms došanās tiešsaistē palūdz atļauju vecākiem | **ET** Enne Interneti kasutamist küsi vanematelt luba | **LT** Prieš prisijungdami prie interneto, atsiklauskite tėvų



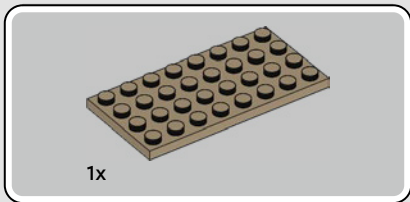
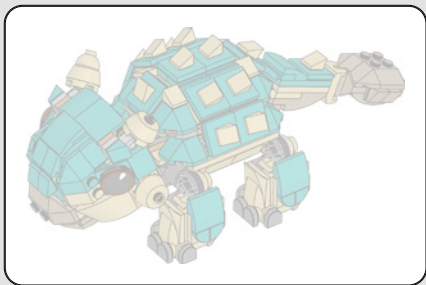

1

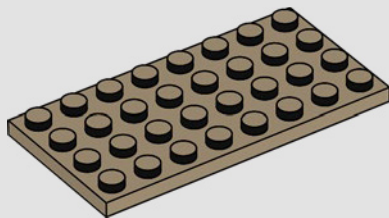



2x

2

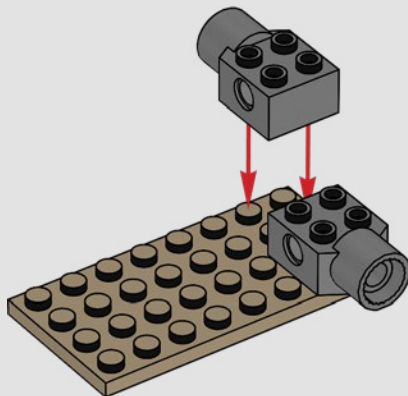

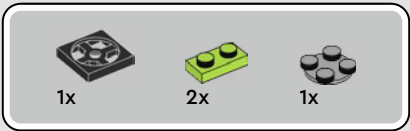

3

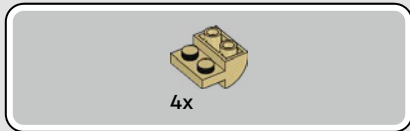
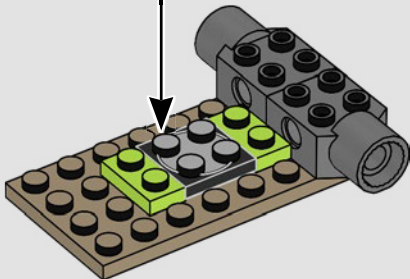
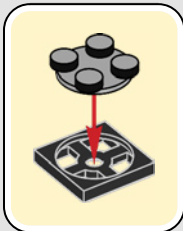

4

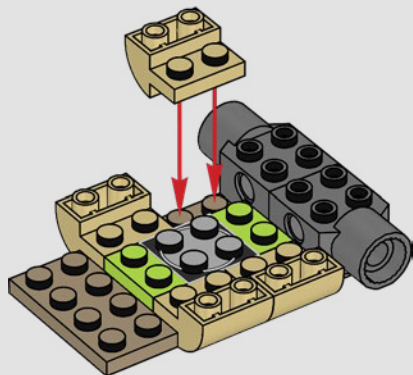

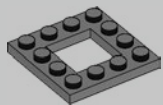

1x

5

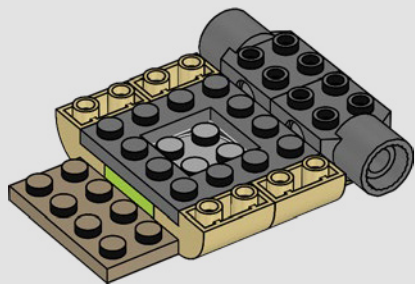



1x

6

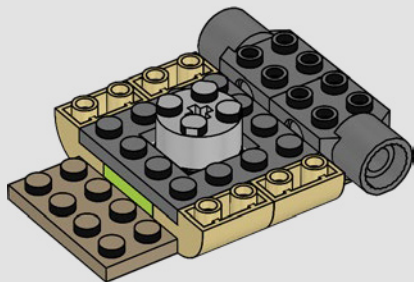

2x

7

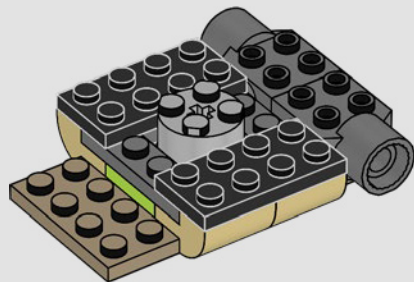

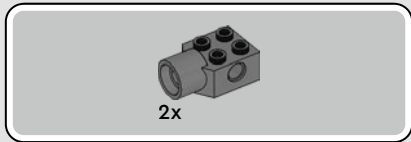

8

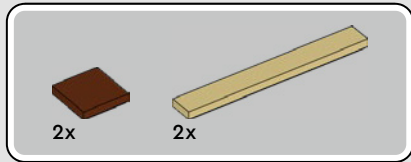
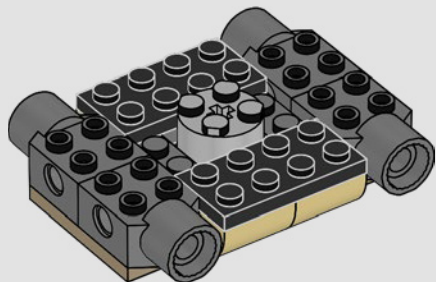

9

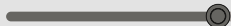
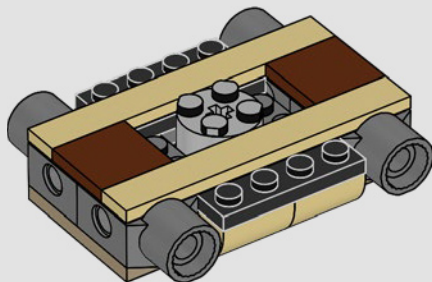

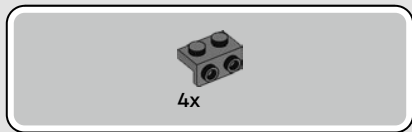

10

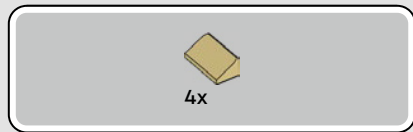
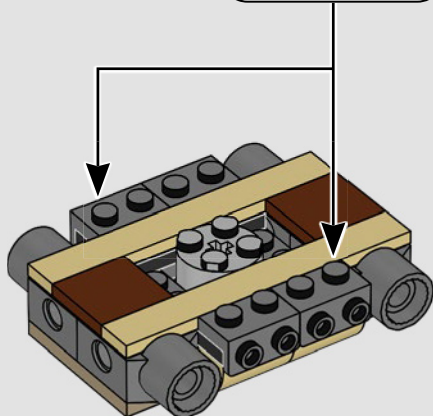
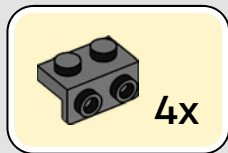

11

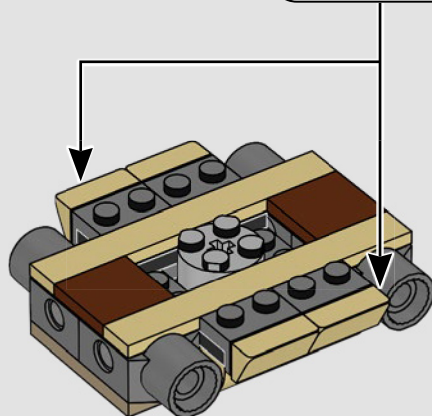
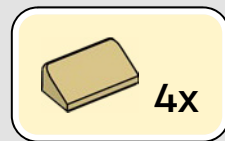

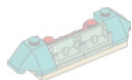

2x

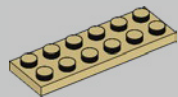

2x



2x



4x



4x



4x

12

1

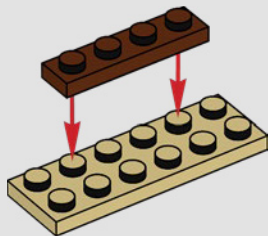

2

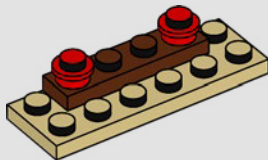

3

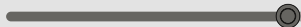
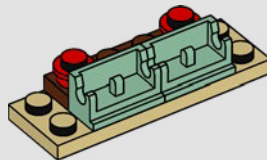

4

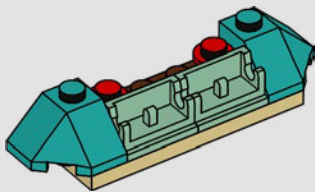

2x

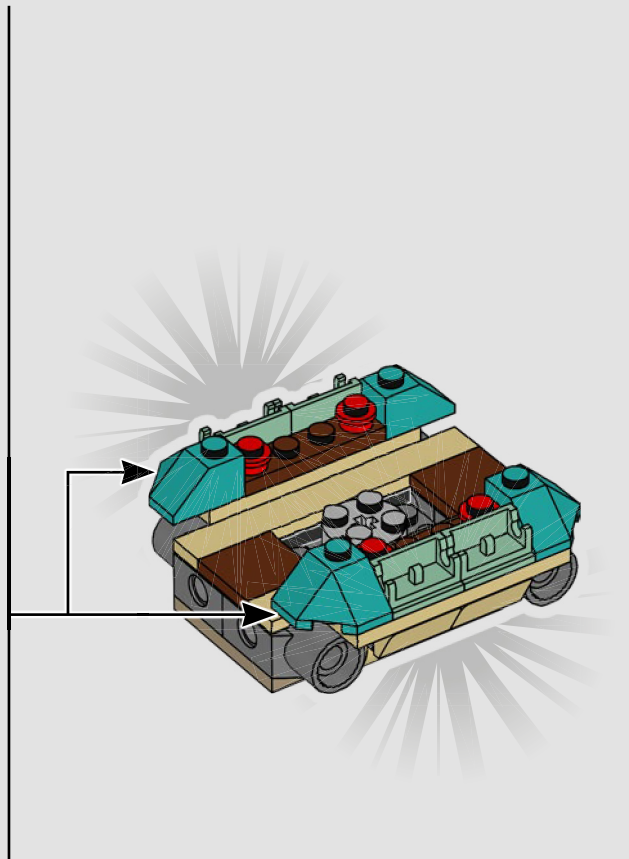

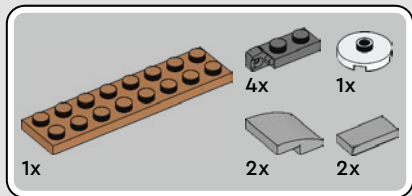

13

1

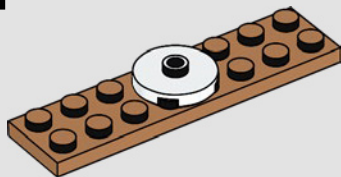

2

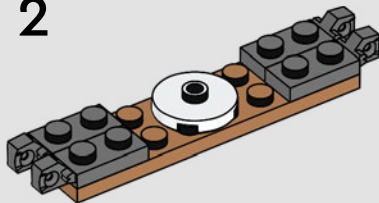

3

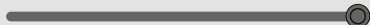
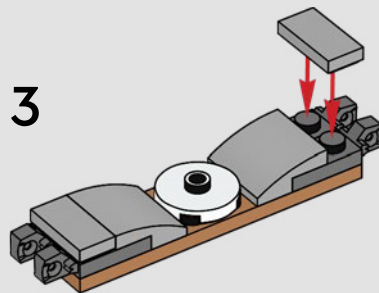

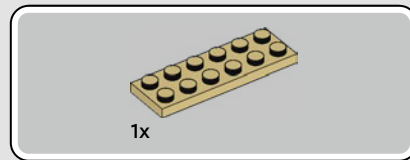
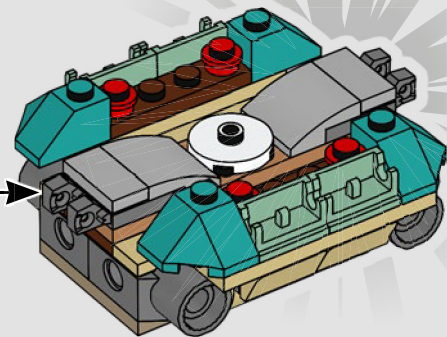

14

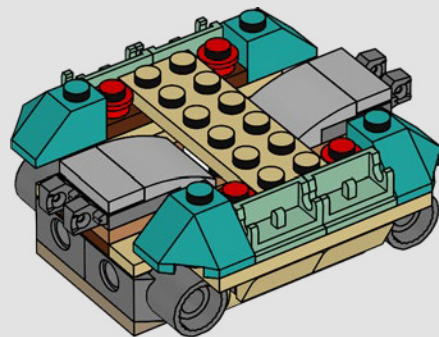



15

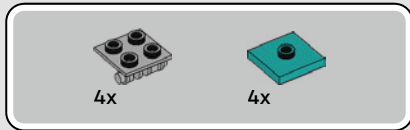
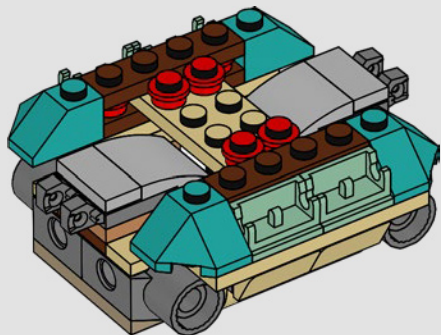

16

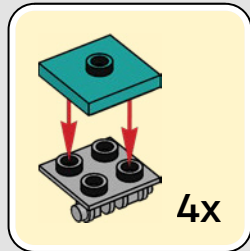
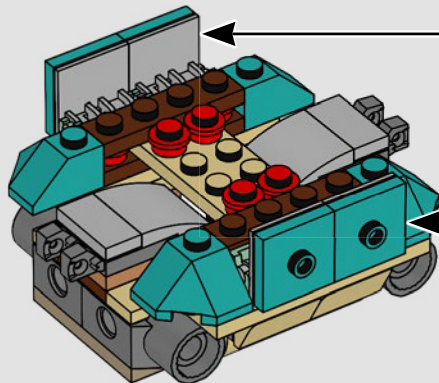

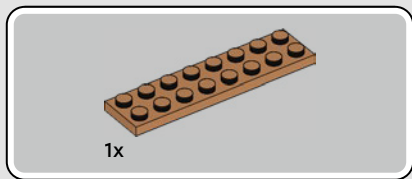
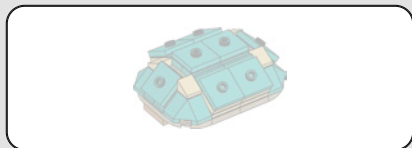

17

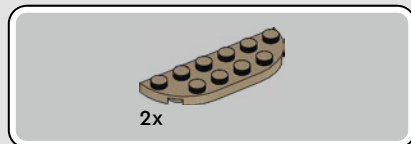
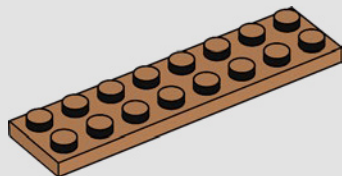

18

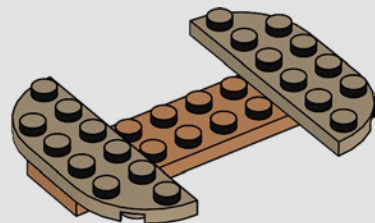



4x

19

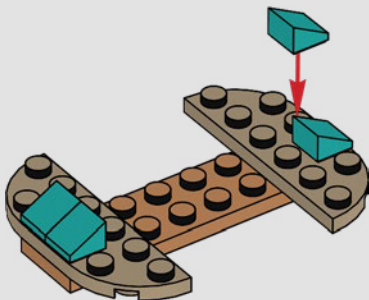

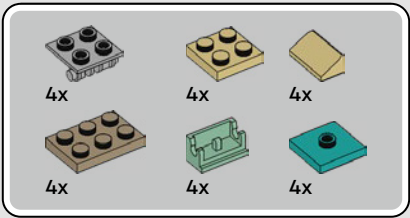

20

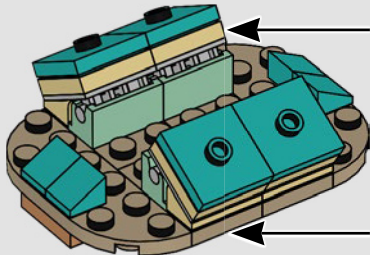
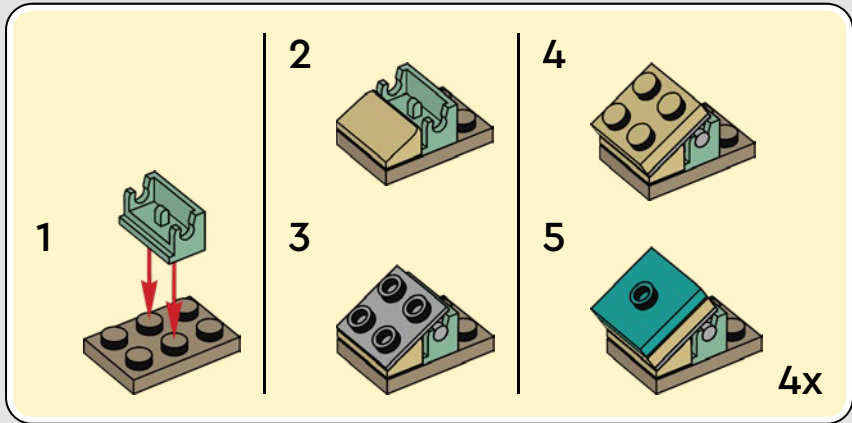

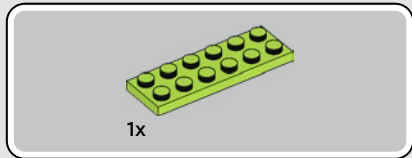

21

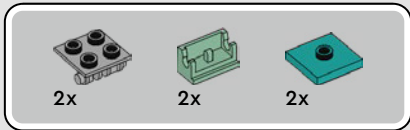
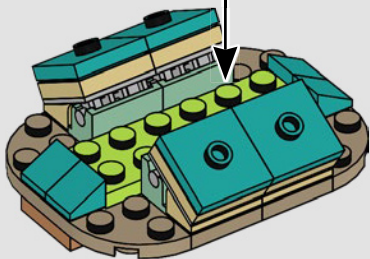
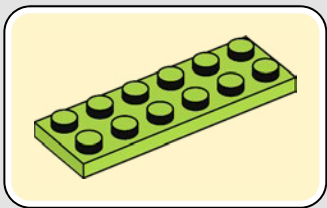

22

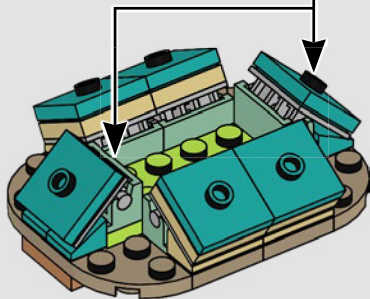
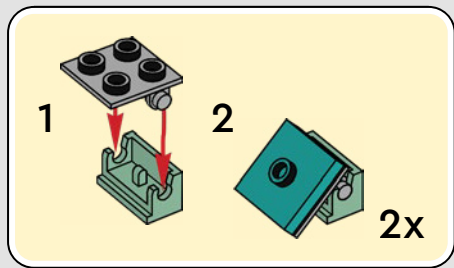



4x

23

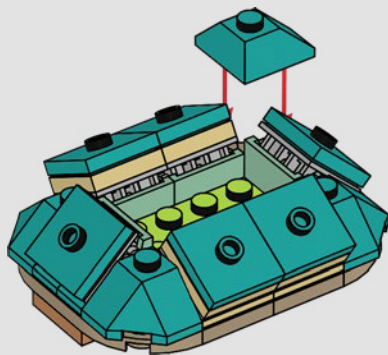

4x

24

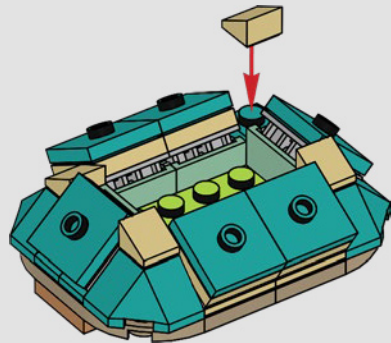

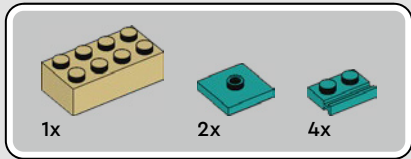

25

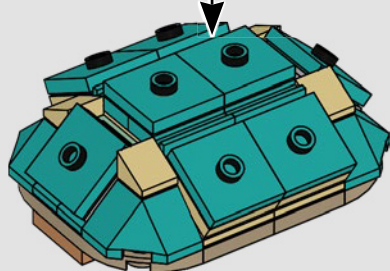
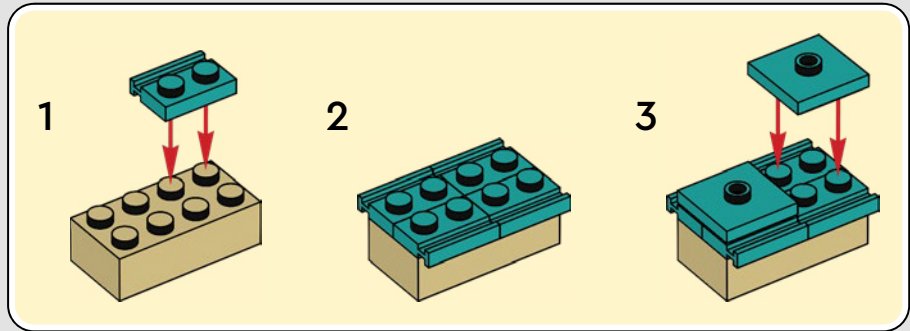

26

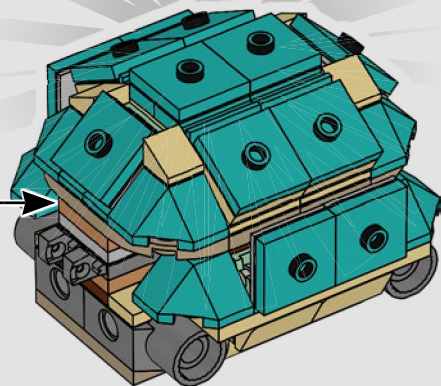

27

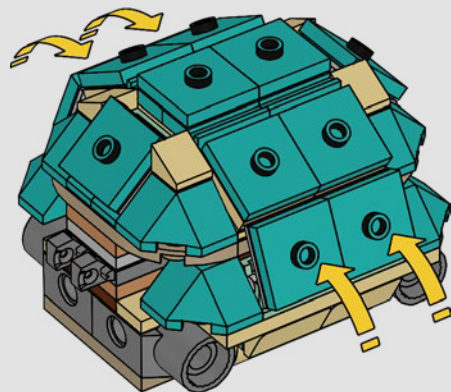



12x

28



12x

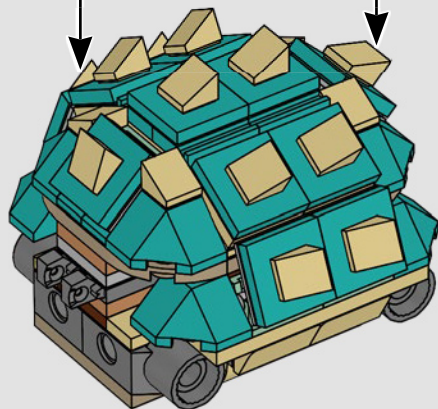



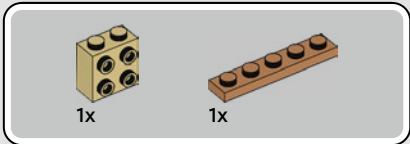
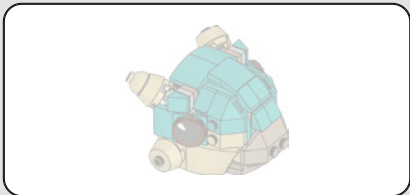

29

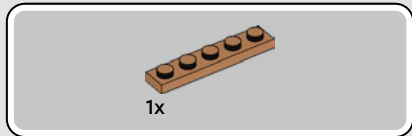
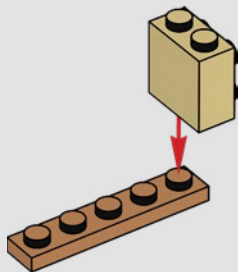

30

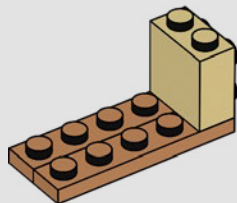



1x



2x

31

1

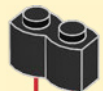

2

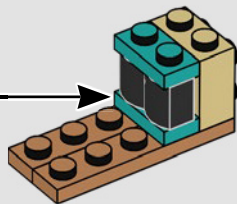
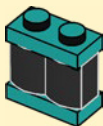

3x

32

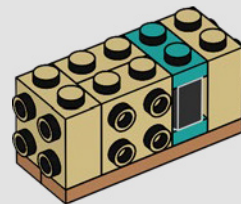



1x

33

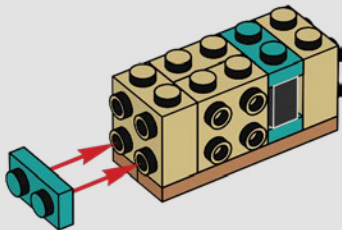

2x

34

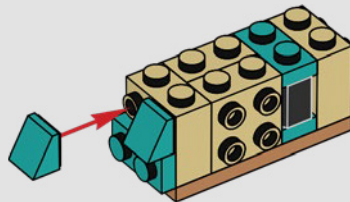



2x



2x

35

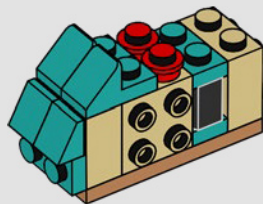

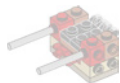

1x



1x

36

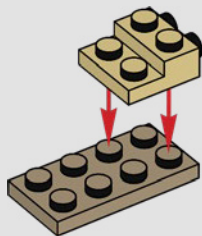

1x

37

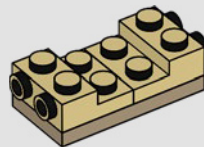



1x



1x

38

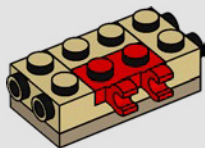

1x

39

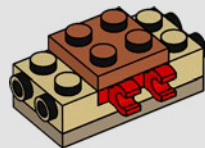



2x

40

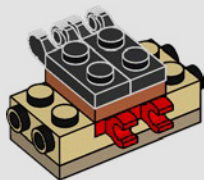

2x



2x

41

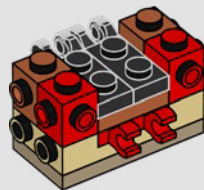

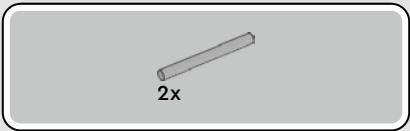

42

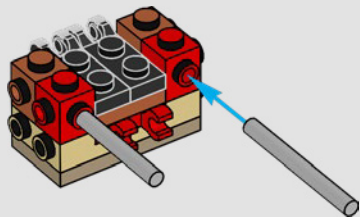

43

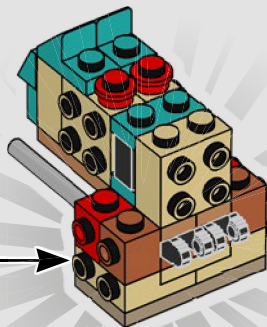
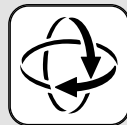



2x

44

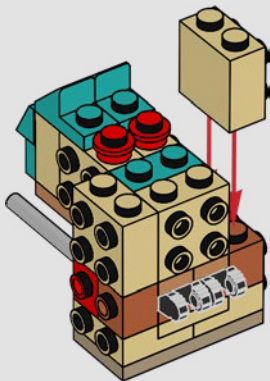

1x

45

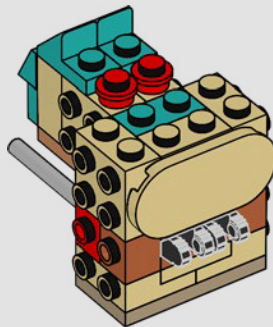



2x

46

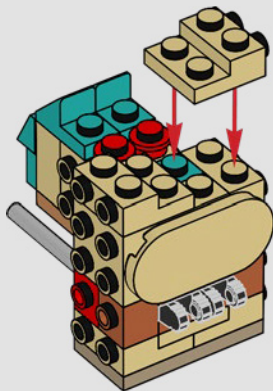

1x

47

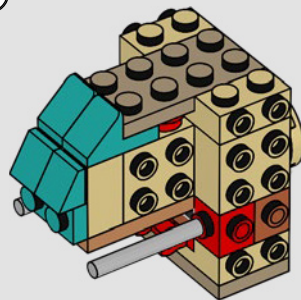

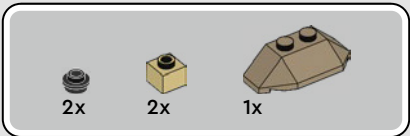

50

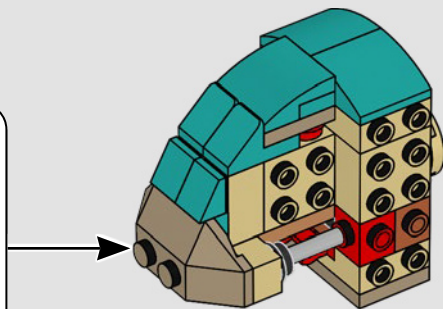
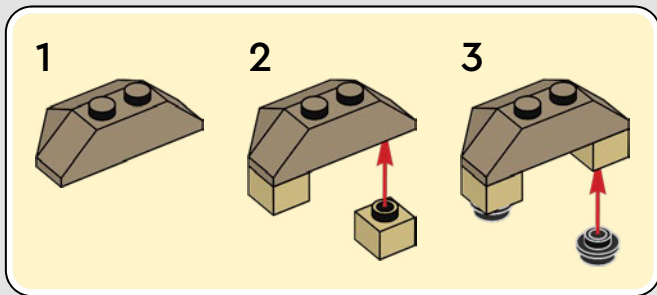

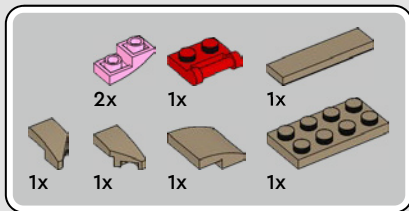

51

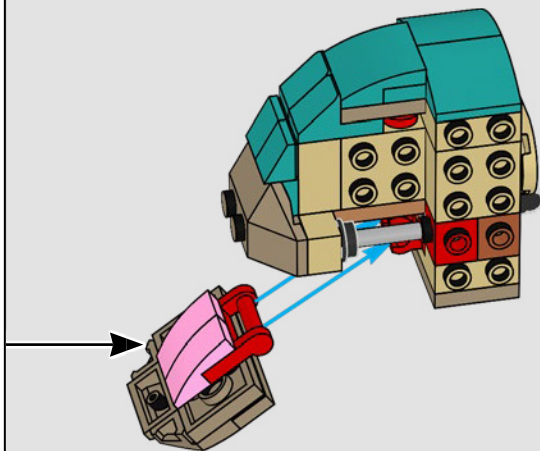
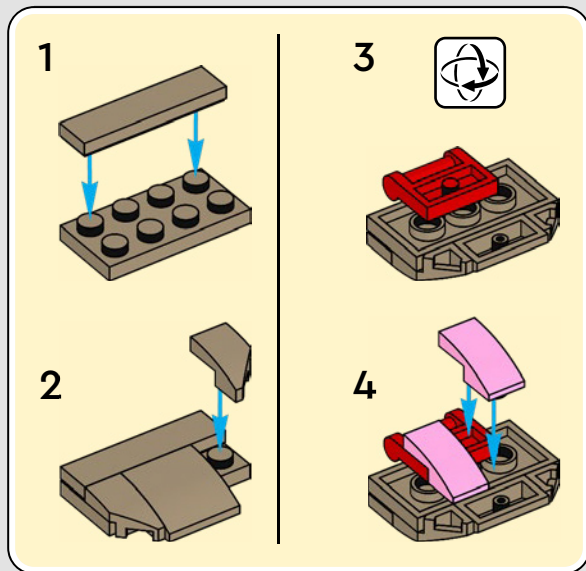



1x



1x

52

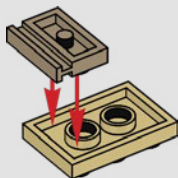

1x



1x

53

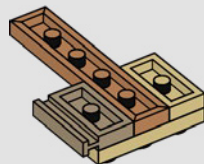



1x

54

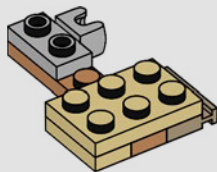

2x



1x

55

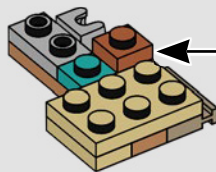

1



2





1x



1x

56

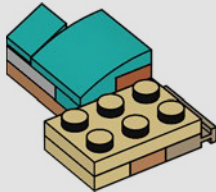

1x



1x

57

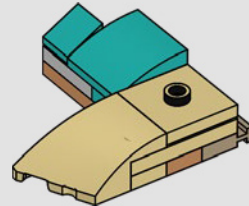



1x

58

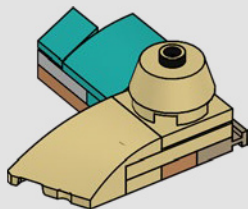

1x



1x

59

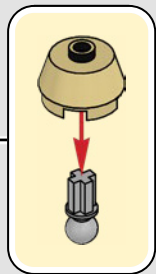
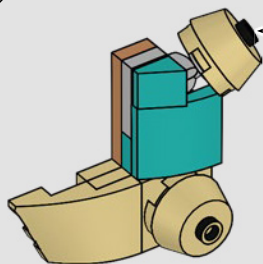

60

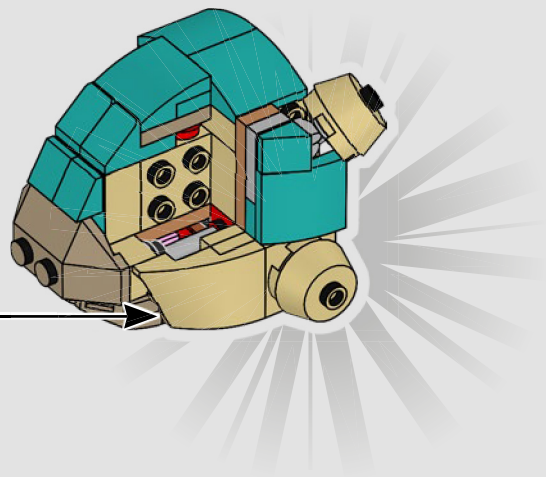

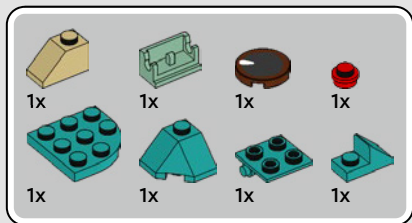

61

1



2



3

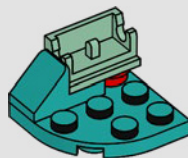

4

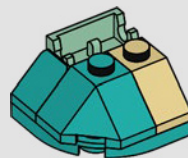

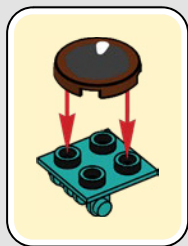

5

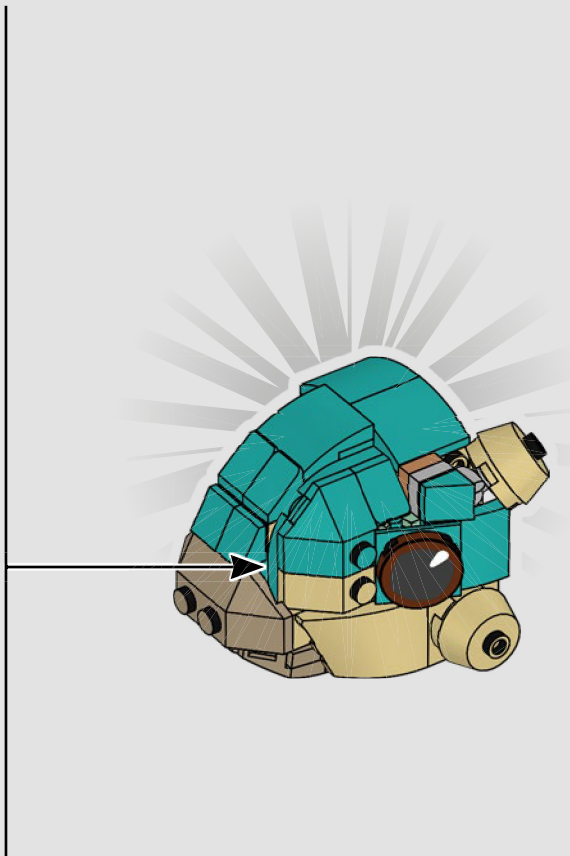
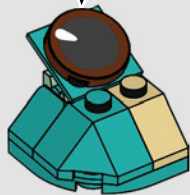

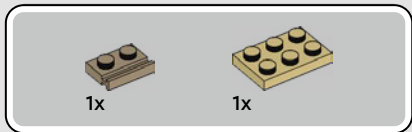
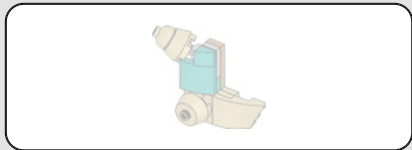

62

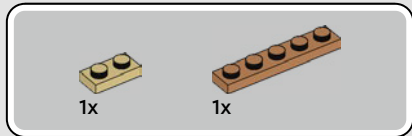
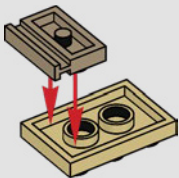

63

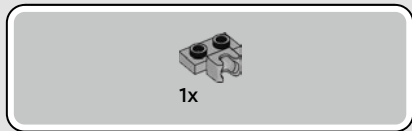
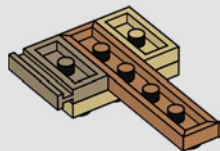

64

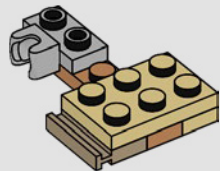



2x



1x

65

1

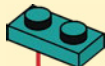

2

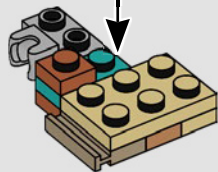
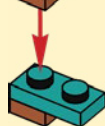

1x



1x

66

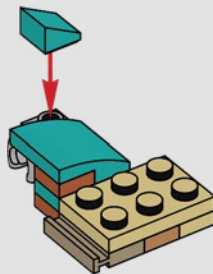



1x



1x

67

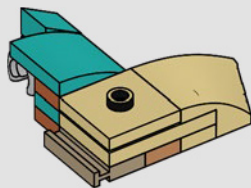

1x

68

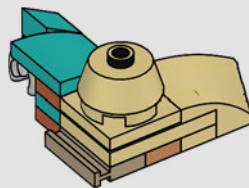



69

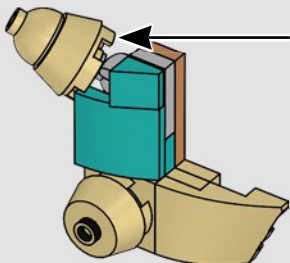
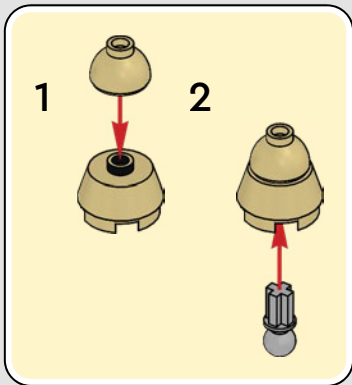

70

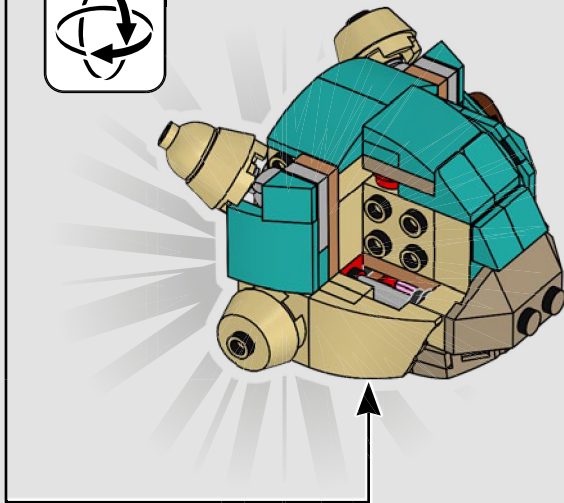

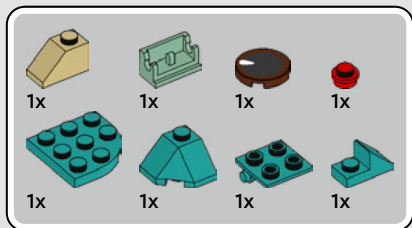

71

1

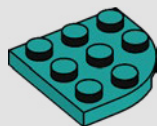

2

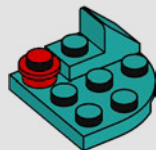

3

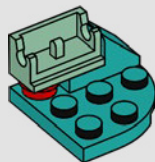

4

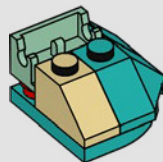

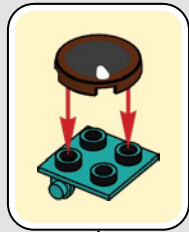

5

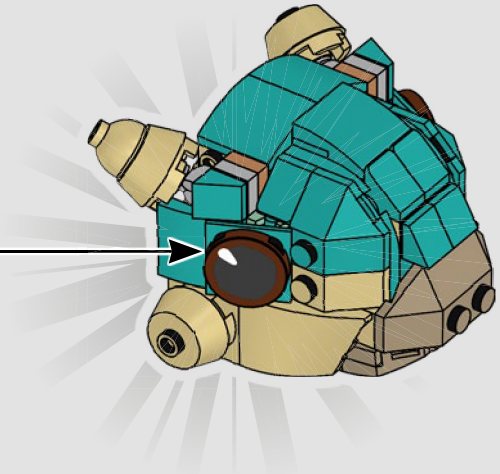
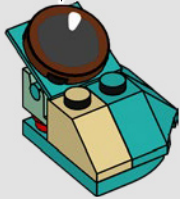

72

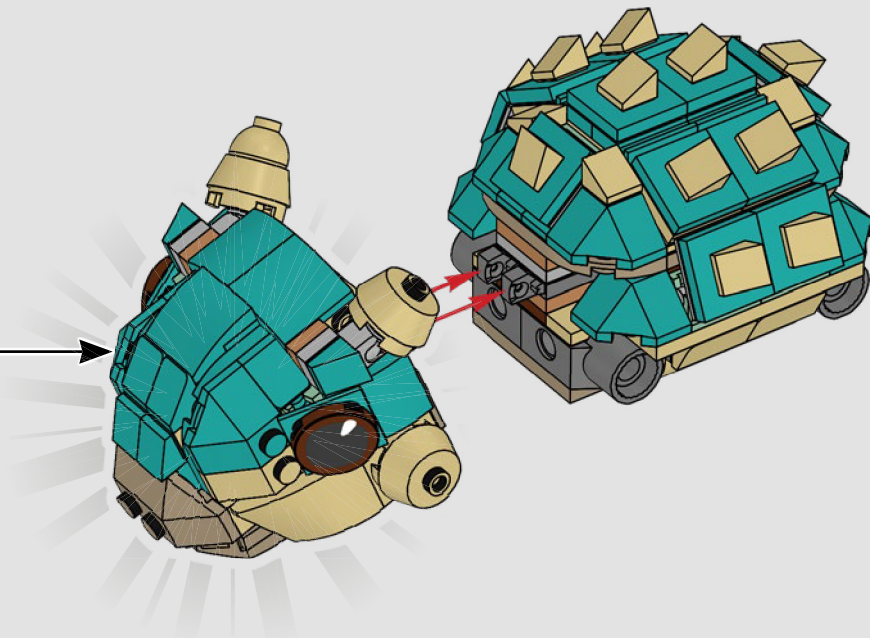





2x

73

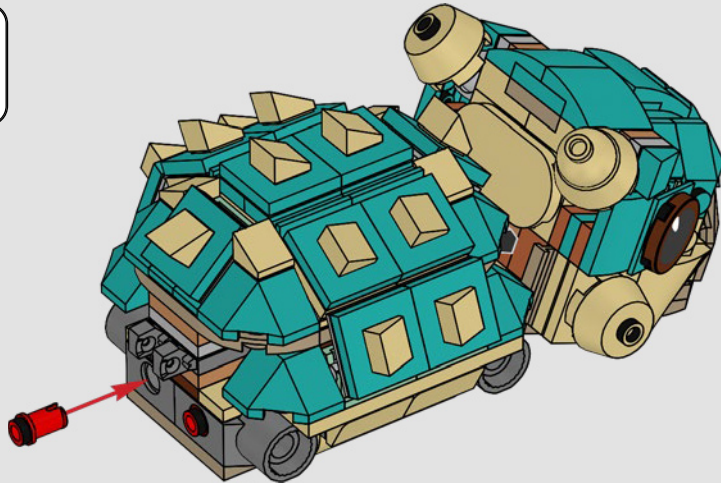

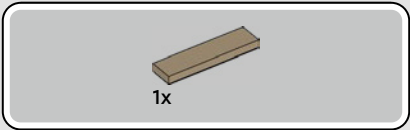

74

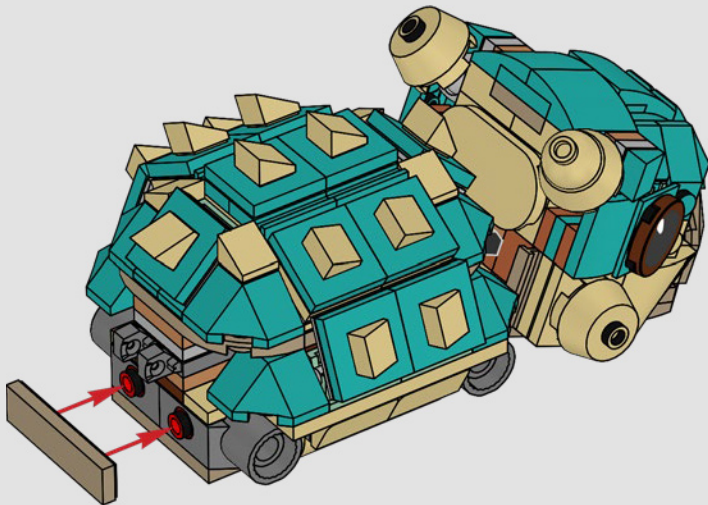



1x

75

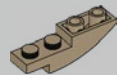

2x

76

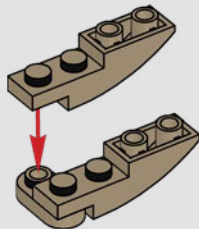



2x

77

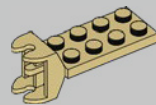
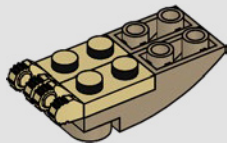

1x

78

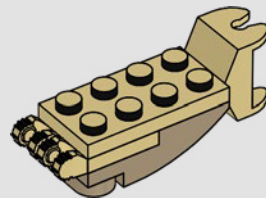

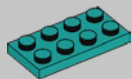

1x

79

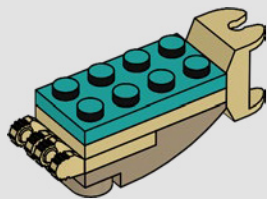

1x



1x

80

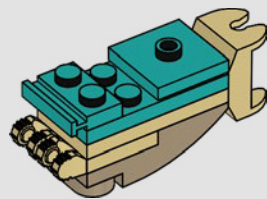



1x



1x

81

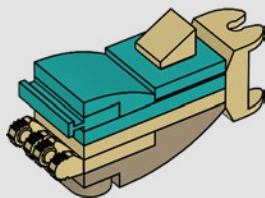

82

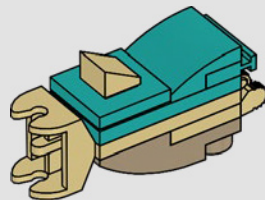

83

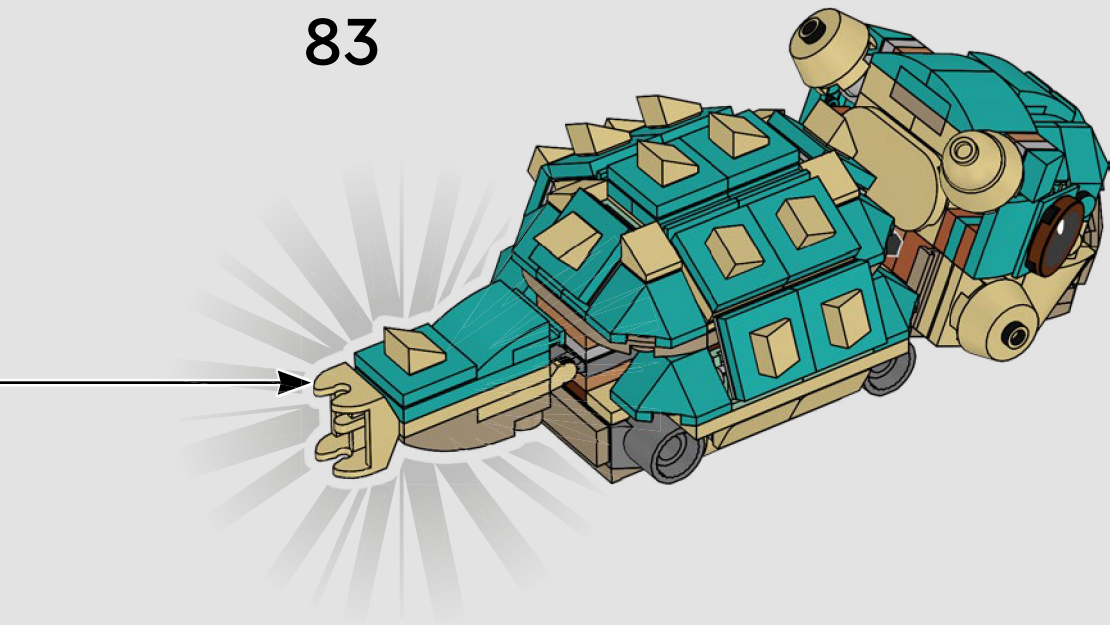



4x



2x



2x



2x



1x

84

1

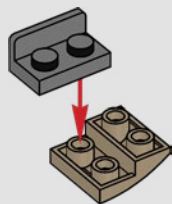

2

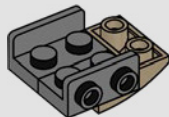

3

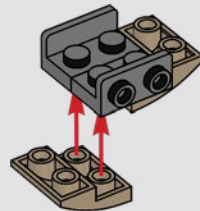

4

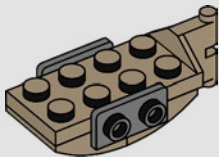

5

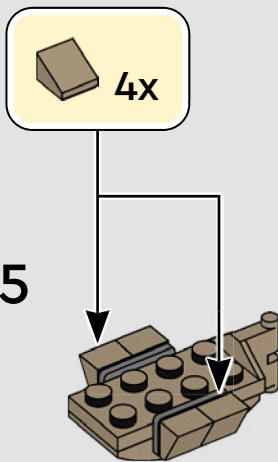

6

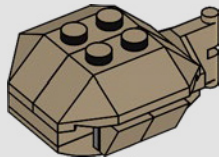

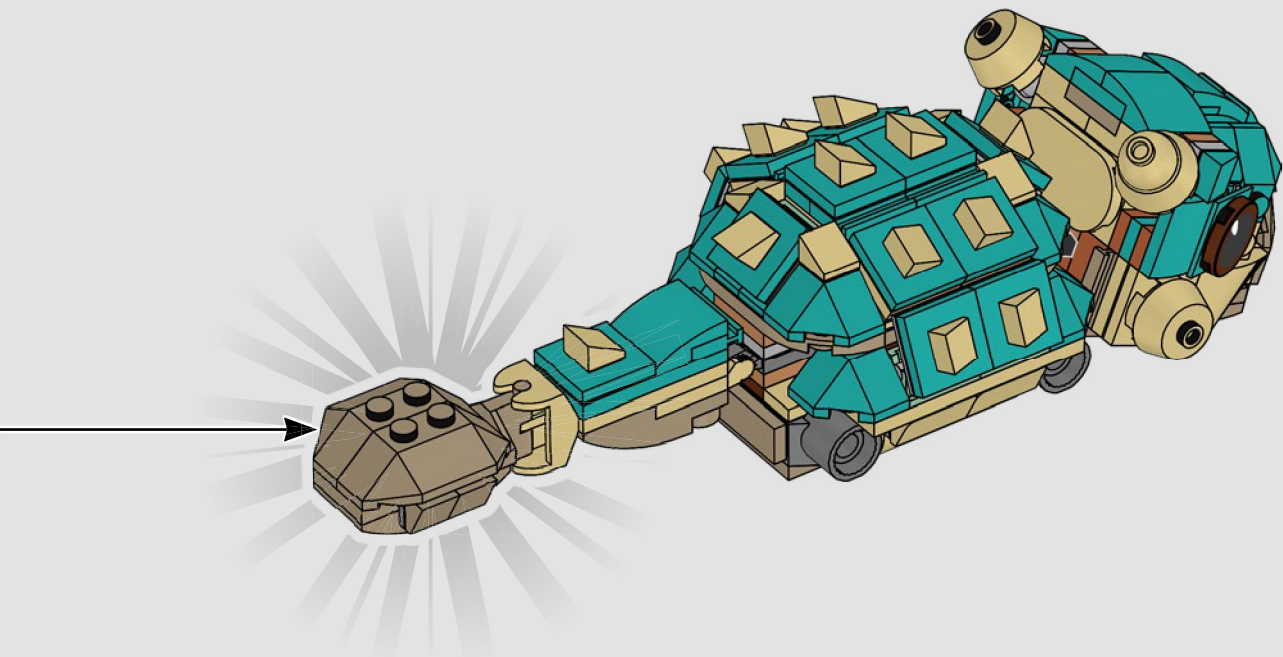



2x



1x

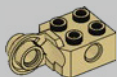

1x

85

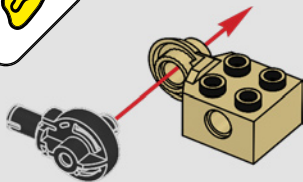

2x

86



2x

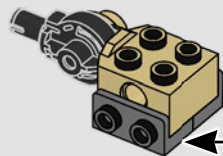



2x

87

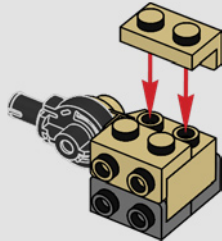

1x

88

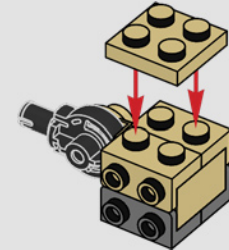



1x



2x

89

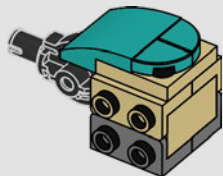

1x

90

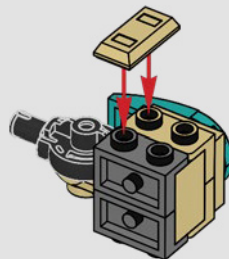



1x



2x

91

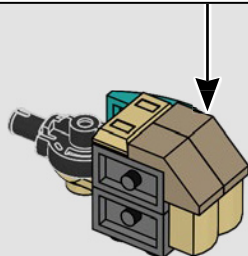
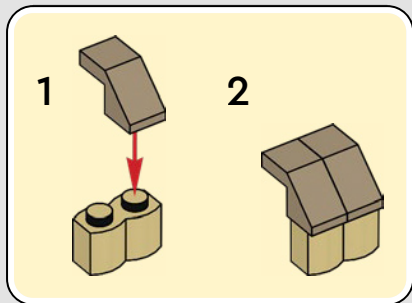

1x

92

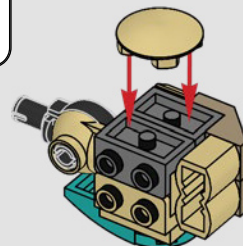

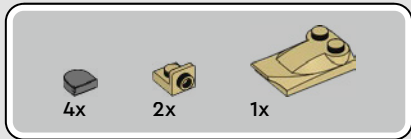

93

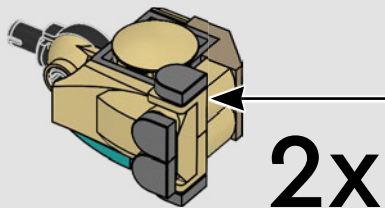
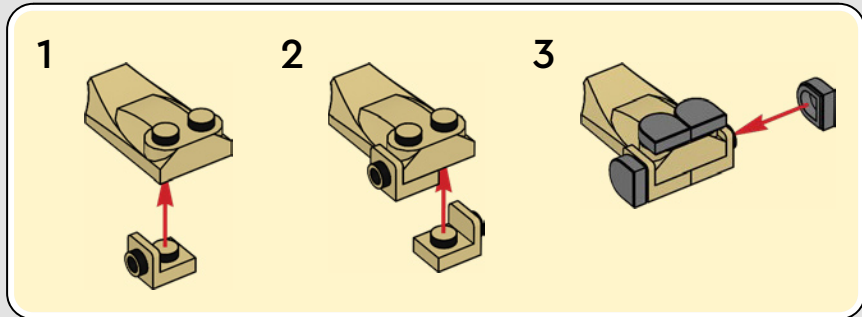

94

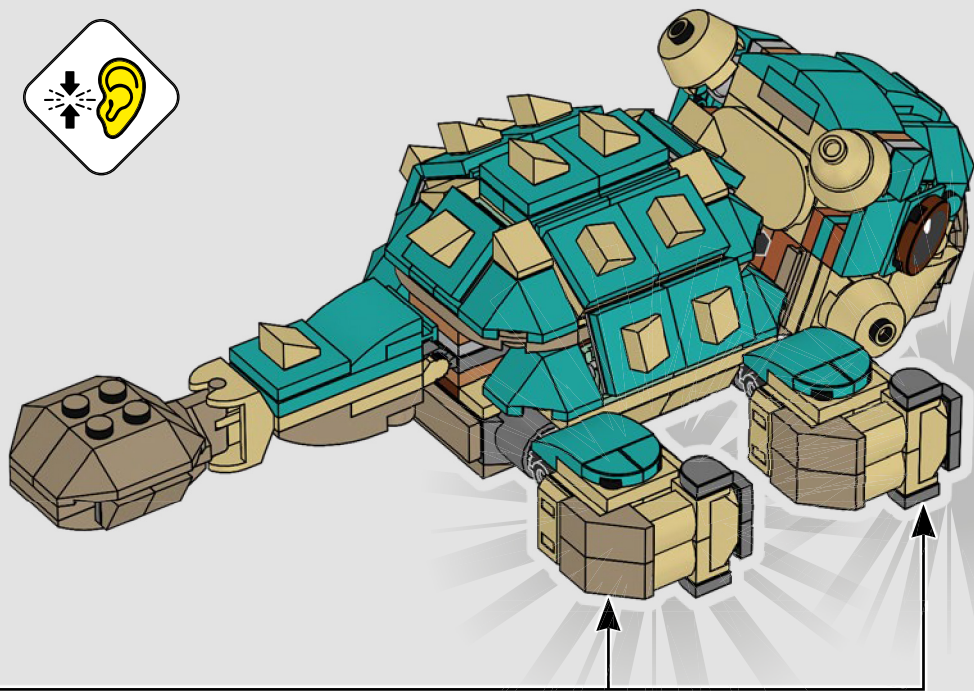



2x



1x

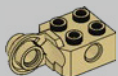

1x

95

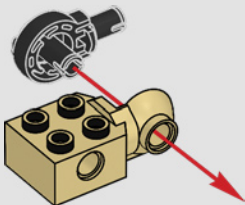

2x

96



2x

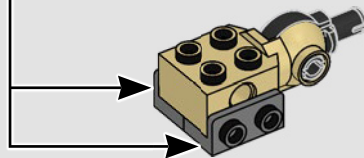



2x

97

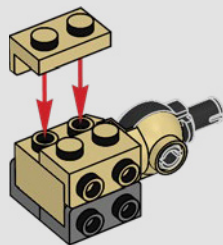

1x

98

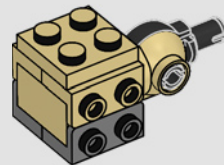



1x



2x

99

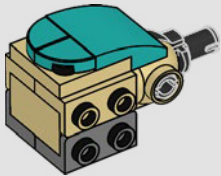

1x

100

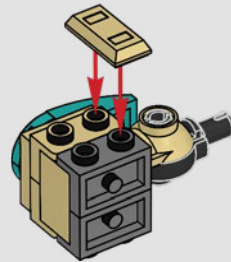
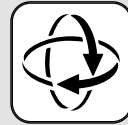



1x



2x

101

1

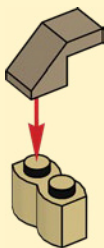

2

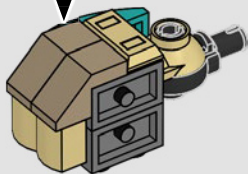

1x

102

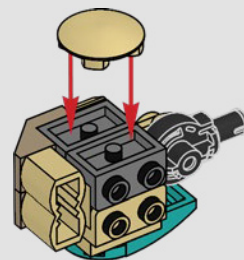

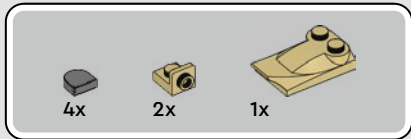

103

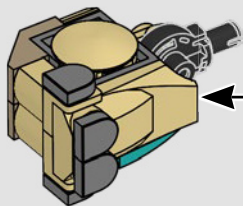
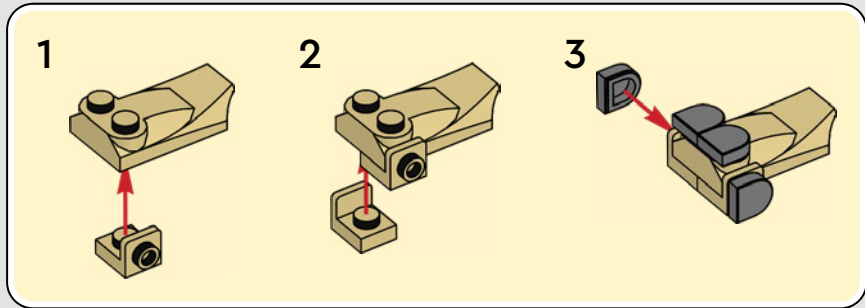

2x

104

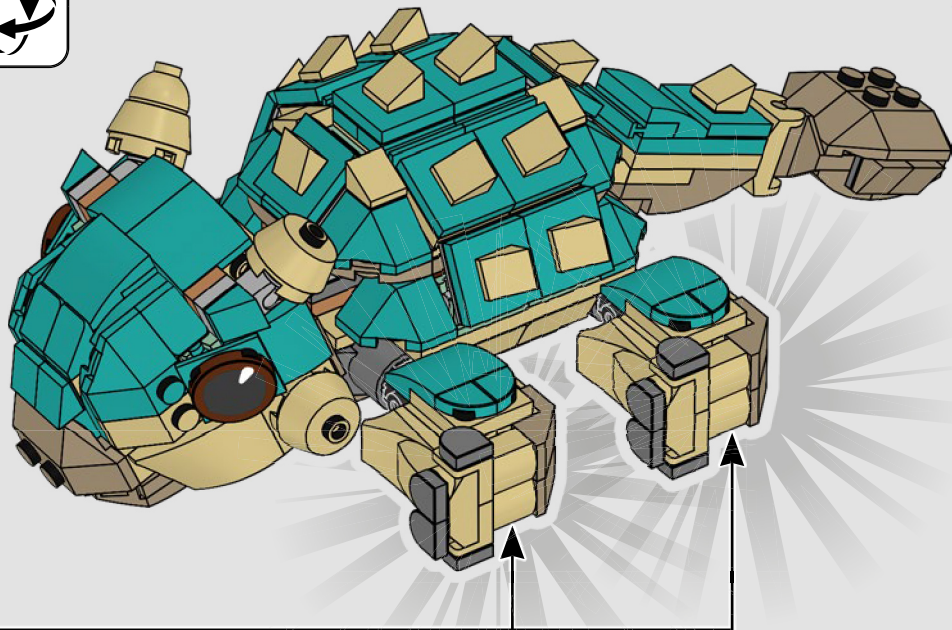

105

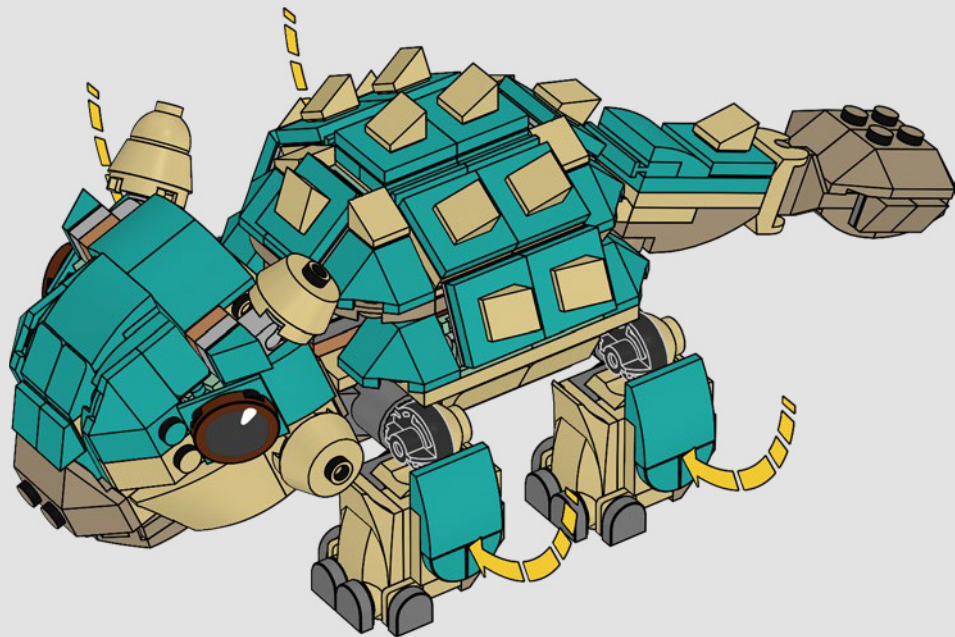

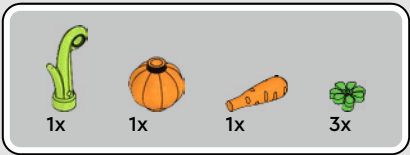

106

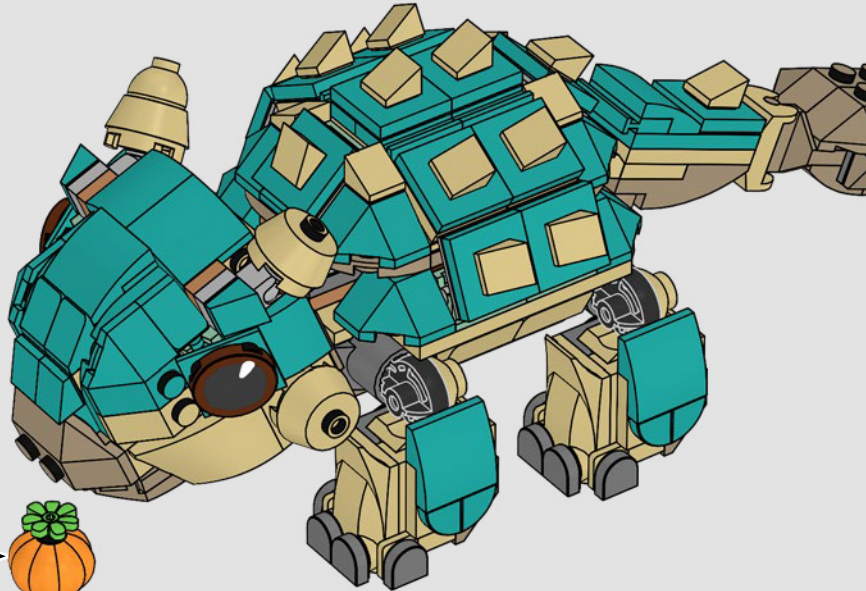
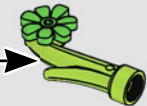
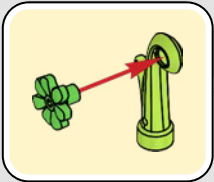
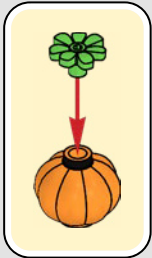
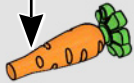
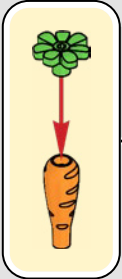

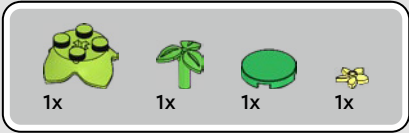

107

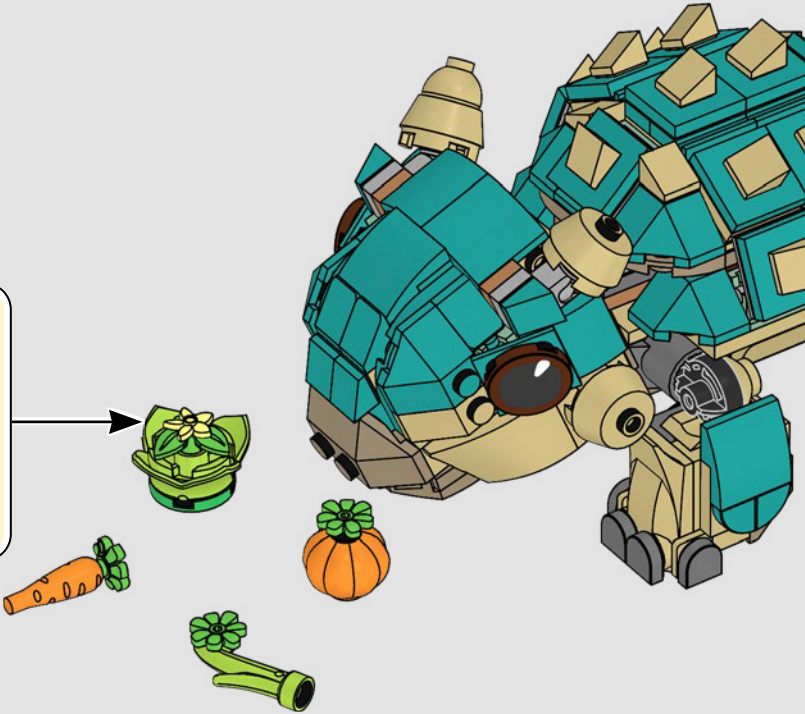
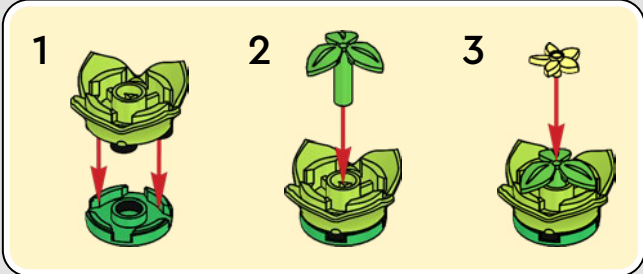







Rebuild
the
world™





1x
6093053



8x
6365720



4x
4218749



1x
4114319



6x
6214334



4x
6375375



4x
6215023



8x
4624086



2x
4121972

82



1x
6404629



4x
6485743



1x
6404628



4x
6271228



3x
4113917



2x
4565387



8x
4114084



2x
4118790



3x
4113993



1x
6487883



8x
6249809



4x
6469454



2x
6485745



4x
4278422



1x
6294716



4x
6485751



1x
6485750



2x
4544139



17x
4516055



2x
6458392



2x
6473603



1x
6360036



1x
4226876



12x
614121



2x
6378120



1x
4644456



4x
4213374



2x
302026



2x
6168646



2x
6267045



1x
368026



1x
6238881



3x
6488792



1x
6235080



1x
6267125



1x
6424015



8x
6240467



8x
6278172



4x
6487879



5x
6213777



5x
6441762



10x
6307898



10x
6223665



13x
6290269



2x
6488169



1x
6249417



1x
6338181



2x
6251838



2x
4164037



1x
4621548



1x
6188696



1x
6210415



4x
6040126



8x
6335228



3x
6487880



1x
6258951



1x
6258949



1x
6231386



1x
6093038



2x
6356427



2x
6271979



4x
6035540



2x
6175927



3x
4267874

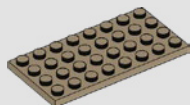

1x
6006524



2x
4616711



2x
6167854



1x
6487884



2x
4271949



4x
4211190



2x
6482494



1x
4211526



2x
6102357



2x
4211414



2x
6043656



2x
6116608



2x
6443149



1x
4540203



10x
4211881



2x
6296041



4x
6278974



1x
6186825



10x
6000606



4x
6214341



4x
6266225



16x
6362252



2x
4666322



4x
6186012



1x
4615606



1x
6451205



12x
6223234



4x
6343854



2x
6226644



 [LEGO.com/service](https://www.LEGO.com/service)

YOU COULD
WIN



Scan this QR code or go to
LEGO.COM/PRODUCTFEEDBACK and give
us your short feedback about this LEGO® set
for a chance to win a cool LEGO prize.

Terms and Conditions apply*

EN: YOU COULD WIN. Terms and Conditions apply* **DE: Du könntest GEWINNEN.** Es gelten die Teilnahmebedingungen* **FR: Tu pourrais GAGNER.** Des conditions s'appliquent* **IT: Potresti VINCERE tu.** Termini e condizioni sono applicabili* **ES: Puedes GANAR.** Aplican términos y condiciones* **PT: Poderá GANHAR.** Aplicam-se termos e condições* **ZH: 轻松获奖. 条款和条件适用*** **PL: Szansa na WYGRANĄ.** Obowiązują warunki korzystania* **CS: Máte šanci VYHRÁT.** Platí všeobecné smluvní podmínky* **SK: Máte šancu VYHRAŤ.** Platia všeobecné zmluvné podmienky* **HU: TE IS NYERHETSZ.** Felhasználási feltételek érvényesek* **RO: Ai putea CÂȘTIGA.** Se aplică termenii și condiții* **BG: Можете да СПЕЧЕЛИТЕ.** Има определени правила и условия* **LV: Tu vari LAIMĒT.** Ir spēkā noteikumi un nosacījumi.* **ET: Sul on võimalus VÕITA.** Kehtivad tingimused* **LT: Jūs galite LAIMĖTI.** Taikomos sąlygos*

*[LEGO.com/productfeedback-terms](https://www.lego.com/productfeedback-terms)

LEGO and the LEGO logo and are trademarks of the LEGO Group. ©2024 The LEGO Group.

© Universal City Studios LLC and Amblin Entertainment, Inc. Series © DreamWorks Animation LLC. All Rights Reserved.

6519662