



**MARVEL**

76292



LEGO® Builder



### **Get excited about our new packaging!**

We're switching from plastic to paper-based packaging. That's why you might find a mix of paper and plastic in our boxes!

### **Nos nouveaux emballages vous emballeront !**

Nous passons des emballages en plastique aux emballages à base de papier. C'est pourquoi vous pourriez trouver un mélange de papier et de plastique dans nos boîtes !

### **¡Te presentamos nuestros nuevos empaques!**

Estamos sustituyendo las bolsas de plástico por bolsas con base de papel. ¡Por eso, puedes encontrar una mezcla de papel y de plástico en nuestras cajas!

**[LEGO.com/sustainable-packaging](https://www.lego.com/sustainable-packaging)**

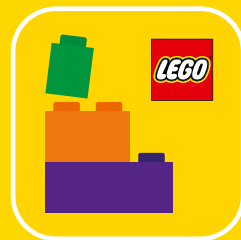

# BUILDER



Apple and the Apple logo are trademarks of Apple Inc., registered in the U.S. and other countries and regions. App Store is a service mark of Apple Inc. Google Play and the Google Play logo are trademarks of Google LLC. Tencent and the Tencent logo are trademarks of Tencent Inc.

[LEGO.com/devicecheck](https://www.lego.com/devicecheck)

**EN** Ask parents' permission before going online | **DE** Eltern um Erlaubnis bitten, bevor du online gehst | **FR** Demande l'autorisation d'un parent avant d'aller en ligne | **IT** Chiedi il permesso ai tuoi genitori prima di andare online | **ES** Pídeles permiso a tus papás antes de conectarte a Internet | **PT** Pede autorização aos pais antes de acederes online | **ZH** 上网前应先征得父母的同意 | **PL** Poproś rodziców o zgodę, zanim wejdziesz do Internetu | **CS** Než půjdeš na internet, požádej rodiče o svolení | **SK** Skôr než pôjdeš na internet, vypýtaj si povolenie od rodičov | **HU** Kérj szülői engedélyt, mielőtt online csatlakoznál! | **RO** Cere permisiunea părinților înainte de a te conecta online | **BG** Поискайте разрешение от родител, преди да влезете онлайн | **LV** Pirms došanās tiešsaistē palūdz atļauju vecākiem | **ET** Enne Interneti kasutamist küsi vanematelt luba | **LT** Prieš prisijungdami prie interneto, atsiklauskite tėvų

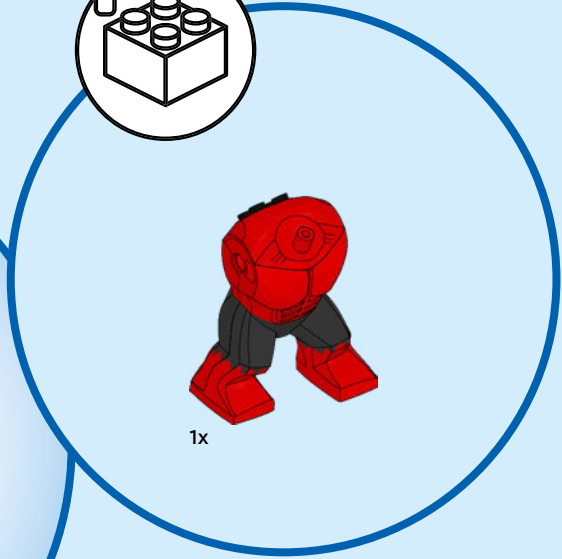
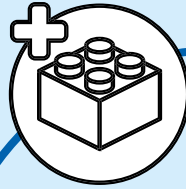



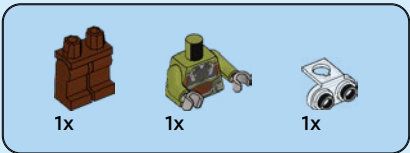
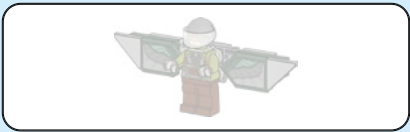

1

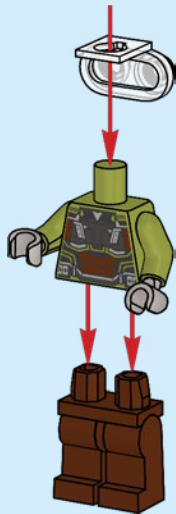

2

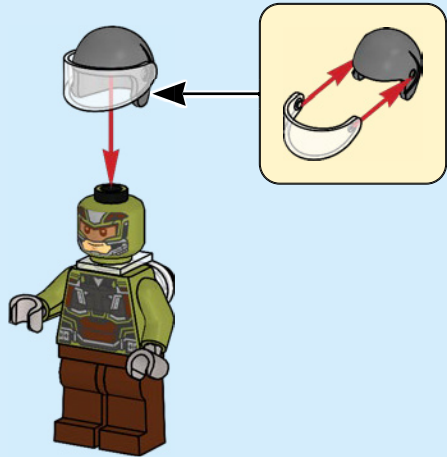

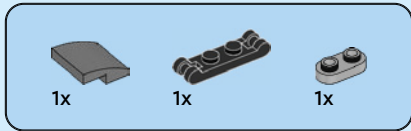

3

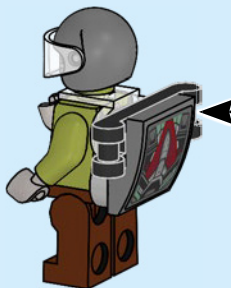
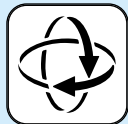
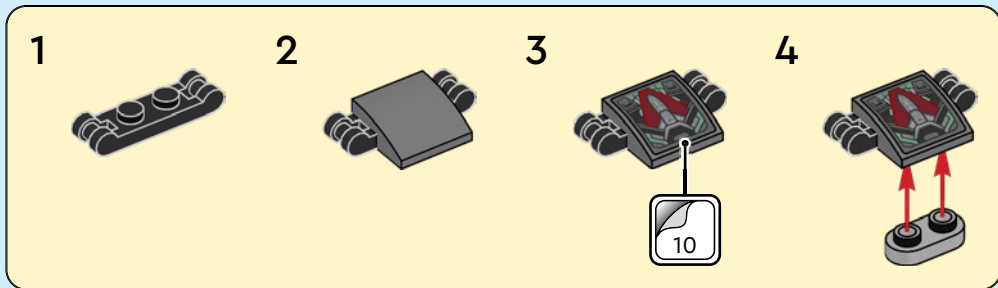

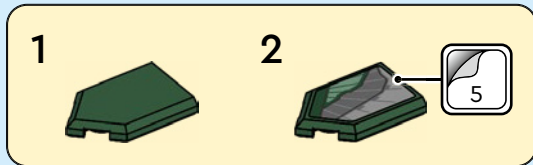
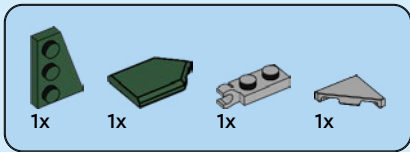

4

1

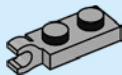

2

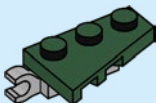

3



4

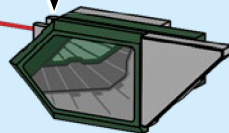
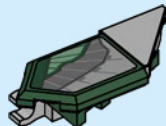

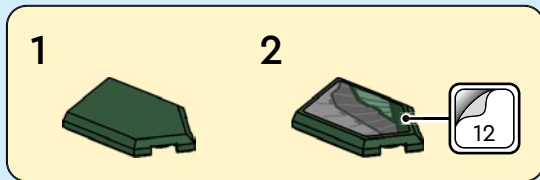
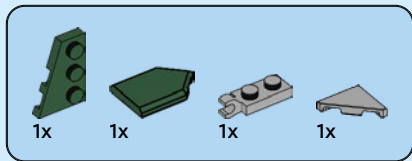

5

1

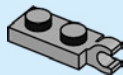

2

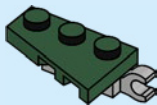

3



4

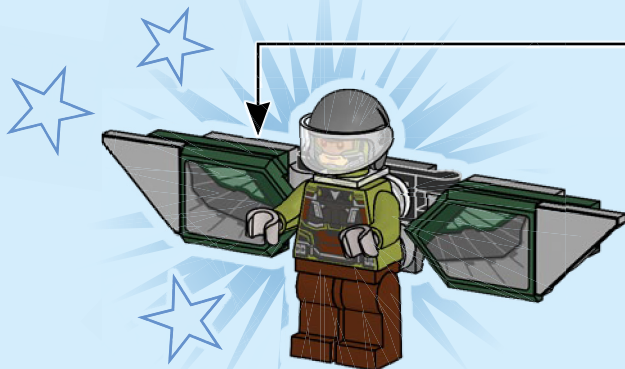

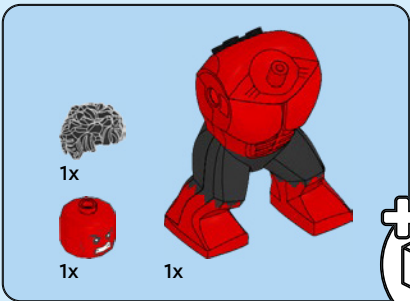
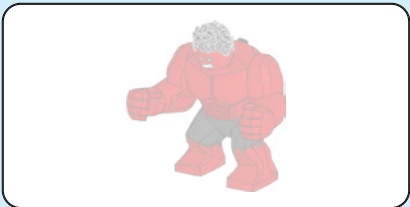

1

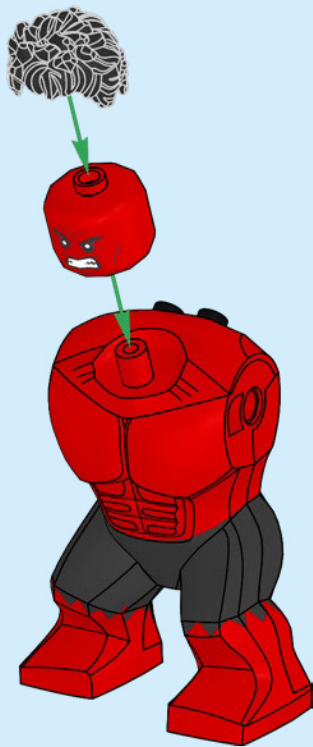



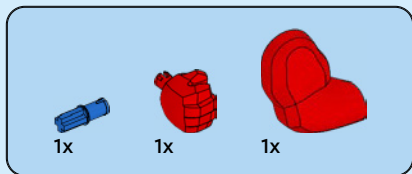

2

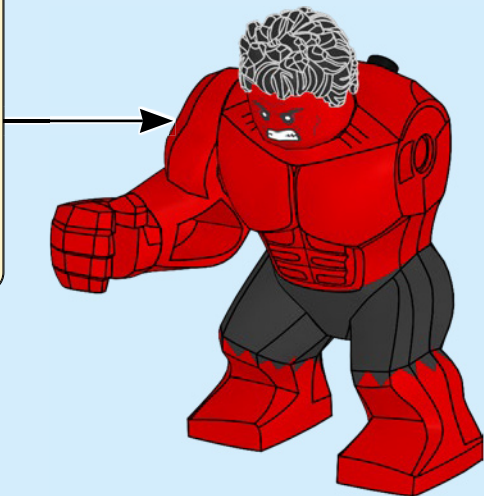
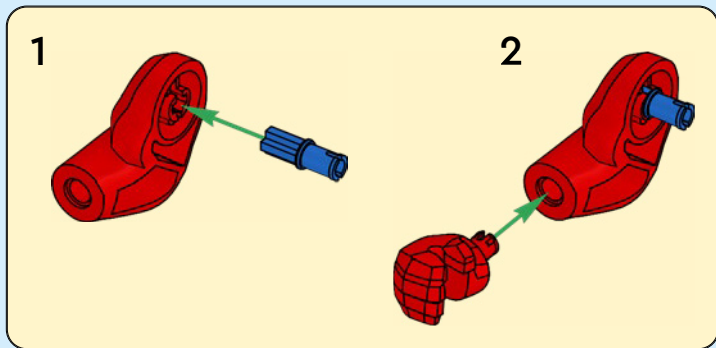

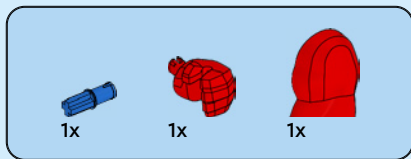

3

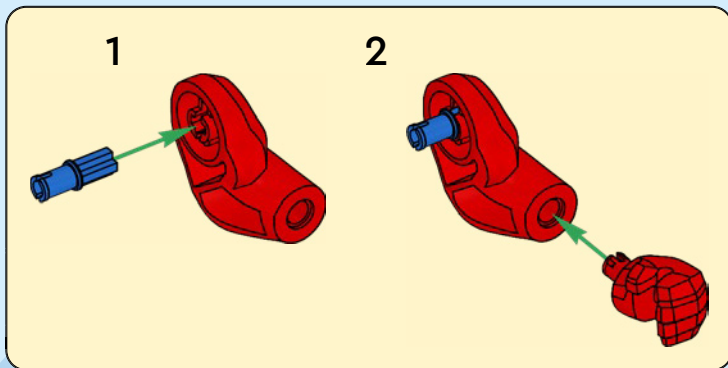
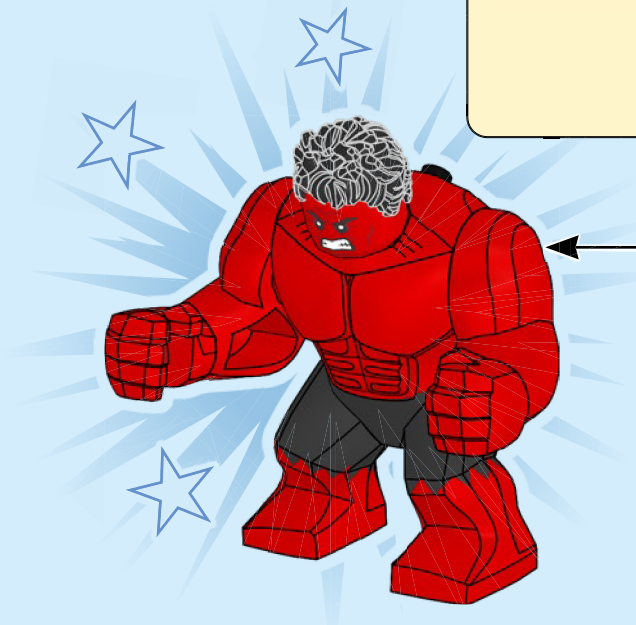

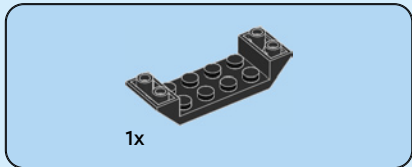
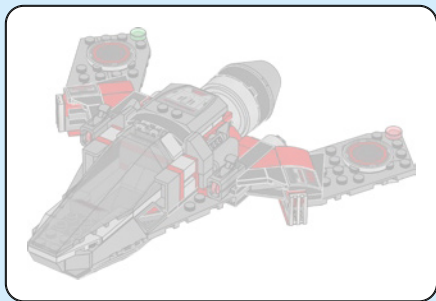

1

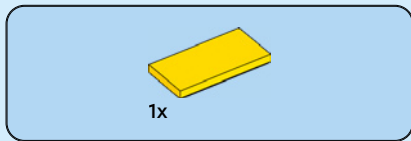
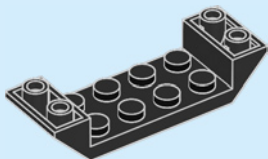

2

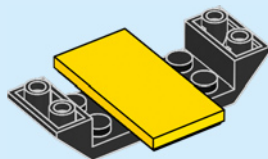

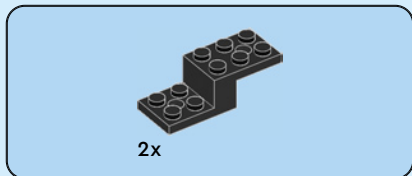

3

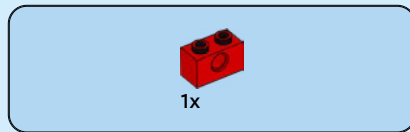
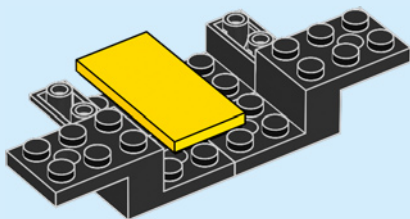

4

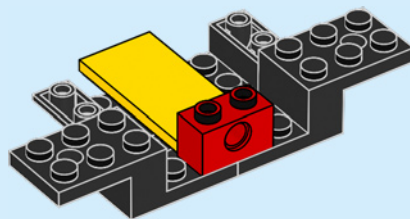

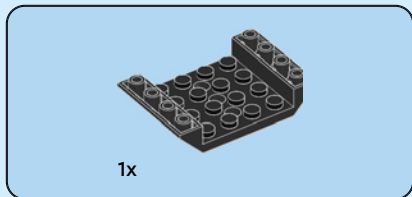

5

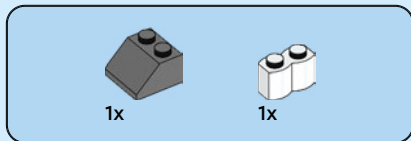
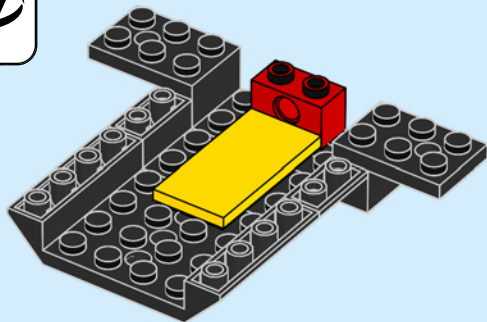

6

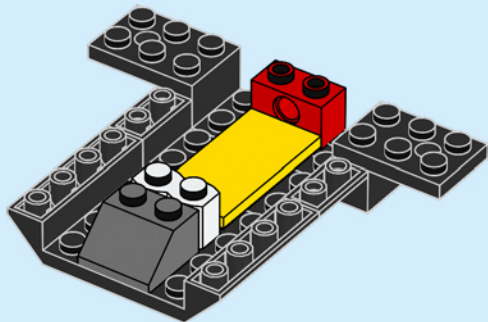



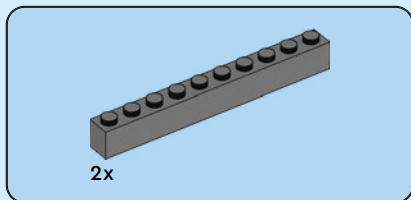

7

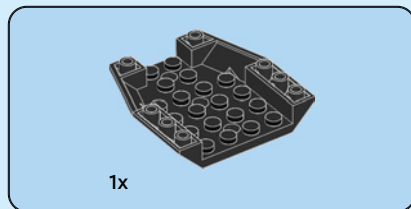
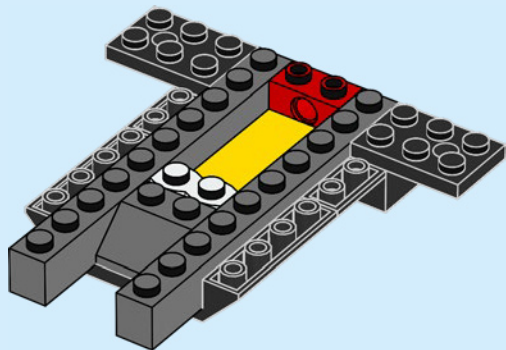

8

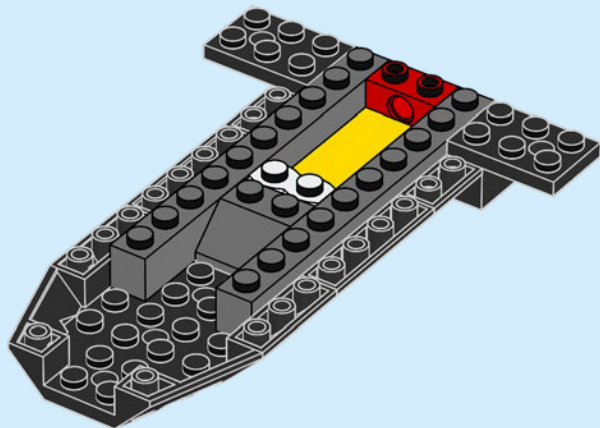

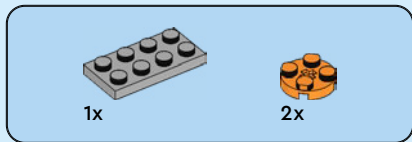

9

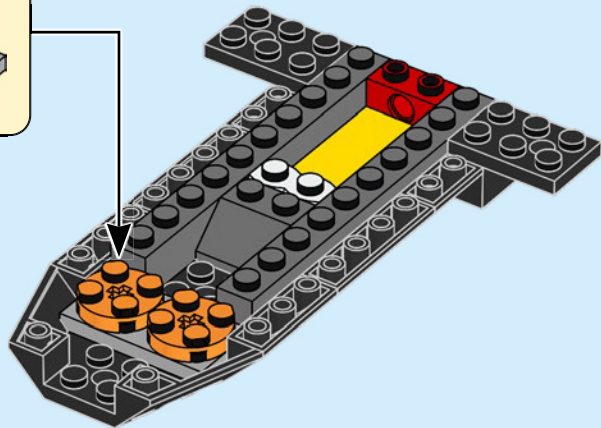
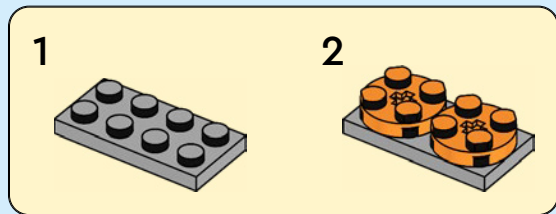

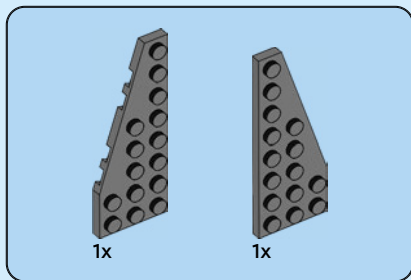

10

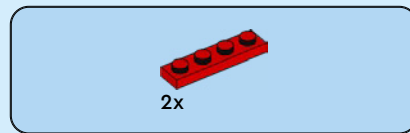
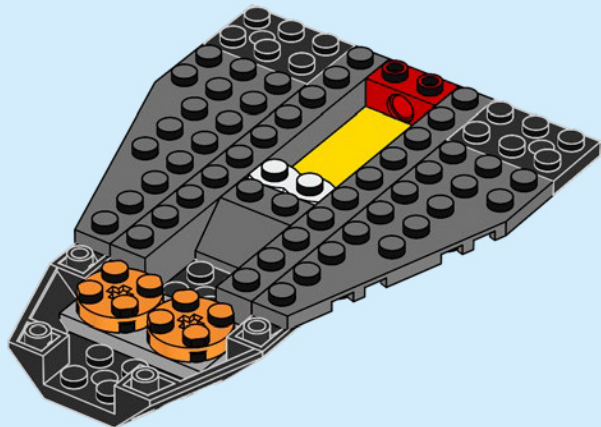

11

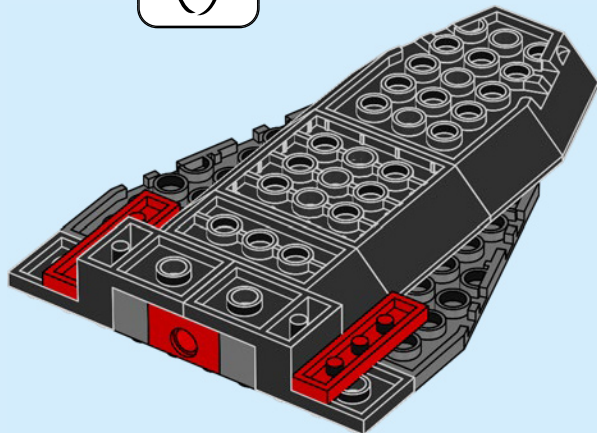

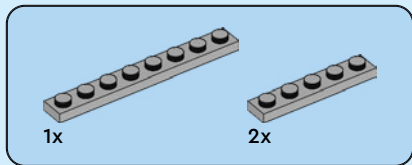

12

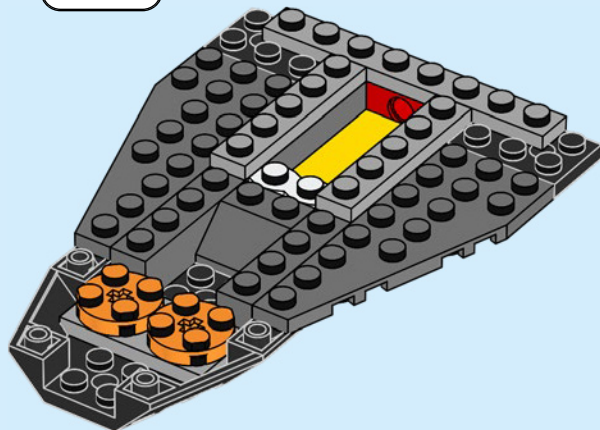
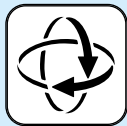



2x

13



2x

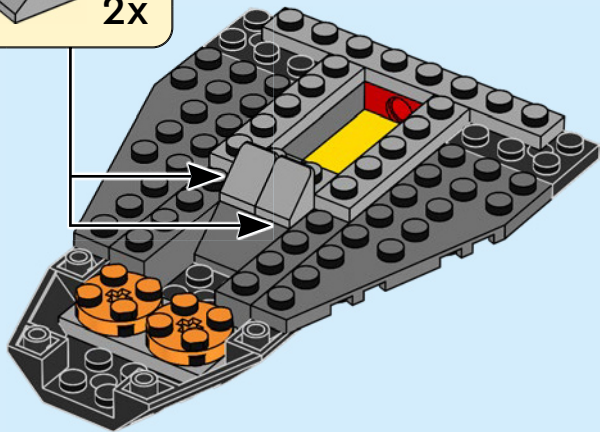

2x



2x

14

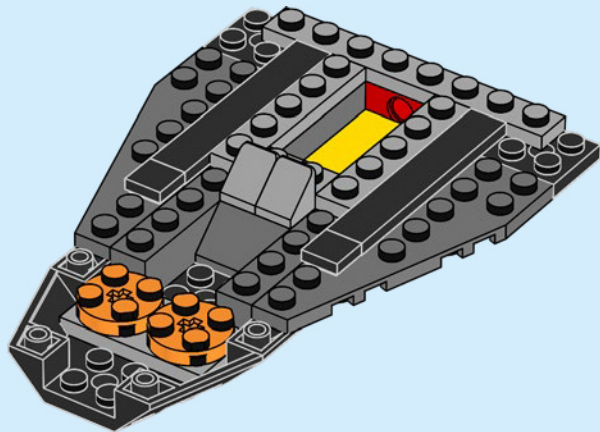



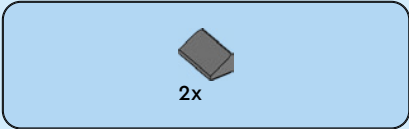

15

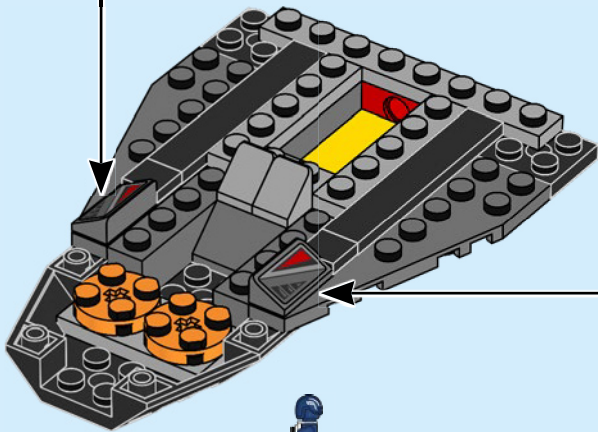
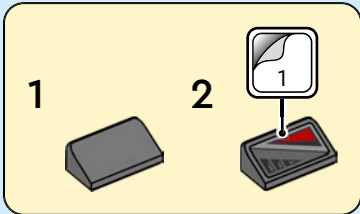
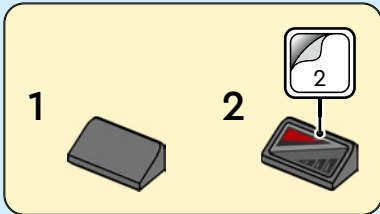

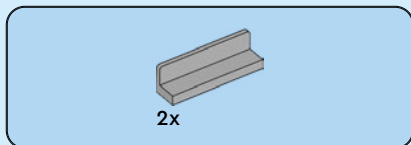

16

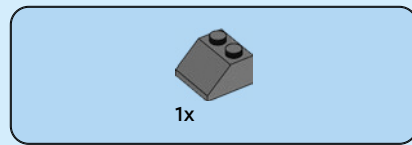
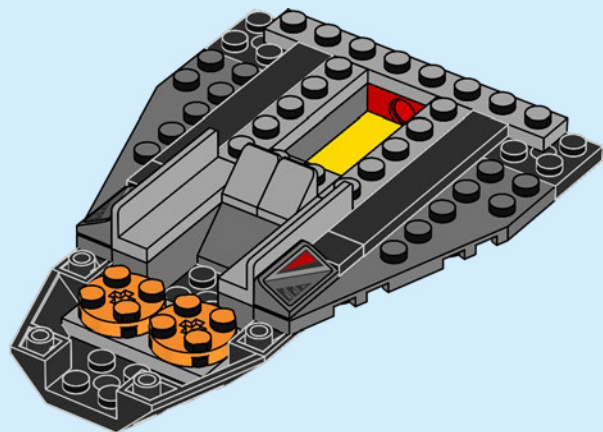

17

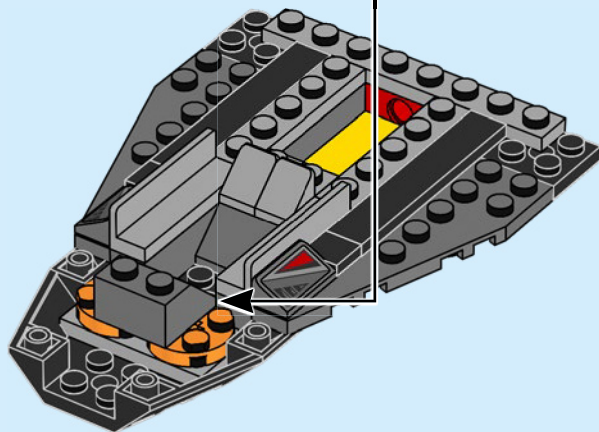
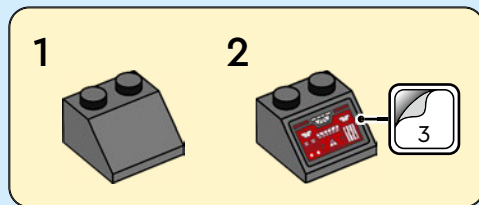

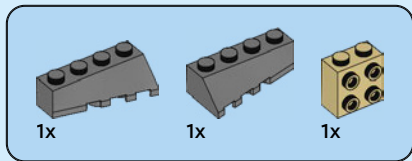

18

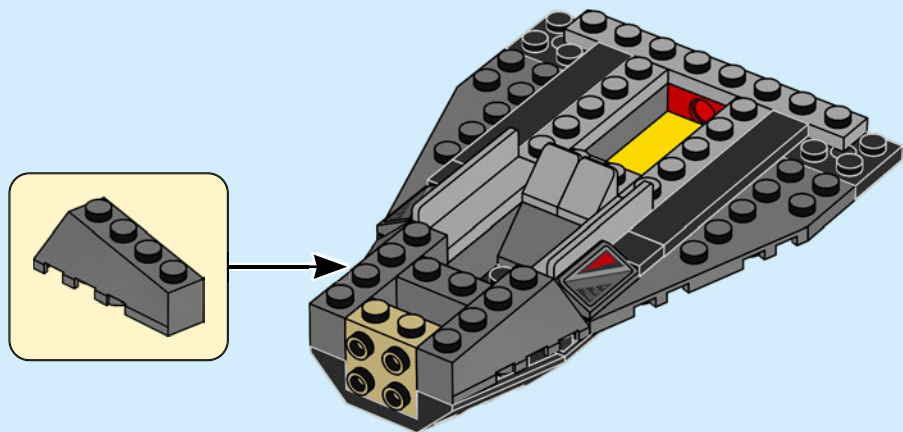

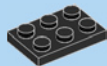

1x

19

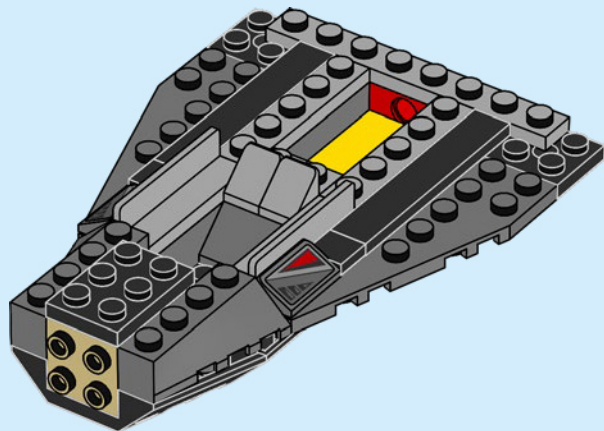

2x

20



2x

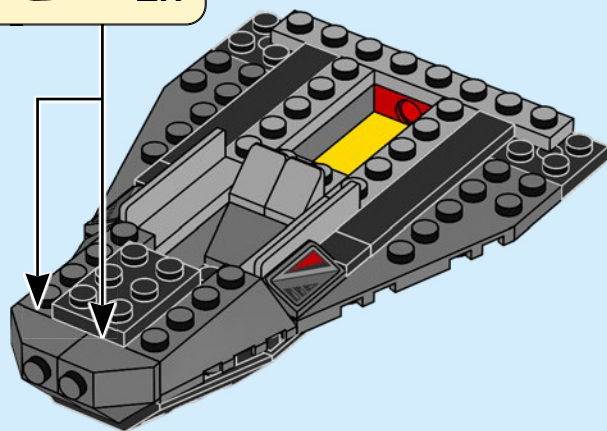



1x

21

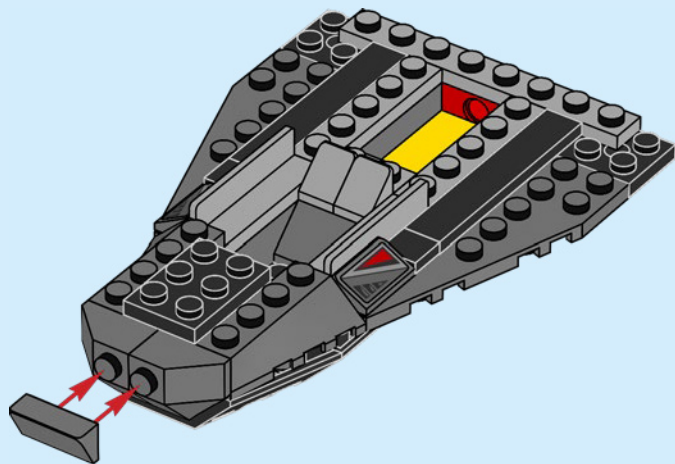



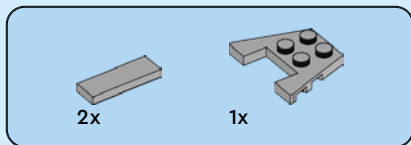

22

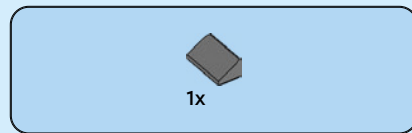
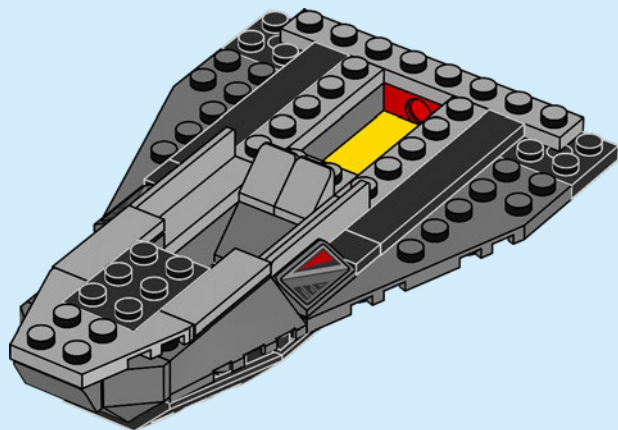

23

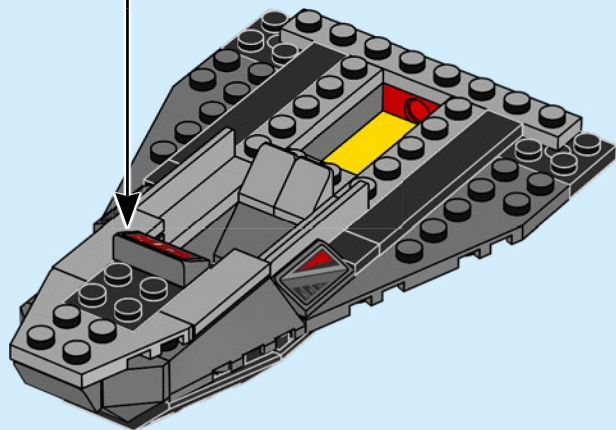
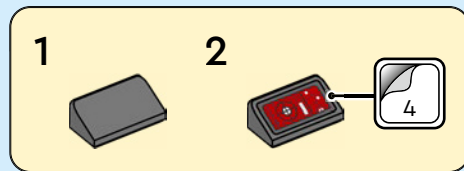

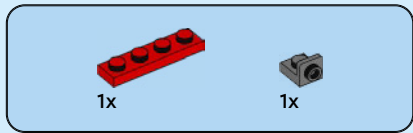
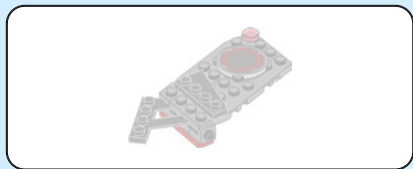

24

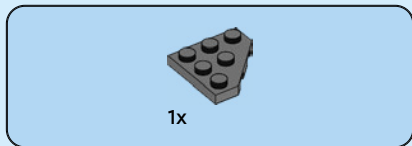
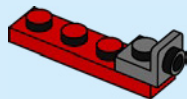

25

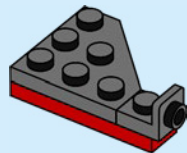

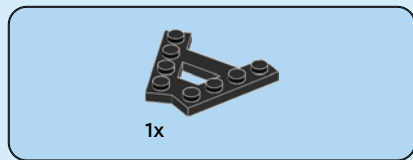

26

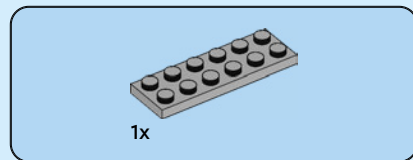
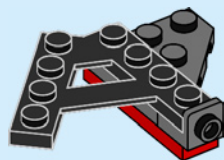

27

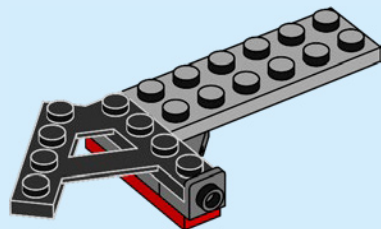

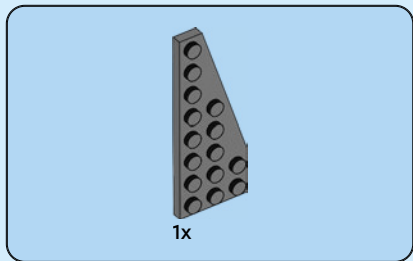

28

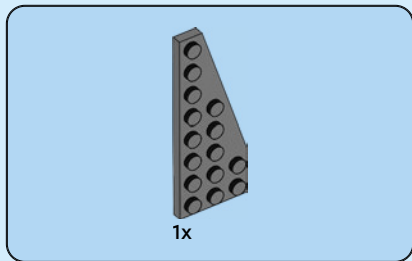
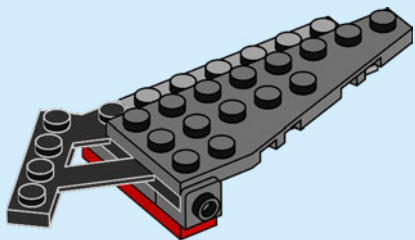

29

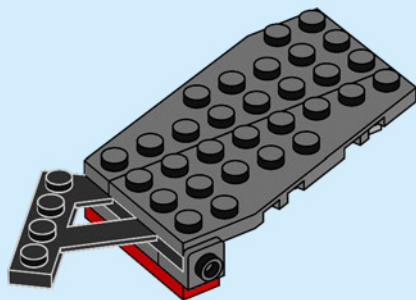

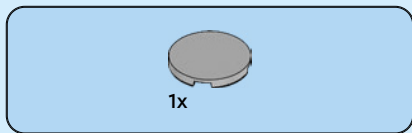

30

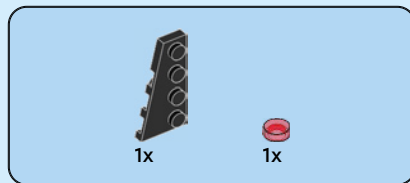
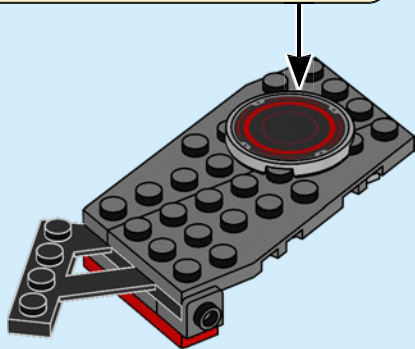
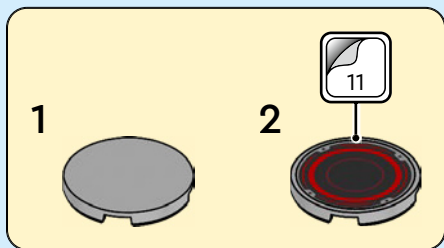

31

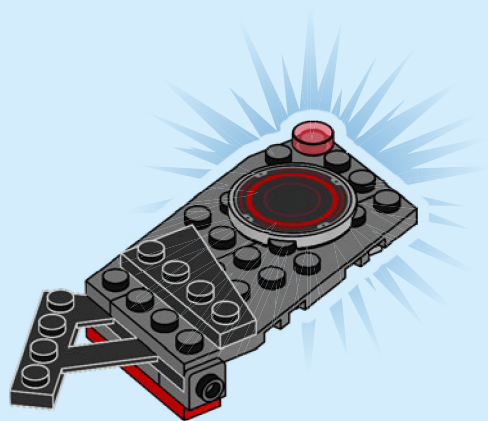

32

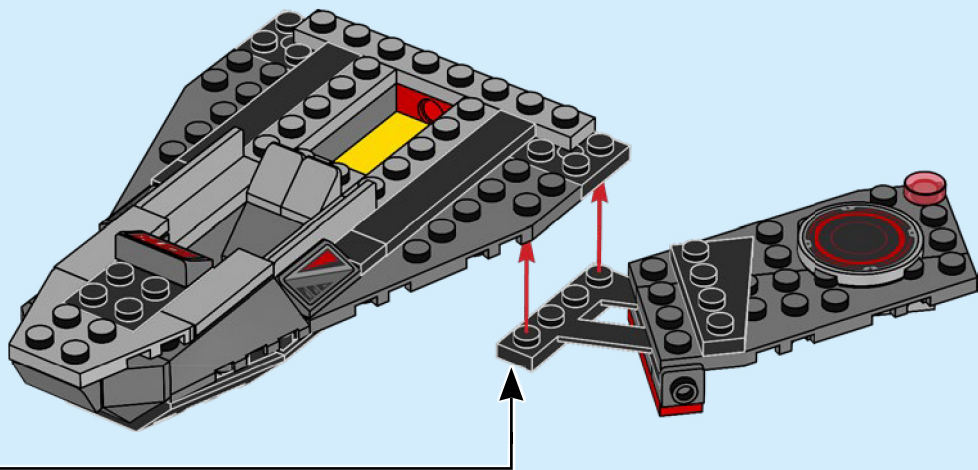

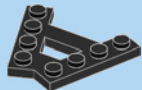

1x

33

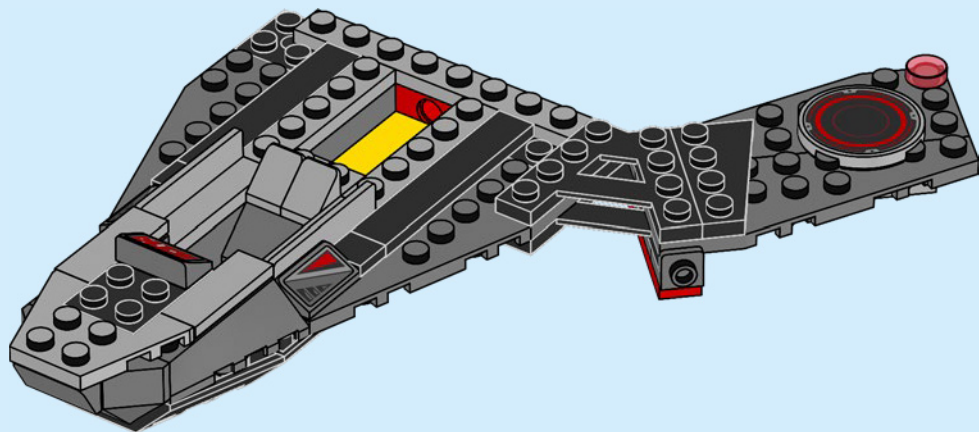



1x

34

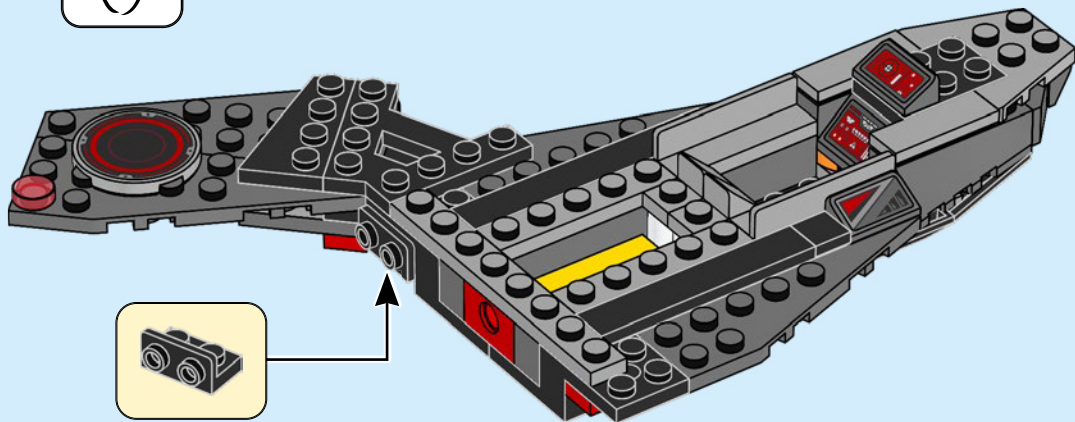





1x



1x

# 35

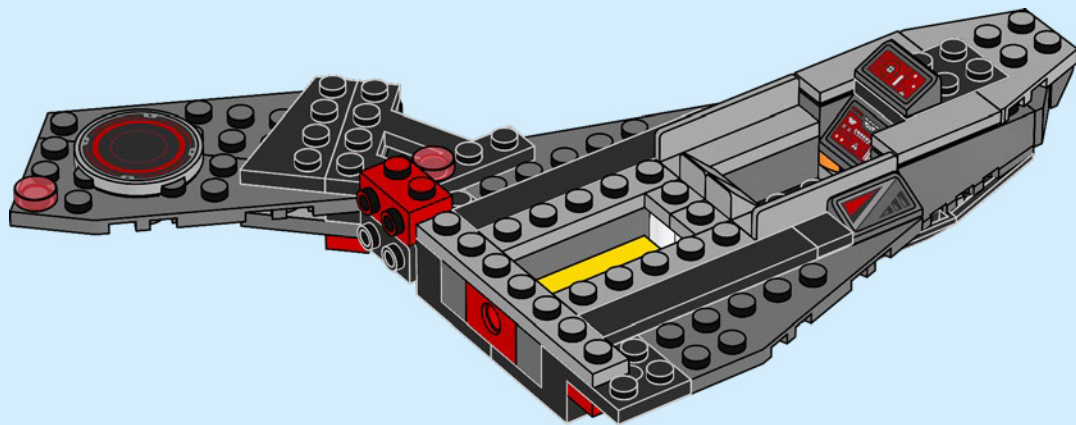



1x



1x

# 36

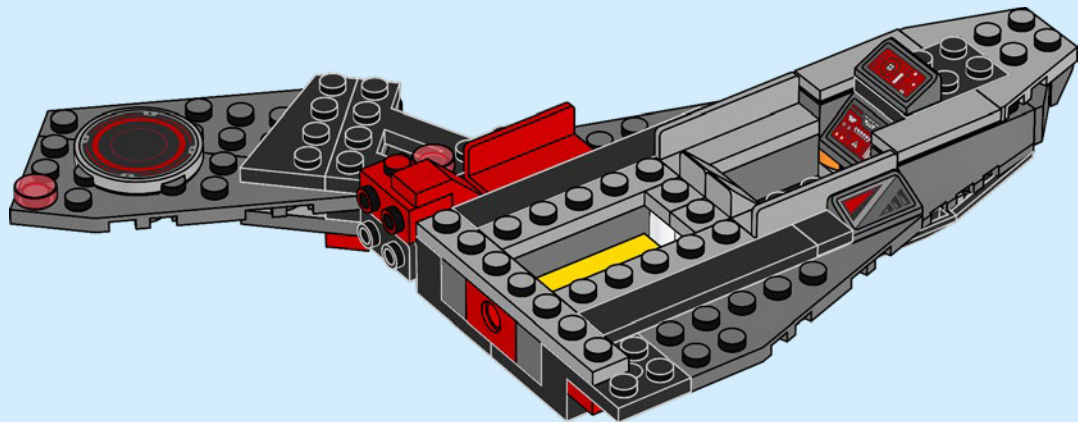



1x



1x

37

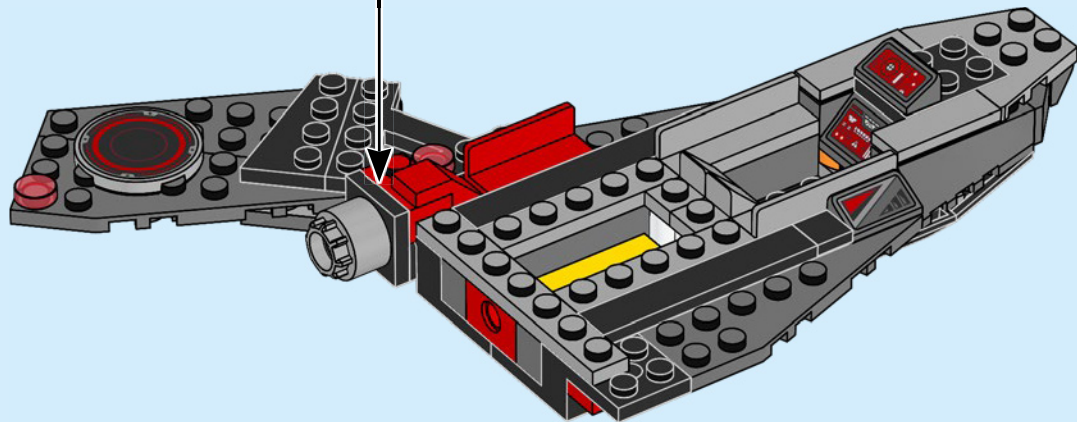
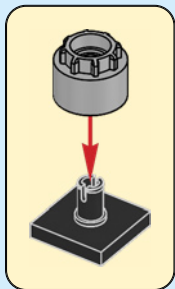

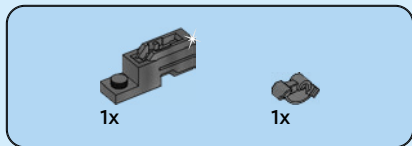

38

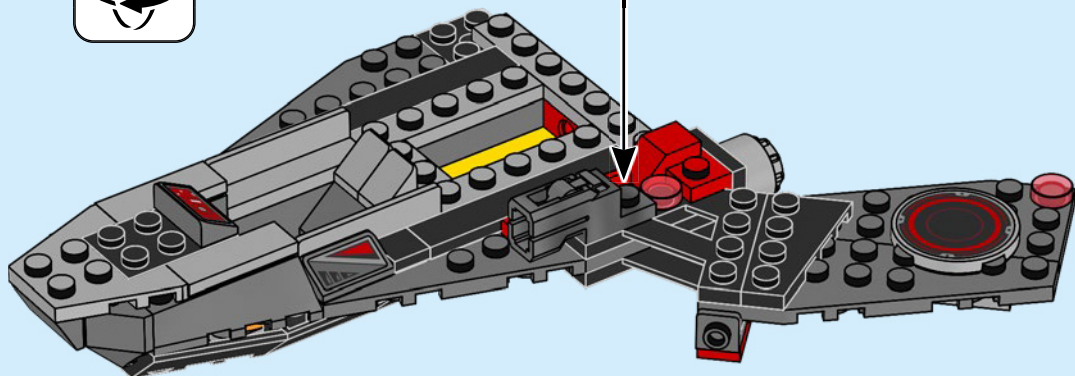
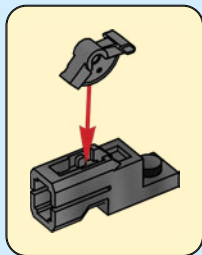
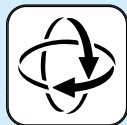



1x



1x

39

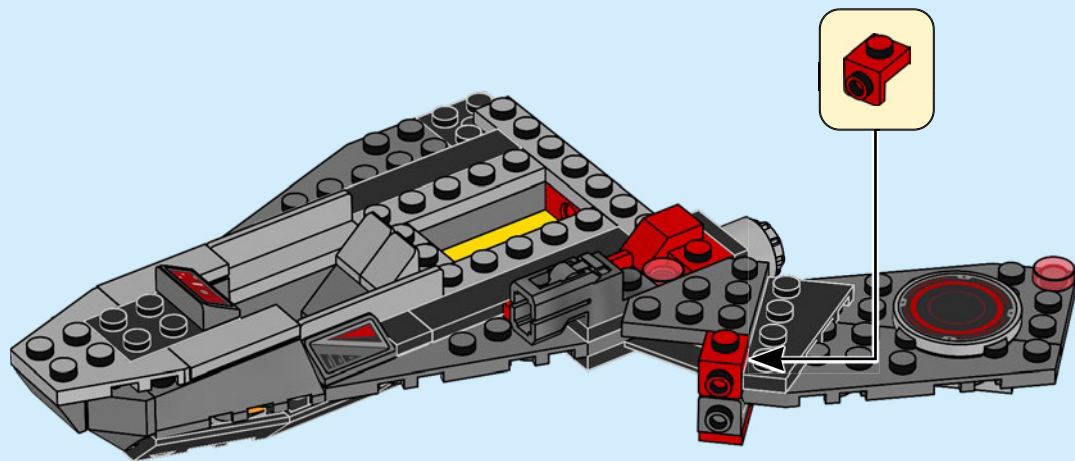

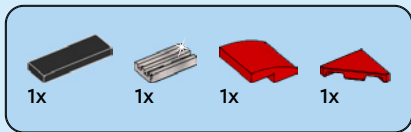

40

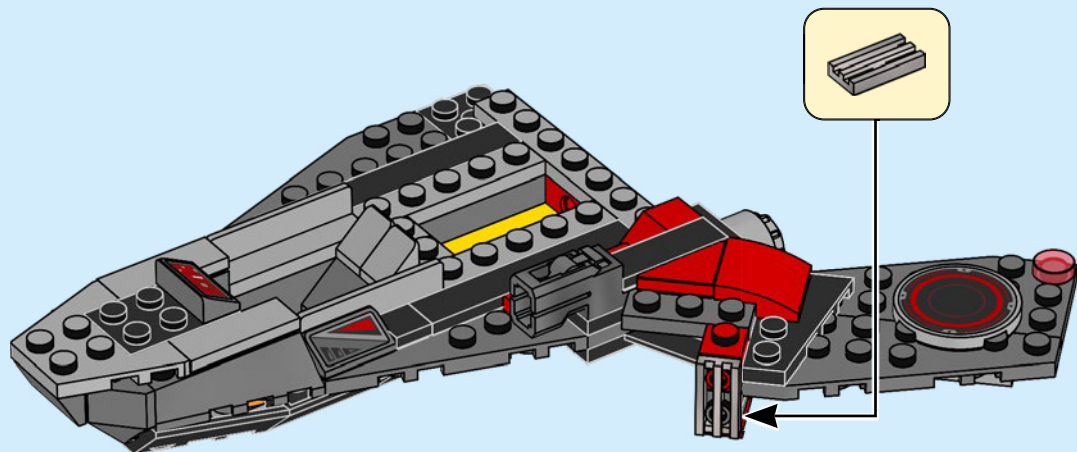

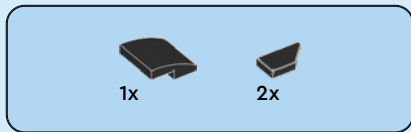

41

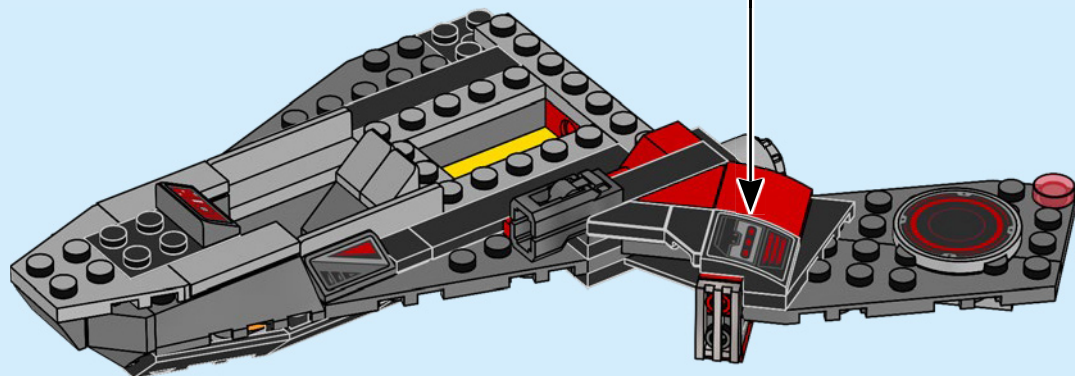
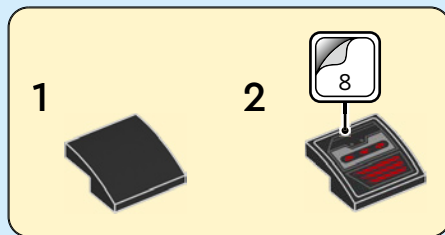

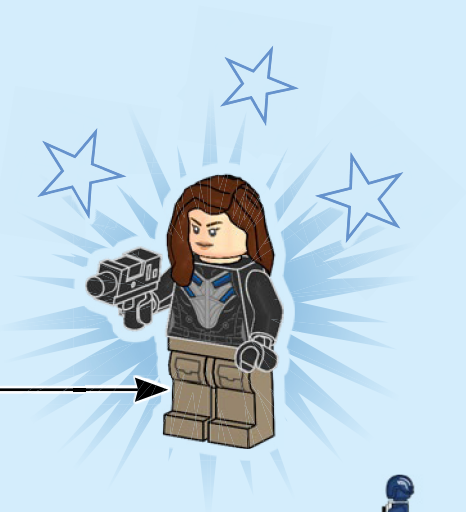
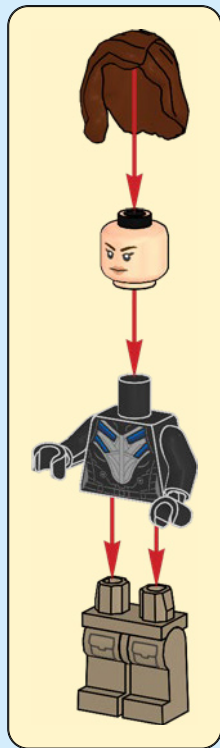



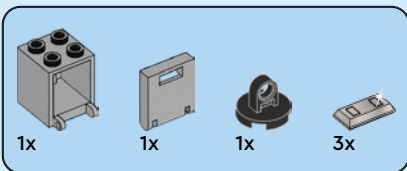

1

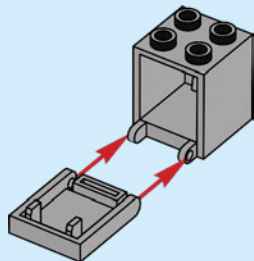

2

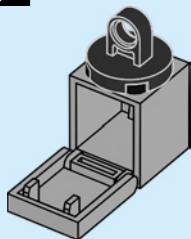

3

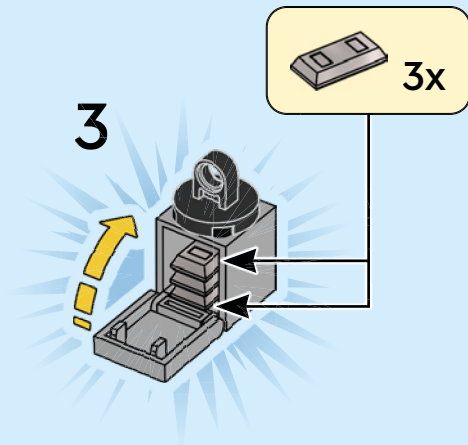

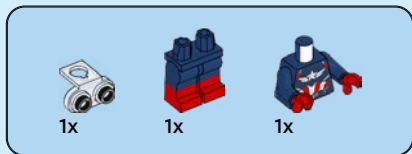

1

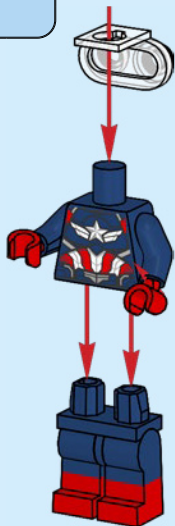

2



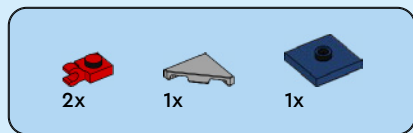

3

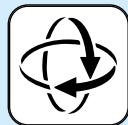
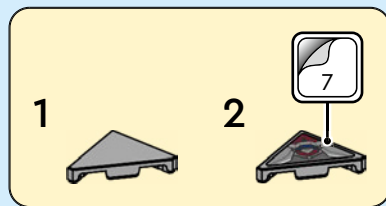
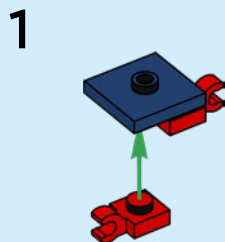

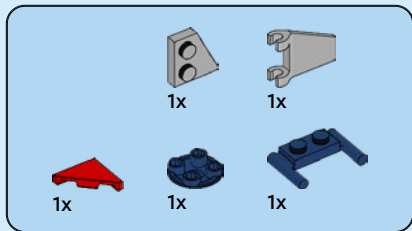

4

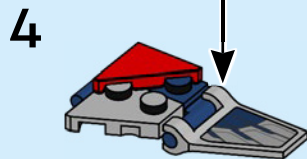
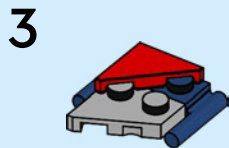
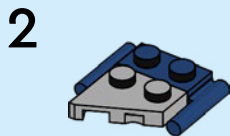
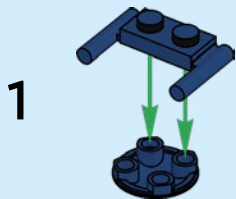
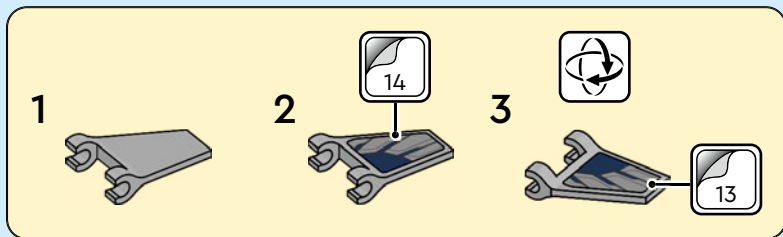

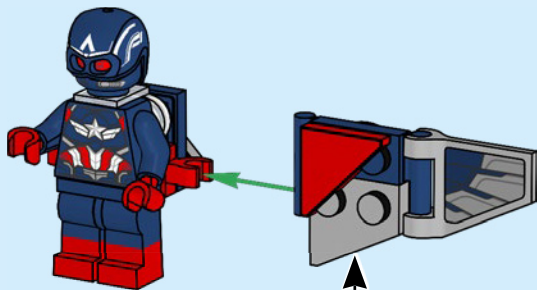
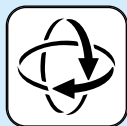

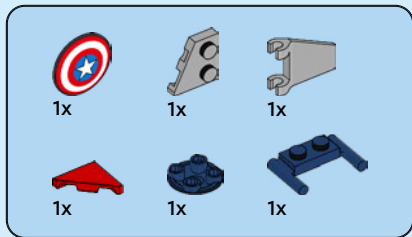

5

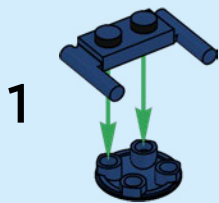
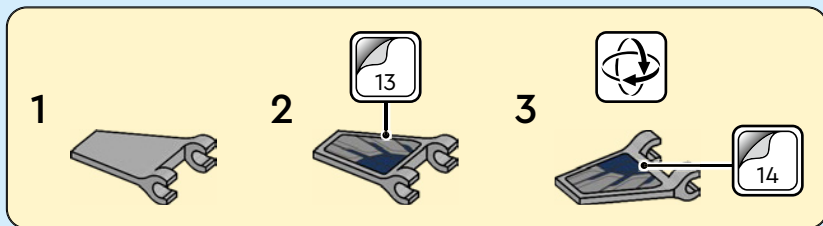

2

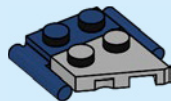

3



4

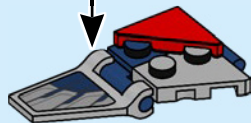



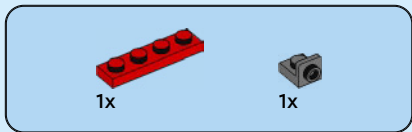
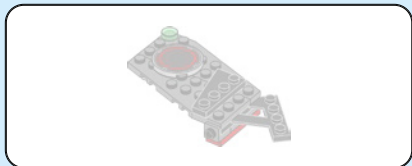

42

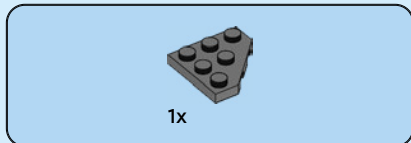
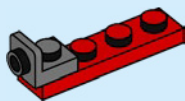

43

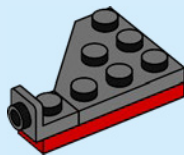



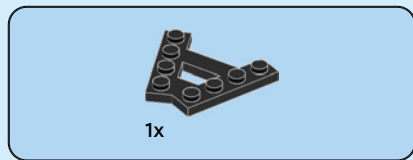

44

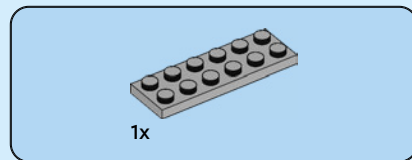
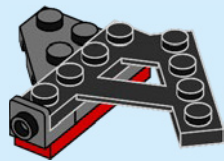

45

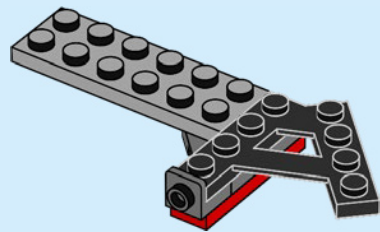

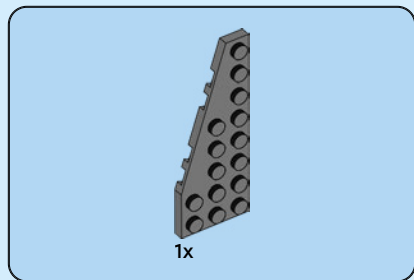

46

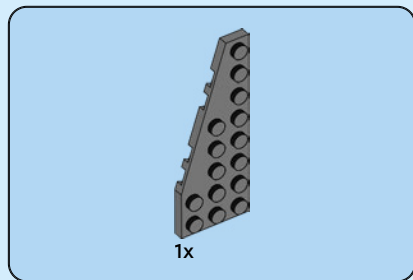
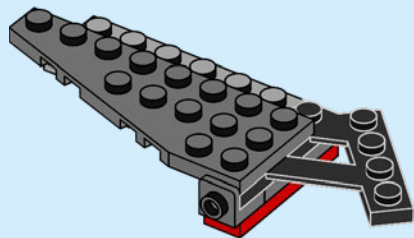

47

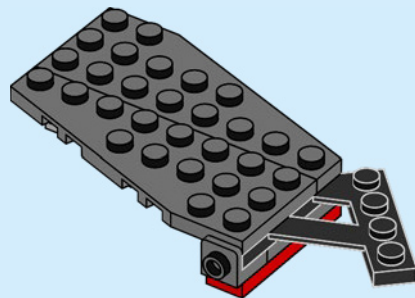

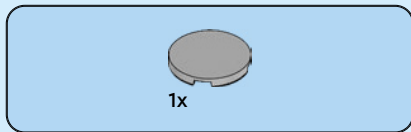

48

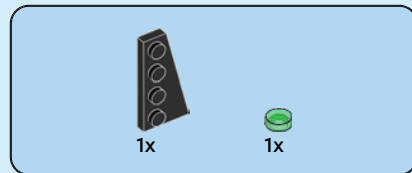
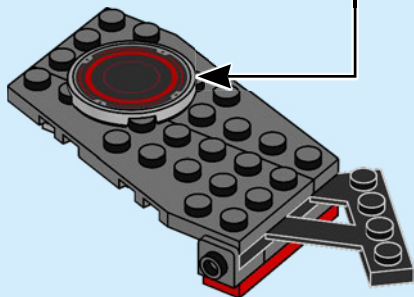
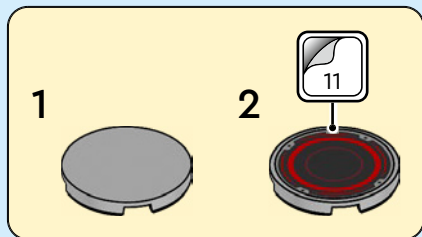

49

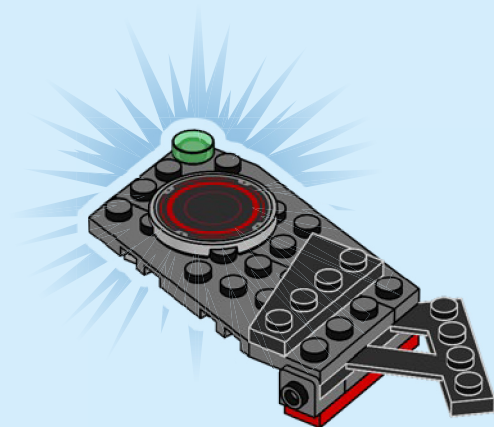

50

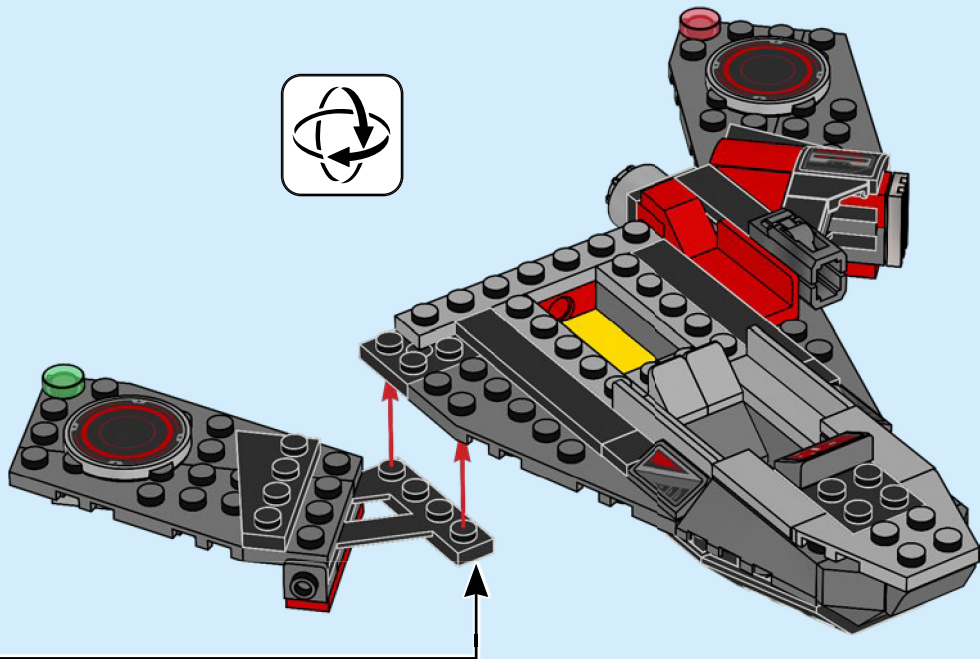

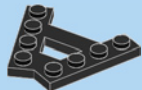

1x

51

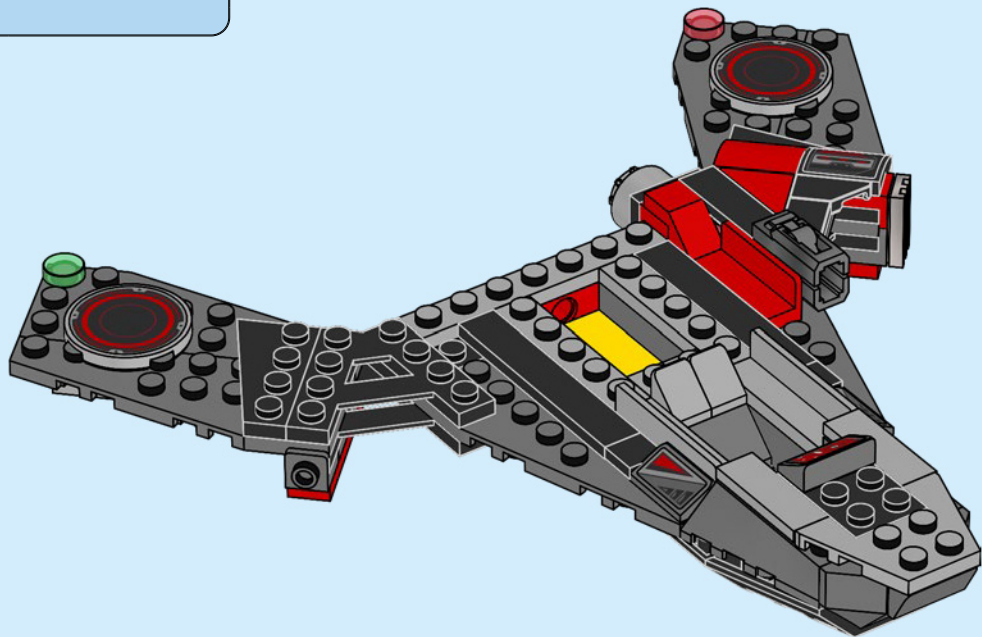



1x

52

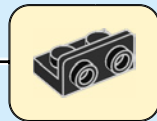
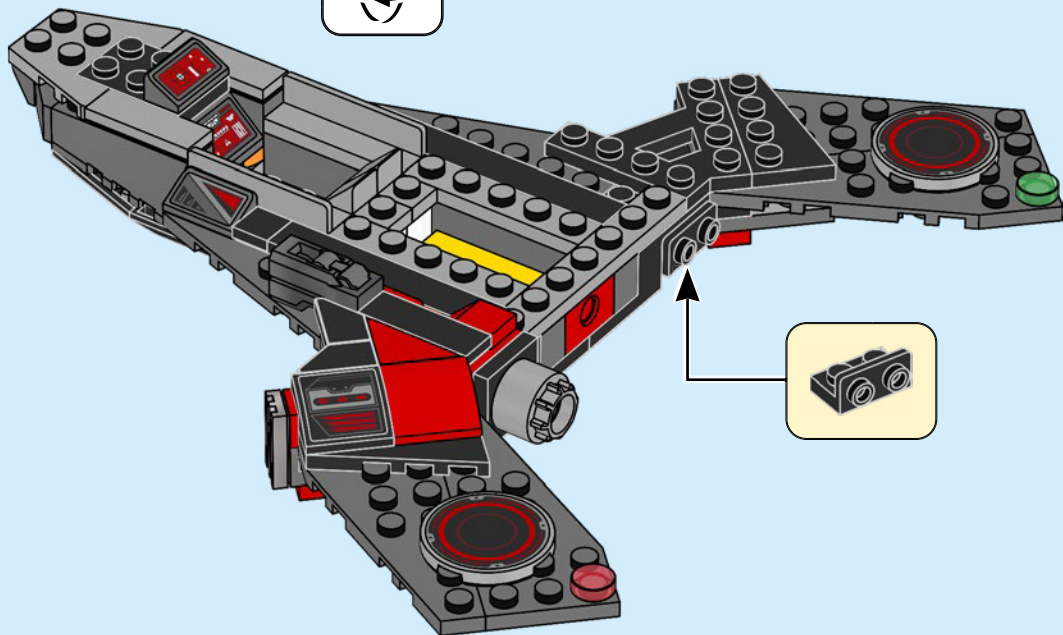
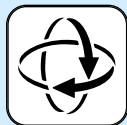



1x



1x

# 53

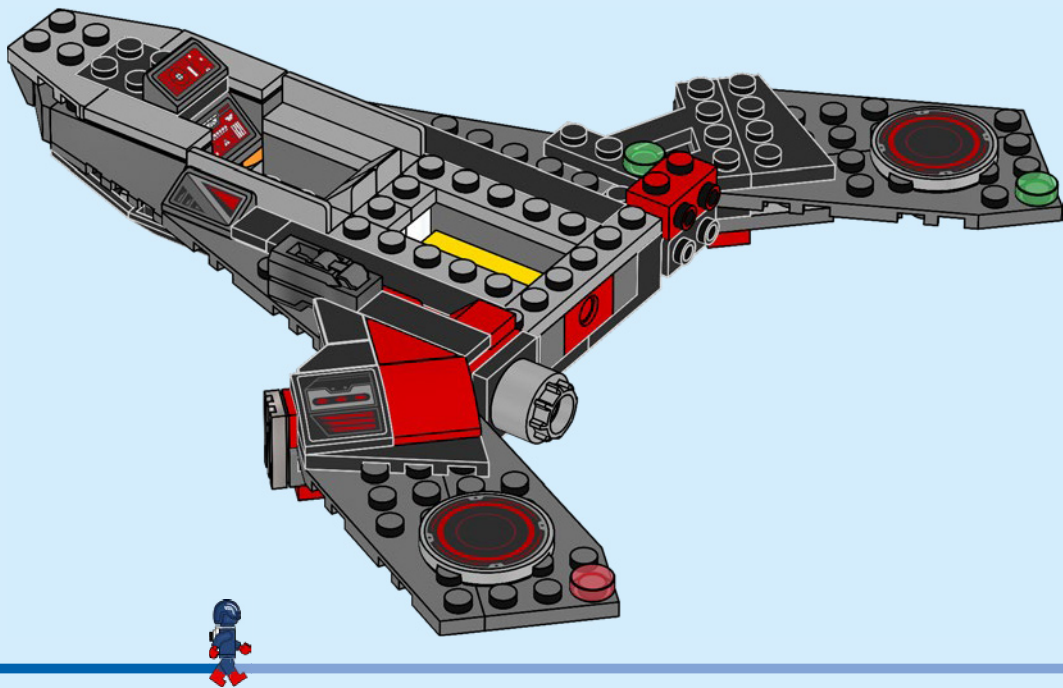



1x



1x

# 54

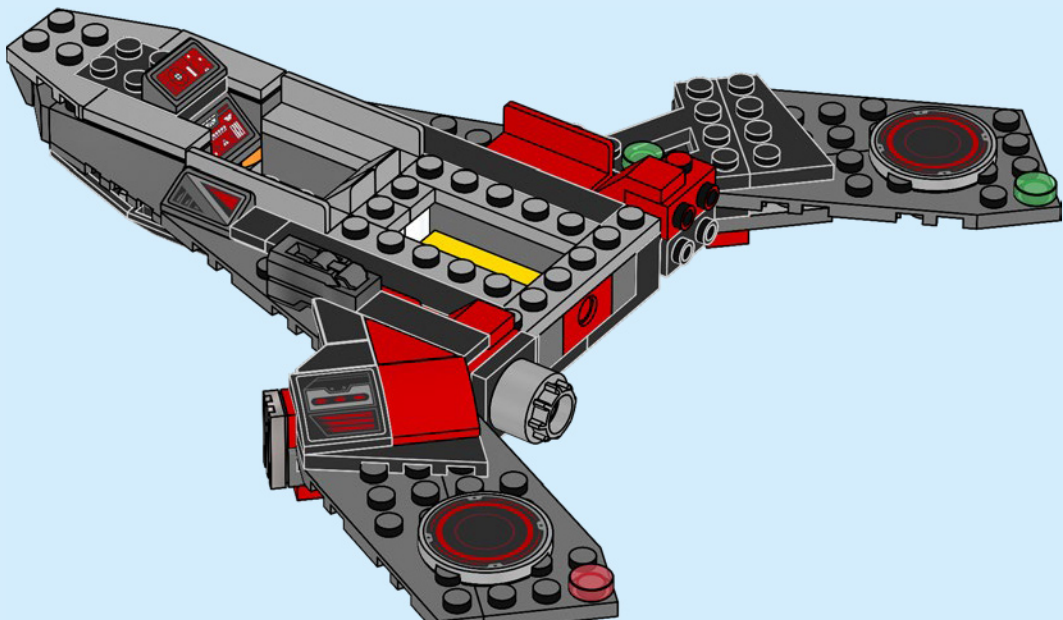





1x



1x

55

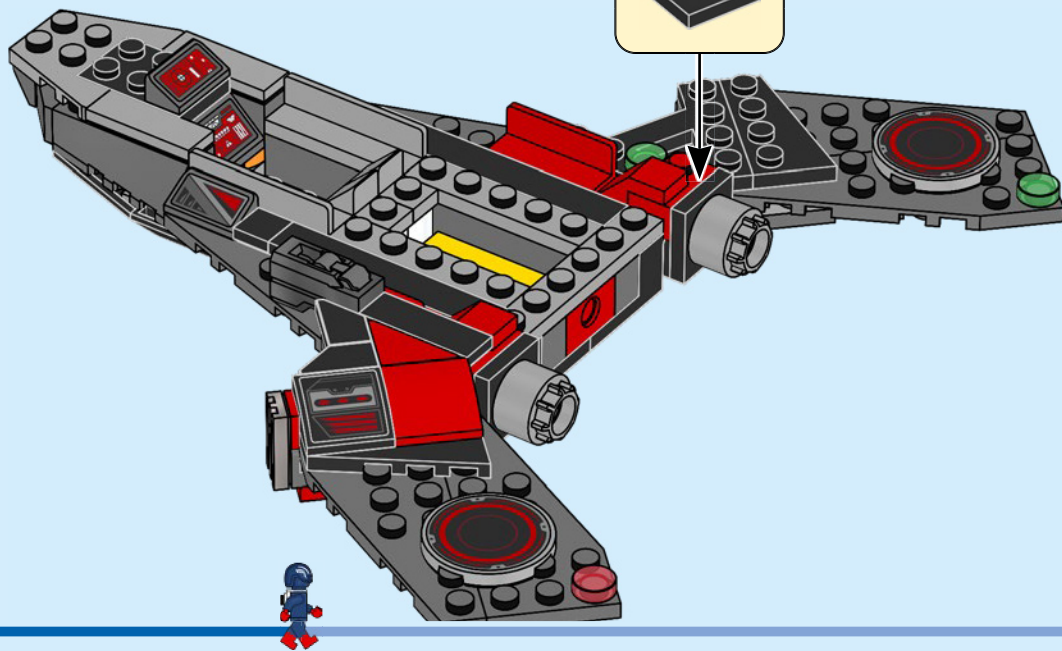
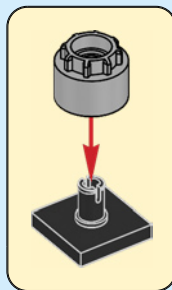

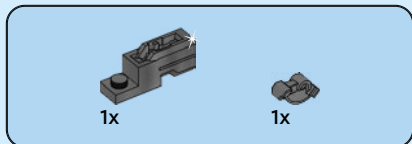

56

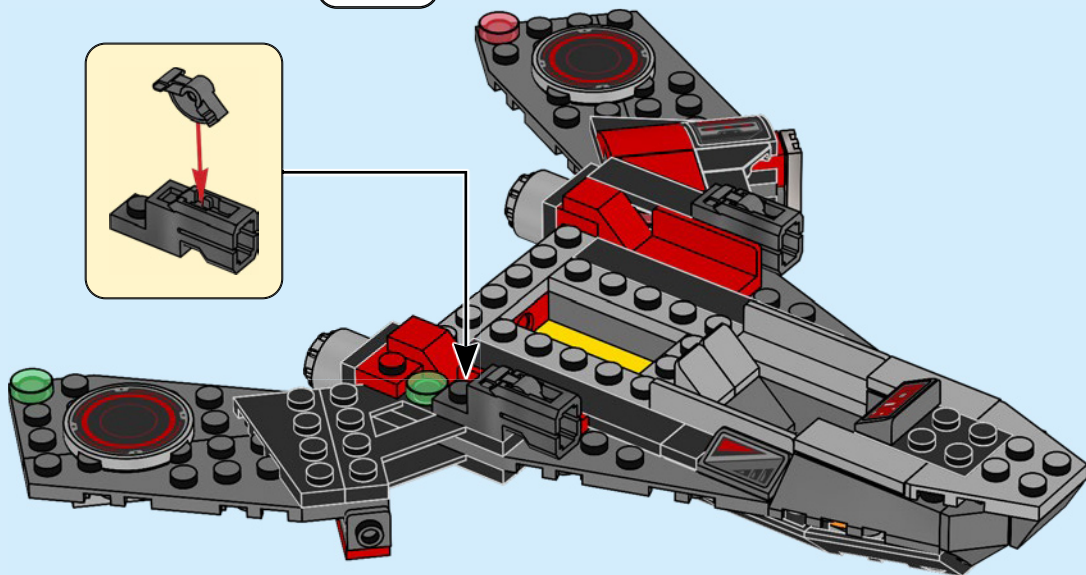
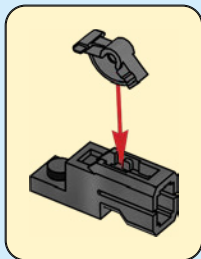



1x



1x

57

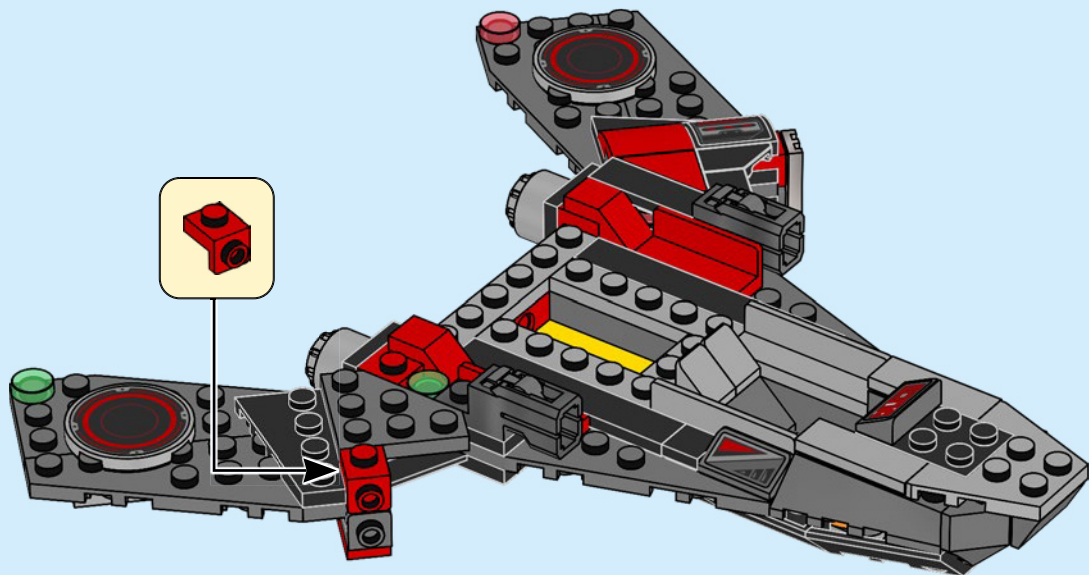



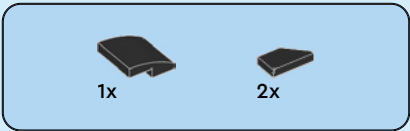

# 59

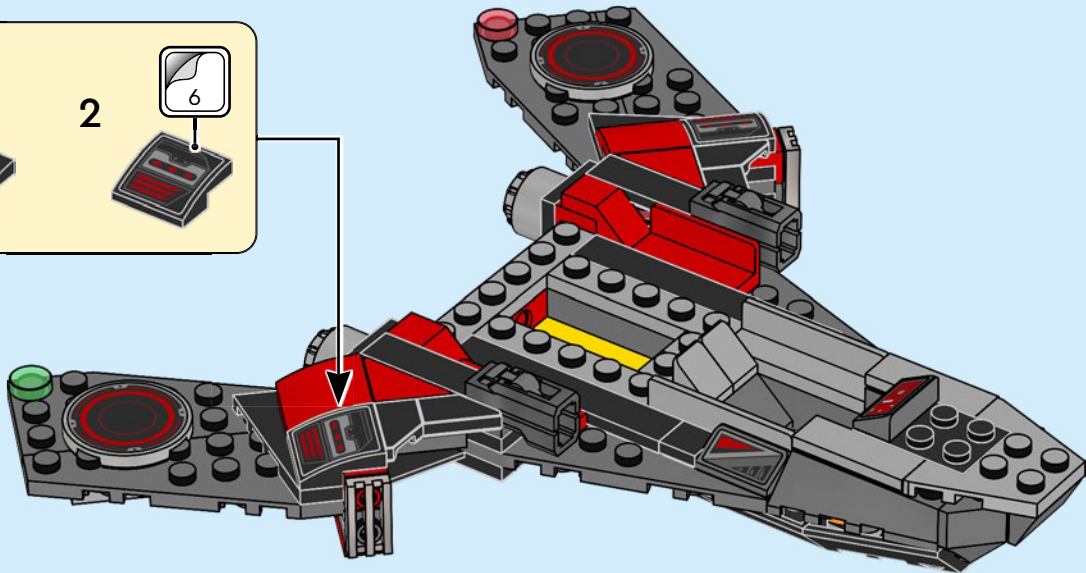
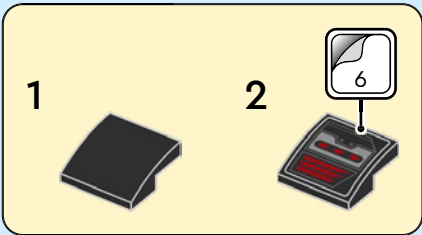

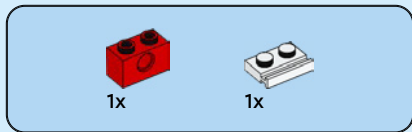

60

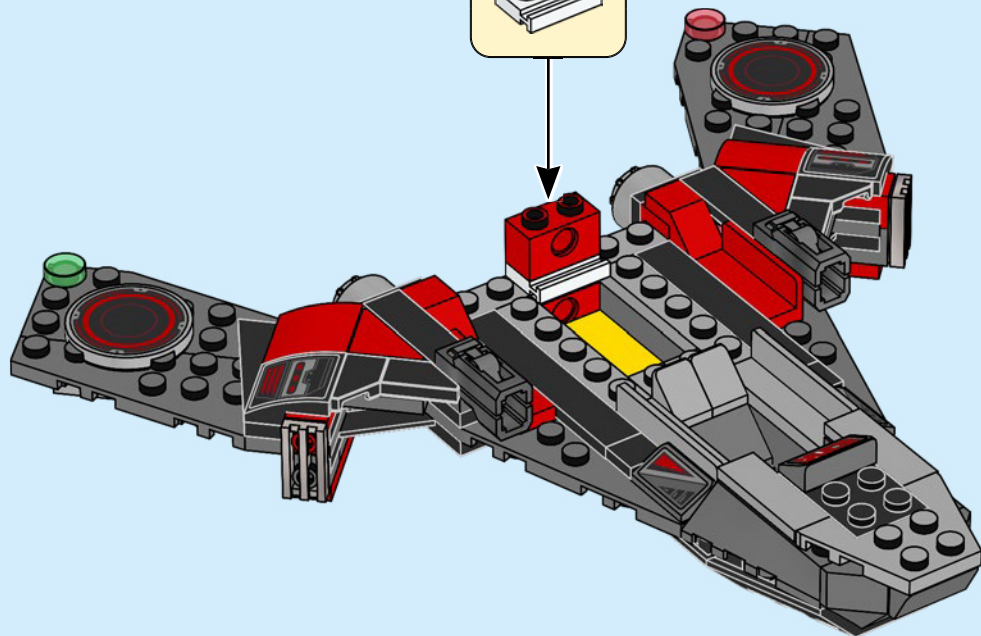
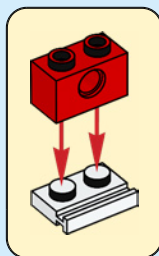

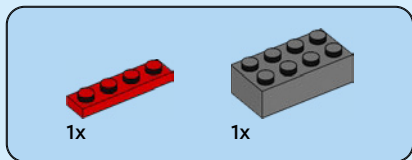
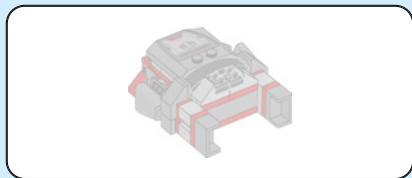

61

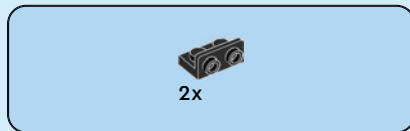
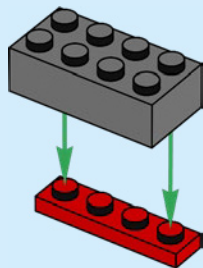

62

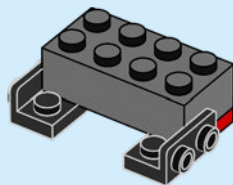



2x

63

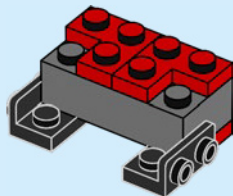

2x

64

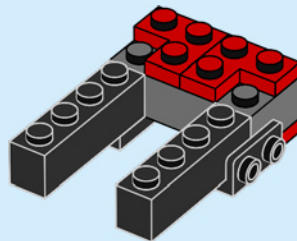





2x

65

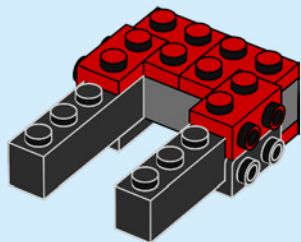

2x

66

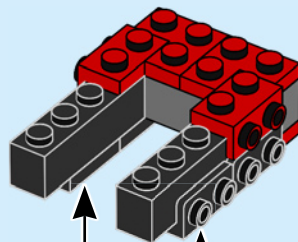

2x





2x

67

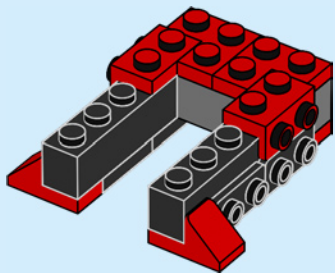

1x



2x

68

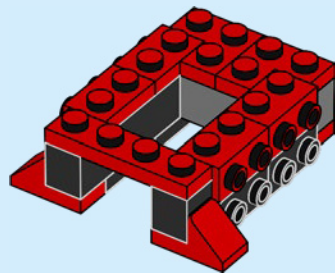



2x



2x

69

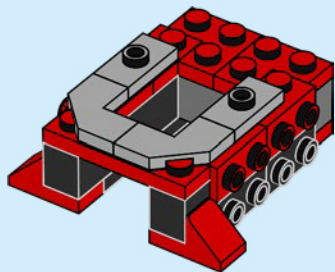

2x

70

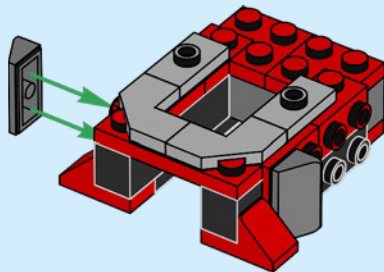



2x

# 71

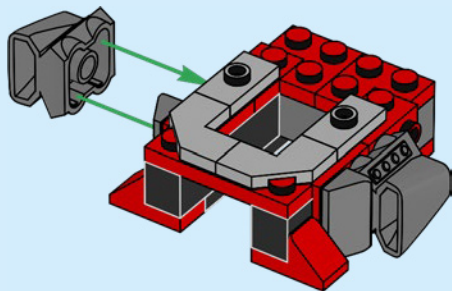

1x



2x

# 72

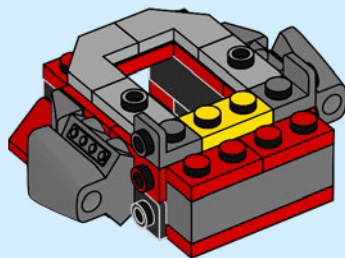



2x

73

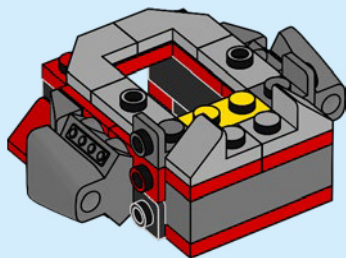

2x

74

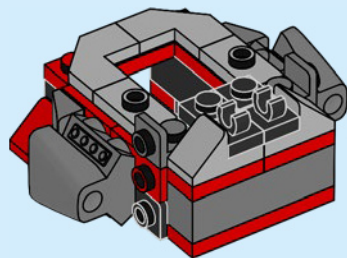



75

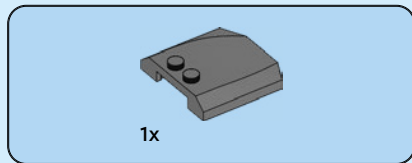
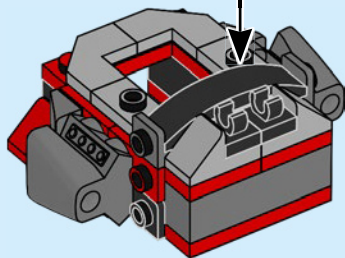

76

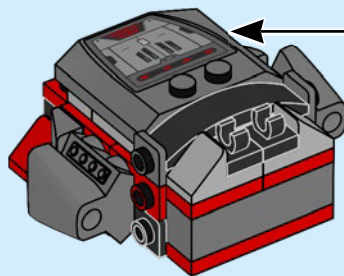
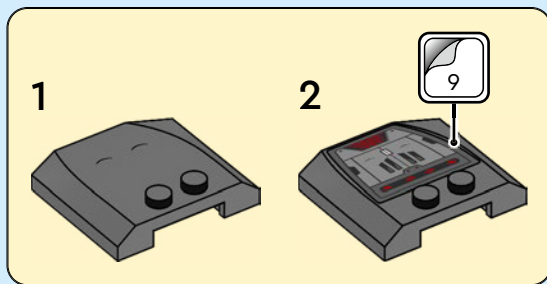



2x



2x

# 77

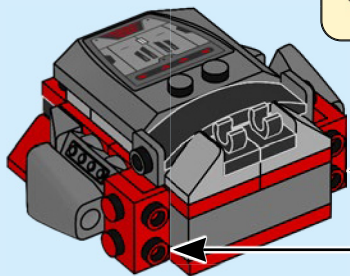
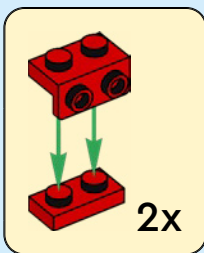

2x



2x

# 78

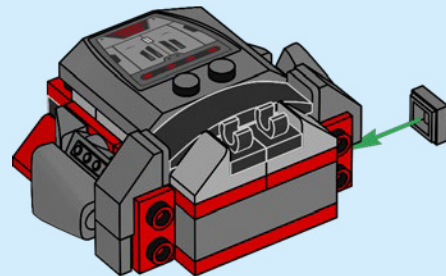

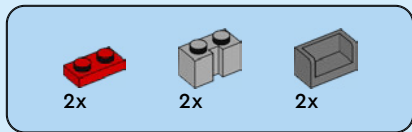

79

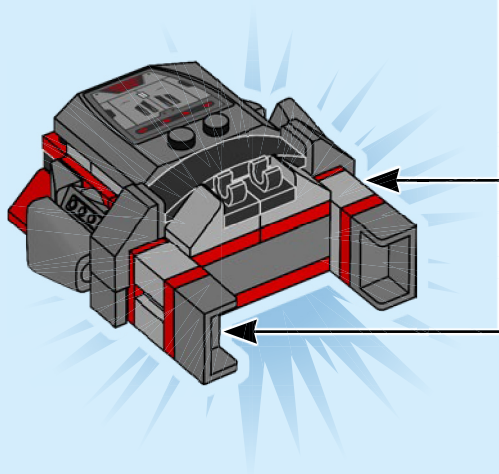
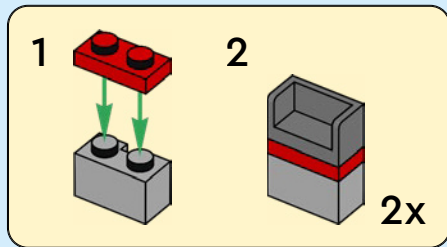



80

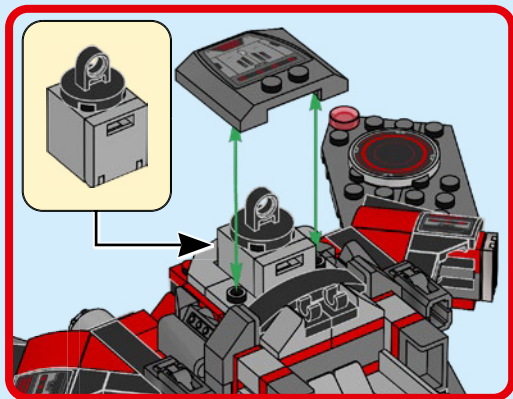
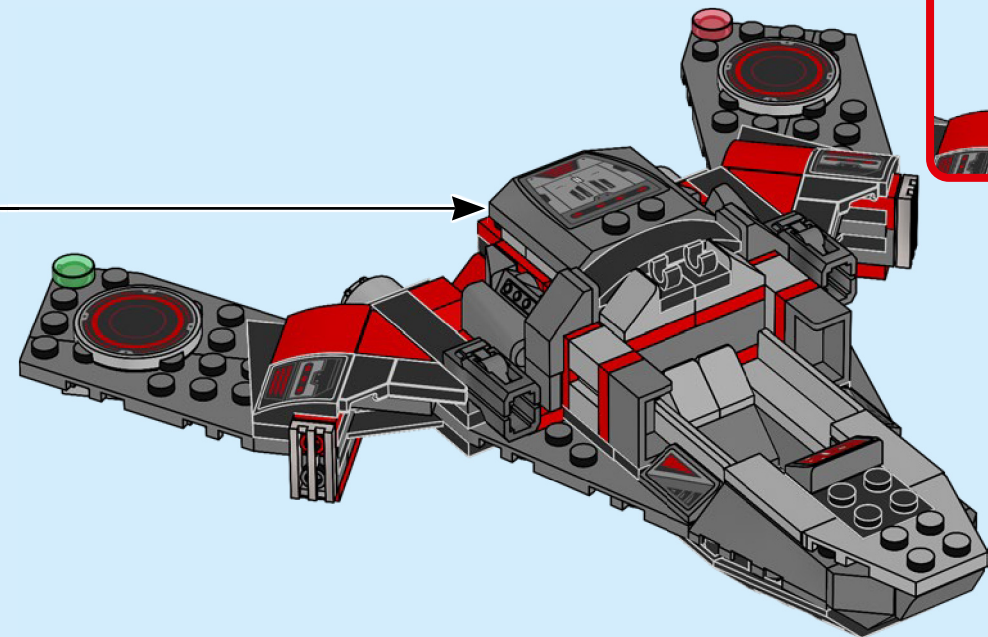

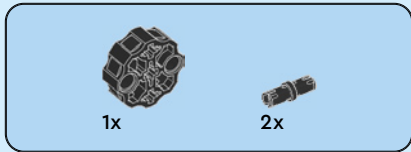

81

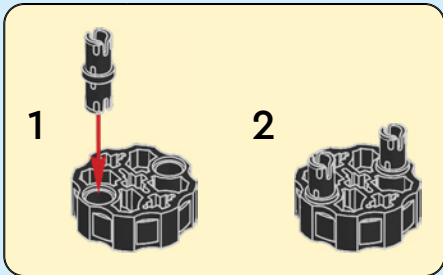
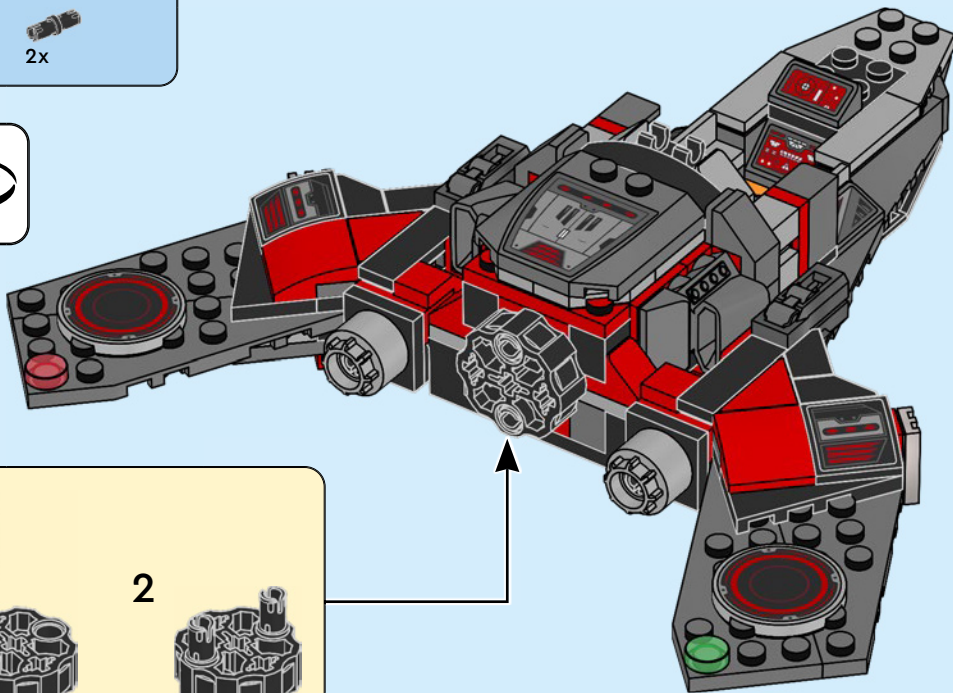

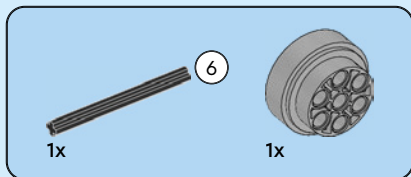

82

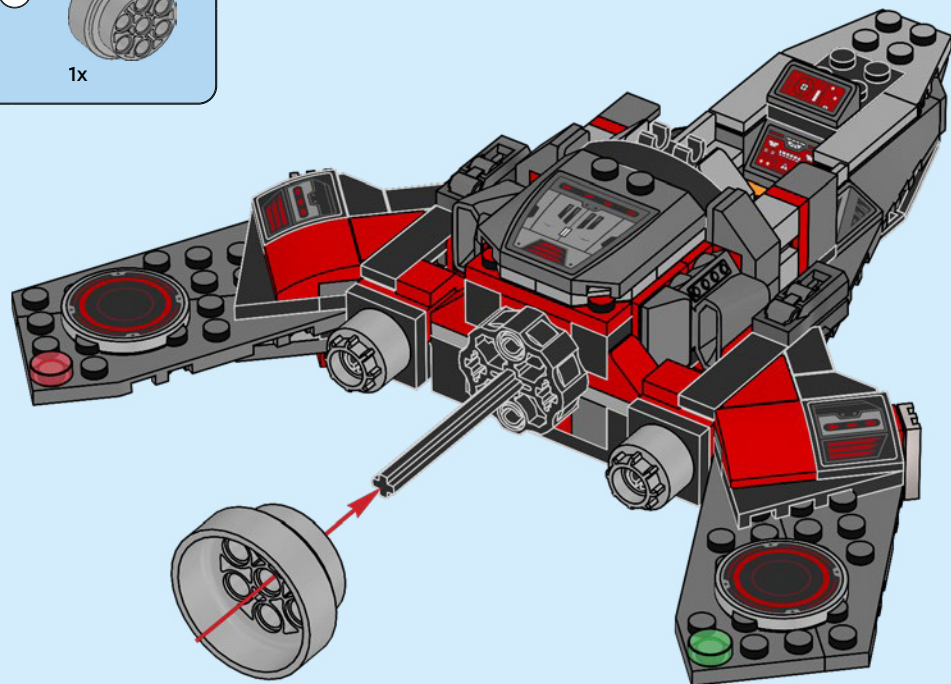

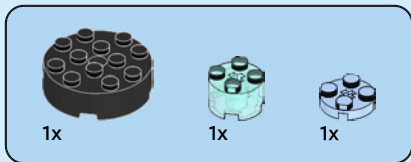

83

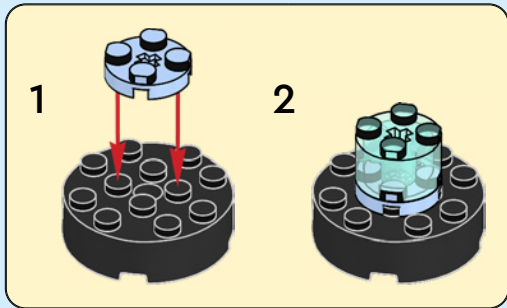
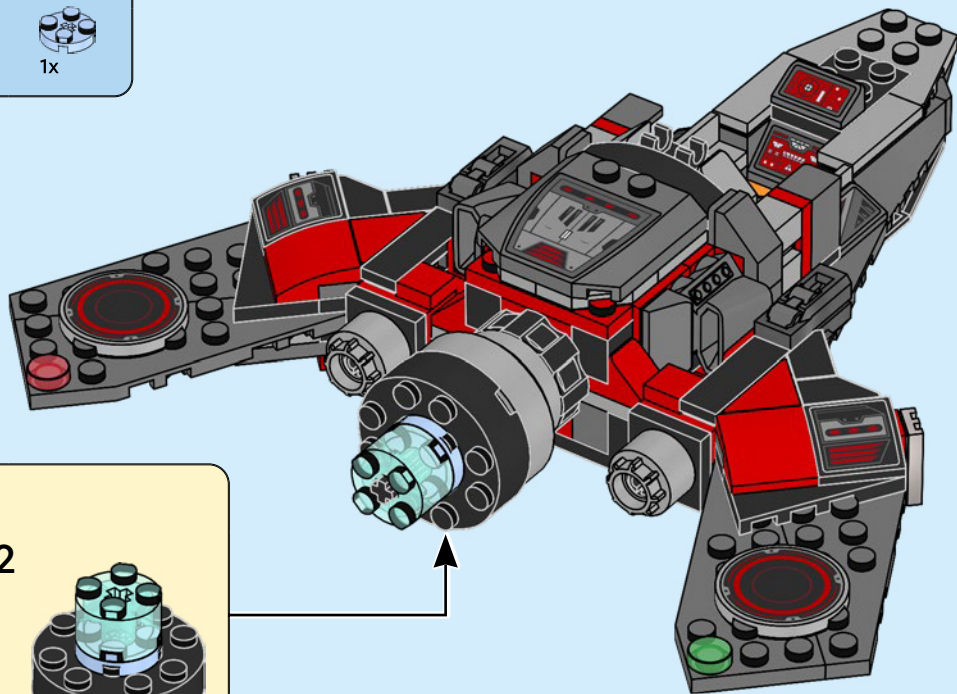

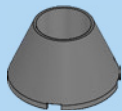

1x

84

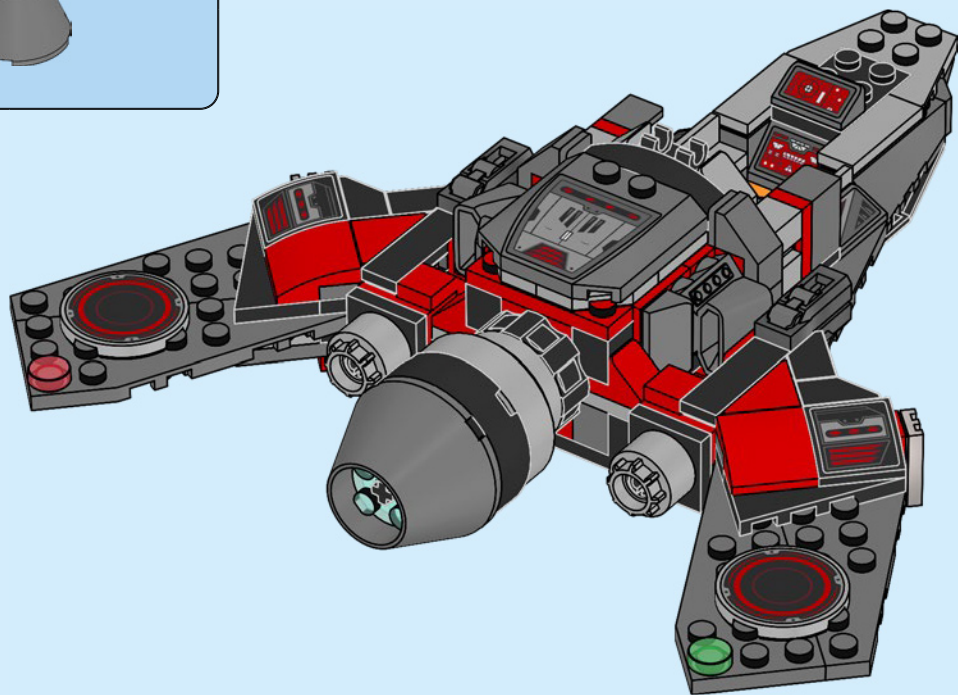

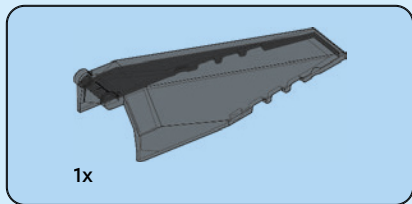

85

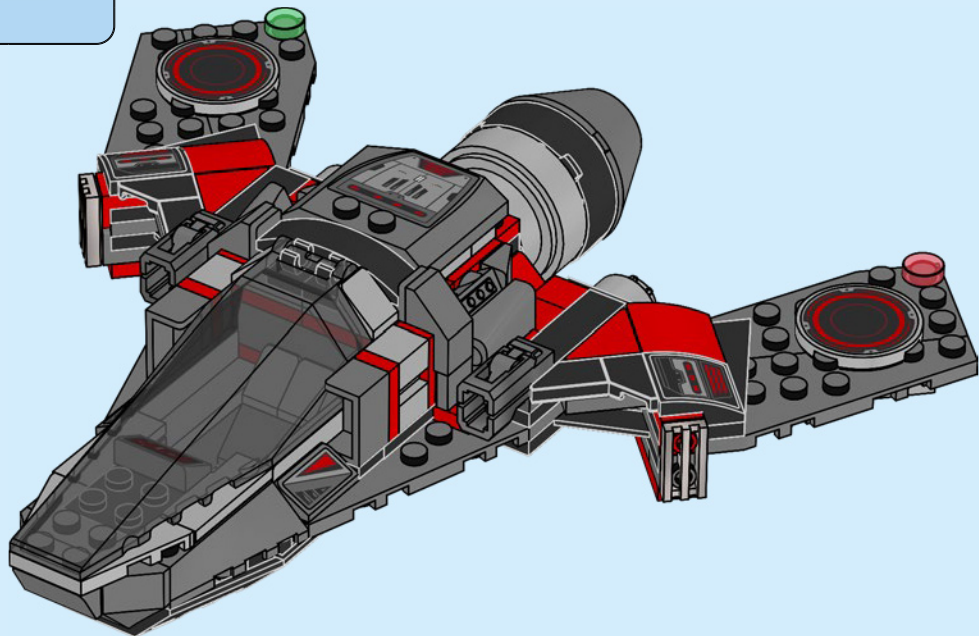





4x

86

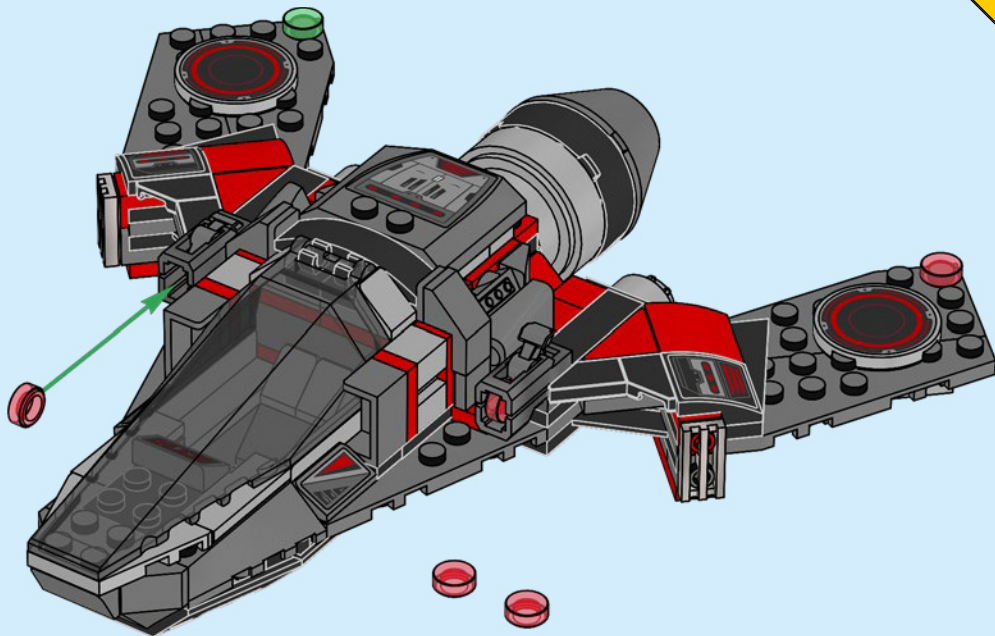

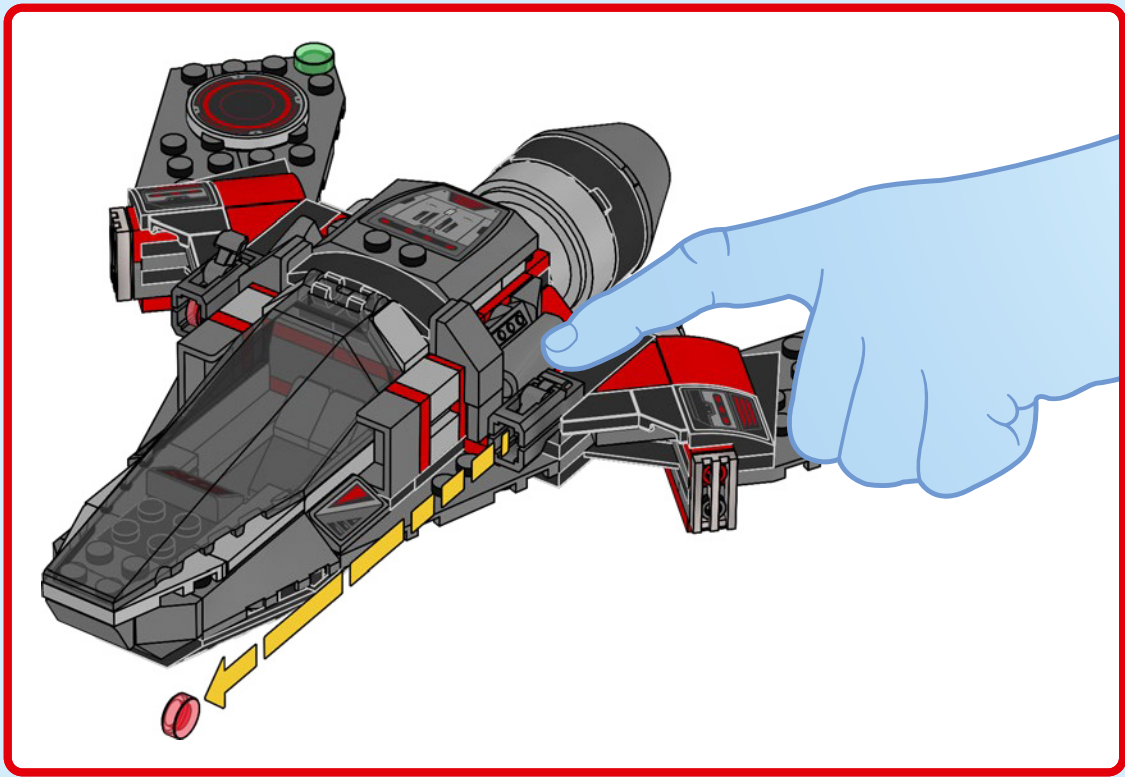



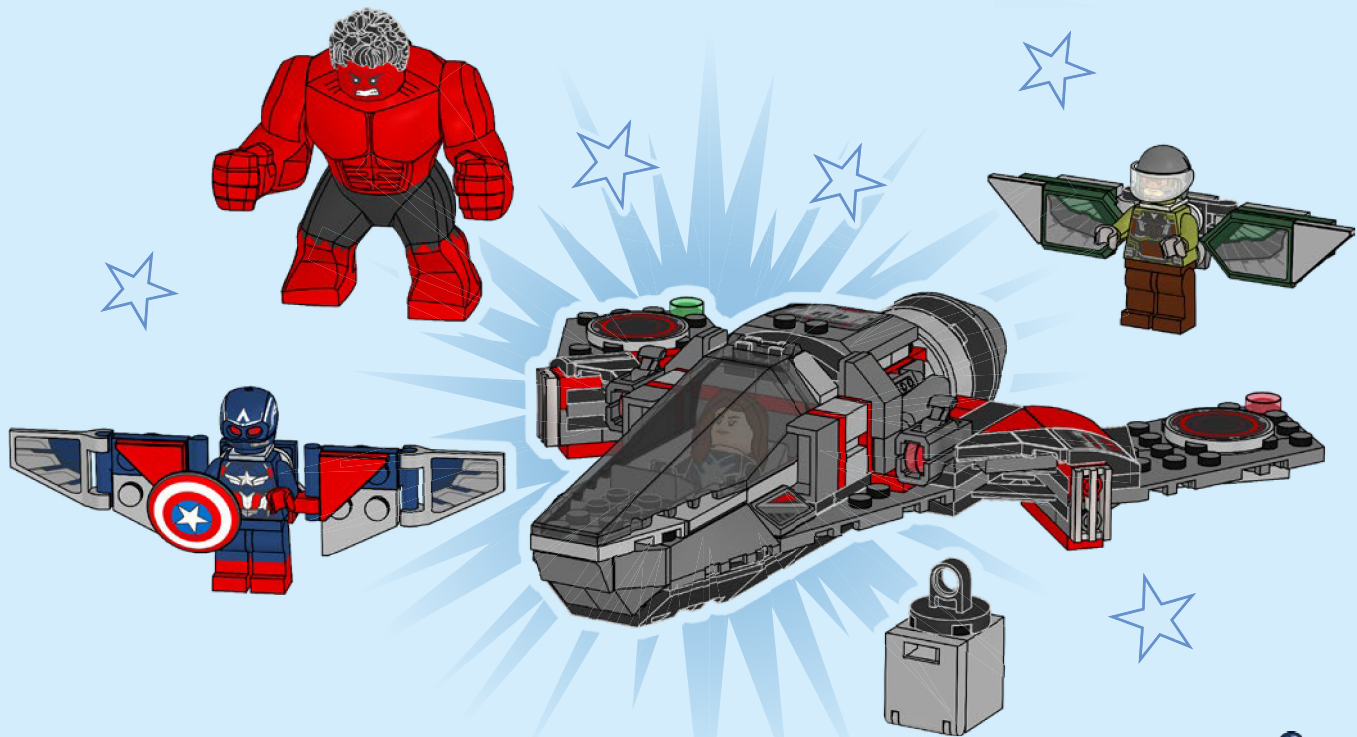



1x  
6059185



1x  
4249563



1x  
6214334



2x  
6372478



2x  
6335377



1x  
6476670



2x  
370021



2x  
6053011



4x  
302321



2x  
6275178

82



1x  
6486008



8x  
6319330



1x  
6486015



4x  
6351892



1x  
6486017



2x  
6105976



2x  
242021



2x  
6211447



1x  
6486018



6x  
371021

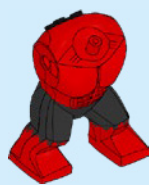

1x  
6476680



2x  
4206482



1x  
302324



1x  
4560181



2x  
307026



2x  
6458188



1x  
4161332



1x  
4160869



1x  
6103643



2x  
6279875



1x  
6010831



2x  
6458187



2x  
6347310



6x  
6020193



1x  
6430626



2x  
6053077



2x  
6313191



1x  
6186133



2x  
4558170



1x  
6487153



1x  
6099483



1x  
302126



2x  
301026



1x  
4613153



1x  
4558957



4x  
6054852



2x  
6039194



1x  
370626



2x  
663626



1x  
6131571



1x  
4541984



1x  
6195436



1x  
6244787



2x  
6166106



6x  
6258607



1x  
6273153



2x  
6274742



2x  
6030521



1x  
6343796



1x  
6491727



1x  
6486001



2x  
6440476



1x  
6458400



1x  
6389696



1x  
6487137



2x  
6486505



1x  
6167130



1x  
6167129



2x  
6285134



1x  
4550736

6

1x  
6163478

1x  
6163477

1x  
6248890

1x  
4211492

2x  
6307931

4x  
6093859

2x  
4617170

2x  
6066097

2x  
6365505

3x  
6217876

2x  
6319336

2x  
6177078

1x  
4211491

2x  
6306721

2x  
4558169

2x  
6071299

1x  
4511007

1x  
6170521

1x  
4211395

2x  
6372029

2x  
4211452

1x  
4211425

1x  
4221886

1x  
6383134

1x  
6420370

3x  
6208446

2x  
4619636

2x  
4210848

4x  
6225494

1x  
6488037

2x  
6360675

6x  
4567887

1x  
6261471

3x  
4529727

3x  
4529728

2x  
6168776

2x  
6275131

2x  
4211054

2x  
6227909

2x  
4502068

1x  
6071261

4x  
4210897

1x  
4298583

1x  
4222113

1x  
4298580

1x  
4211085

1x  
4210940

2x  
4211107

2x  
6345952

1x  
6476665

1x  
6488184

1x  
6440101

 [LEGO.com/service](https://www.LEGO.com/service)

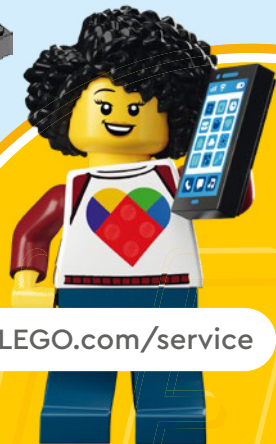

YOU COULD **WIN**

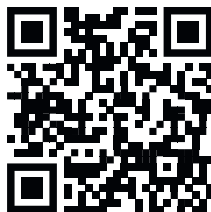

Scan this QR code or go to **LEGO.COM/PRODUCTFEEDBACK** and give us your short feedback about this LEGO® set for a chance to win a cool LEGO prize.

Terms and Conditions apply\*



**EN: YOU COULD WIN.** Terms and Conditions apply\* **DE: Du könntest GEWINNEN.** Es gelten die Teilnahmebedingungen\* **FR: Tu pourrais GAGNER.** Des conditions s'appliquent\* **IT: Potresti VINCERE tu.** Termini e condizioni sono applicabili\* **ES: Puedes GANAR.** Aplican términos y condiciones\* **PT: Poderá GANHAR.** Aplicam-se termos e condições\* **ZH: 轻松获奖. 条款和条件适用\*** **PL: Szansa na WYGRANĄ.** Obowiązują warunki korzystania\* **CS: Máte šanci VYHRÁT.** Platí všeobecné smluvní podmínky\* **SK: Máte šancu VYHRAŤ.** Platia všeobecné zmluvné podmienky\* **HU: TE IS NYERHETSZ.** Felhasználási feltételek érvényesek\* **RO: Ai putea CÂȘTIGA.** Se aplică termenii și condiții\* **BG: Можете да СПЕЧЕЛИТЕ.** Има определени правила и условия\* **LV: Tu vari LAIMĒT.** Ir spēkā noteikumi un nosacījumi.\* **ET: Sul on võimalus VÕITA.** Kehtivad tingimused\* **LT: Jūs galite LAIMĖTI.** Taikomos sąlygos\*

\*[LEGO.com/productfeedback-terms](https://www.lego.com/productfeedback-terms)

LEGO and the LEGO logo are trademarks of the/sont des marques de commerce du/son marcas registradas de LEGO Group. ©2024 The LEGO Group.

© 2024 MARVEL

6512871