



CITY

60307



WARNING: CHOKING HAZARD.
Toy contains small parts and a small ball.
Not for children under 3 years.

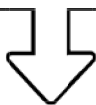
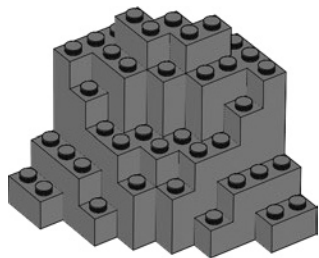

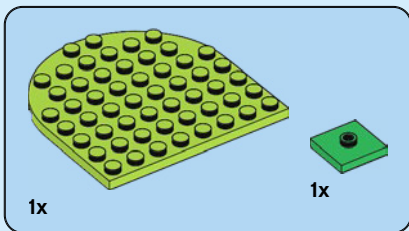

1

- ⚠ **AVERTISSEMENT :**
RISQUE D'ÉTOUFFEMENT.
Le jouet contient des petites pièces ainsi qu'une petite boule.
Il ne convient pas aux enfants de moins de 3 ans.
- ⚠ **ADVERTENCIA:**
PELIGRO DE ASFIXIA.
Juguete que contiene partes pequeñas y una pelota pequeña.
No recomendado para niños menores de 3 años.

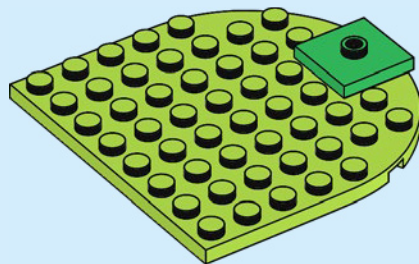

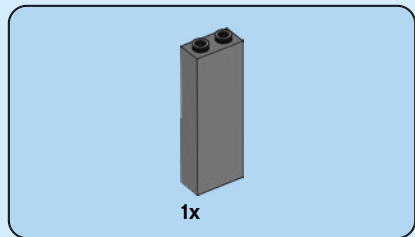

2

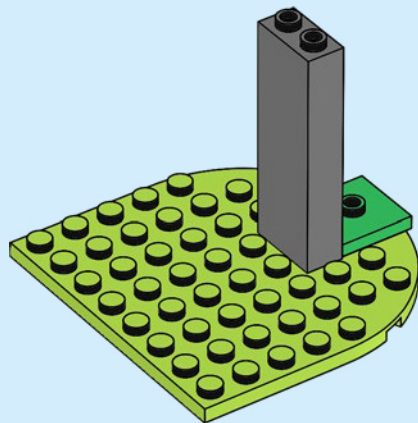

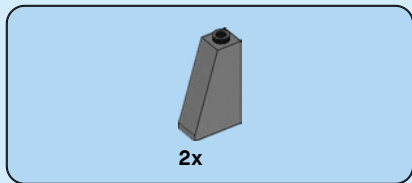

3

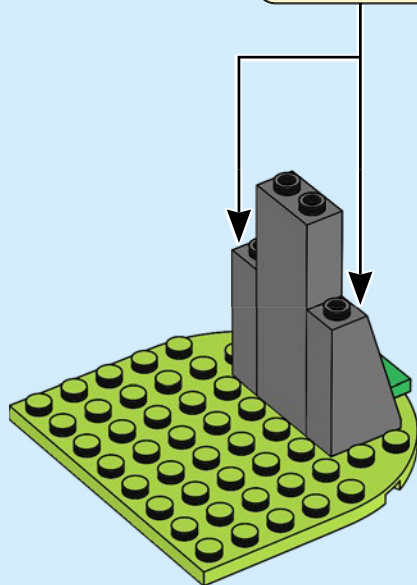
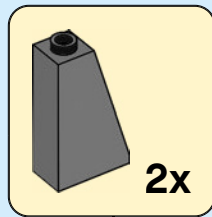

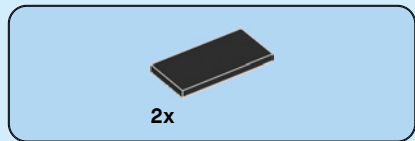

4

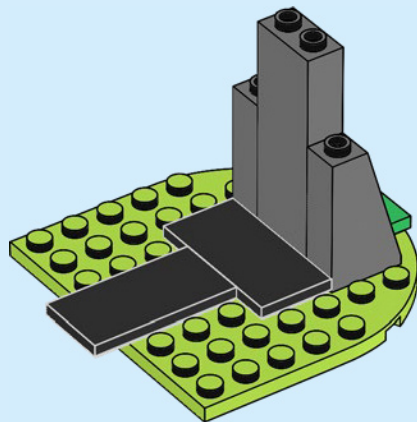

6

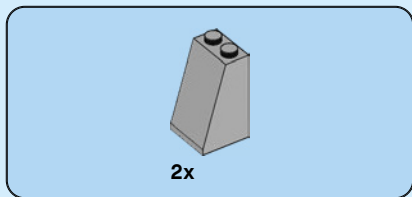

5

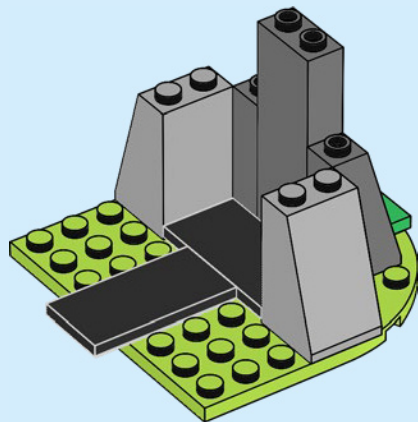

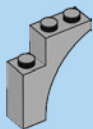

2x

6

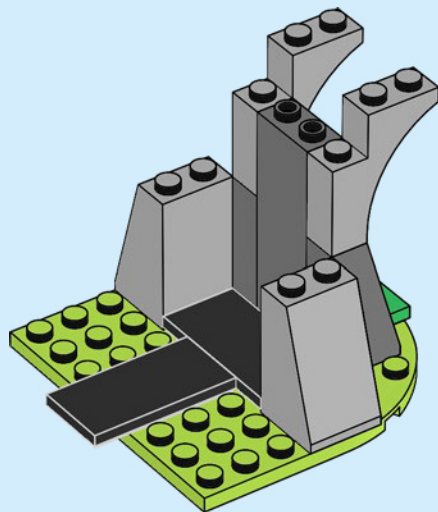

8

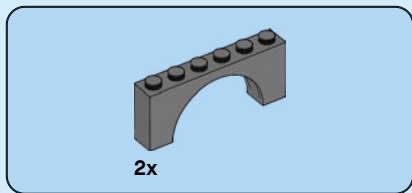

7

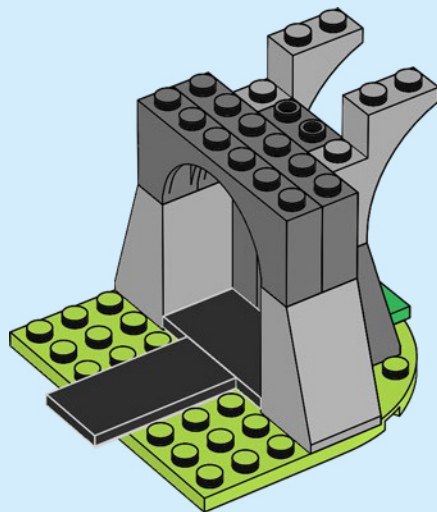

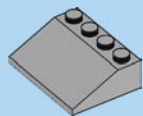

1x

8

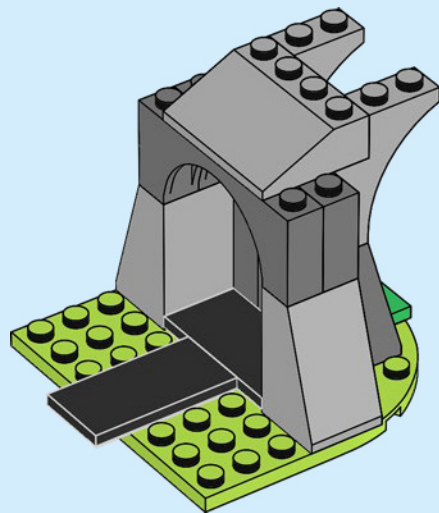

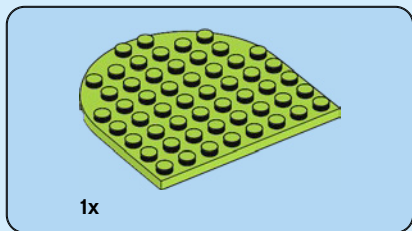

9

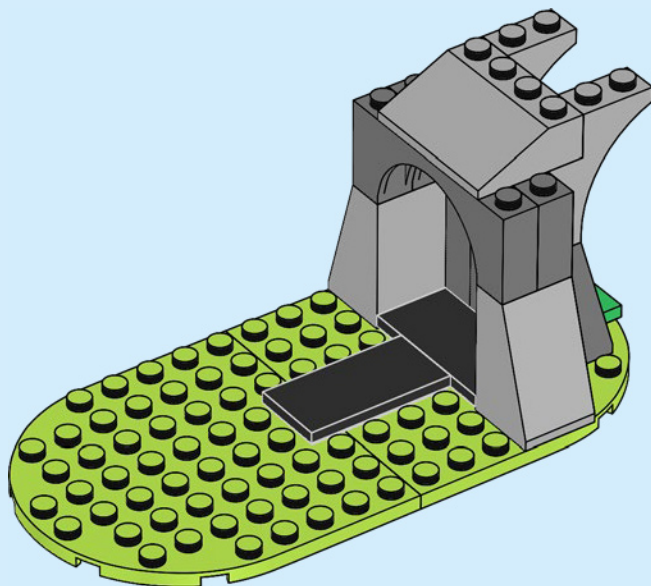

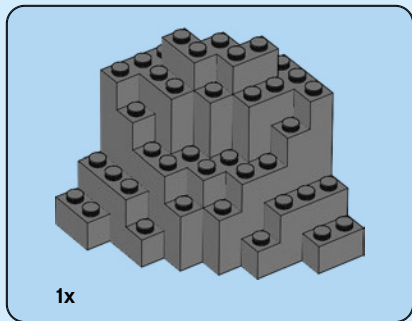

10

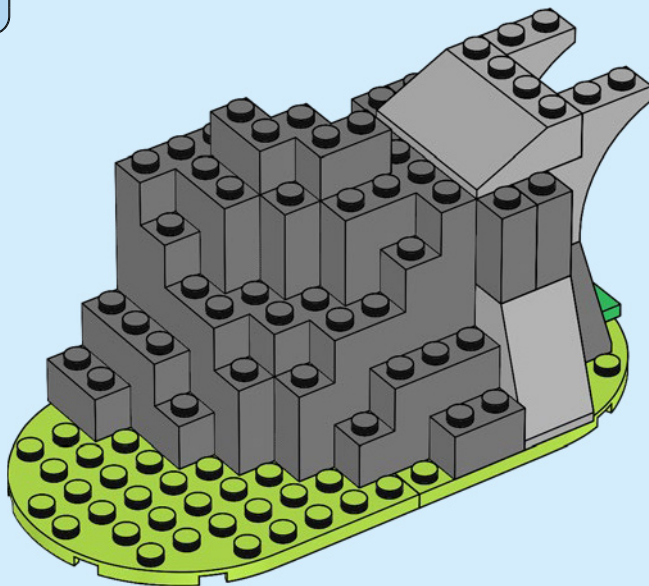



1x

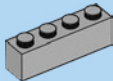

1x

11

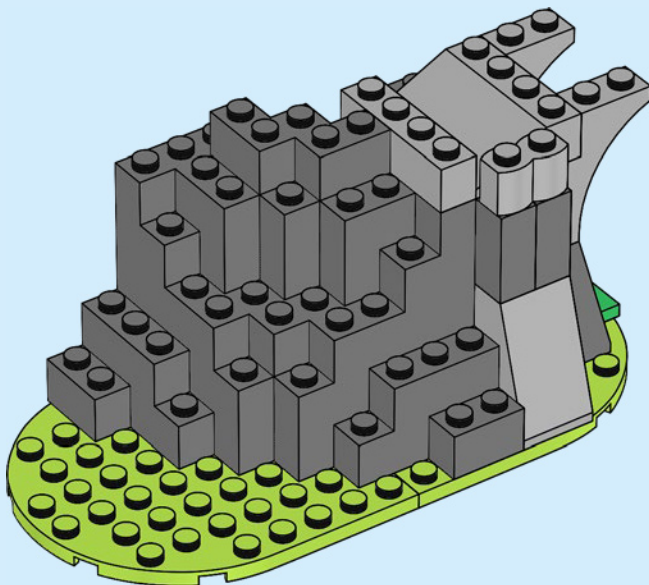



1x

12

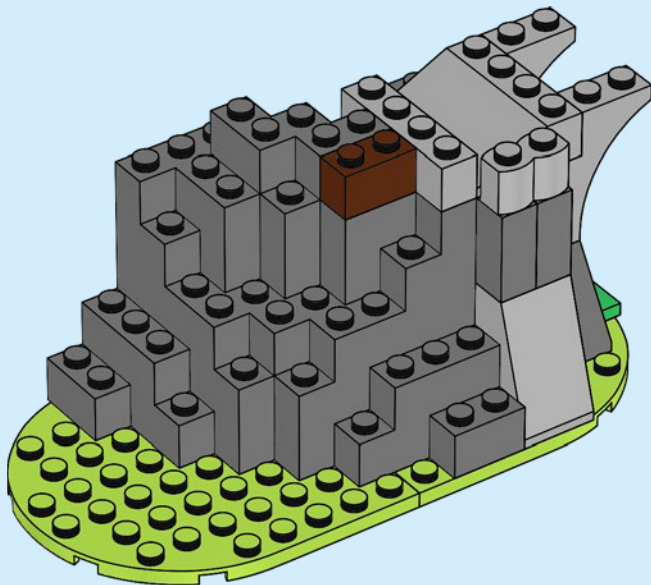



13

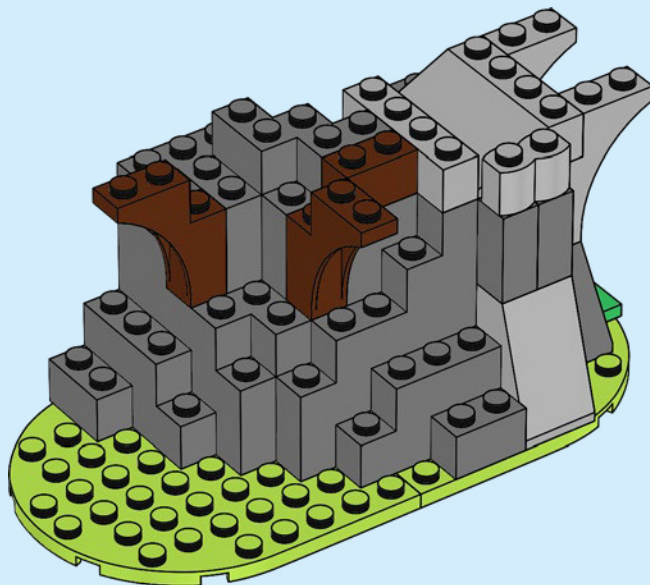



1x



1x

14

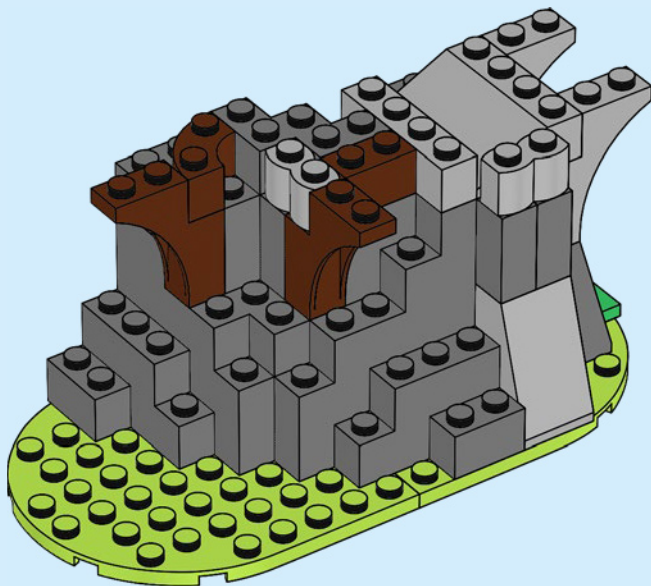

16



3x

15

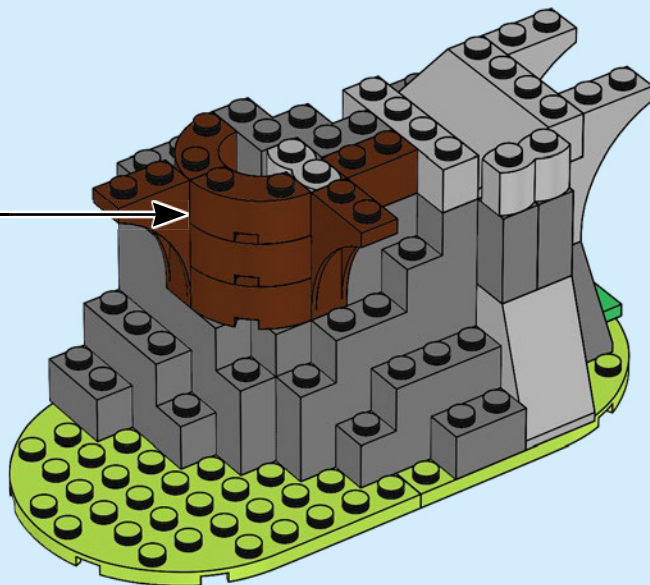
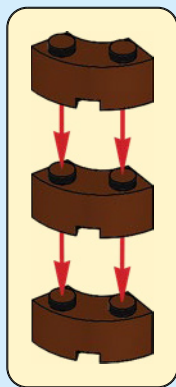

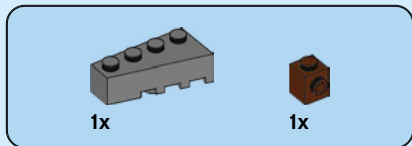

16

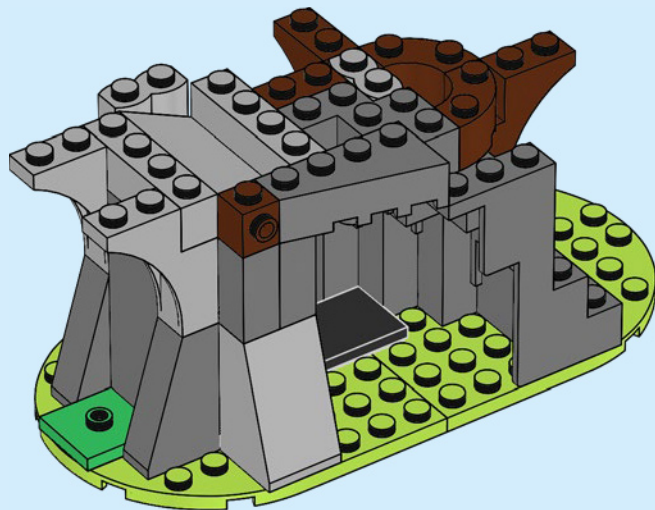

18



1x

17

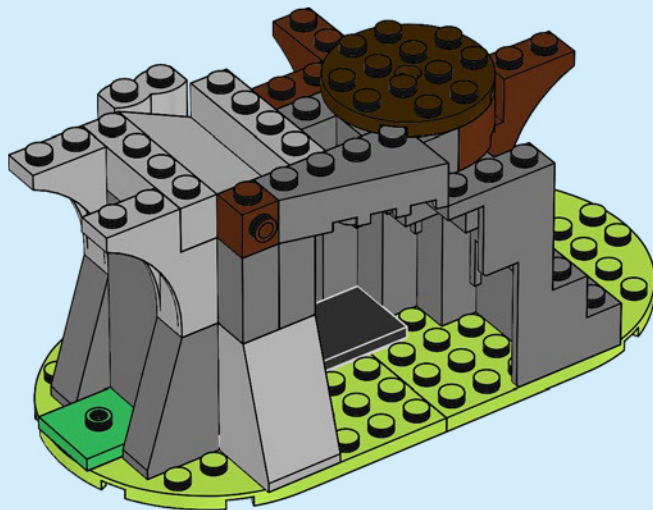

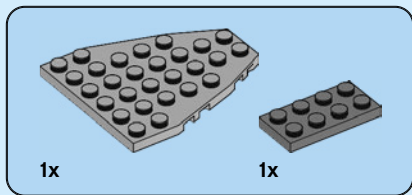

18

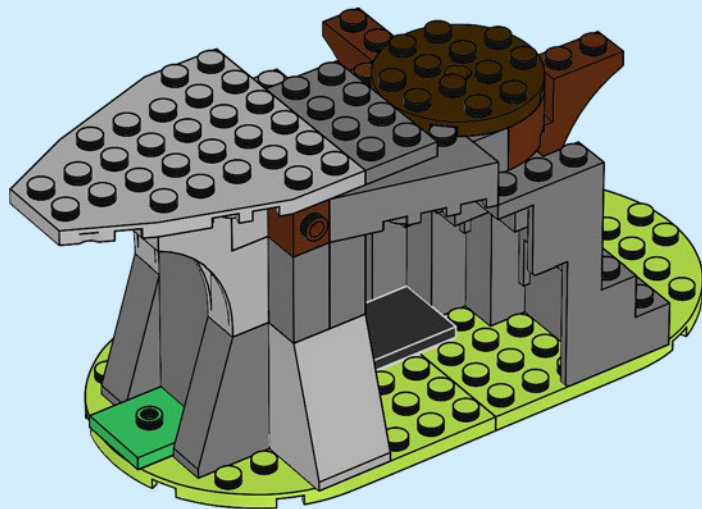



1x

19

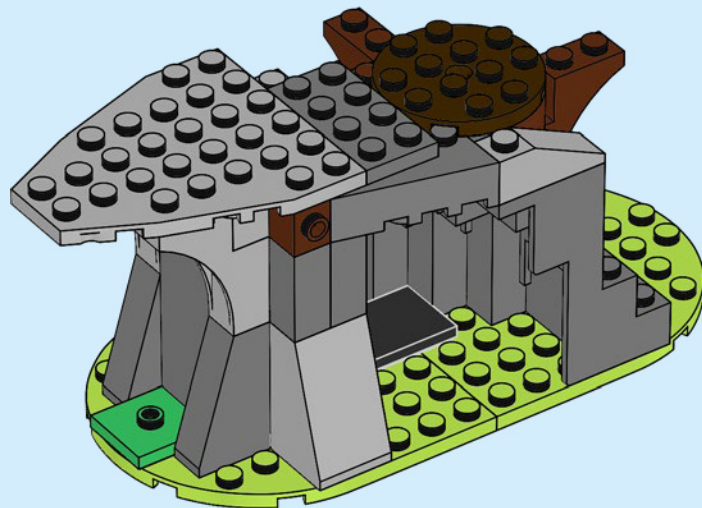



2x

20

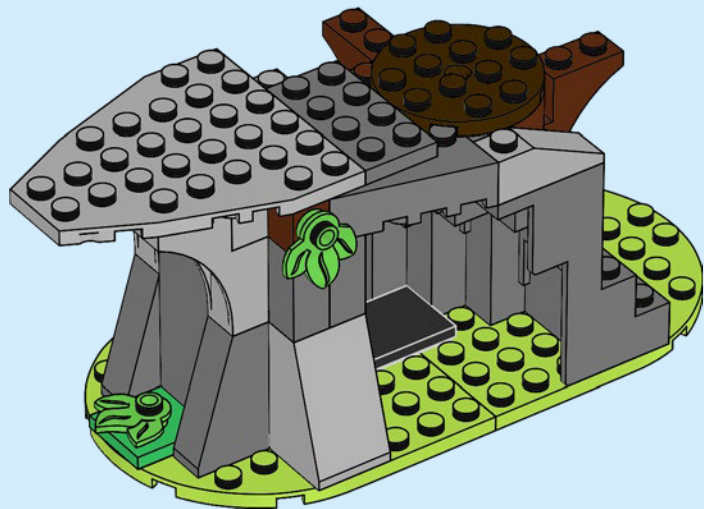

22

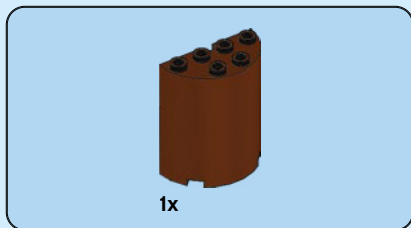

21

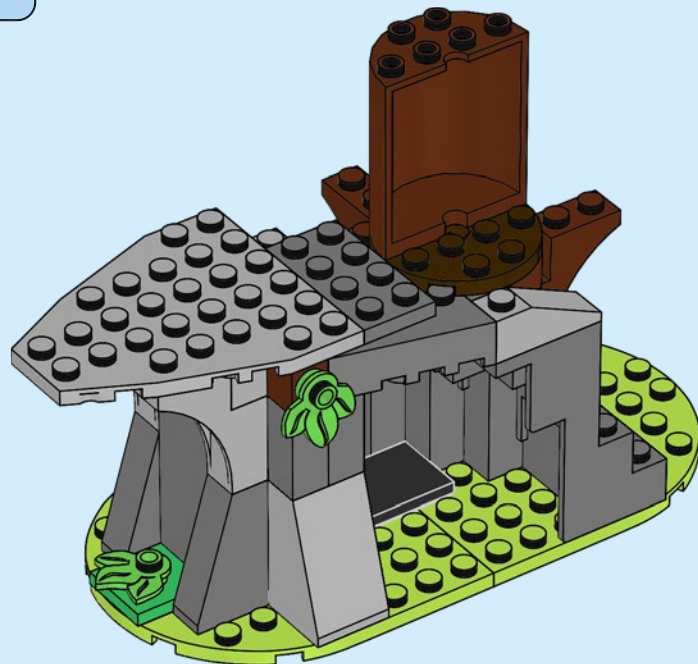

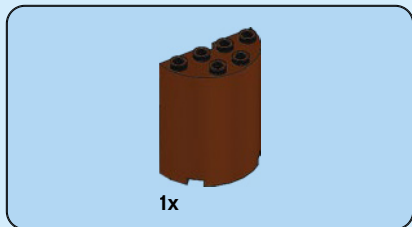

22

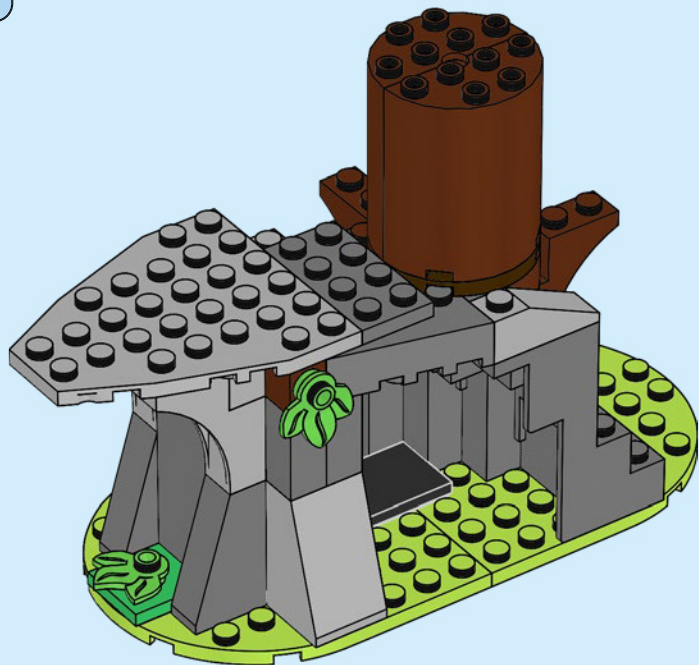

24



1x

23

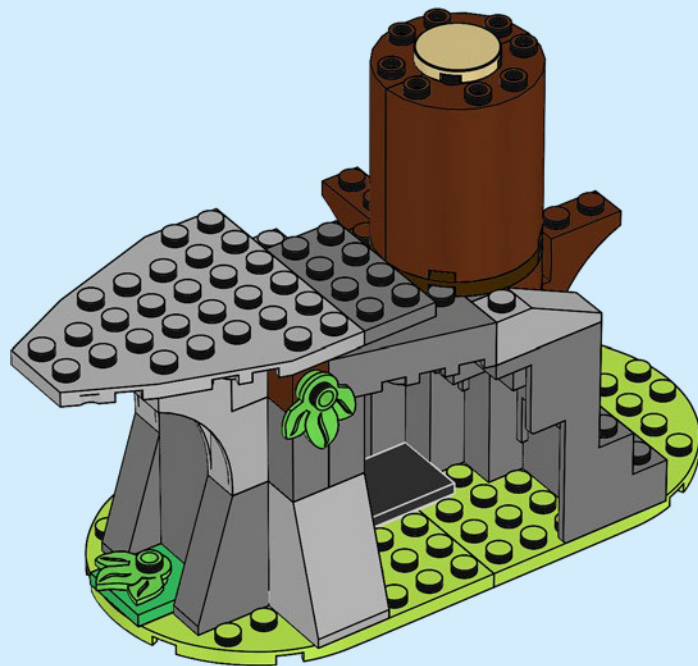



2x

24





25

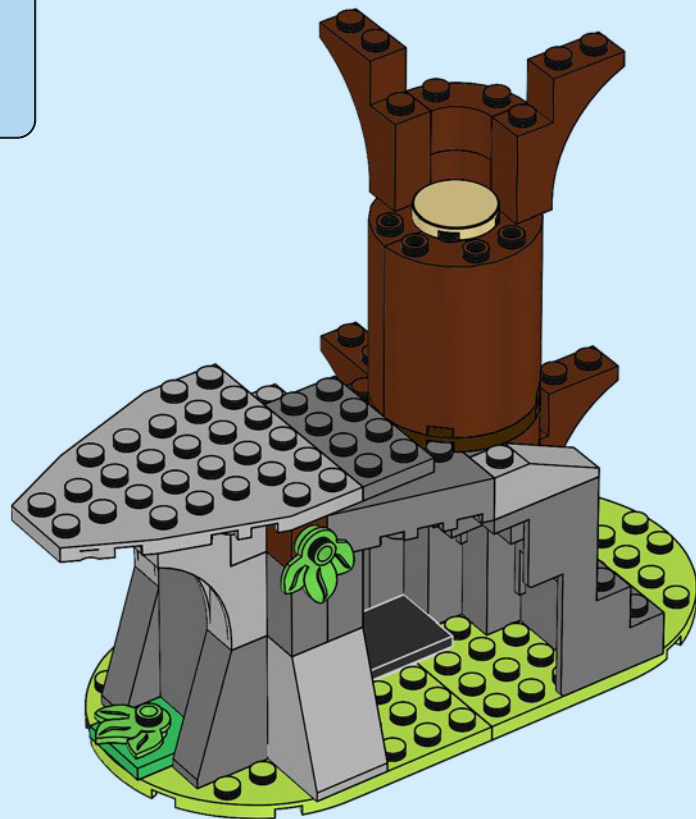



26





2x

27

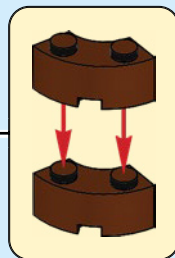
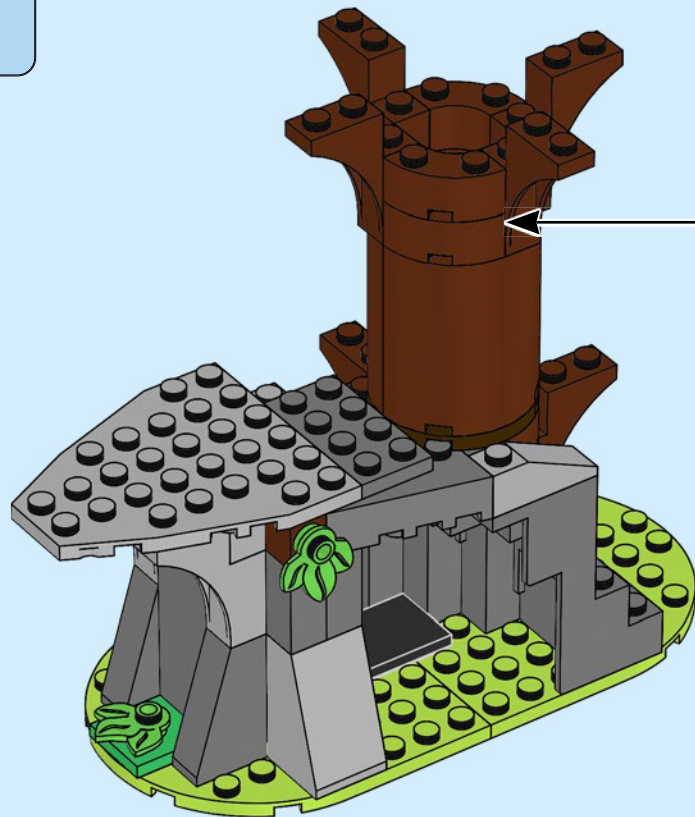

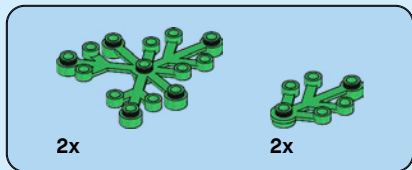

28





4x

29

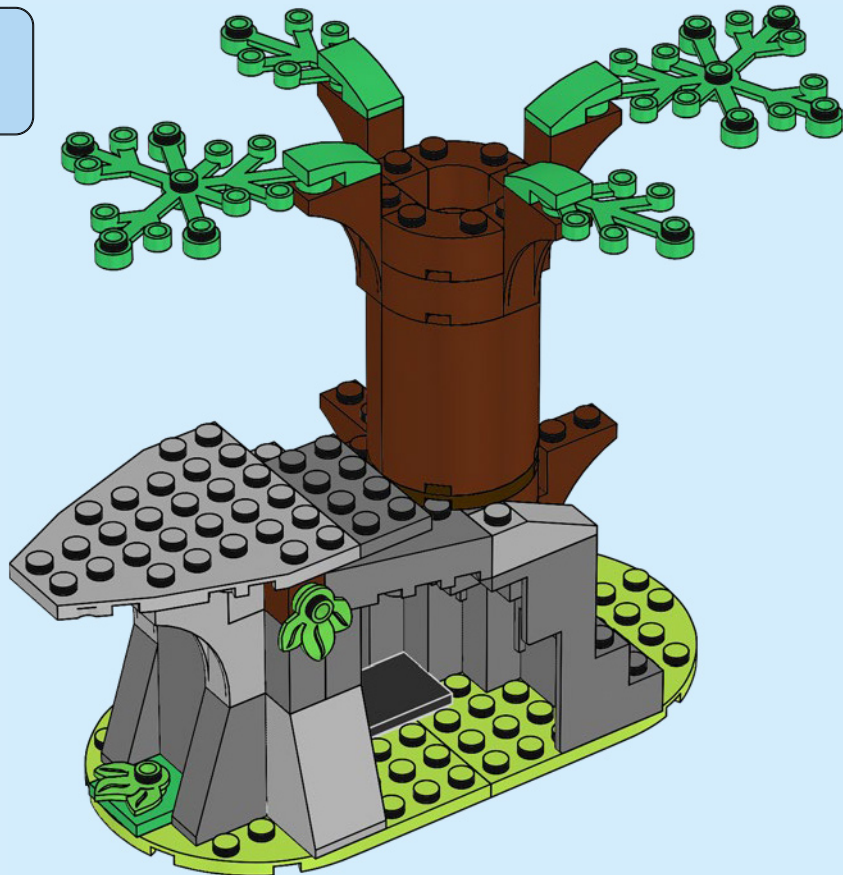

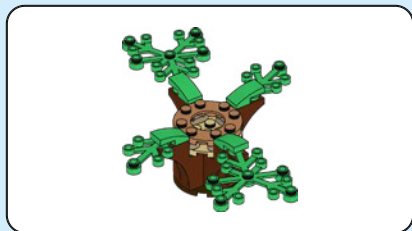

30



32



31

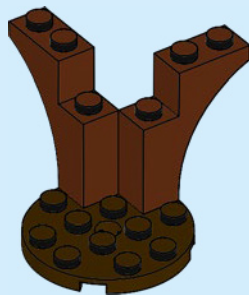



32

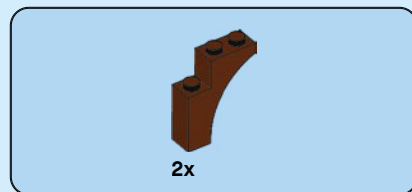
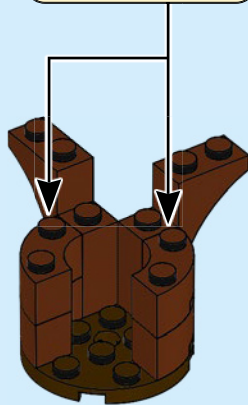
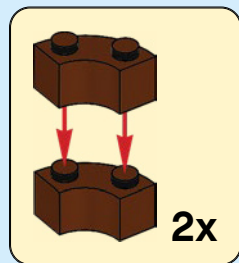

33

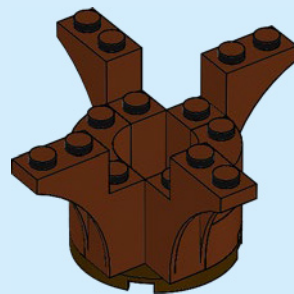

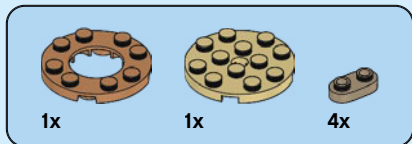

34

1



2

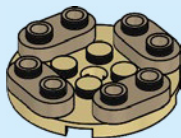

3

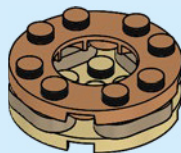

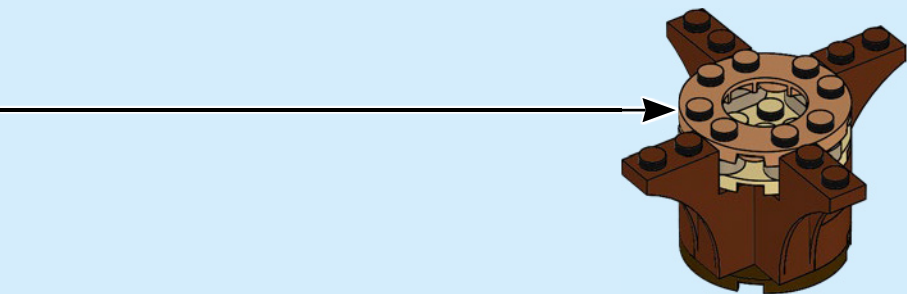

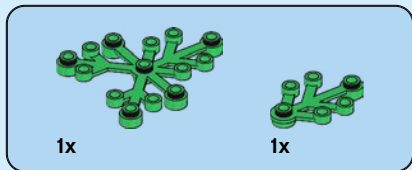

35

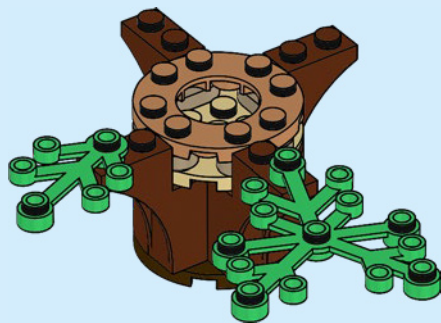

36

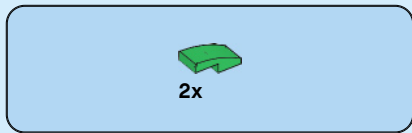

36

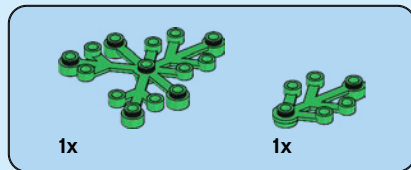
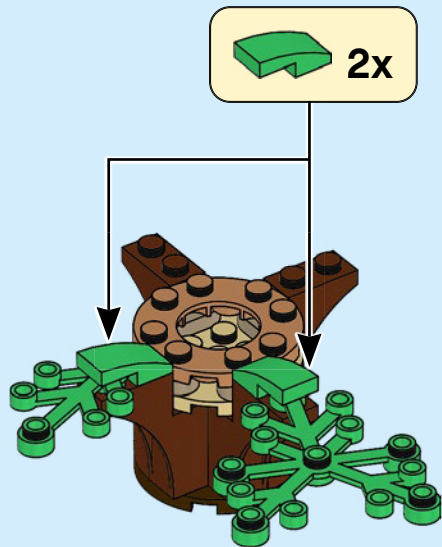

37





2x

38

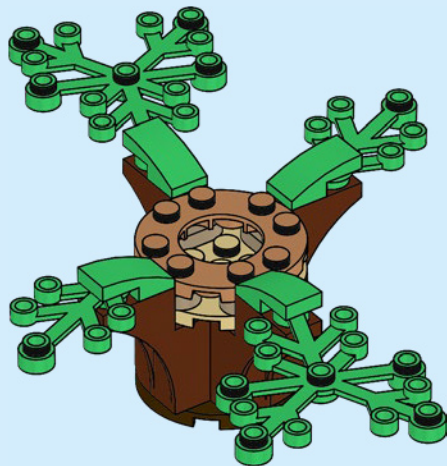

38

39

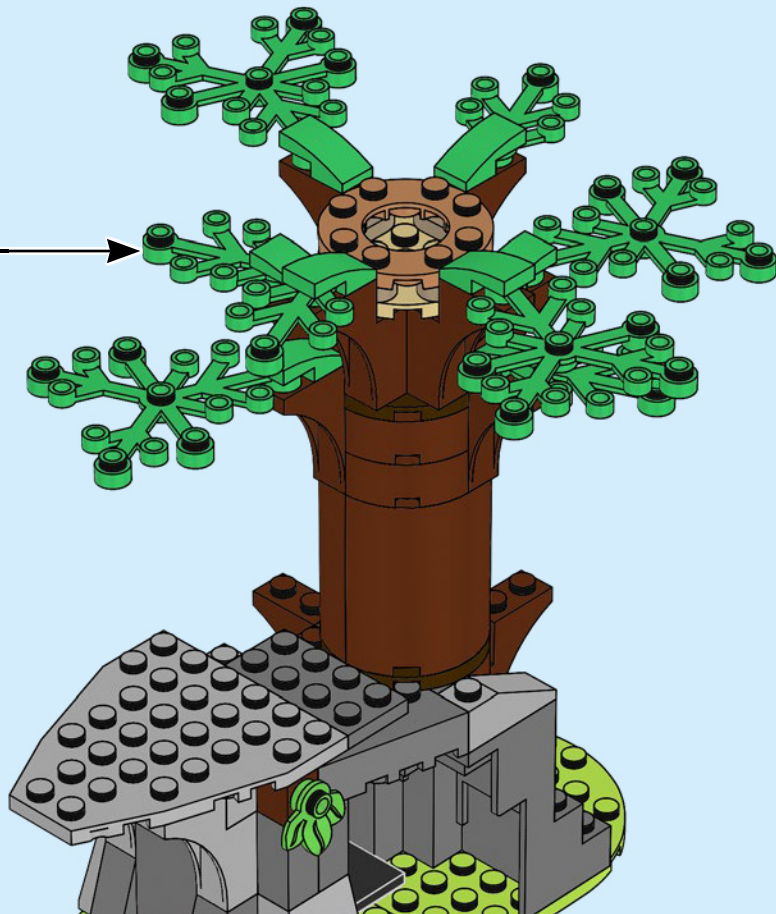

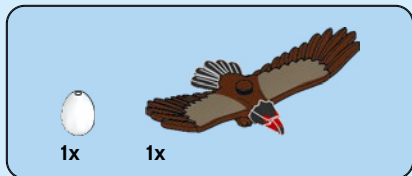

40

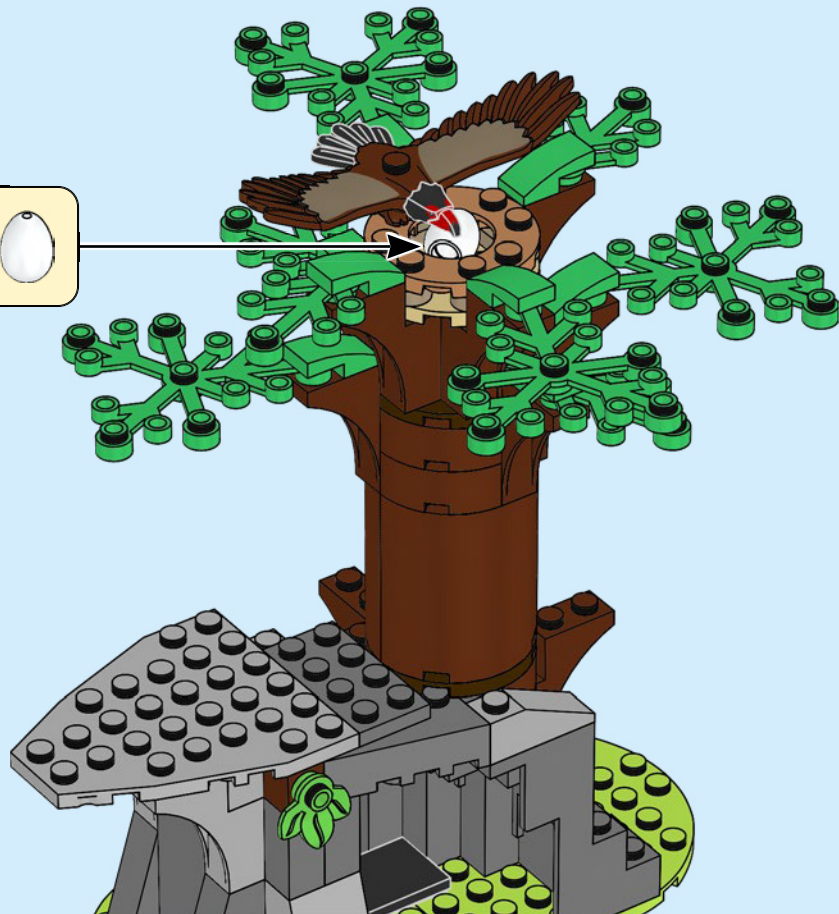

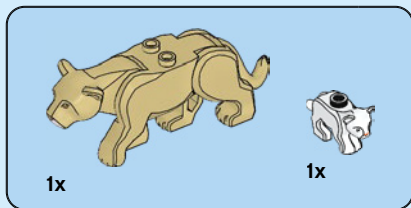

41







CITY



60281



60279



60280



60282



CITY

