



# CREATOR™

40488





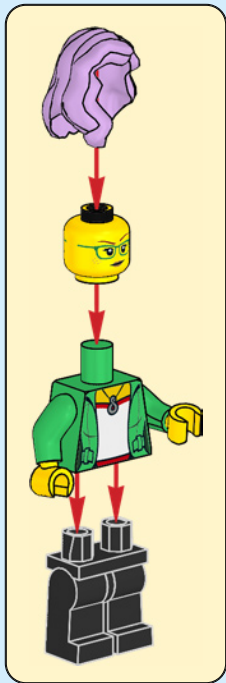



1x



2x



1x

1

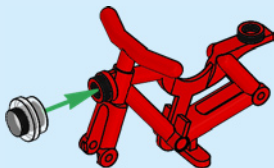

2

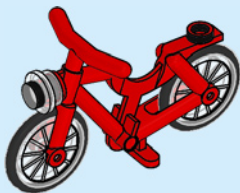

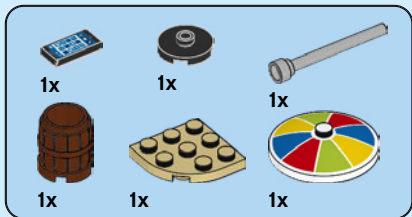

1



2

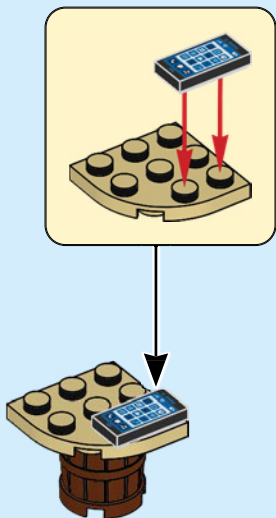

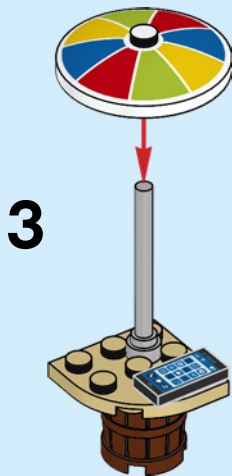

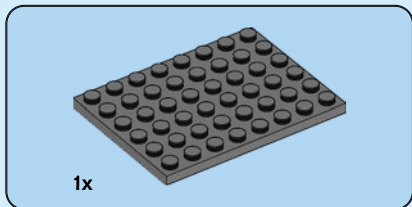
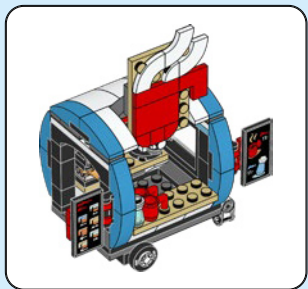

**1**

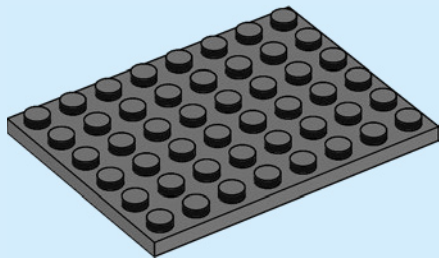



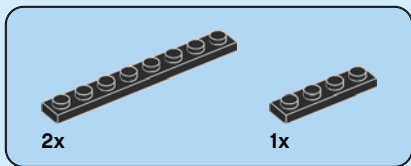

**2**

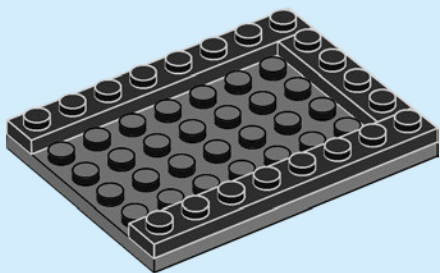

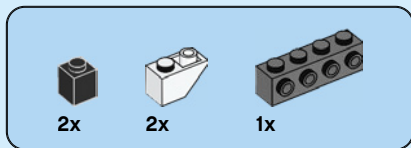

3

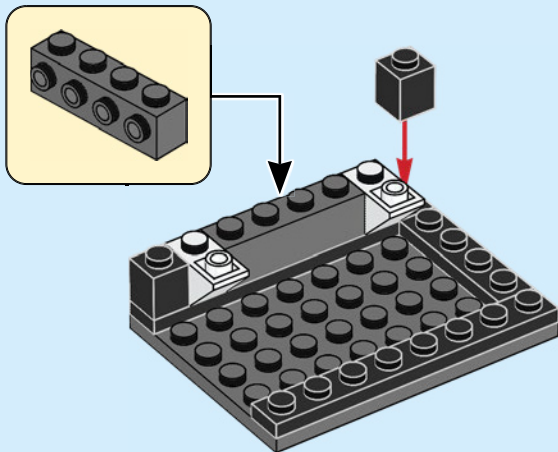

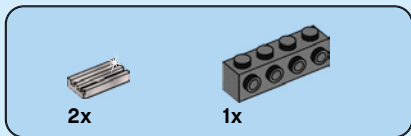

4

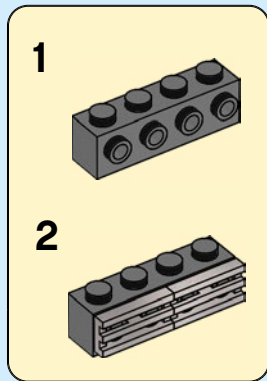
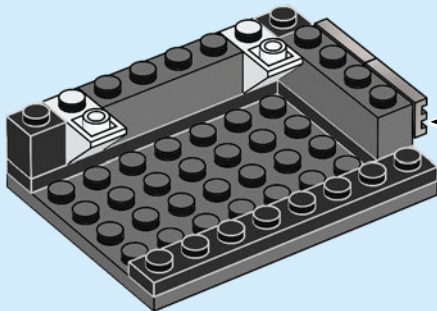

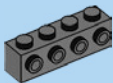

2x

5

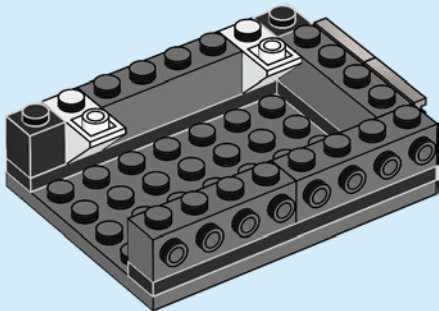



3x

6

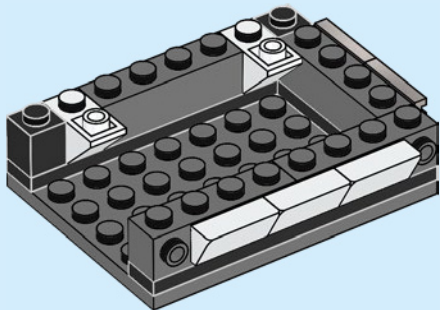

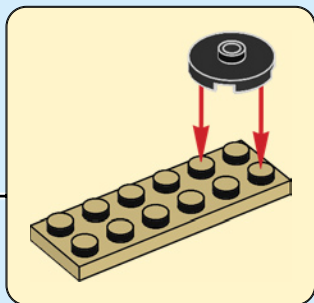
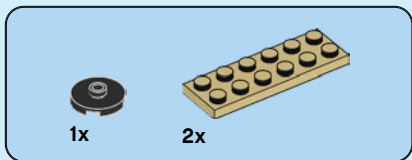

7

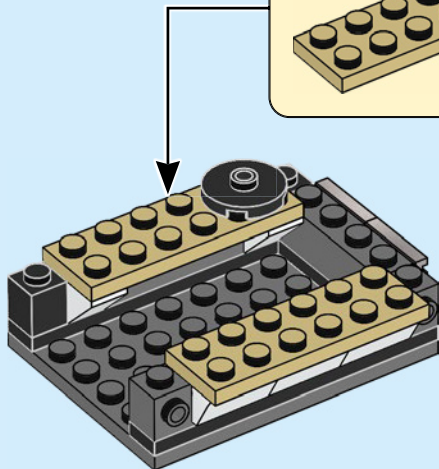

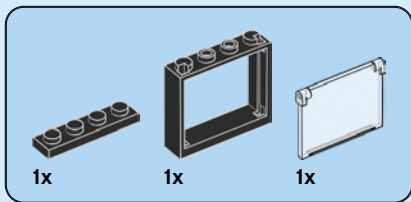

8

1

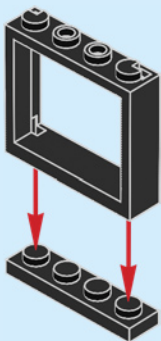

2

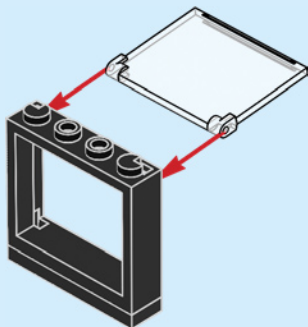

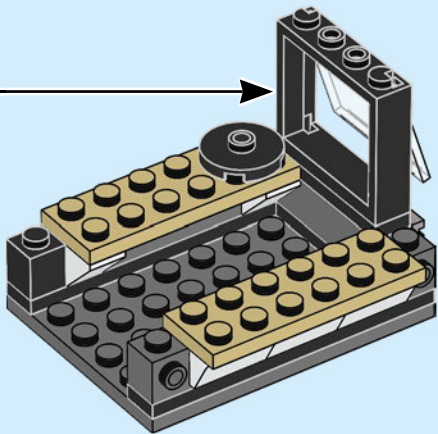





9

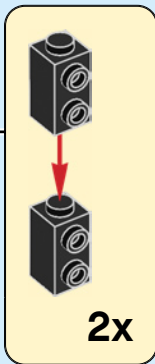
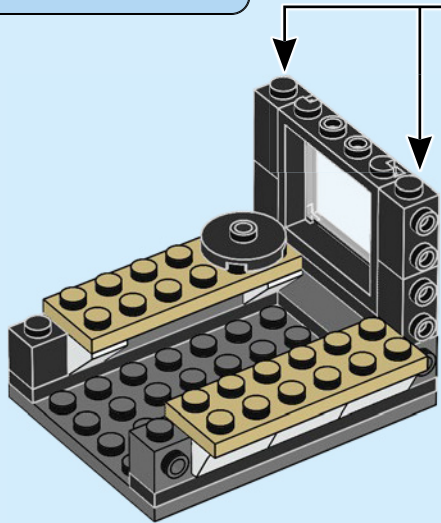



1x



1x



1x



2x

# 10

1



2

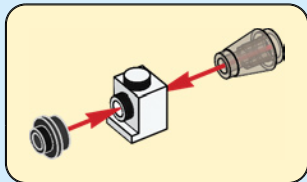

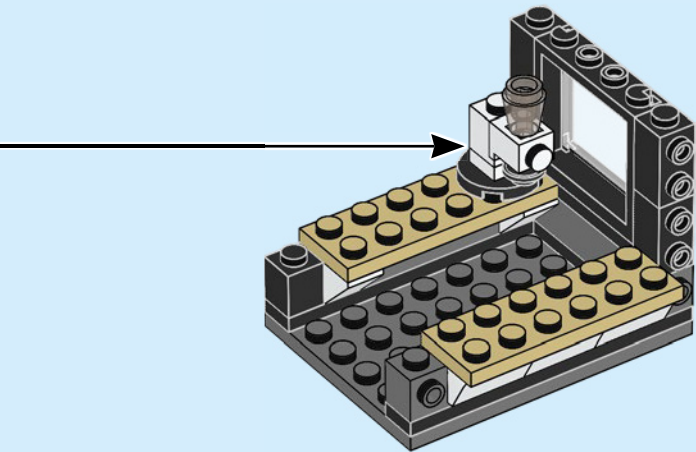



2x



2x

# 11

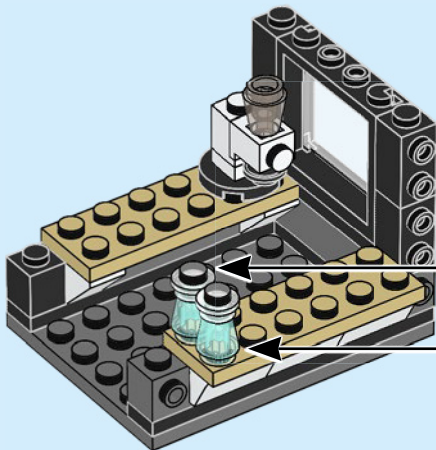

2x



2x



1x

# 12

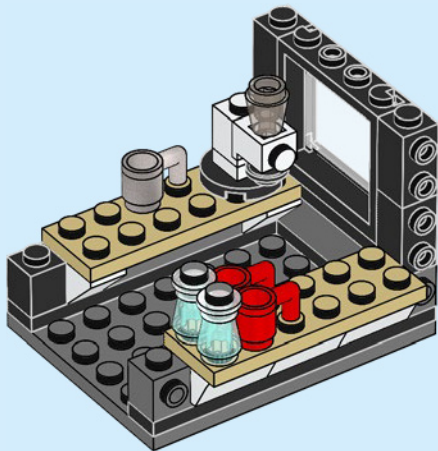

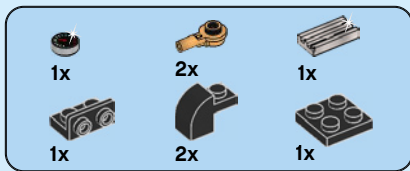

# 13

1

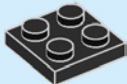

2

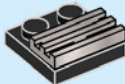

3

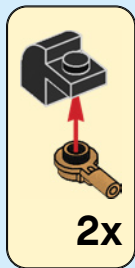
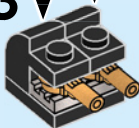

2x

4

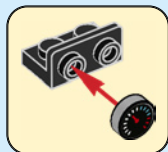

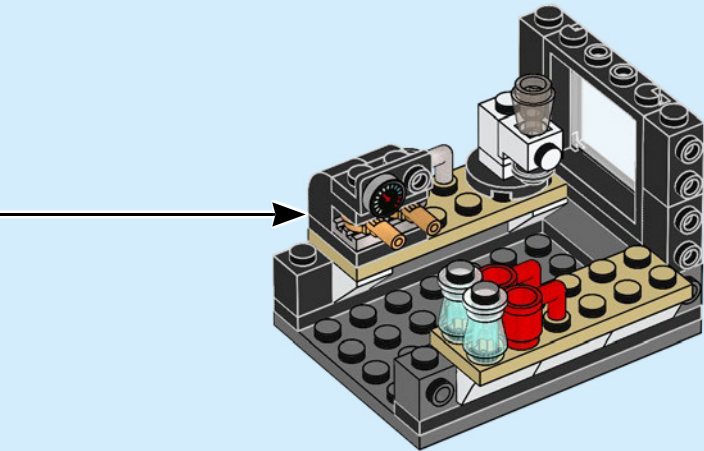



2x



2x

# 14

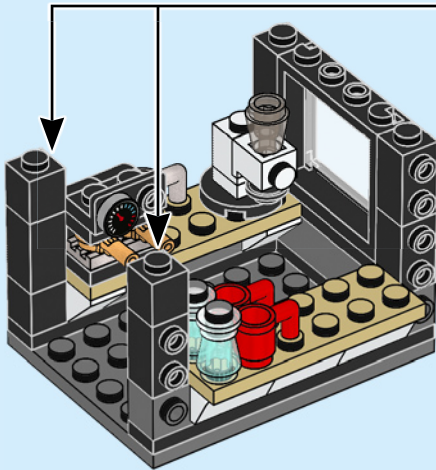

2x



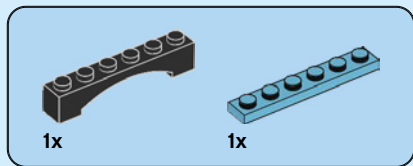

15

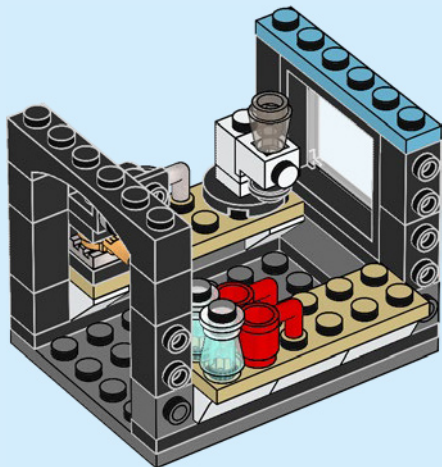



2x

16

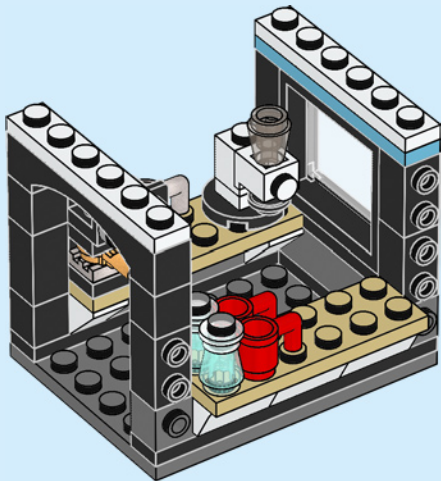

26

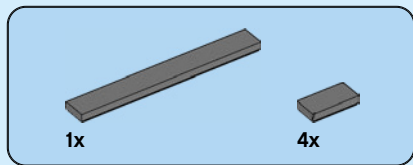

17

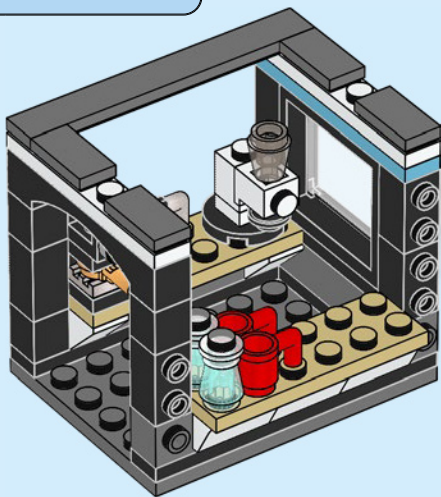



2x



2x



2x



1x



1x



2x

# 18

## 1

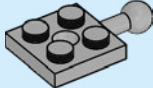

## 2

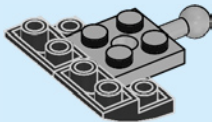

## 3

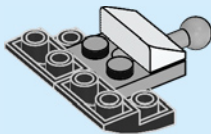

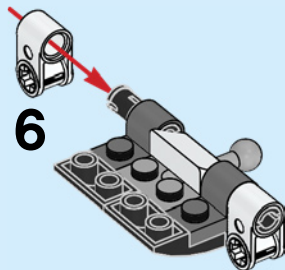
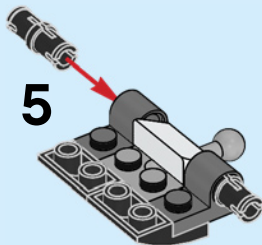
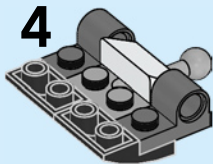

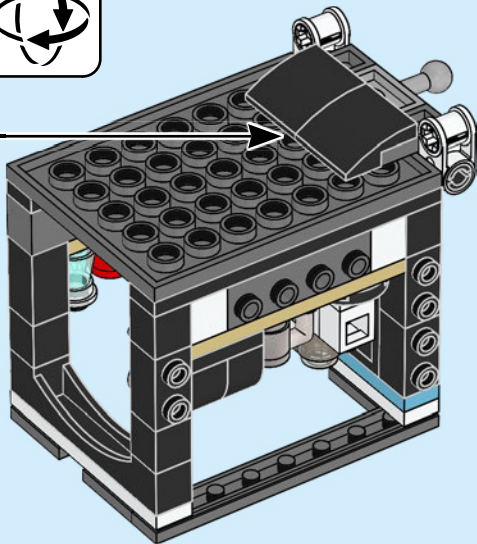



2x



2x



1x



2x



1x

# 19

## 1

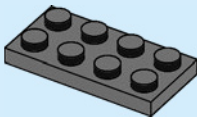

## 2

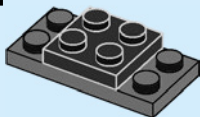

**3**

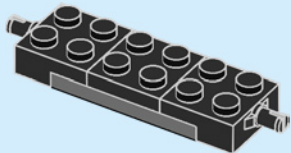

**4**

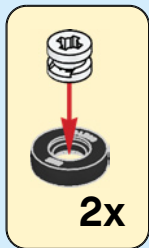
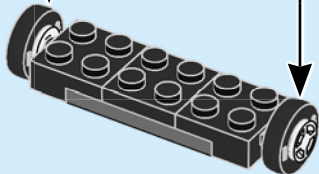



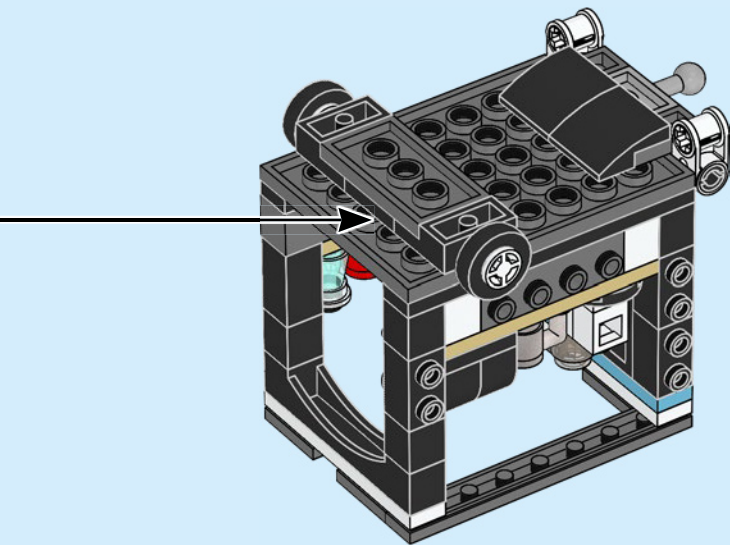



2x

20

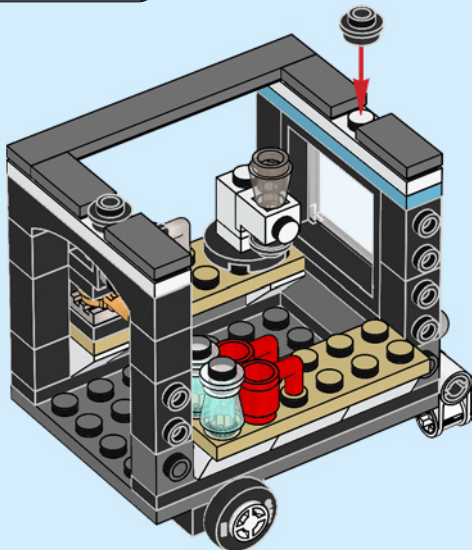

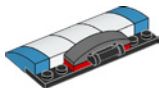

1x

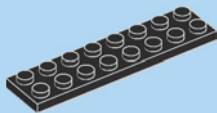

1x

# 21

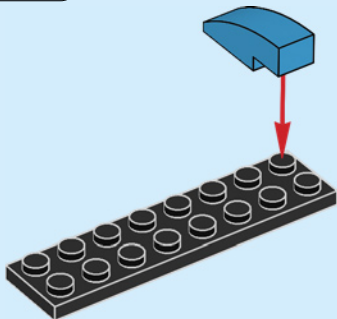



2x



3x

22

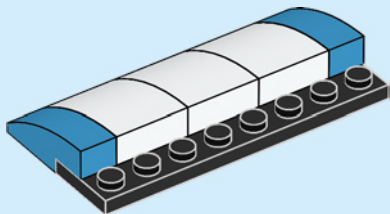

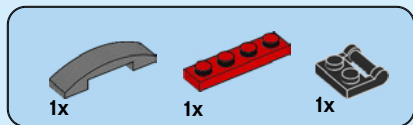

23

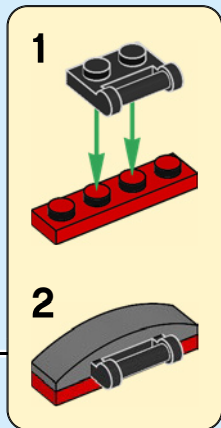
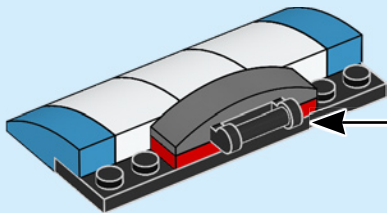



2x



2x

# 24

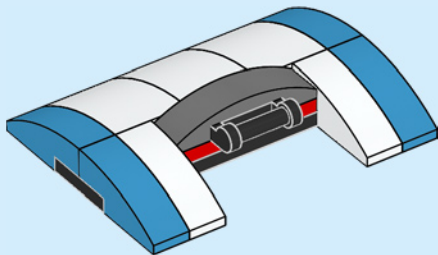

25

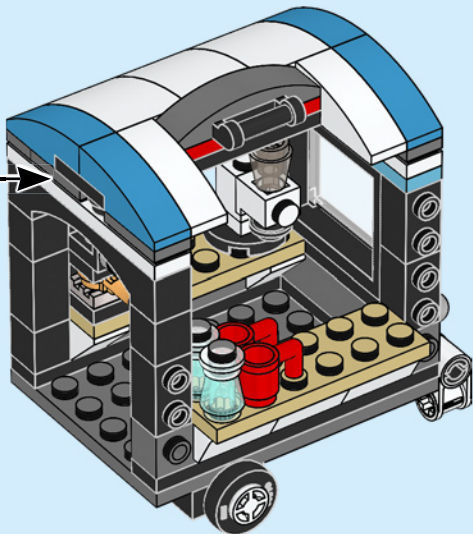



2x



4x

# 26

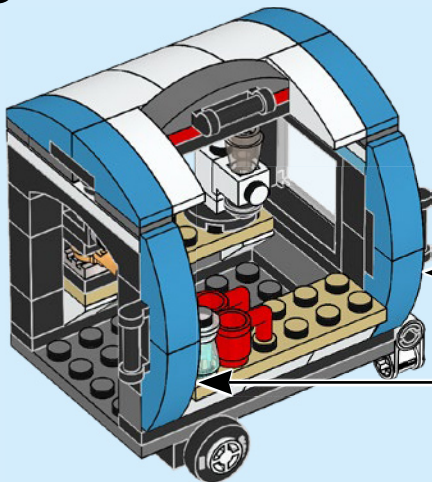

1



2

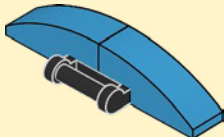

2x



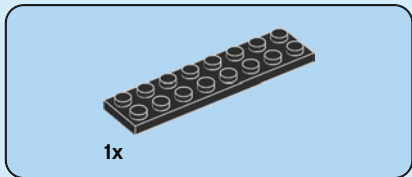
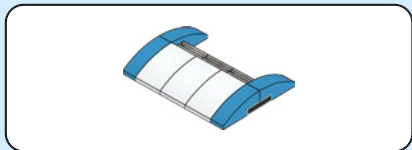

**27**

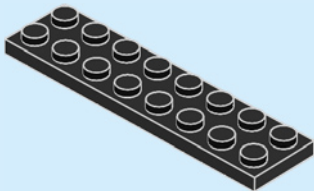



3x

28

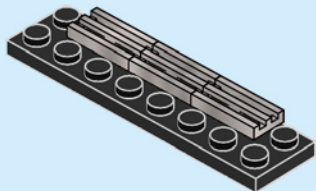

42



4x

29

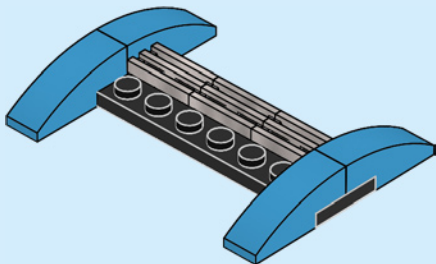



3x

30

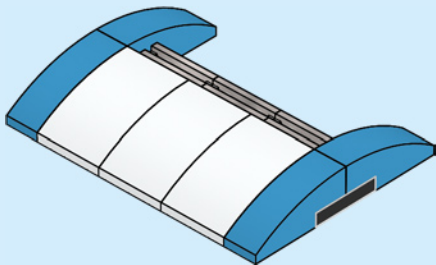

# 31

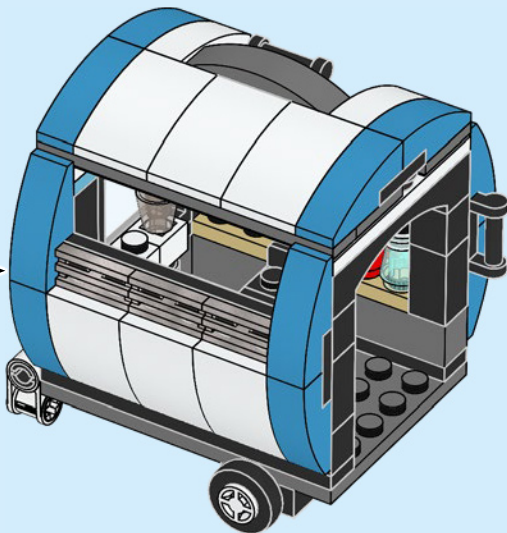

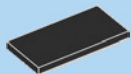

1x



2x

32

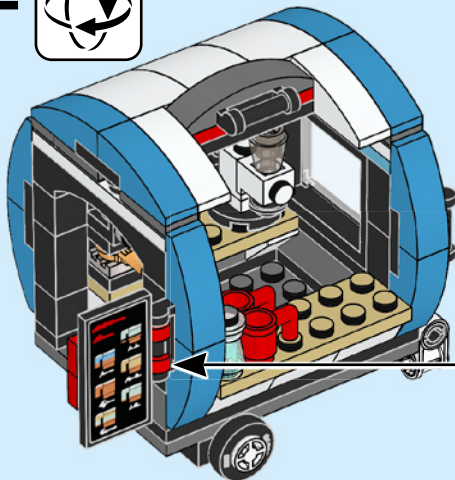

1

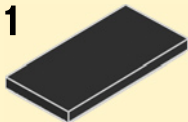

2

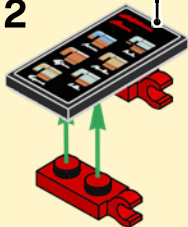

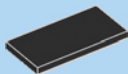

1x



2x

# 33

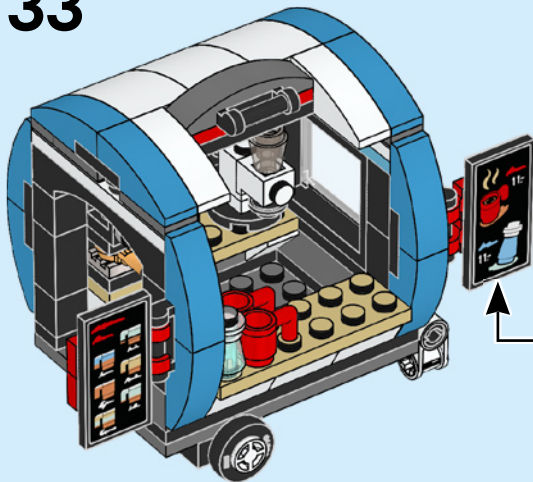

1

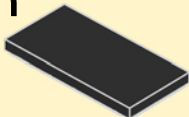

2

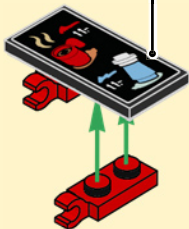

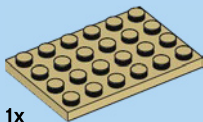

1x

34

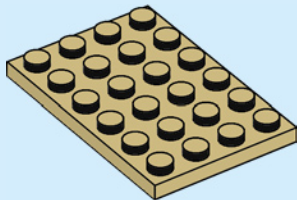



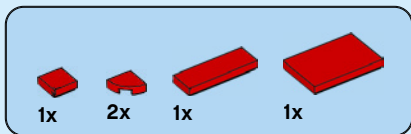

35

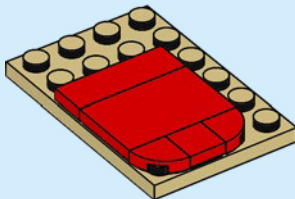



1x



3x



1x

# 36

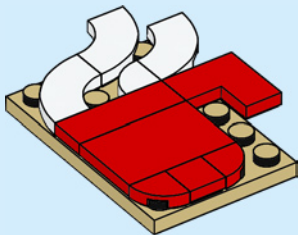



1x

37

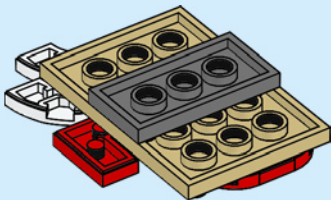



2x

38

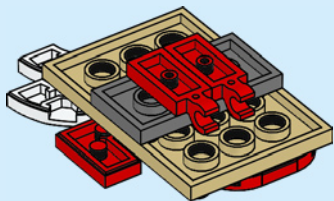

52

39

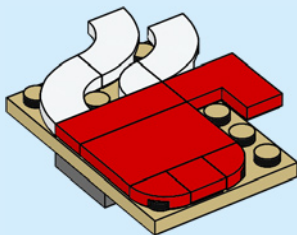

40

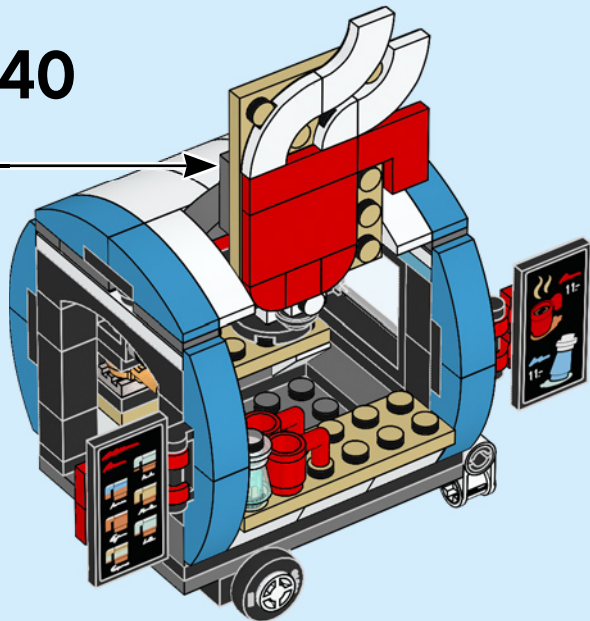

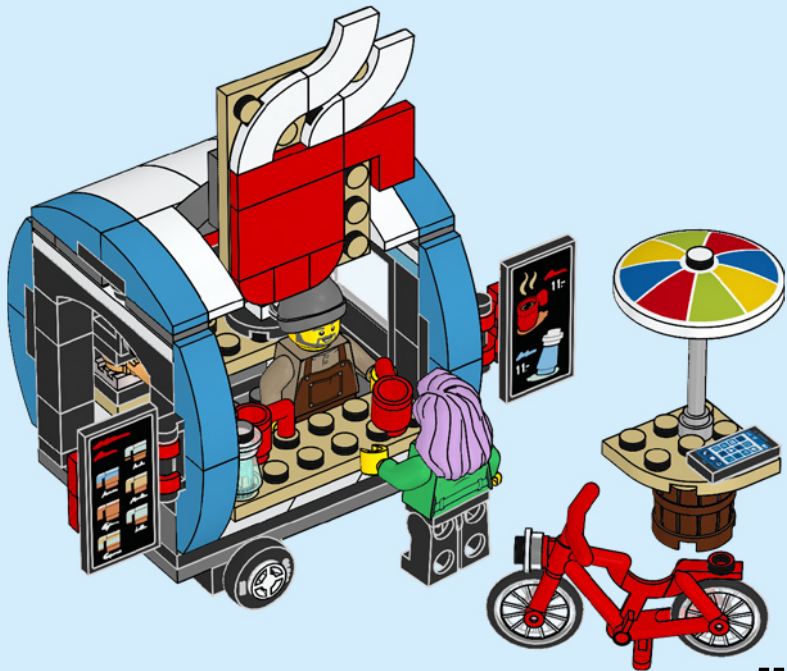



# CREATOR™

# 3 IN 1

3 in 1  
3 en 1  
3 em 1  
3 az 1-ben  
Trīs vienā  
3 合 1

**31112**



**31113**



**31116**



**31114**



**31115**



**31118**







# CREATOR™

# 3 IN 1

31120



31119



31117



LEGO.com/creator



2x  
6184784



1x  
6020193



3x  
4225201



2x  
302226



2x  
6211476



2x  
6092658



2x  
371026



1x  
4530589



2x  
4560182



1x  
4620763



2x  
346026

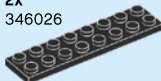

2x  
303426



1x  
4625036



12x  
4640901



2x  
6163986



1x  
6253734



2x  
6337639



1x  
6301323



1x  
6120224



1x  
6278989



1x  
6329581



1x  
6359225



1x  
4211473



1x  
6155003



4x  
4211052



2x  
6019987



1x  
4648256



4x  
4210725



3x  
6240030



2x  
4211065

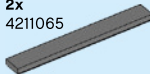

1x  
4211008



1x  
4210794



2x  
6335111



1x  
6236213



6x  
4619636



1x  
6271746



1x  
6218235



2x  
6194809



1x  
6172366



2x  
407001



2x  
6261372



4x  
4547489



2x  
366501



3x  
6172674



2x  
4249112



6x  
6132212



2x  
366601



1x  
6217974



1x  
4543858



2x  
4113993



1x  
4114001



1x  
371021



1x  
307021



2x  
6170390



2x  
389921



6x  
6346804



1x  
6078641



1x  
4533742



1x  
6189130



1x  
6350697



1x  
6295342



1x  
6335769



1x  
6330919



3x  
6168646



4x  
300526



2x  
4516843



2x  
6195325



2x  
6279875



6x  
6228987



1x  
9339



1x  
6329698



1x  
302401



Customer Service

Kundenservice

Service Consommateurs

Servicio Al Consumidor

LEGO.com/service or dial



: 00800 5346 5555



: 1-800-422-5346



# CREATOR™

# 3 IN 1



LEGO and the LEGO logo are trademarks of the/son des marques de commerce du/son marcas registradas de LEGO Group.

©2021 The LEGO Group. 6374106/6374107

31116

