

LEGO

duplo

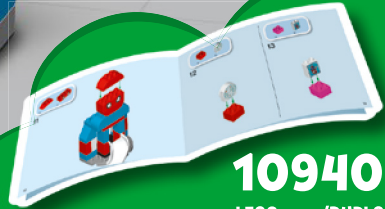

10940
LEGO.com/DUPL0

EXPLORE THE DIGITAL UNIVERSE UN UNIVERS NUMÉRIQUE À EXPLORER EXPLORA EL UNIVERSO DIGITAL



COMPTINES
DUPLO[®]

CANCIONES
INFANTILES
DUPLO[®]



Customer Service
Kundenservice
Service Consommateurs
Servicio Al Consumidor

LEGO.com/service or dial

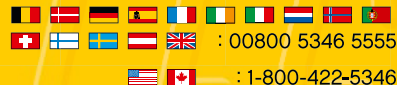
 : 00800 5346 5555
: 1-800-422-5346



duplo



Ages/
edades

1 1/2

Ages/
edades

2+



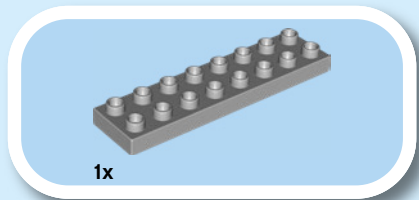

1

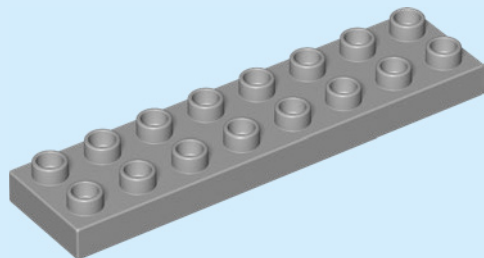

4

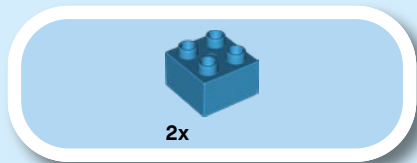

2

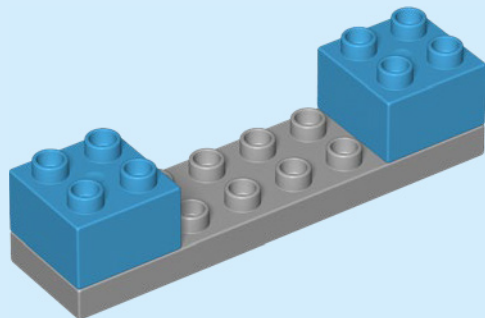

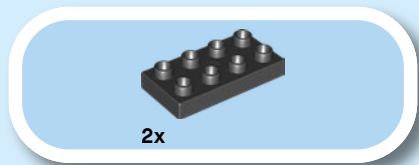

3

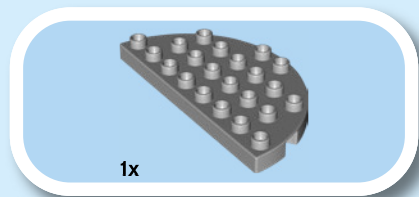
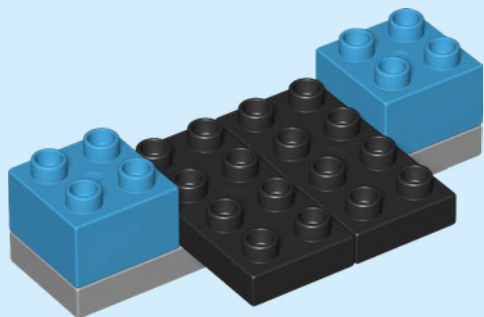

4

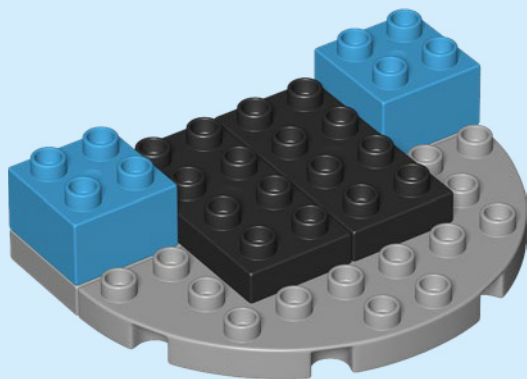

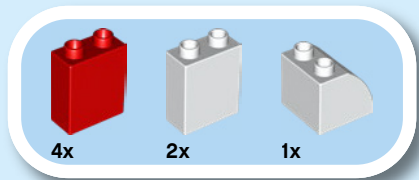

5

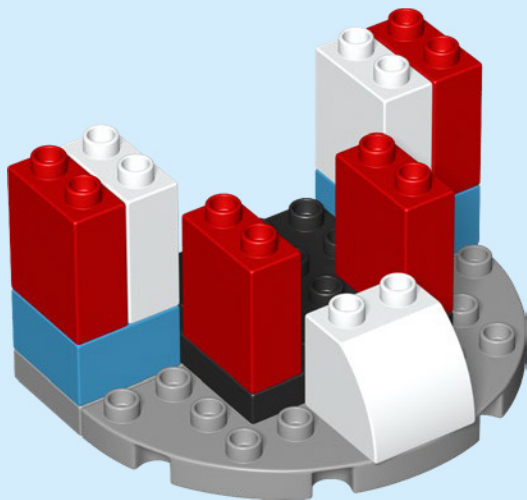

6

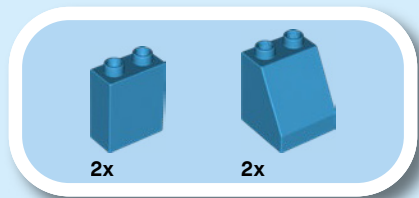

6

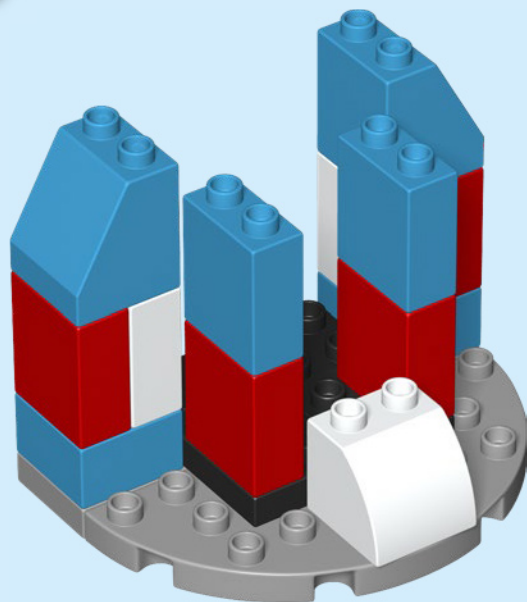

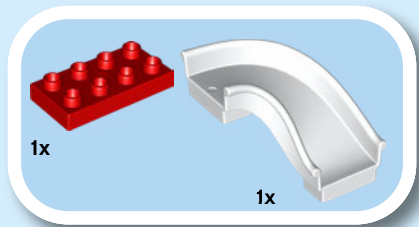

7

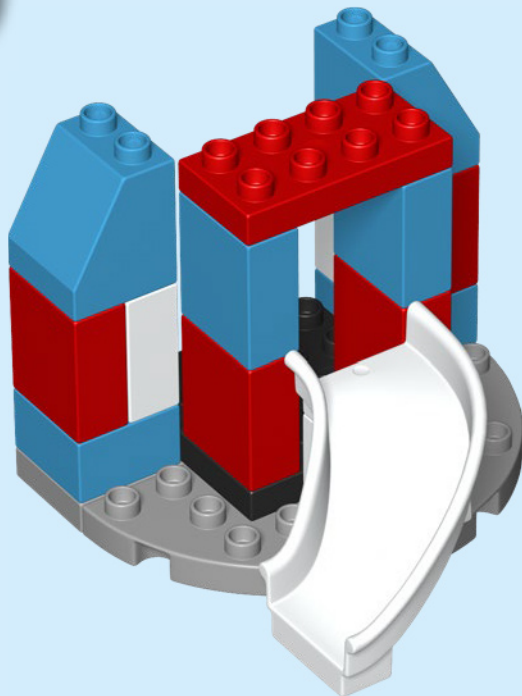

8

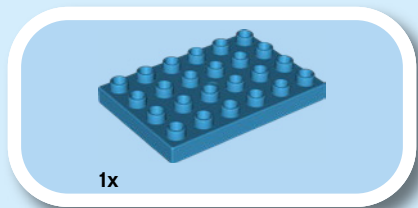

8

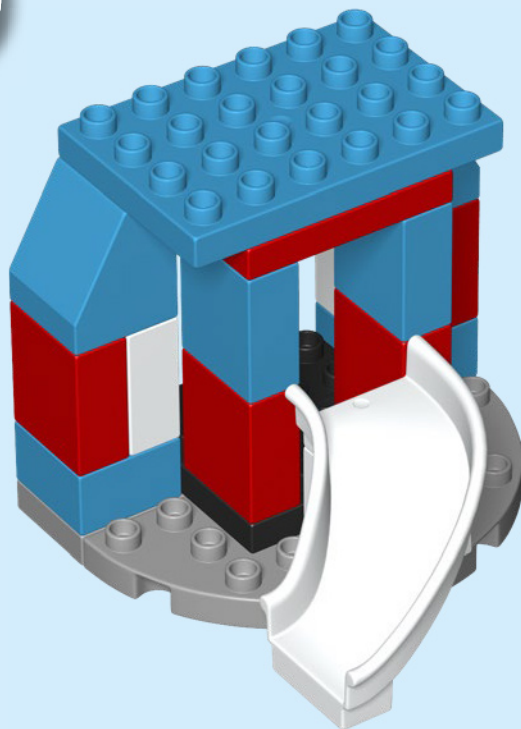

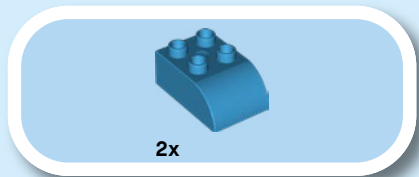

9

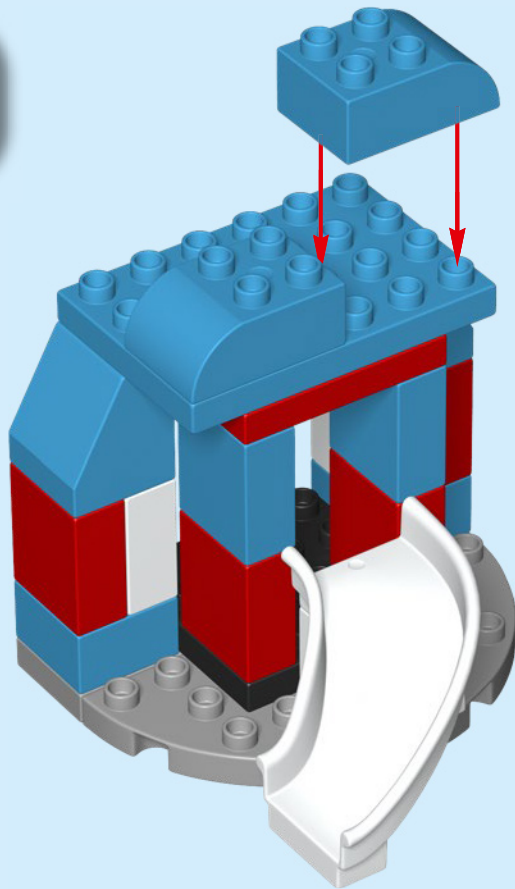

10

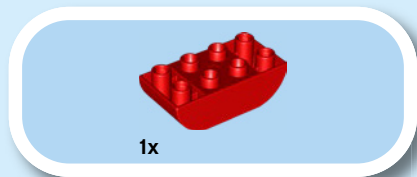

10

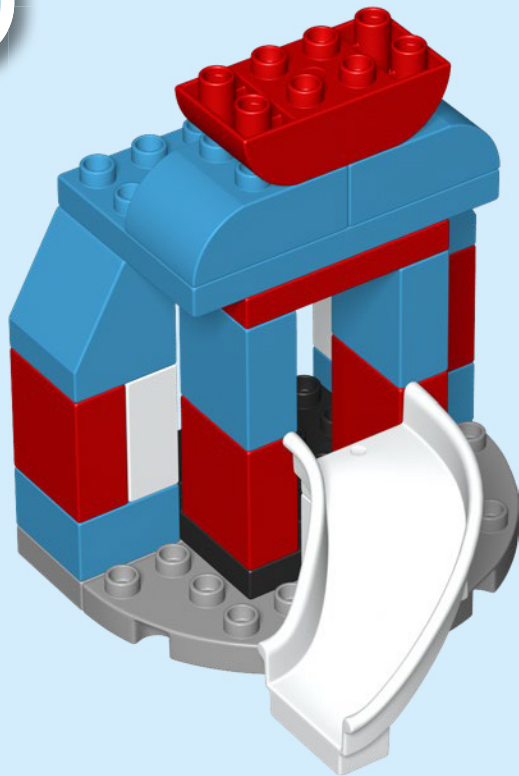

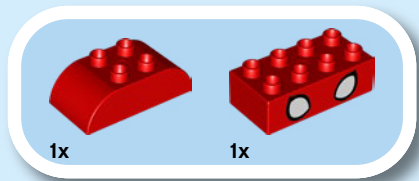

11

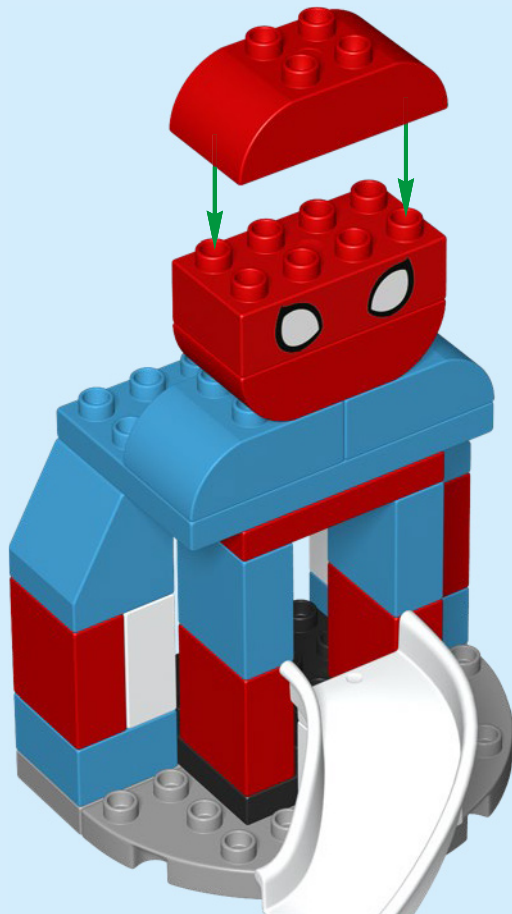

12

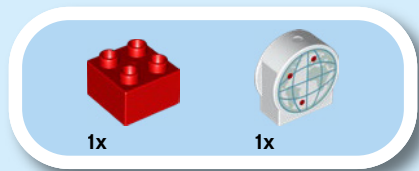

12

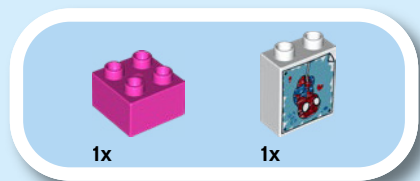
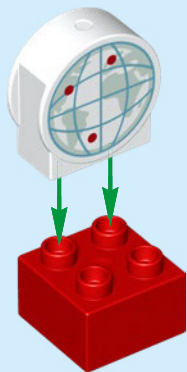

13

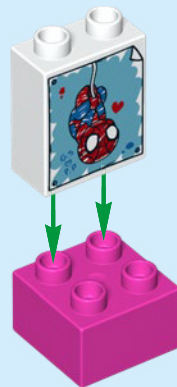

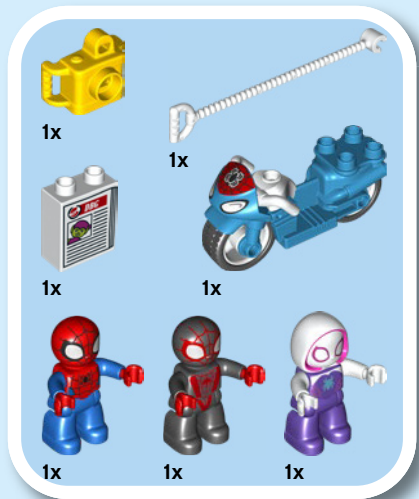

14





Customer Service

Kundenservice

Service Consommateurs

Servicio Al Consumidor

LEGO.com/service or dial



: 00800 5346 5555

: 1-800-422-5346



win
Go to www.LEGO.com/productfeedback
and give us your short
feedback about this
LEGO® DUPLO® set for a chance to win
a cool LEGO prize

Terms & Conditions apply

LEGO.com/productfeedback

GEWINNE

Erzähle uns auf
www.LEGO.com/productfeedback

etwas über die Erfahrungen, die du
mit diesem LEGO® Set gemacht hast,
und sichere dir die Chance auf einen
coolen LEGO Preis!

Es gelten die Teilnahmebedingungen

GAGNE

Rends-toi sur
www.LEGO.com/productfeedback

et donne-nous quelques commen-
taires sur ce produit LEGO® pour
avoir une chance de gagner un
prix LEGO !

Voir Conditions Générales

GANAN

Visita
www.LEGO.com/productfeedback

y envíanos tu opinión acerca de este
set LEGO®. ¡Participarás en el sorteo
de un premio LEGO!

Términos y Condiciones aplicables

获取奖品

登录
www.LEGO.com/productfeedback

给出关于此乐高®套装的简短反
馈，就有机会获得炫酷乐高奖品

《条款及条件》适用

LEGO, the LEGO logo, DUPLO and the DUPLO logo are trademarks of the/sont des marques de commerce du/son marcas registradas de LEGO Group.
©2021 The LEGO Group. All rights reserved/Tous droits réservés/Todos los derechos reservados.

© 2021 MARVEL

6371729