



CITY



60186





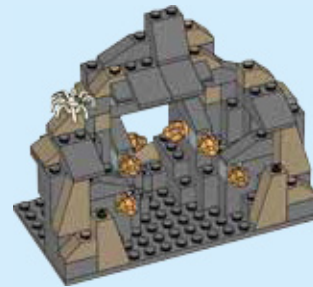
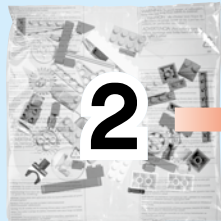
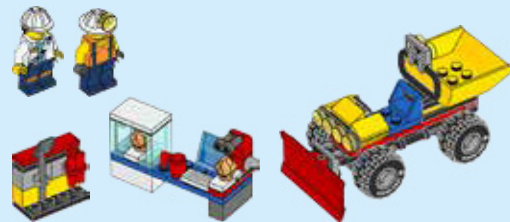

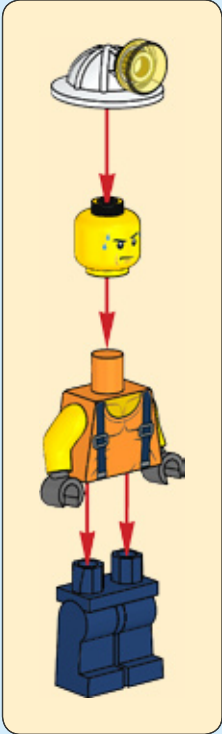
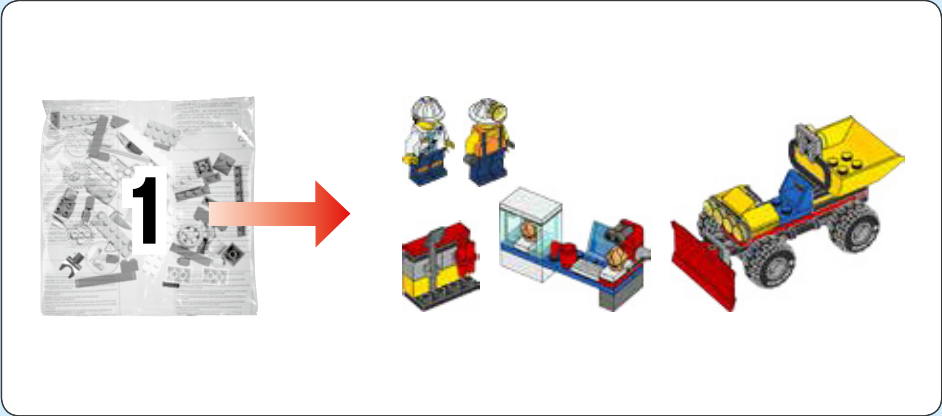

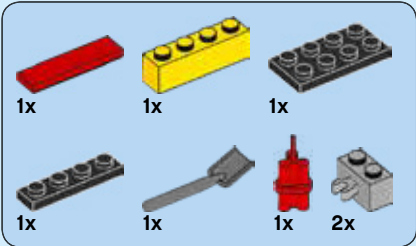

1

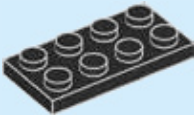

2

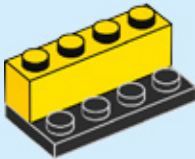

3

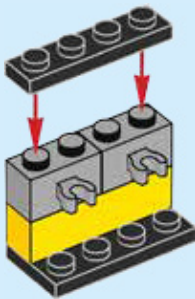

4

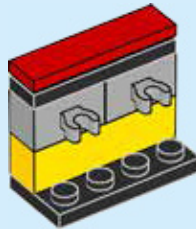

5

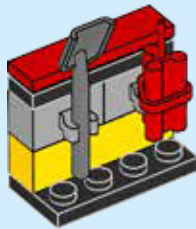

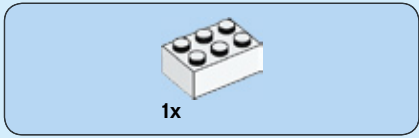
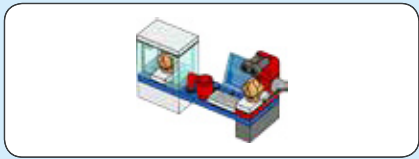

1



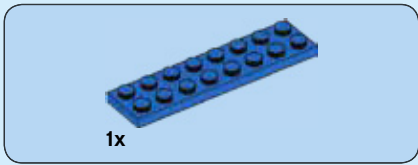

2

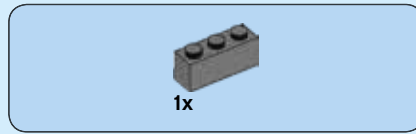
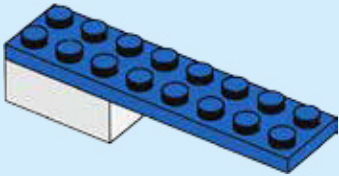

3

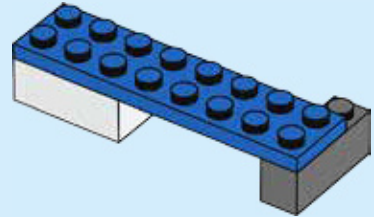



1x

4

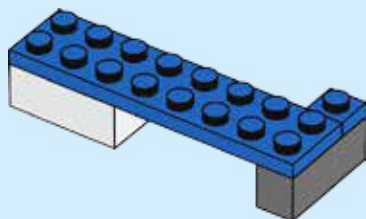



1x



1x

5

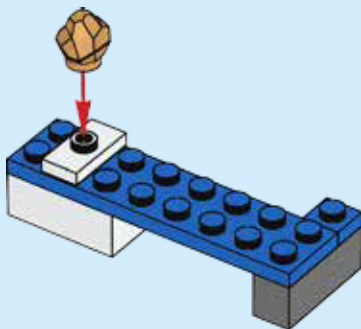

2x

6

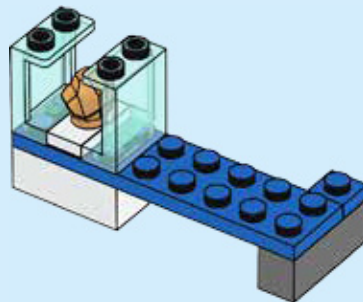



1x

7

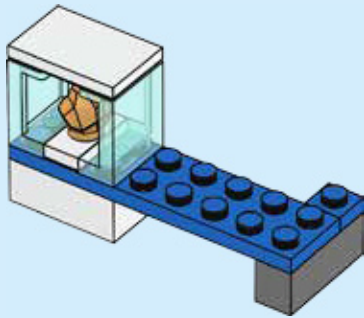

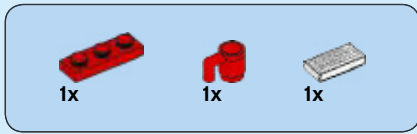

8

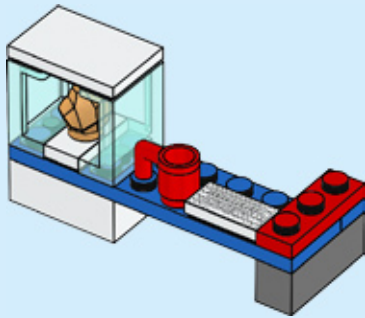

9

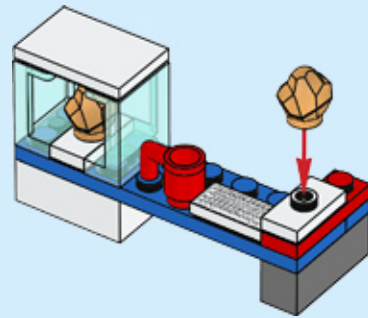

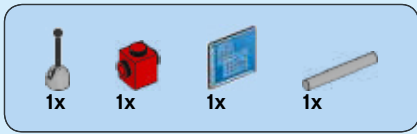

10

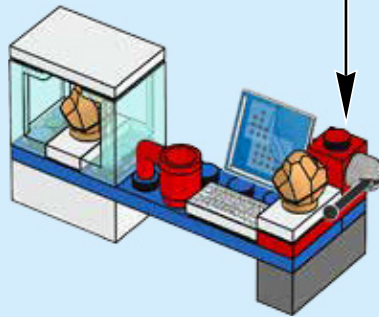
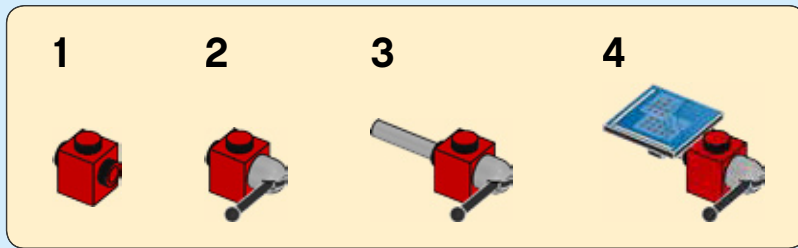



1x

11

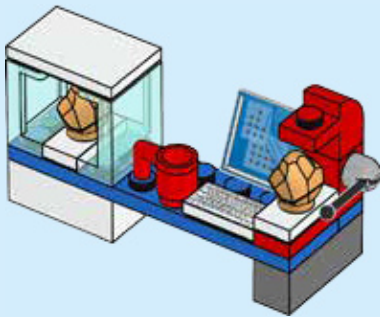

1x

12

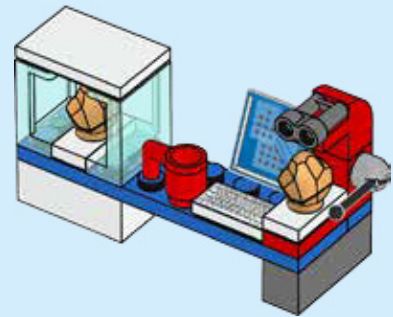

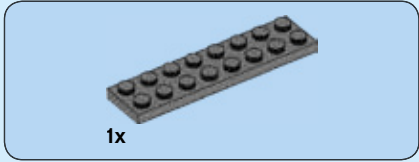
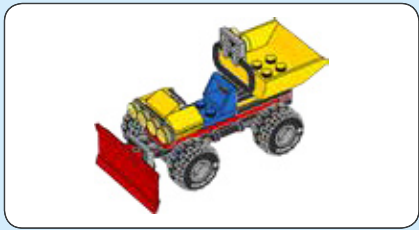

1

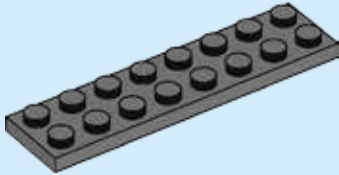



2

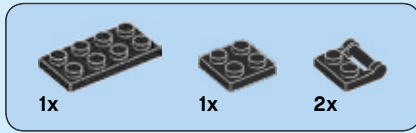
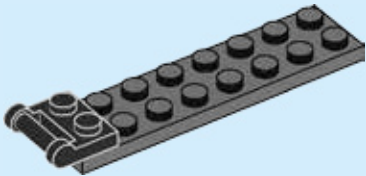

3

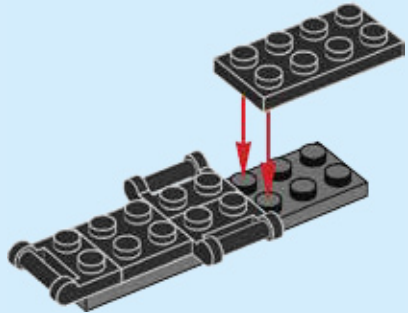

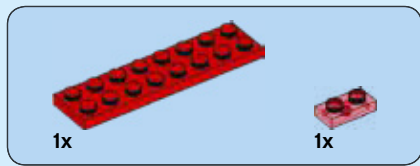

4

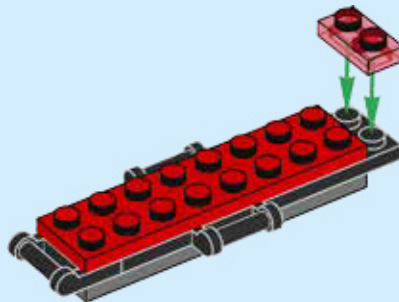



5

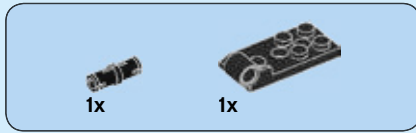
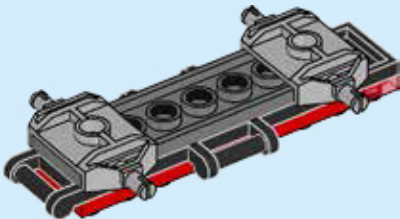
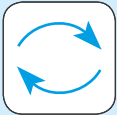

6

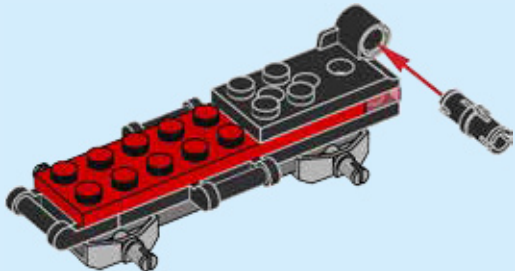
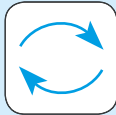



1x

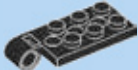

1x

7

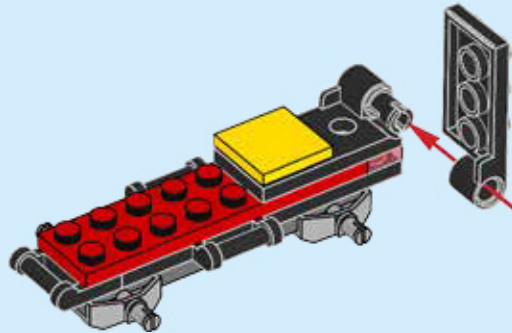

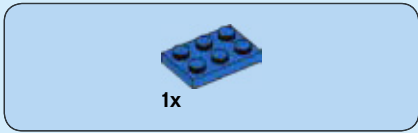

8

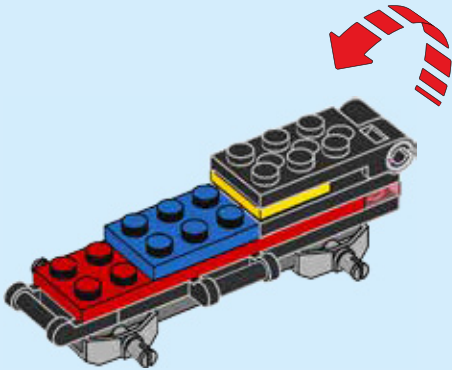

9

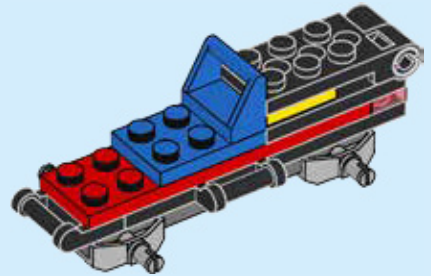

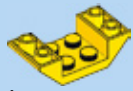

1x

10

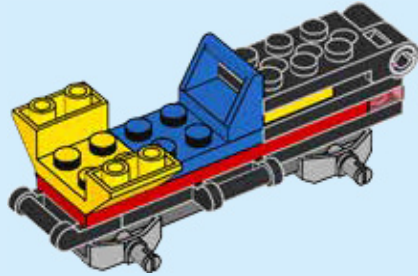



11

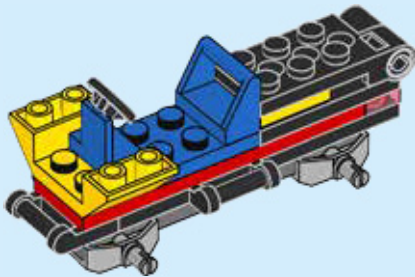

12

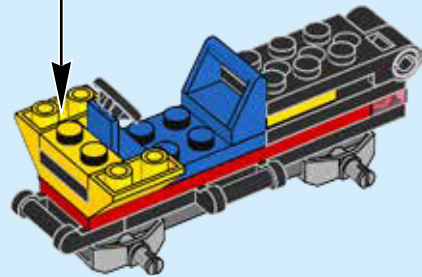
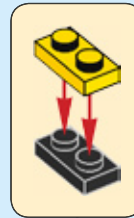



1x

13

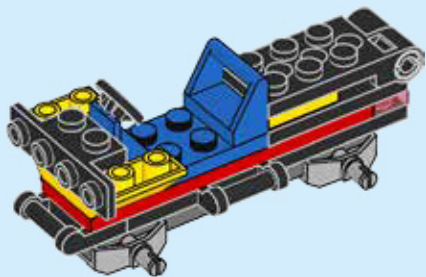



3x

14

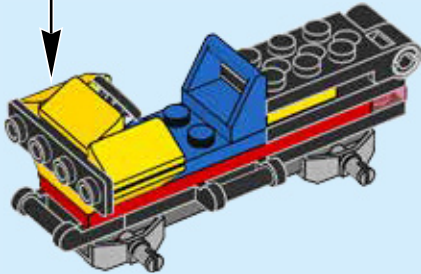
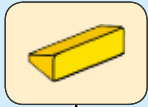

4x

15

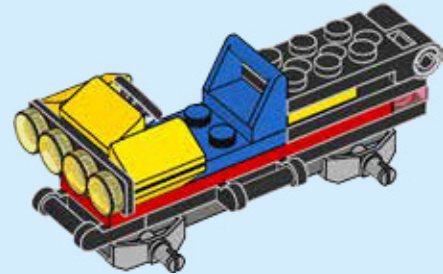



1x

16

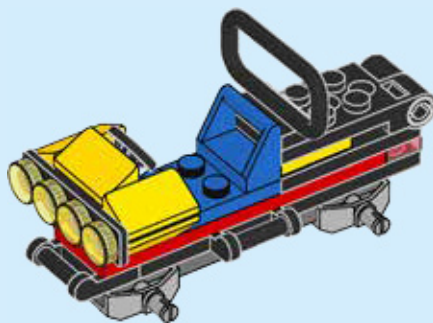

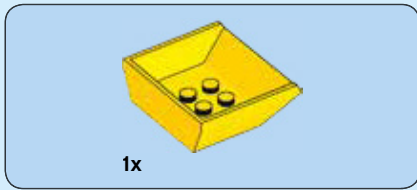

17

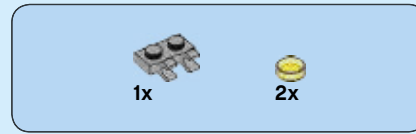
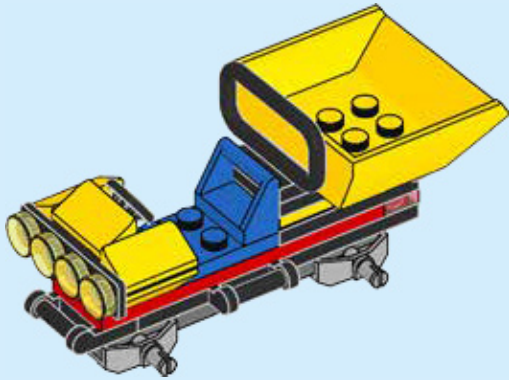

18

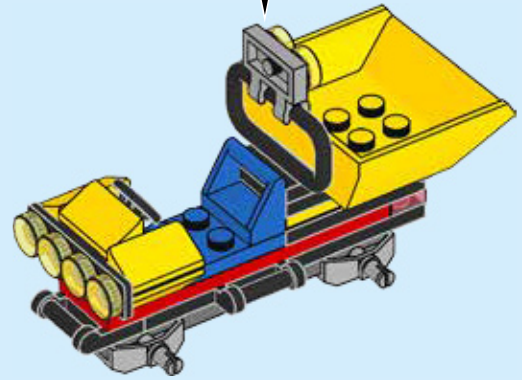
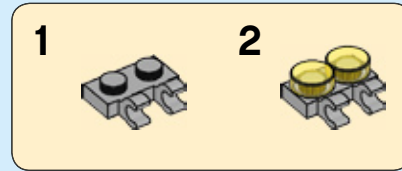

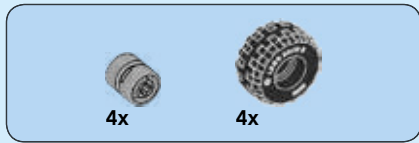

19

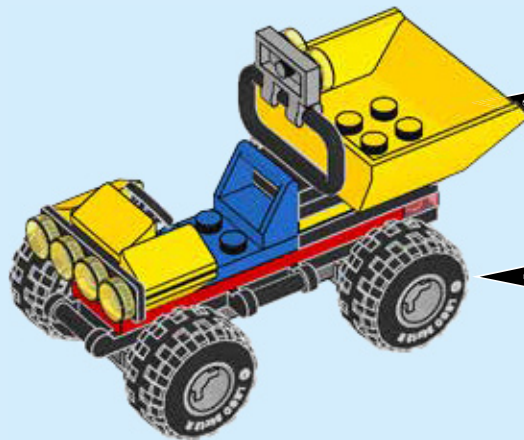
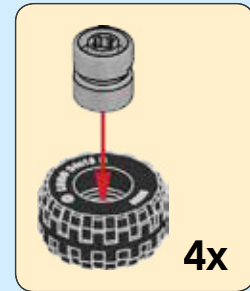

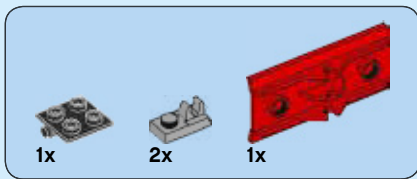

20

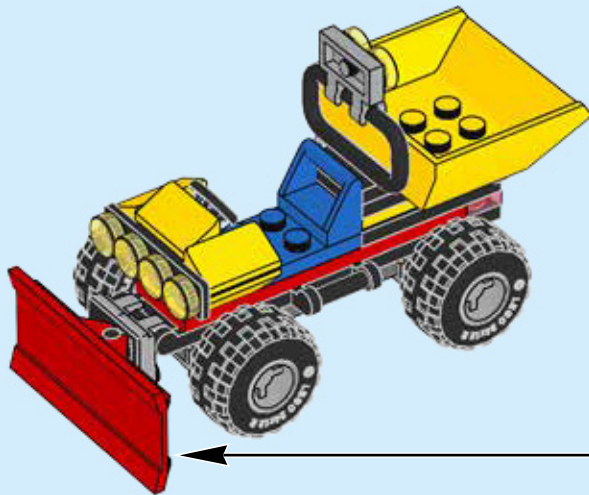
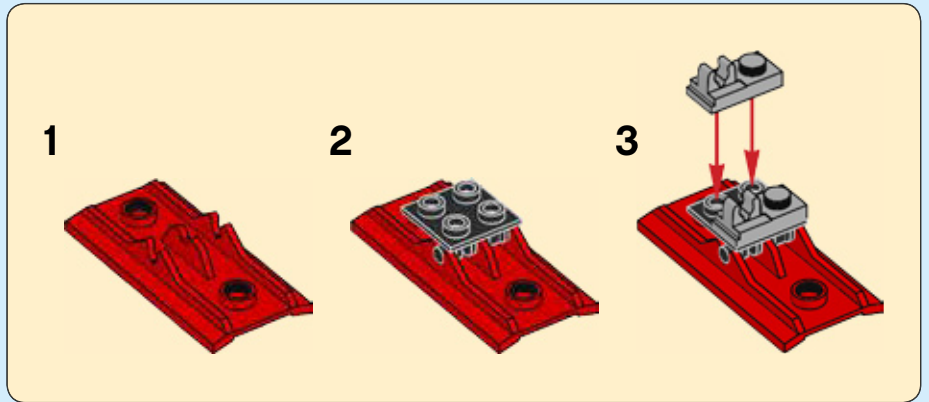

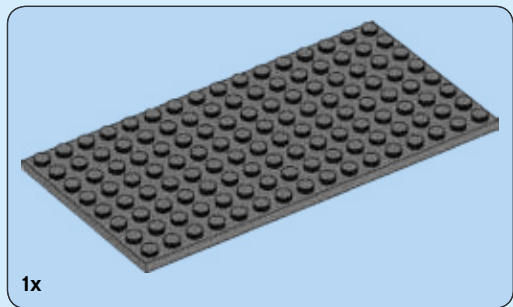
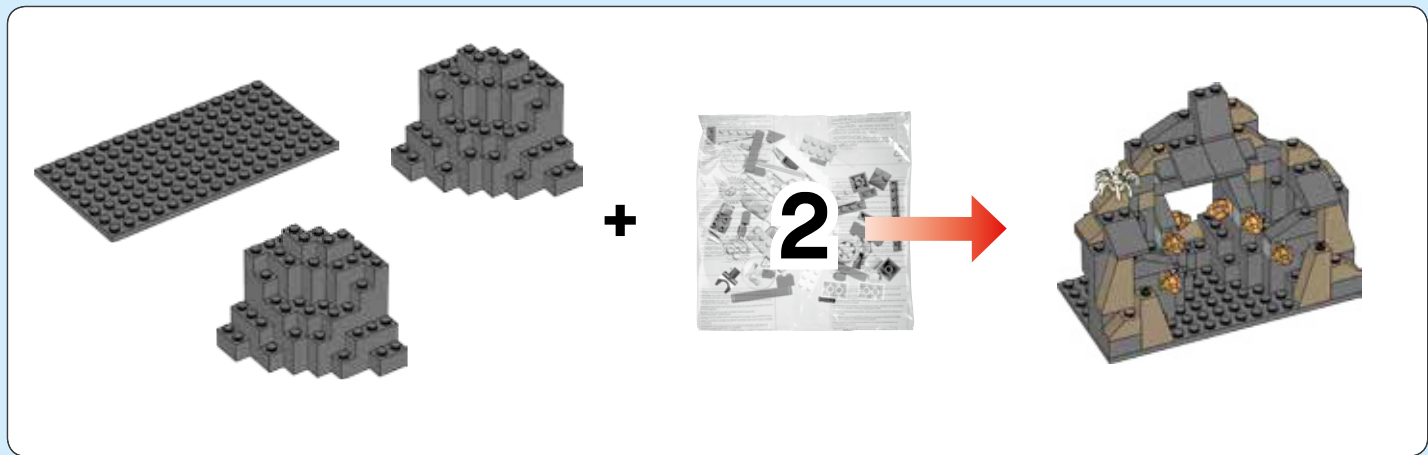

1

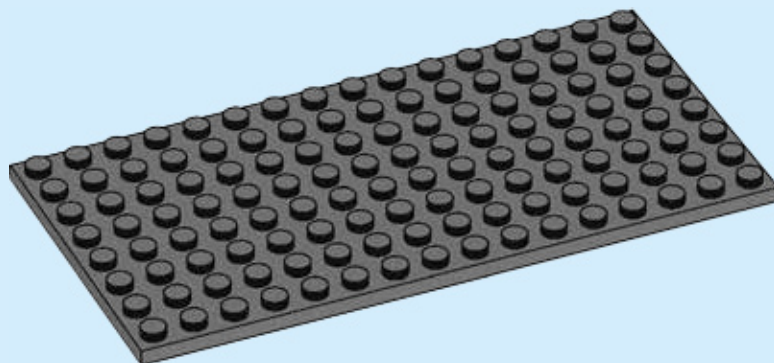

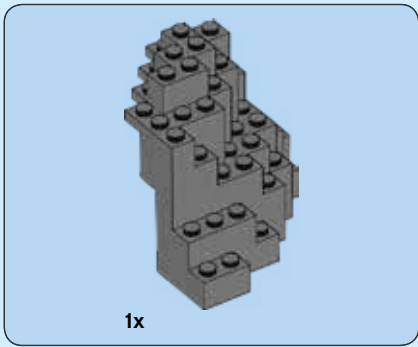

2

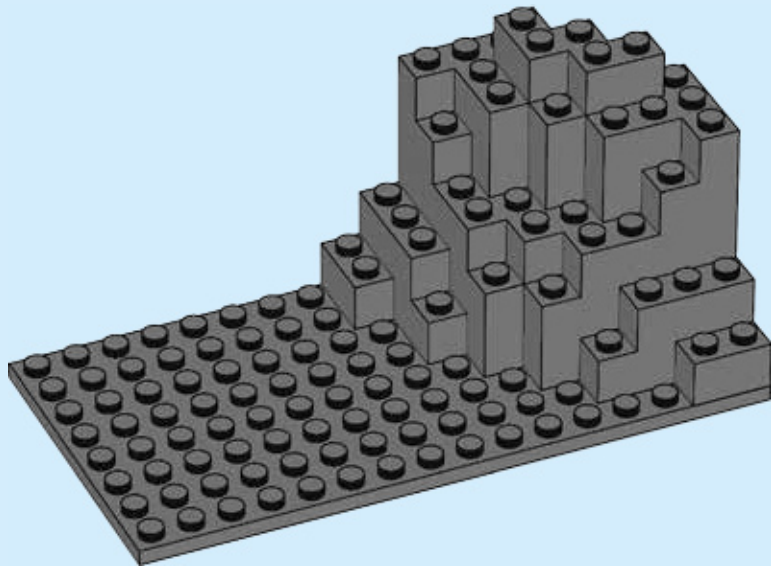

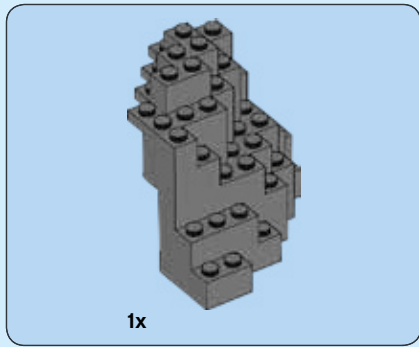

3

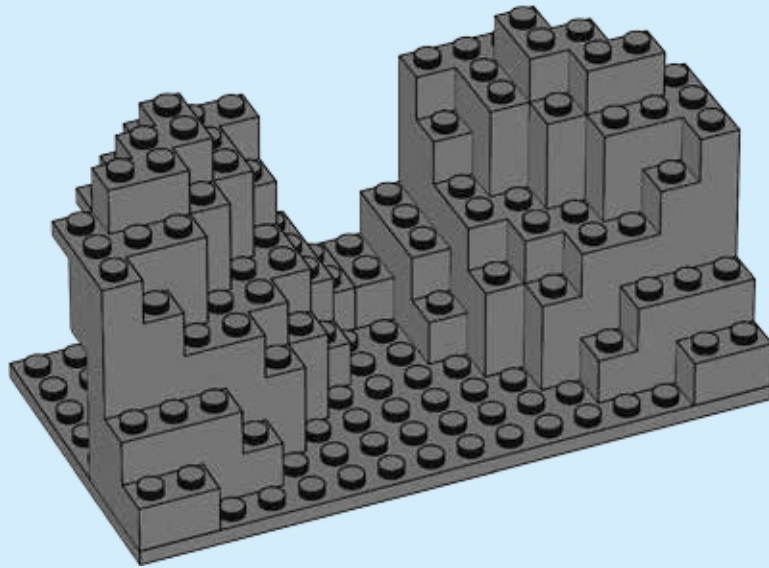



4

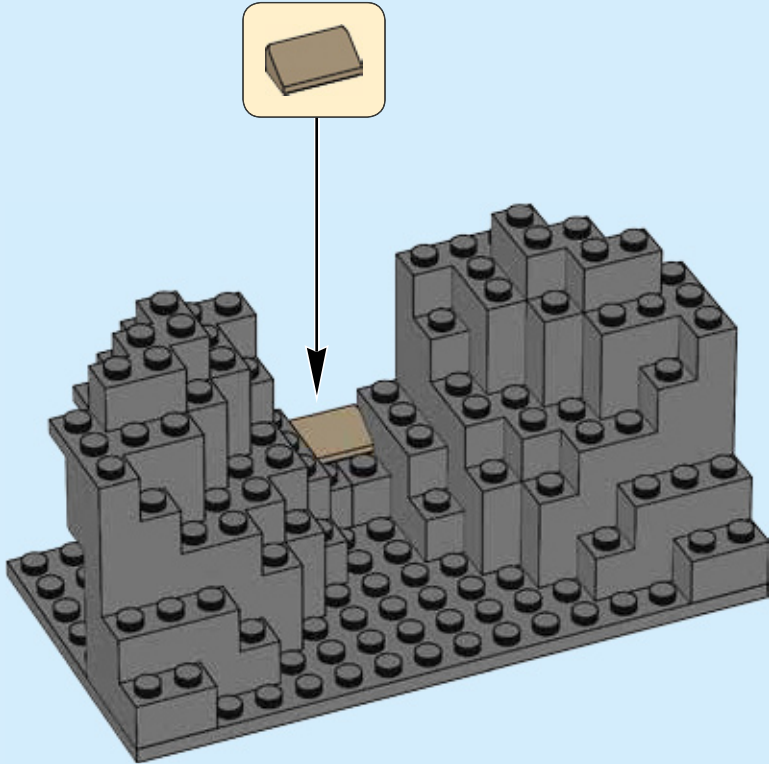



6x



6x

5

1



2



6x

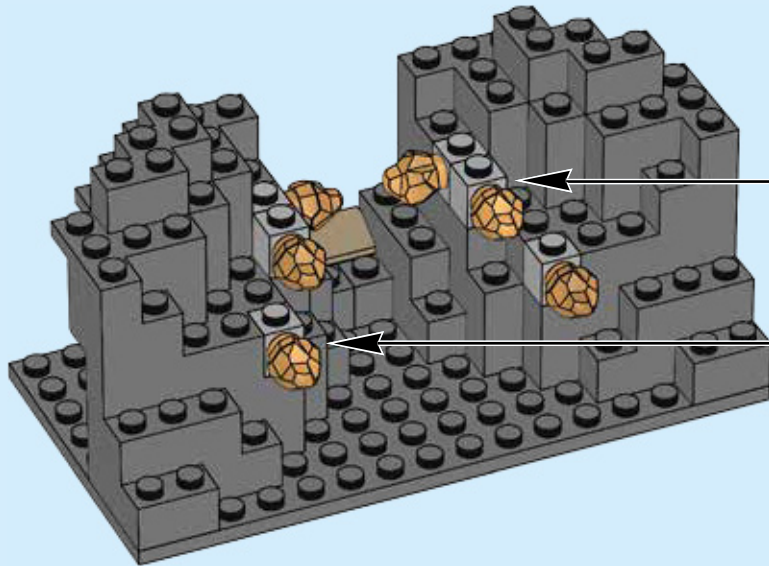



4x

6

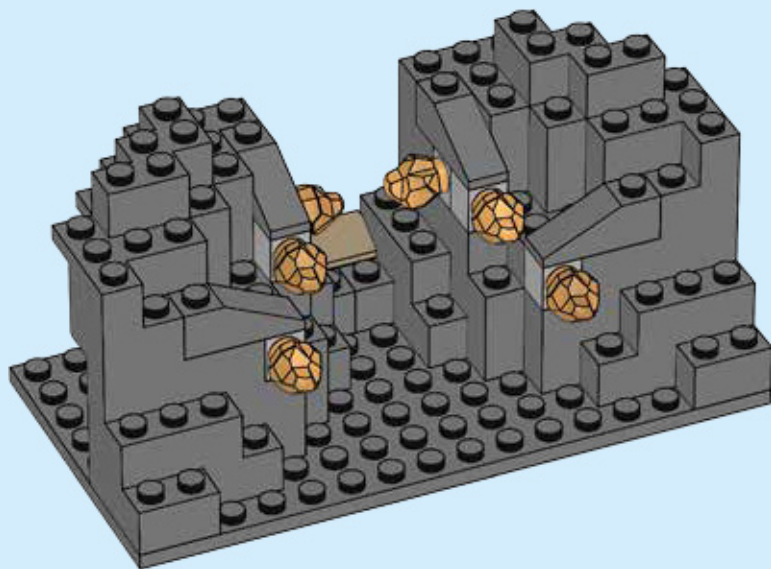

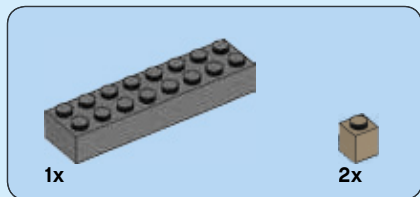

7

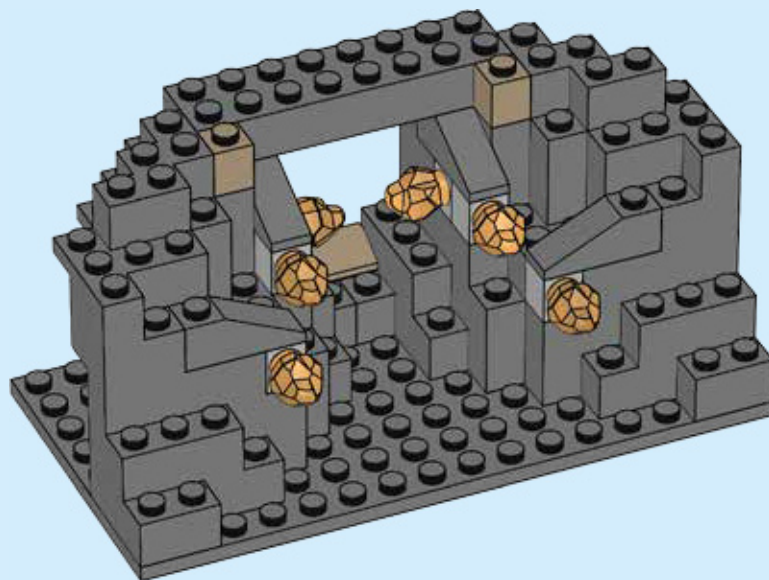

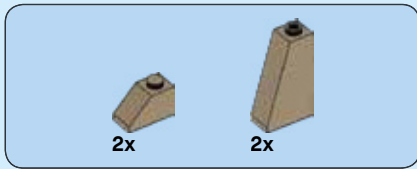

8

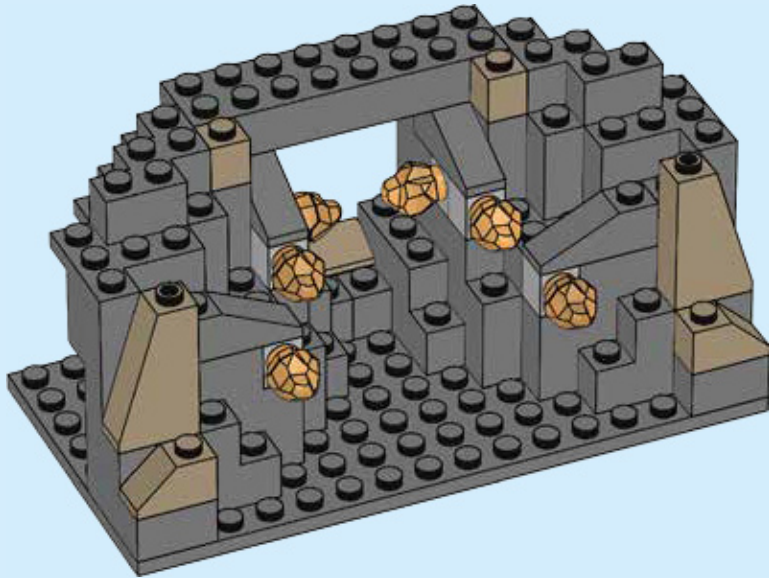



9

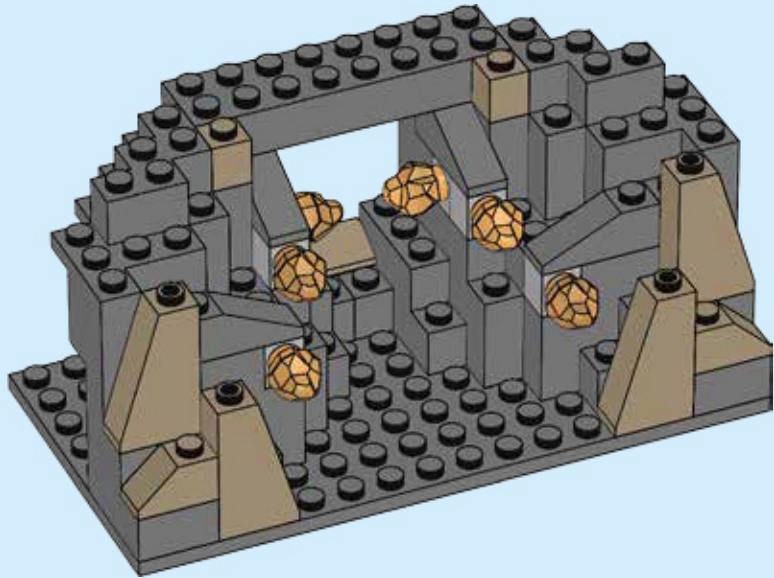



2x

10

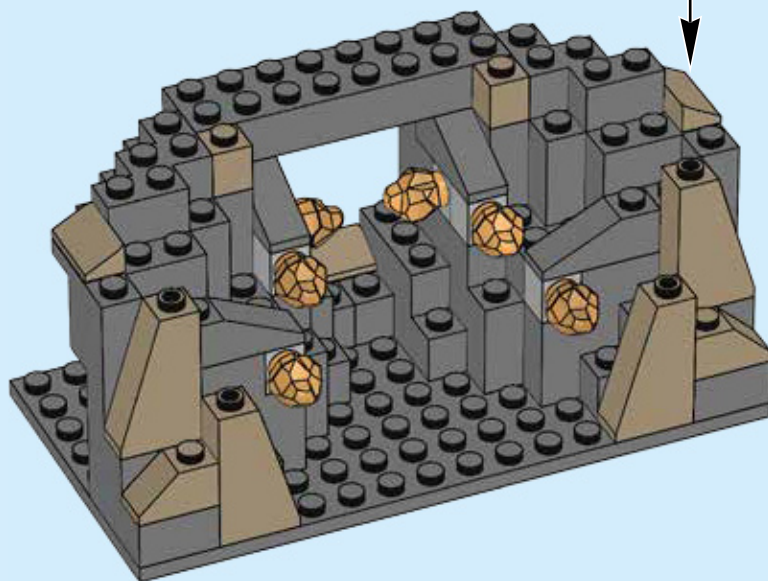
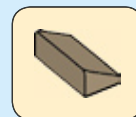



2x

11

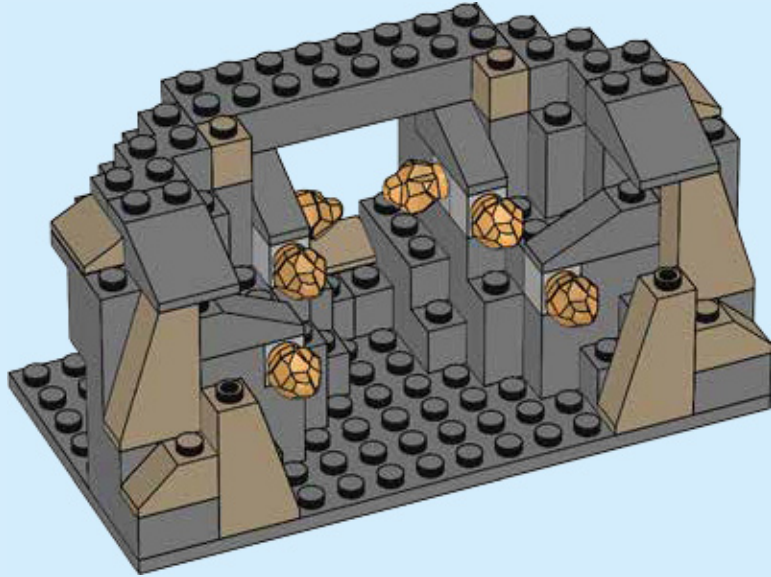

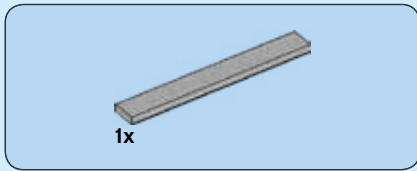

12

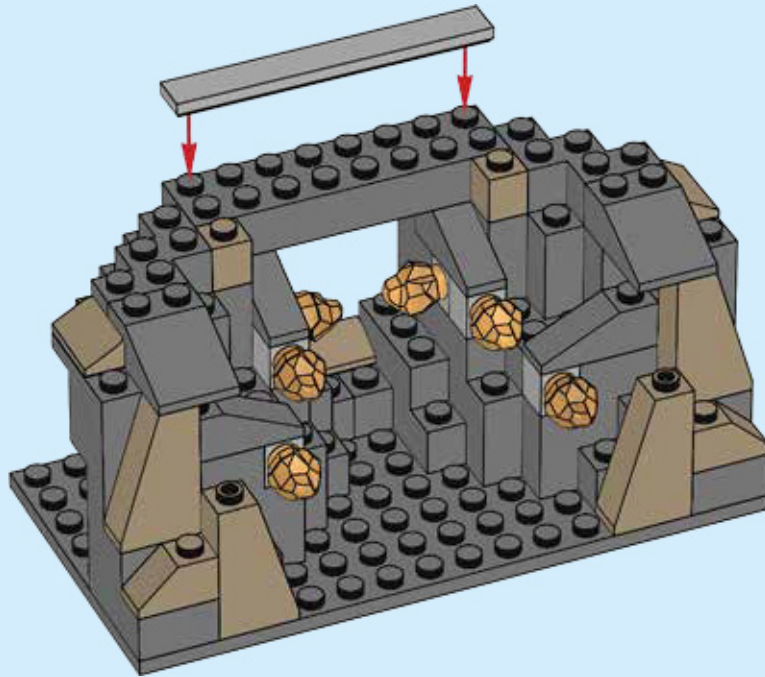



2x

13

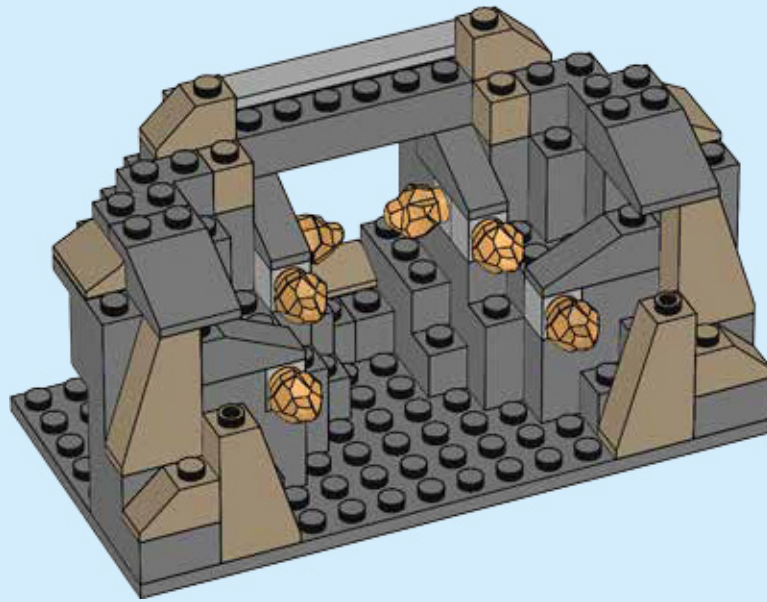



2x

14

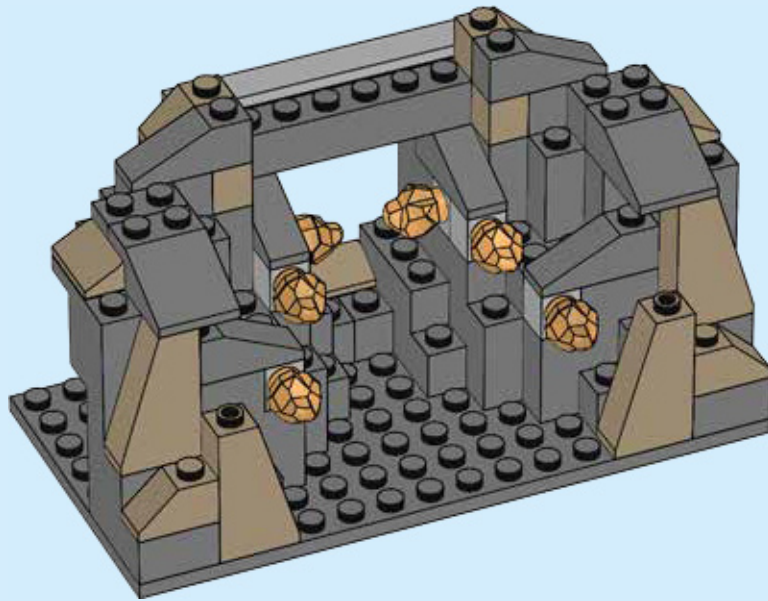



2x

15

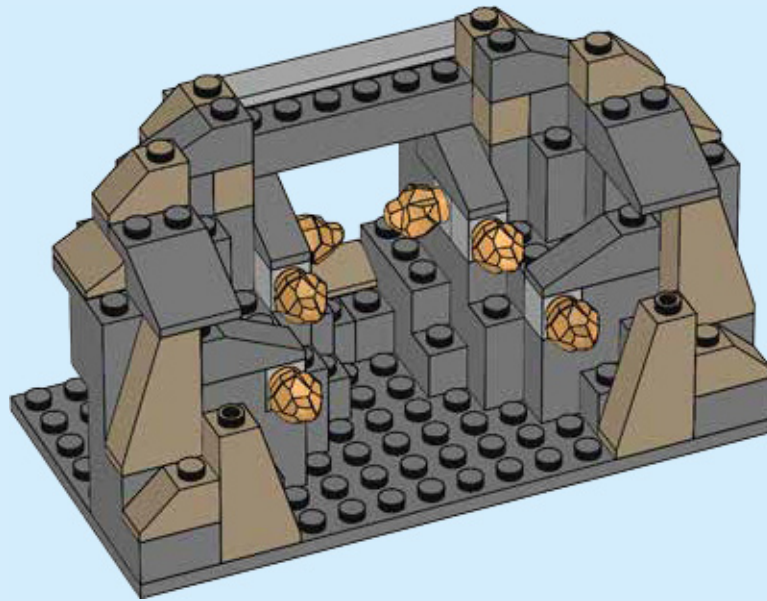



3x

16

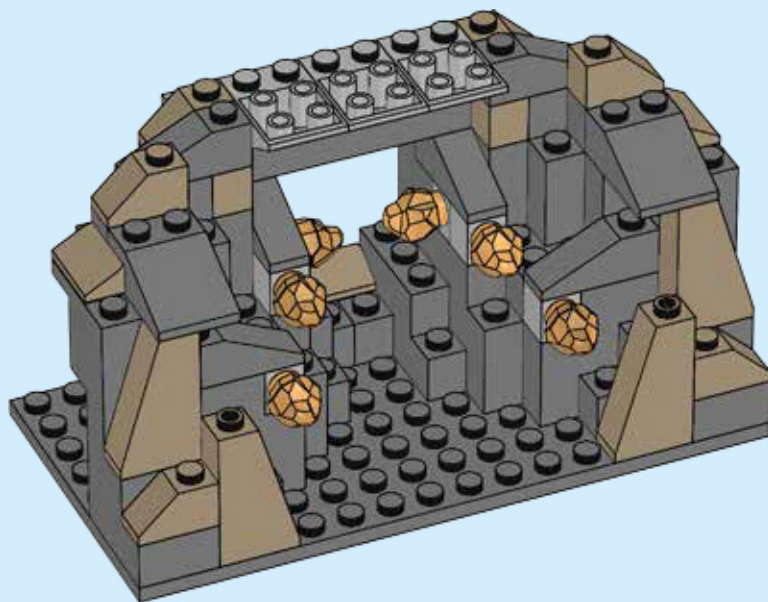

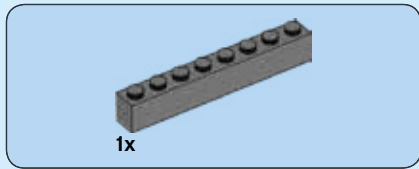

17

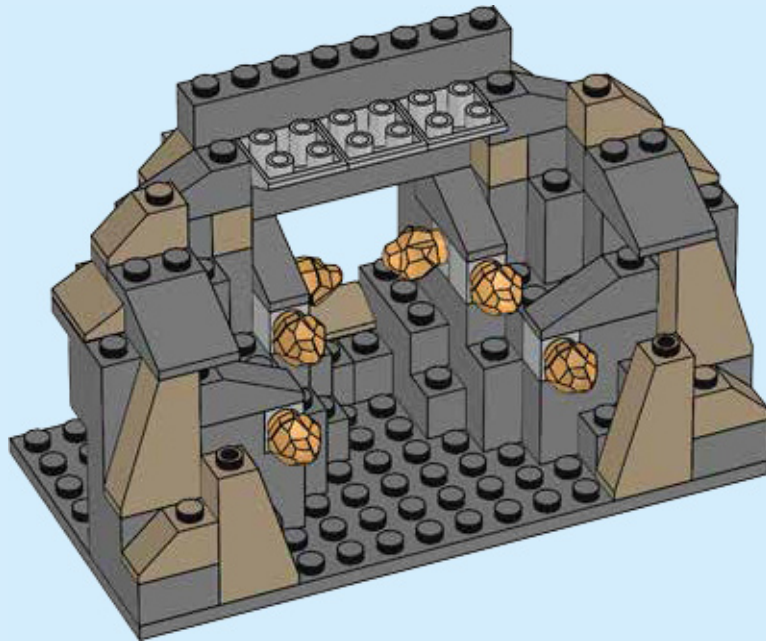

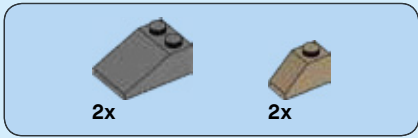

18

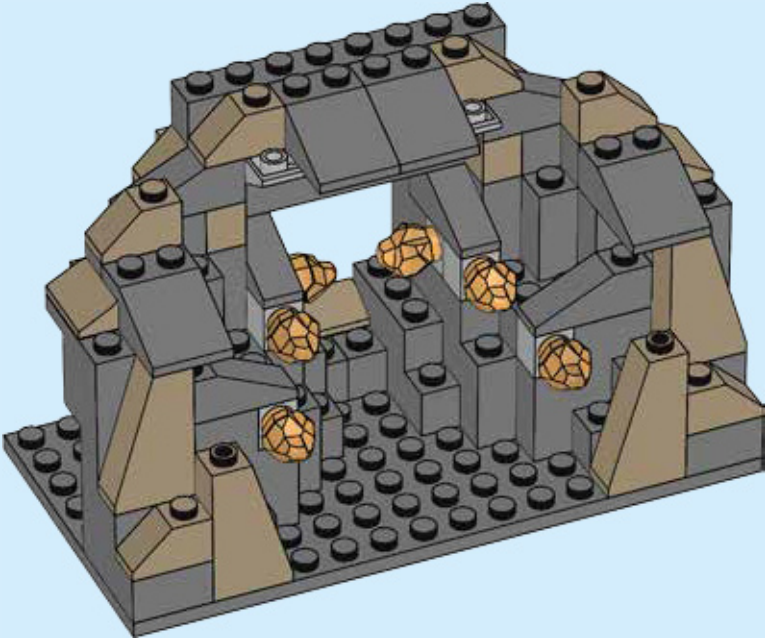



2x

19

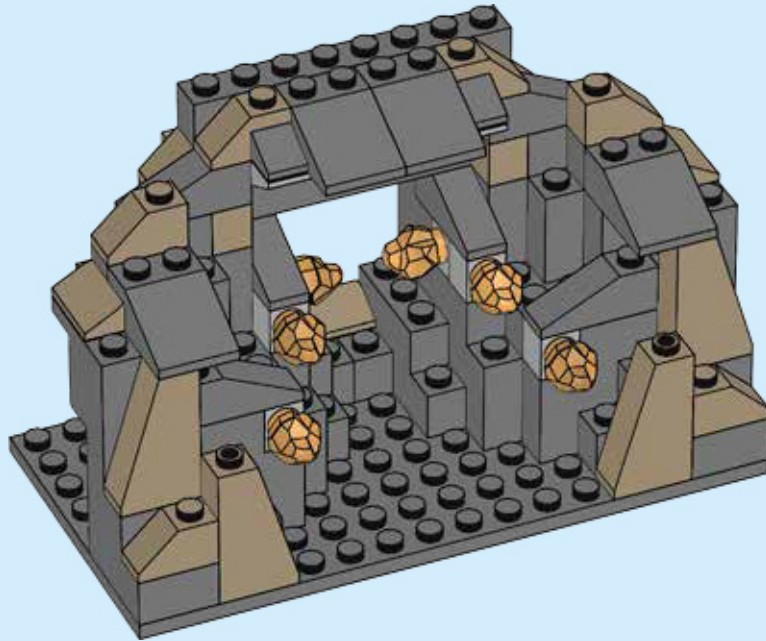



1x

20

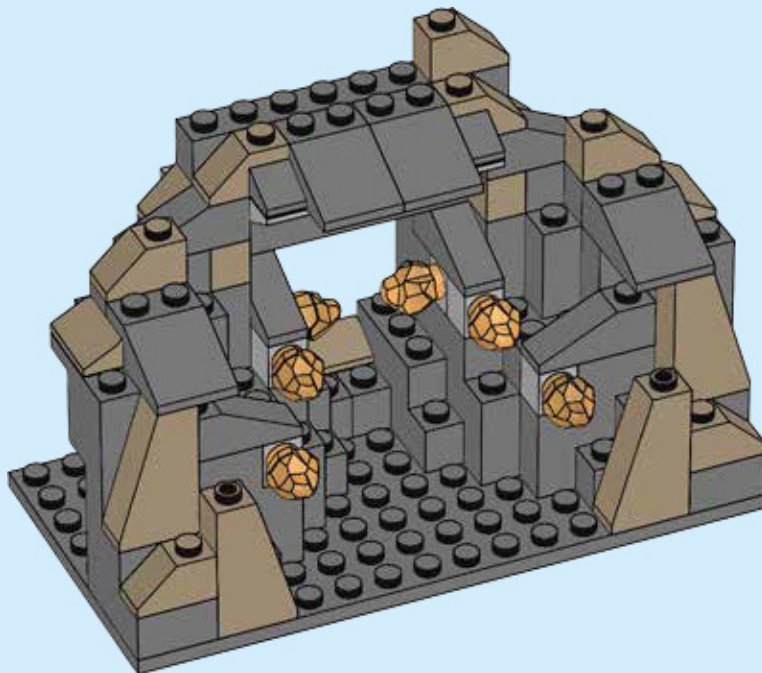

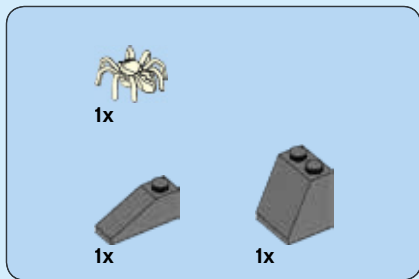

21

