

LEGO

NINJAGO

Masters of Spinjitzu



70622



7

LEGO.com/NINJAGO



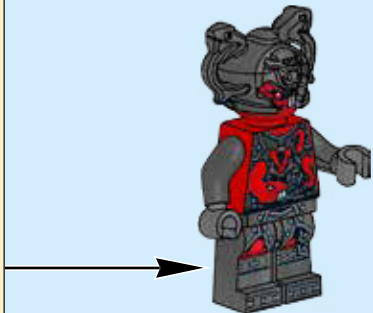
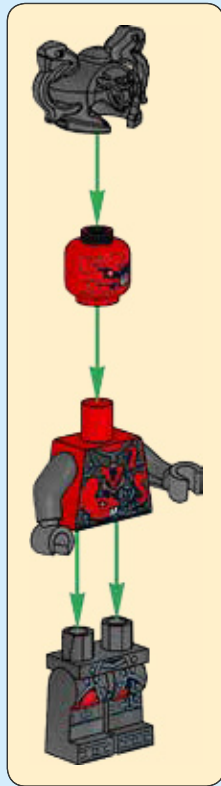

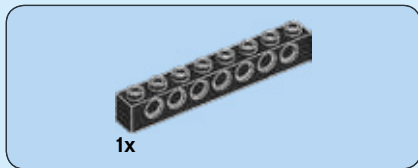
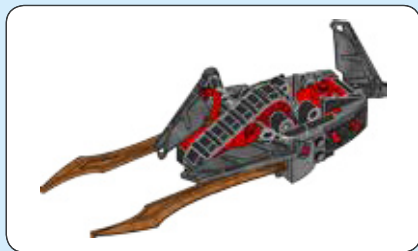

1

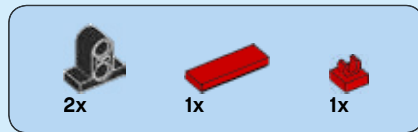
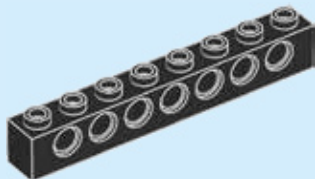

2

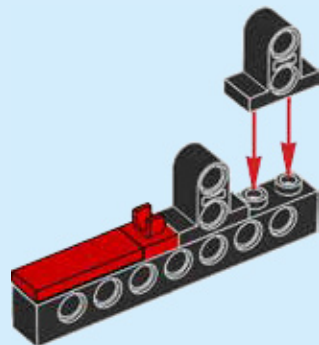



2x

3

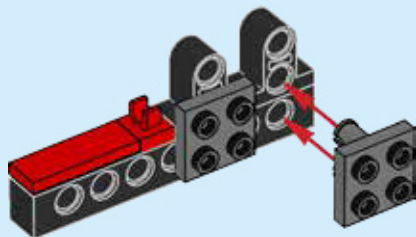

4



1x



1x



1x

4

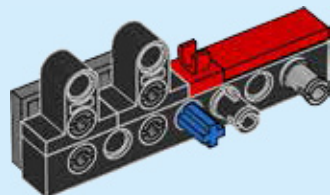
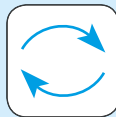



2x

5

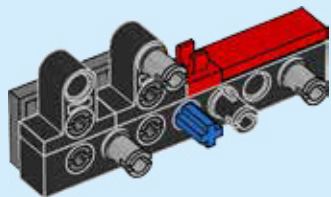

1x



1x

6

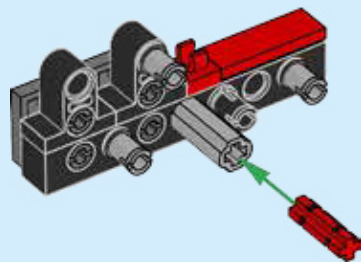



7

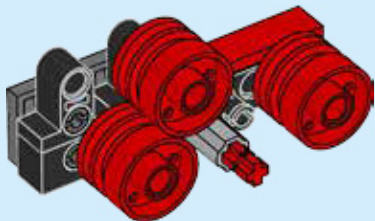

6



8

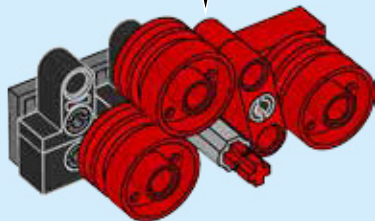
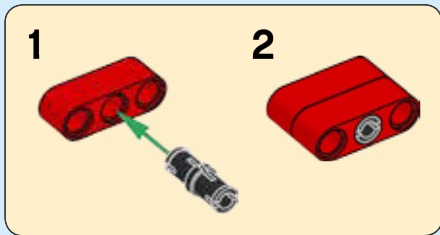



1x



3x

9

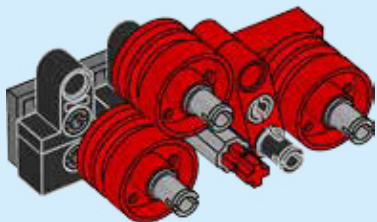

1x

10

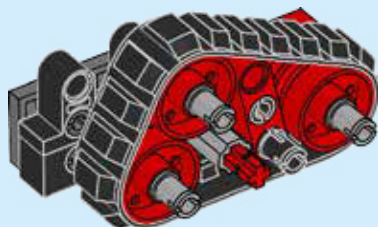

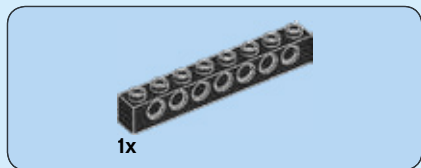

11

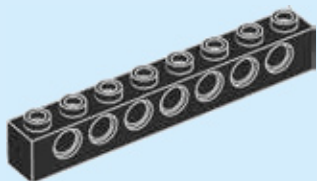

8

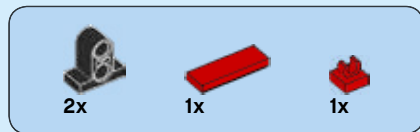

12

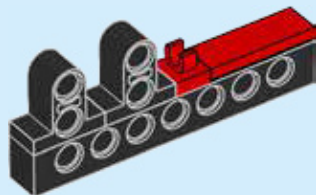



2x

13

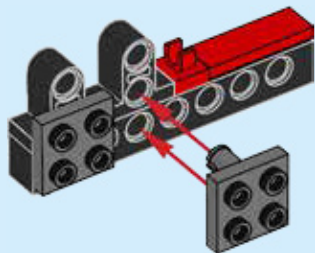

14

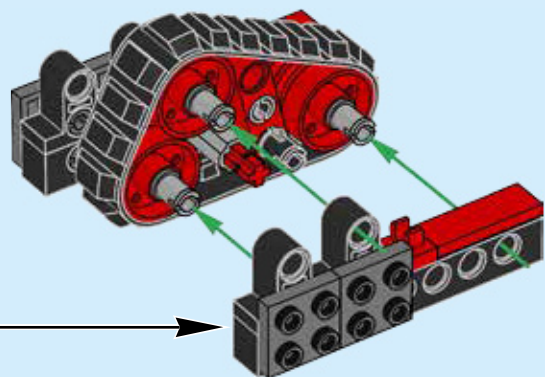



1x

15



2x

16





1x



1x

17

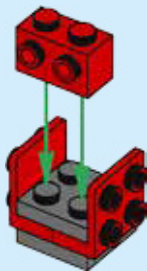

1x



2x



1x

18



1



2



3





1x

19

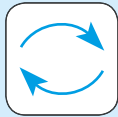

1x



1x

20

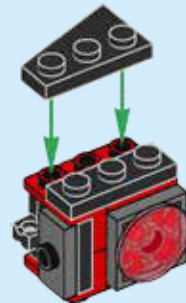

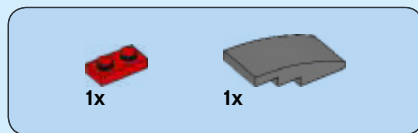

21

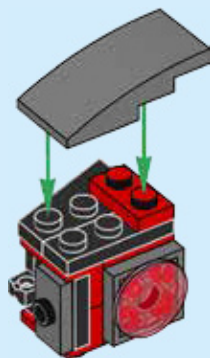

22

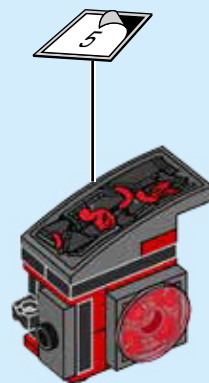

23

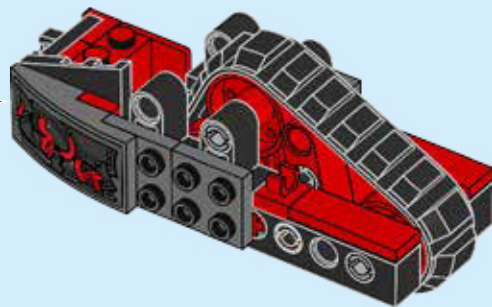

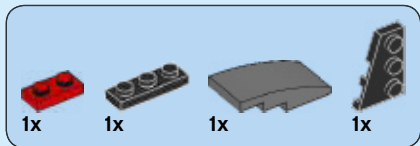

24

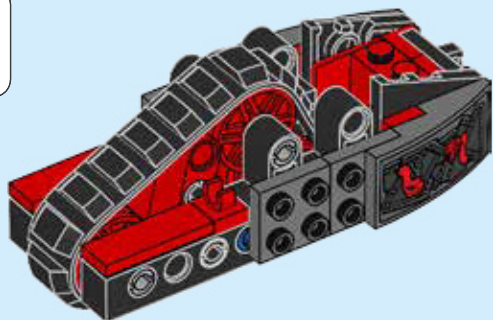
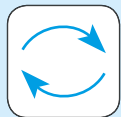
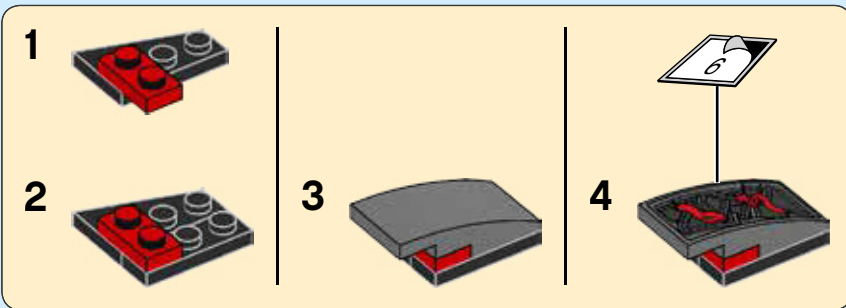

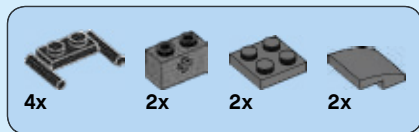

25

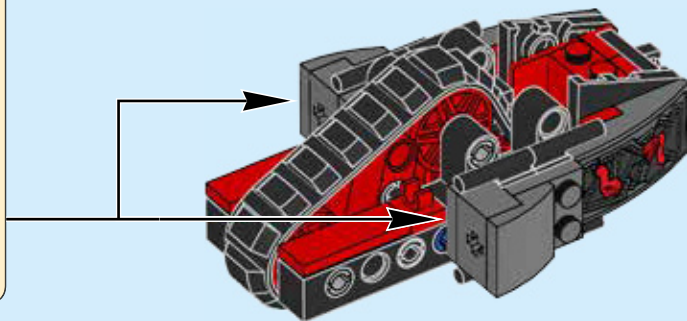
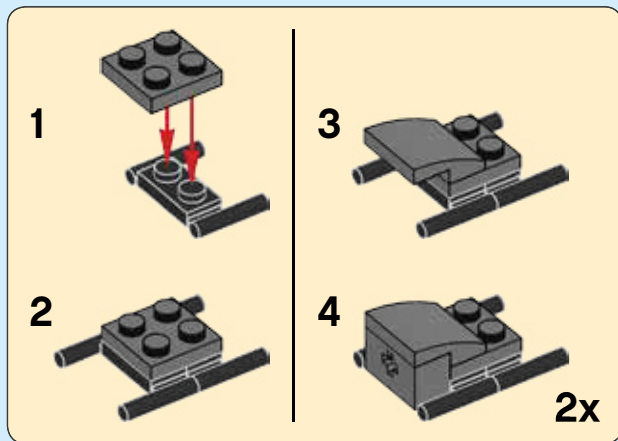

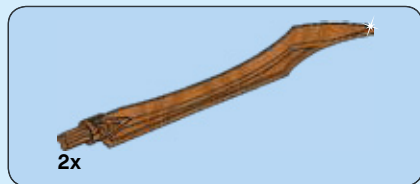

26

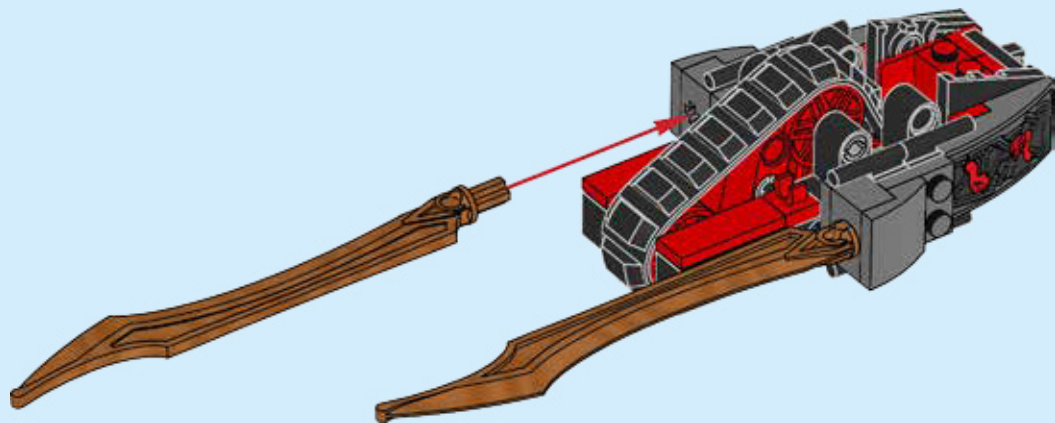



2x

27



2x

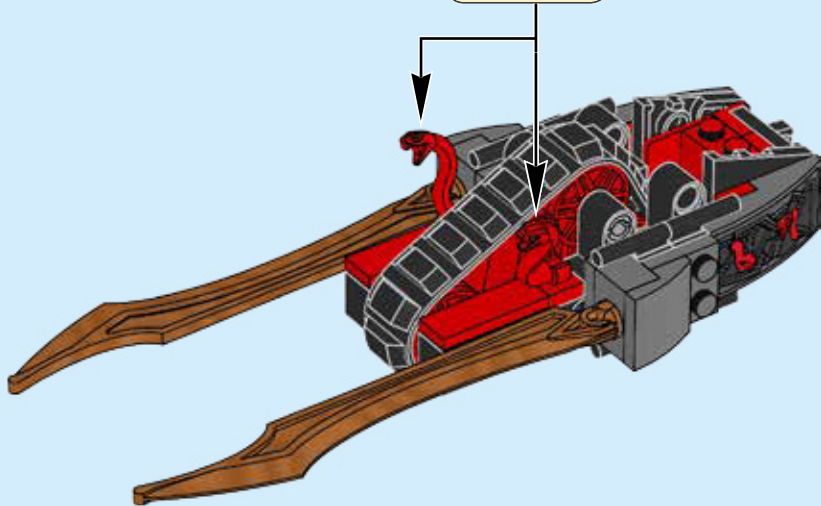

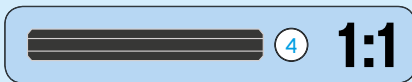
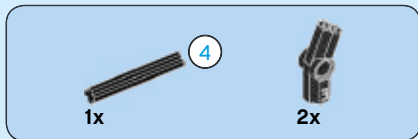

28

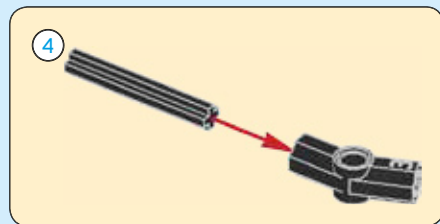
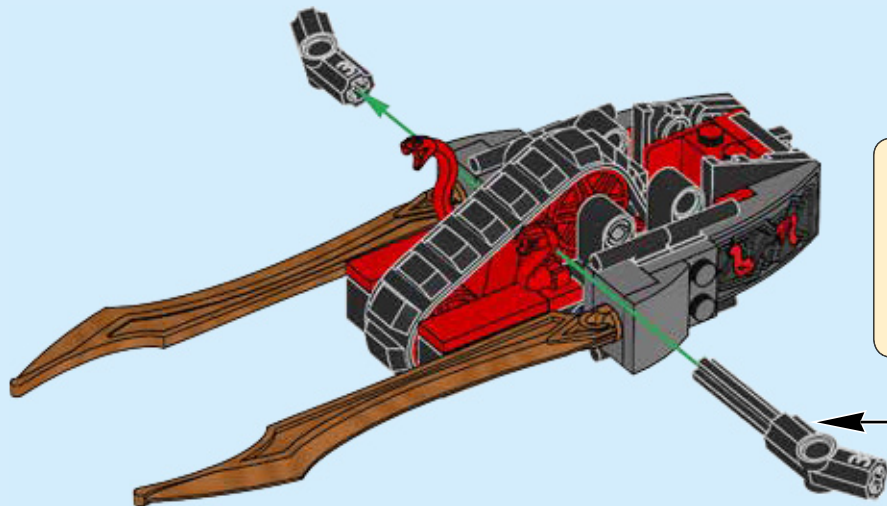



2x

29

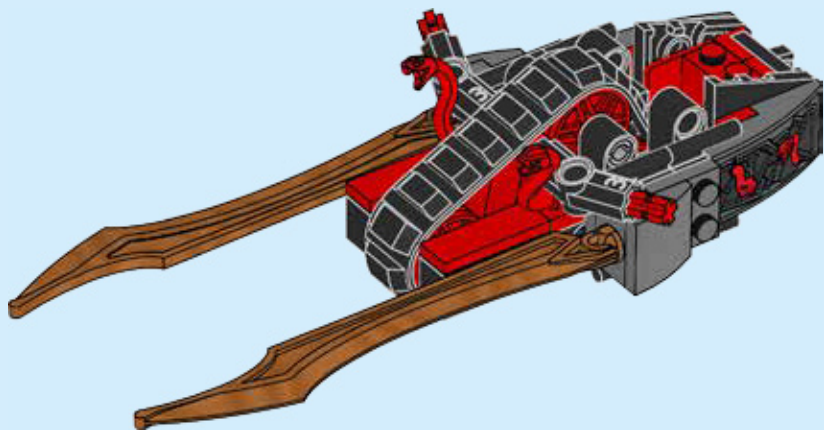

20

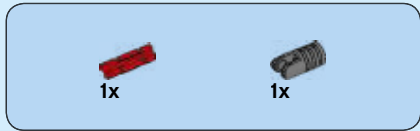

30

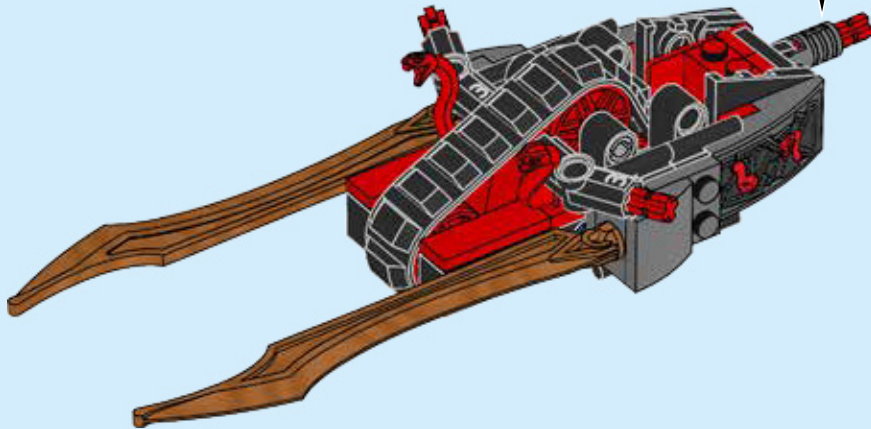
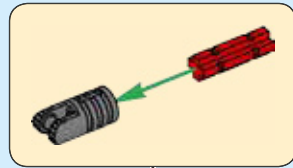

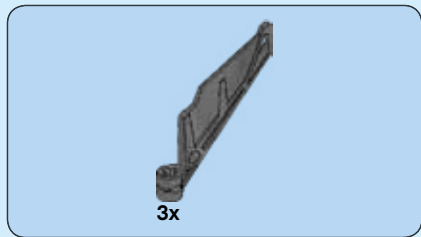

31

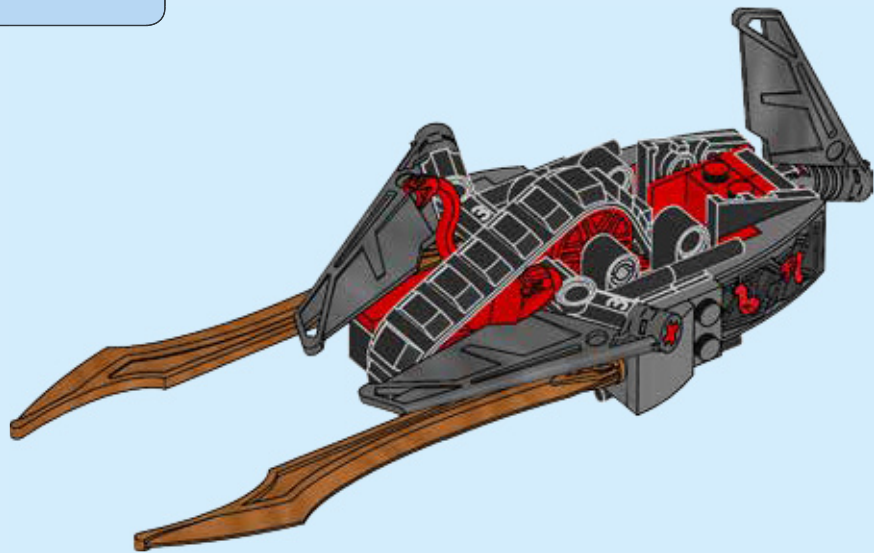



LEGO

NINJAGO

Masters of Spinjitzu





NINJAGO

Masters of Spinjitzu



LEGO.COM/NINJAGO

The LEGO logo is displayed in its characteristic white font with a black outline, set against a red square background.

NINJAGO

Masters of Spinjitzu



LEGO.COM/NINJAGO



Download on the
App Store



ANDROID APP ON
Google play

Ask parents' permission first.
Demande d'abord l'autorisation d'un parent.
Pide antes permiso a tus padres.

Apple and the Apple logo are trademarks of Apple Inc.,
registered in the U.S. and other countries. App Store is
a service mark of Apple Inc.

Google Play is a trademark of Google Inc.



Minifigure yourself
 Transforme-toi en figurine
 Conviértete en una minifigura



Create
 Crée
 Crea



Share
 Partage
 Comparte



Check availability of LEGO LIFE in your country now on LEGO.com/life
 Vérifie la disponibilité de LEGO LIFE dans ton pays sur LEGO.com/life
 Consulta si LEGO LIFE está disponible en tu país en LEGO.com/life

Ask parents' permission first.
 Demande d'abord l'autorisation d'un parent.
 Pide permiso a tus padres.

Apple and the Apple logo are trademarks of Apple Inc., registered in the U.S. and other countries.
 App Store is a service mark of Apple Inc. Google Play is a trademark of Google Inc.

All your LEGO® fun in one app
 Tout l'amusement LEGO® dans une appli
 Toda la diversión LEGO® en una app



6196071

LEGO, the LEGO logo, the Minifigure, the Brick and Knob configurations and the LIFE logo are trademarks and/or copyrights of the/sont des marques de commerce et/ou copyrights du/son marcas registradas, algunas de ellas protegidas por derechos de autor, de LEGO Group. ©2017 The LEGO Group. All rights reserved/Tous droits réservés/Todos los derechos reservados.