

ULTRA AGENTS

70173

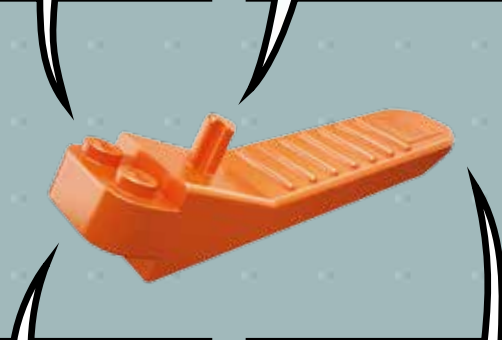

LEGO.com/ultraagents



LEGO.com/brickseparator

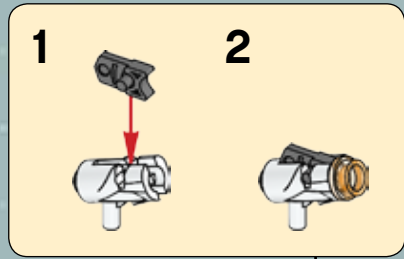
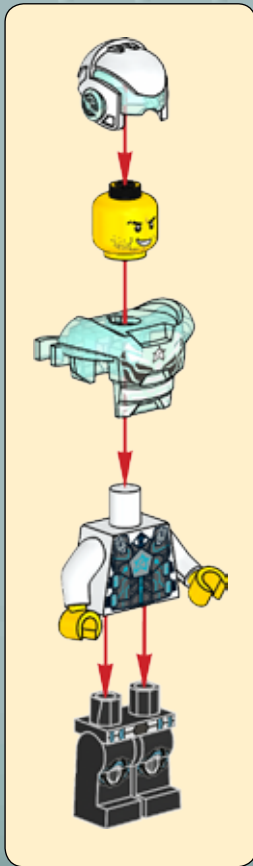
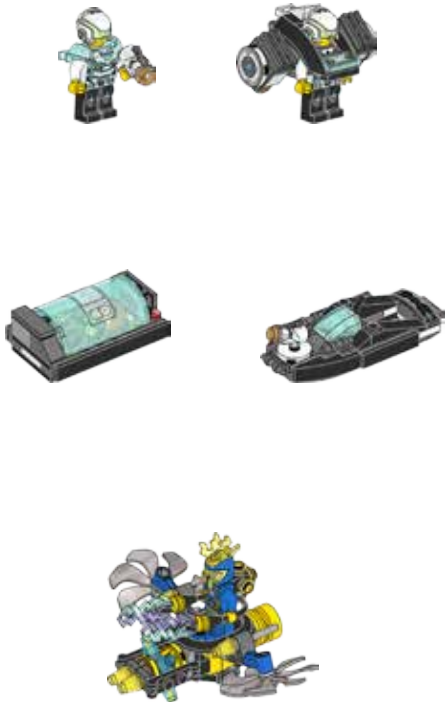

IMPORTANT: Never modify the elements or use other projectiles than provided with this toy.
IMPORTANT : Ne jamais modifier les éléments ni utiliser d'autres projectiles que ceux fournis avec ce jouet.
IMPORTANTE: No modifique los elementos ni utilice otros proyectiles diferentes a los suministrados junto con este juguete.





1

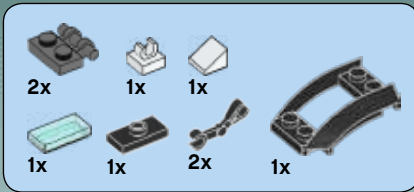

2

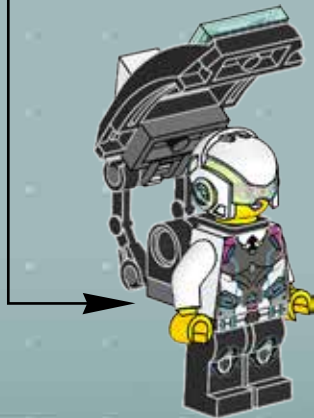
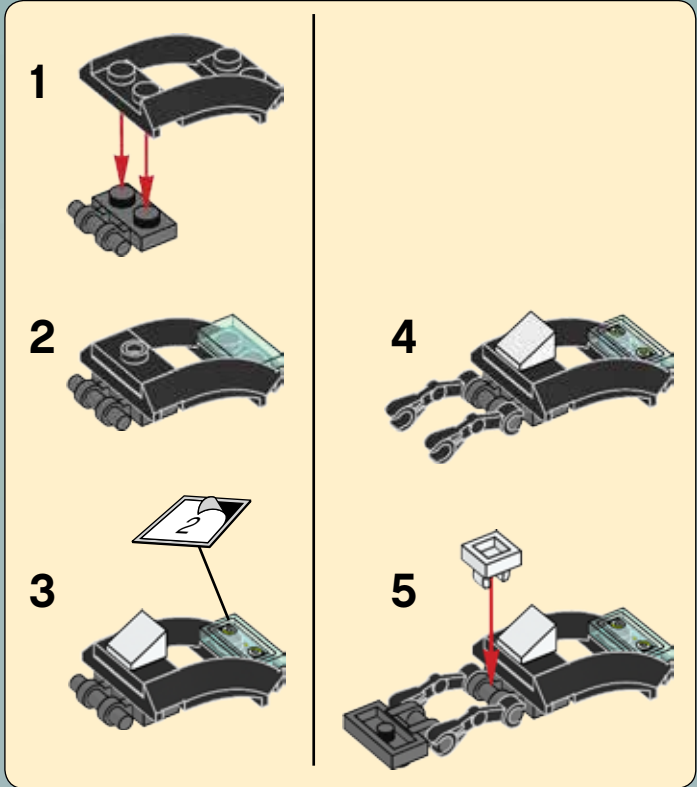

3

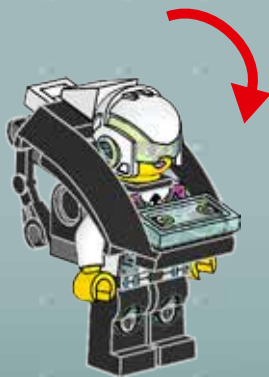

4

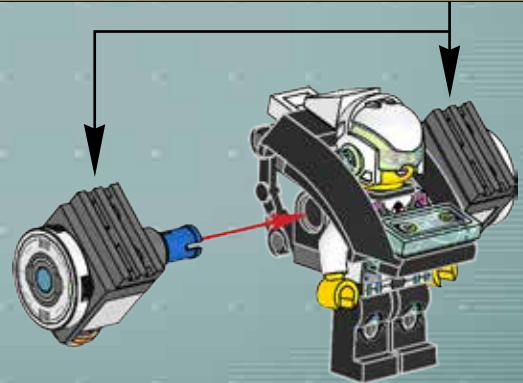
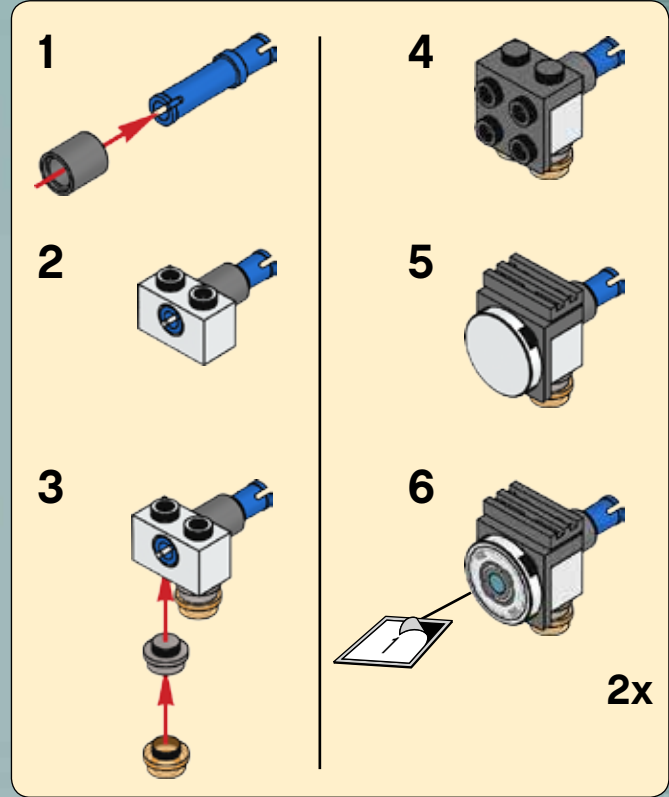
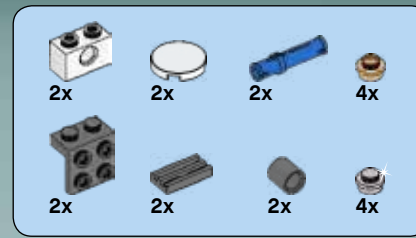

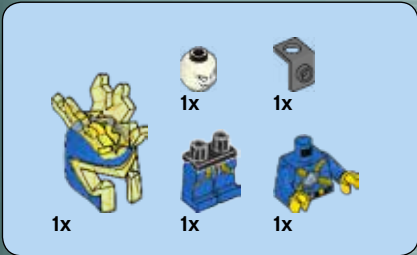

1

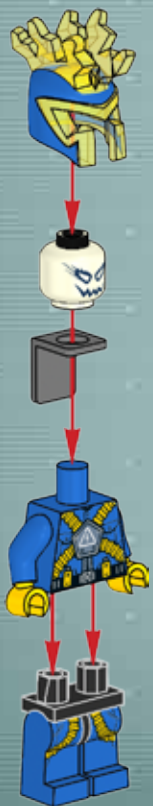

2

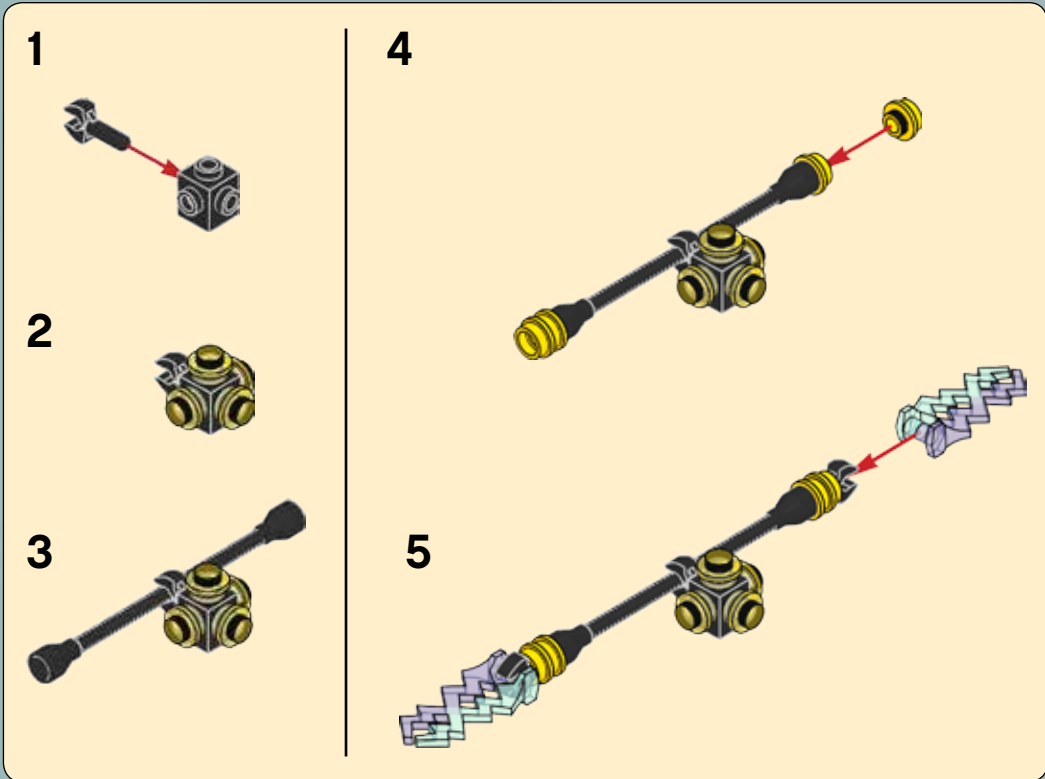

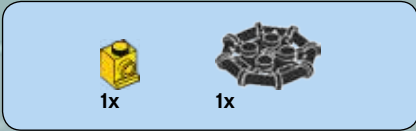
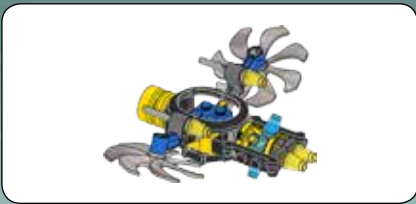

1



2



3

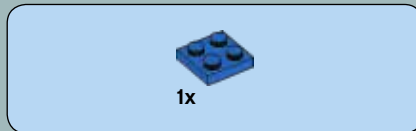
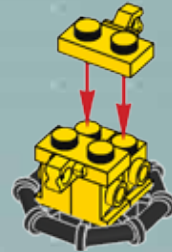

4





5

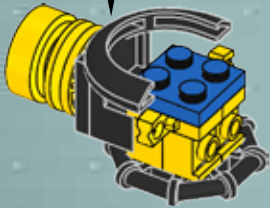
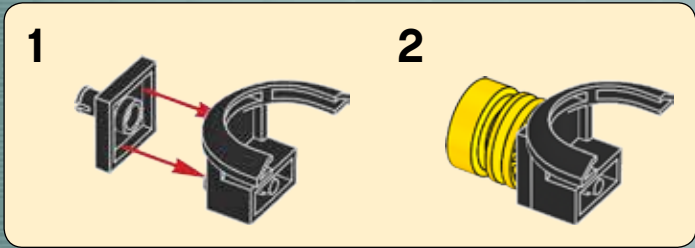

6

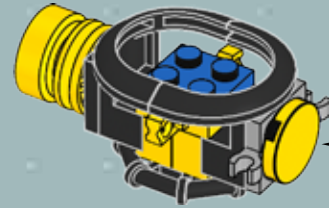
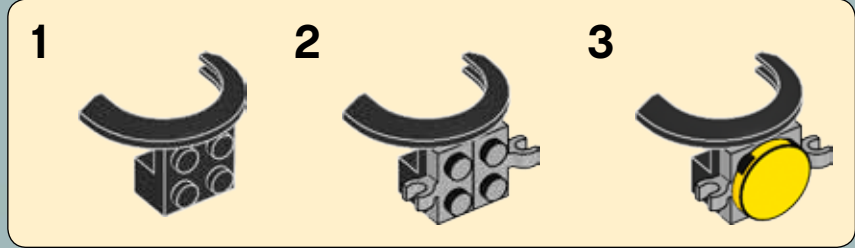

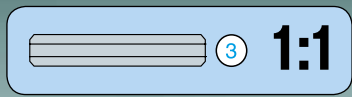

7

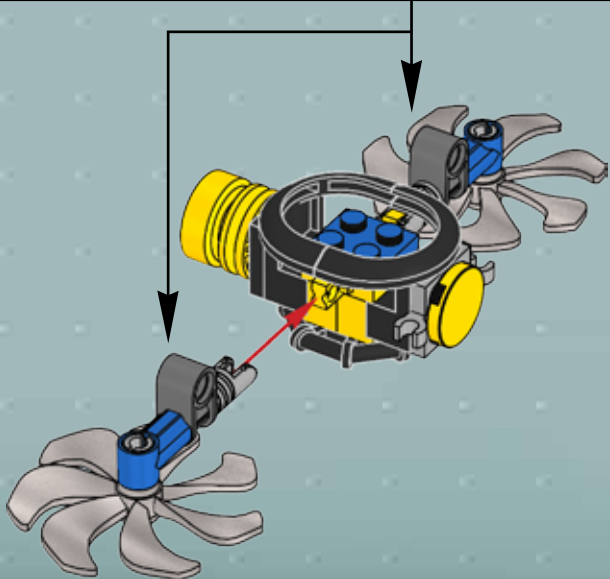
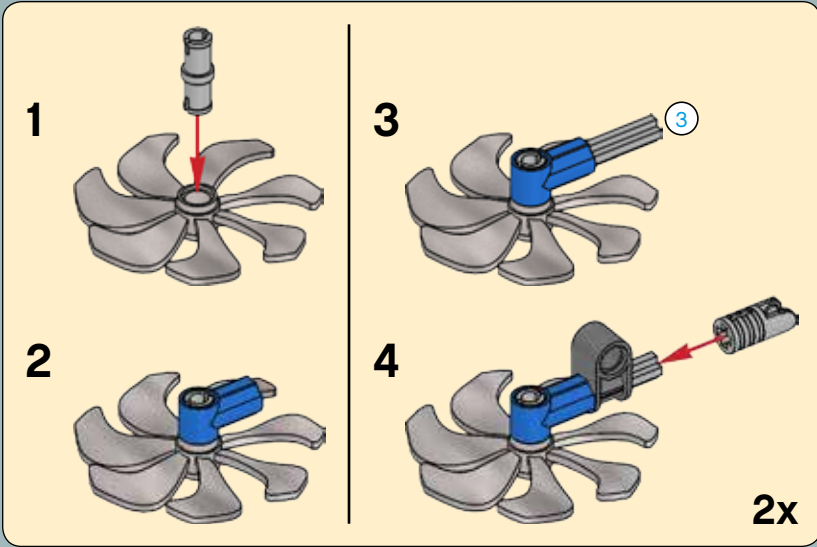

8

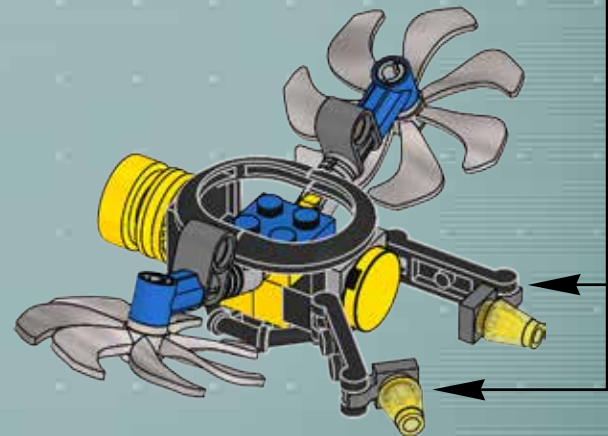
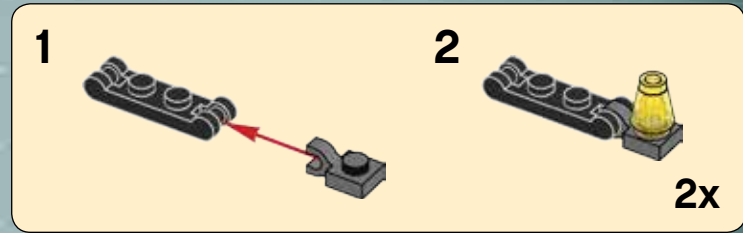

1x  2x  1x  4x 

9

1



2



3



4



1  2   2x

5

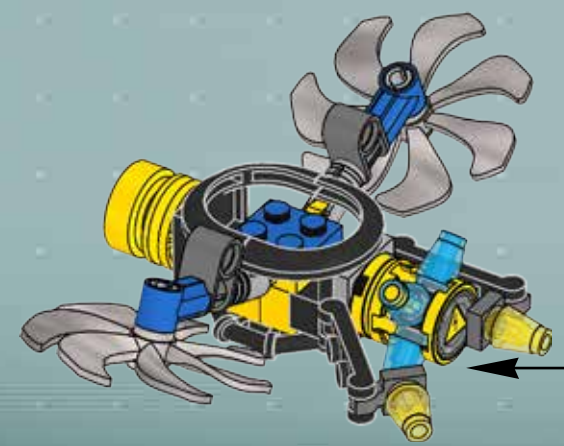



10

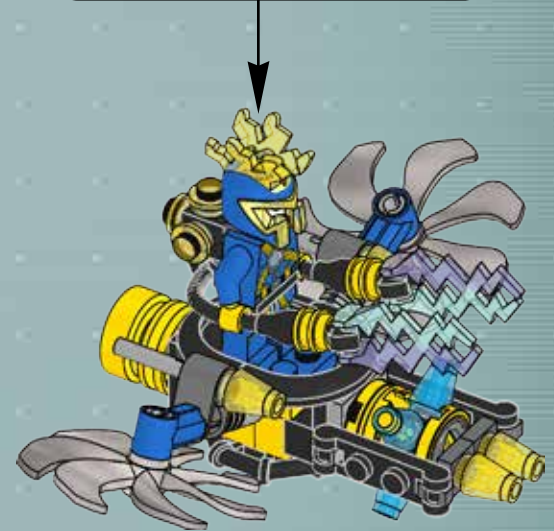
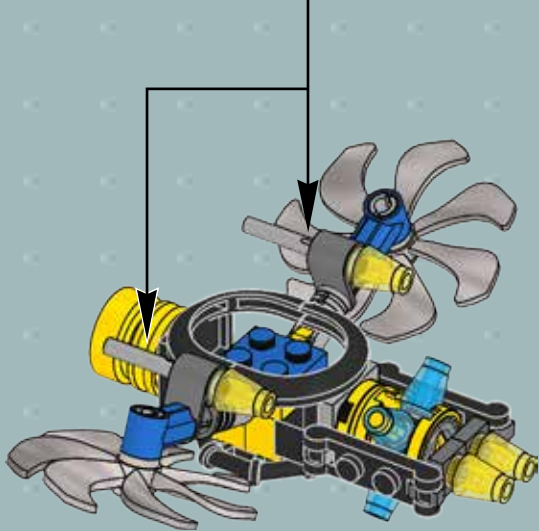
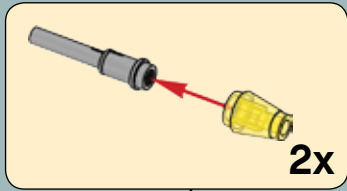



1x

1x

1



1x

4x

2

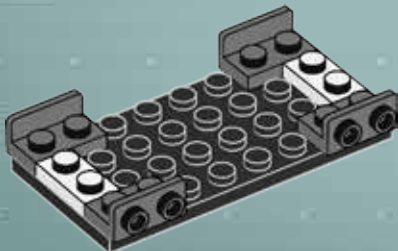

2x

2x

3

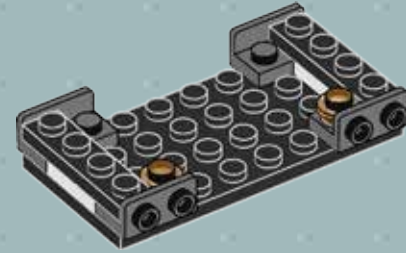

2x

4





5

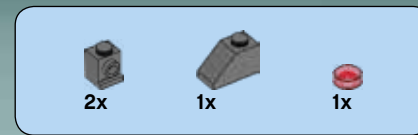
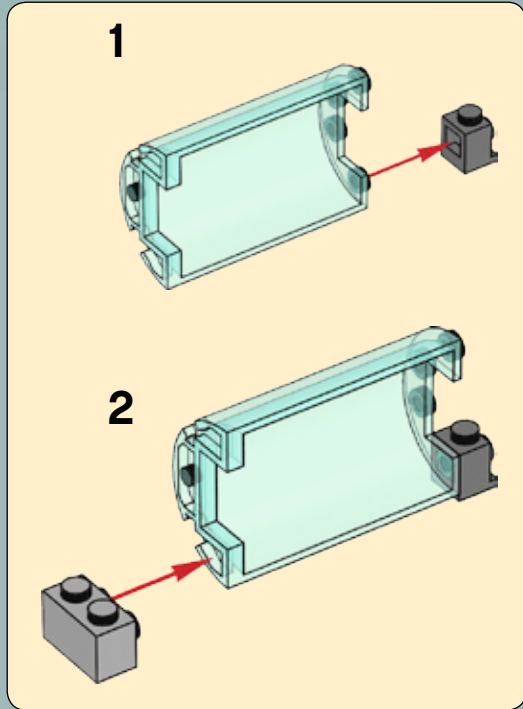

6

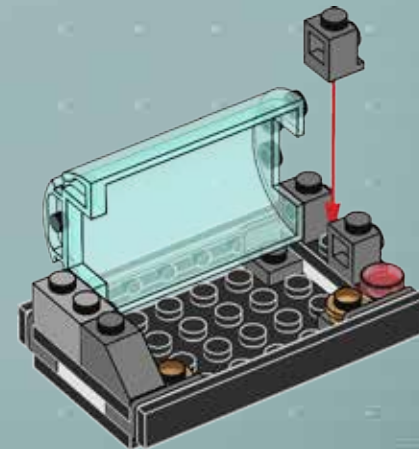

7

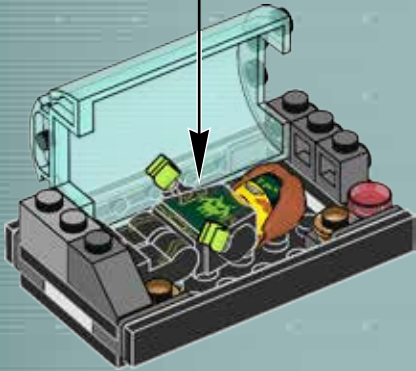

2x

8

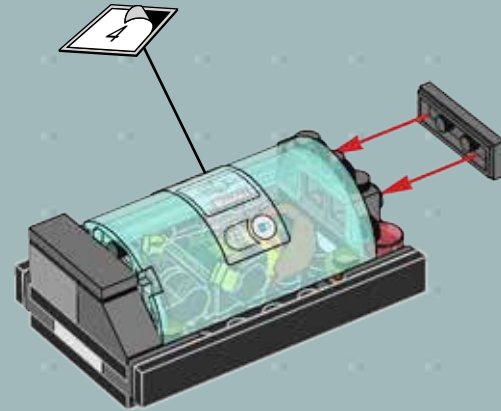

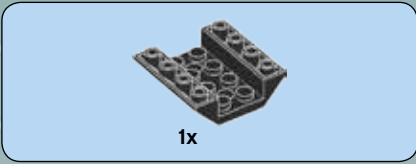

1

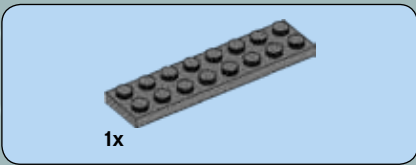
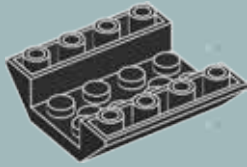

2

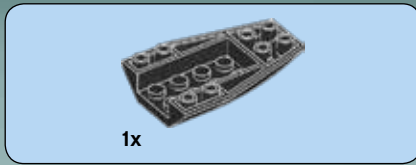
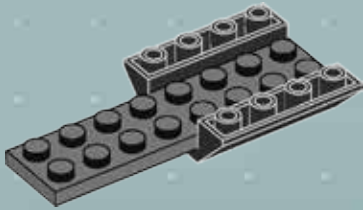

3

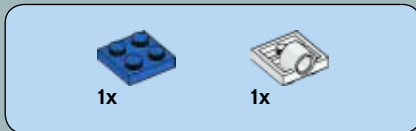
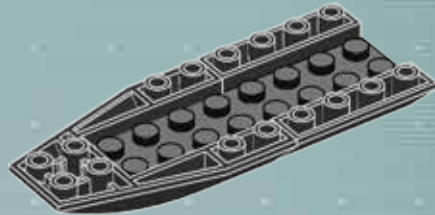

4

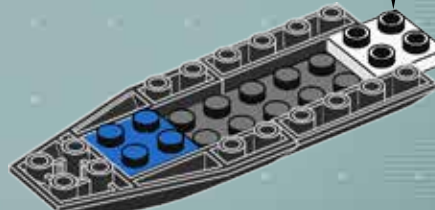



2x



1x

5

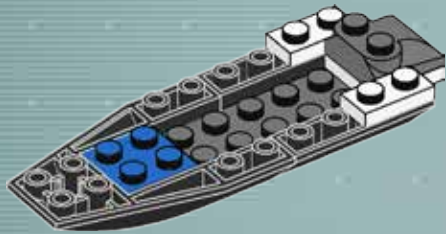

4x

6

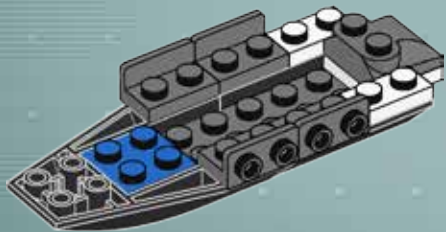

1x



4x

7

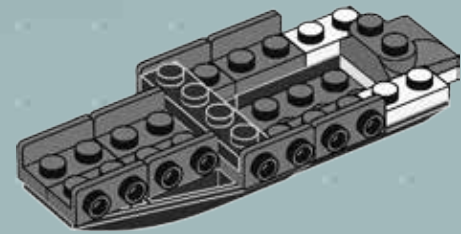

2x



1x

8

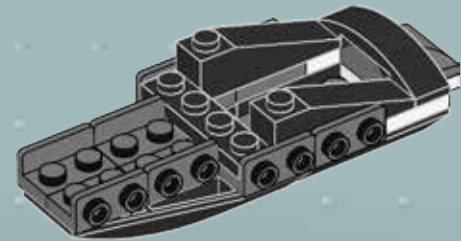



9

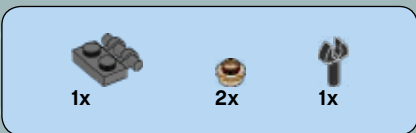
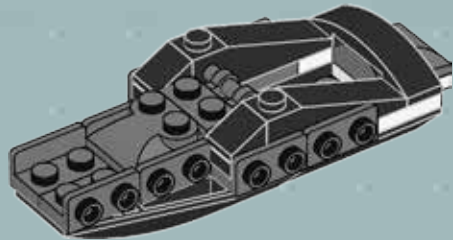

10

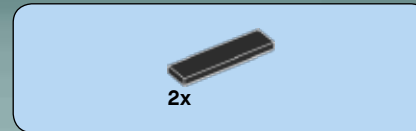
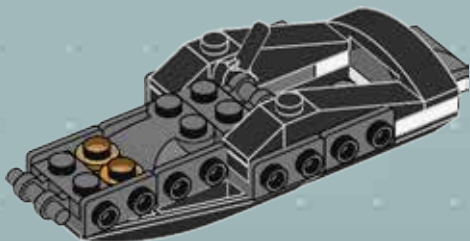

11

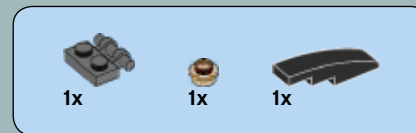
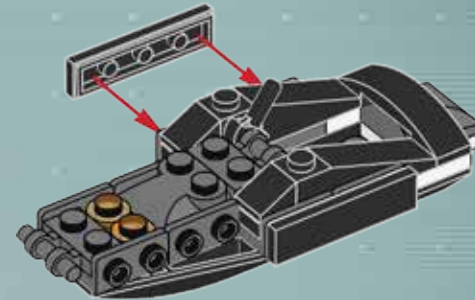

12

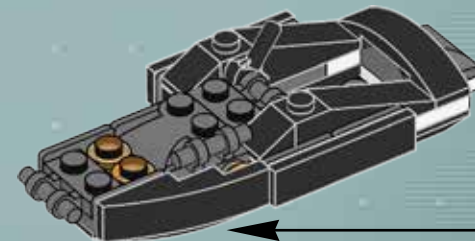
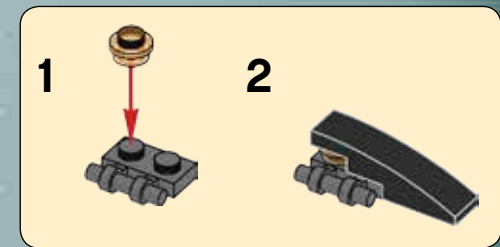

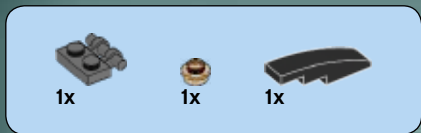

13

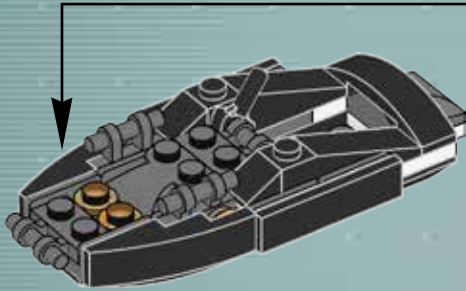
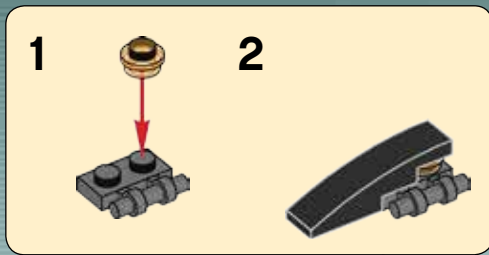

14



15

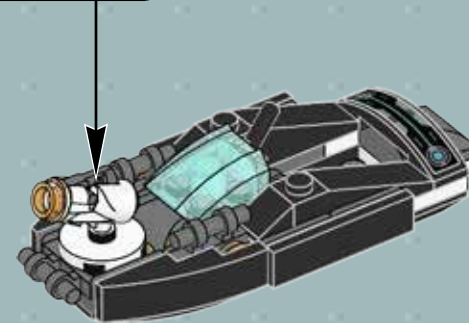
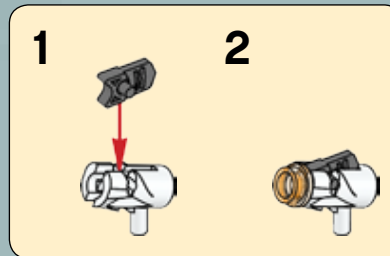



2

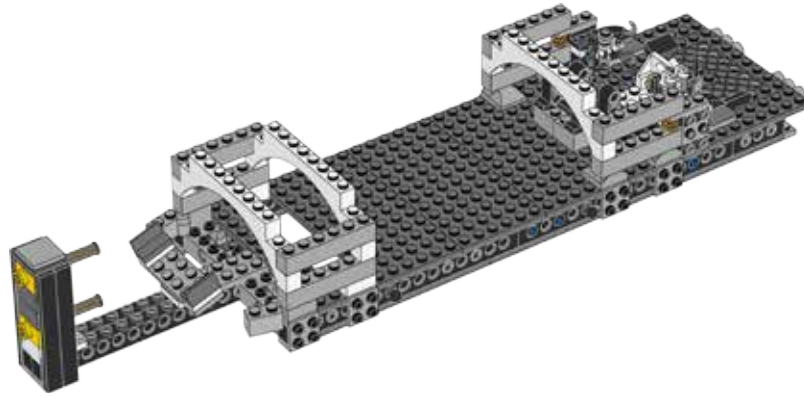

1x

1

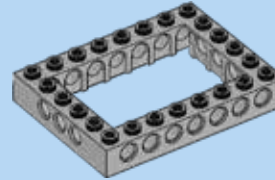

2x

2

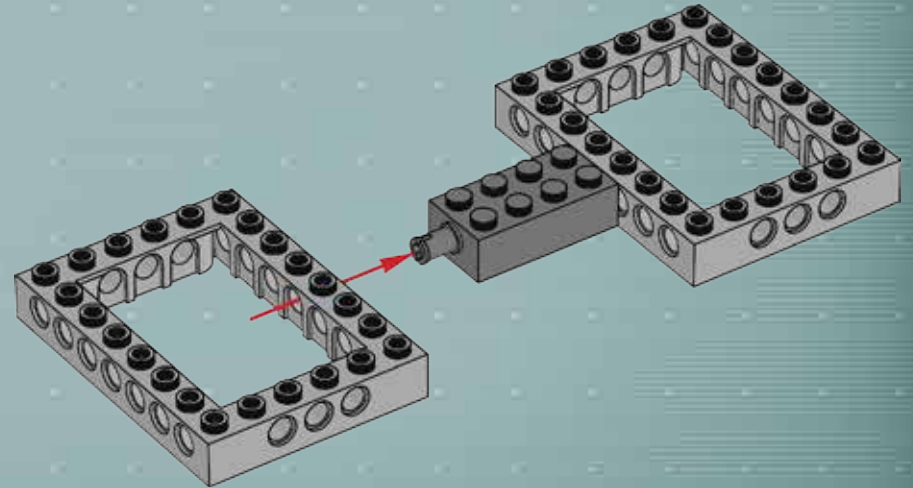

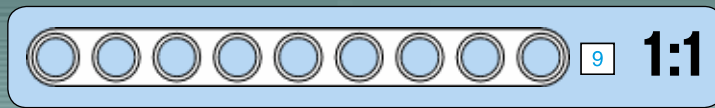
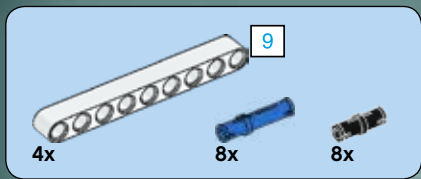

3

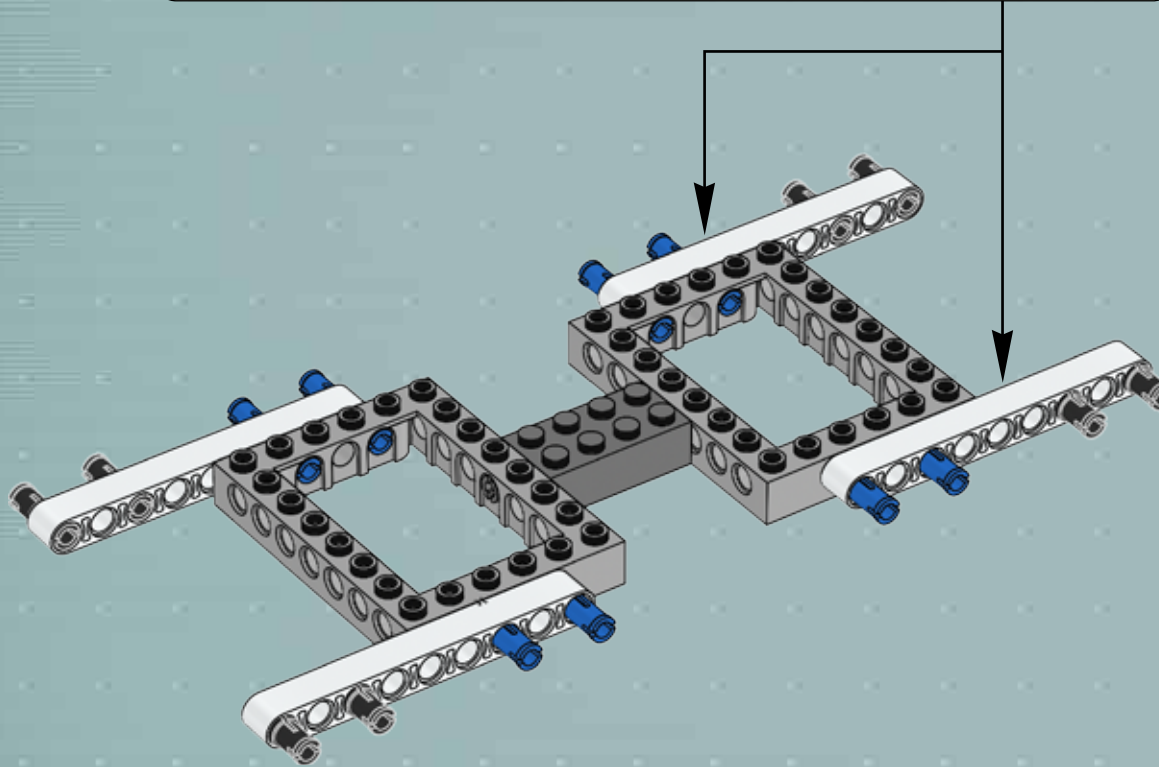
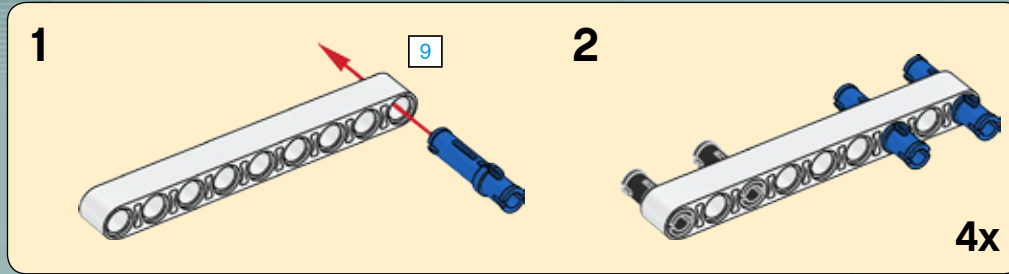

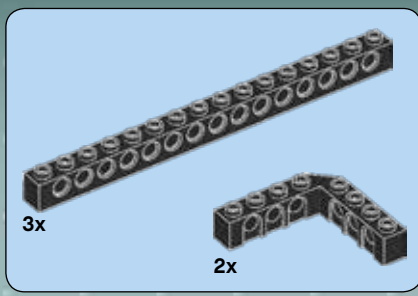

4

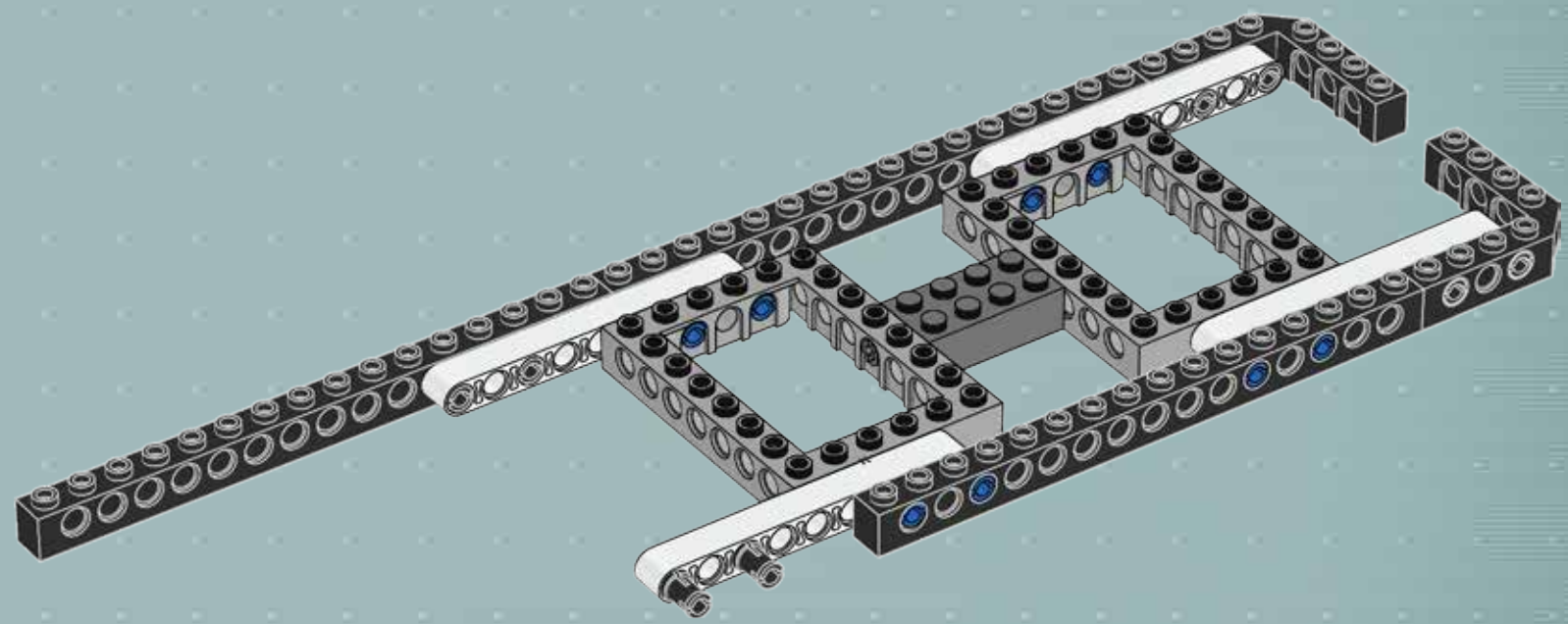

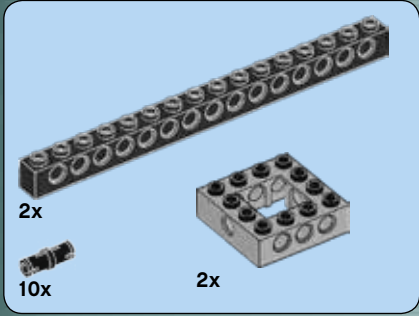
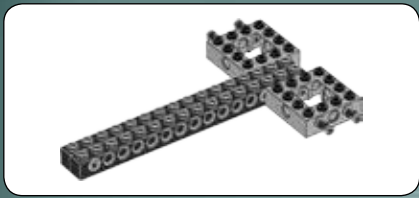

5

1

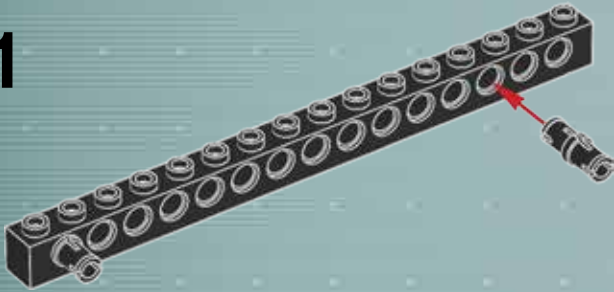

2

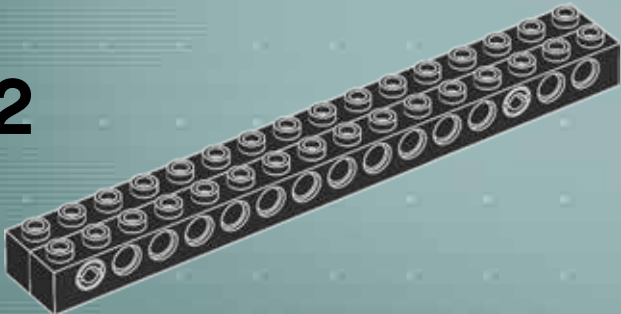

3

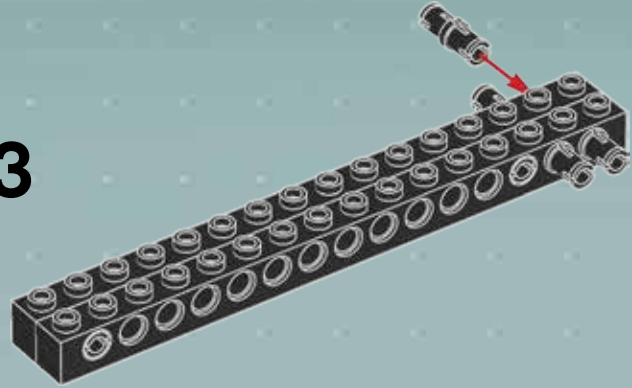

4

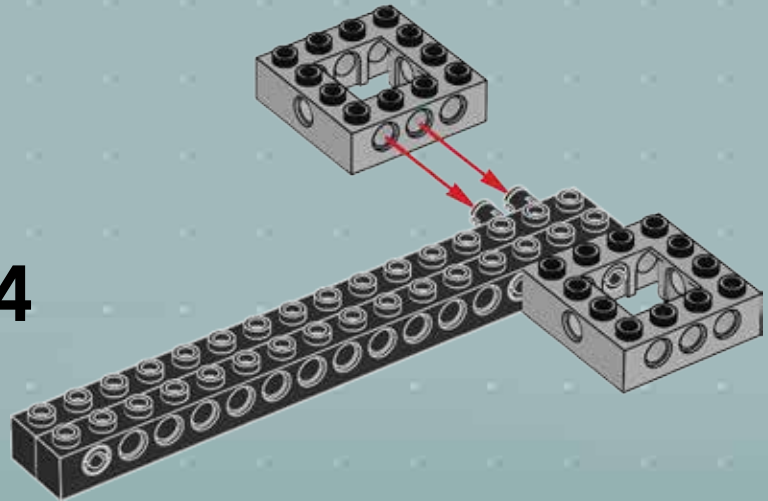

5

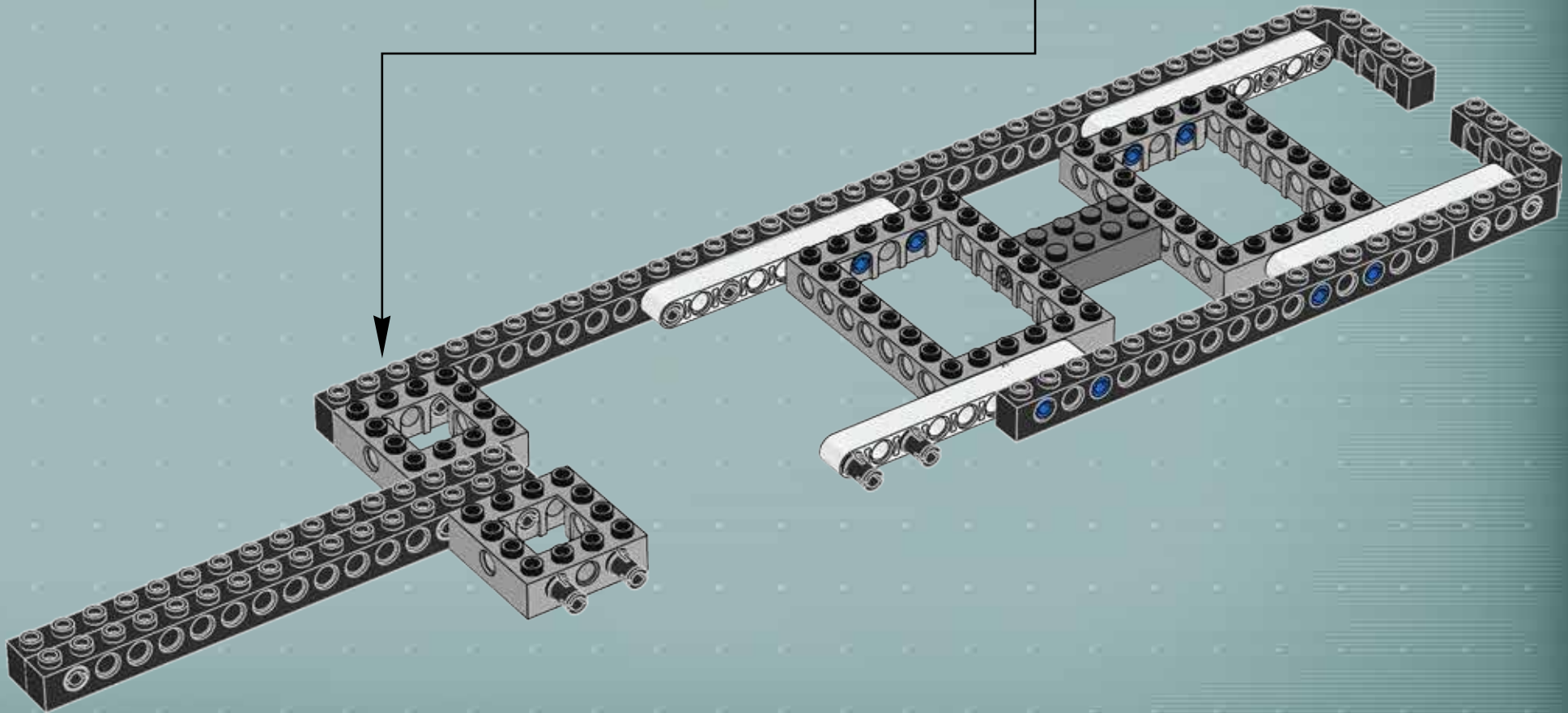
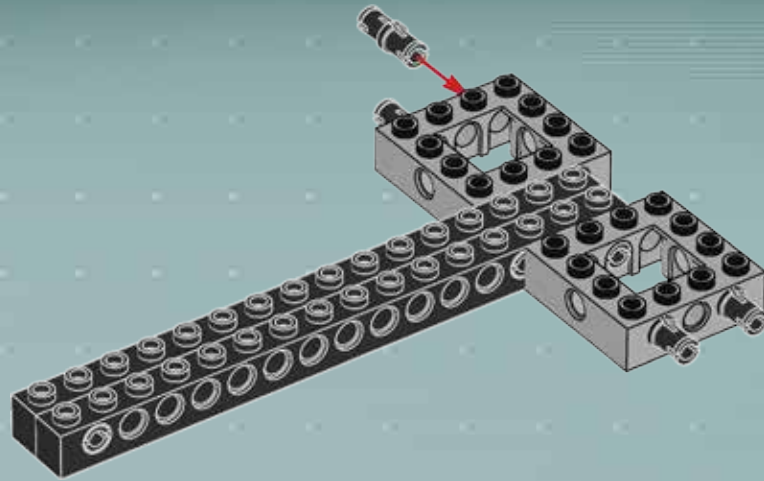

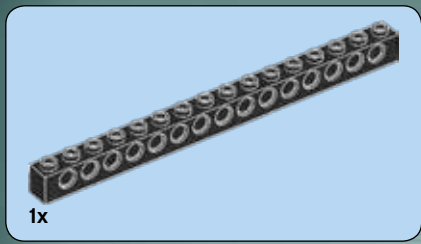

6

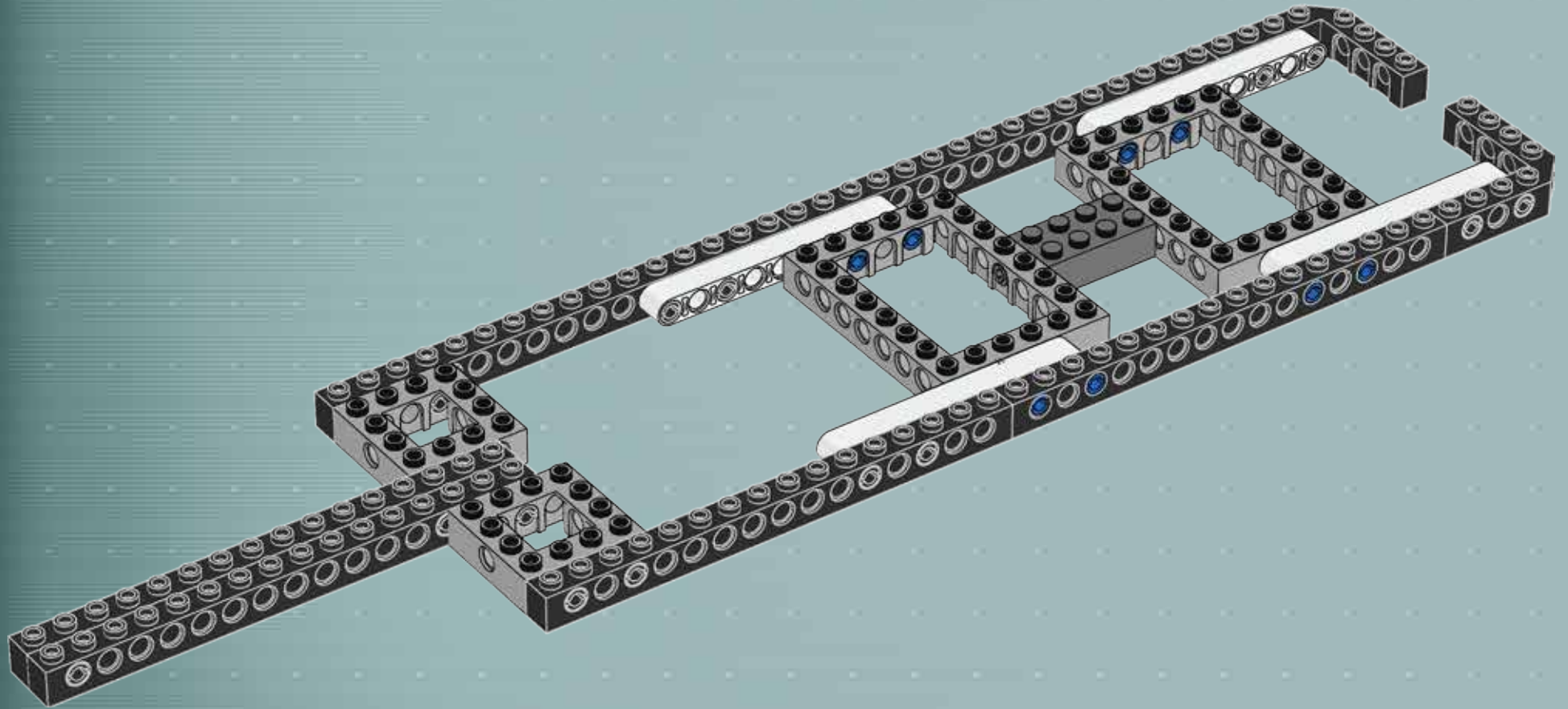

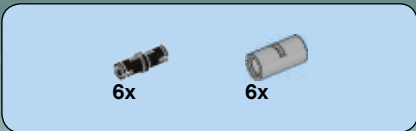

7

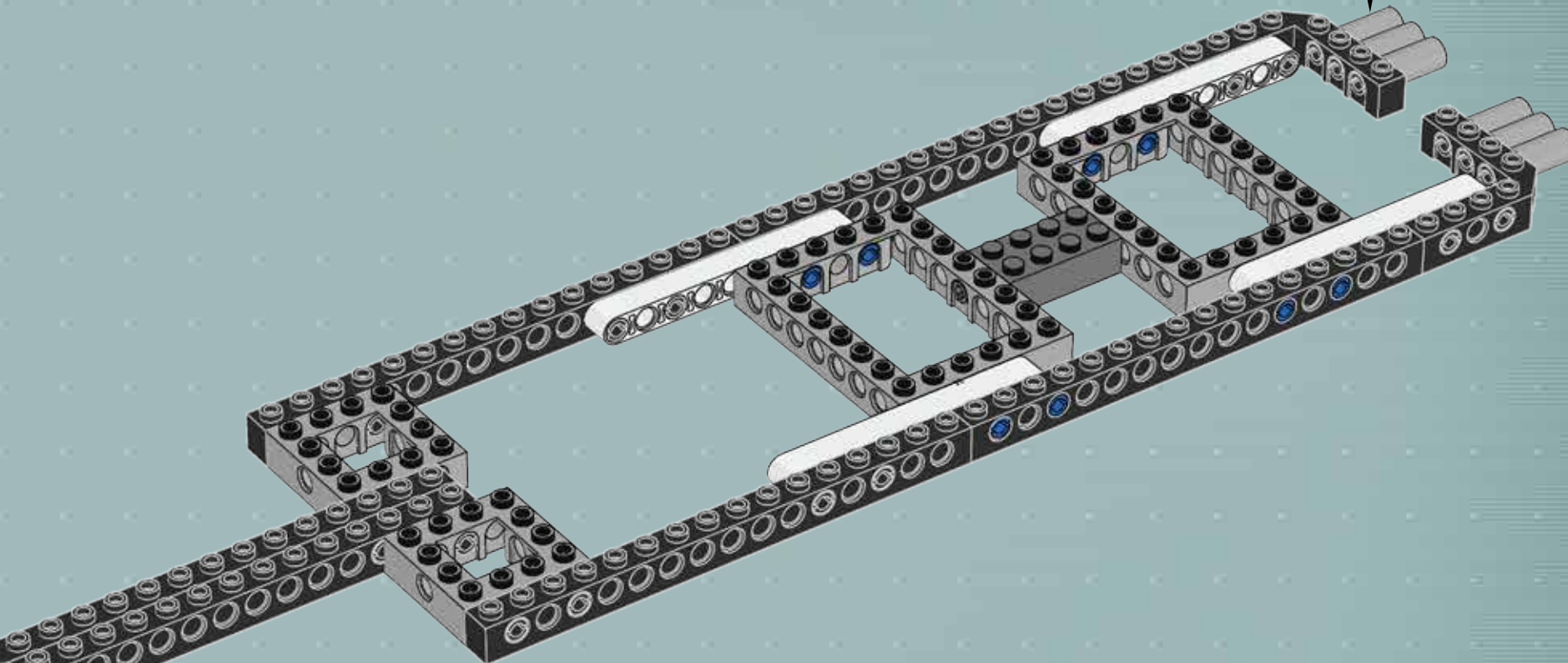
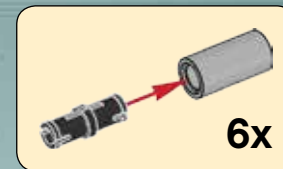

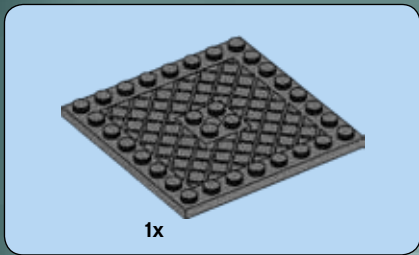

8

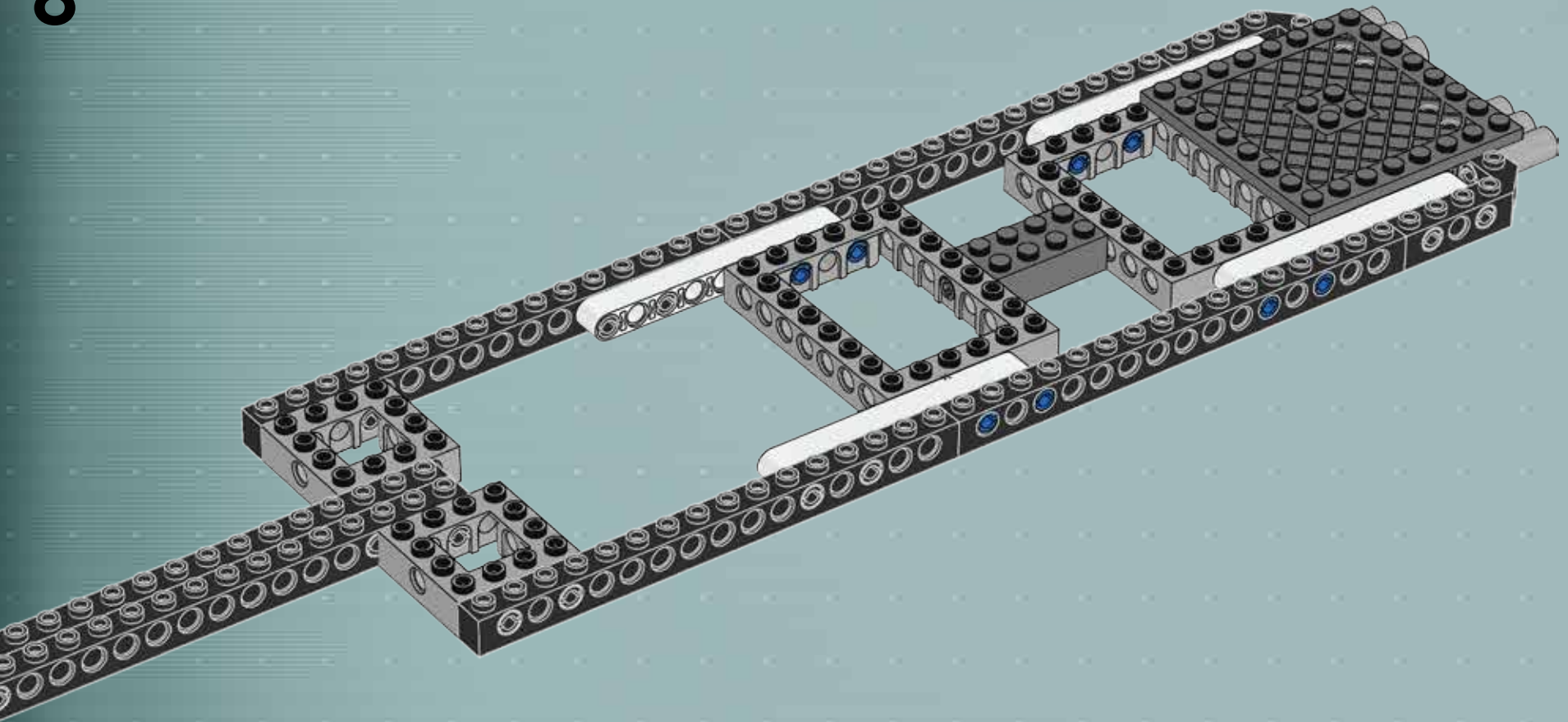

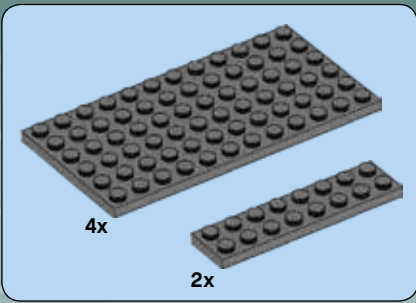

9



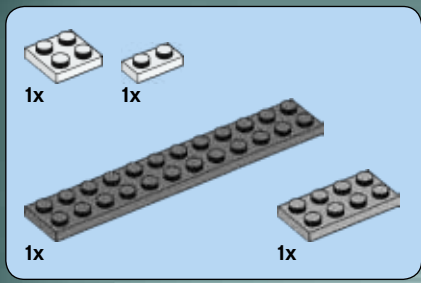

10

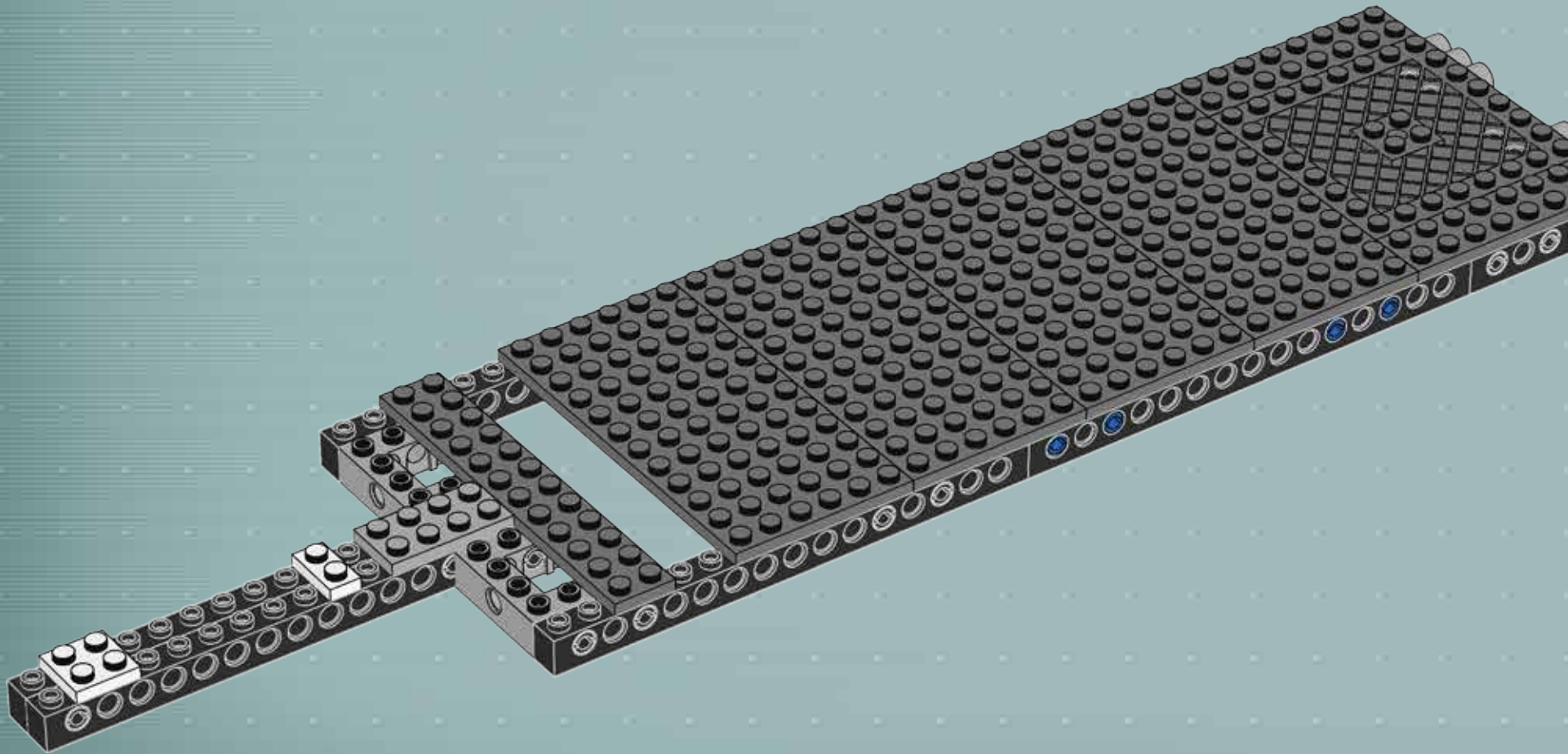

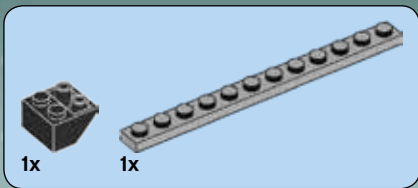

11

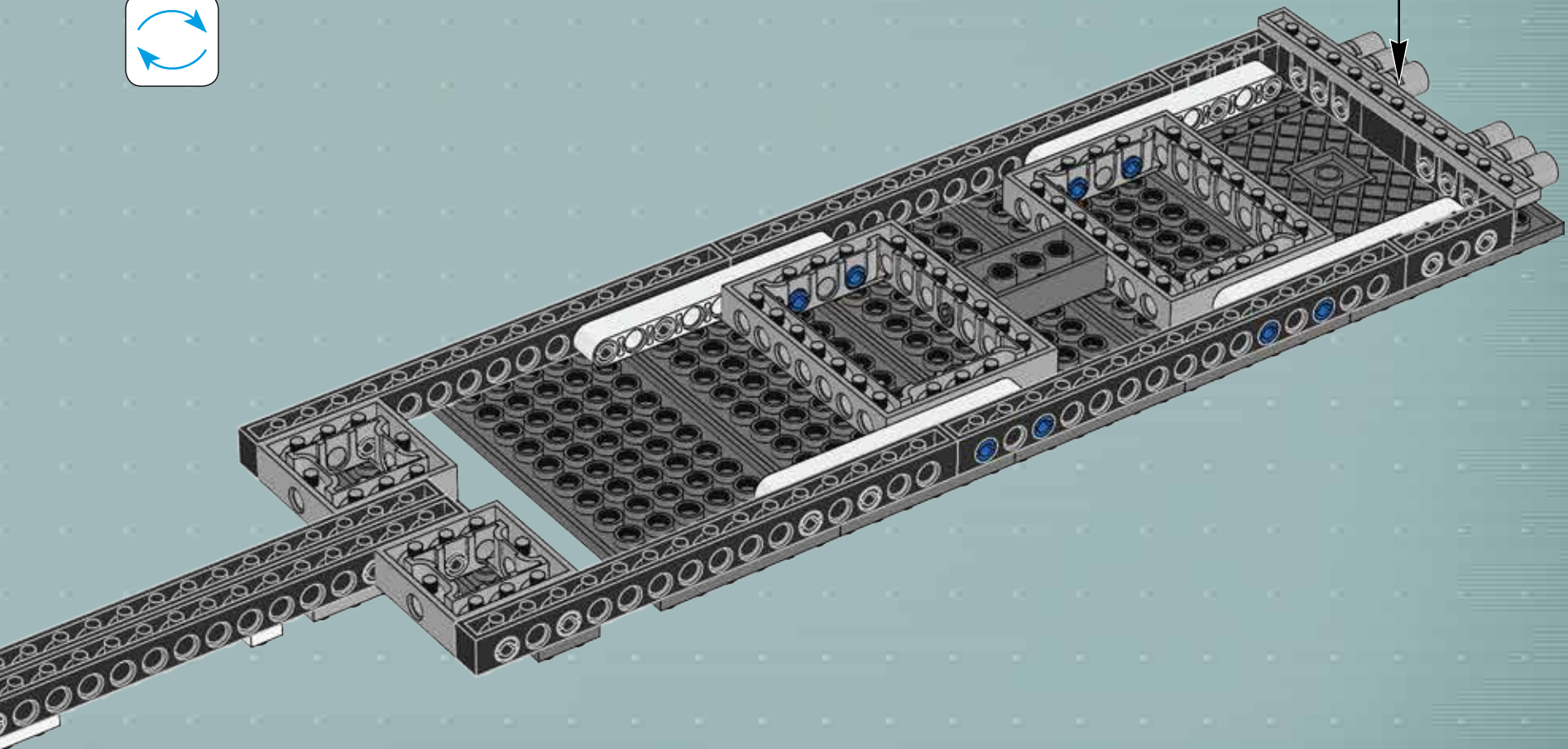
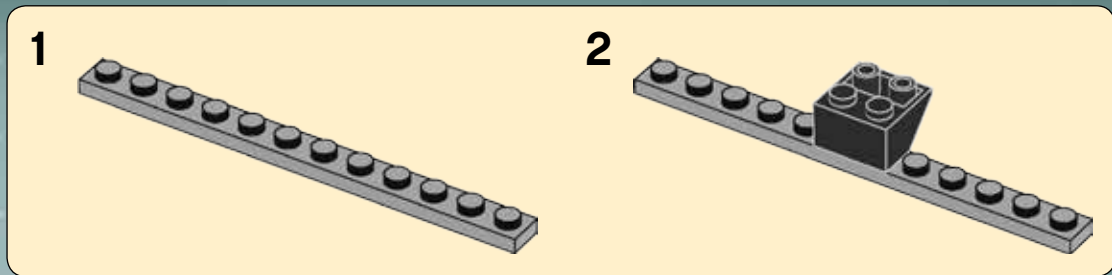

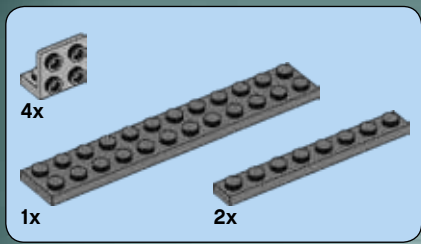

12

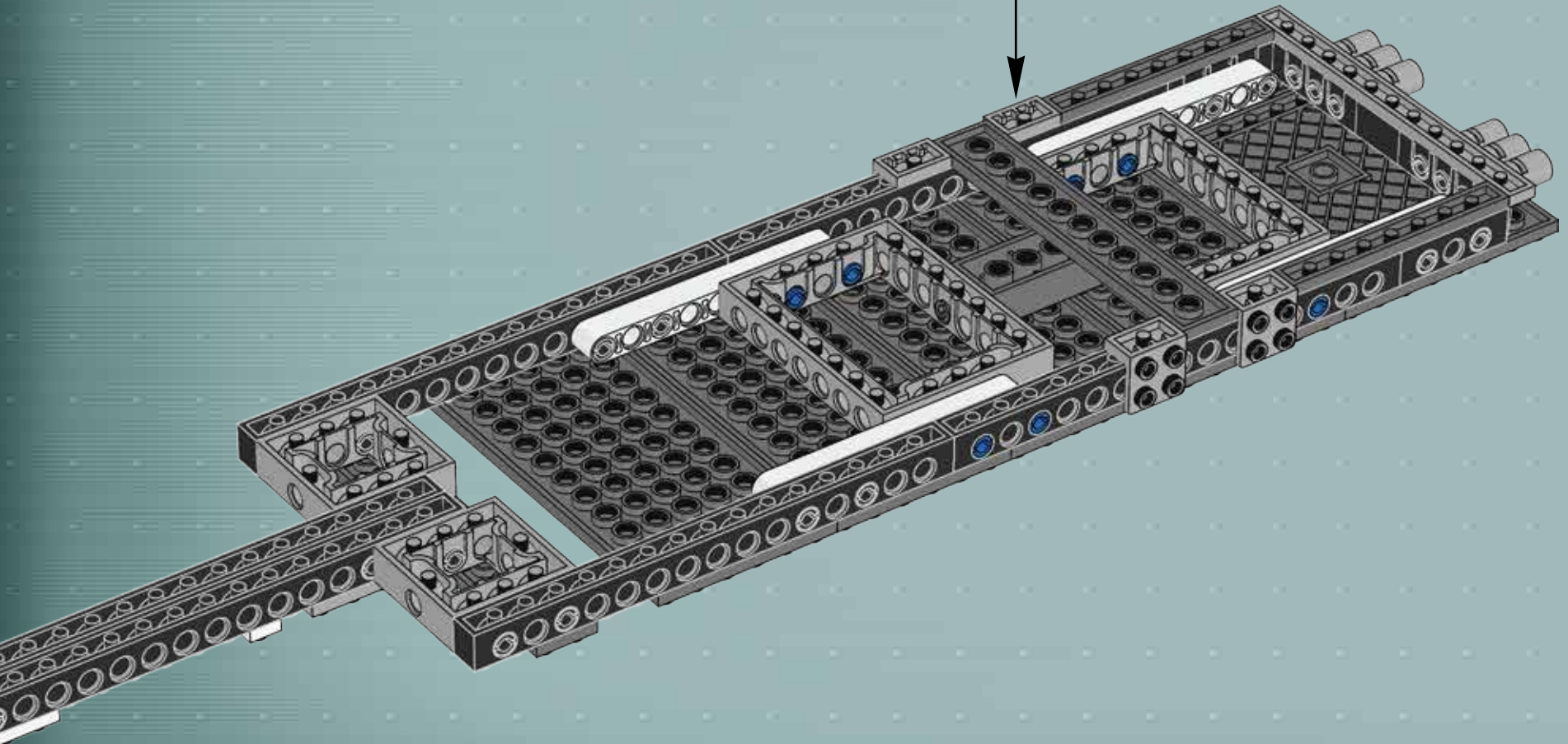
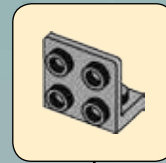

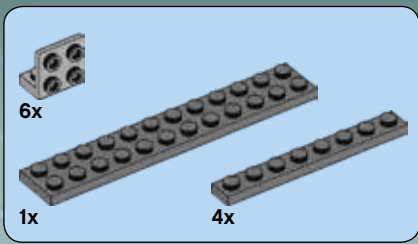

13

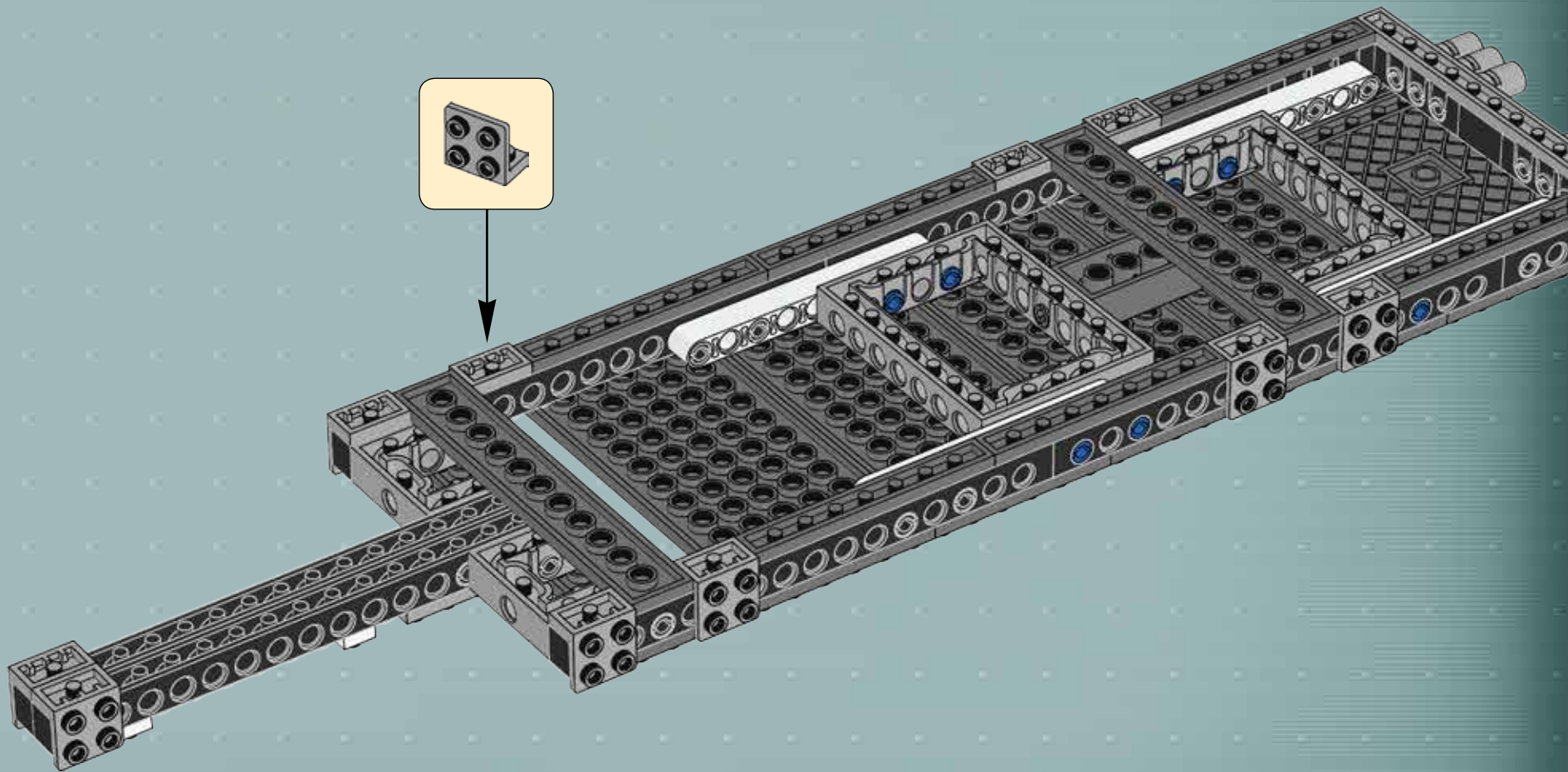



4x

14

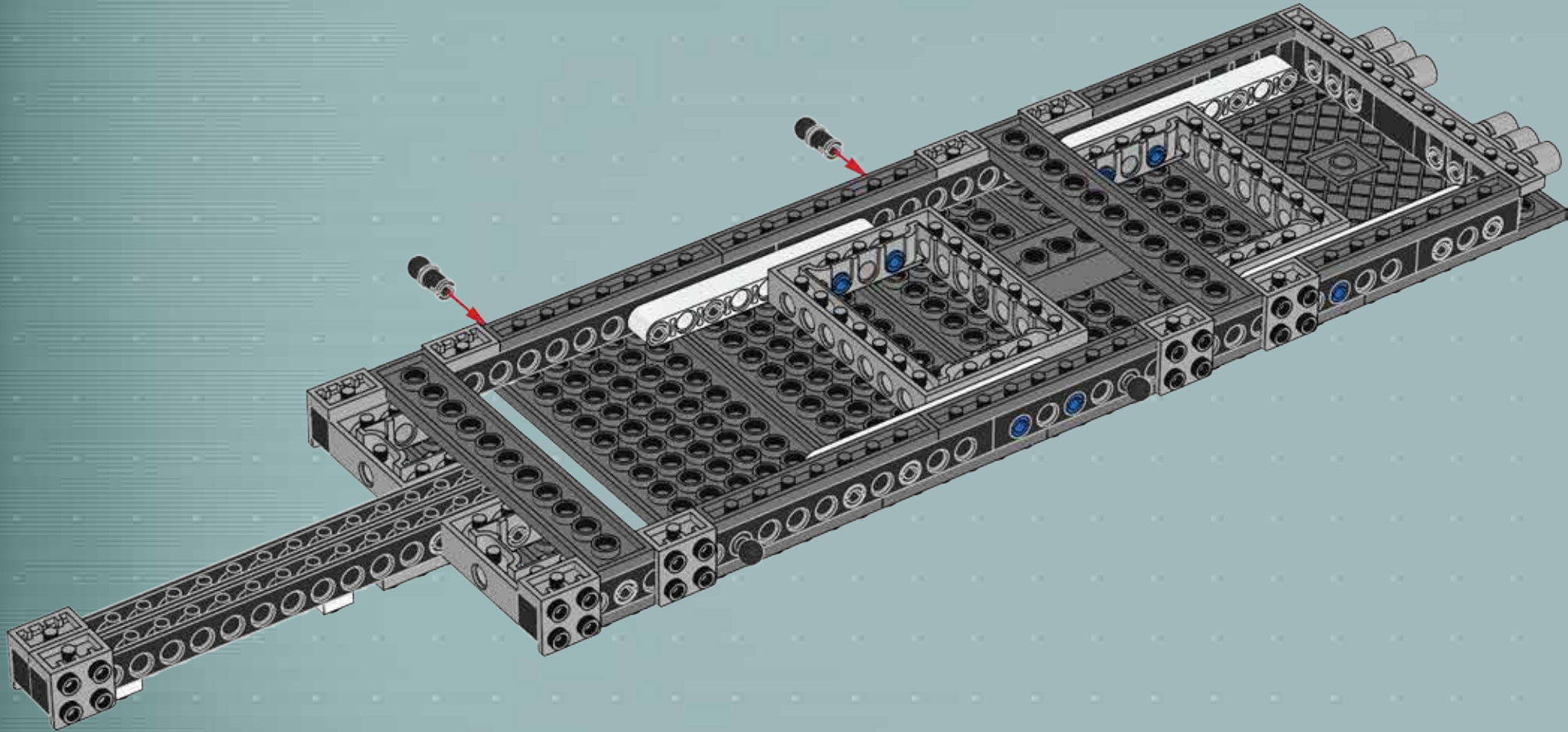



15

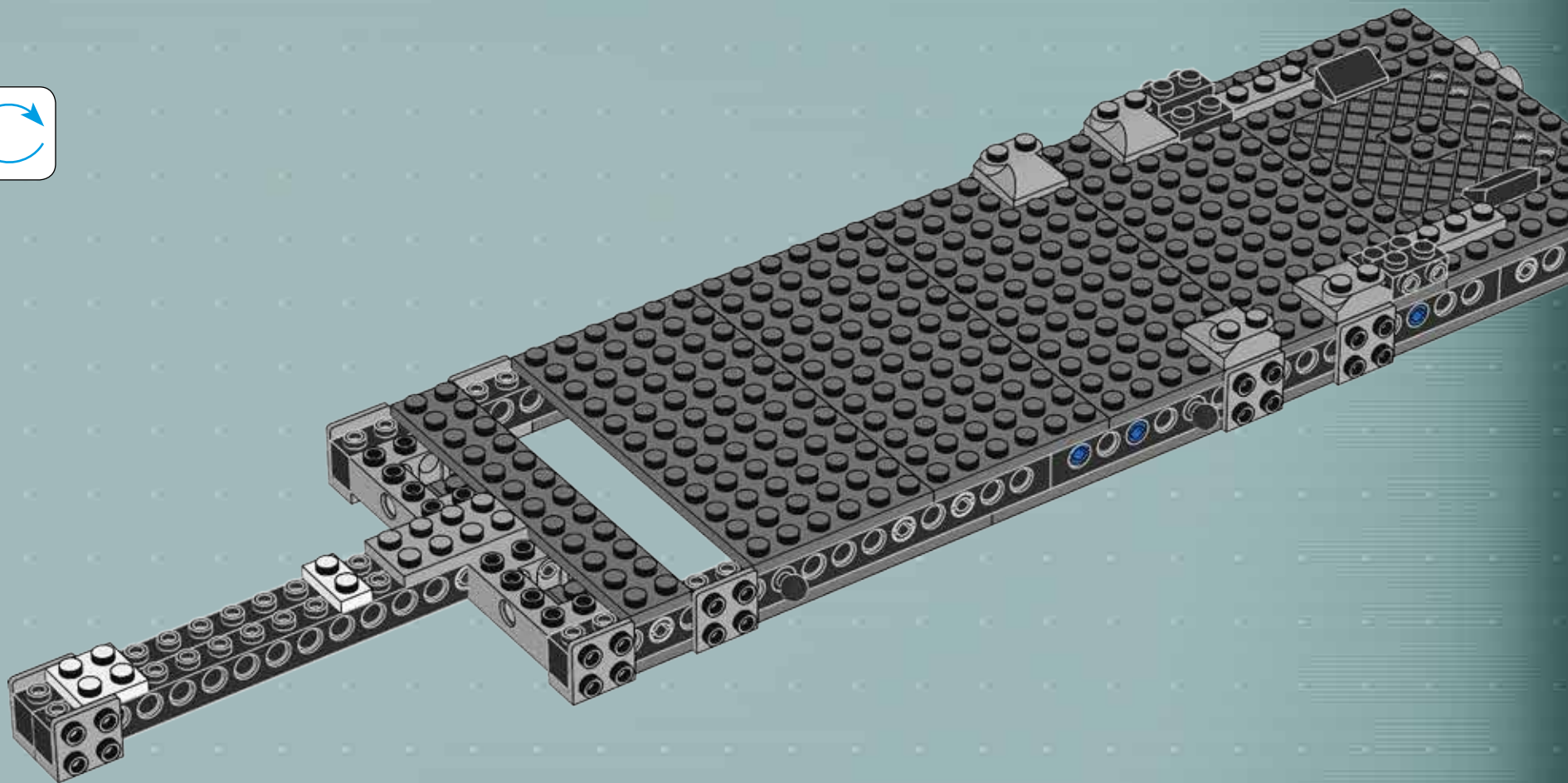

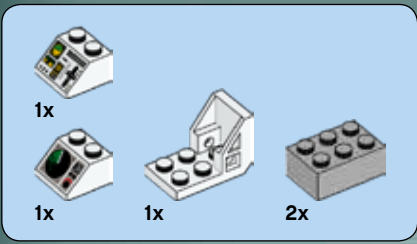

16

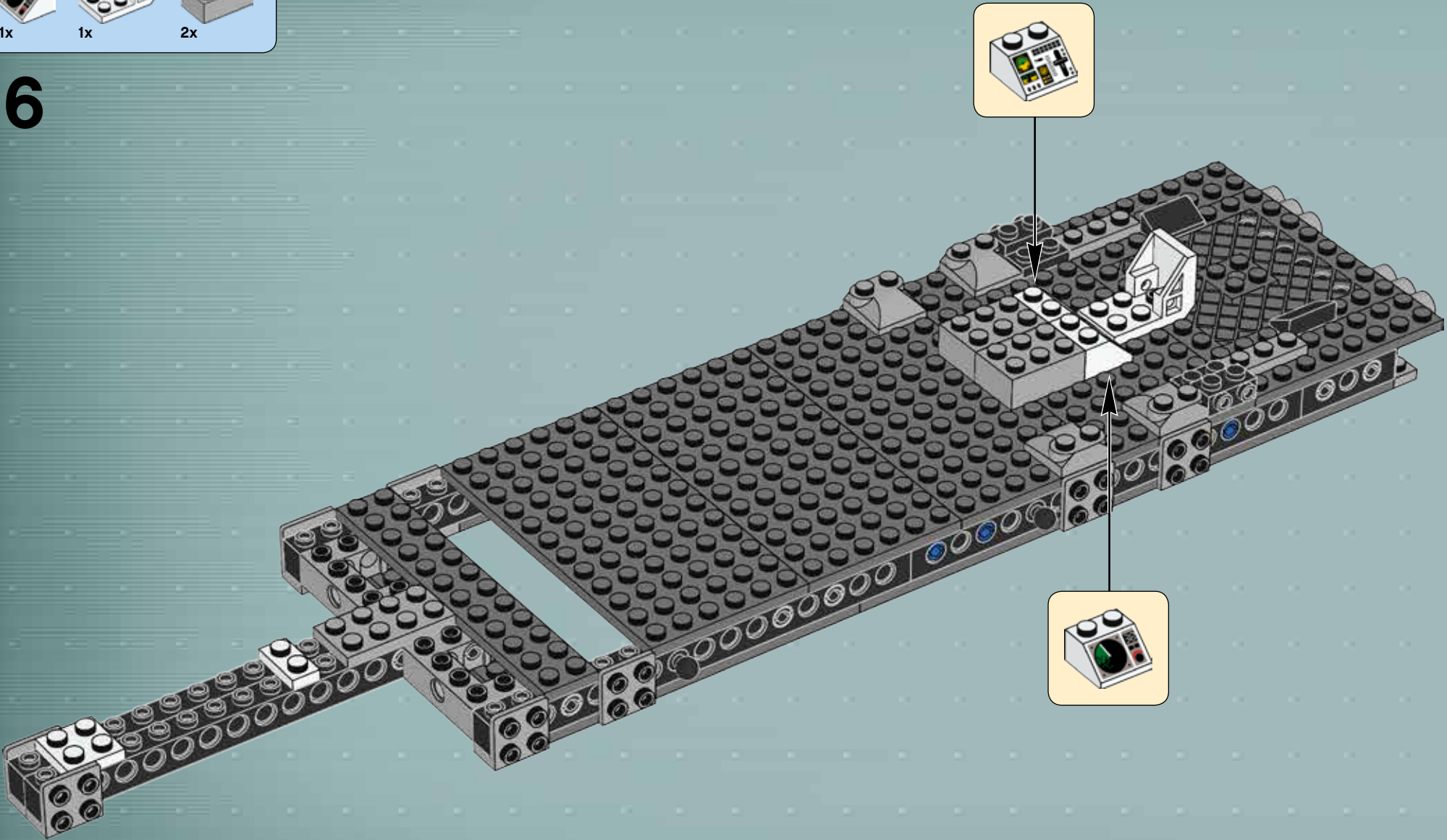

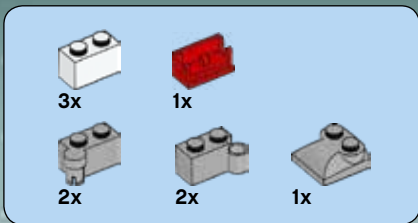

17

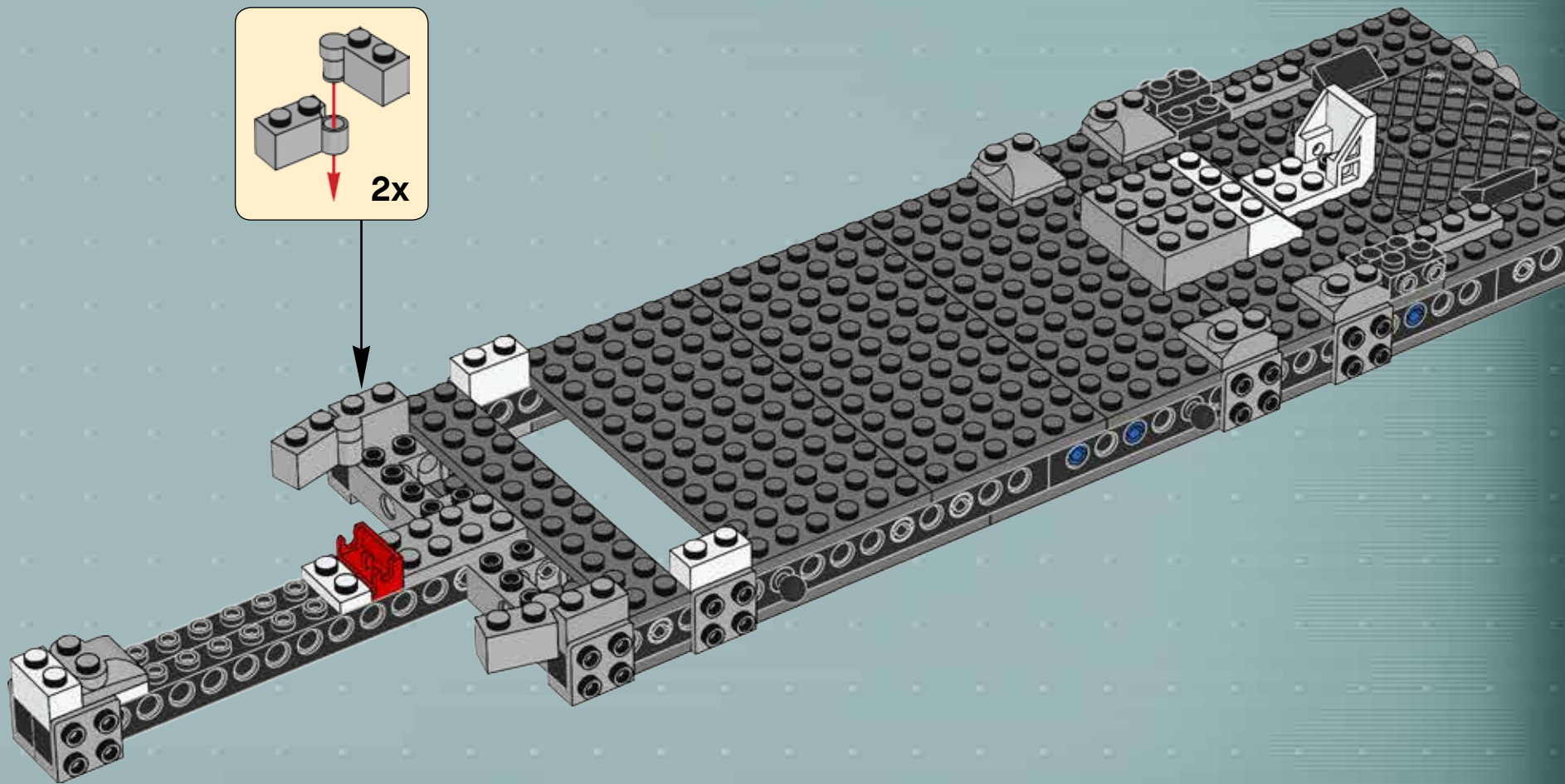
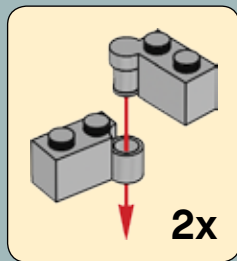

2x  2x  6x 

18

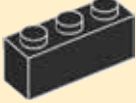
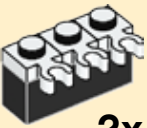
1  2  2x

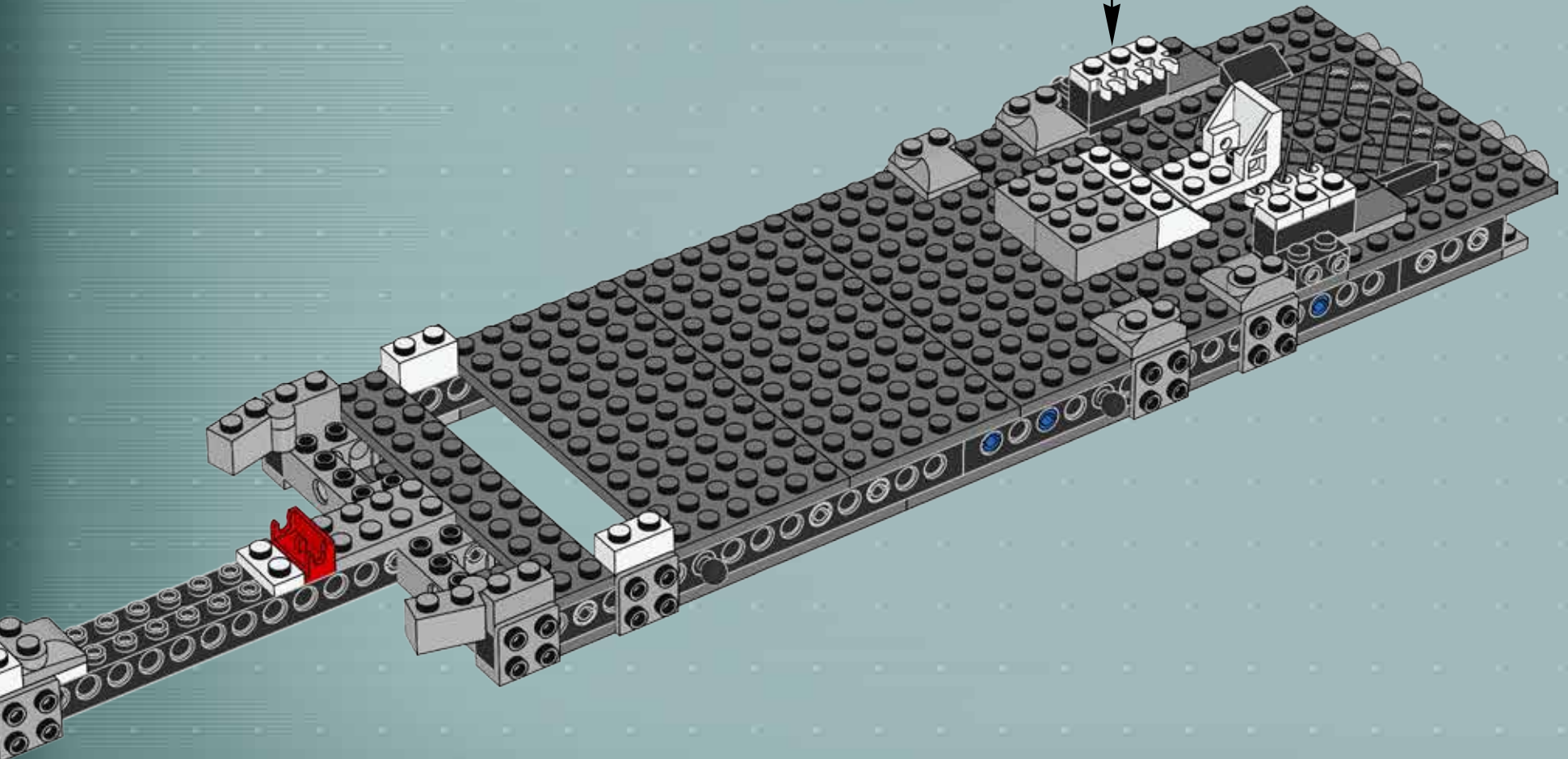

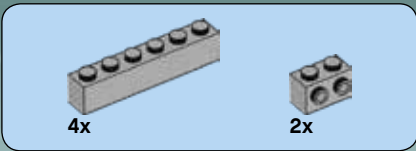

19

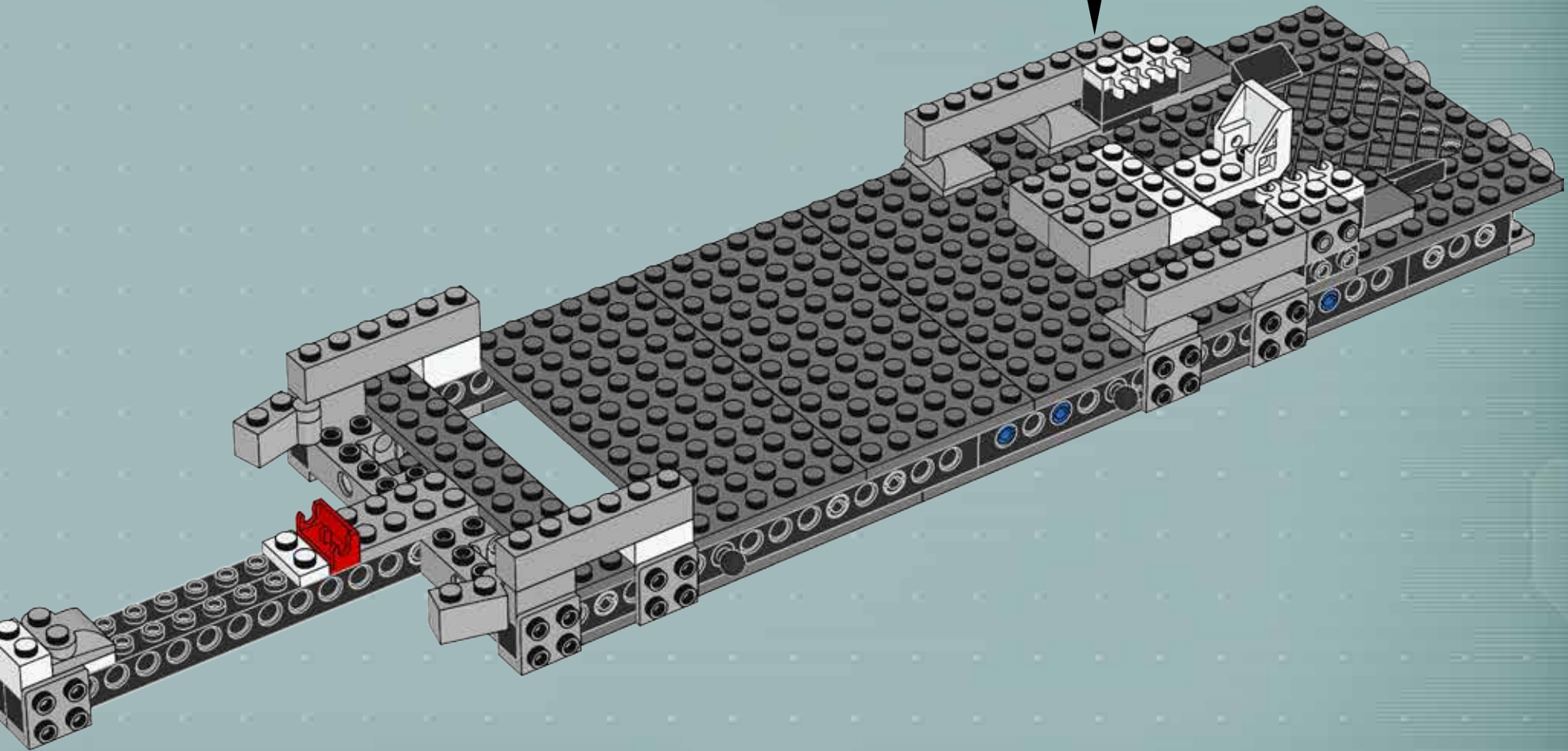
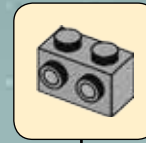

| | | |
|--|---|---|
|  1x |  4x | |
|  2x |  1x |  2x |

20



2x

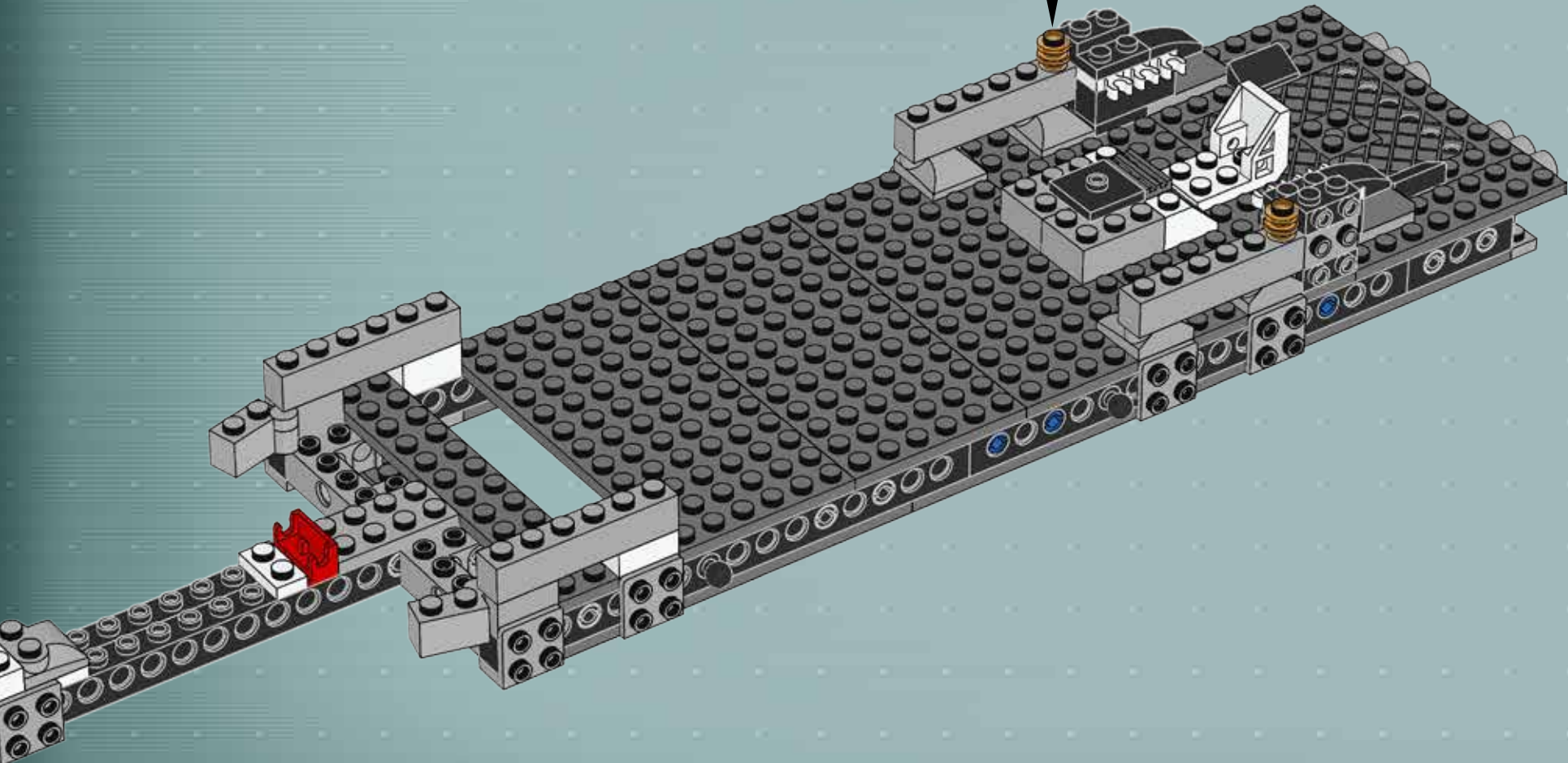

- 1x [Part]
- 2x [Part]
- 2x [Part]
- 1x [Part]
- 1x [Part]
- 1x [Part]
- 2x [Part]
- 2x [Part]
- 1x [Part]

21

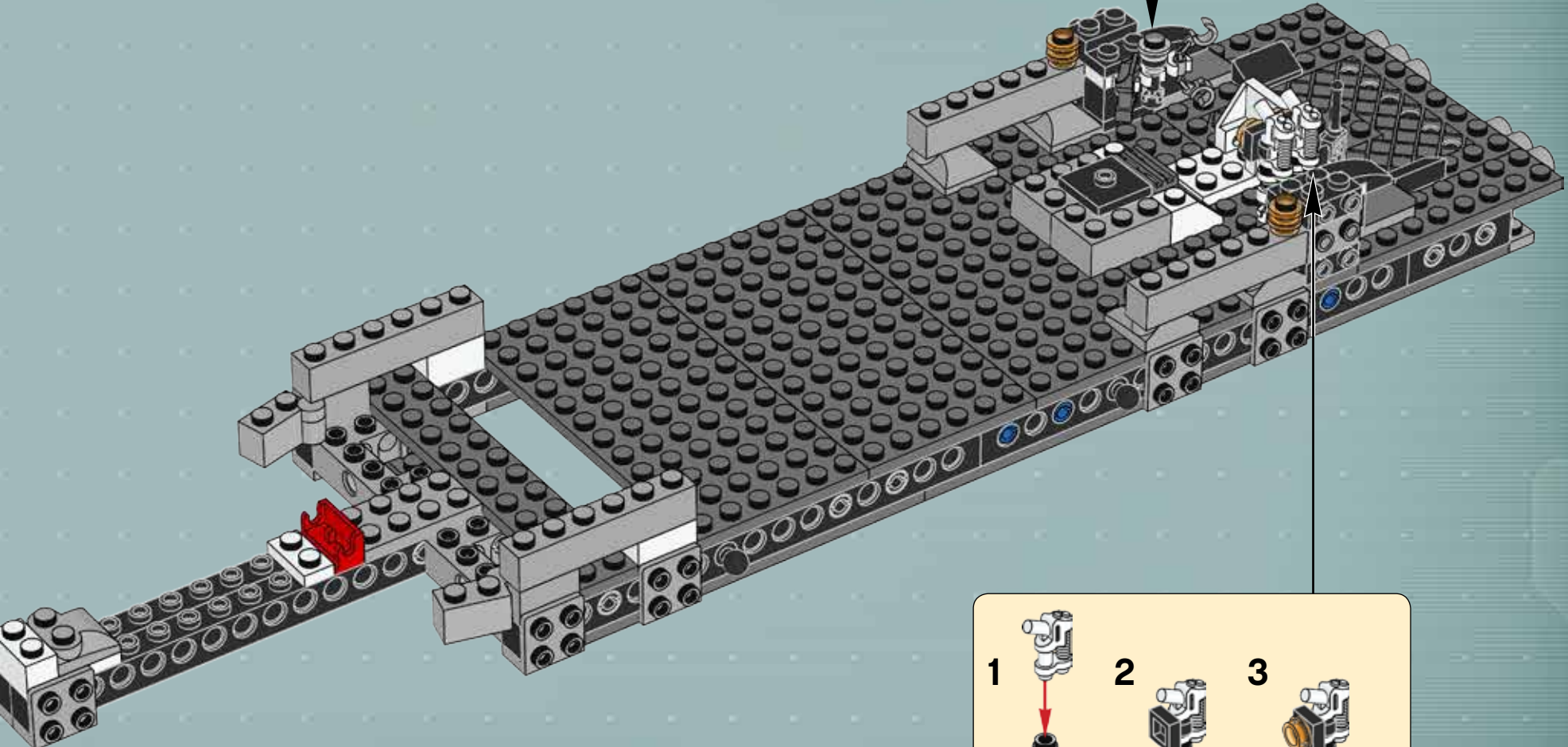
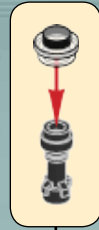

- 1 [Part]
 - 2 [Part]
 - 3 [Part]
- 2x





4x



2x

22

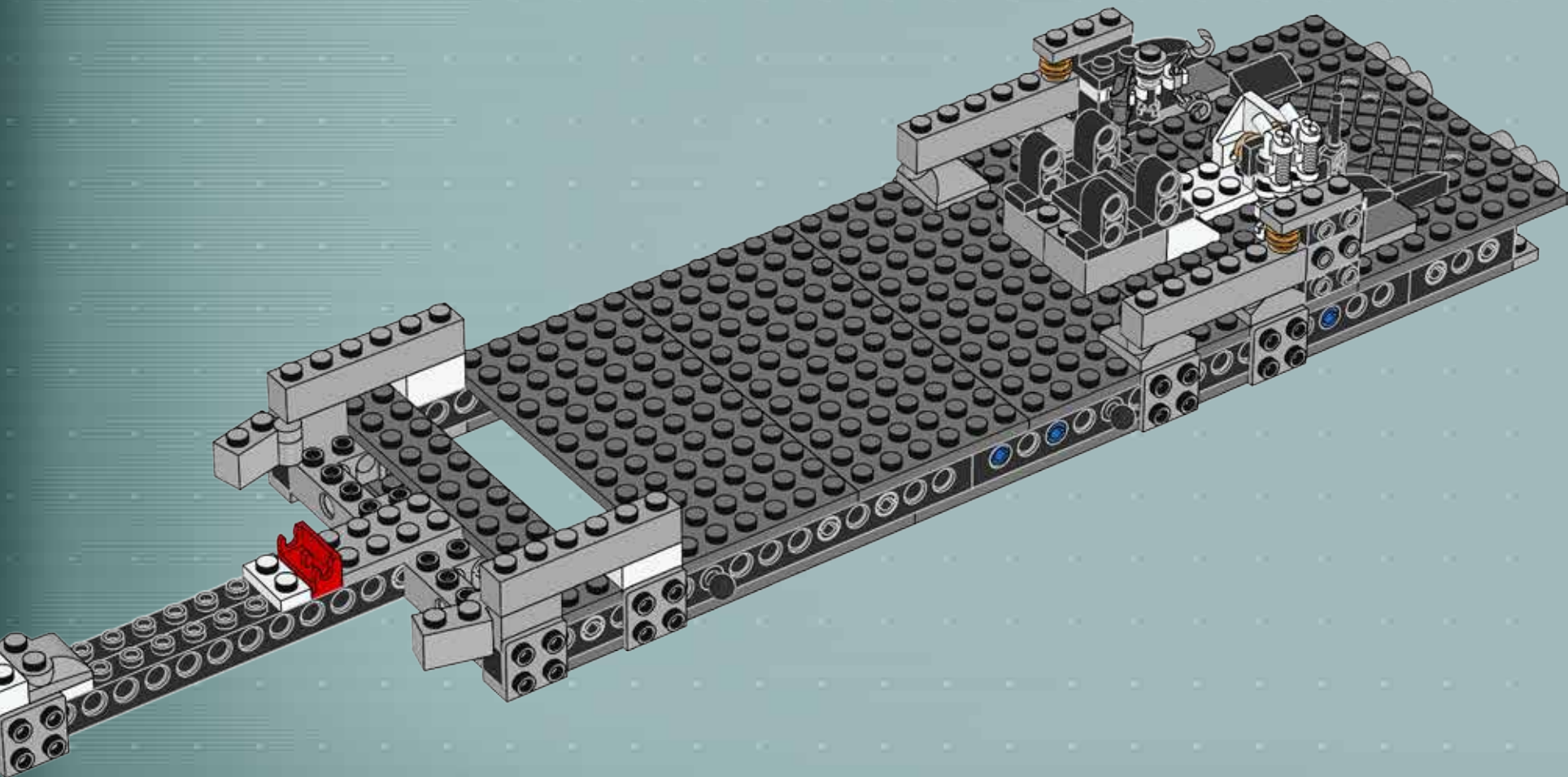

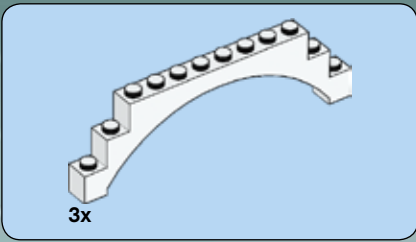

23

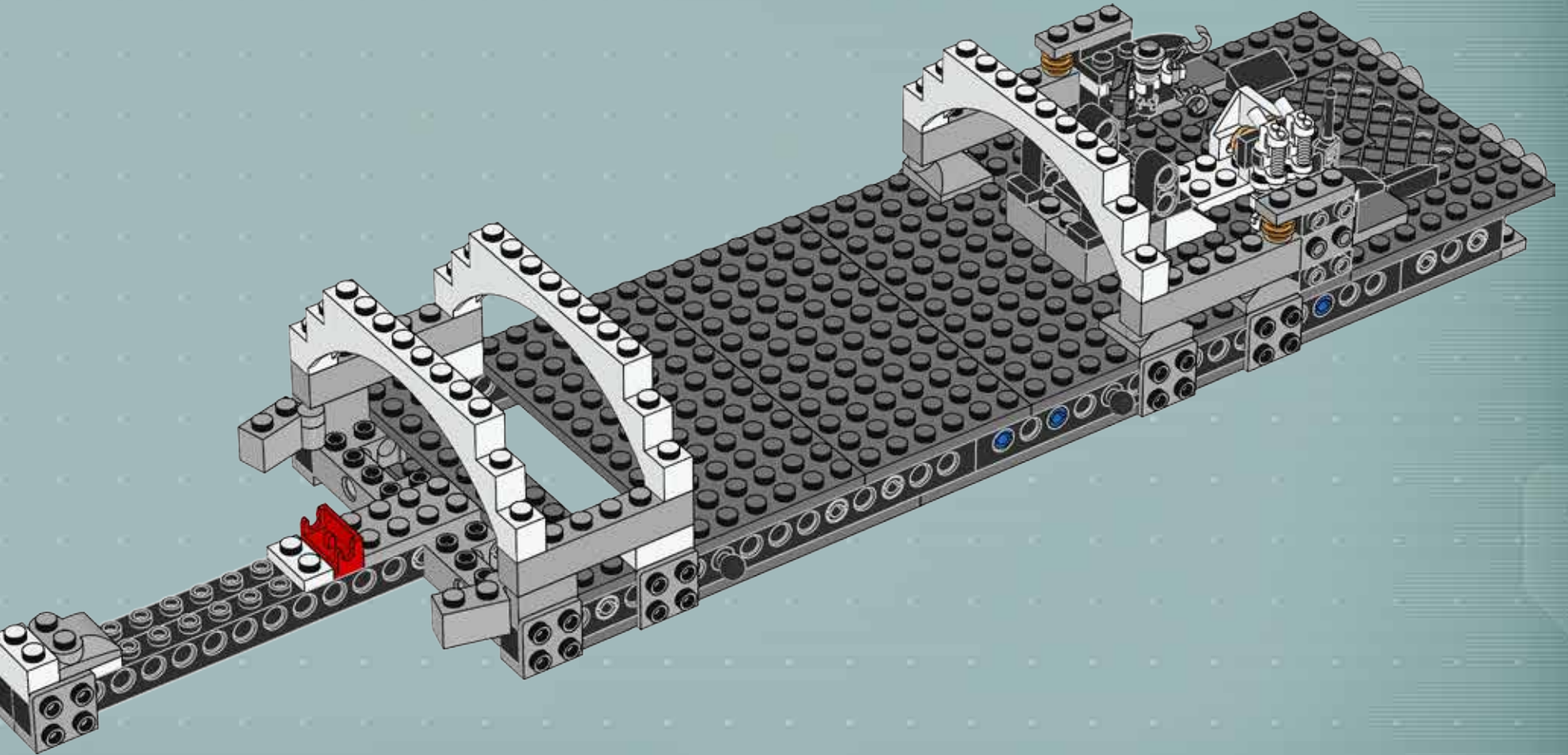

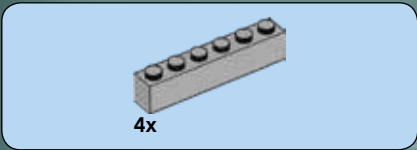

24

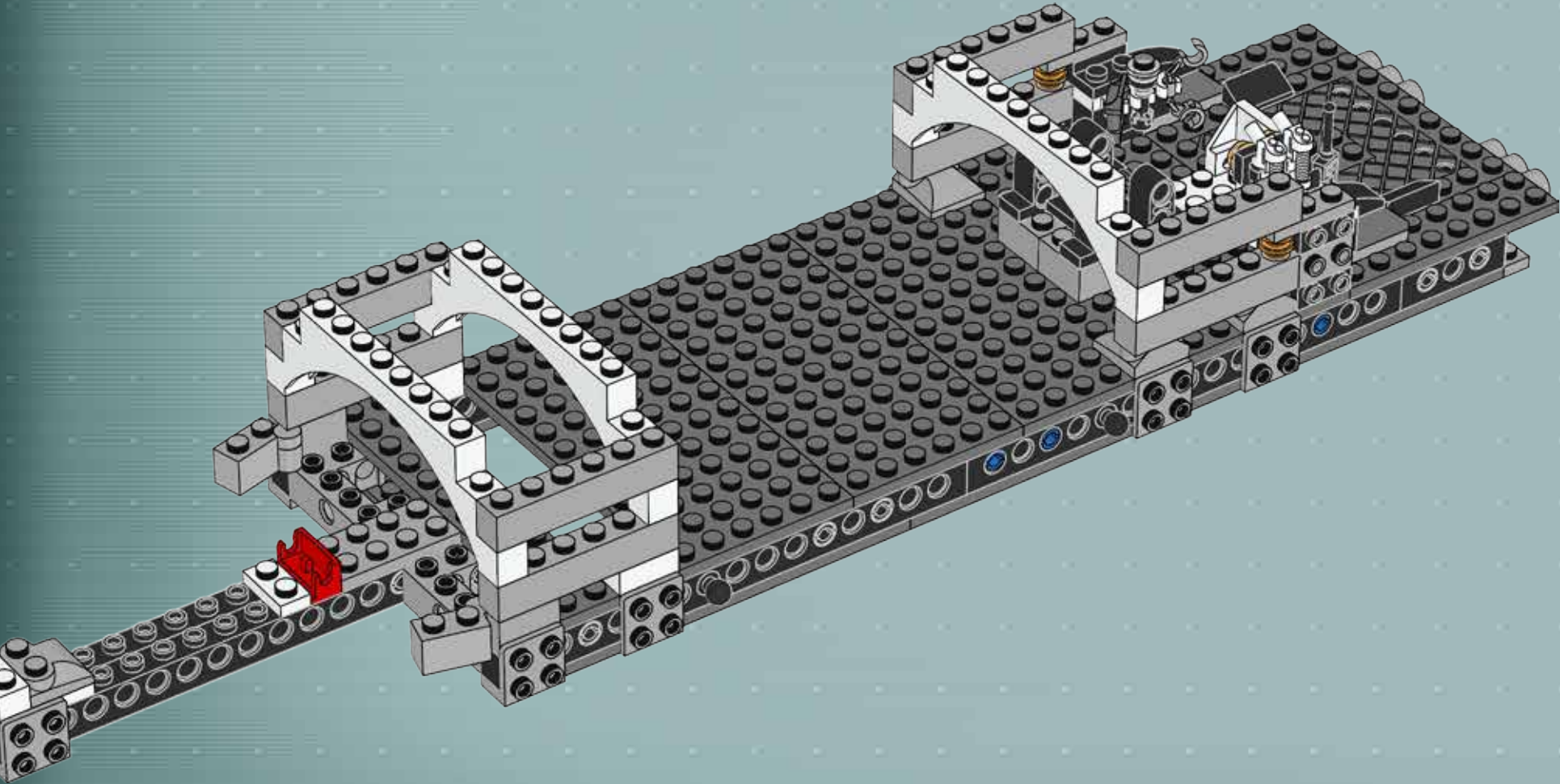

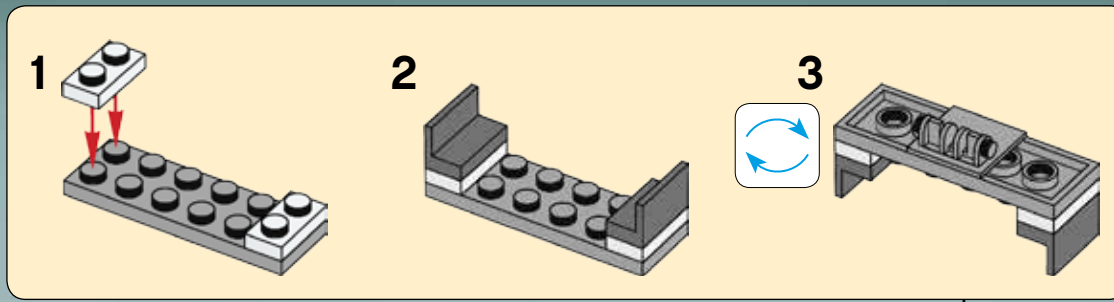
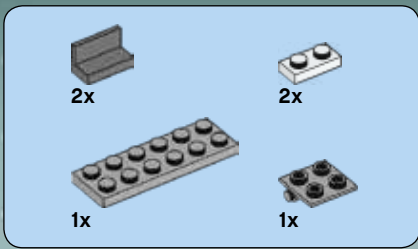

25

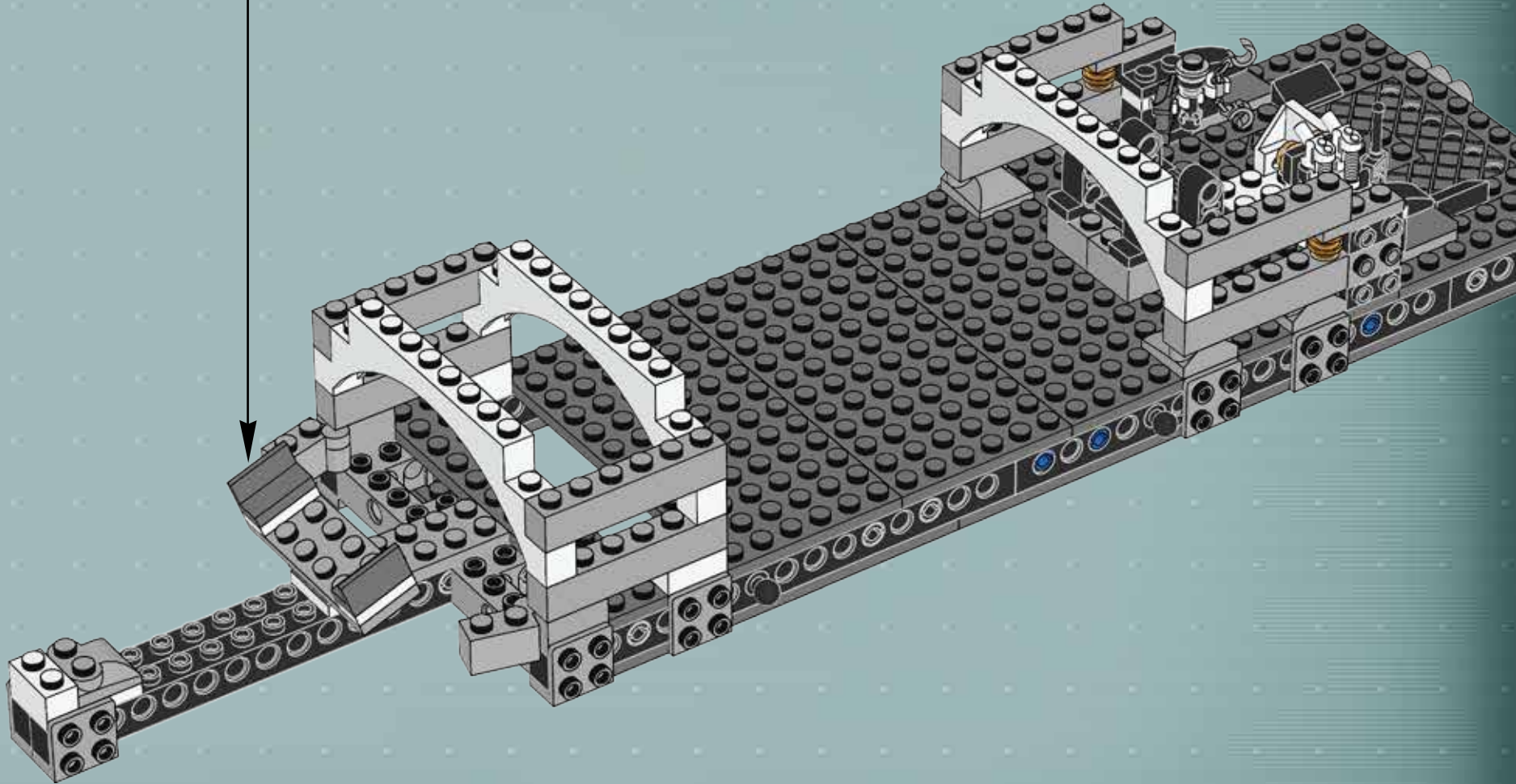

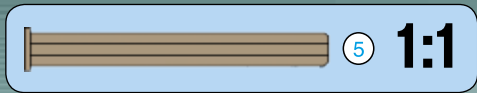
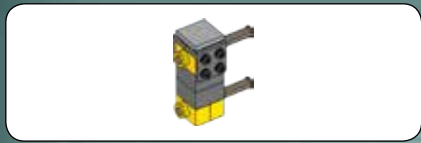

1

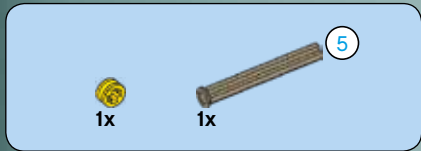
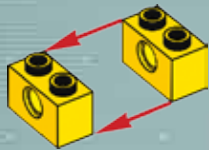

2

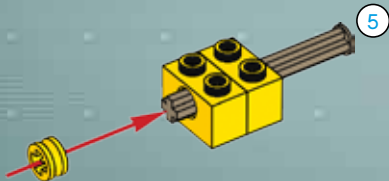

3

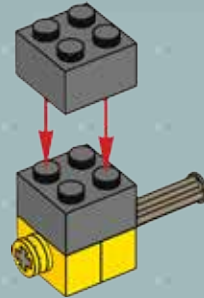

4

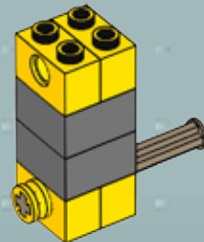

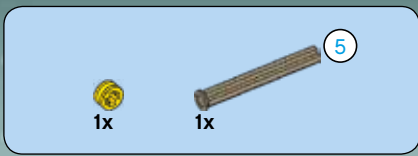

5

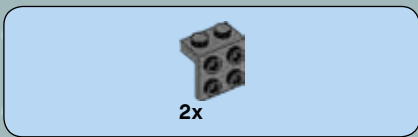
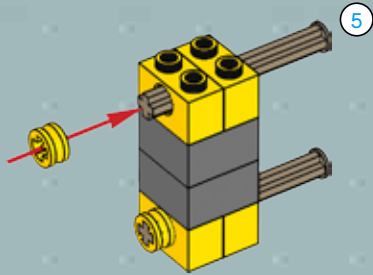

6

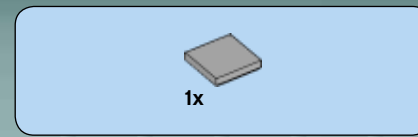
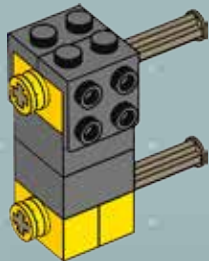

7

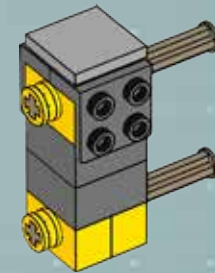

26

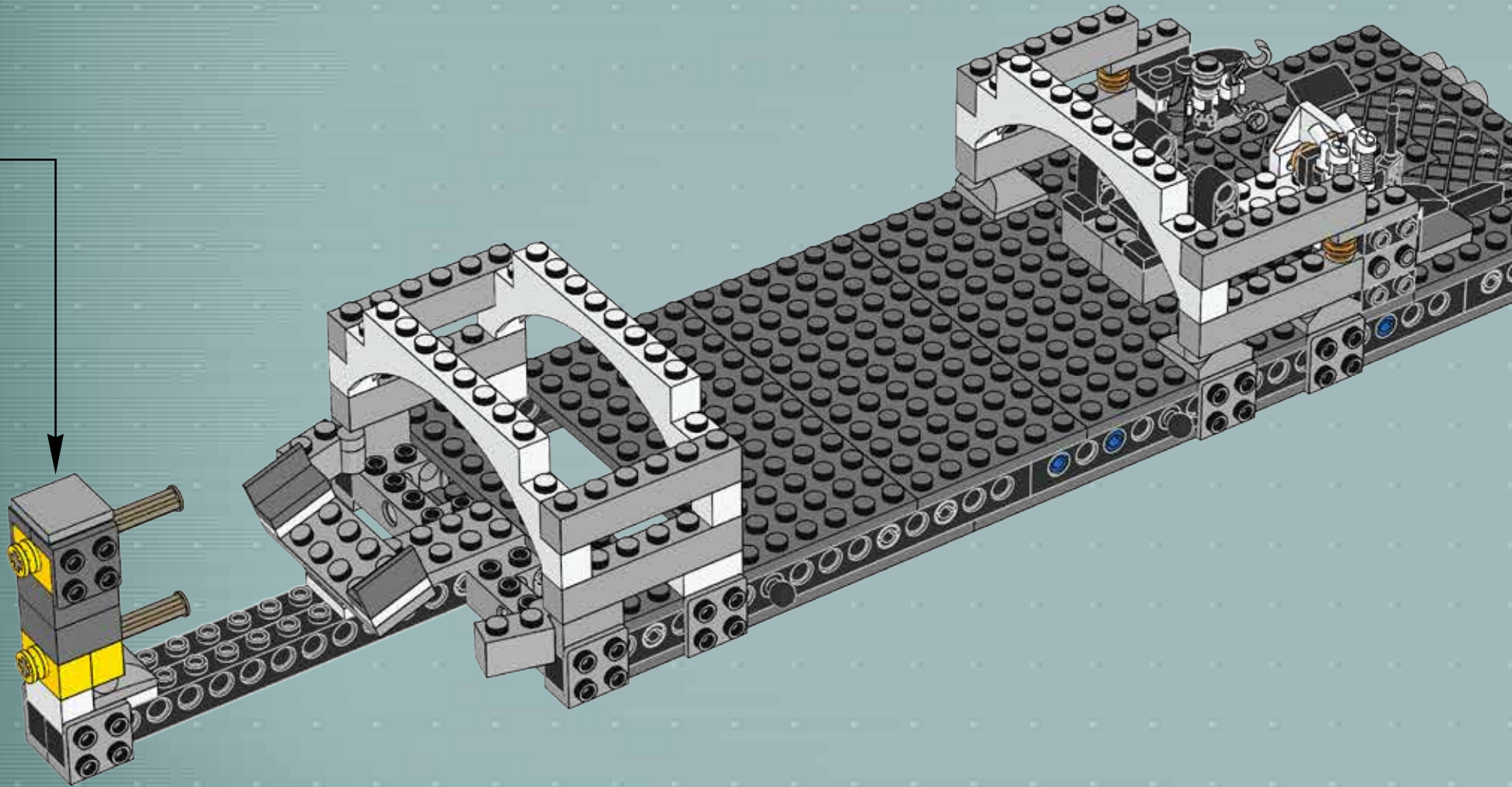

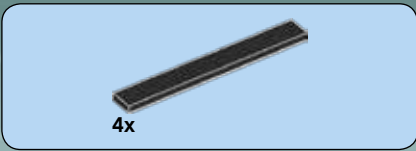

27

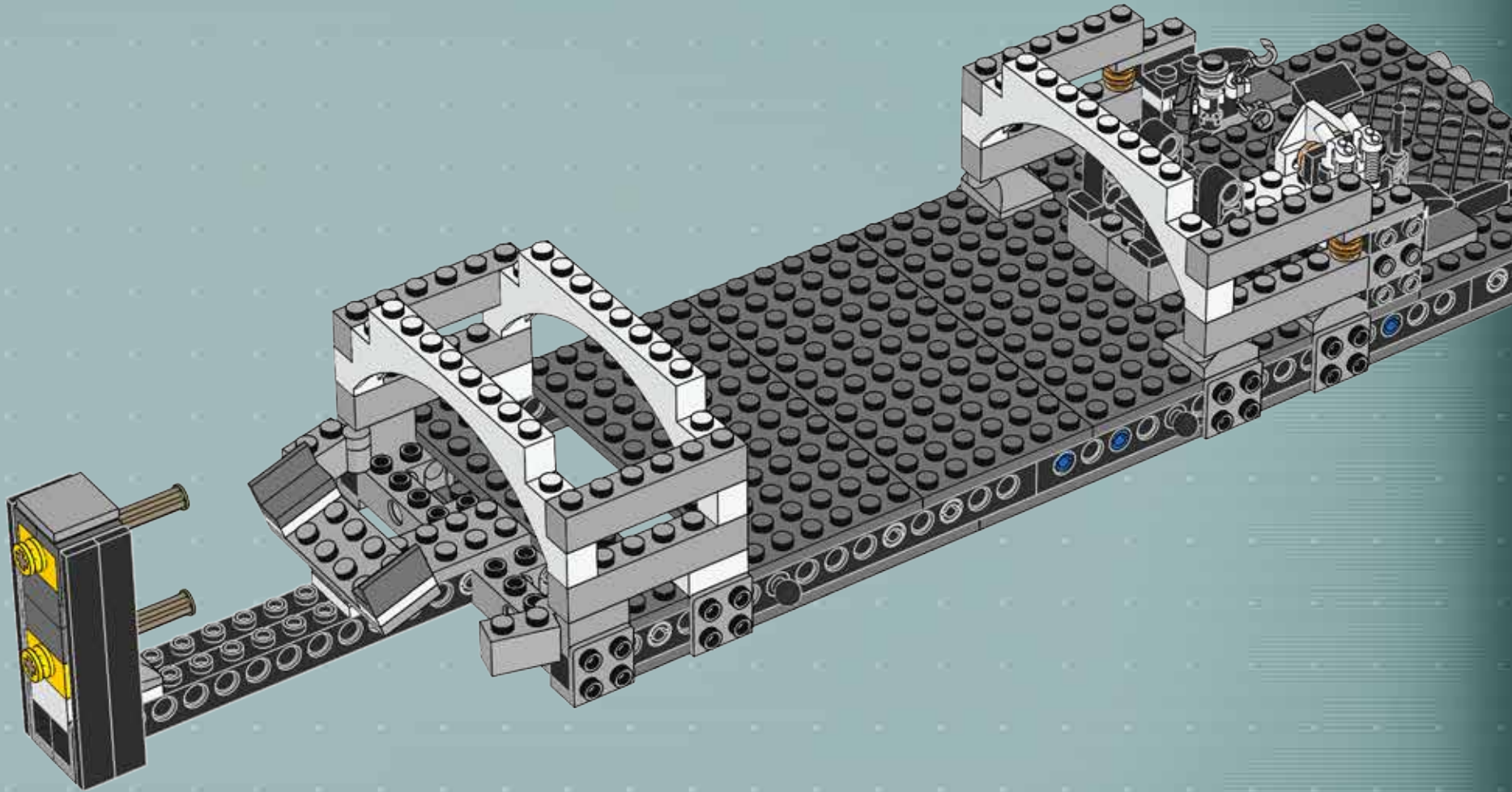

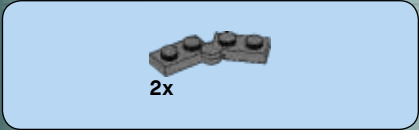
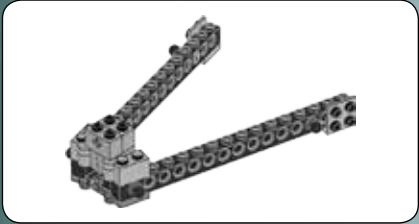
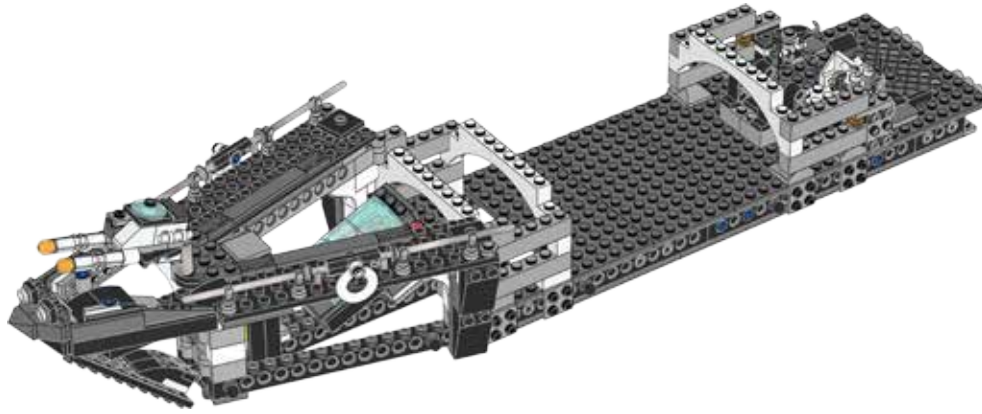
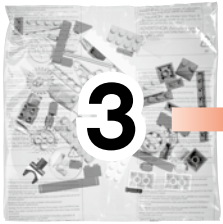

1

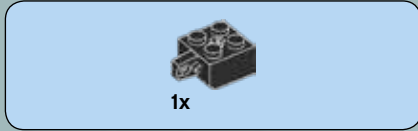
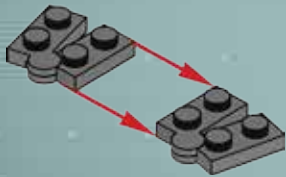

2

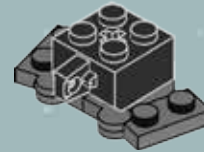

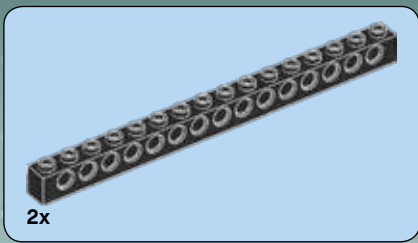

3

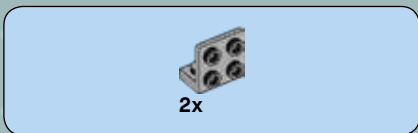
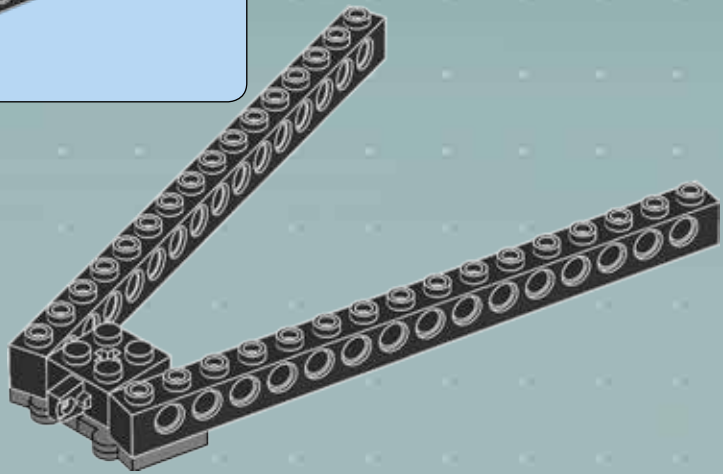

4

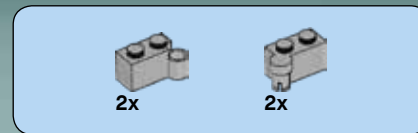
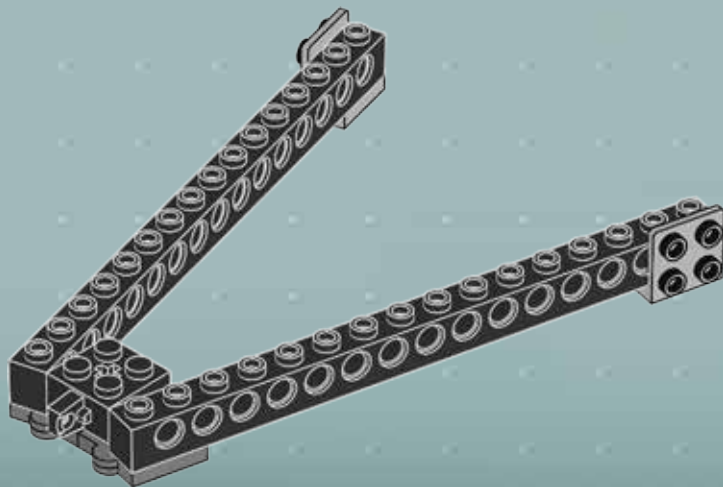

5

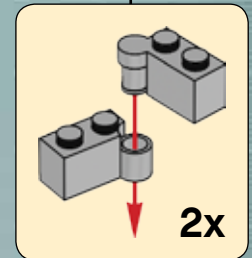
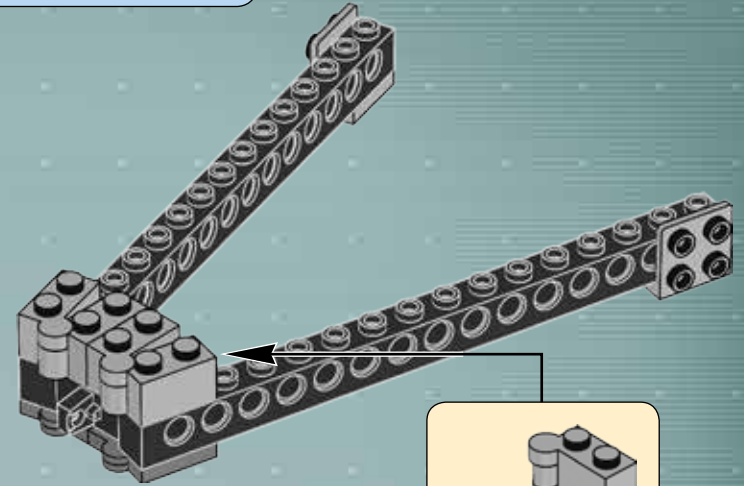

6

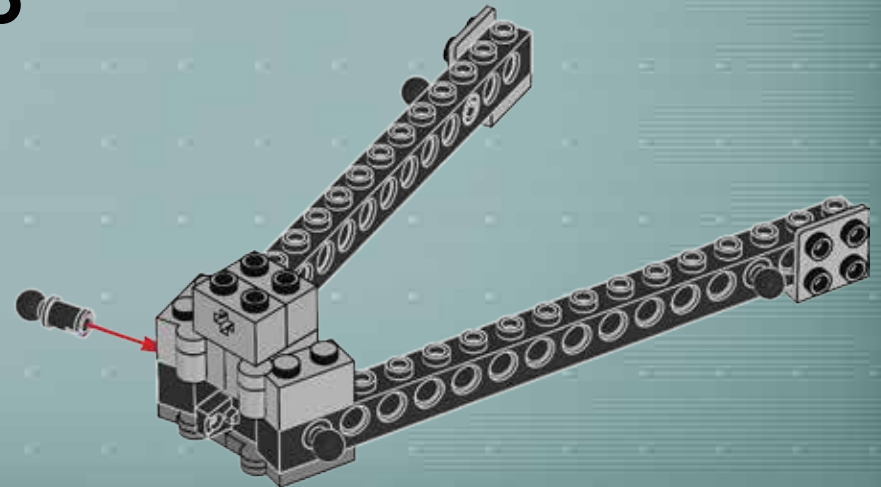

28

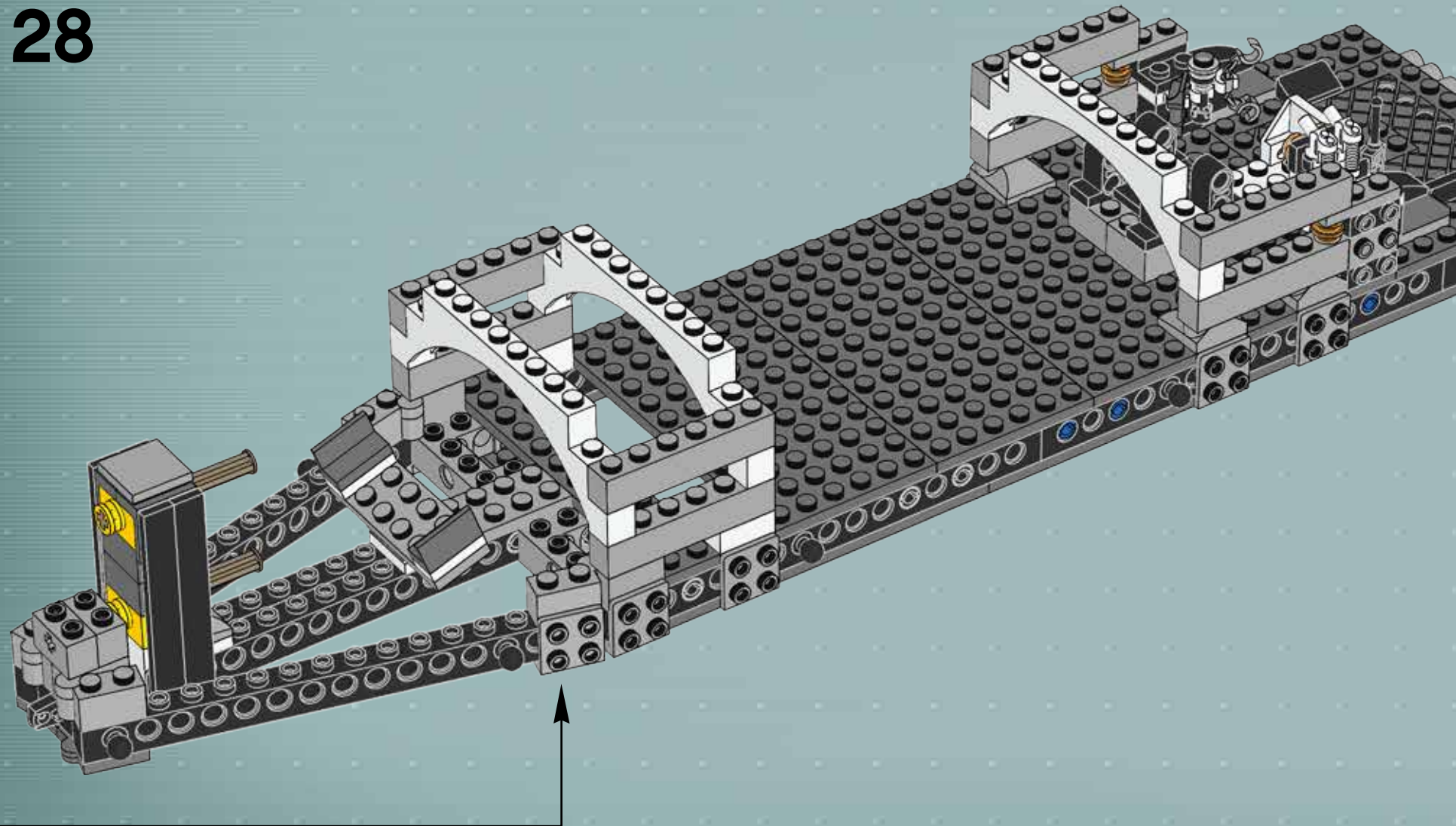

29

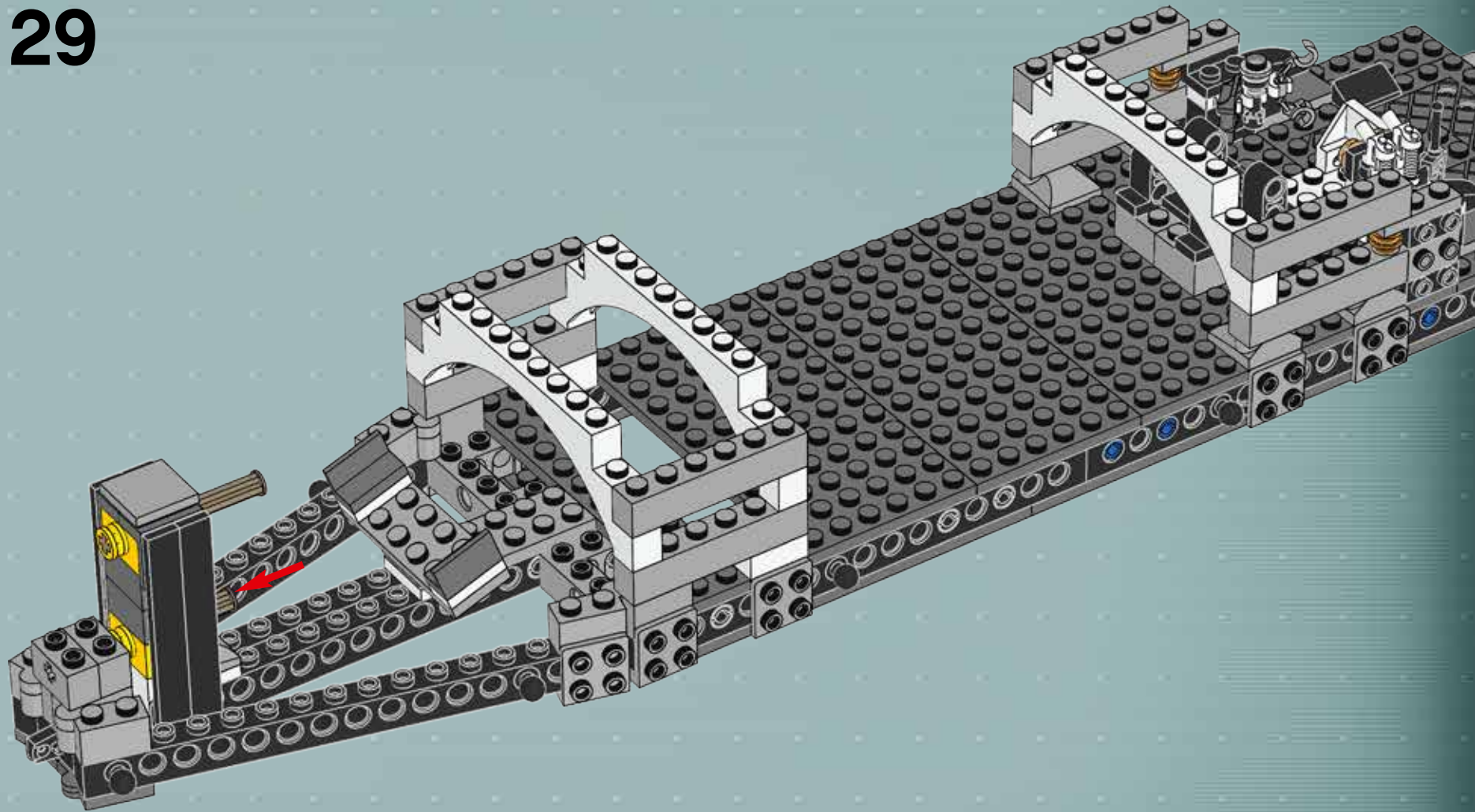

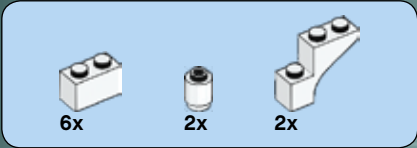

30

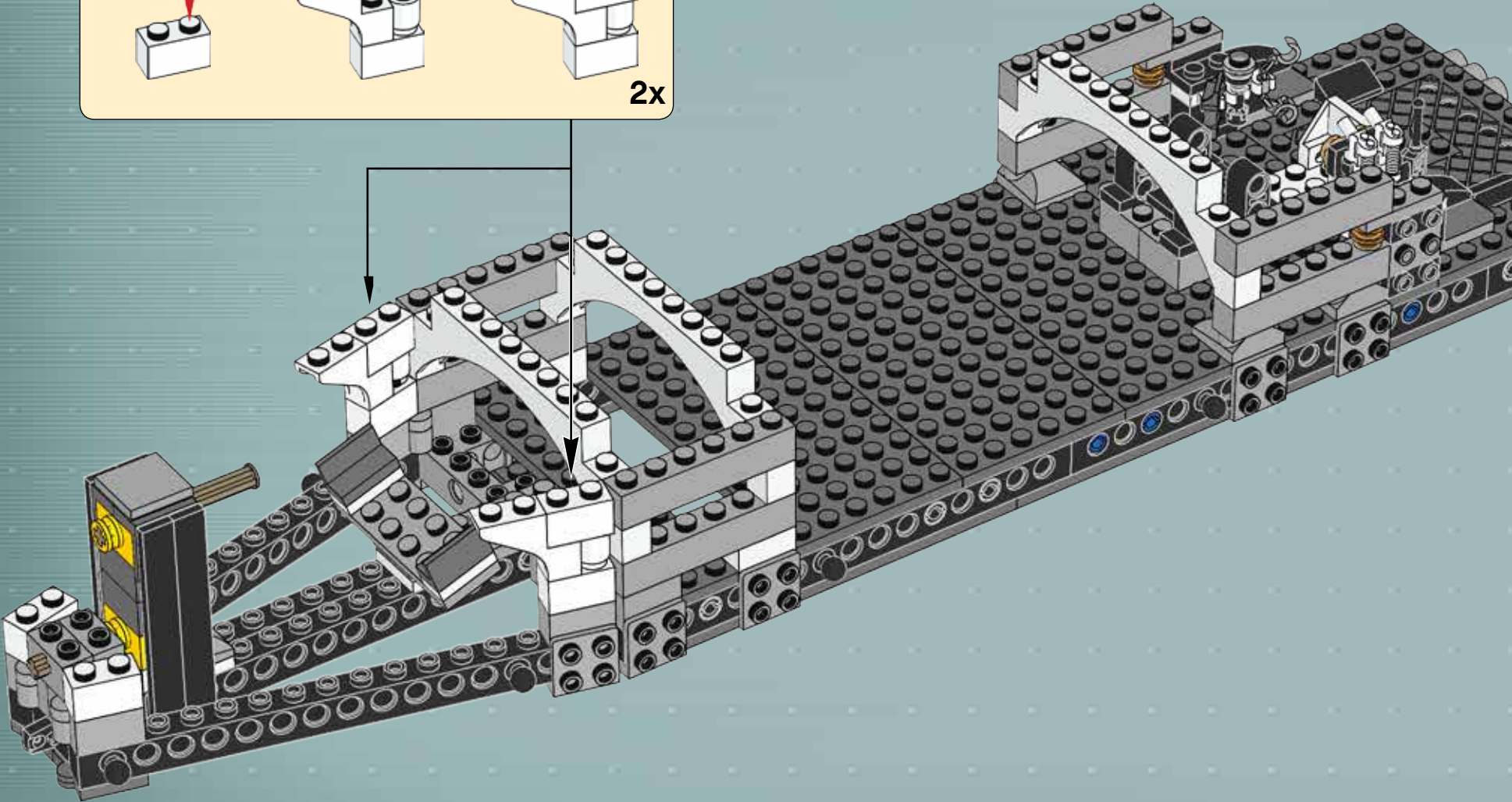
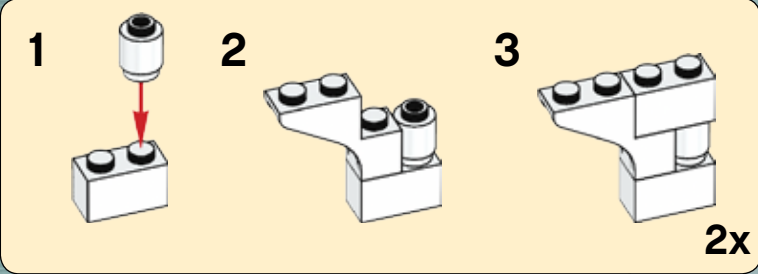



2x



2x

31

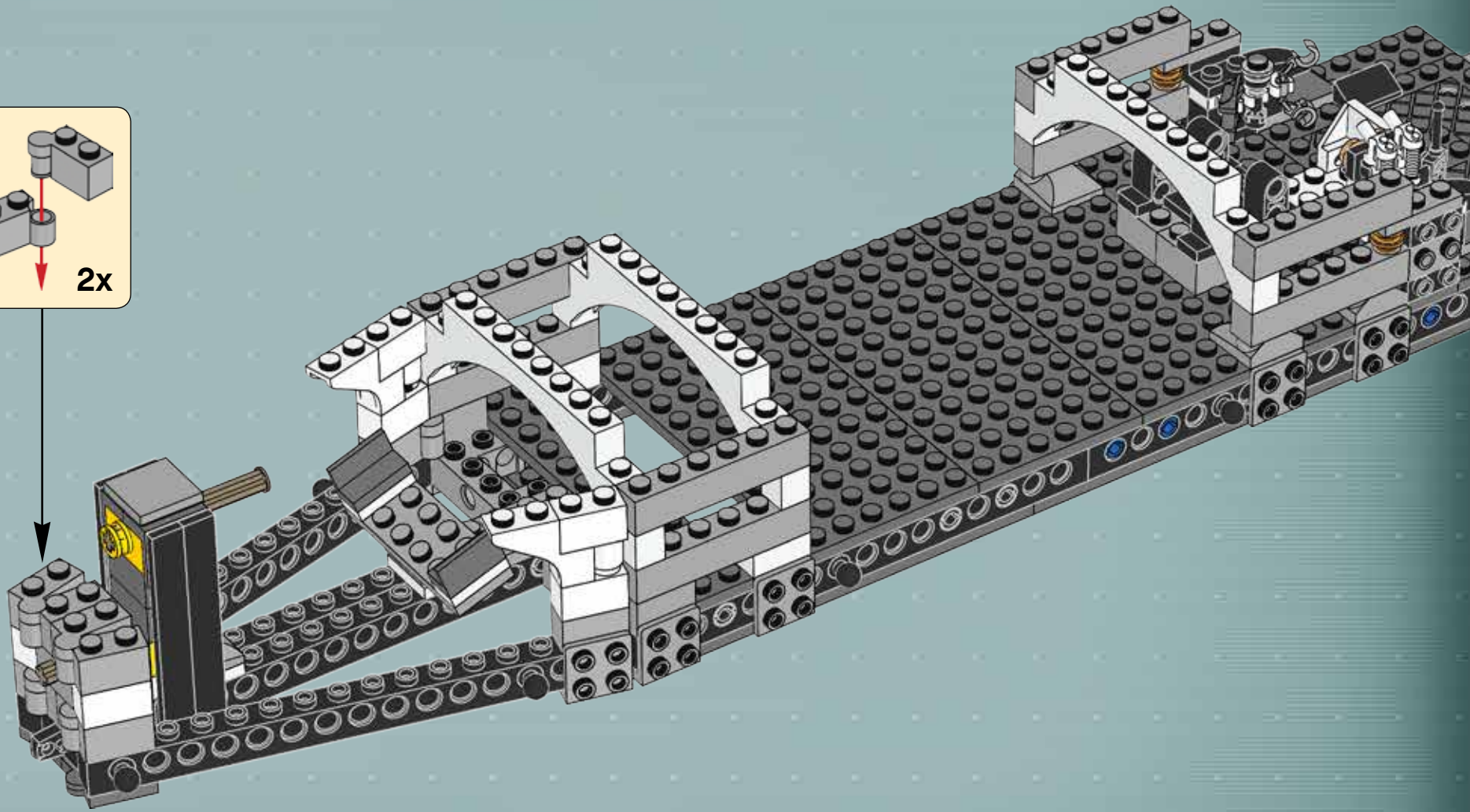
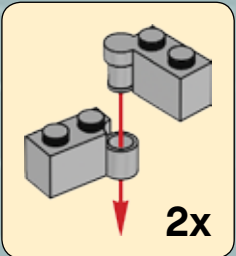

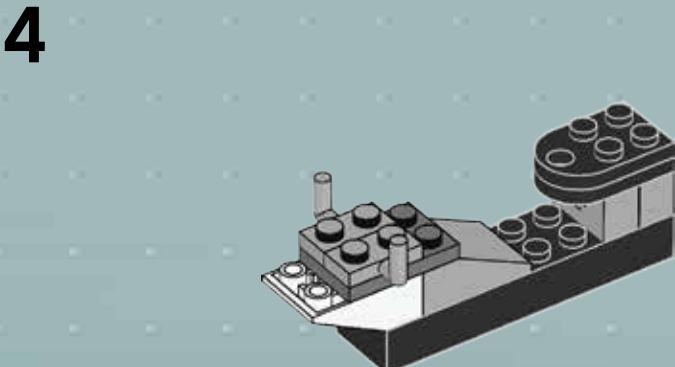
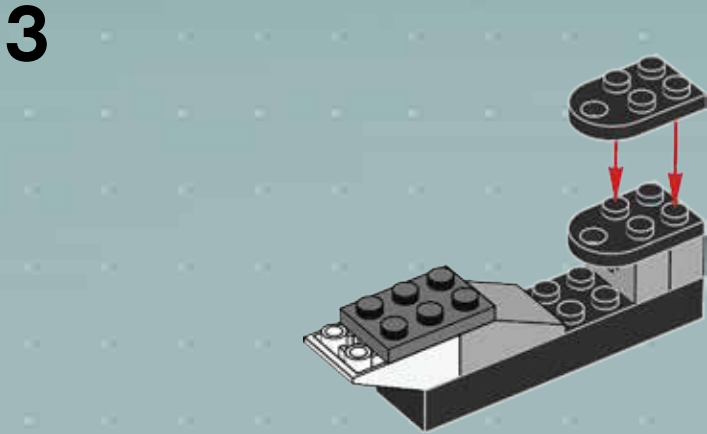
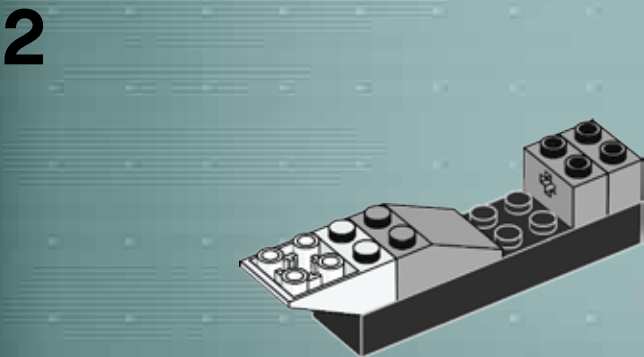
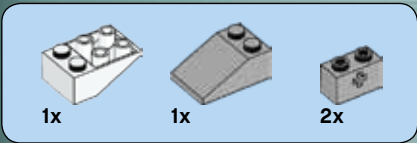
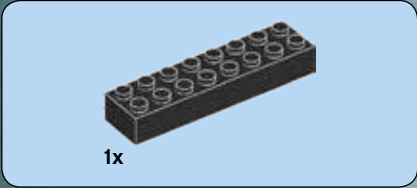
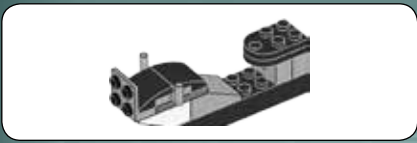



5

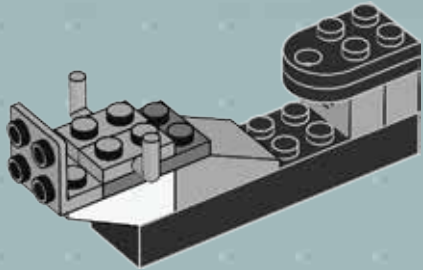

6

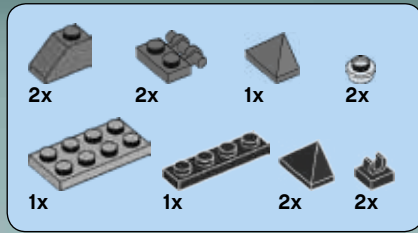
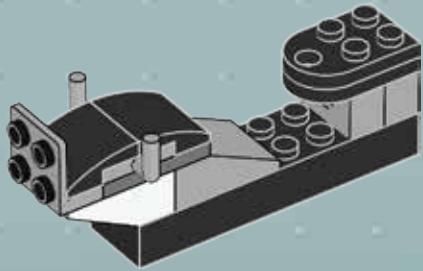

7

1



2

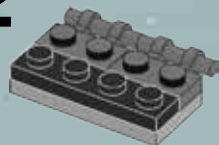

3

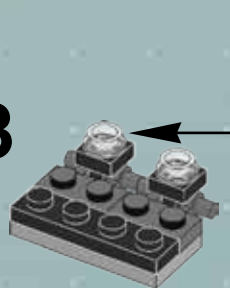

4



5

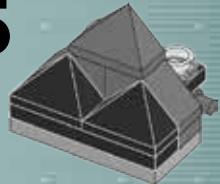

32

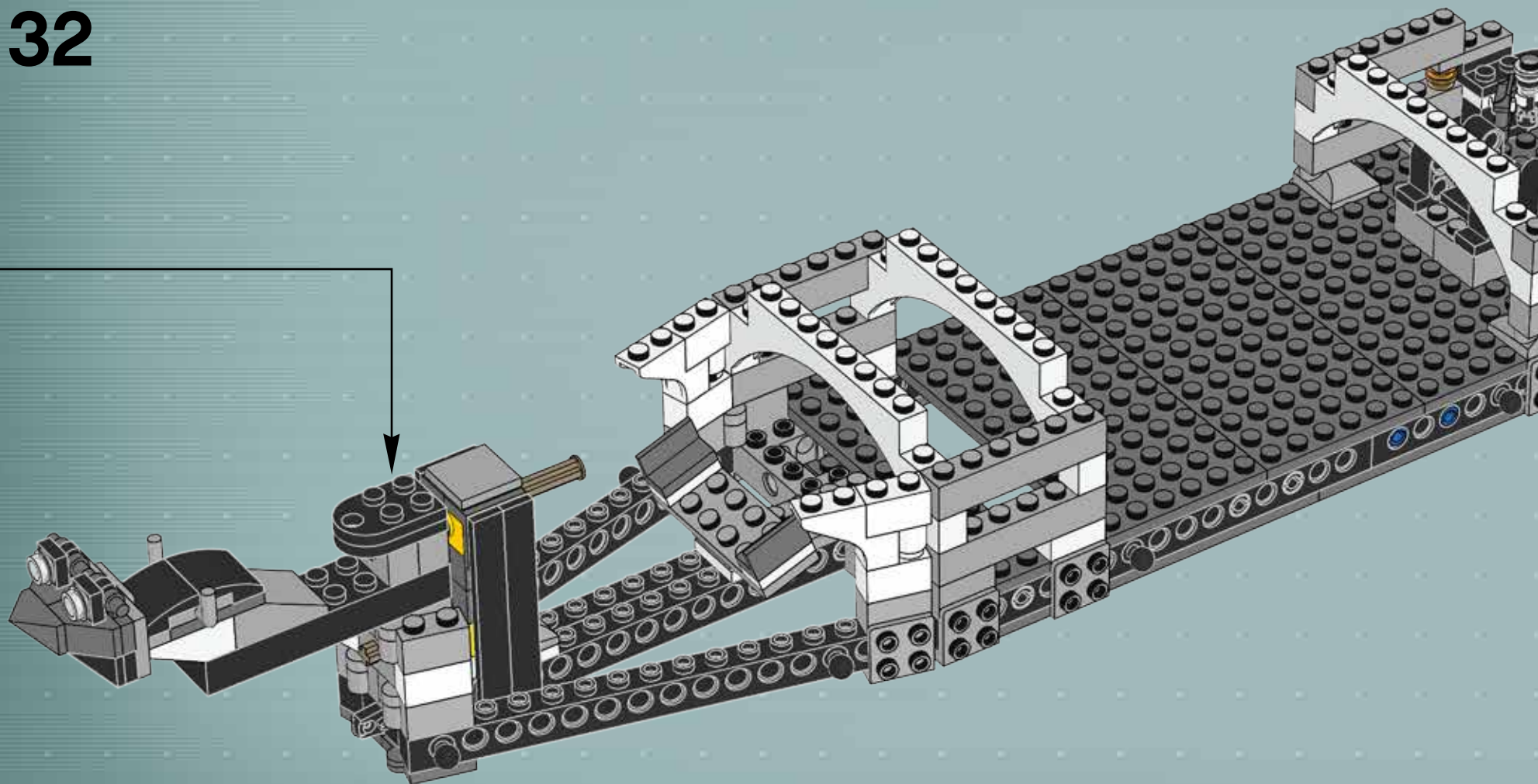

33

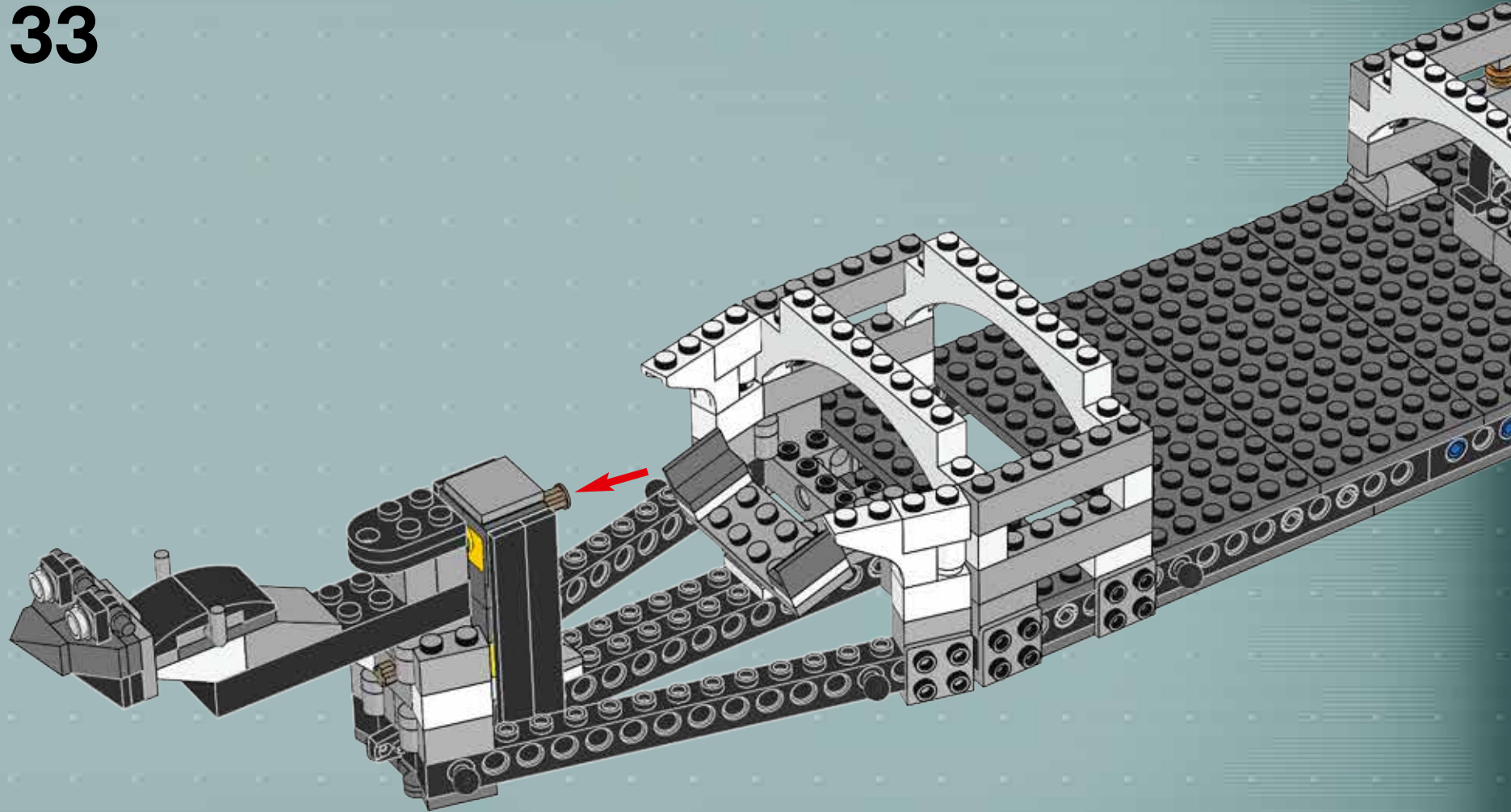

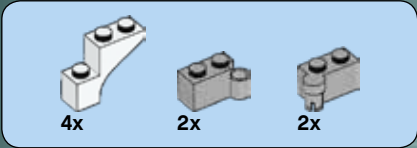

34

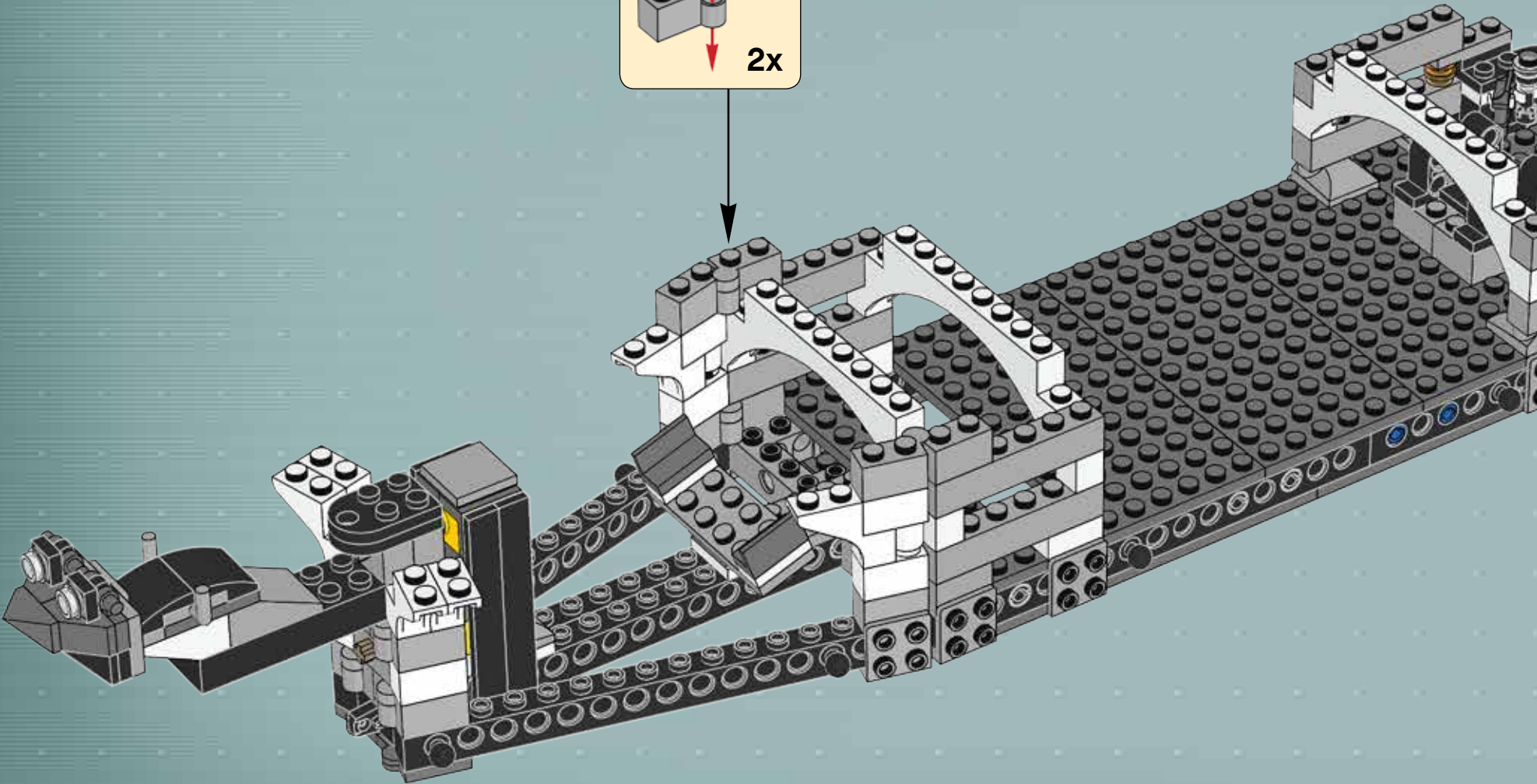
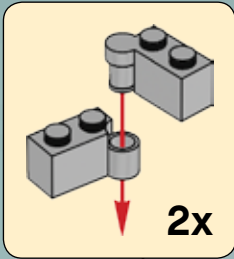

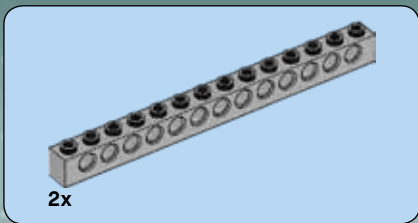

35

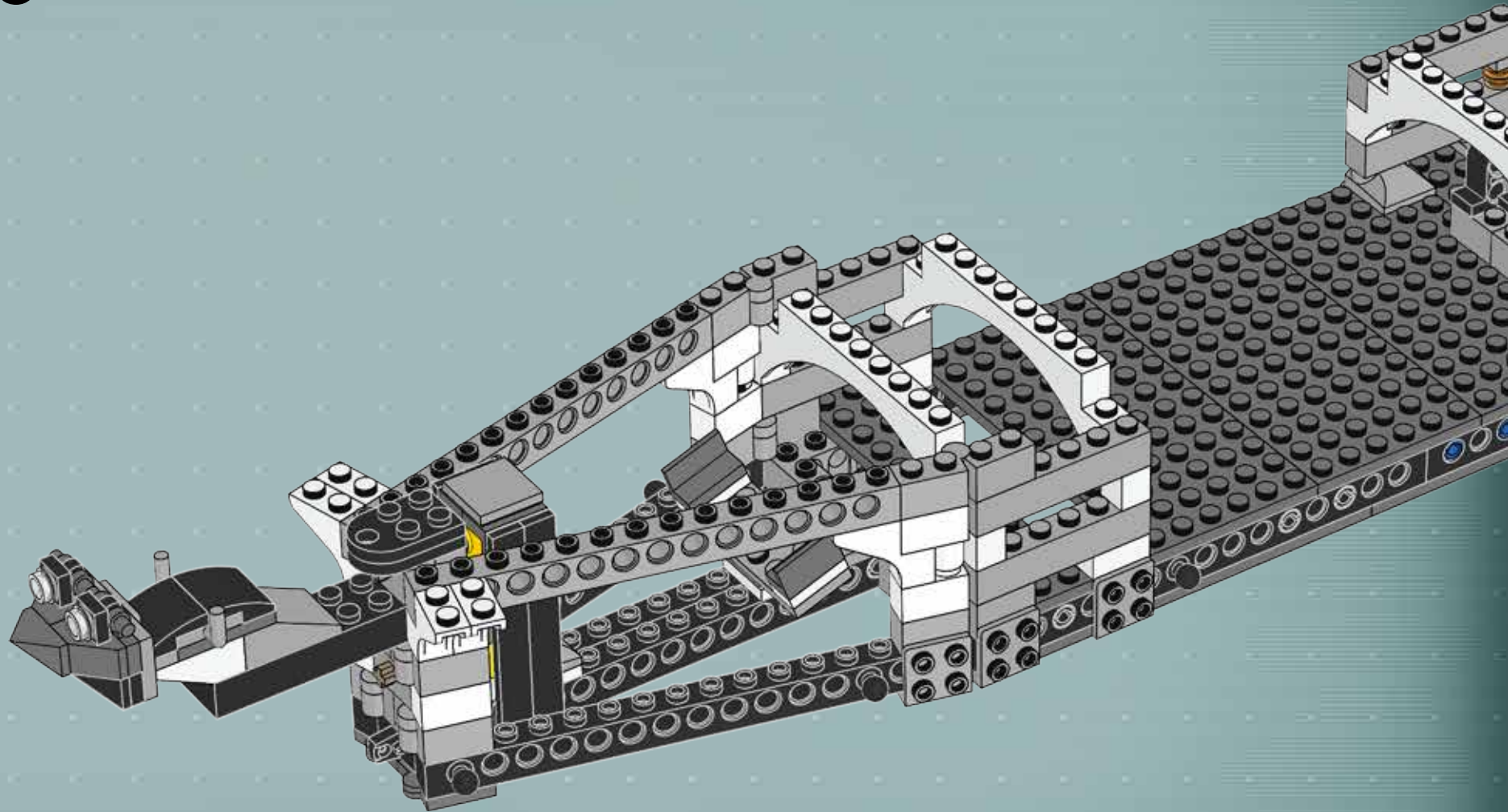

36

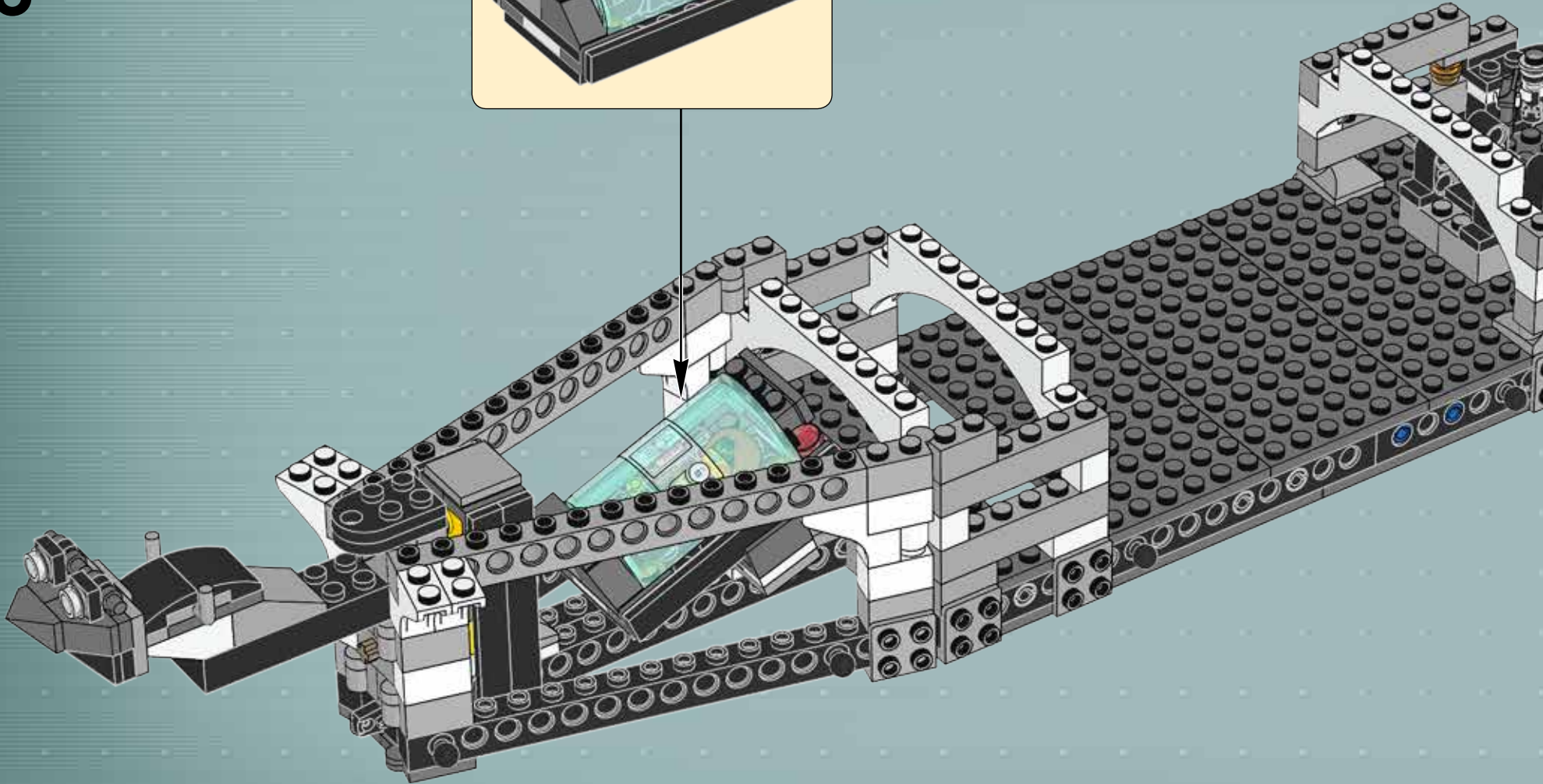
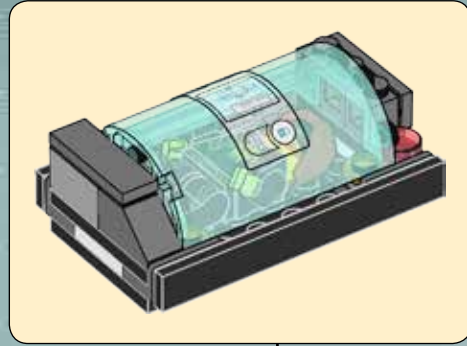

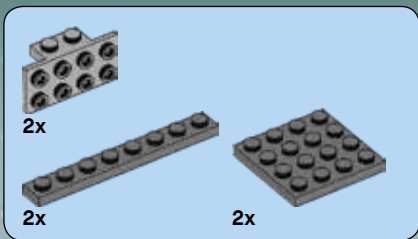

37

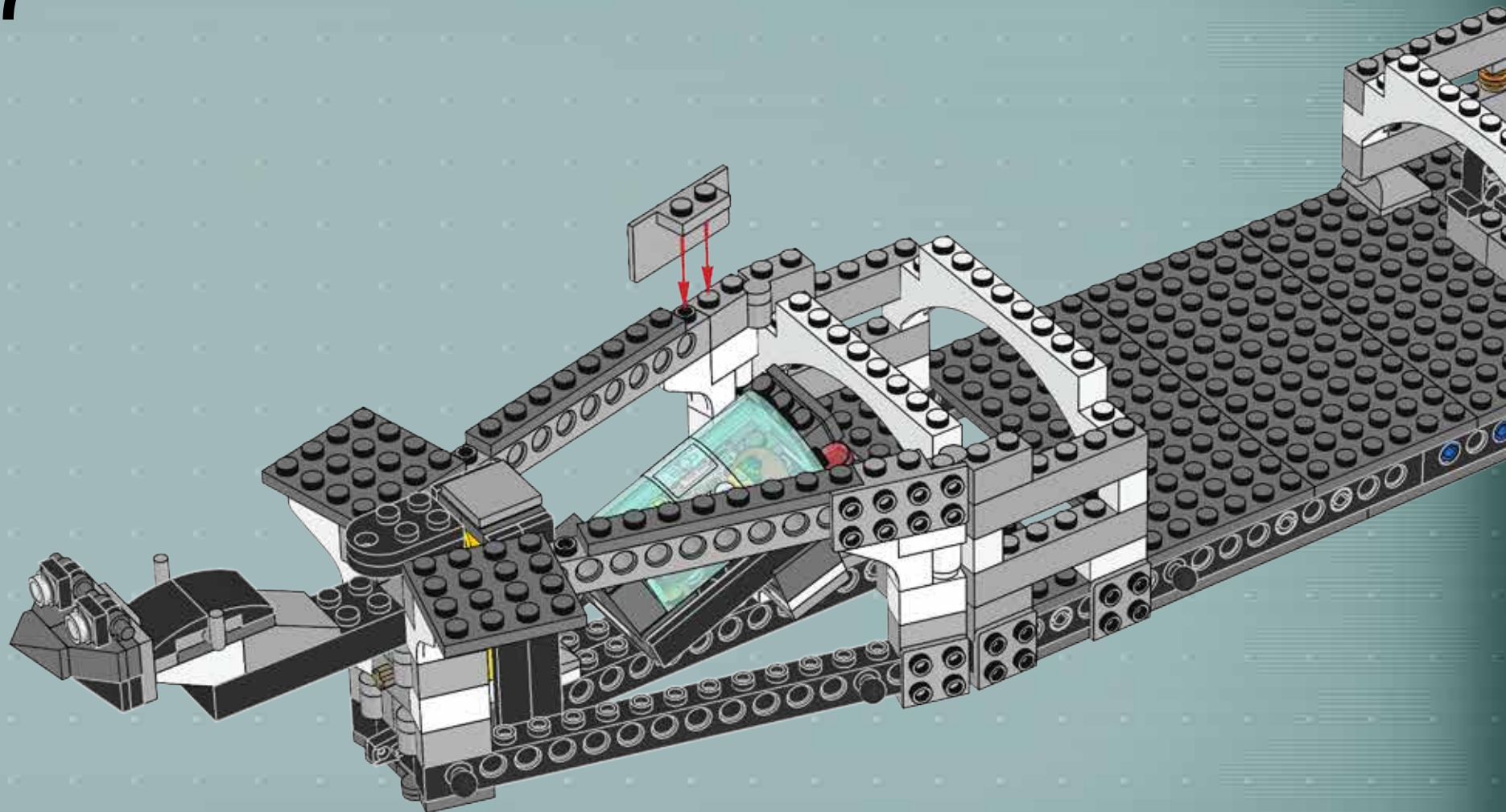

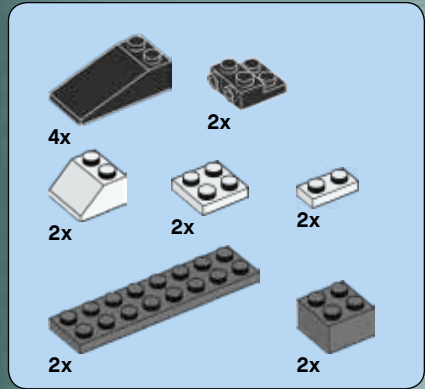

38

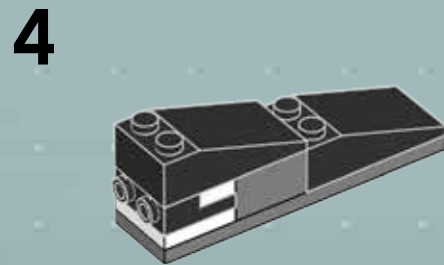
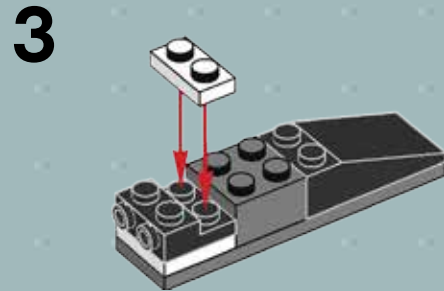
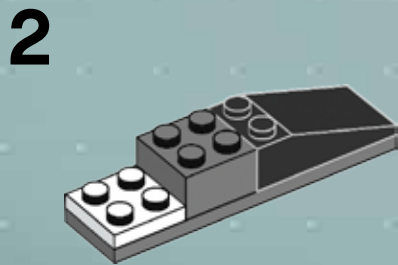
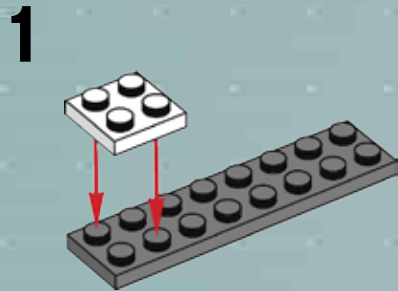

2x

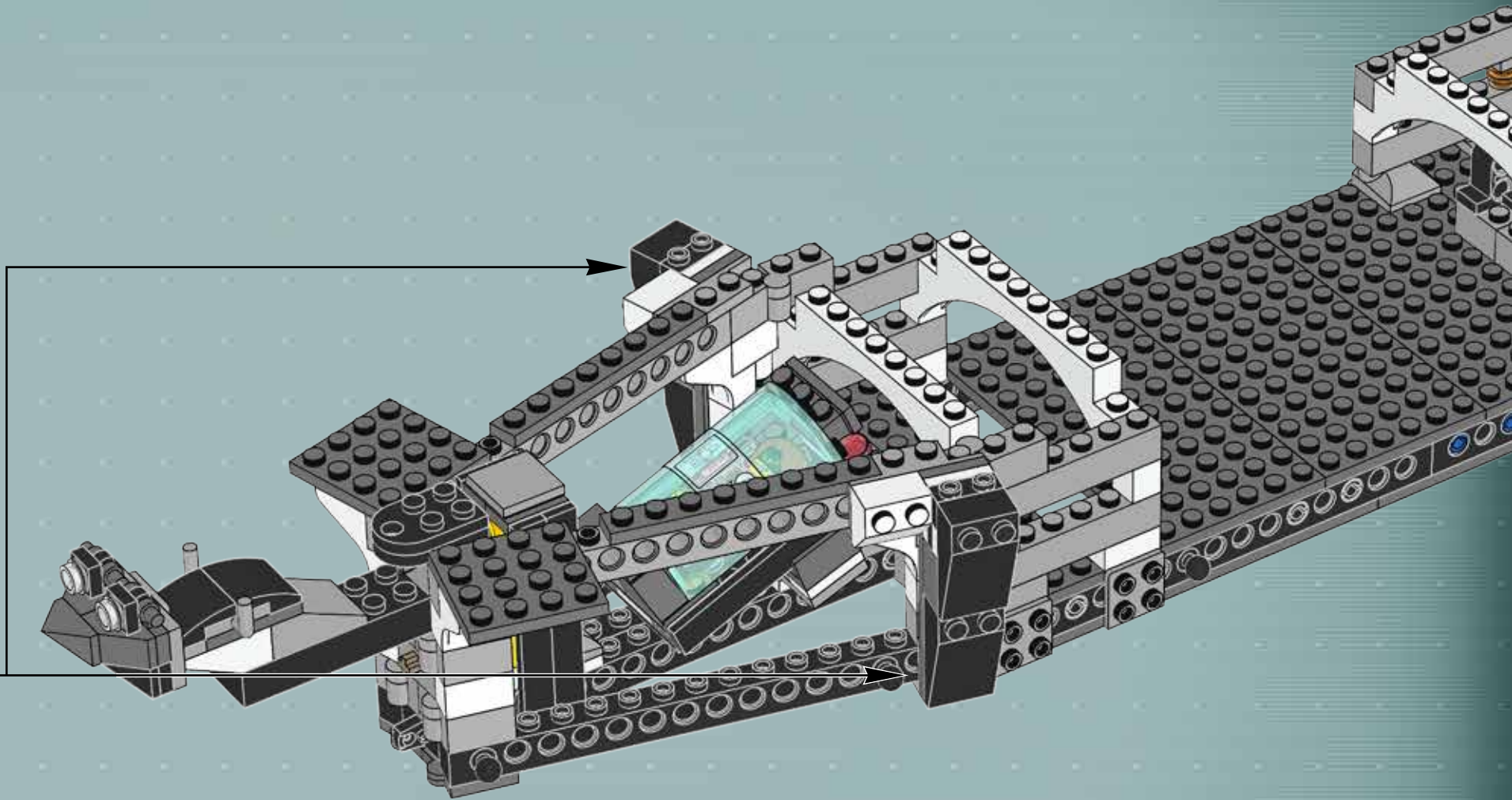

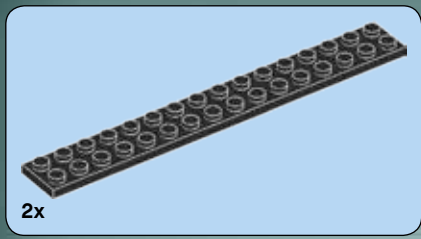

39

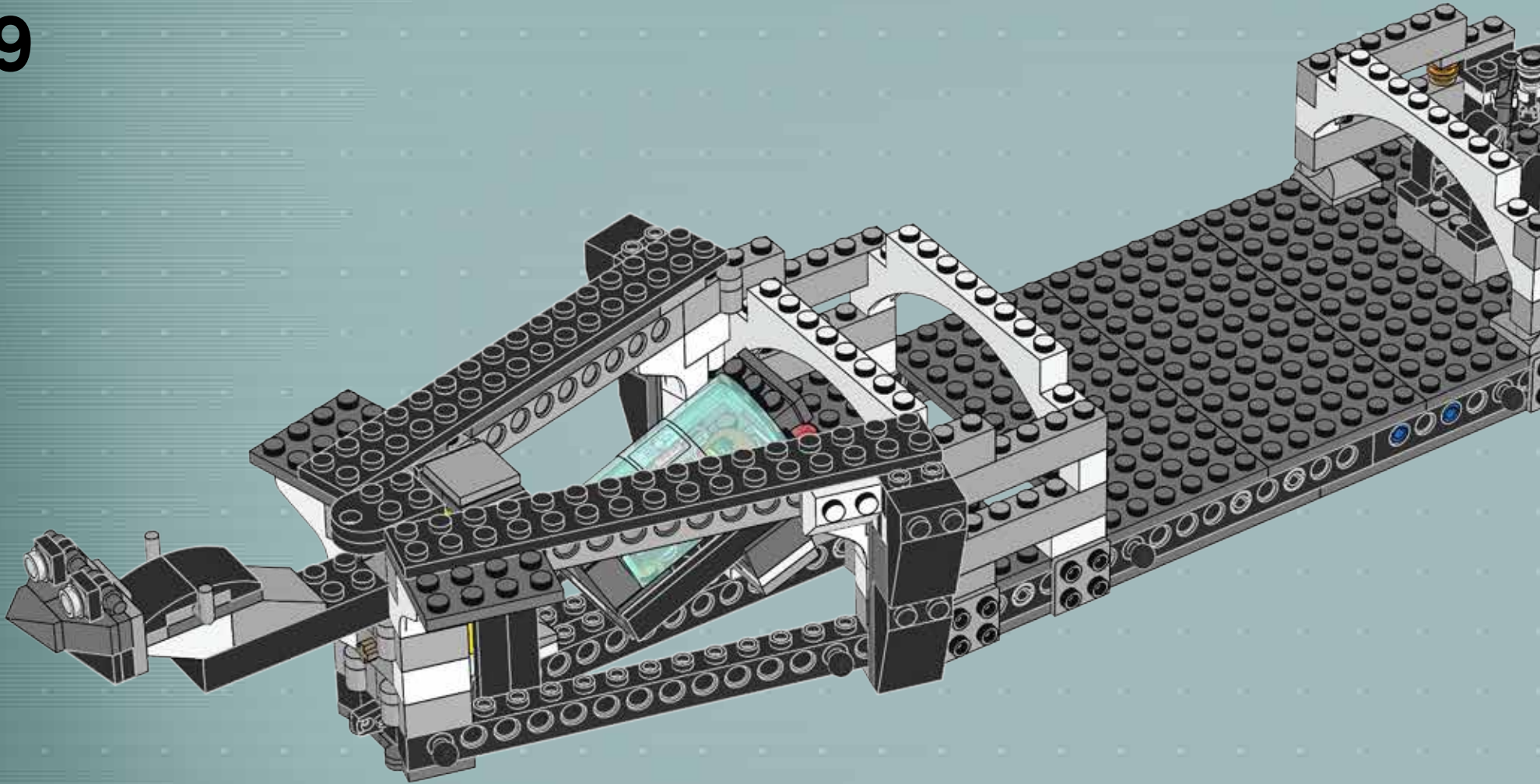



2x

40

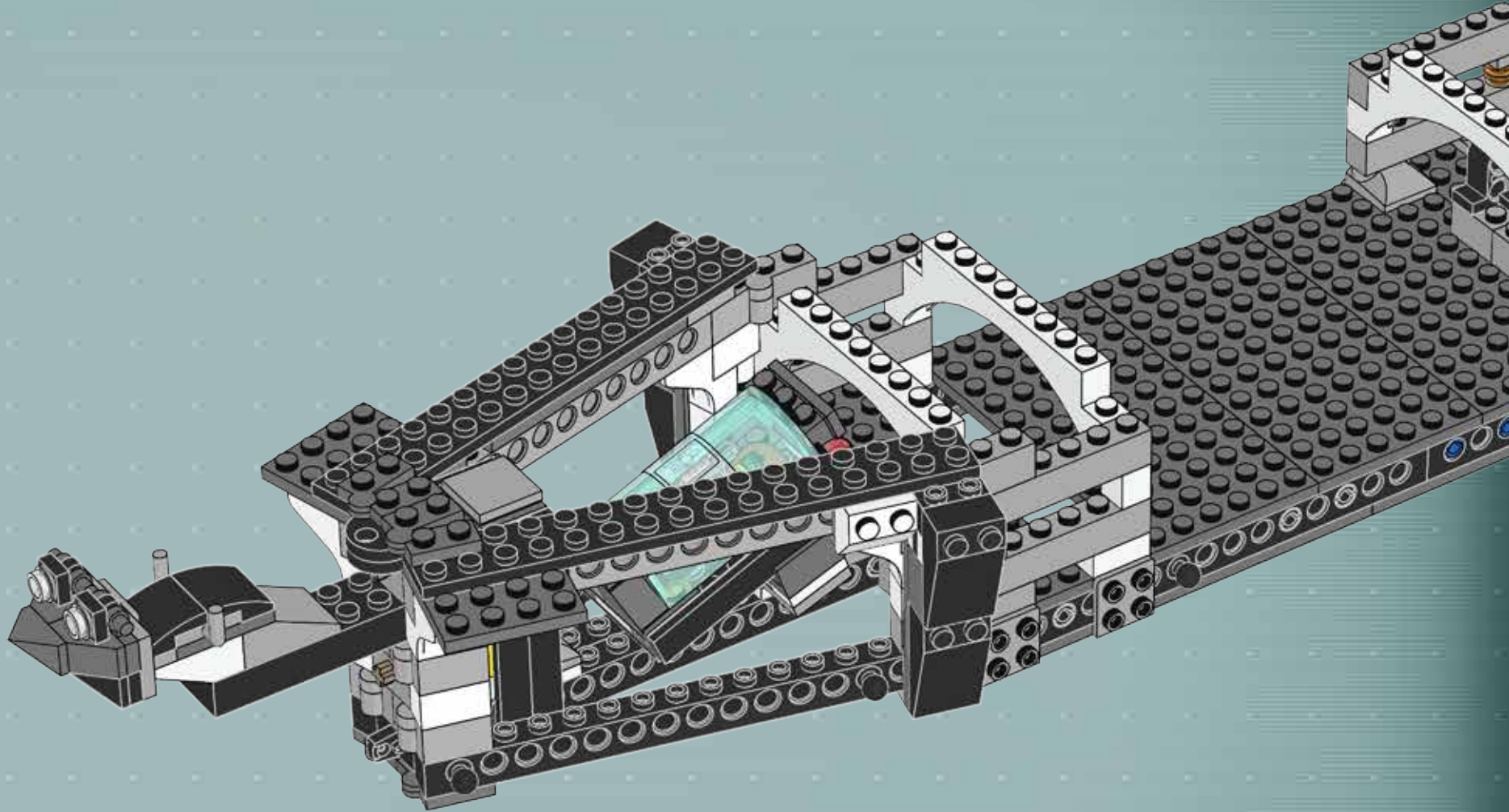

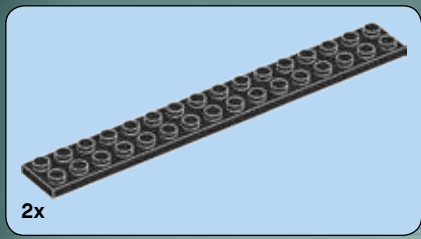

41

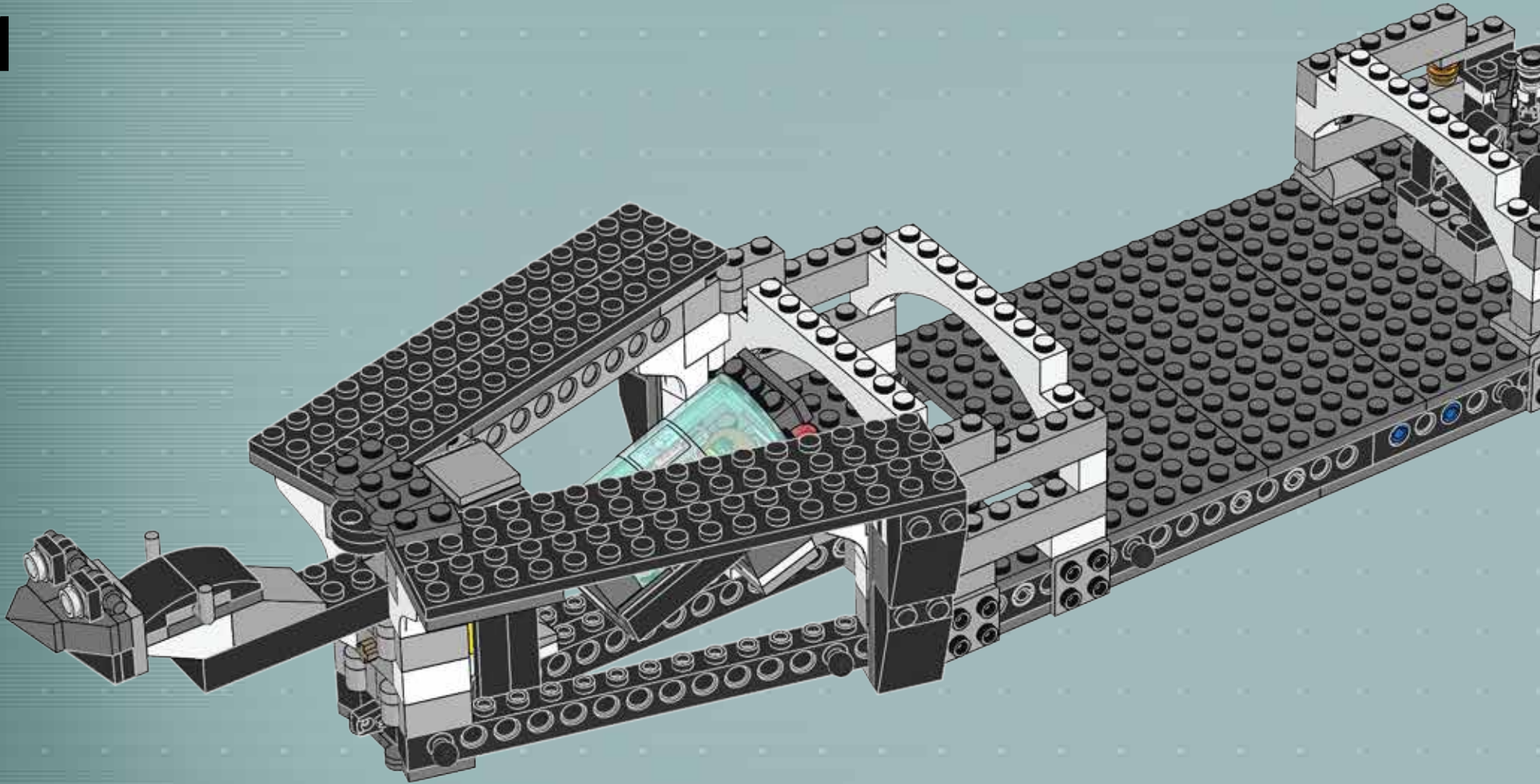

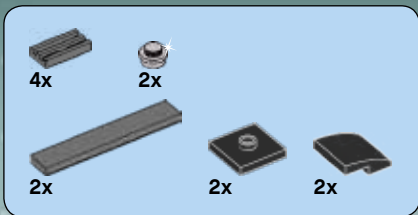

42

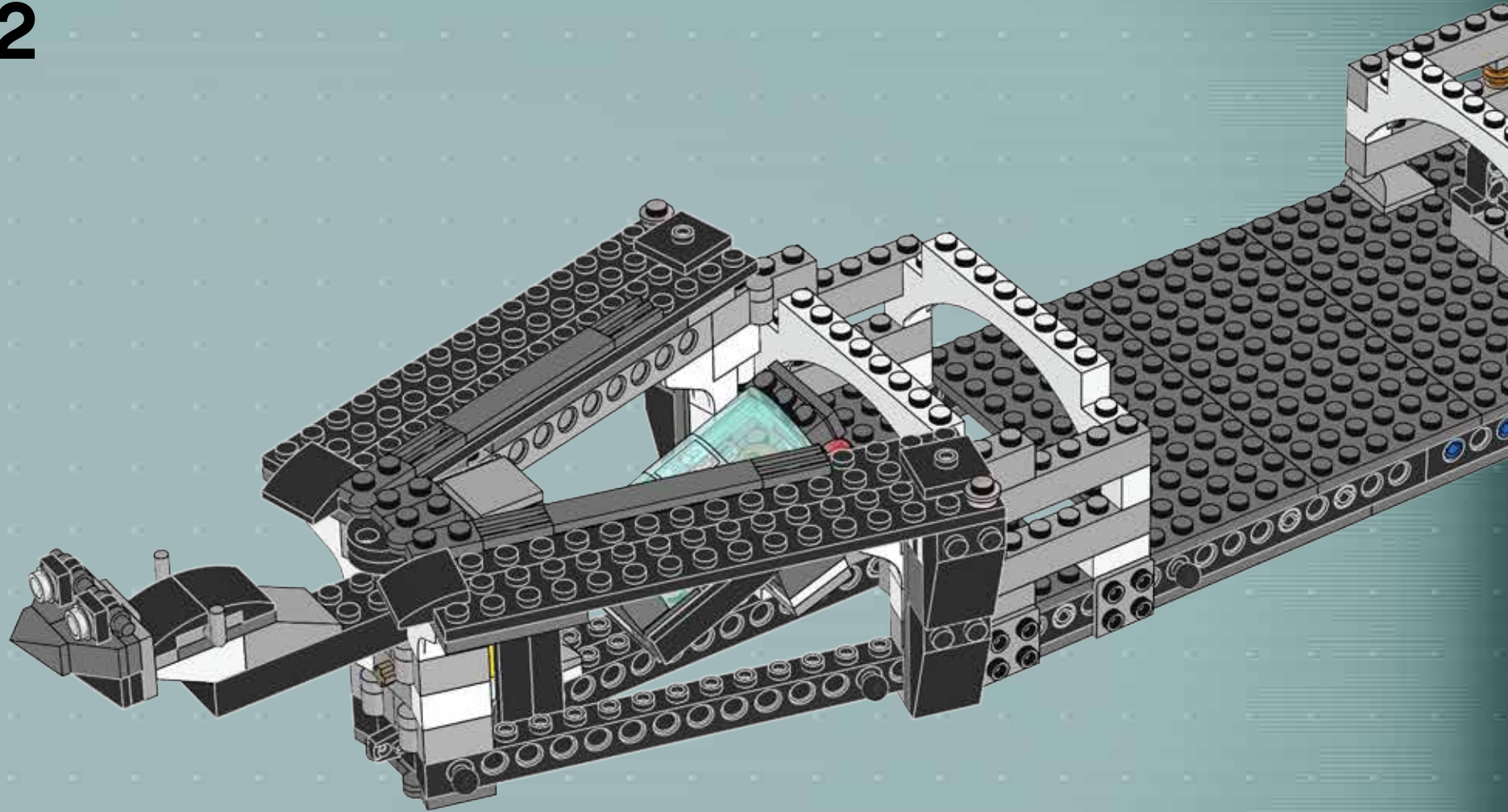

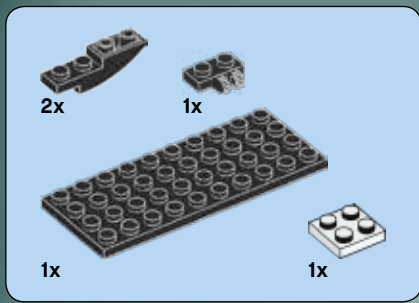

43

1

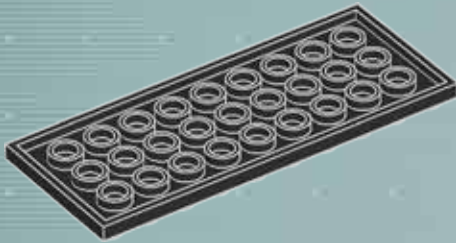

2

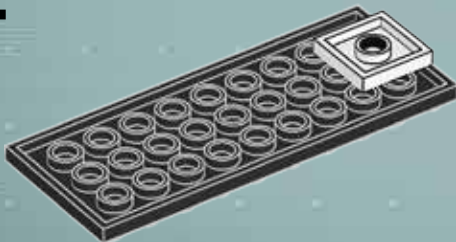

3

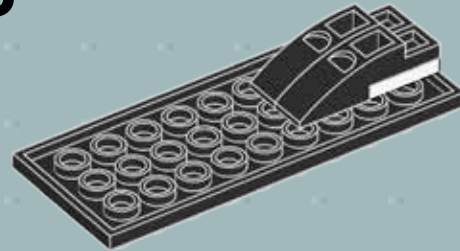

4

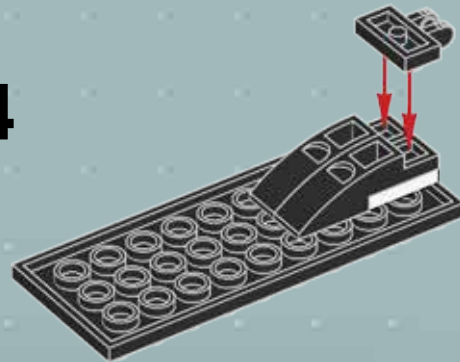

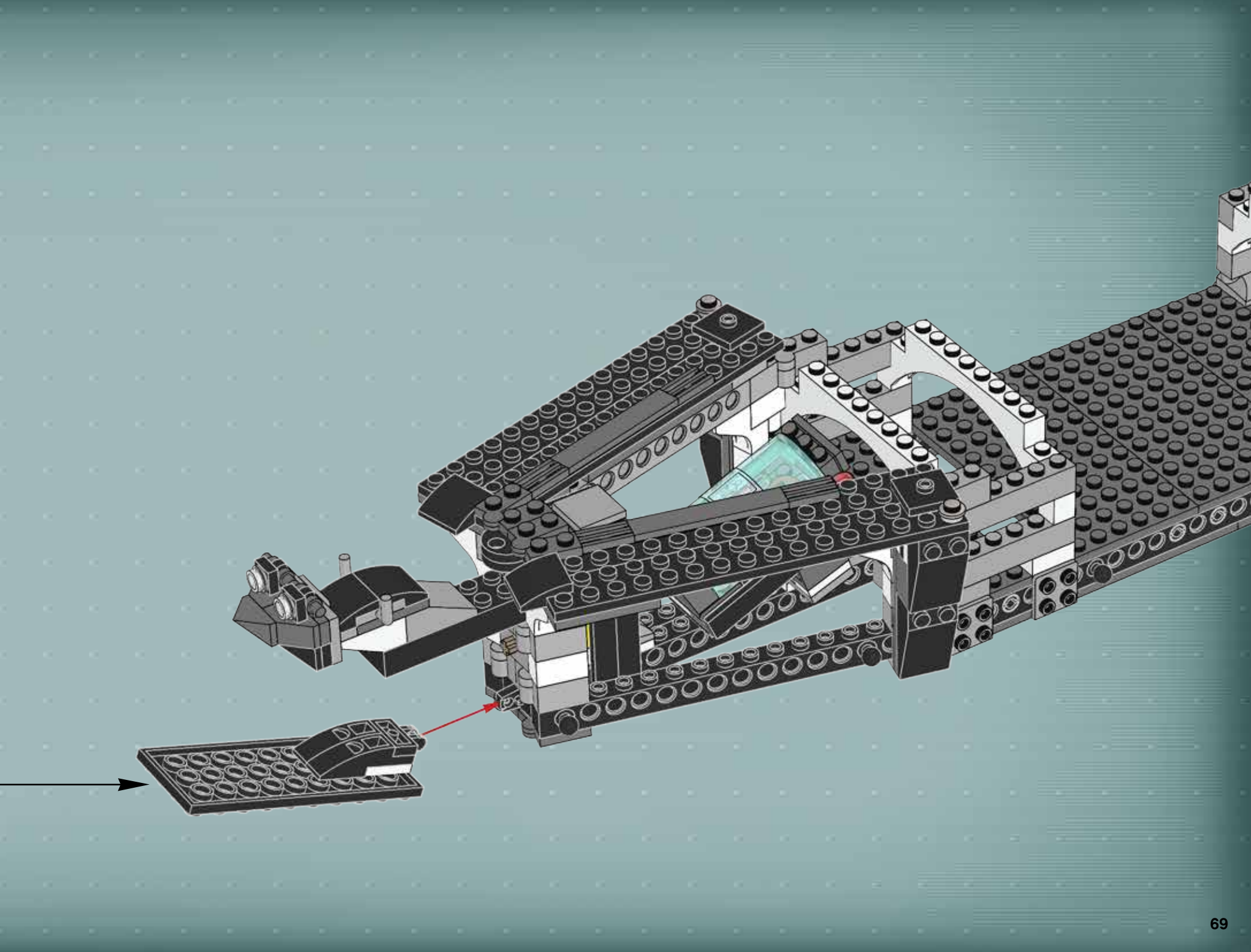

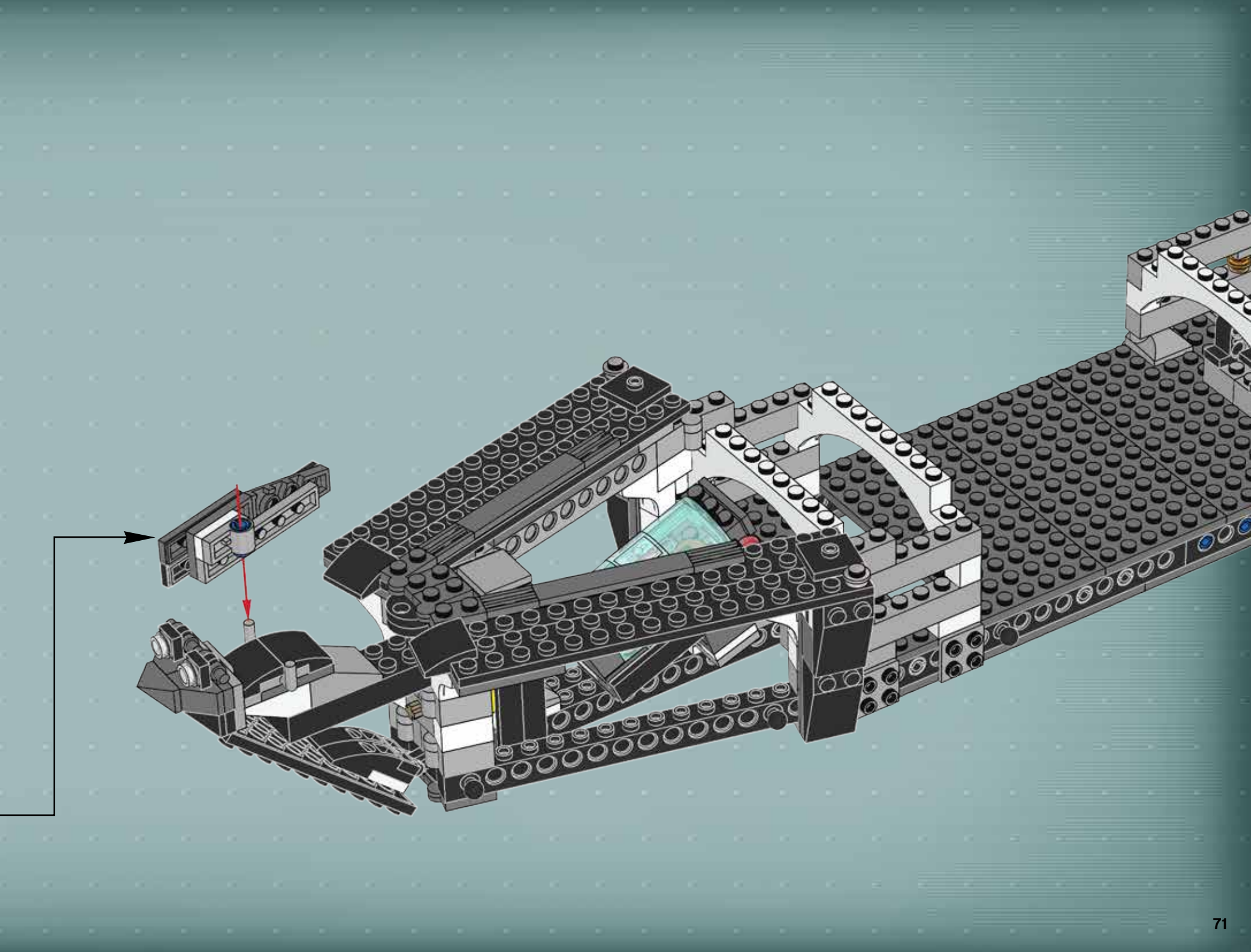

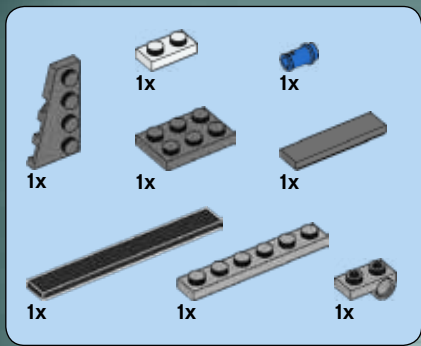

45

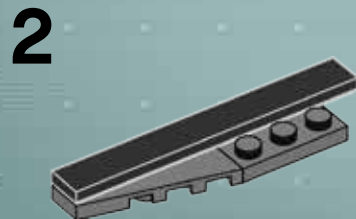
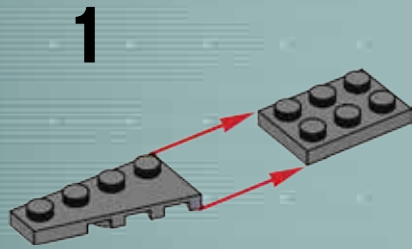

3

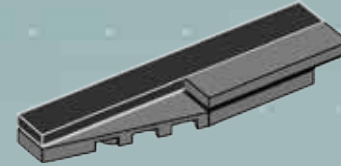

4

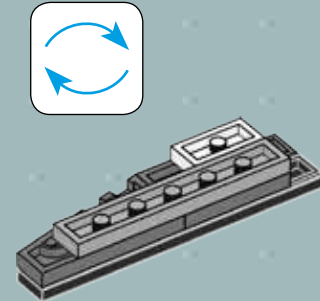

5

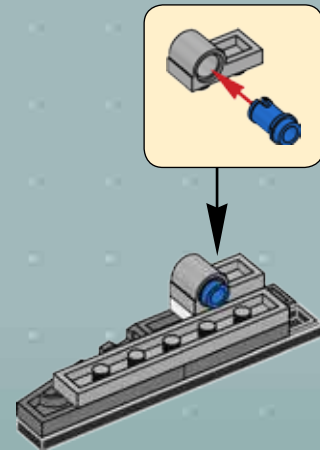

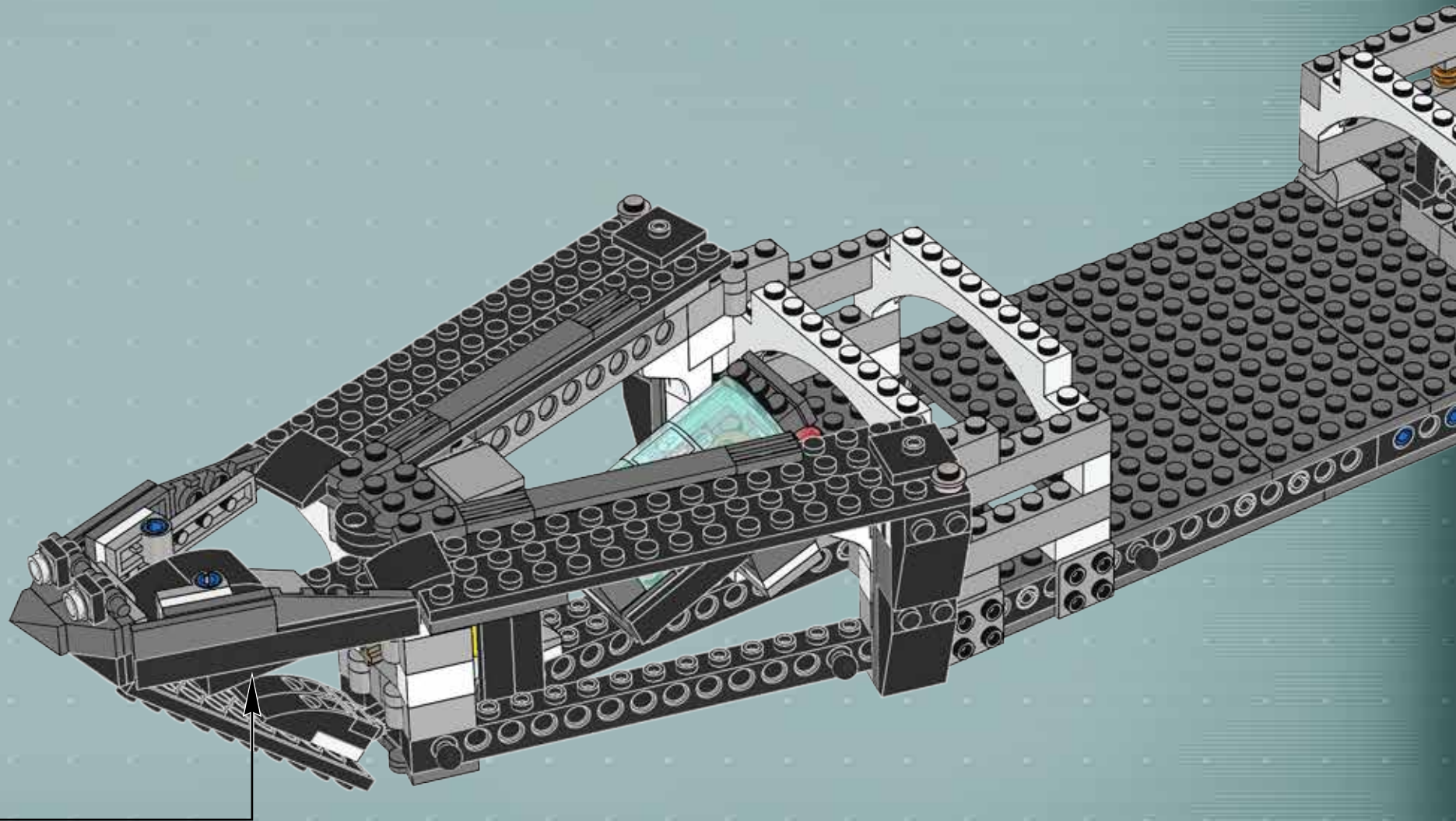

1x

1x

1x

8x

46

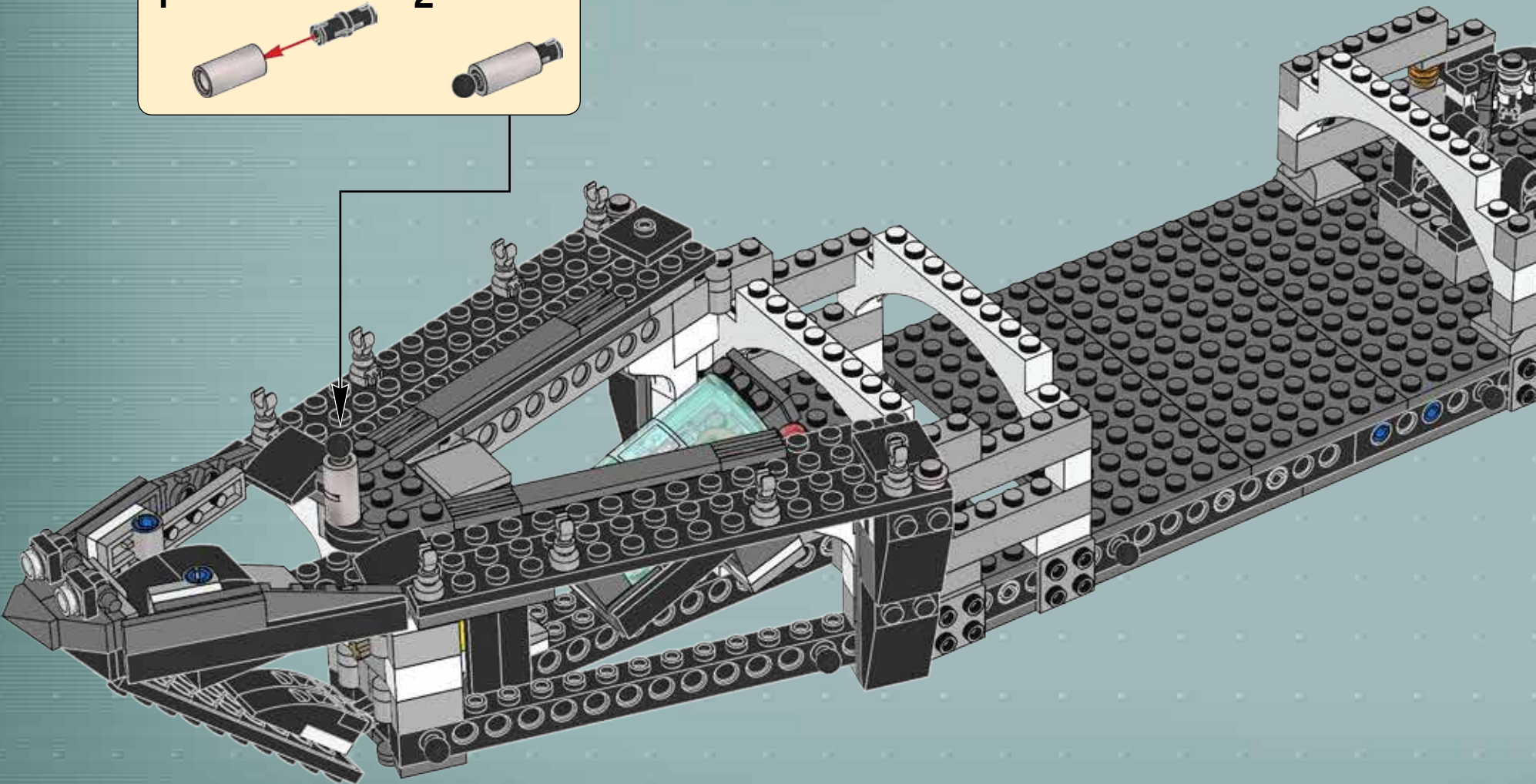
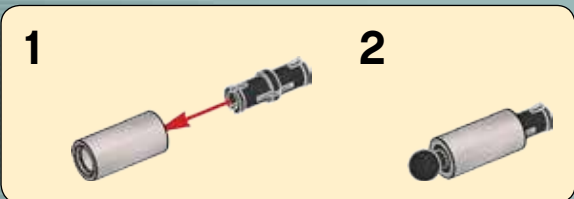

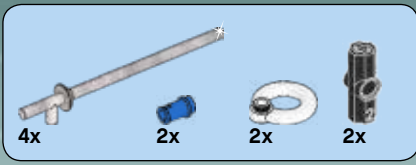

47

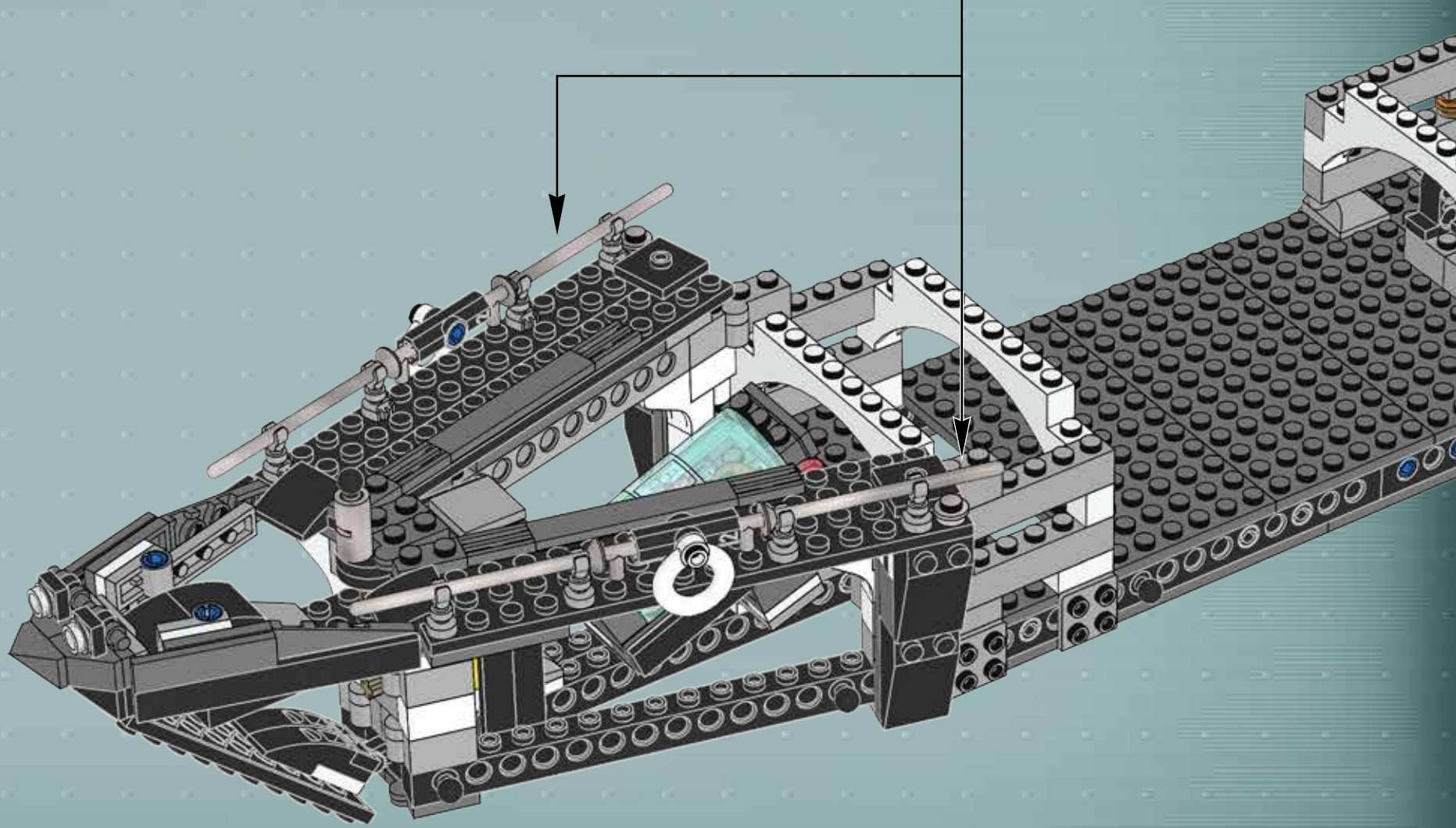
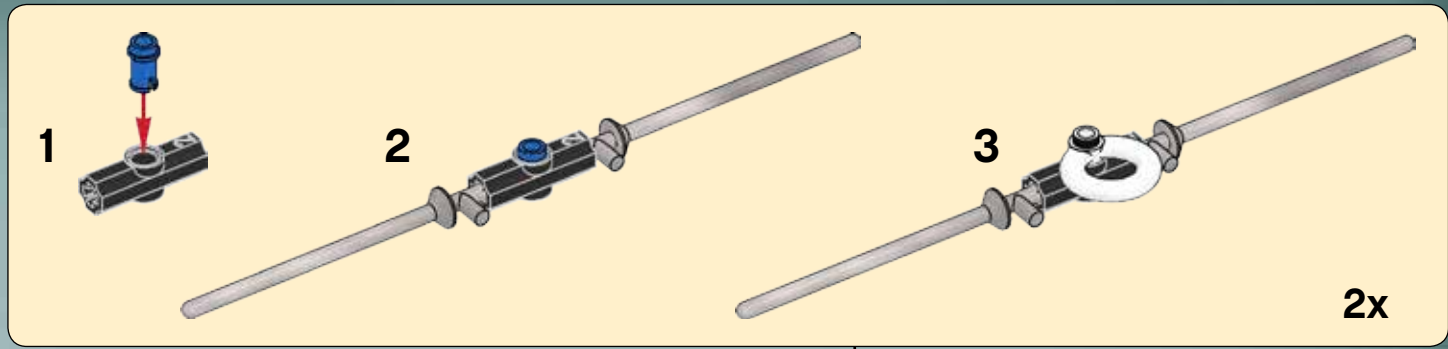

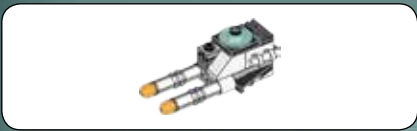

1

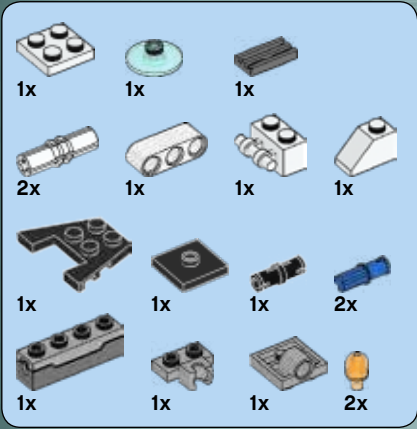
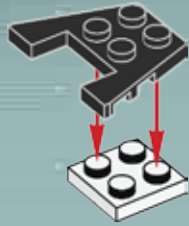

2



3

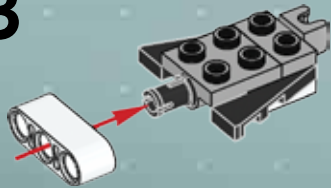

4

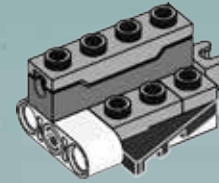

5

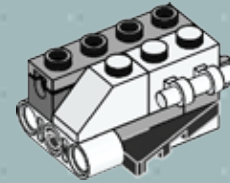

6

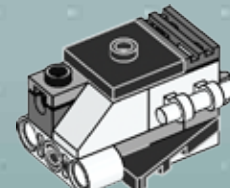

48

7

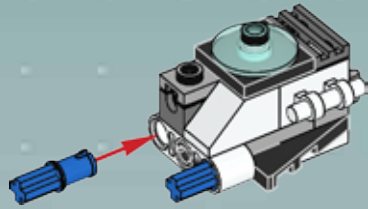

8

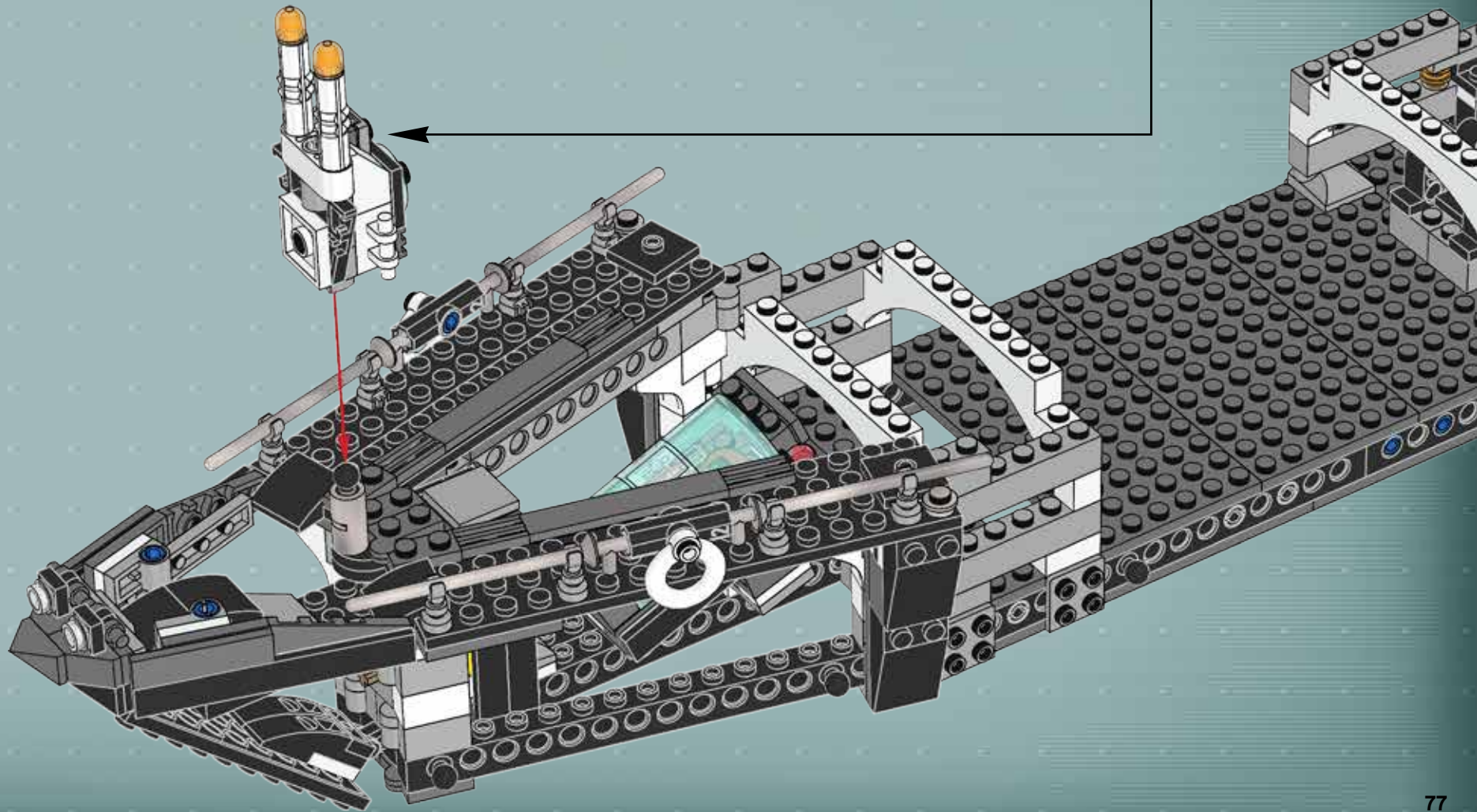
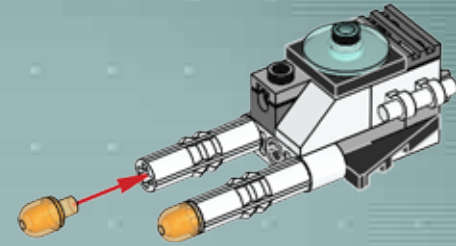

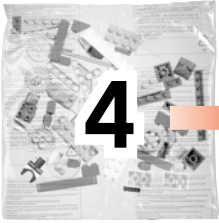

4

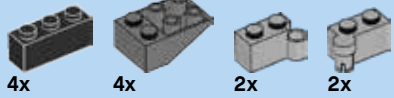
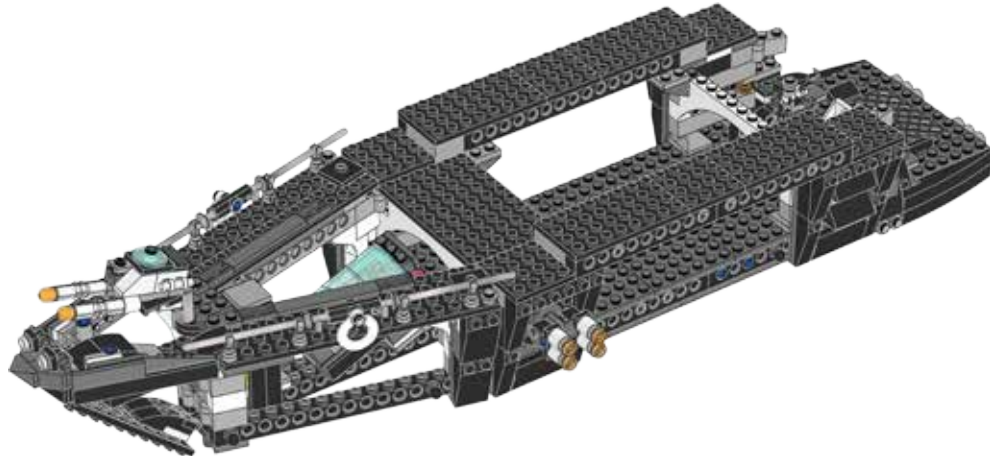

4x

4x

2x

2x

49

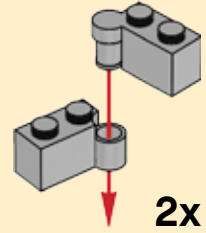

2x

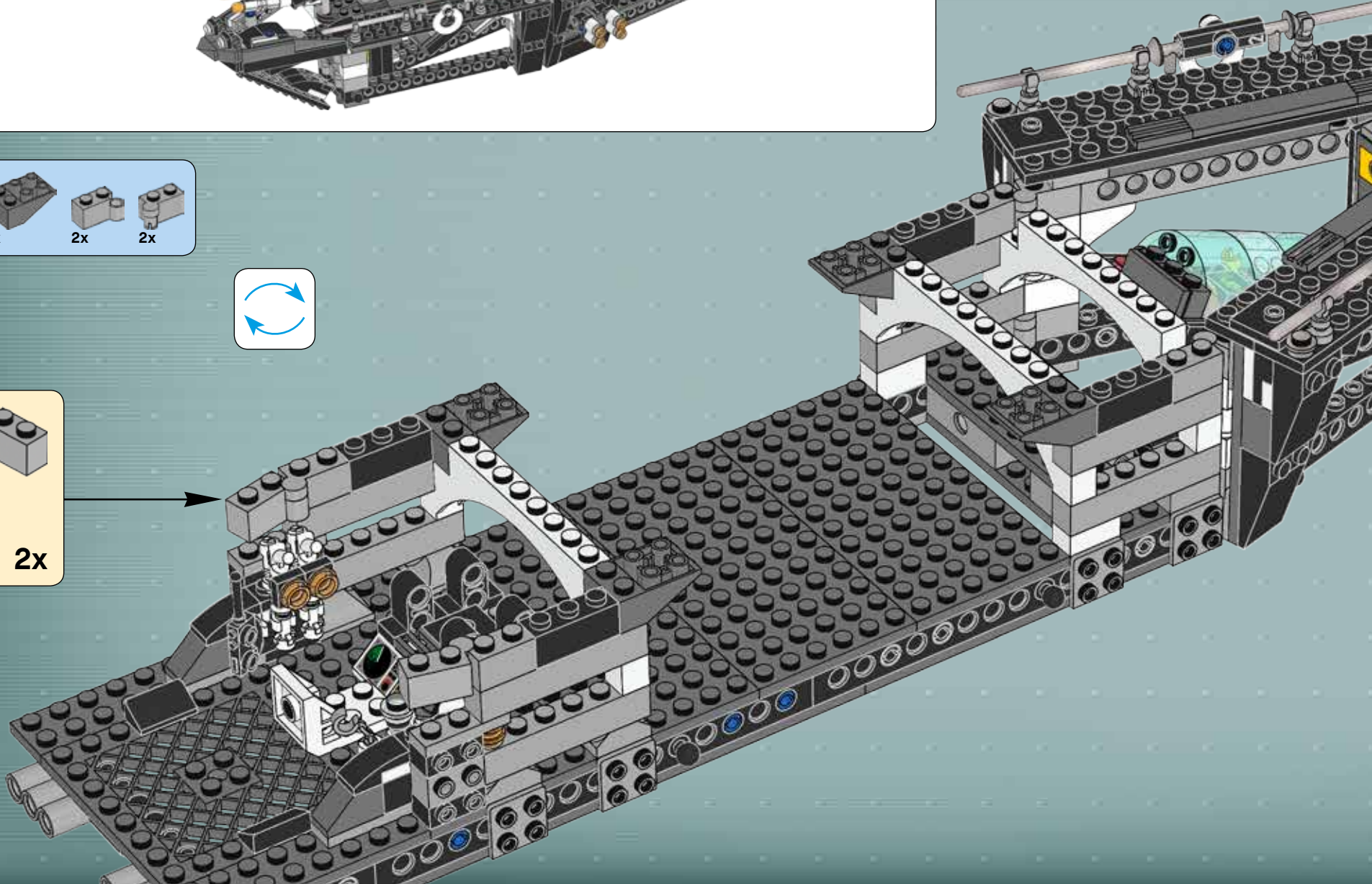



4x



8x

50

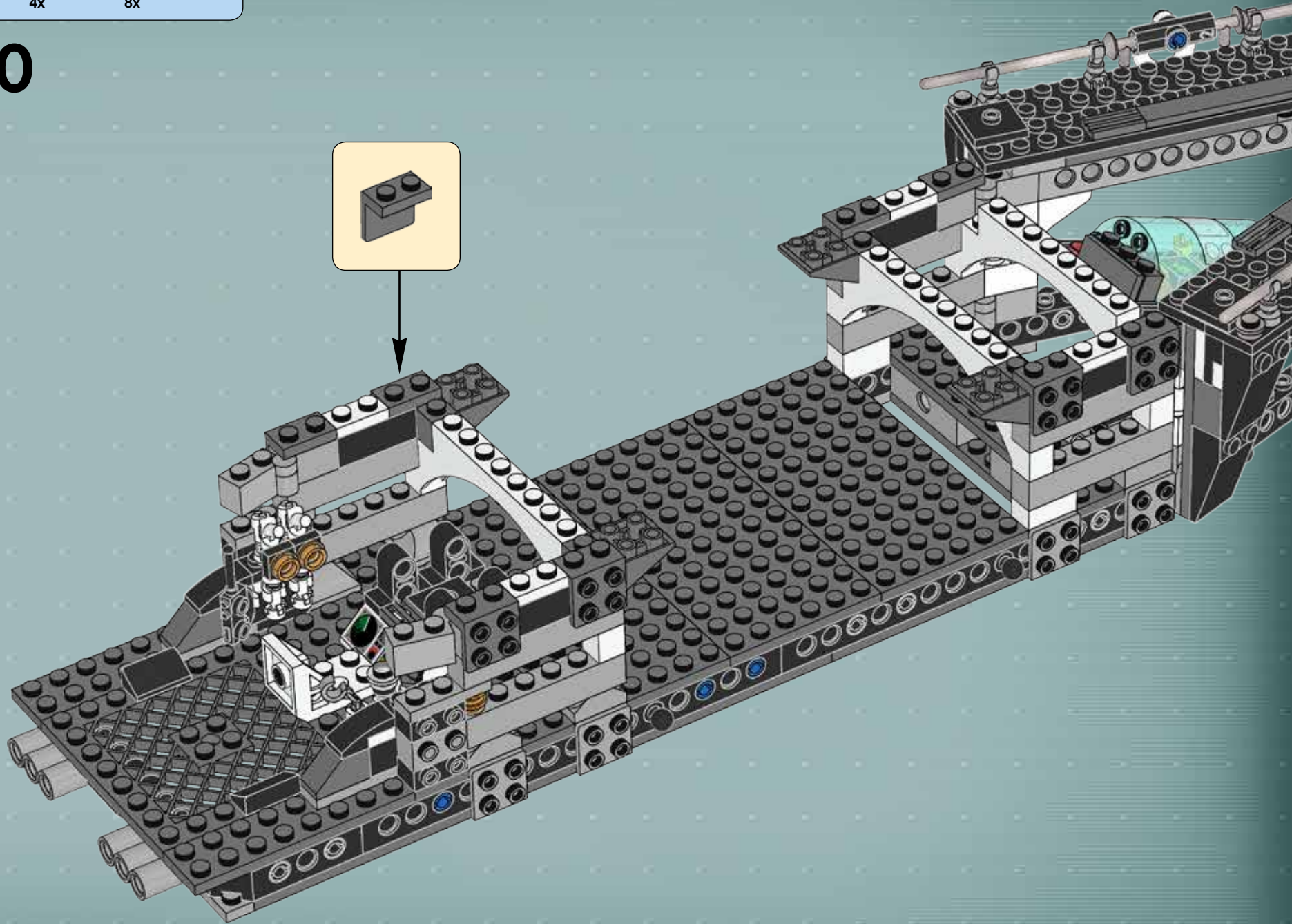
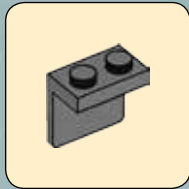



2x

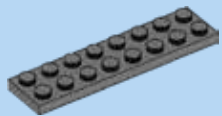

2x

1

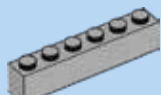
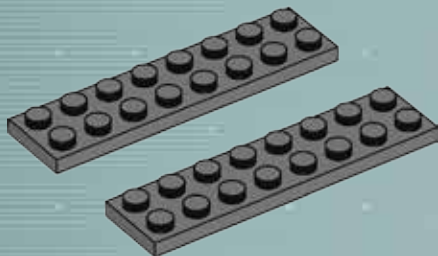

1x

2

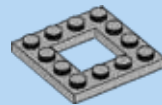
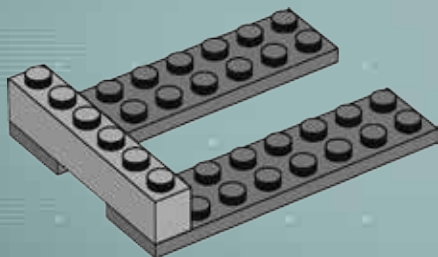

1x

3

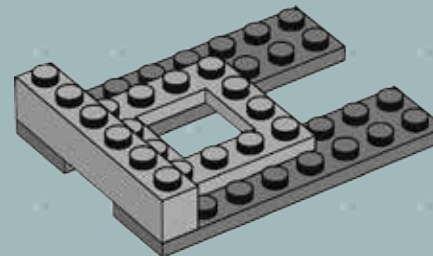

1x

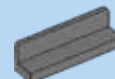

1x

4

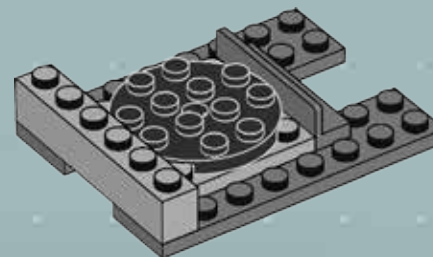



5

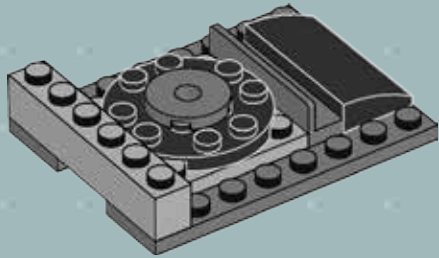

6

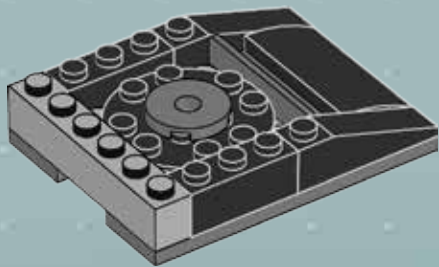

7

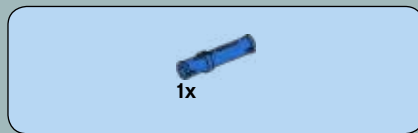
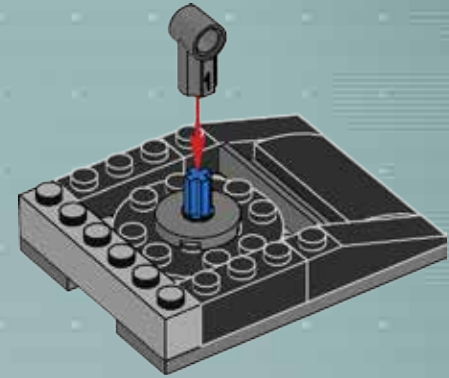

8

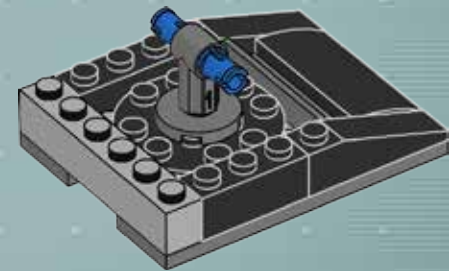

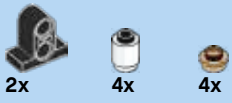

9

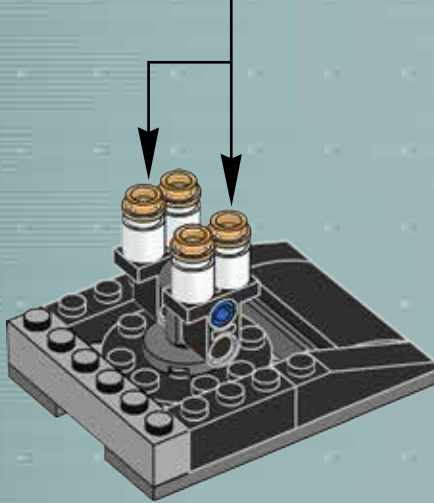
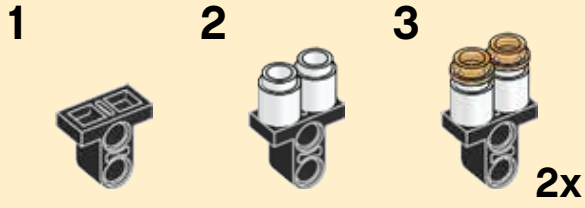

10

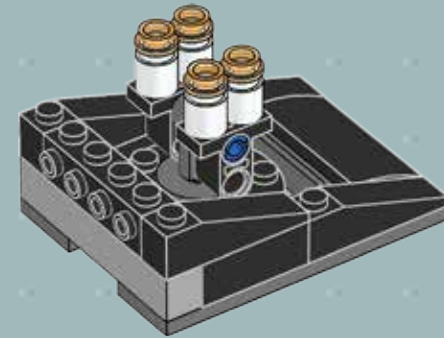

2x

51

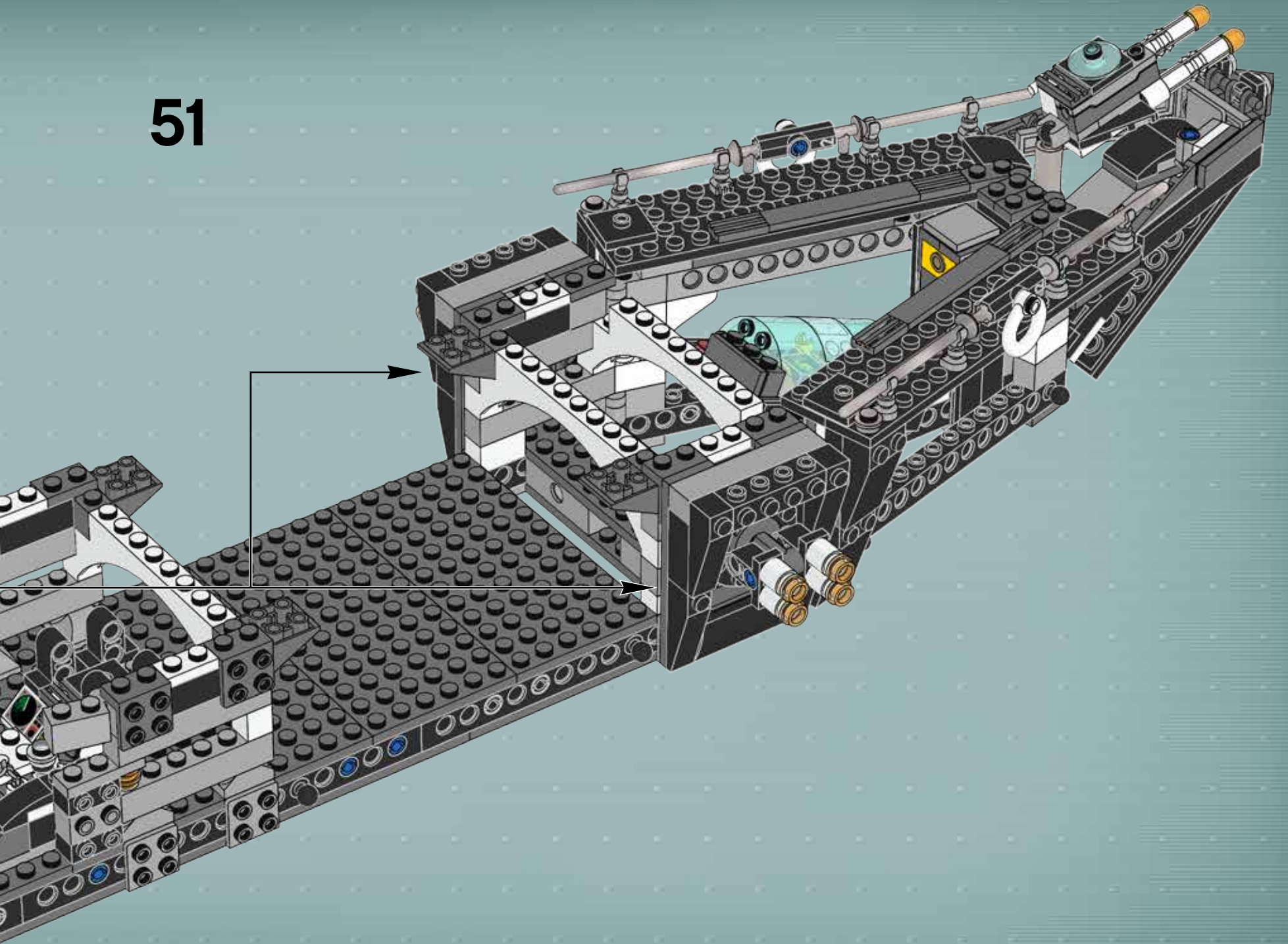

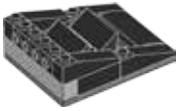

2x

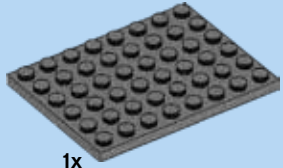

1x



1



1x



2



4x

3

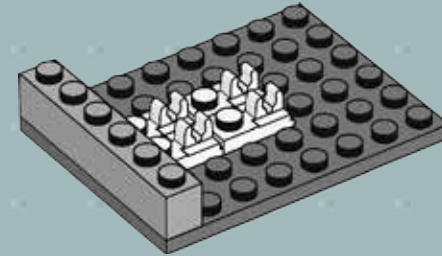

2x

4



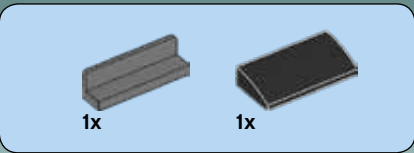

5

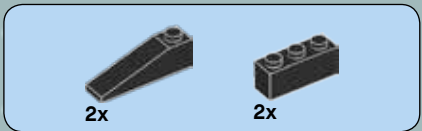
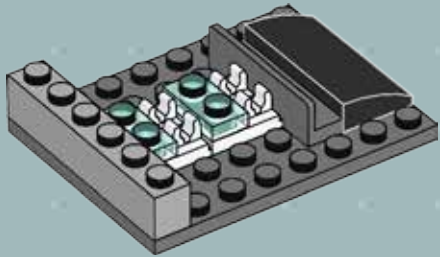

6

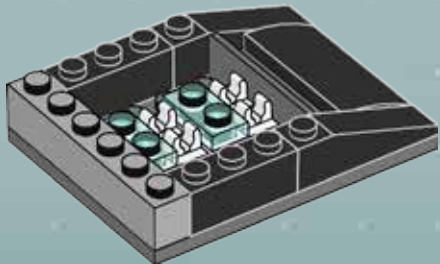

7

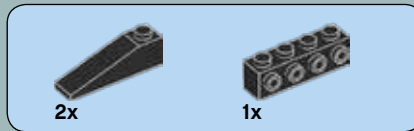
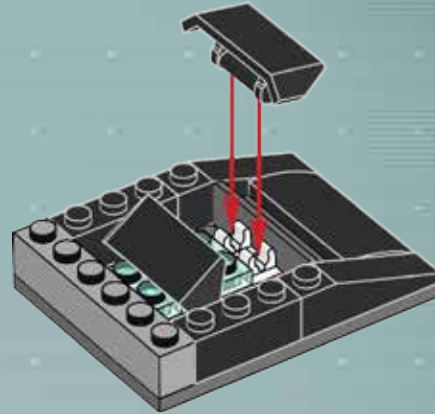

8

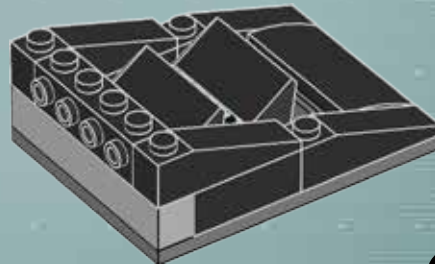

2x

52

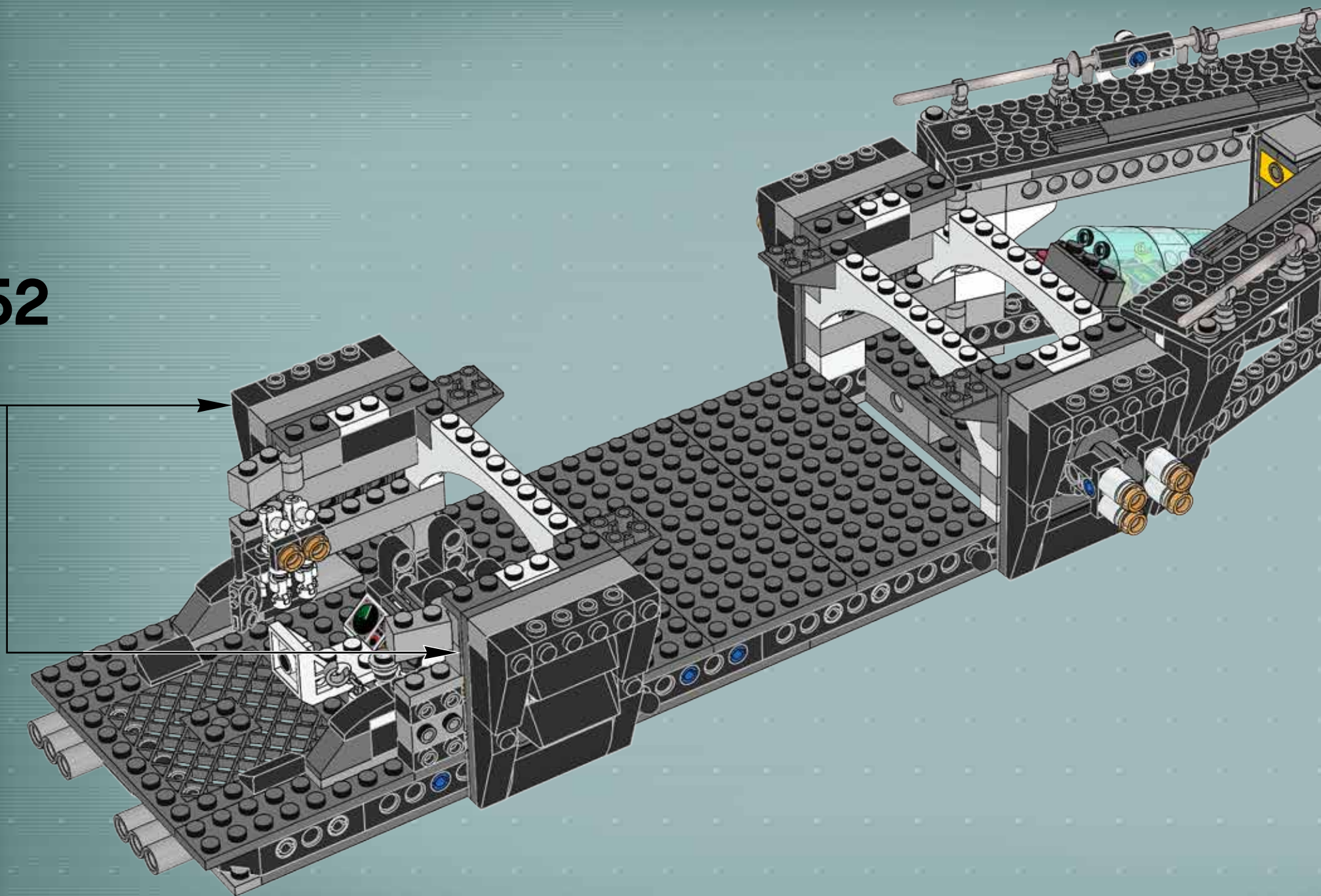

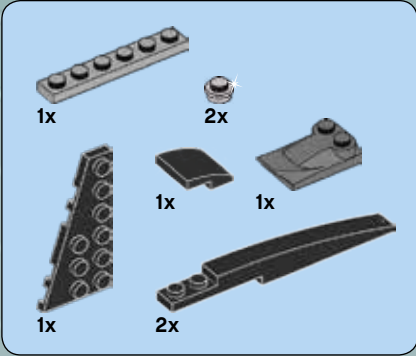

53

1



2

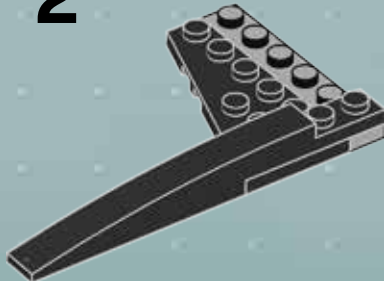

3

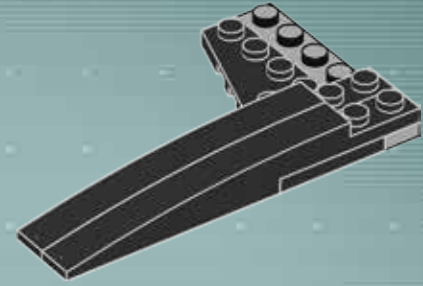

4

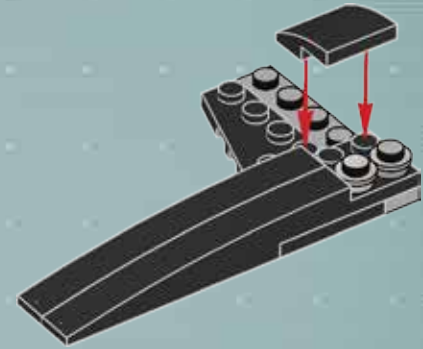

5

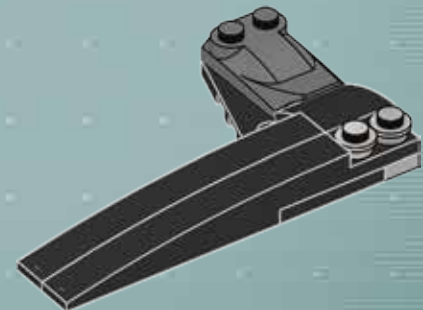

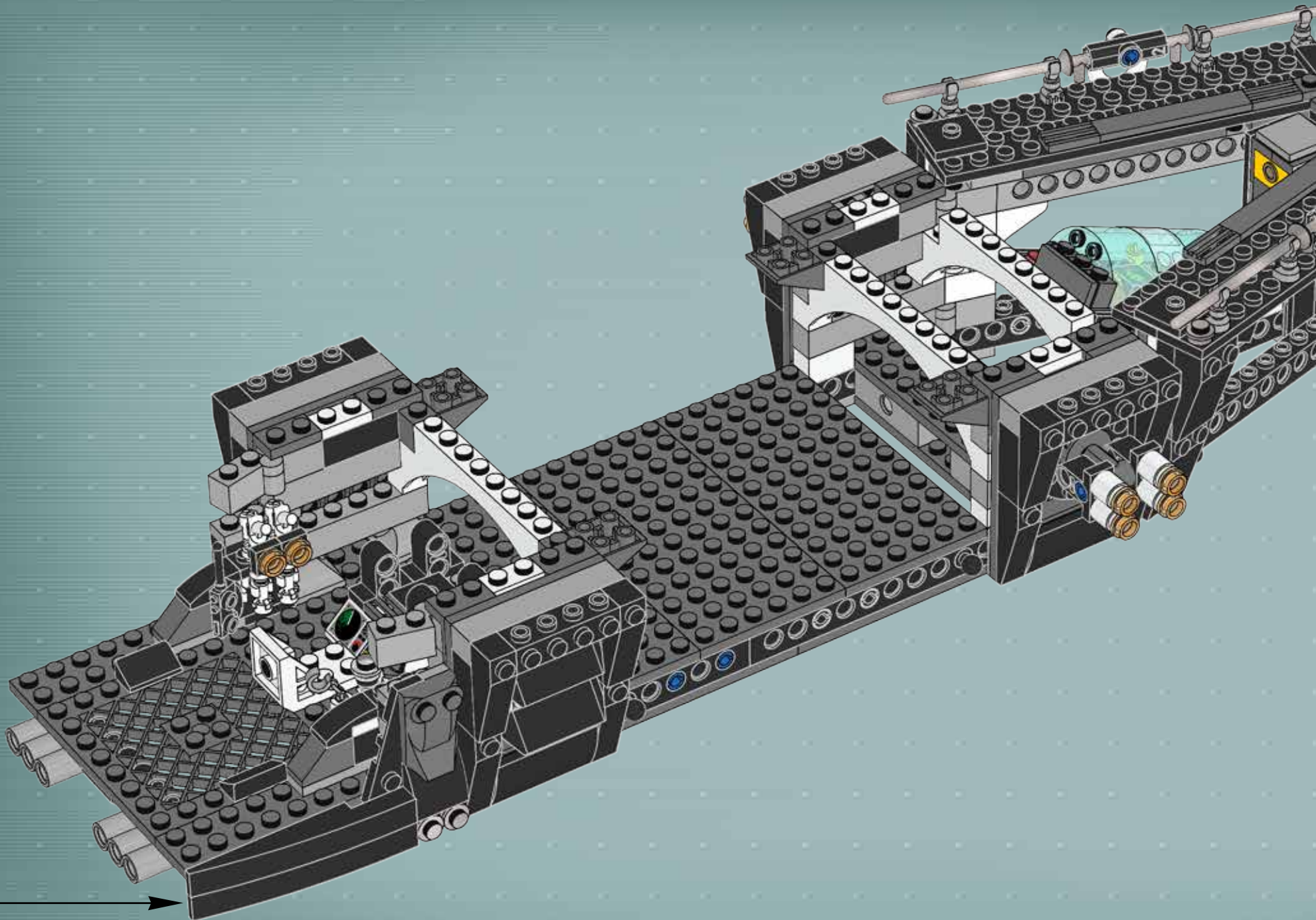

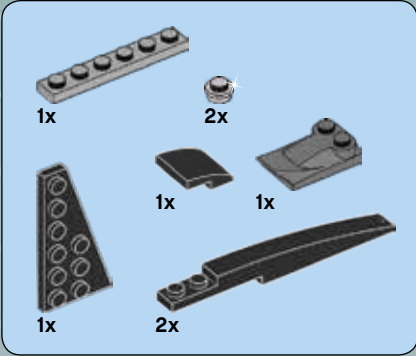

54

1



2

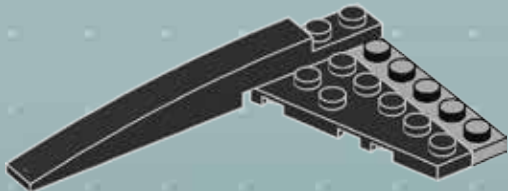

3

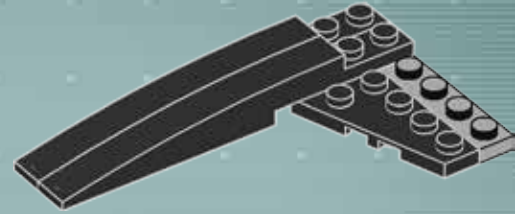

4

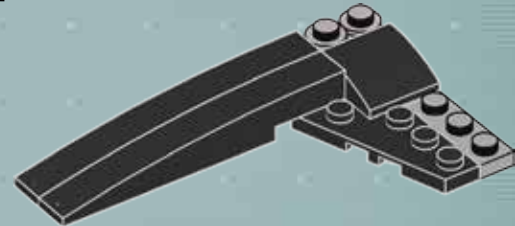

5

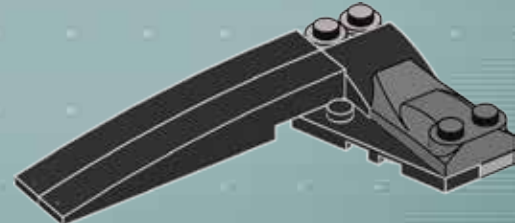

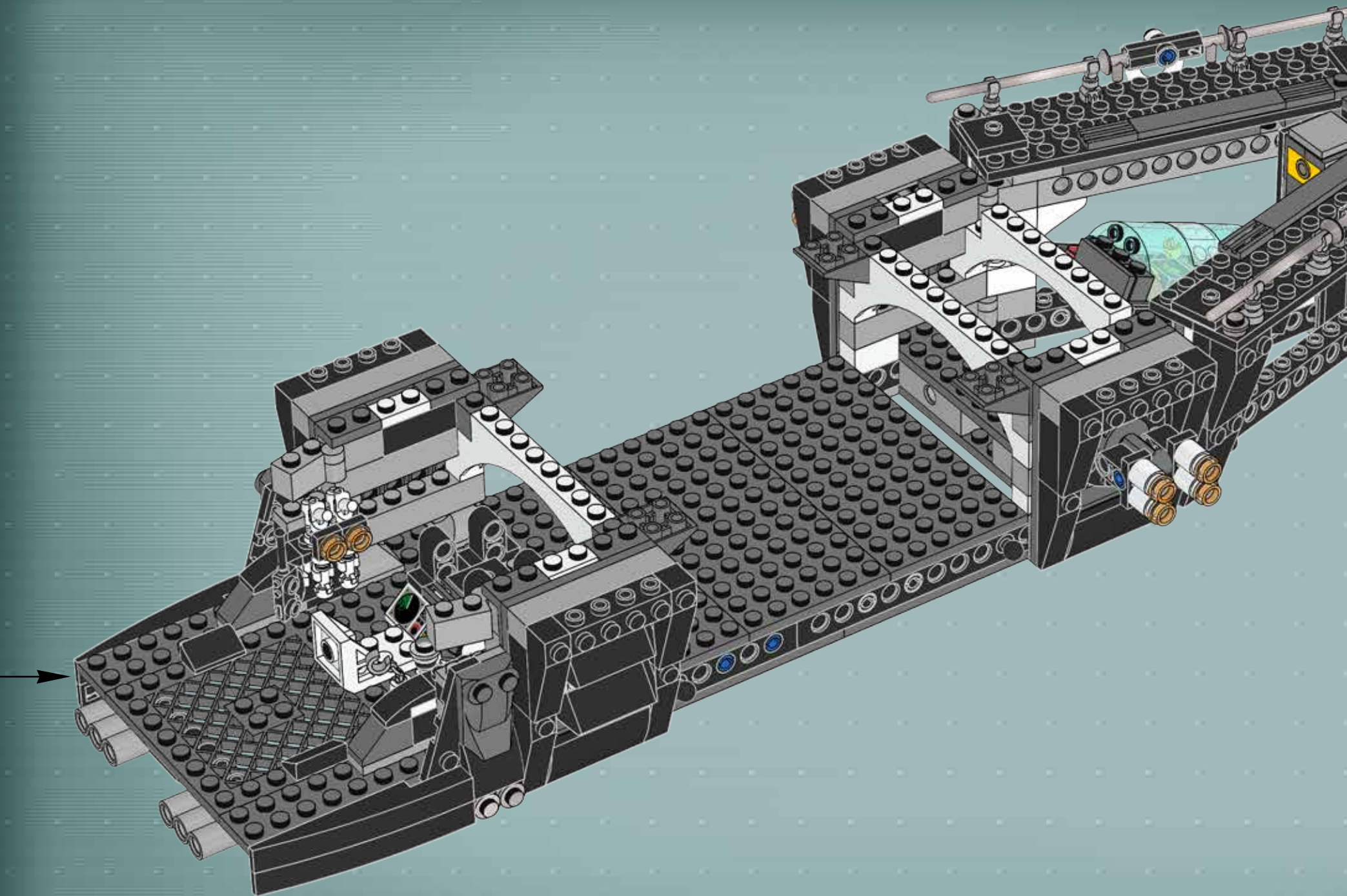

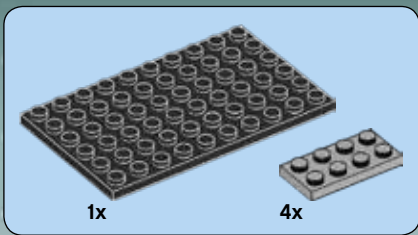

55

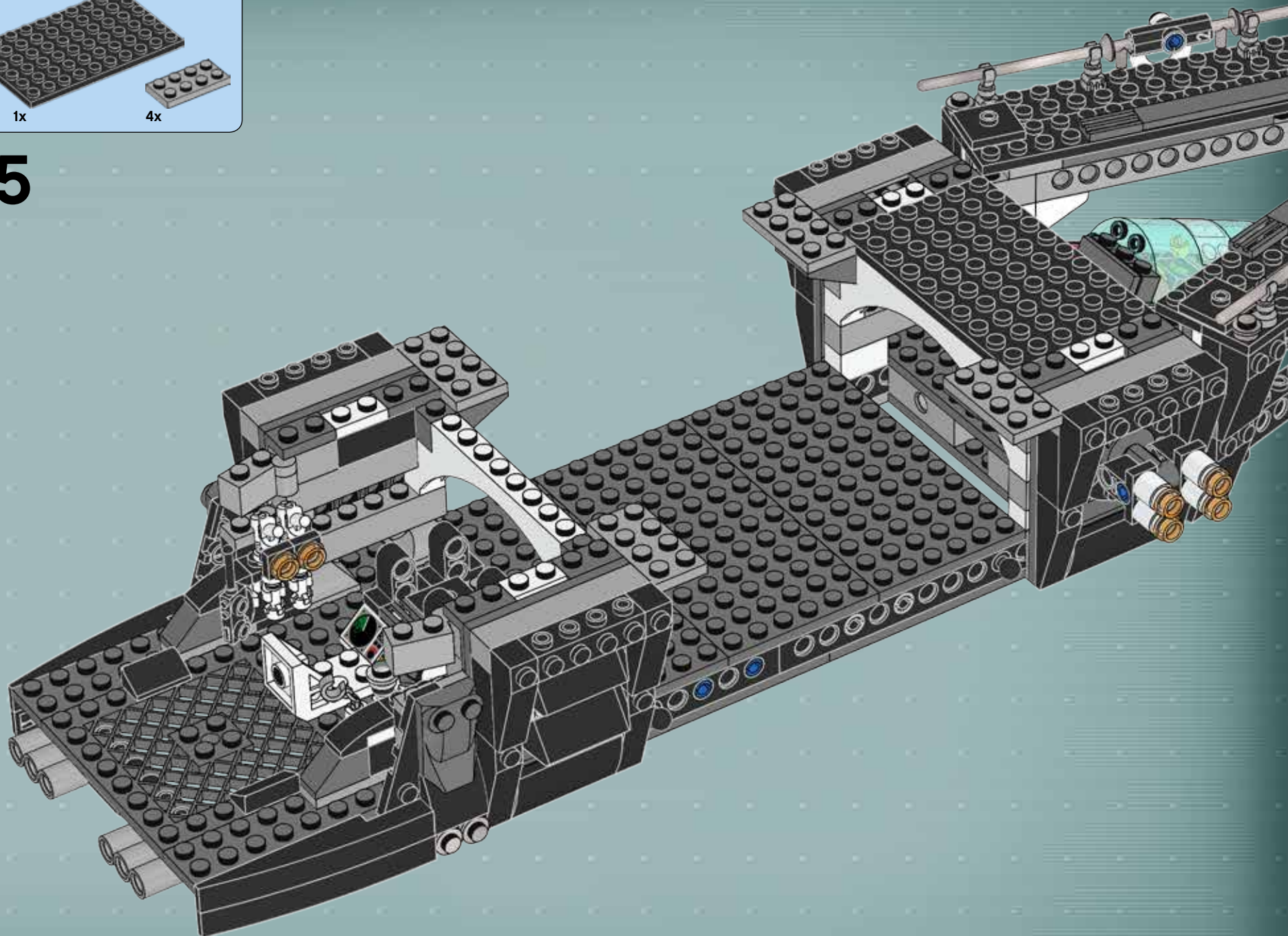

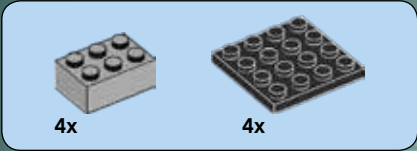

56

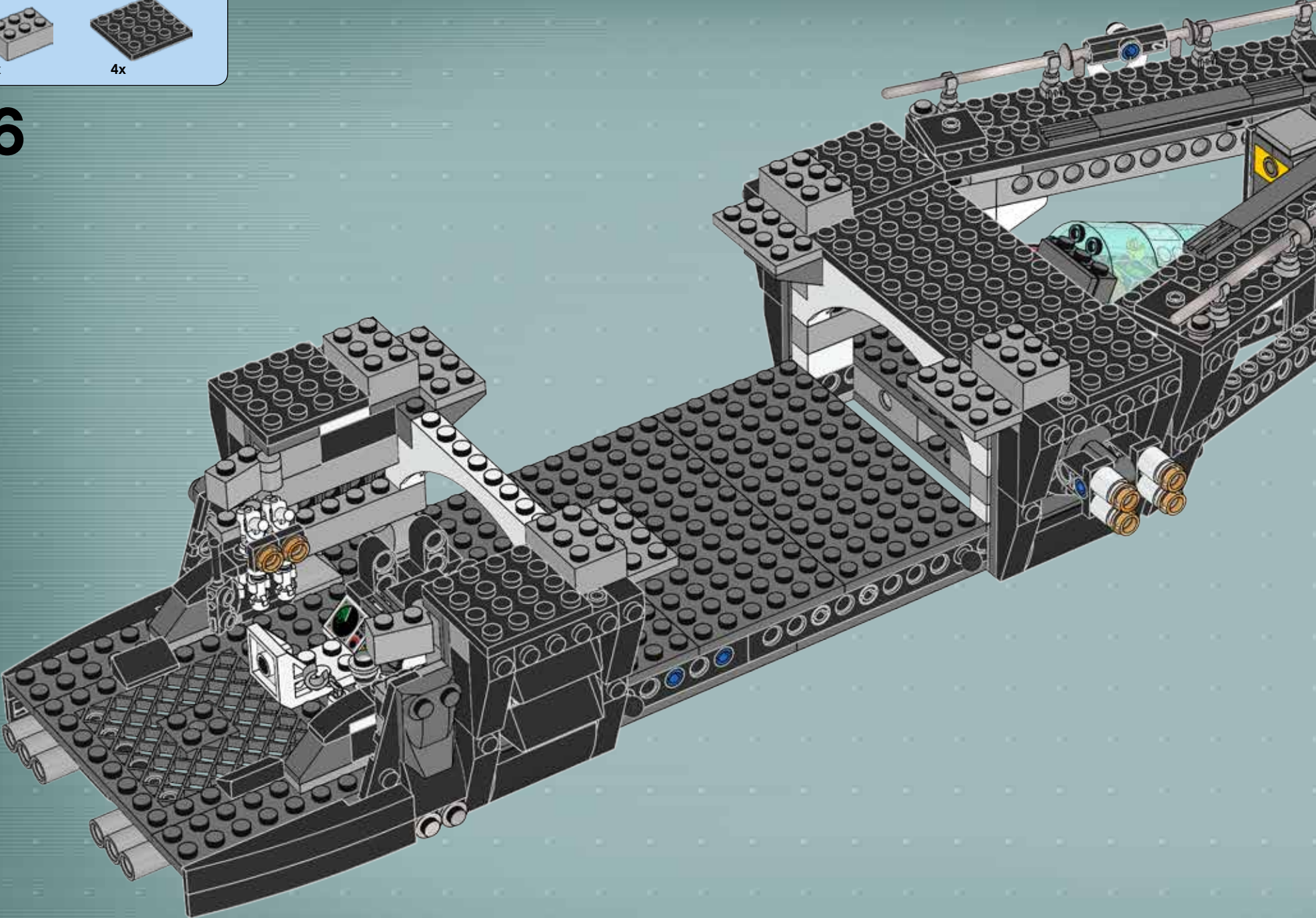

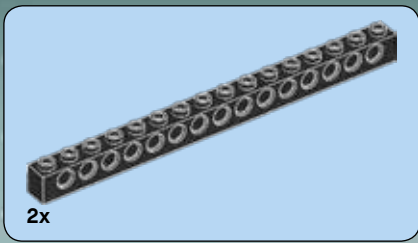

57

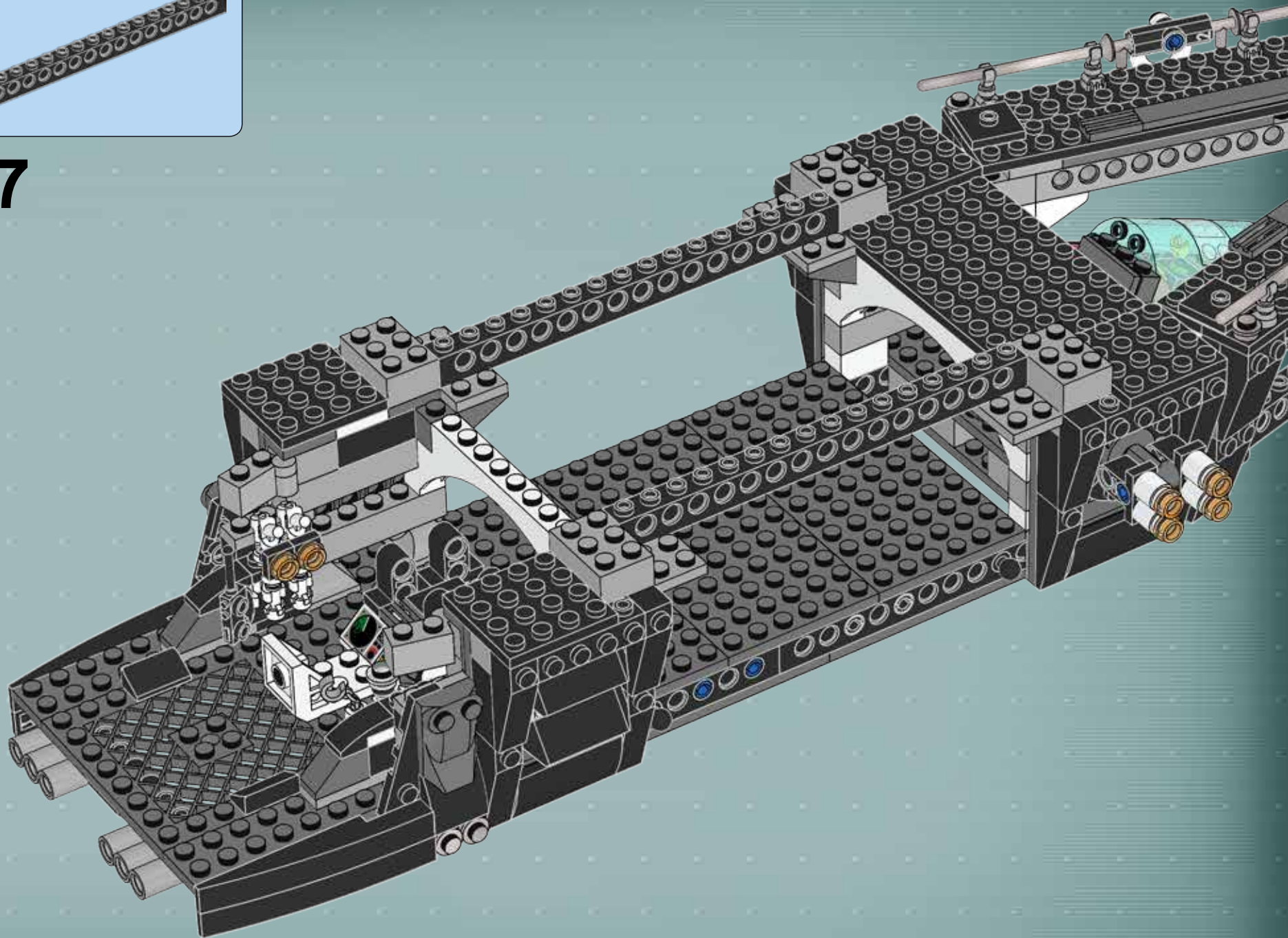

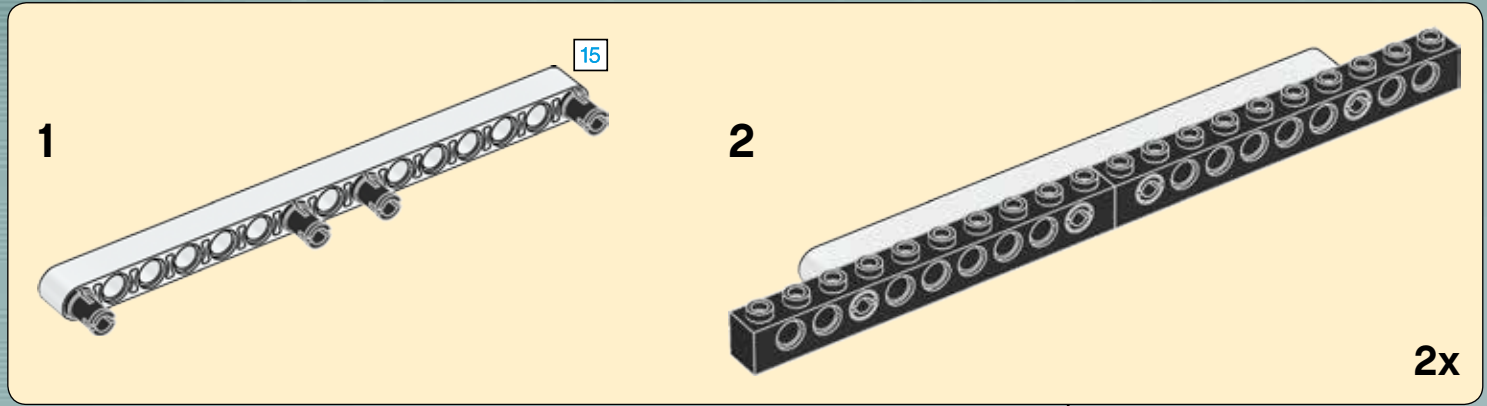
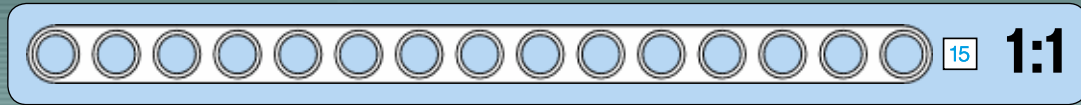
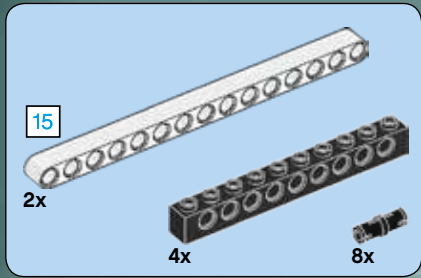

58

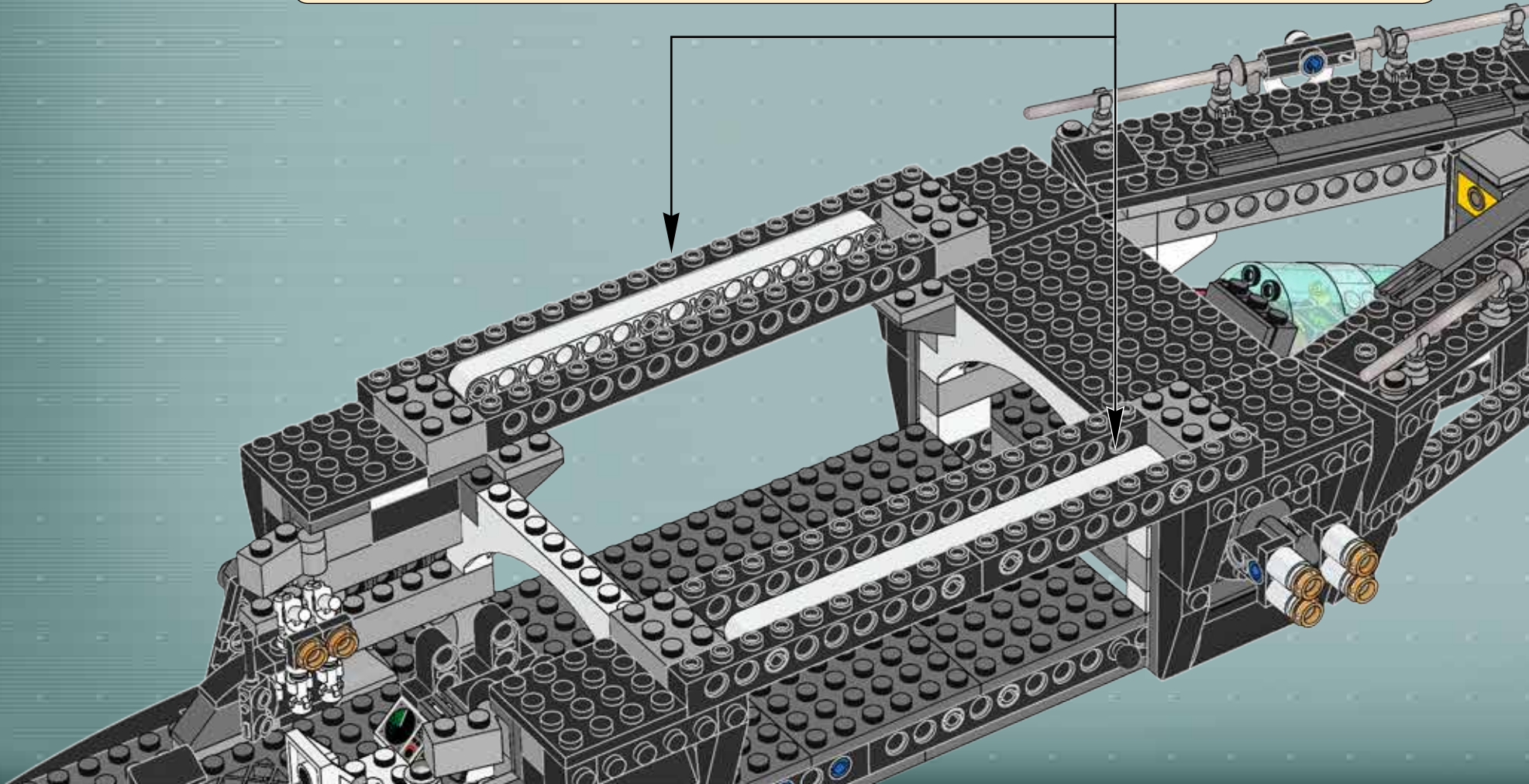

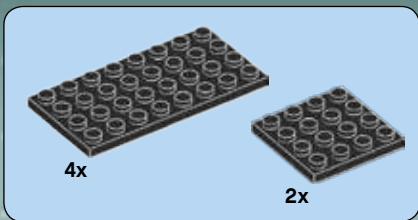

59

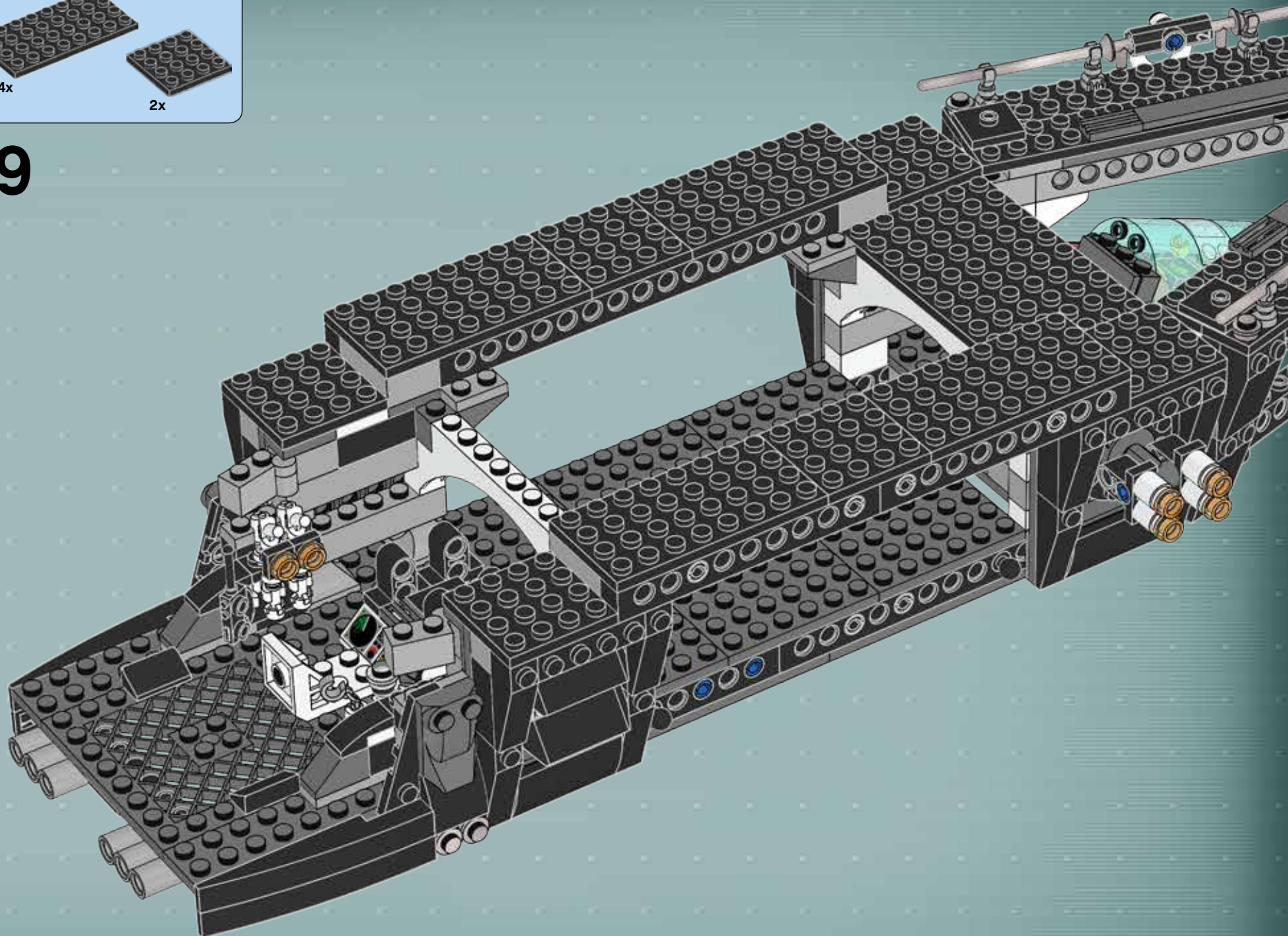

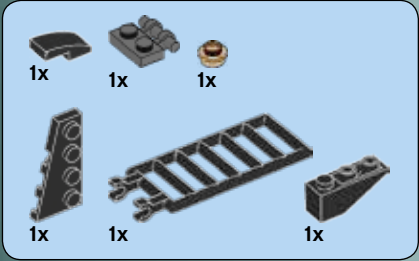
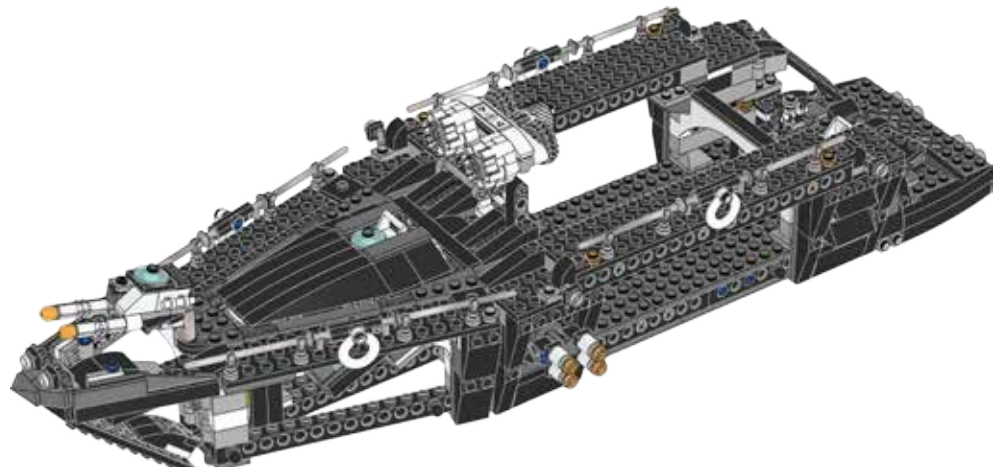

60

1

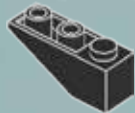

2



3



4



5

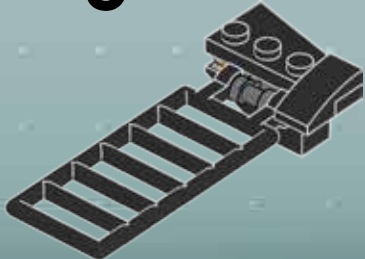

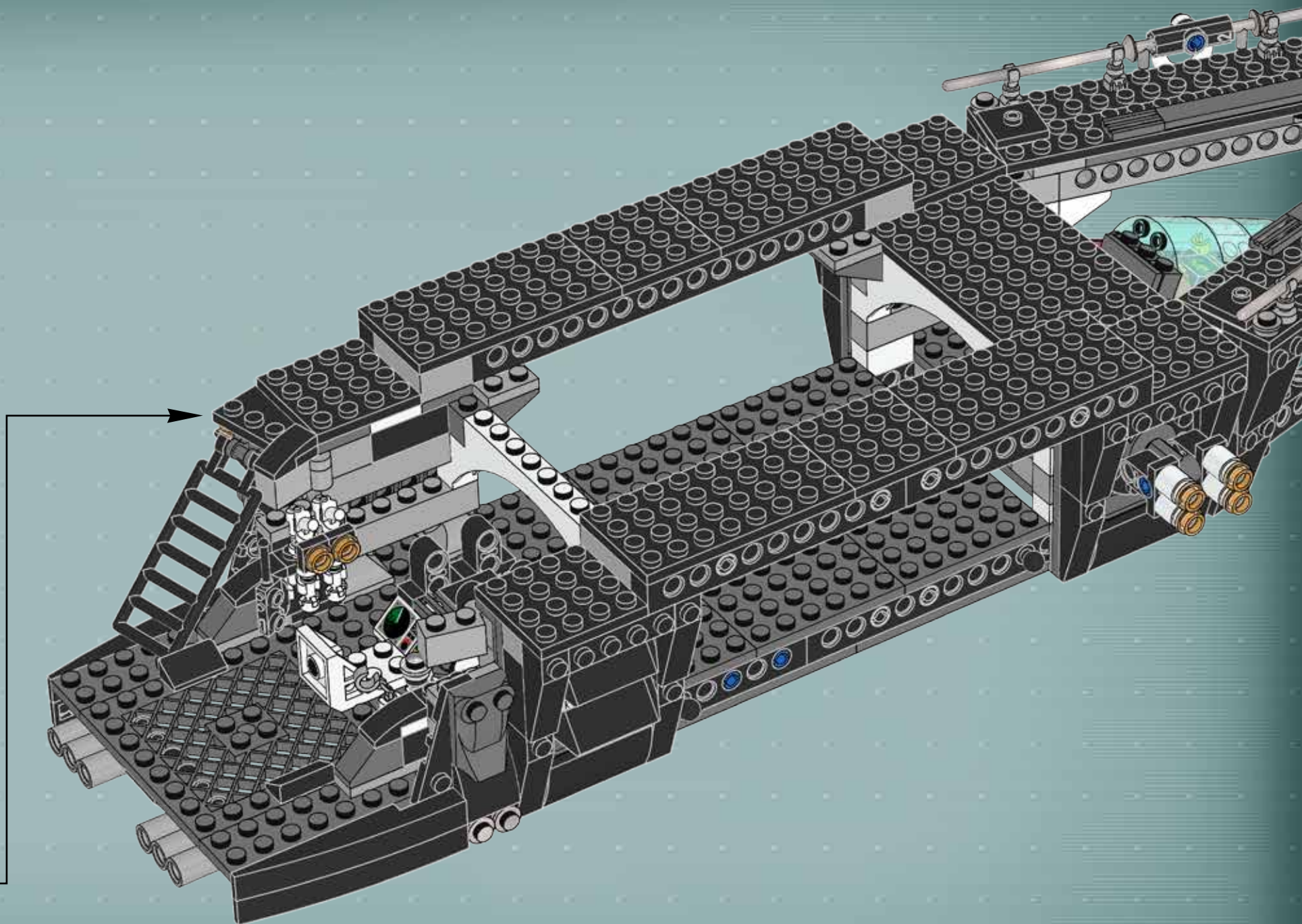

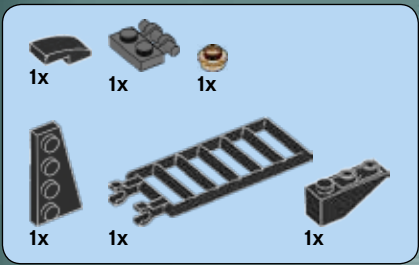

61

1



2



3



4



5

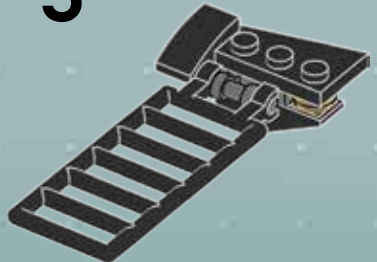

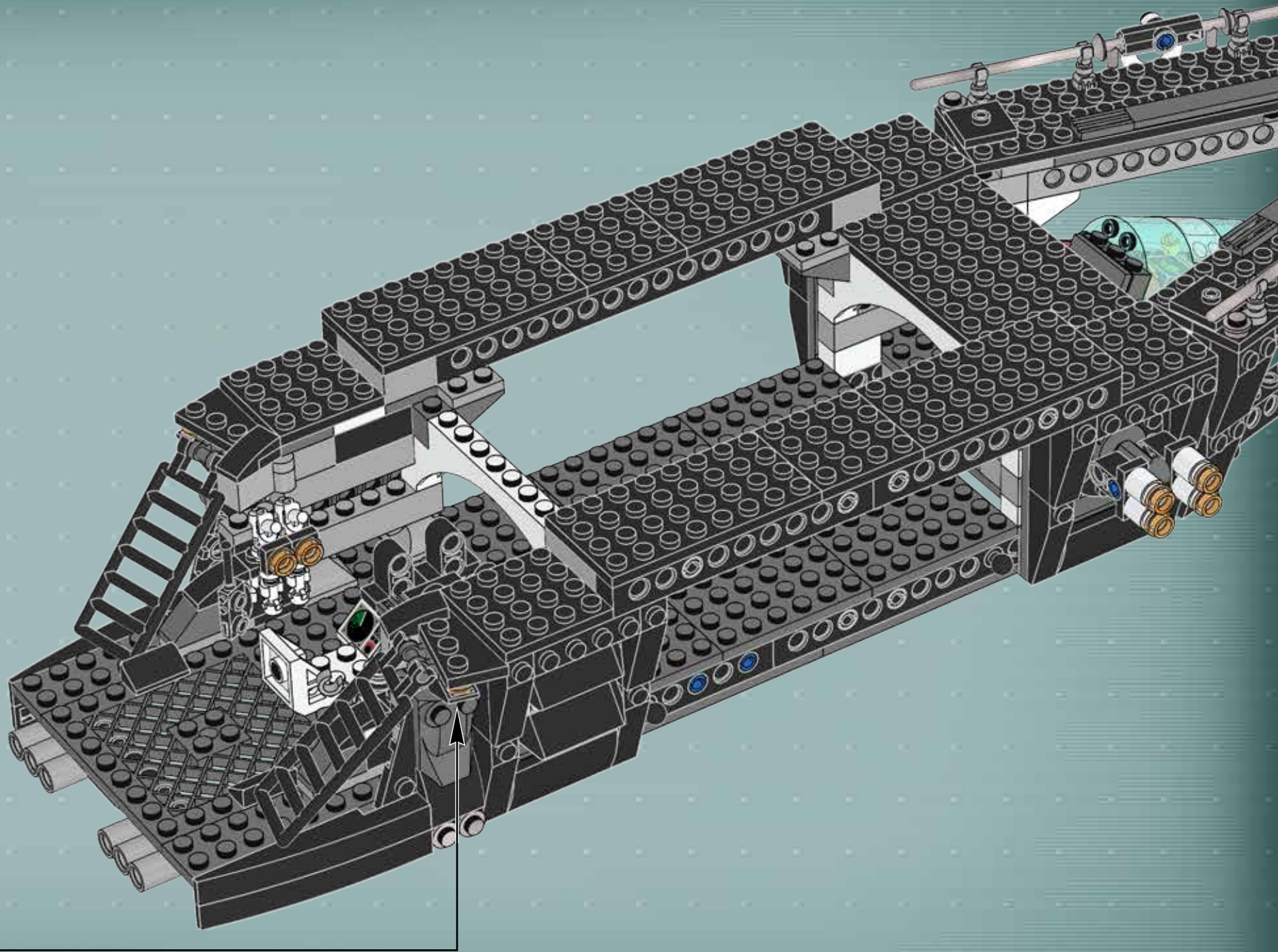



62

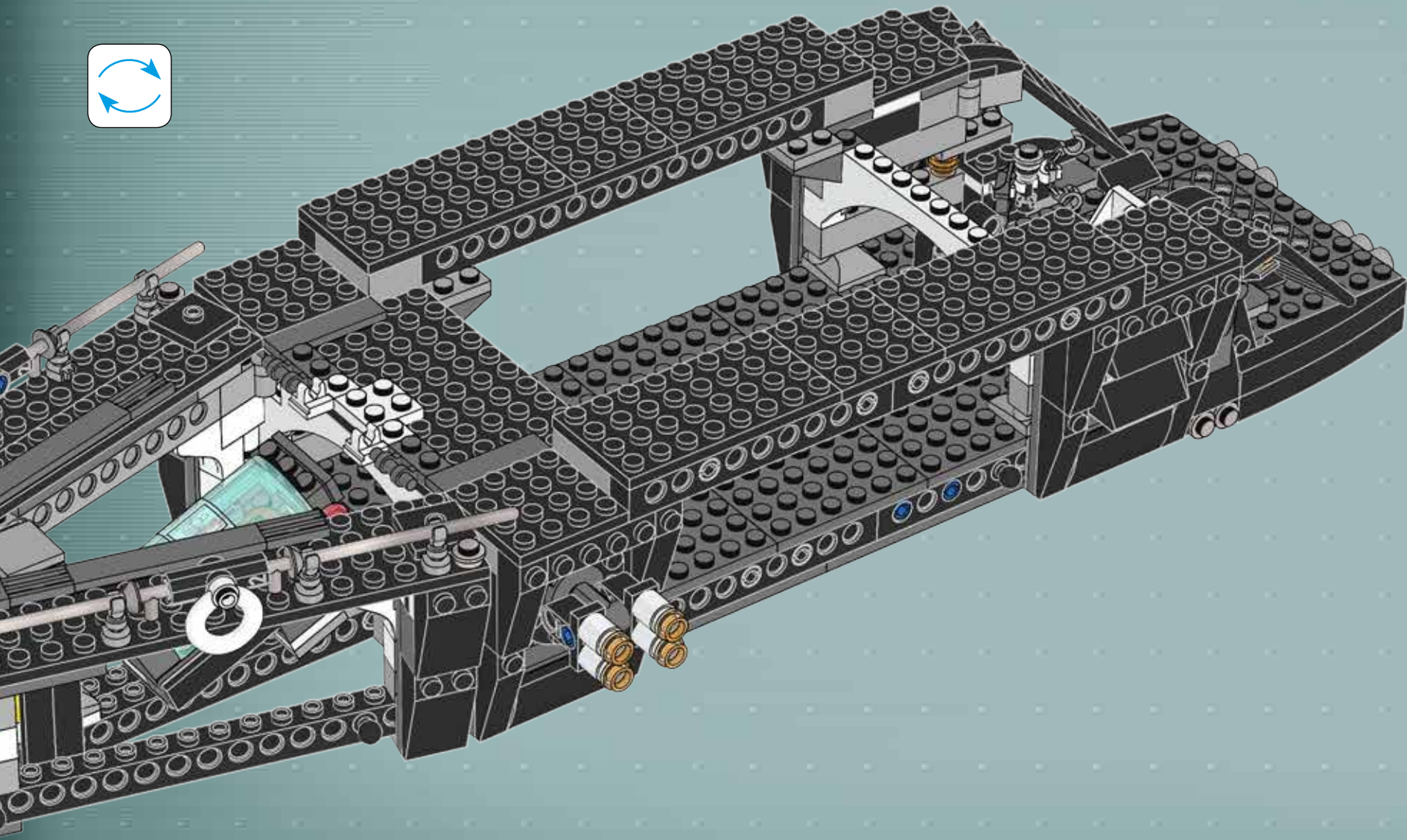

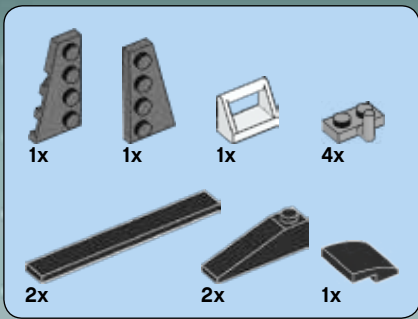

63

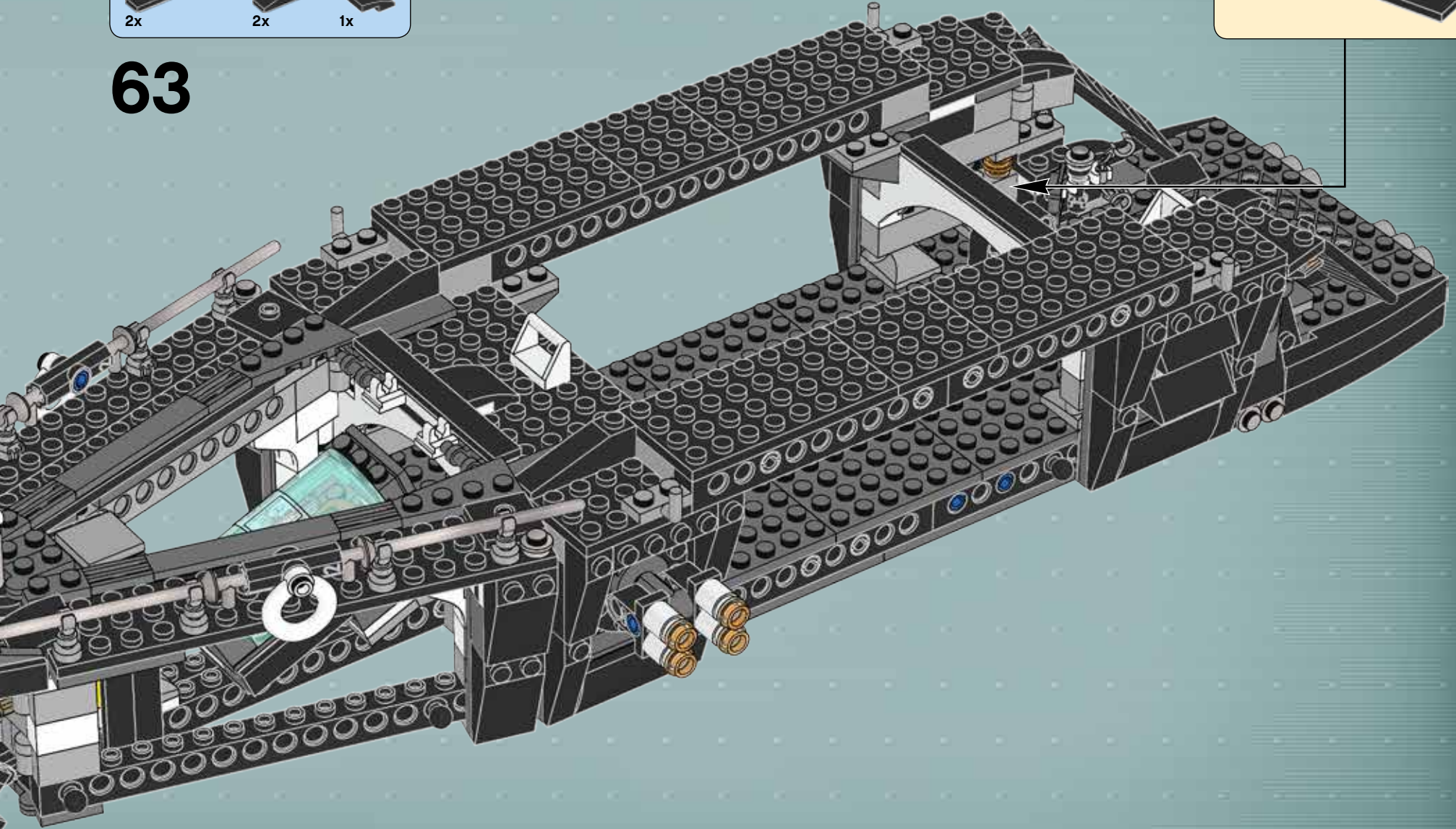

4x 4x 8x 4x 4x

64

4x

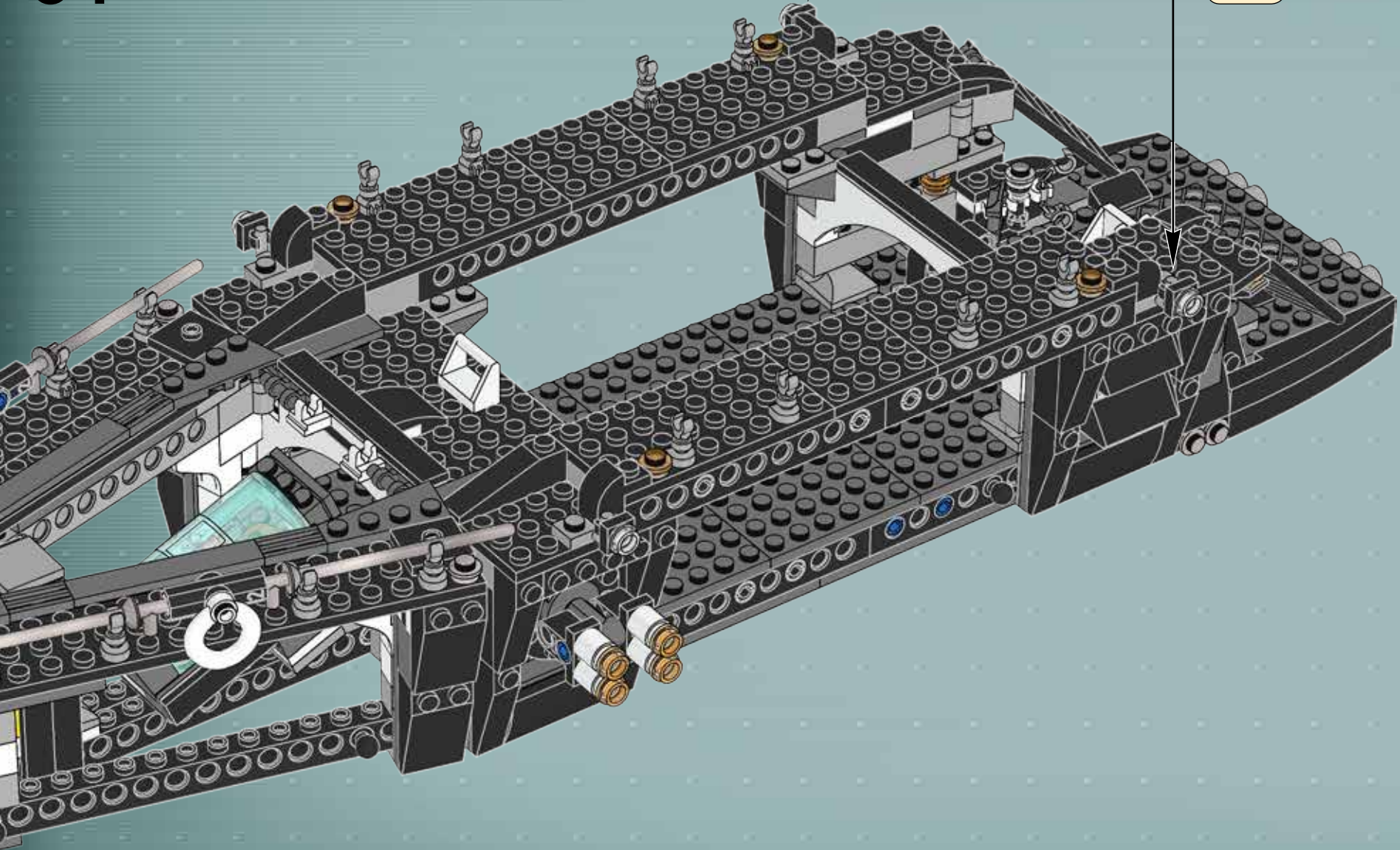

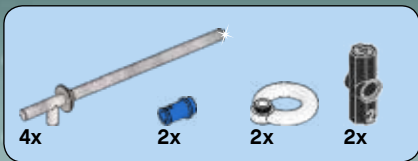

65

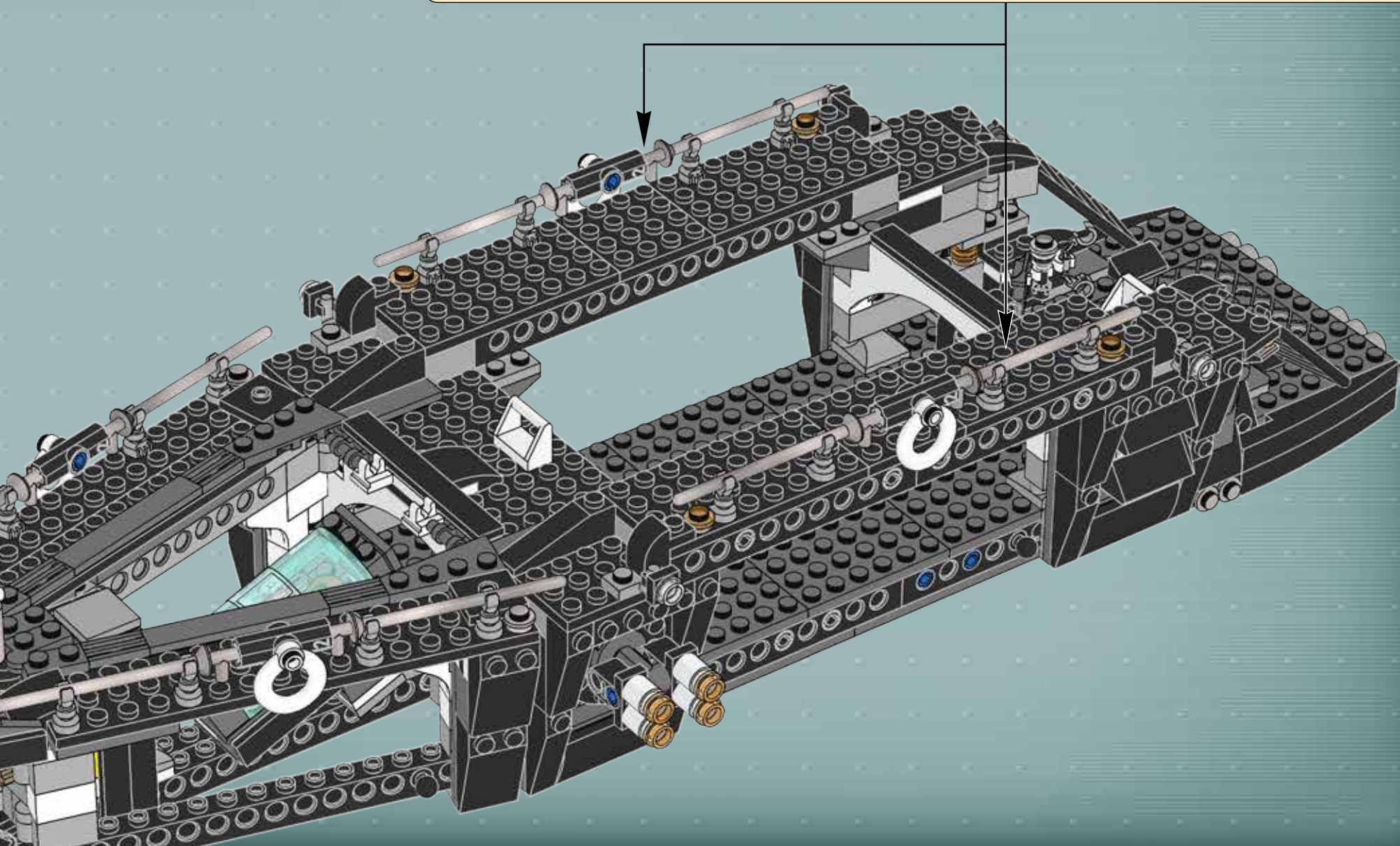
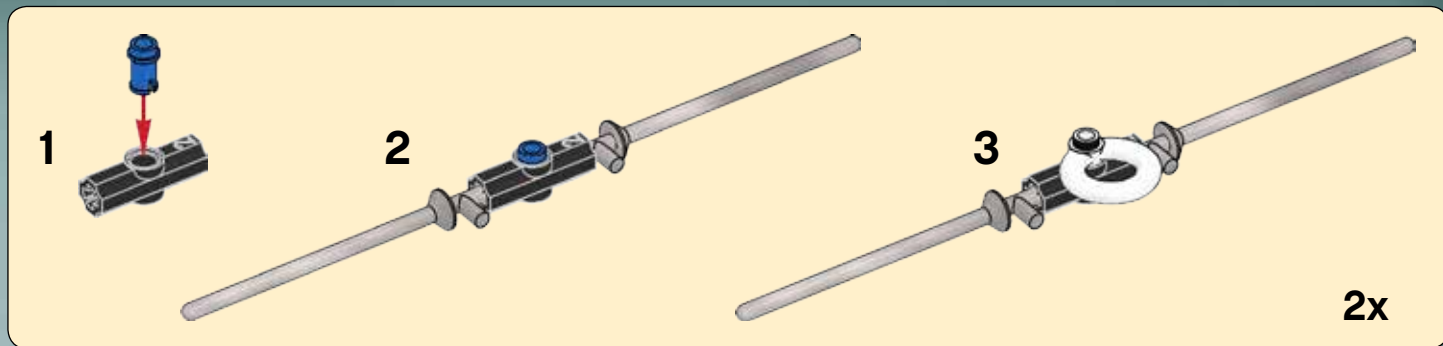

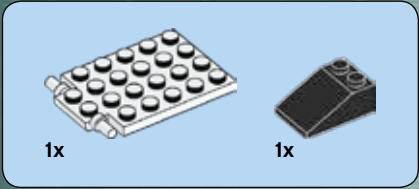

1

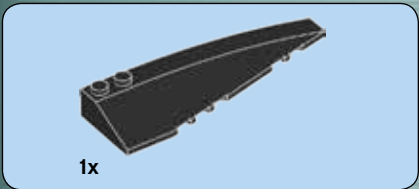

2

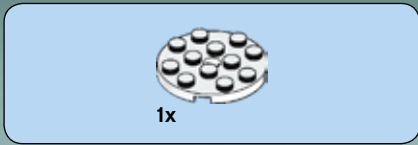
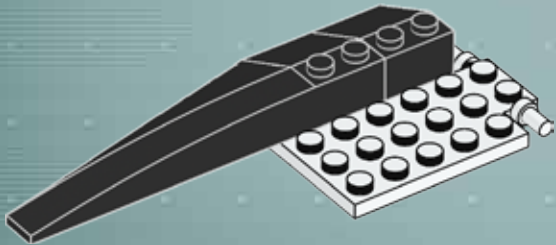

3

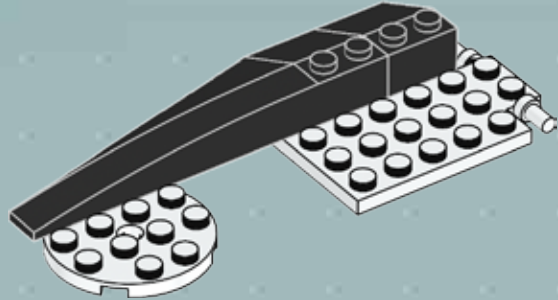

4

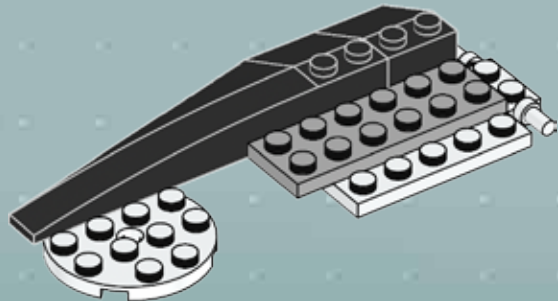

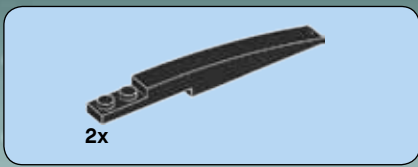

5

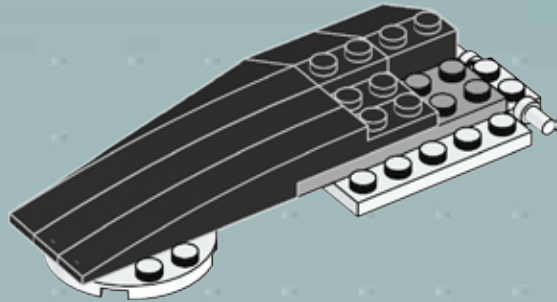

6

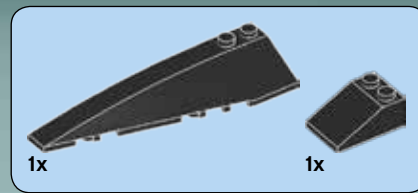
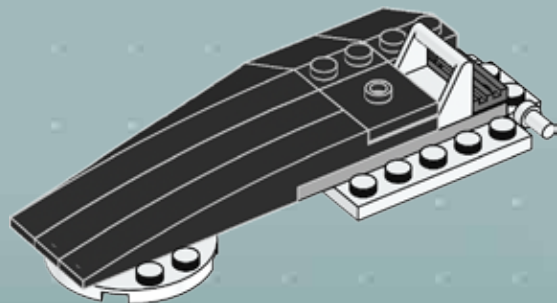

7

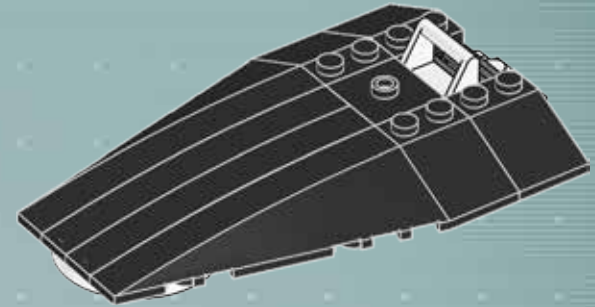

8

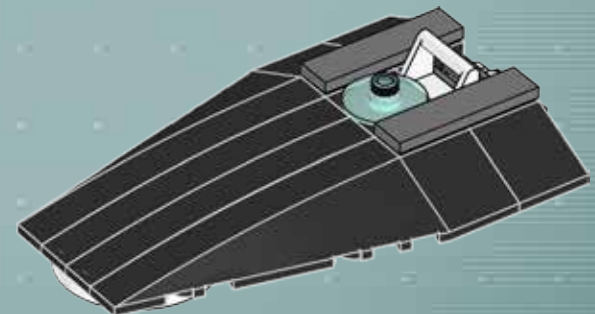

66

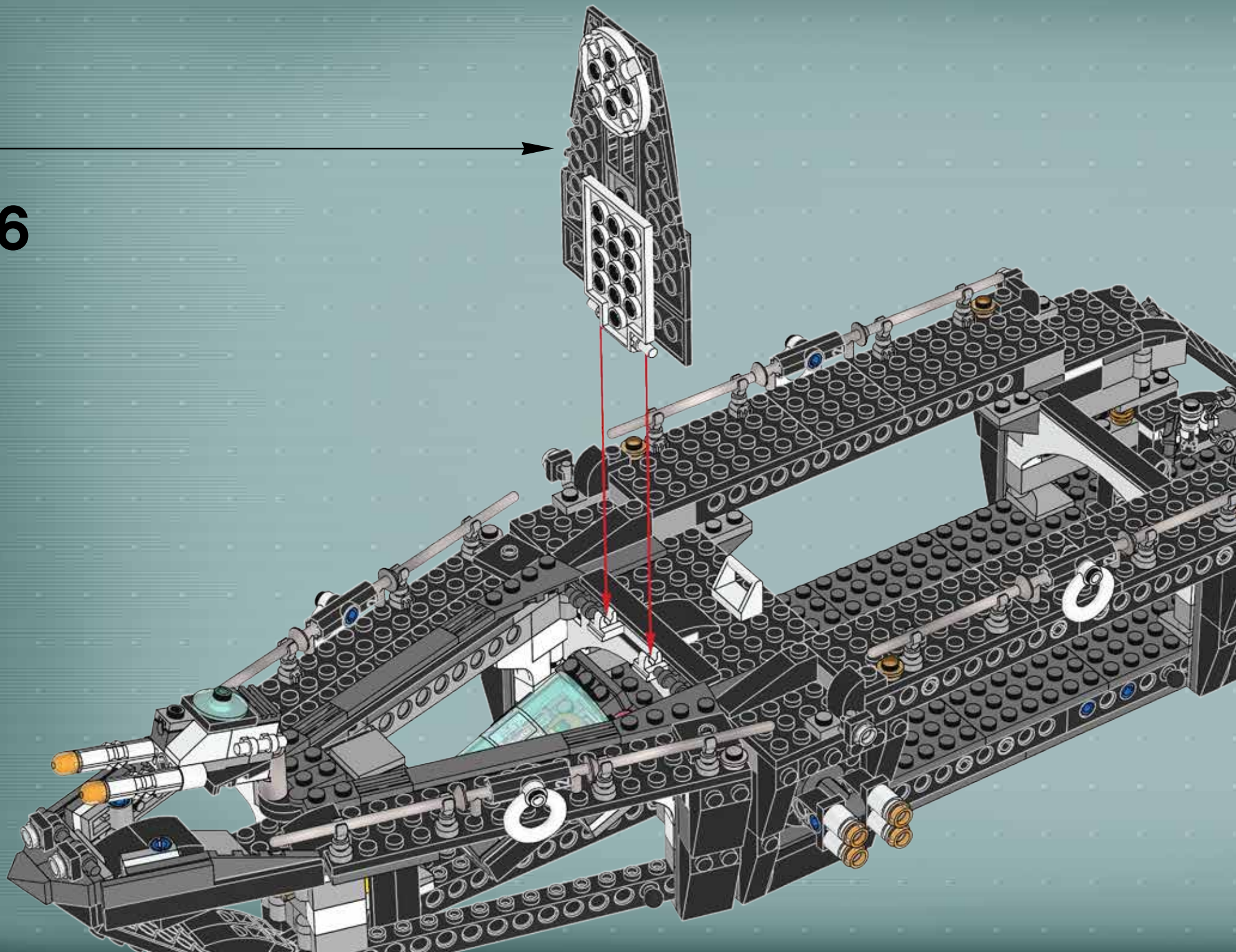

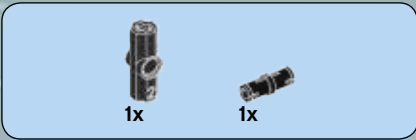

1



2

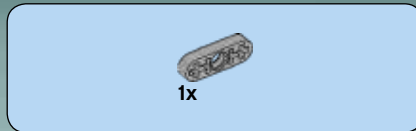

3

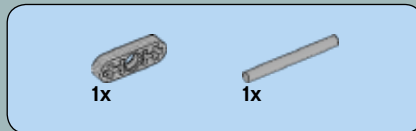
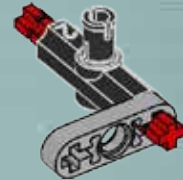

4

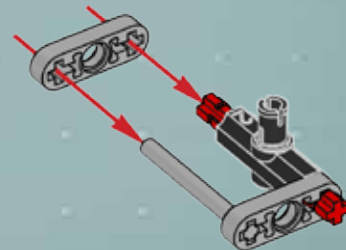

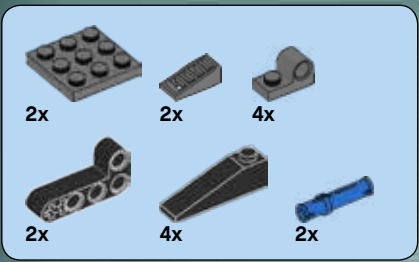

5

1

2

3

4

5

2x

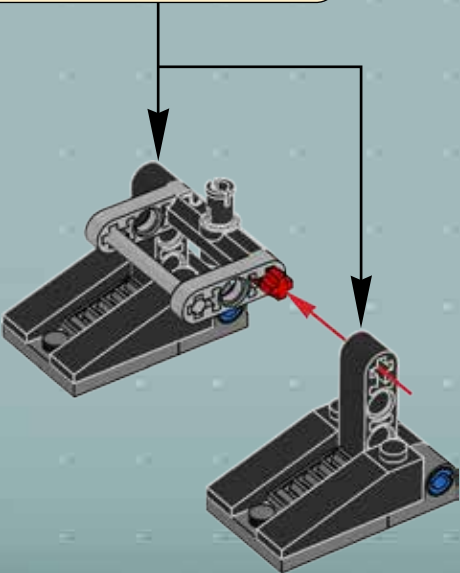

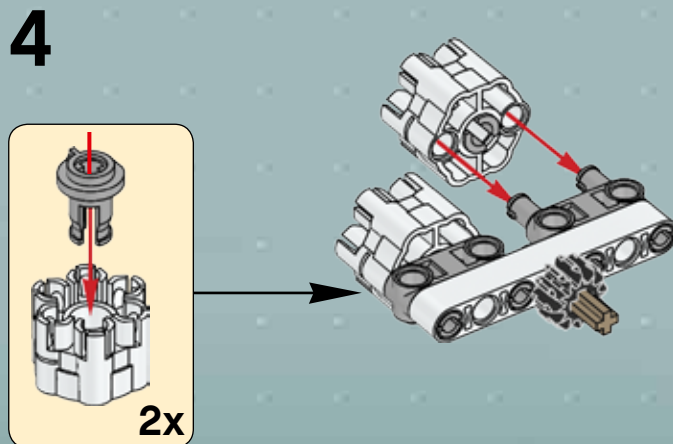
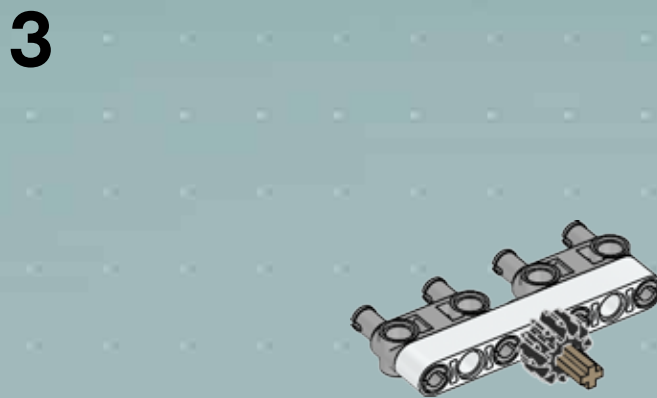
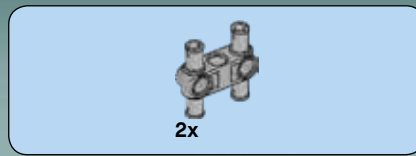
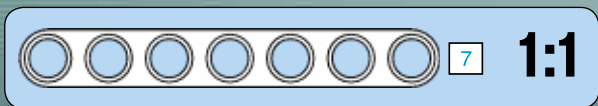
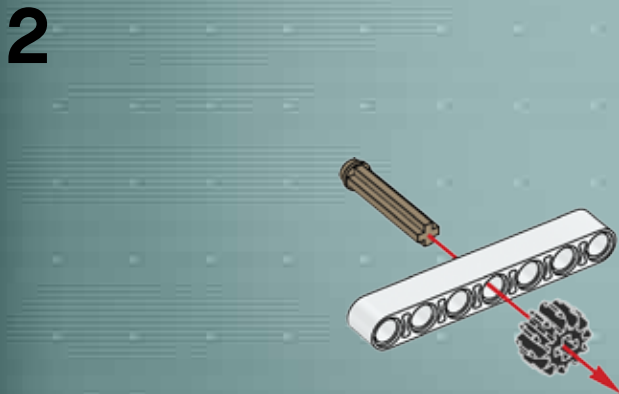
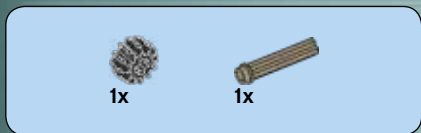
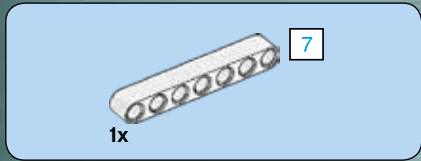

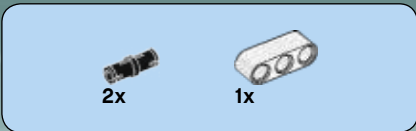

5

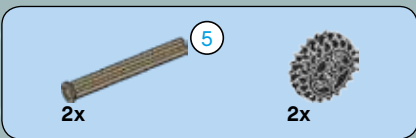
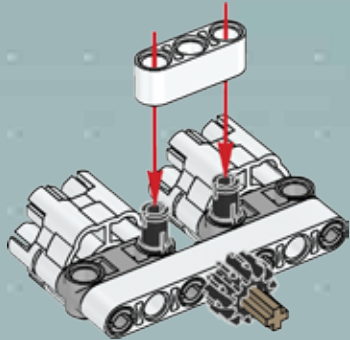

6

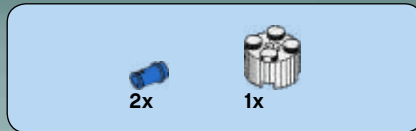
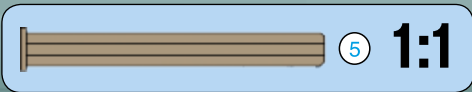
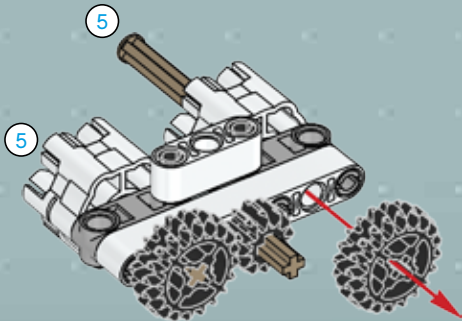

7

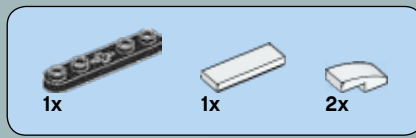
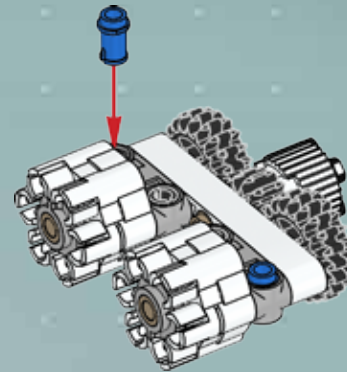

8

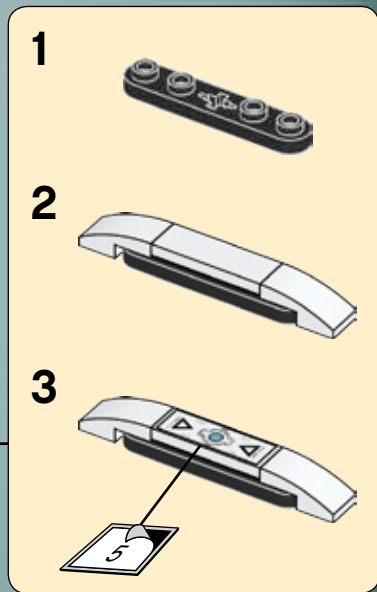
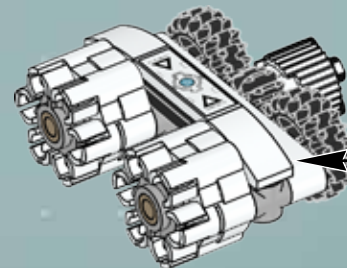

68

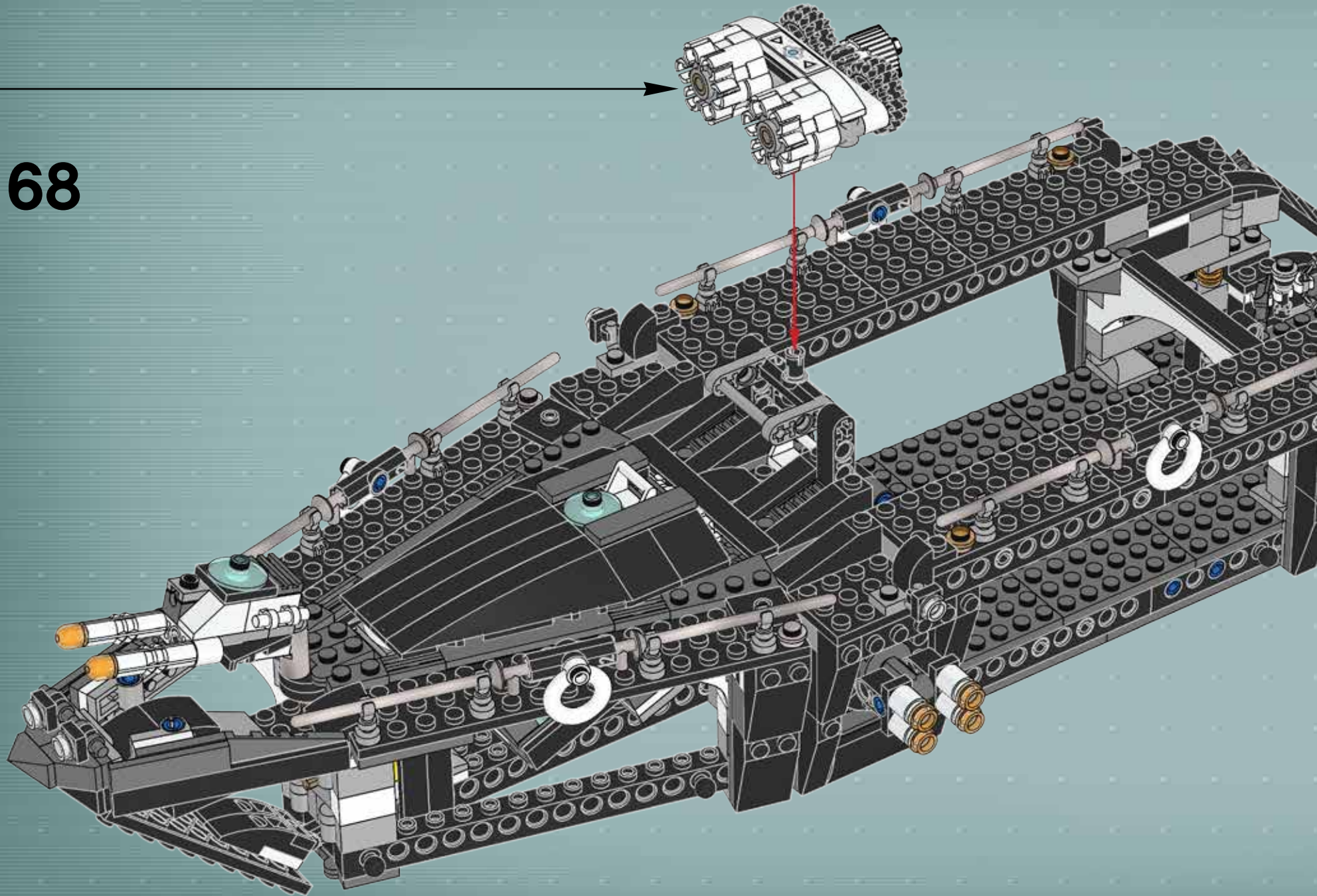

69

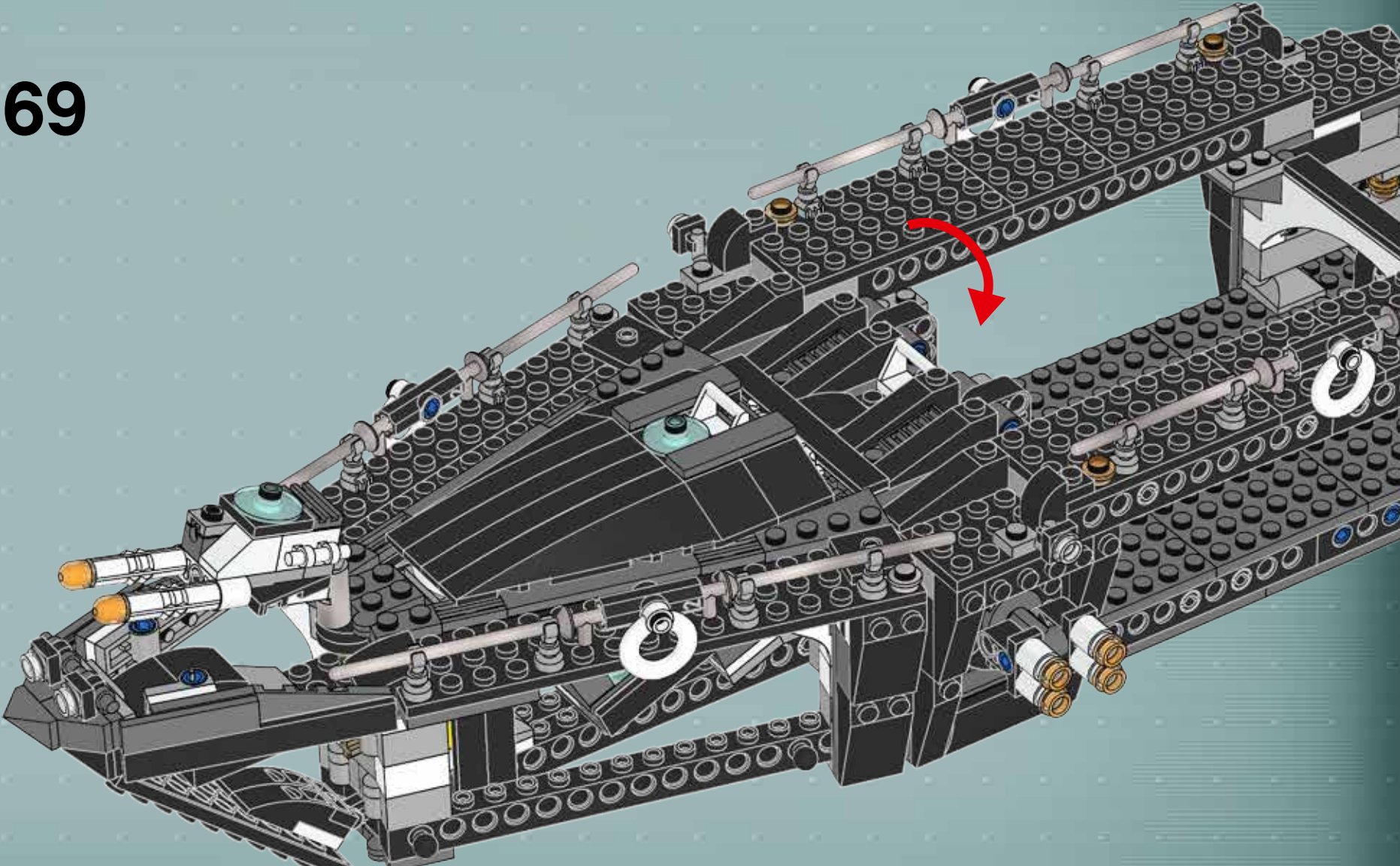

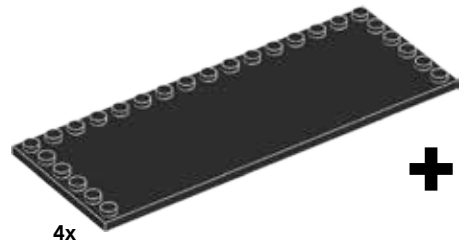

+

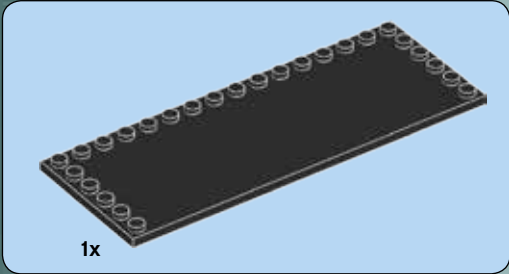
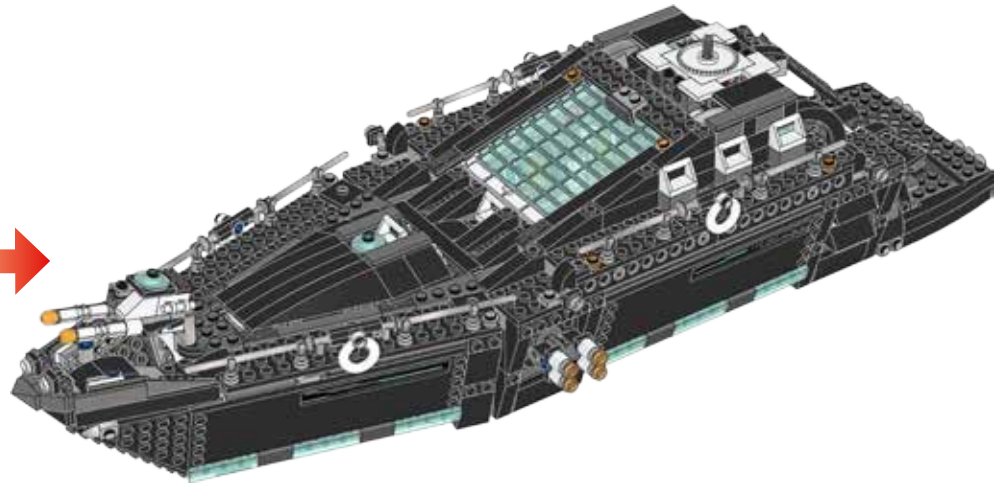

1

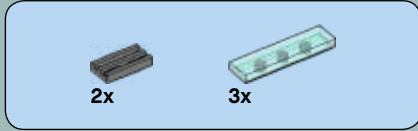
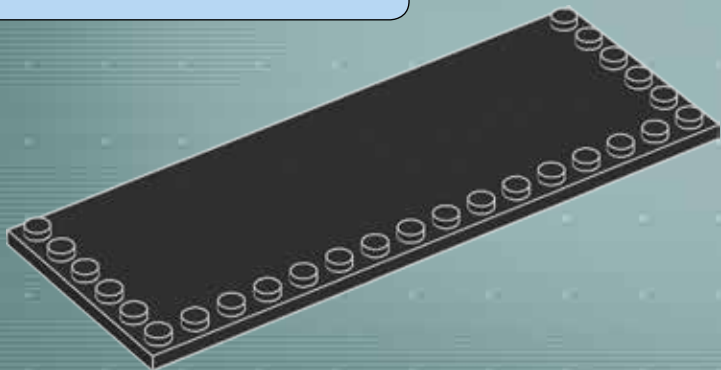

2

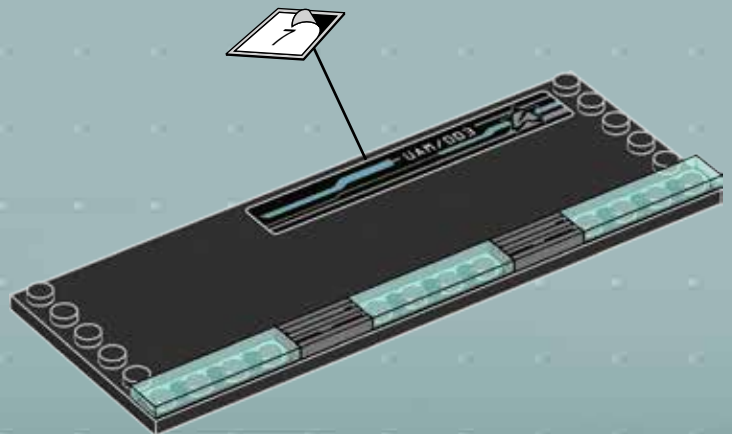



3

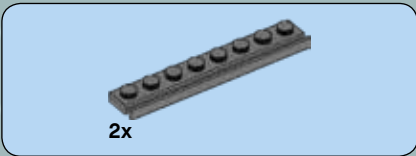
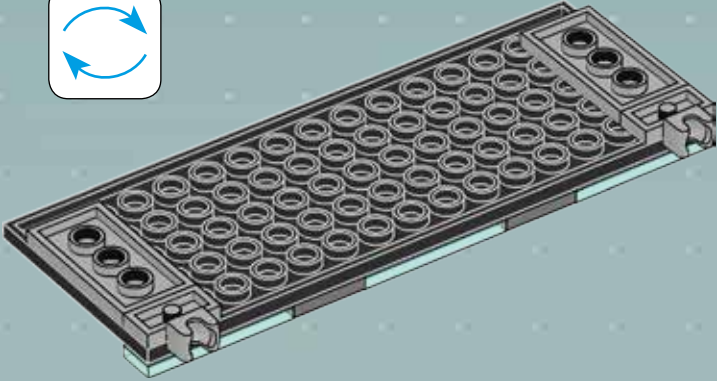

4

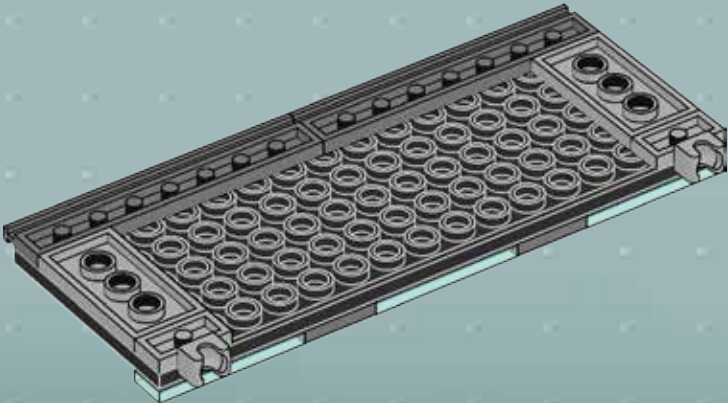

5

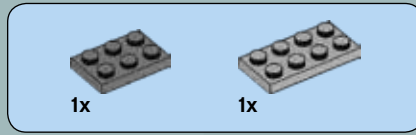
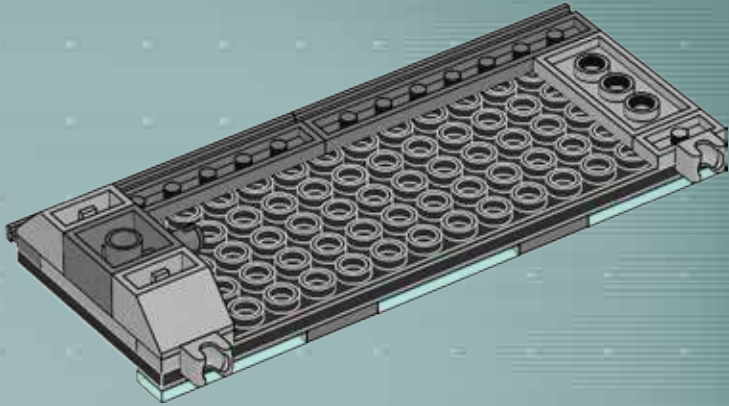

6

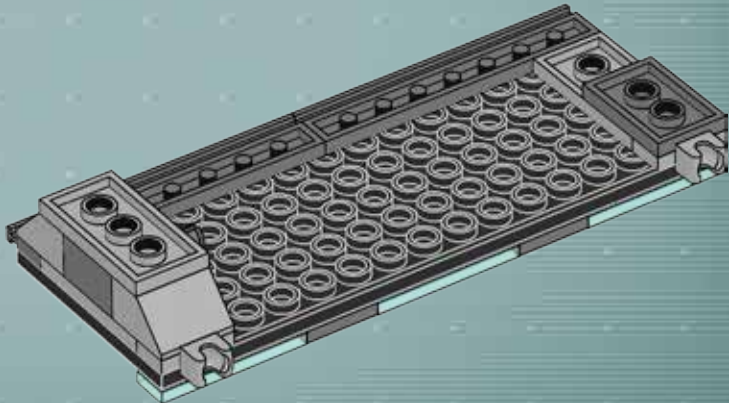

70

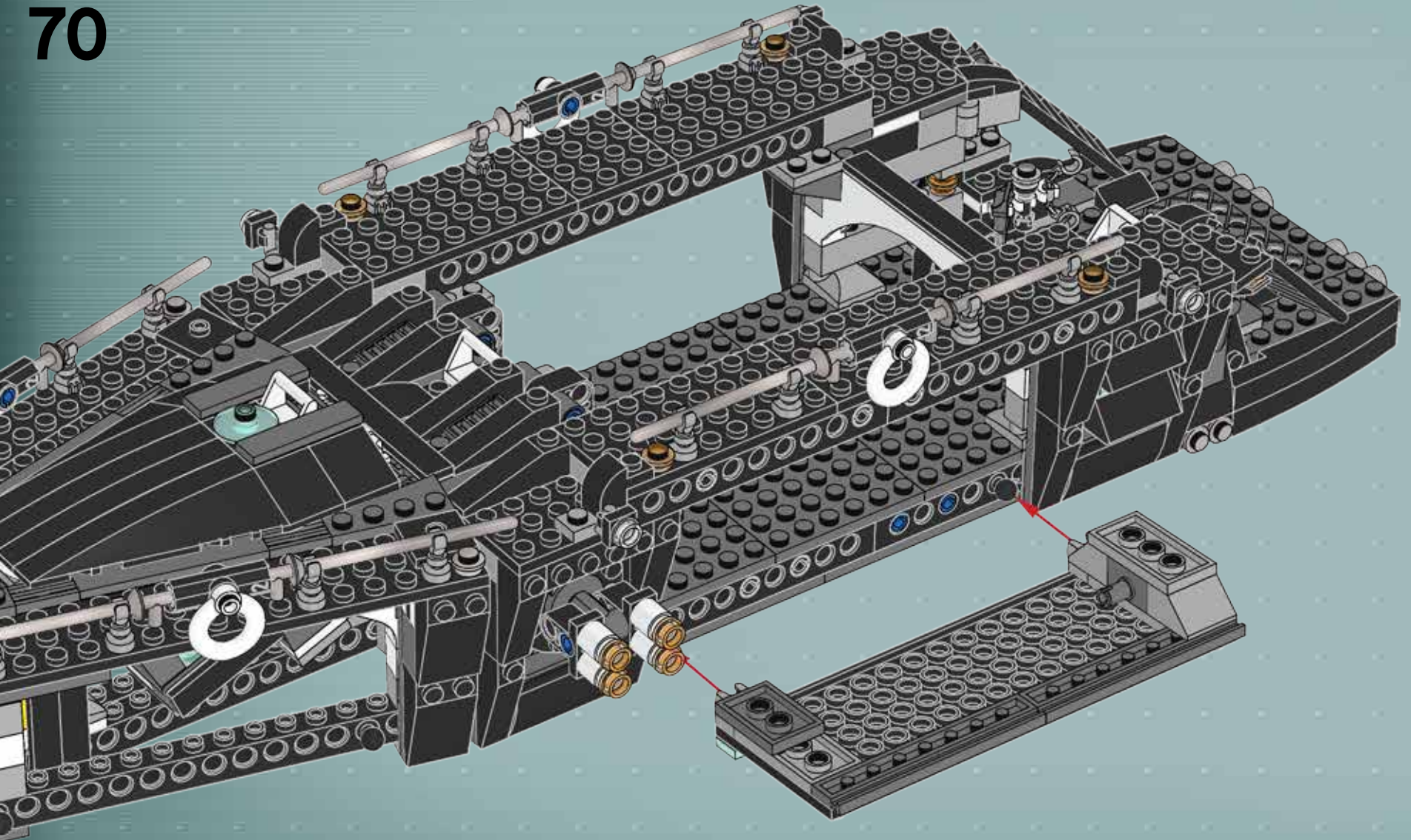

71

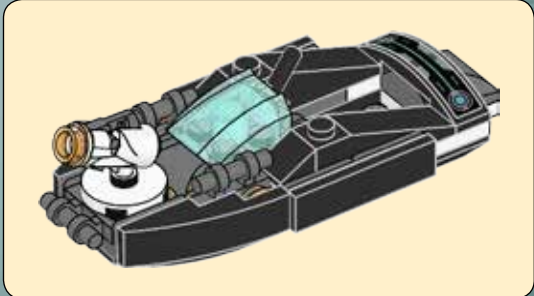
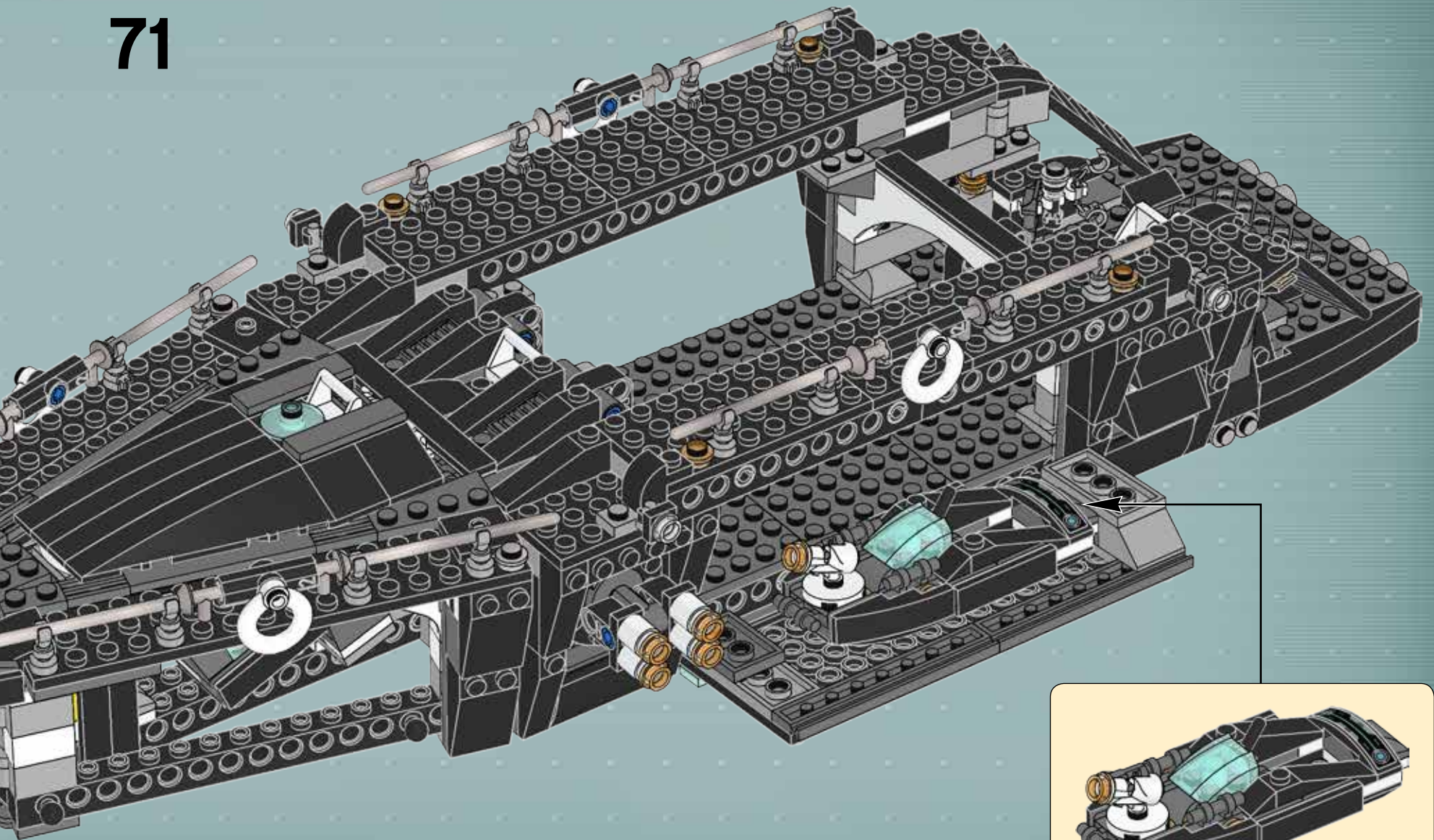

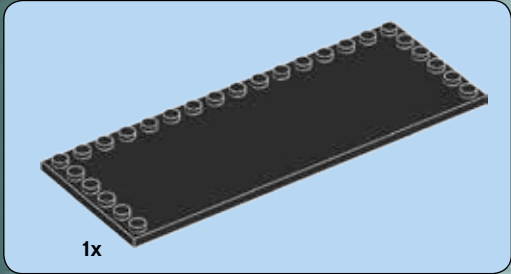
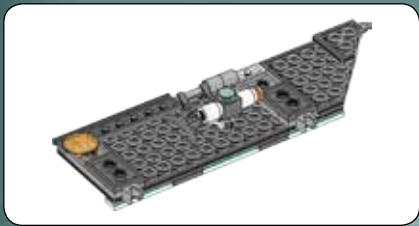

1

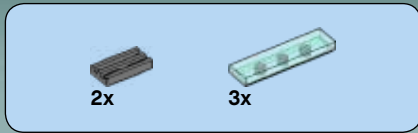
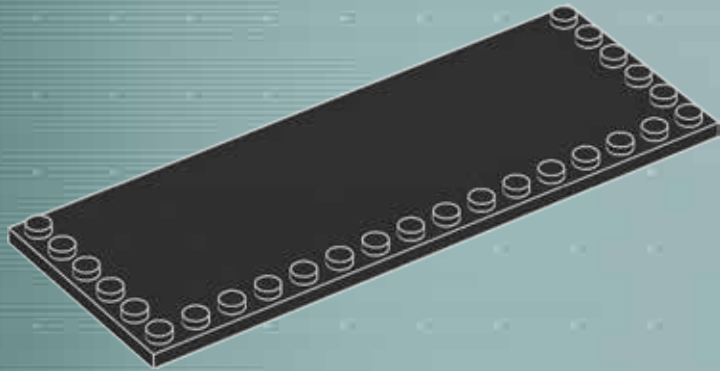

2

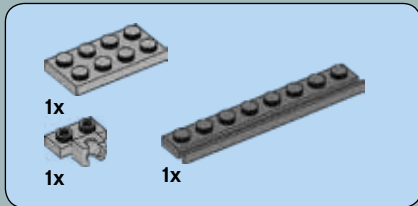
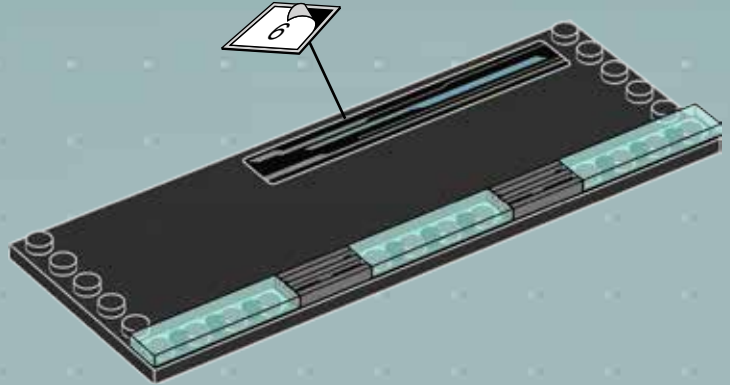

3

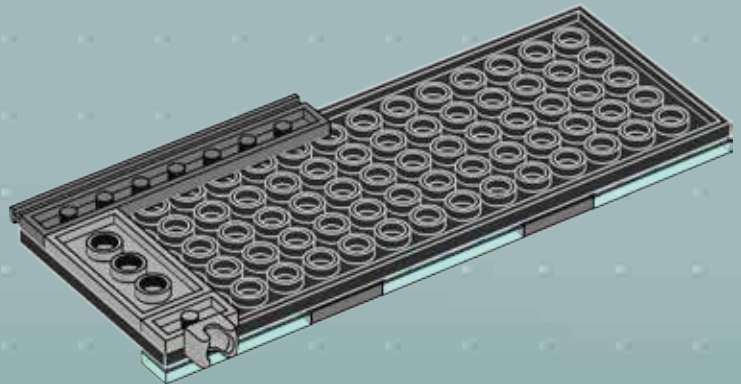

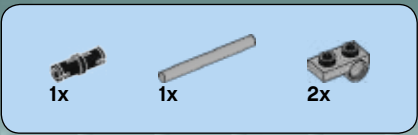

4

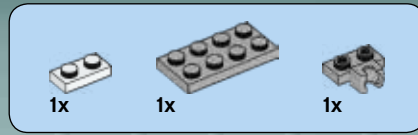
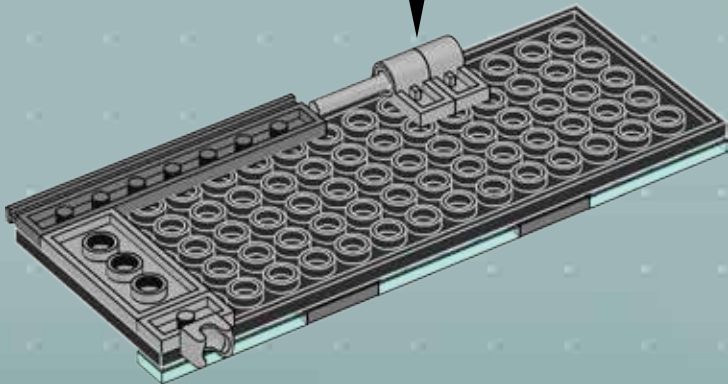
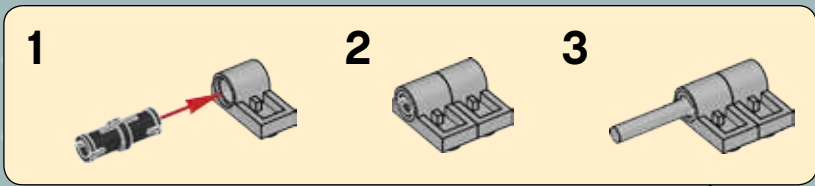

5

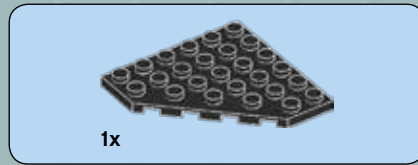
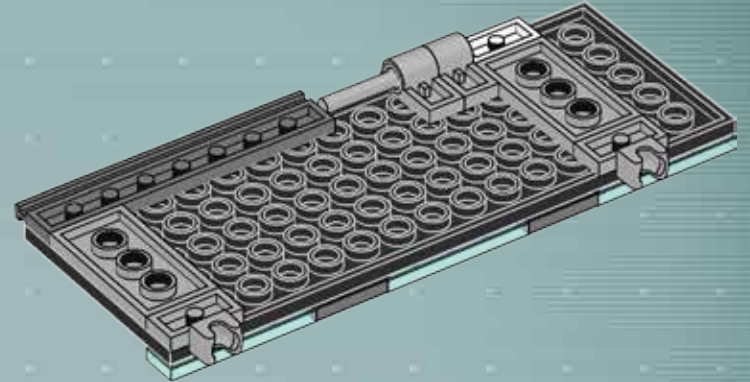

6

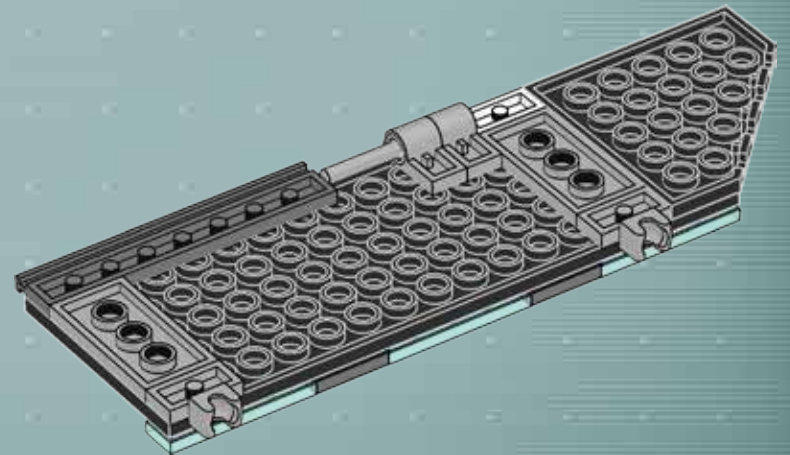



1x



1x

7

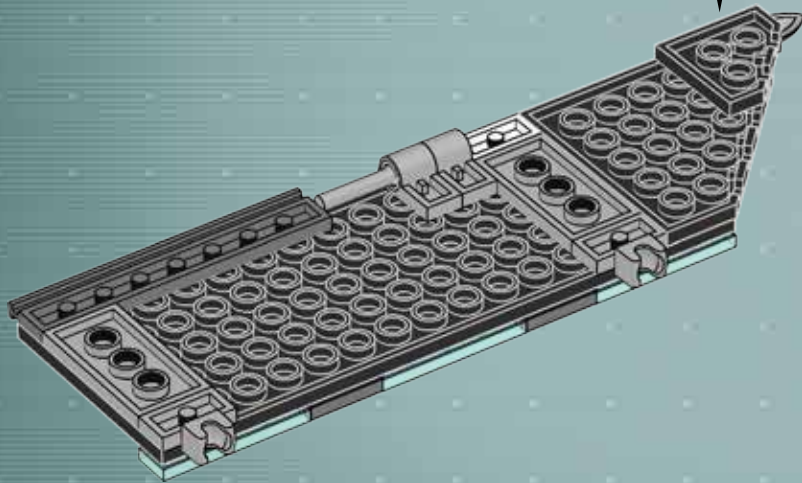
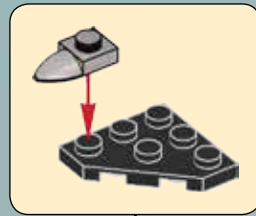

2x



1x

8

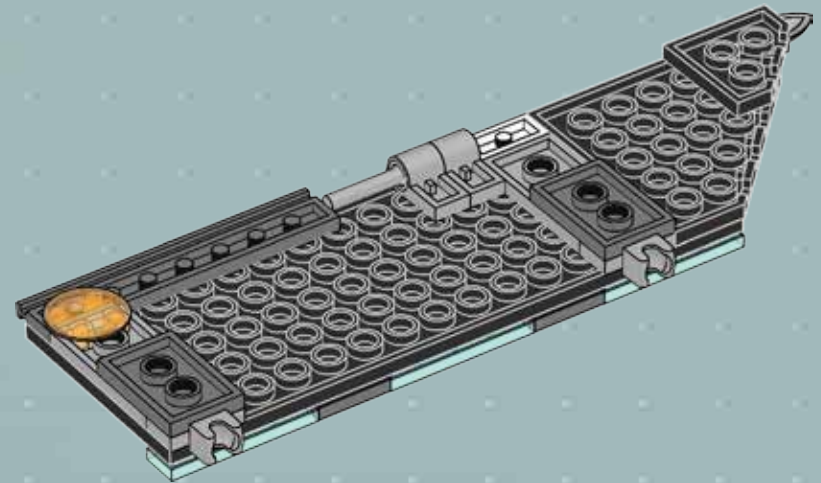



9

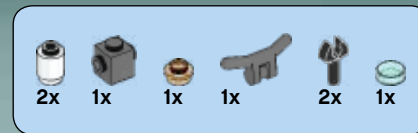
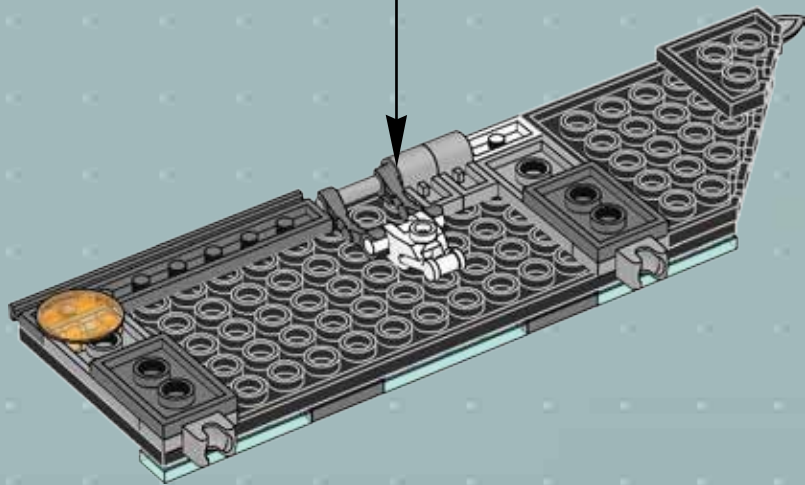
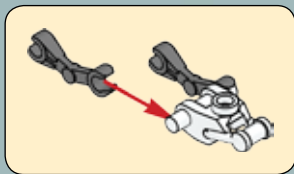

10

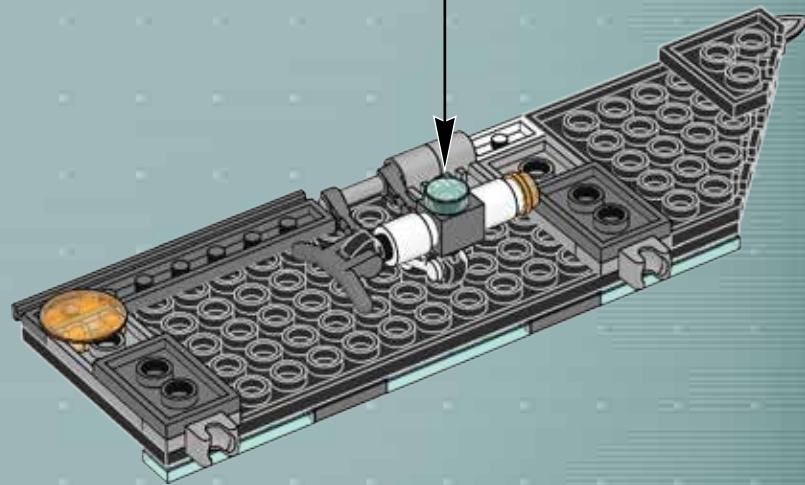
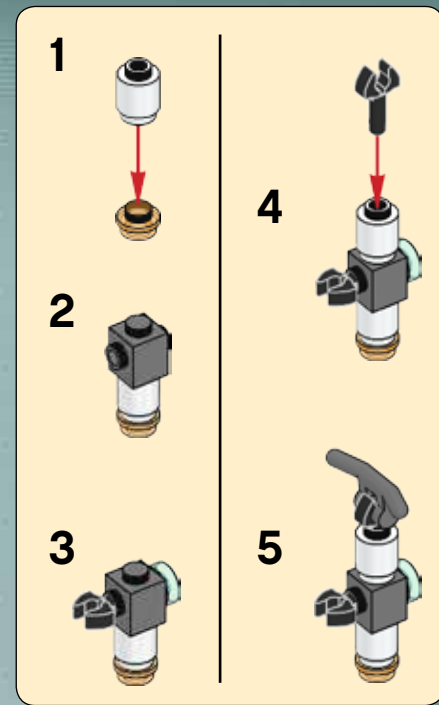

72

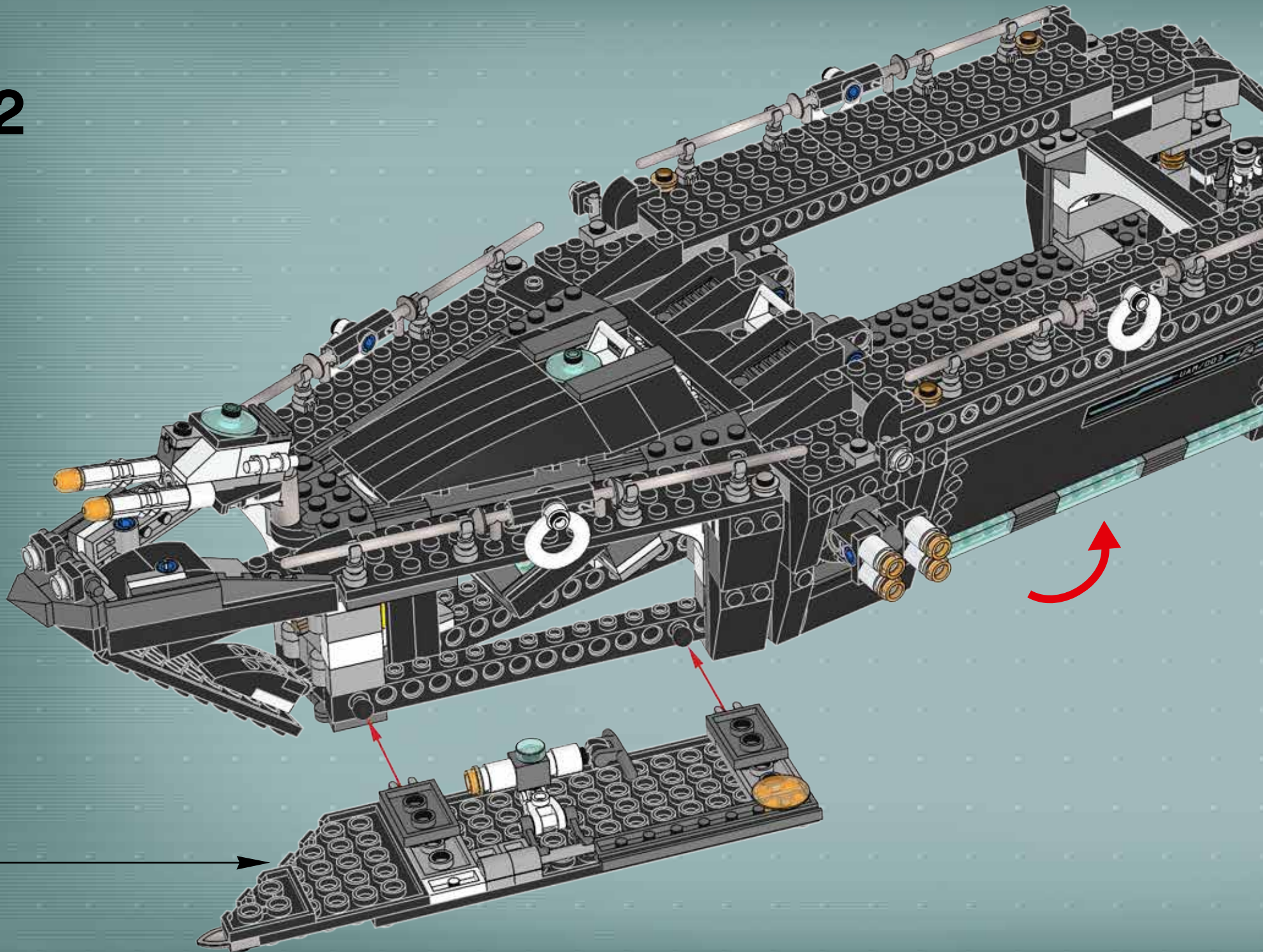

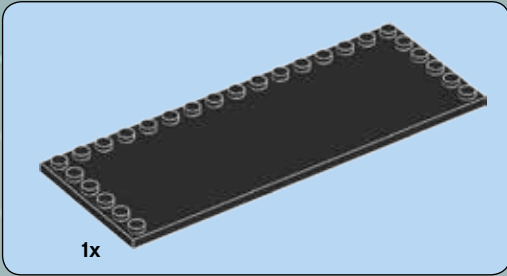
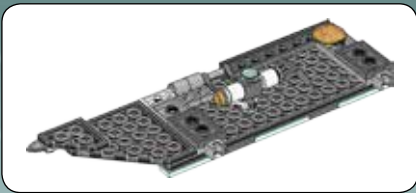

1

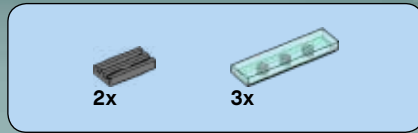
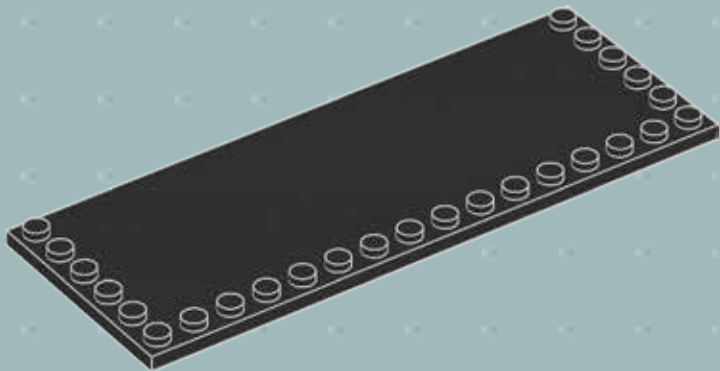

2

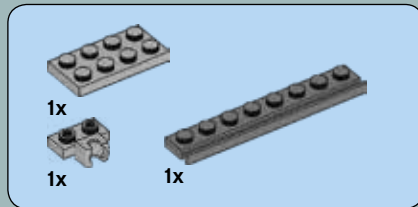
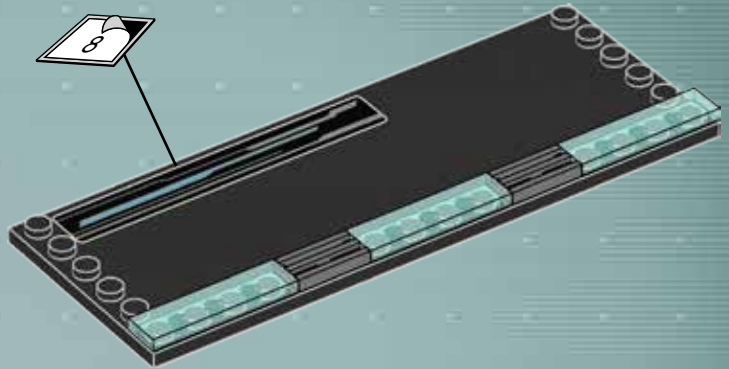

3

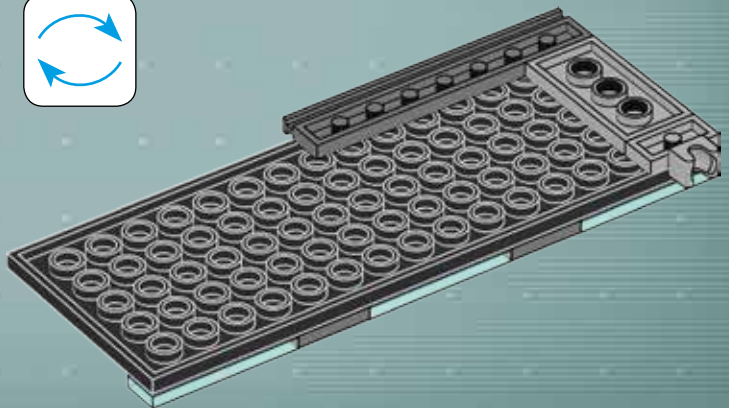
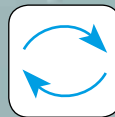

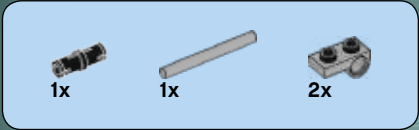

4

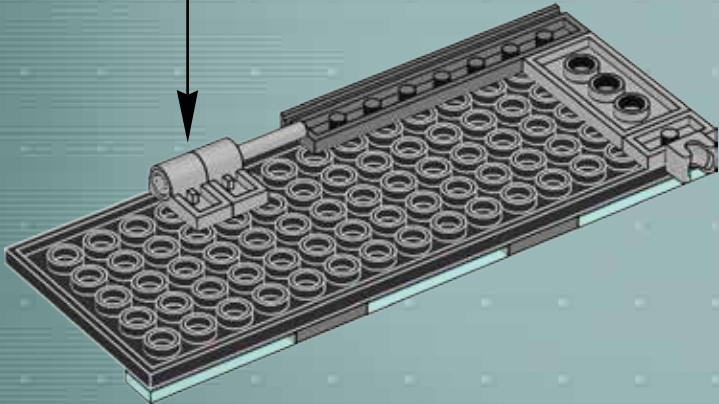
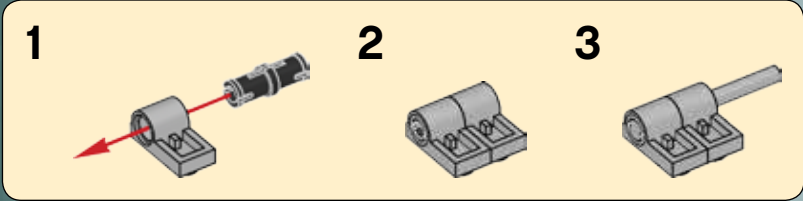

5

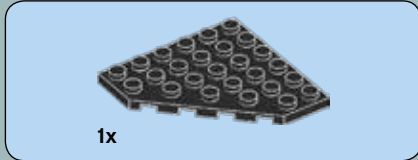
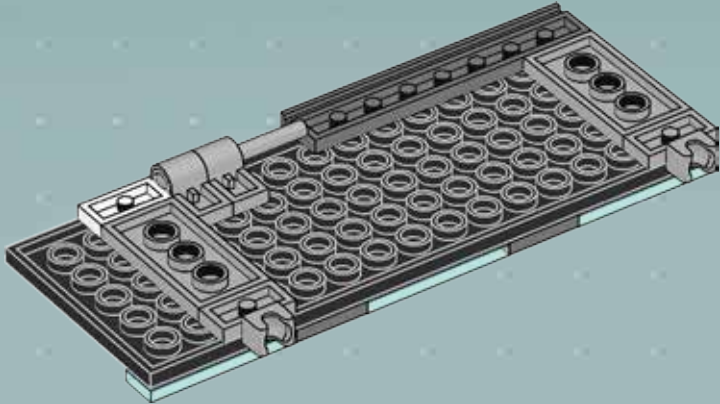

6

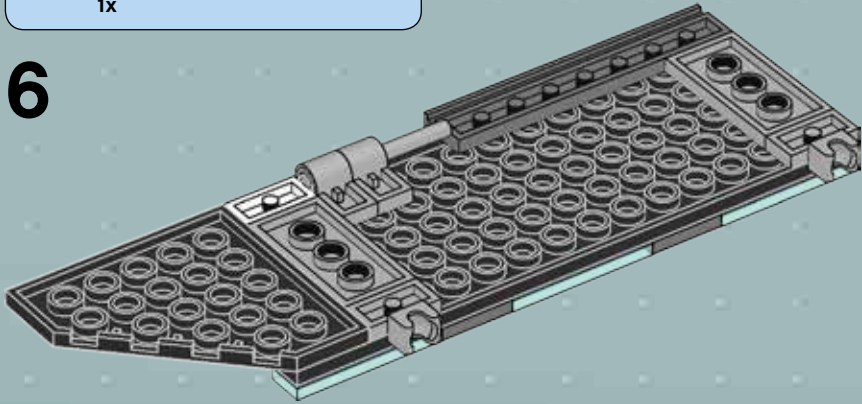



7

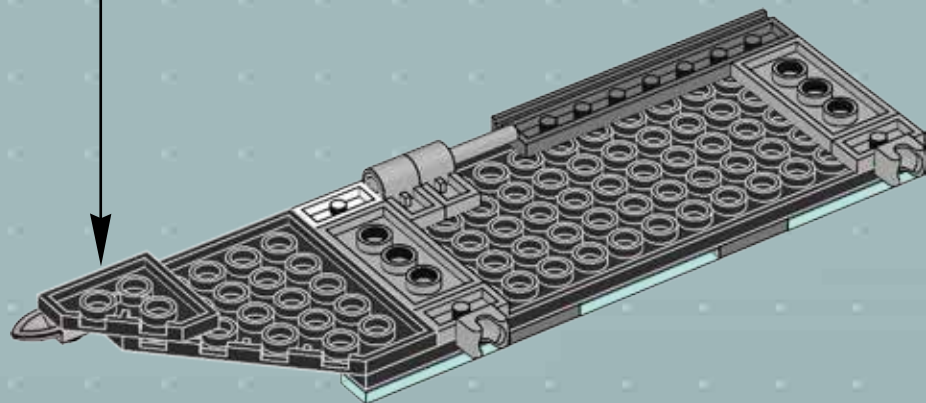
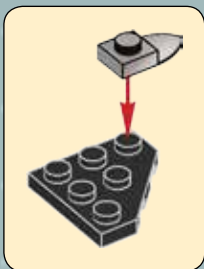

8

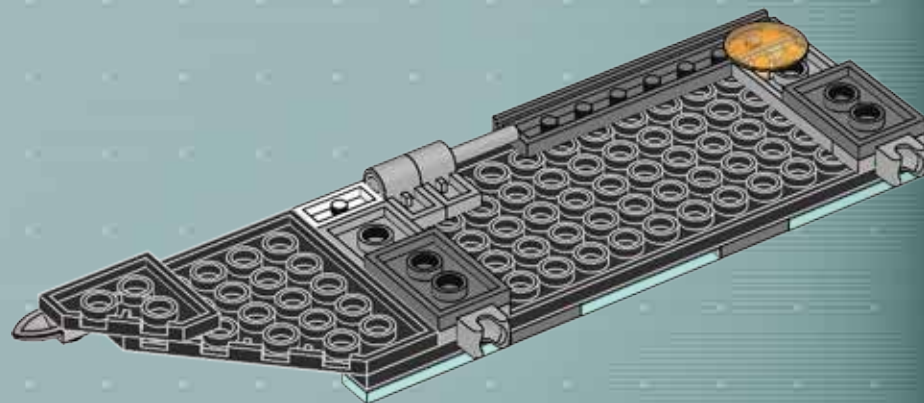



9

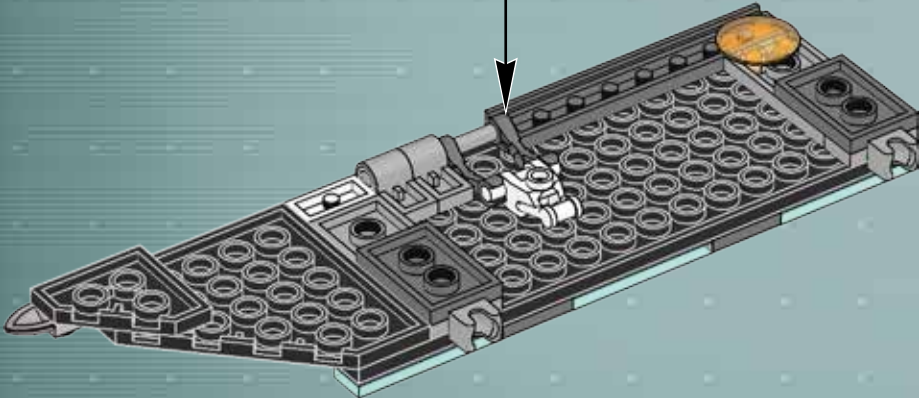
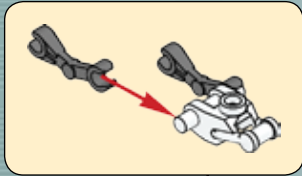

10

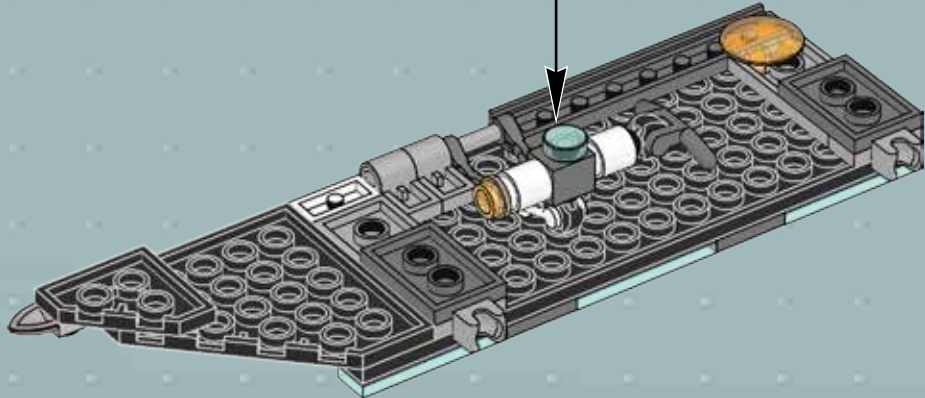
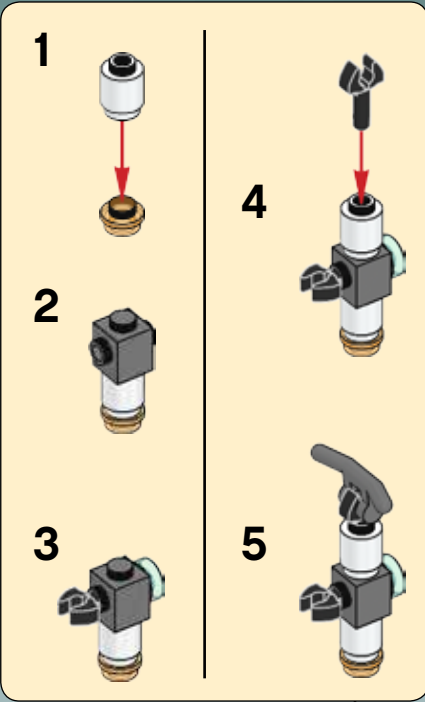

73

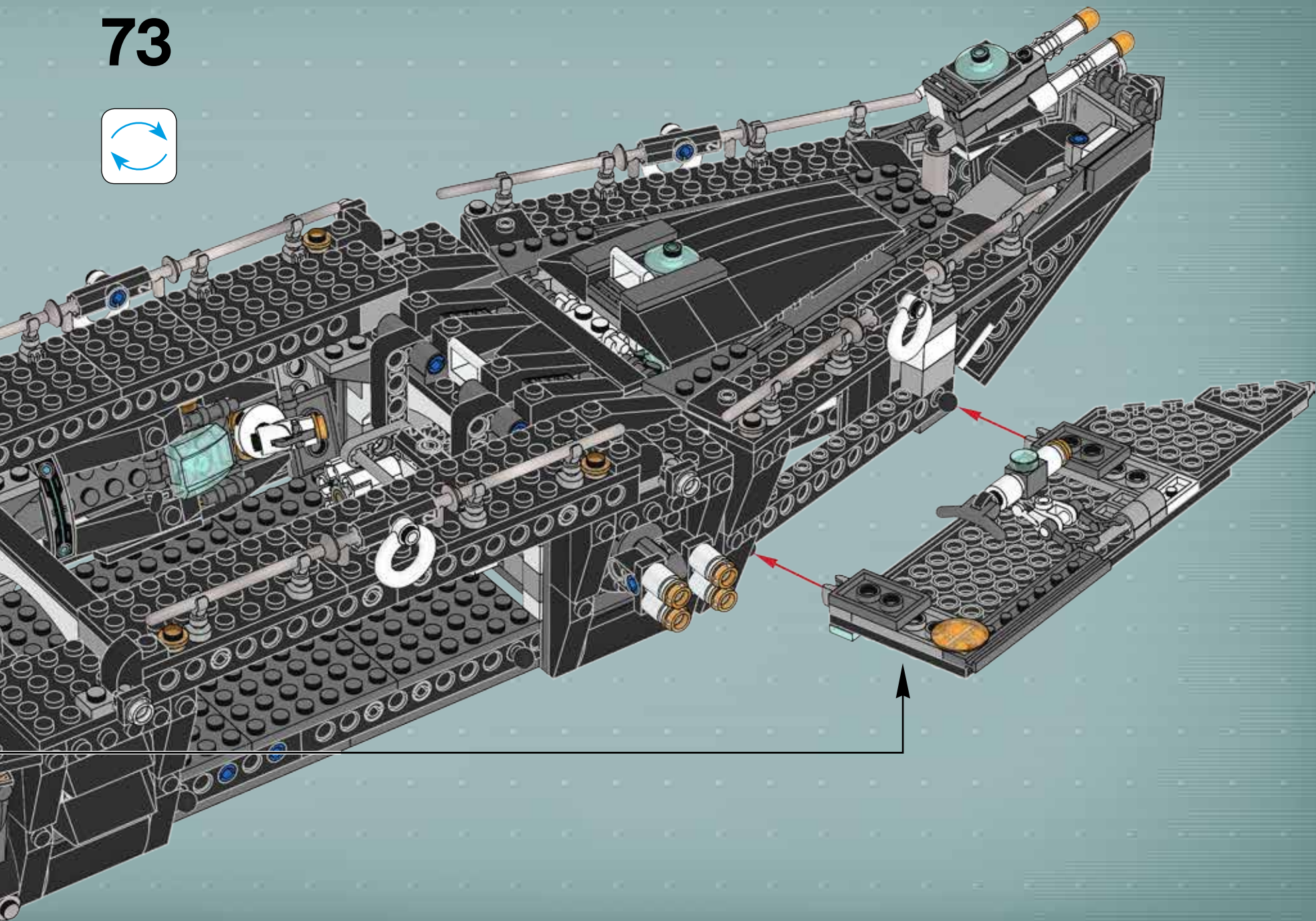

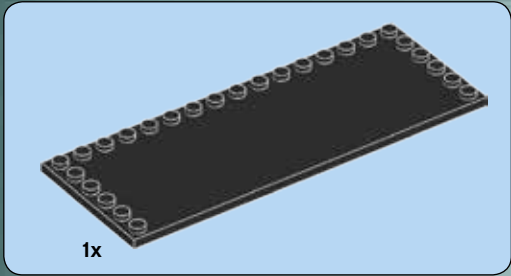

1

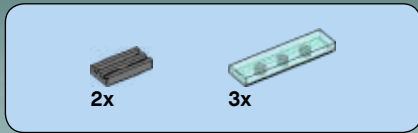
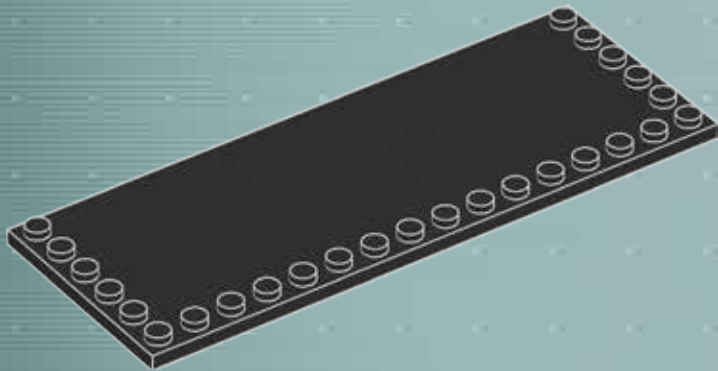

2

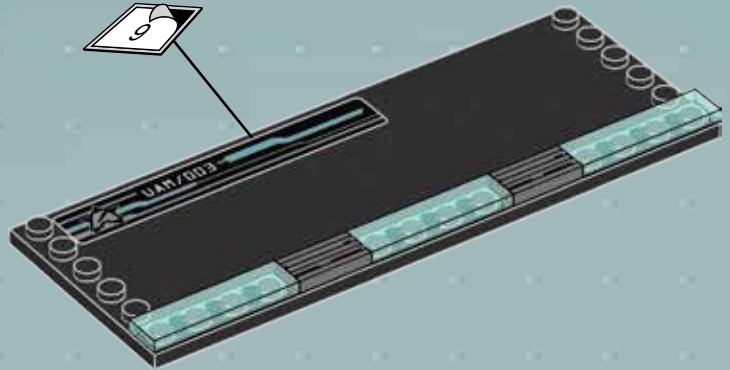

3

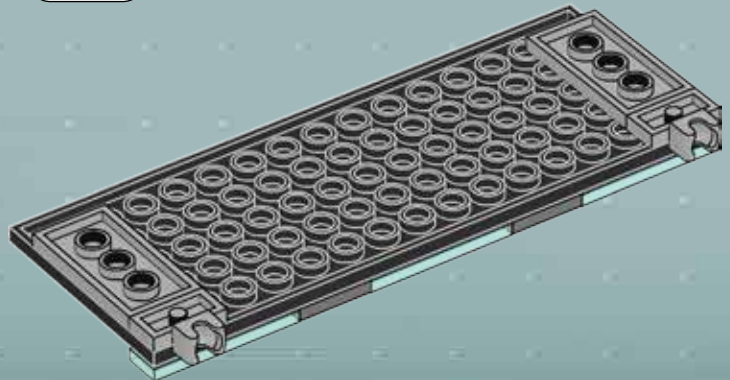

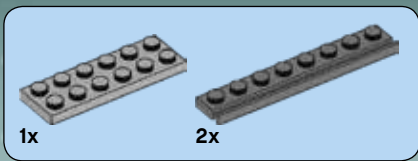

4

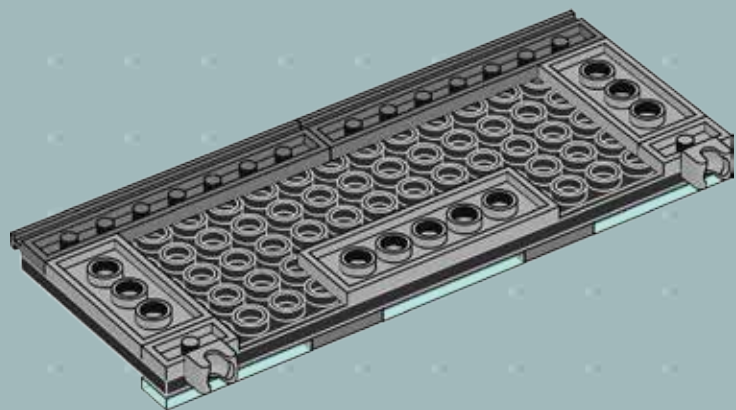

5

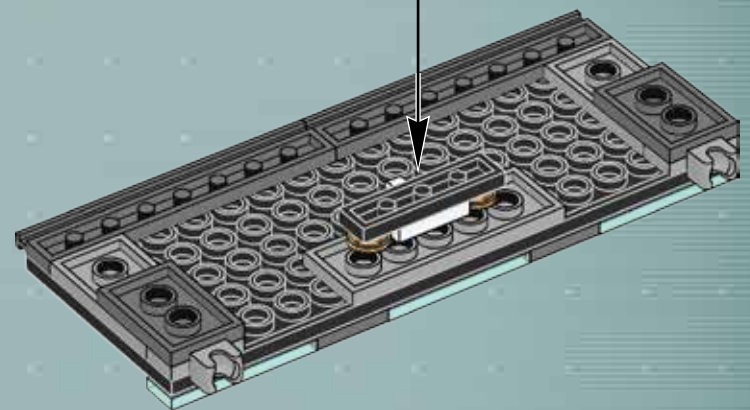
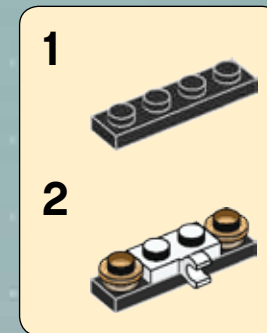

74

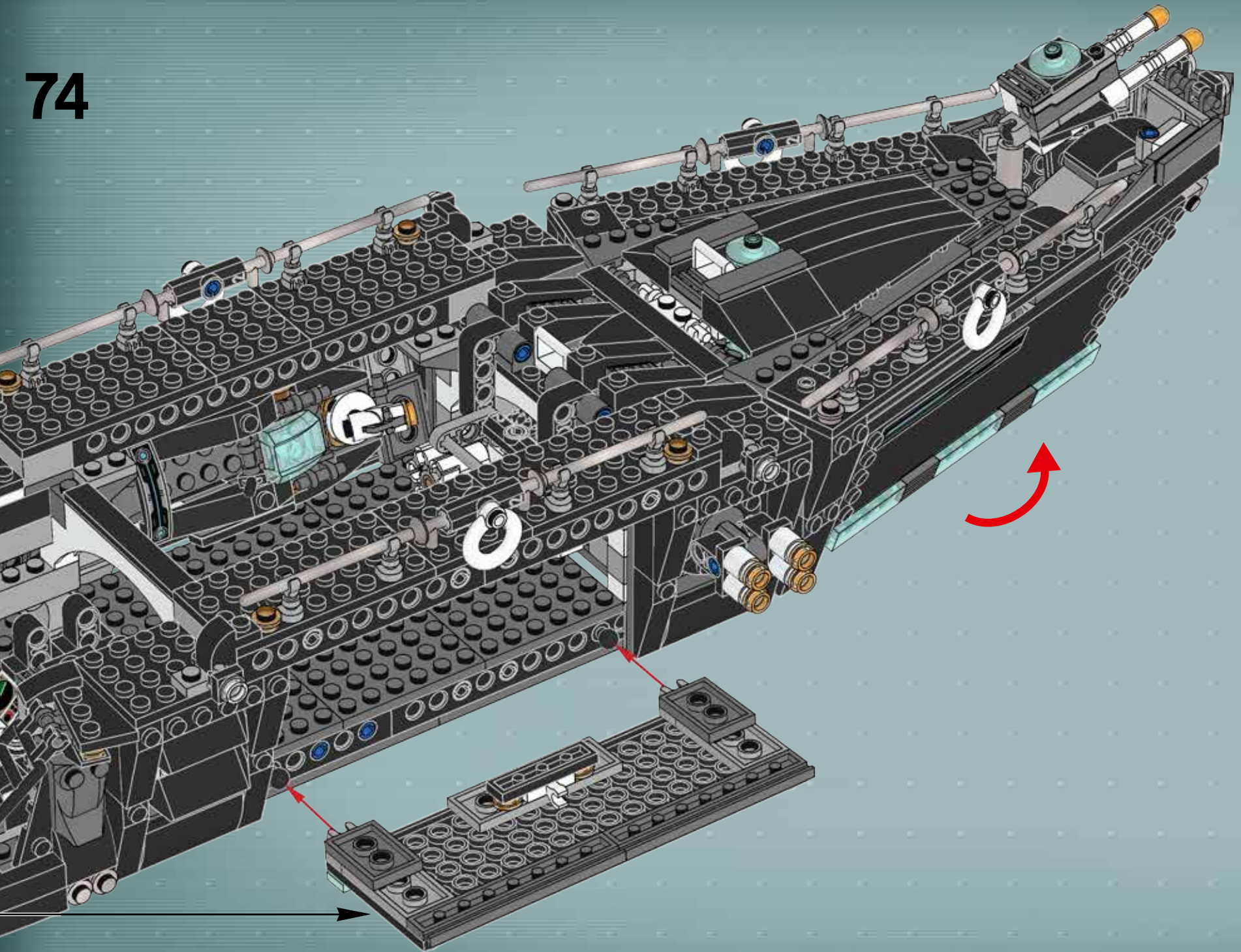

75

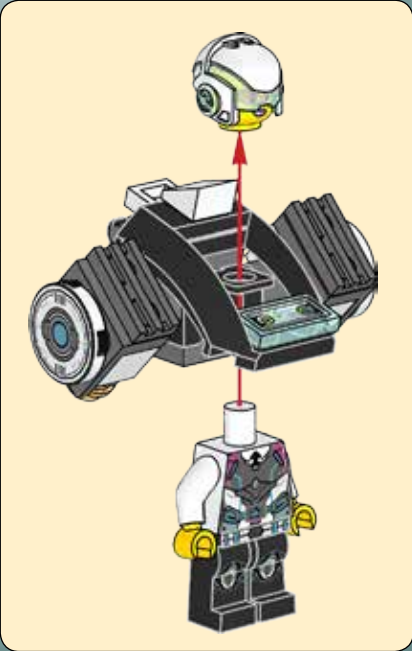
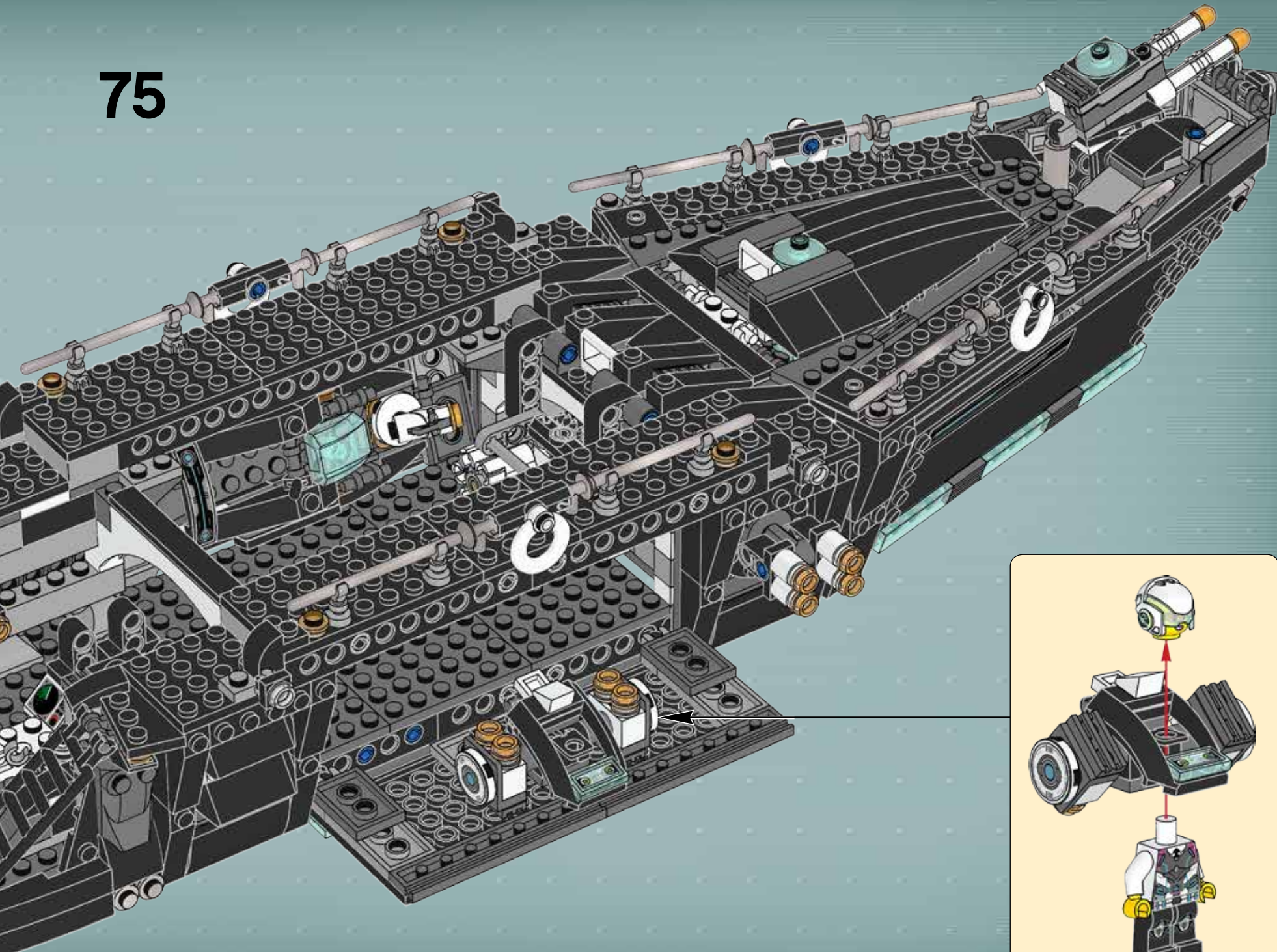

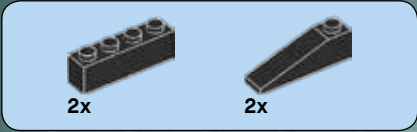

76

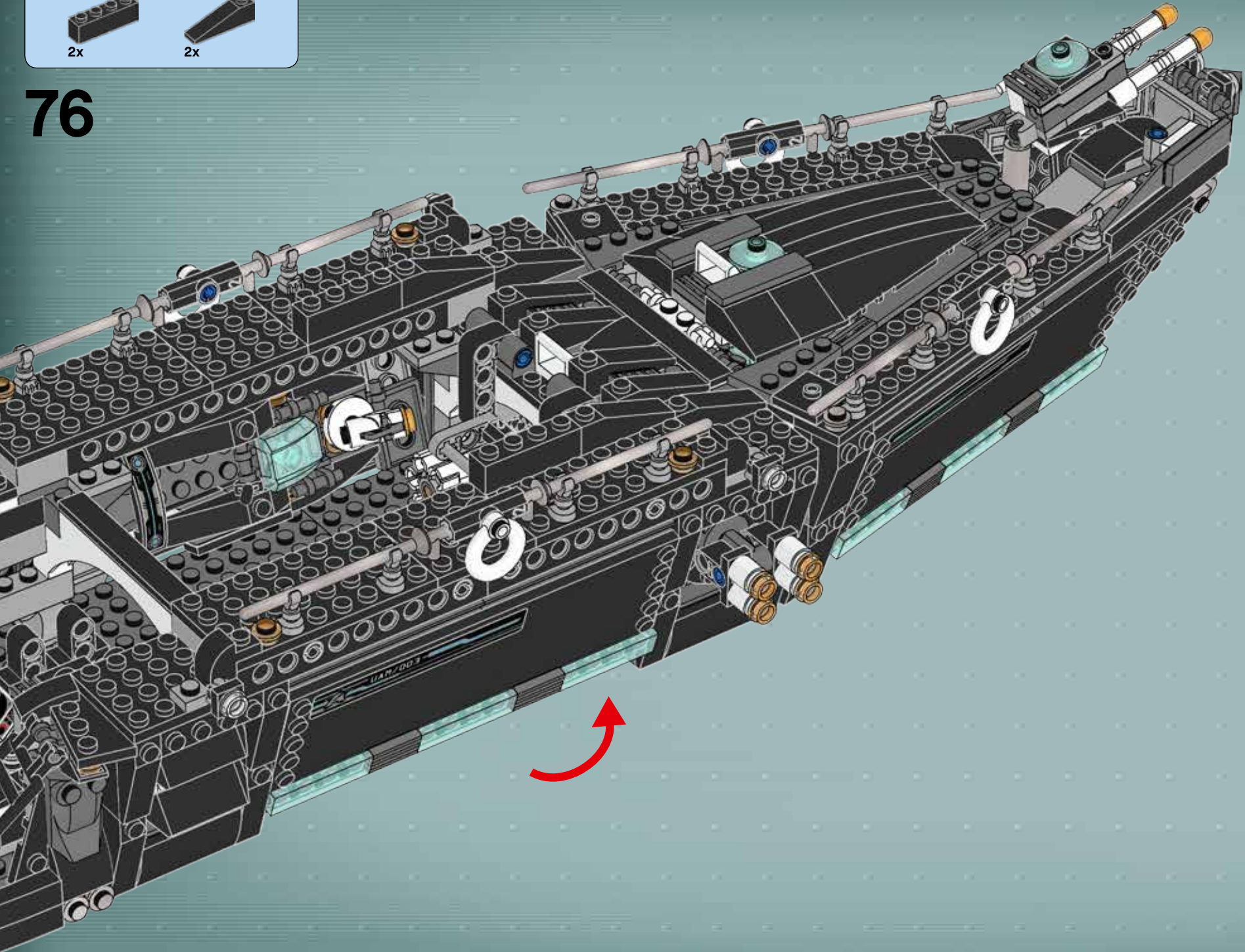

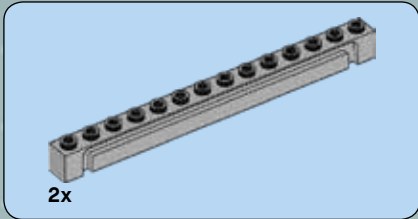
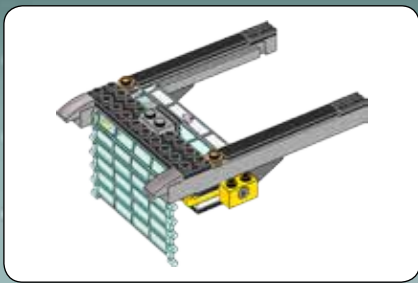

1

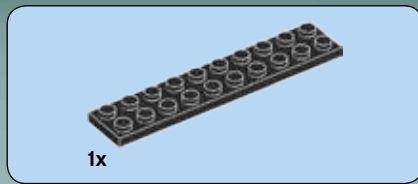
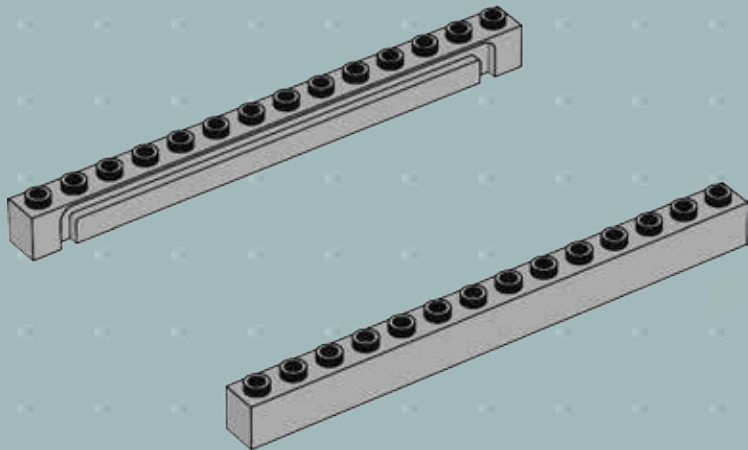

2

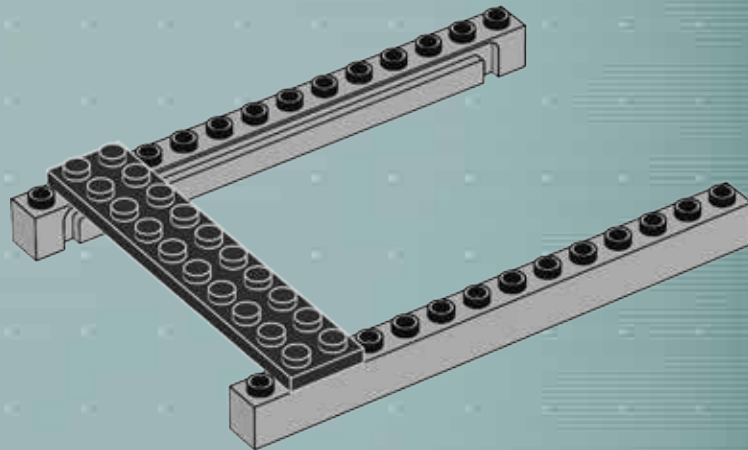

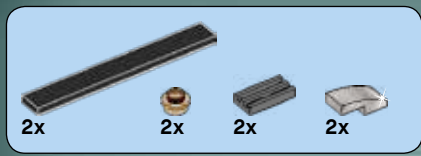

3

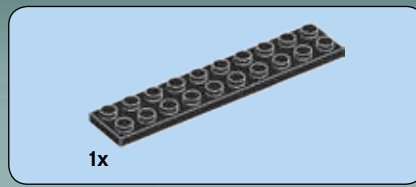
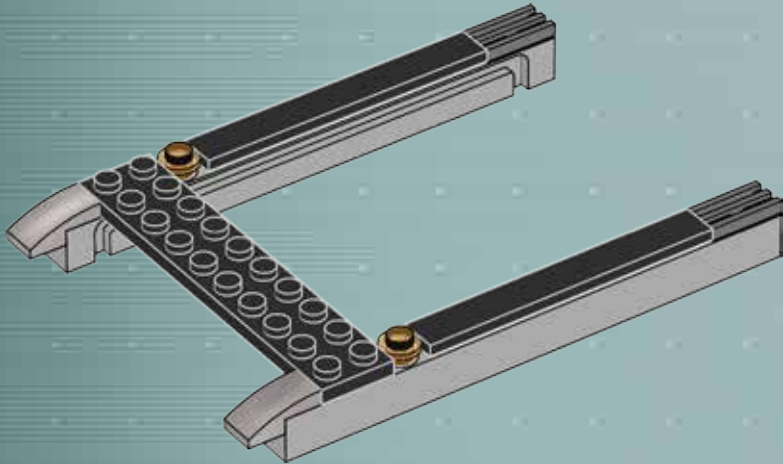

4

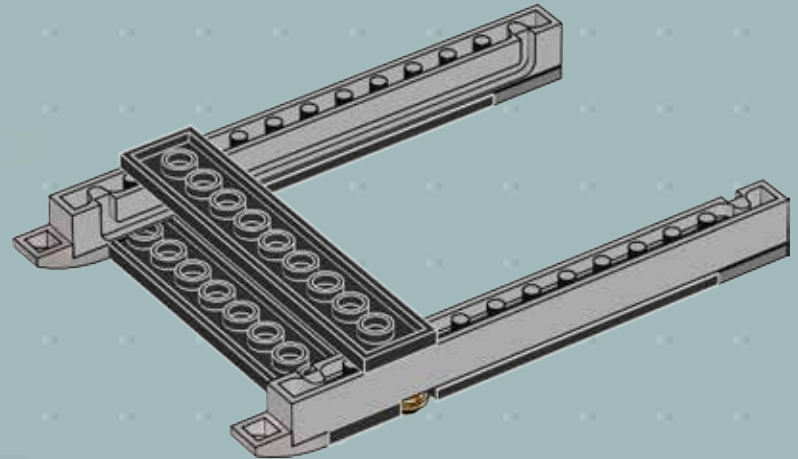



5

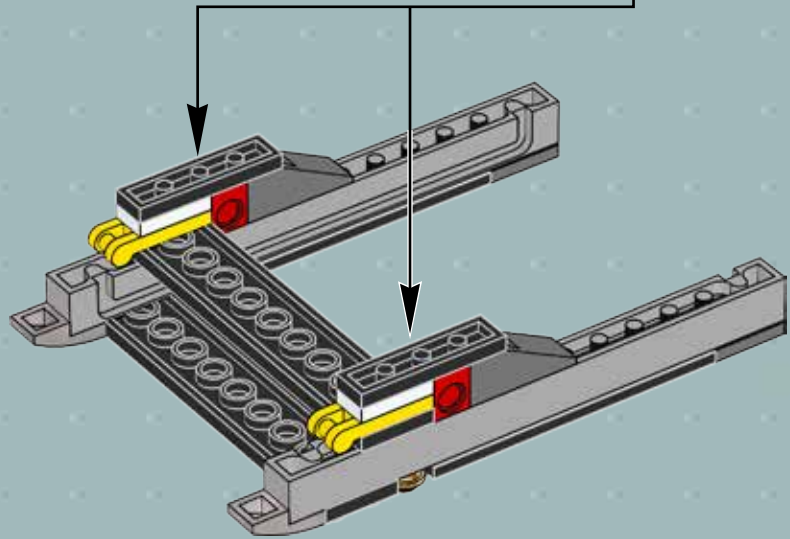
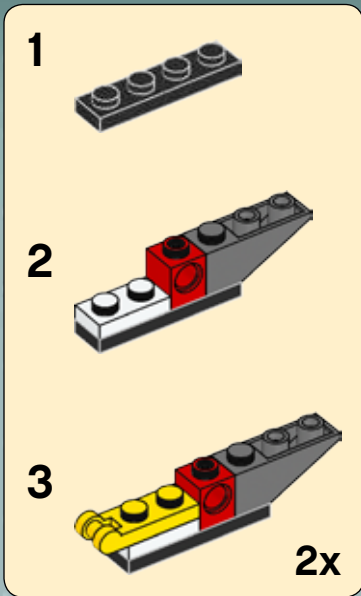

6

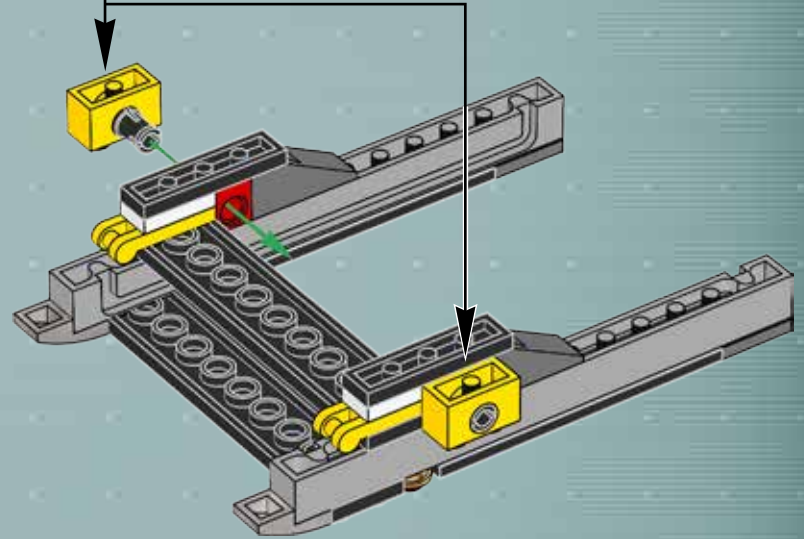
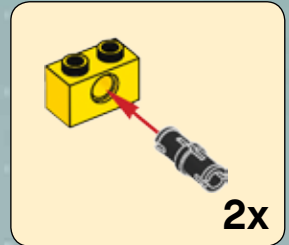

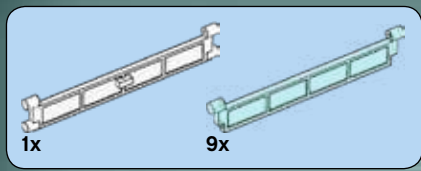

7

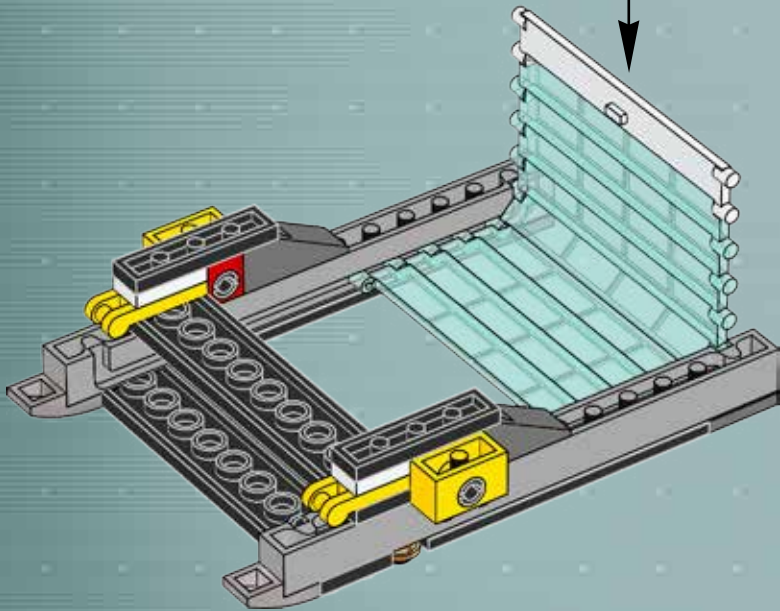
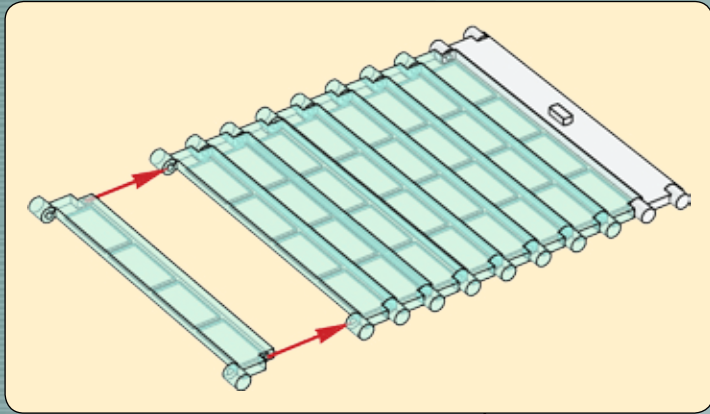

8

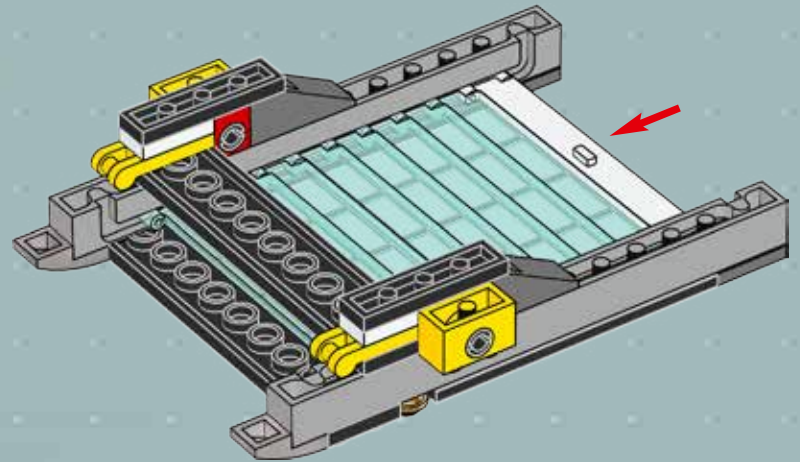

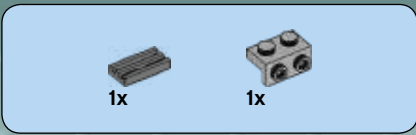

9

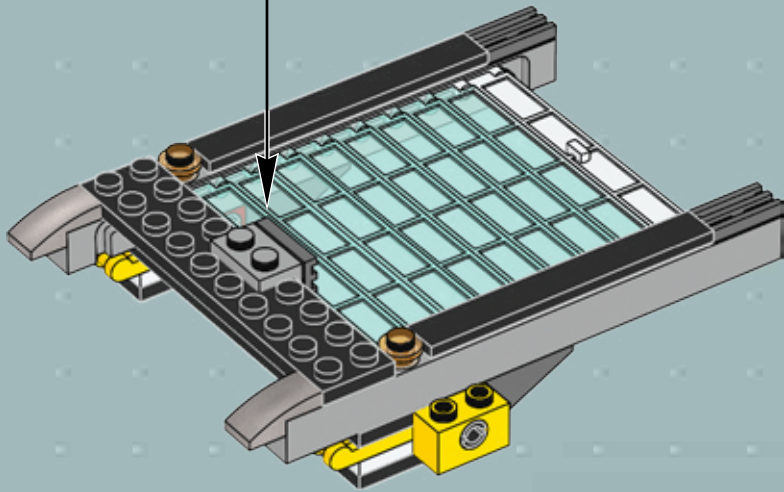
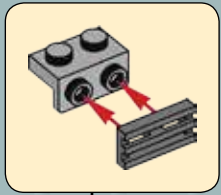

10

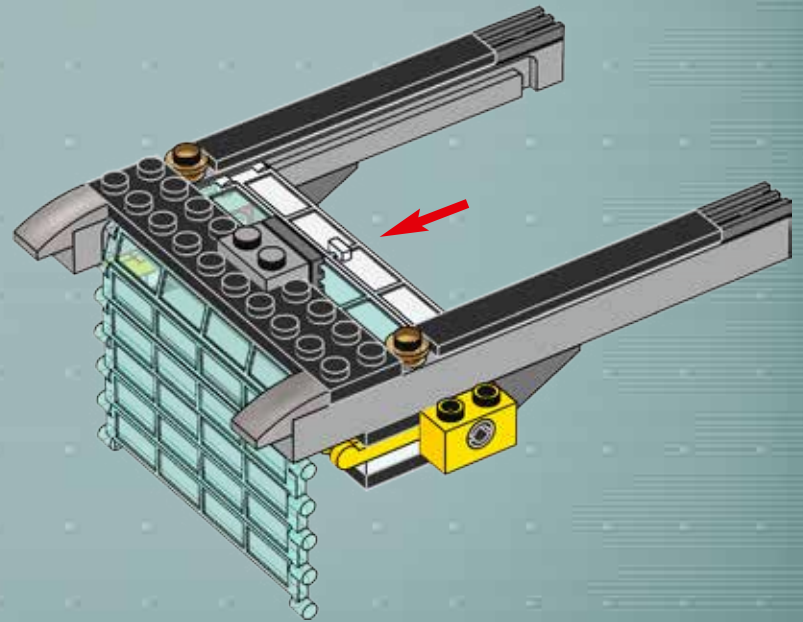

77

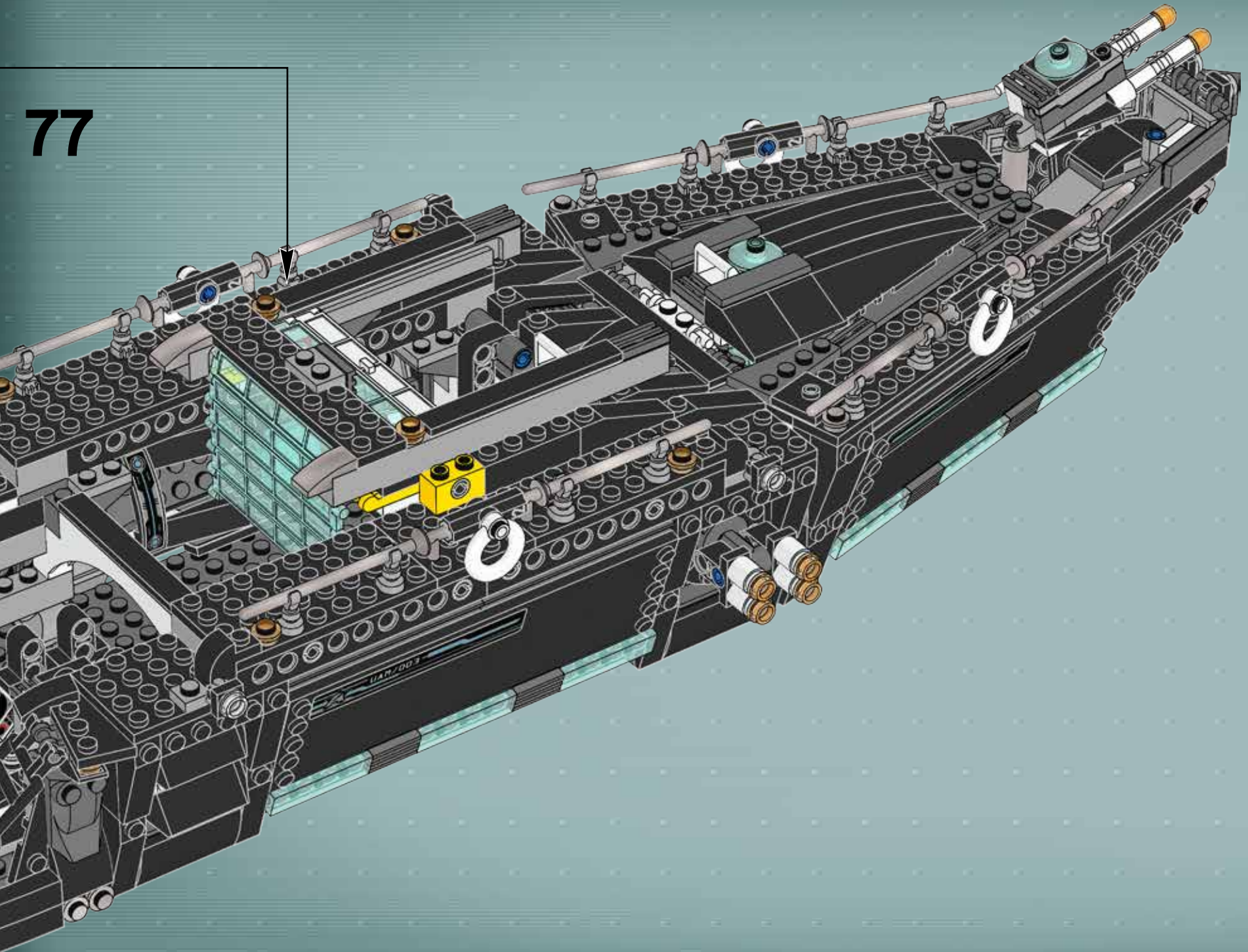

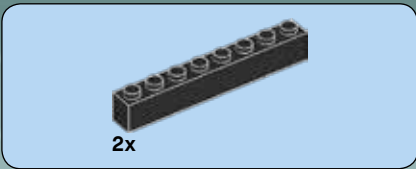

78

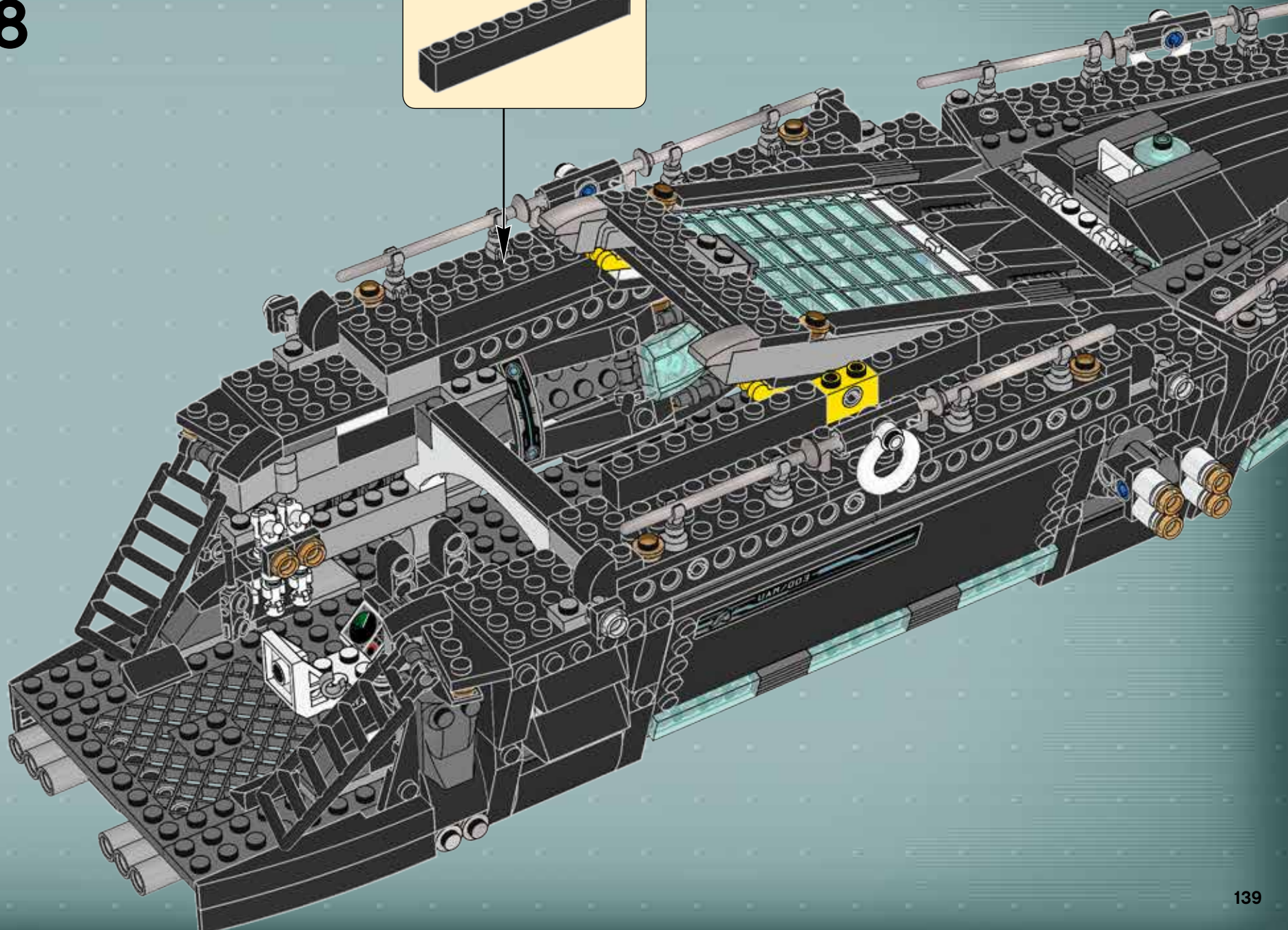
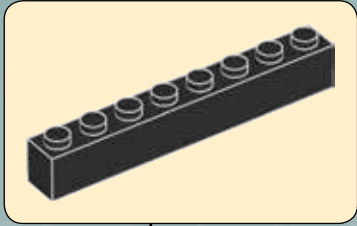

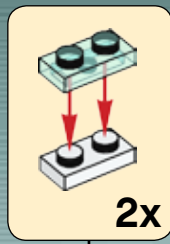
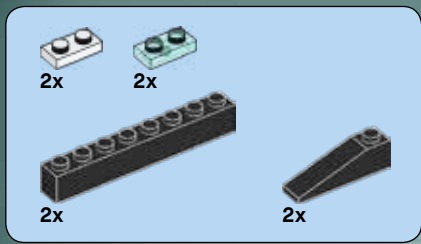

79

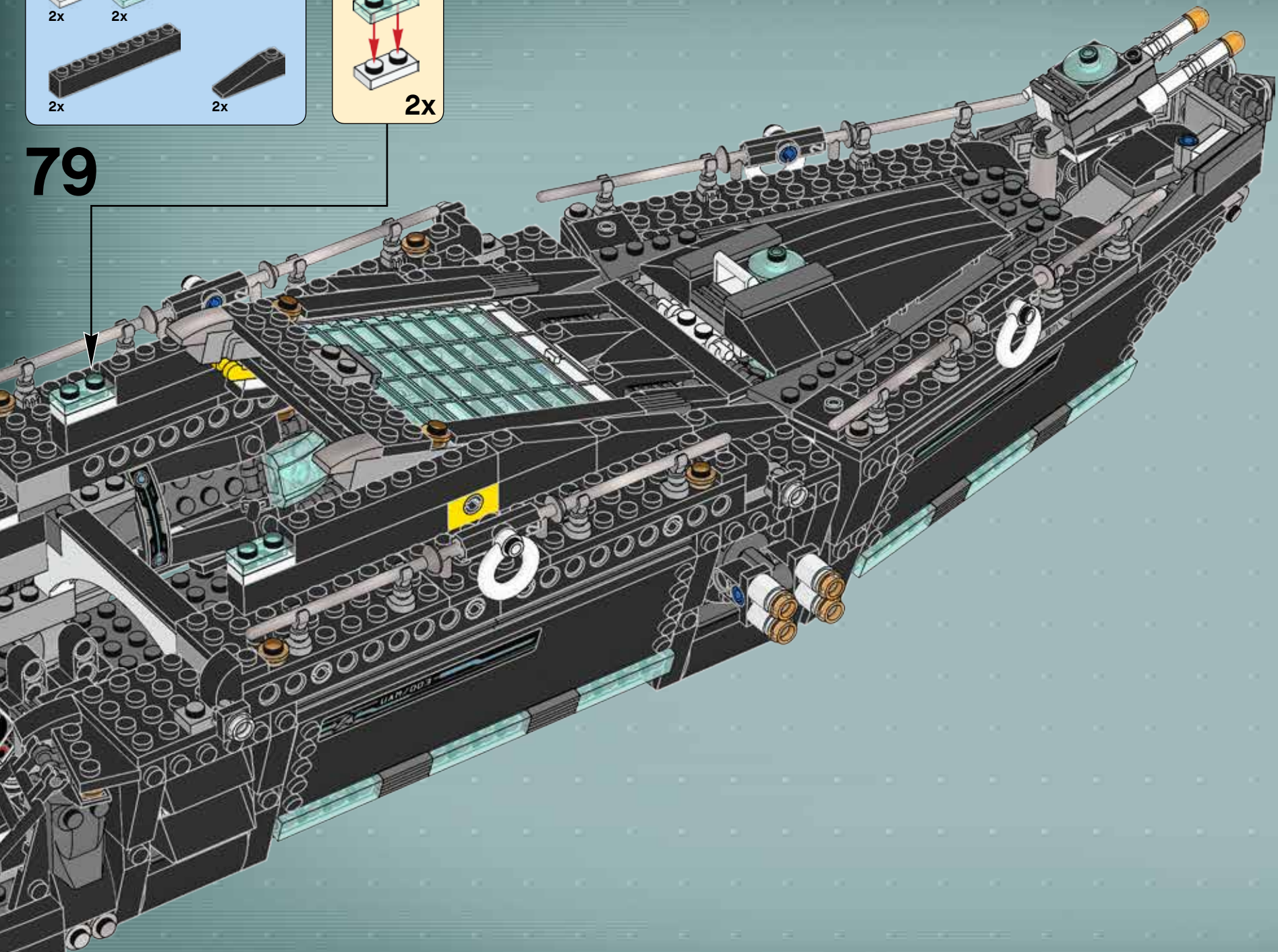

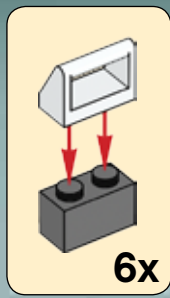
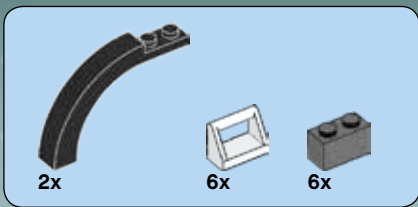

80

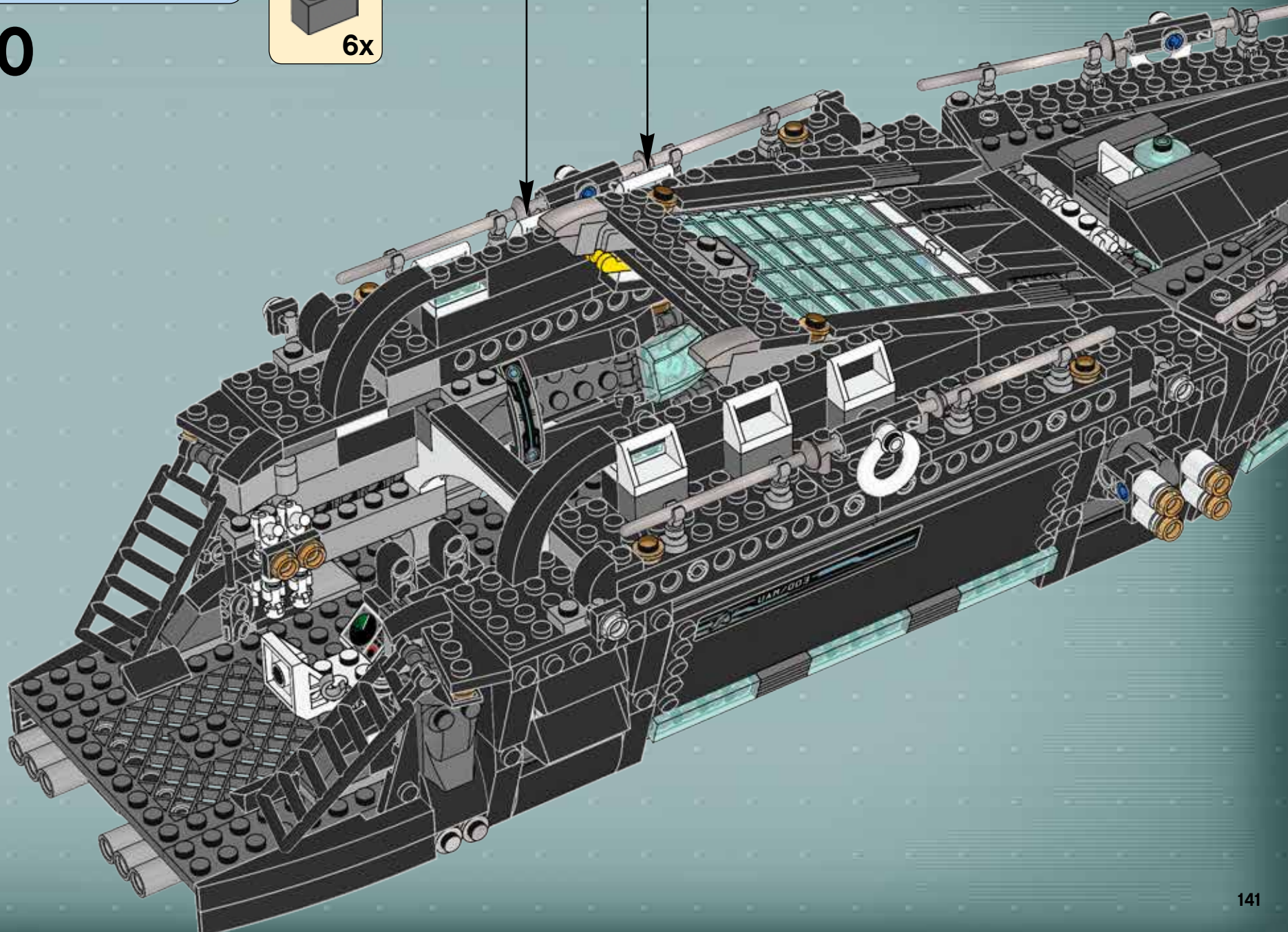

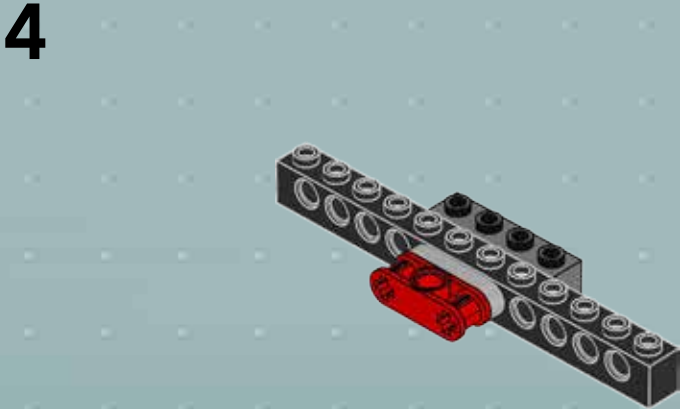
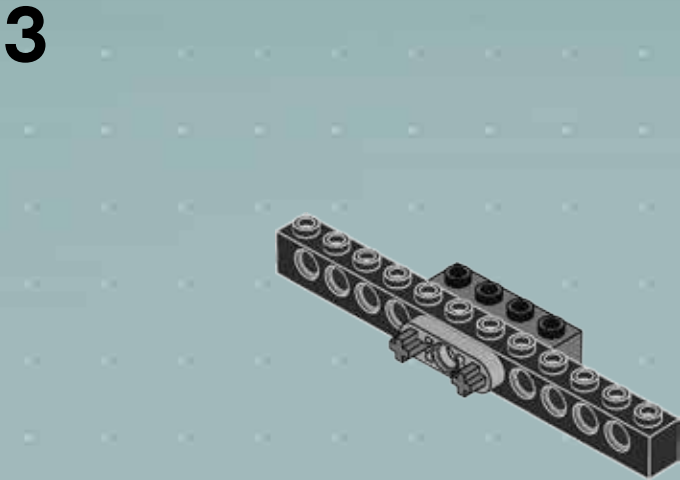
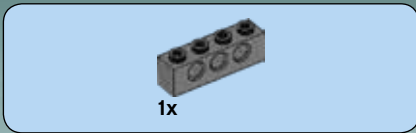
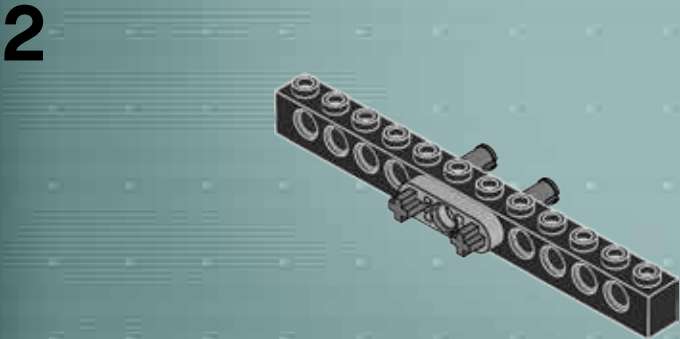
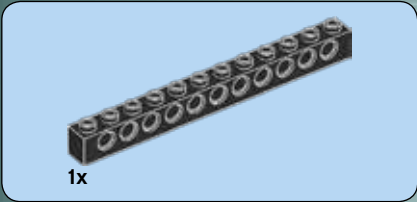
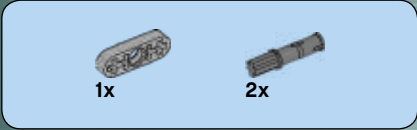
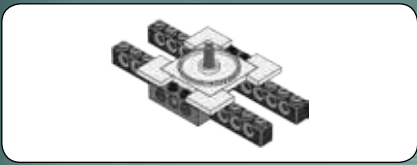

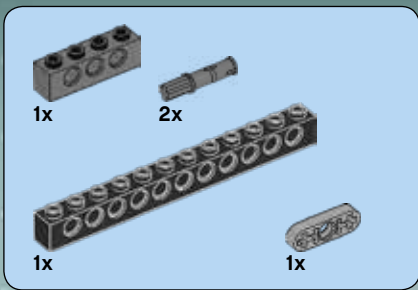

5

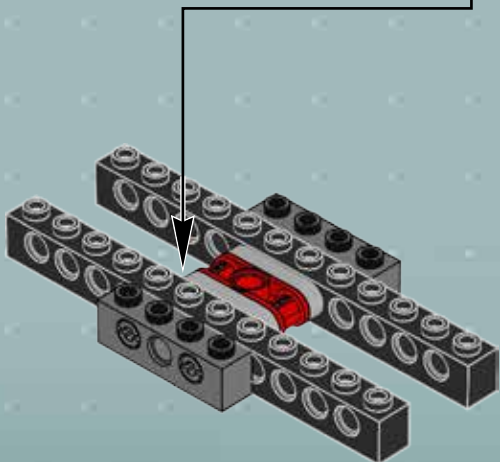
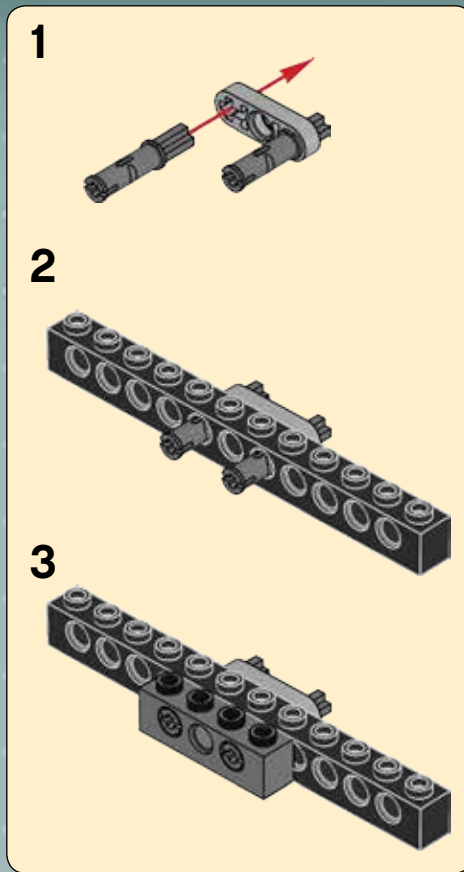

6

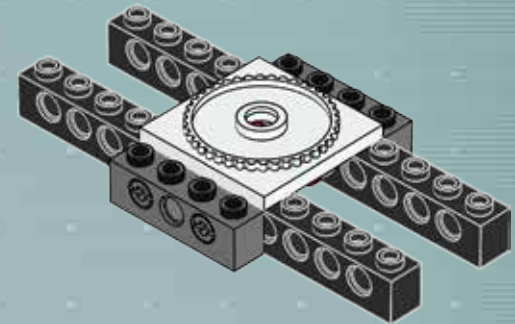

7

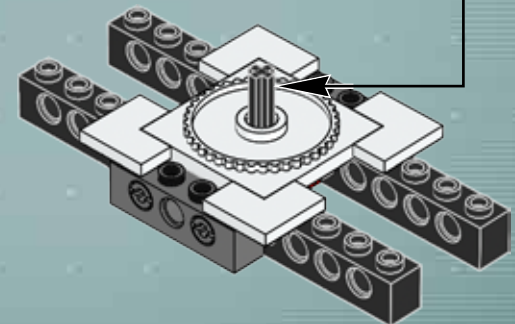
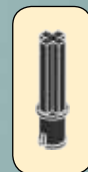

81

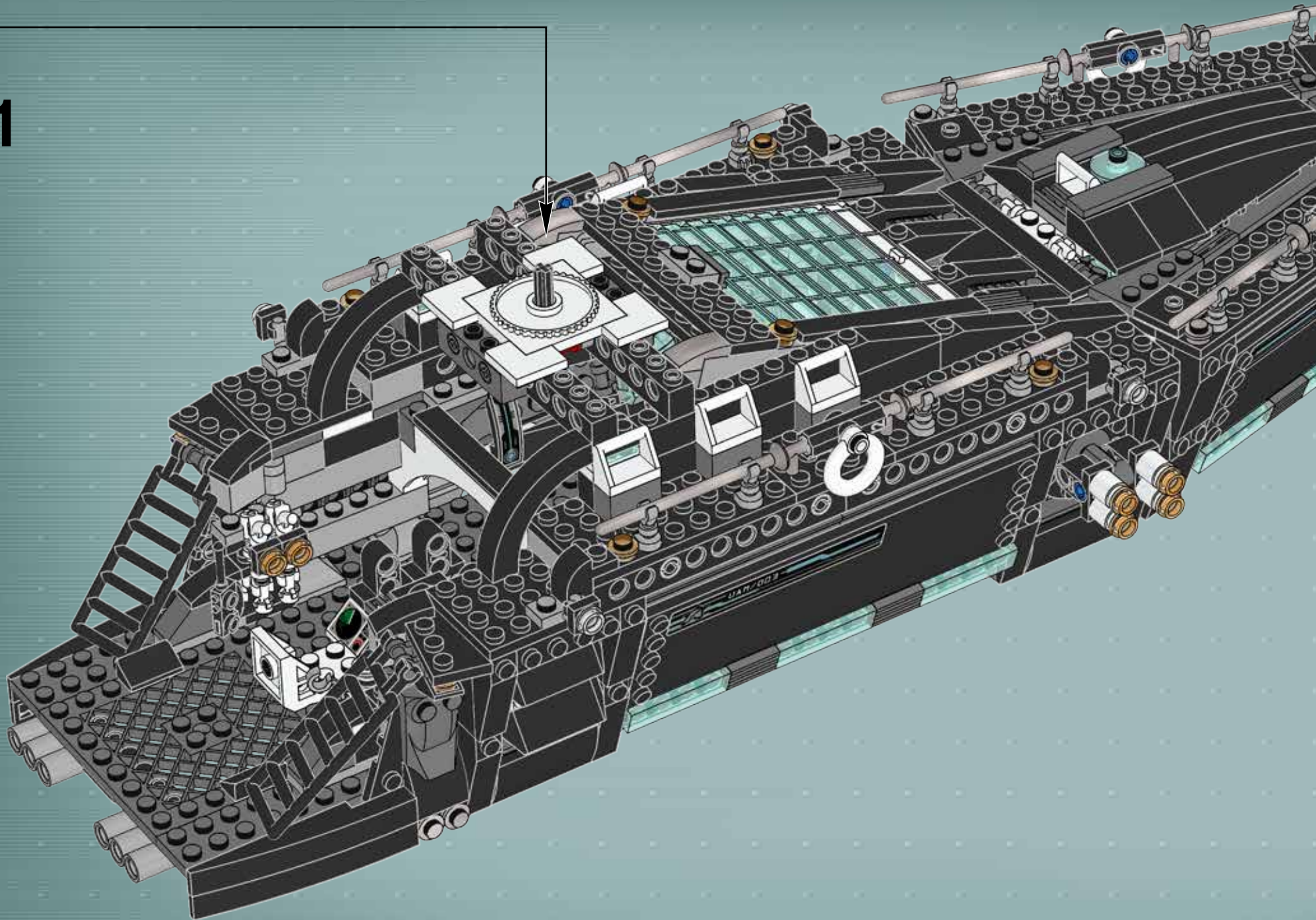



82

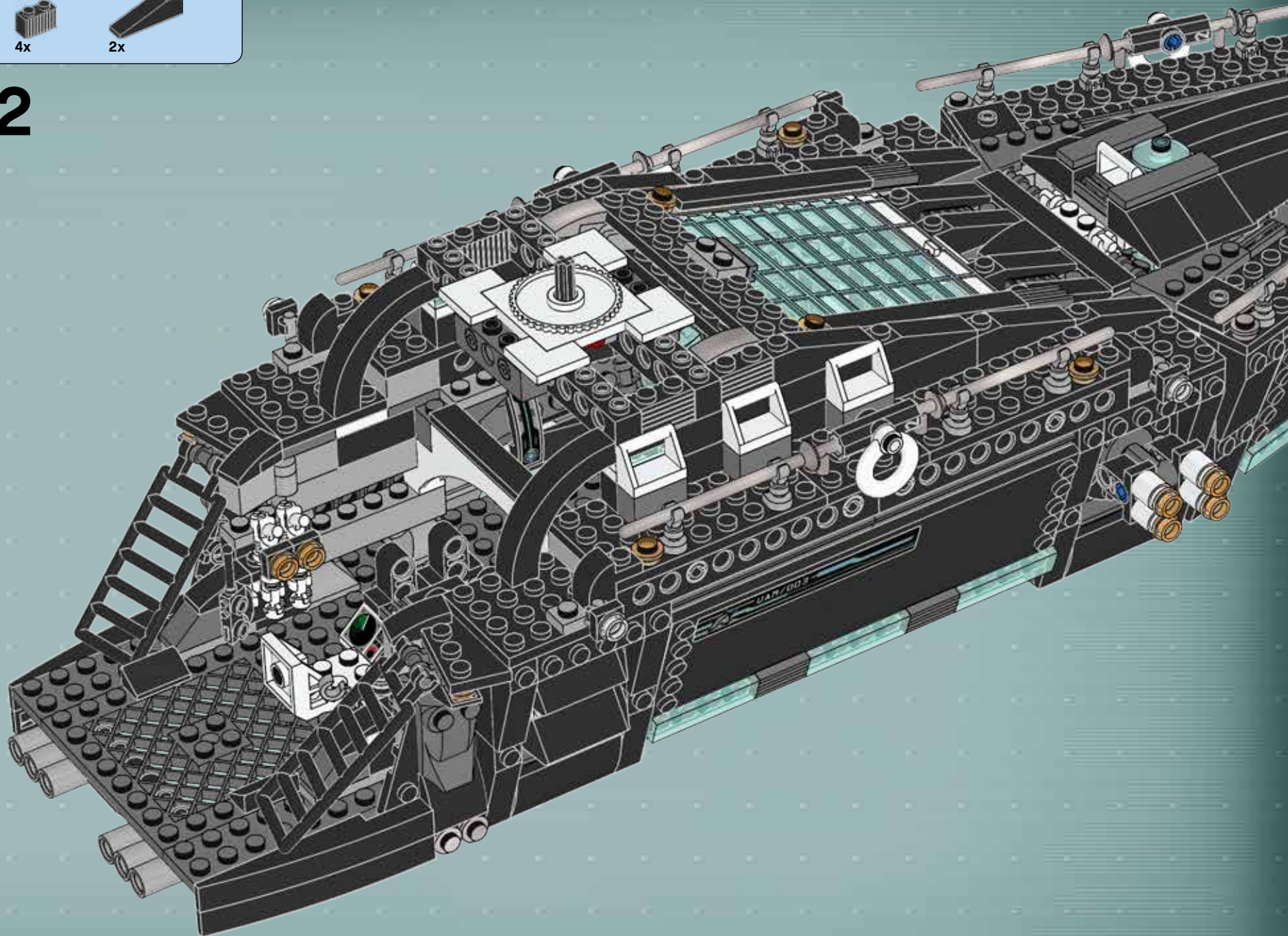

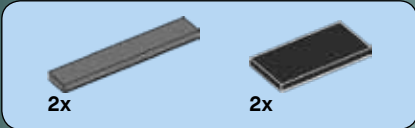

83

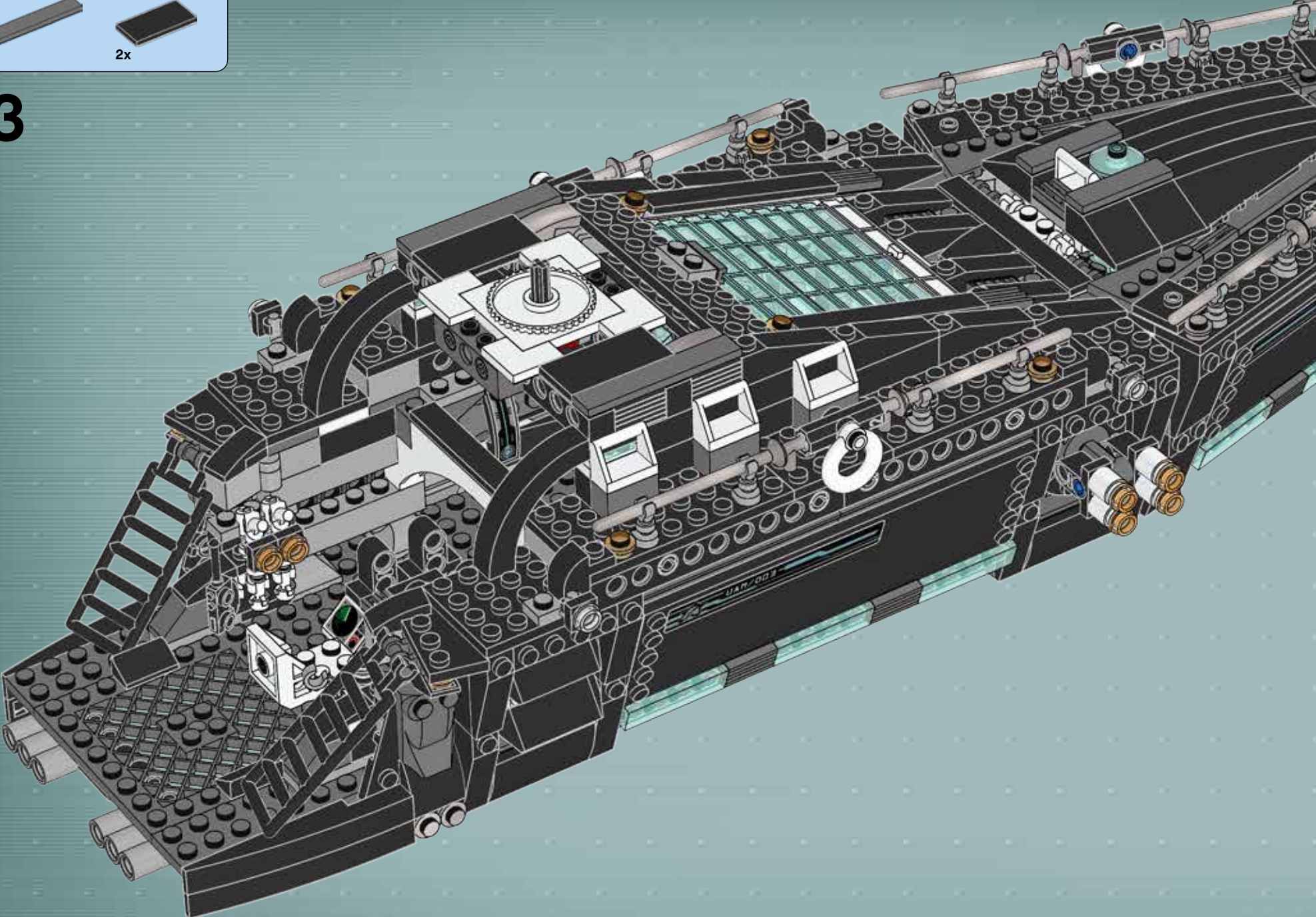

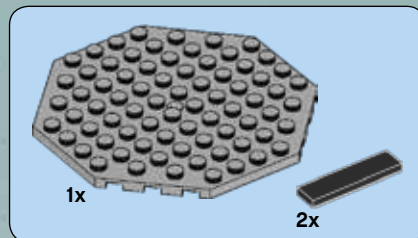
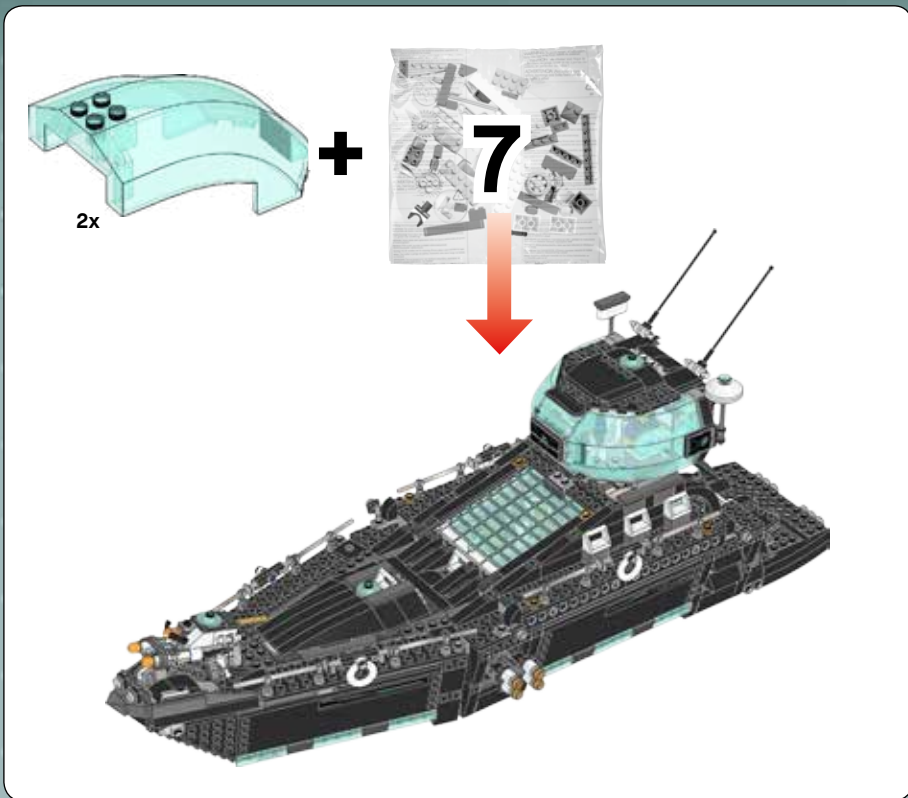

1

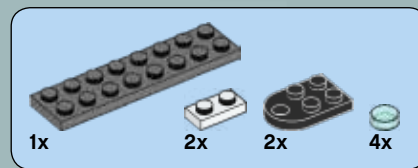
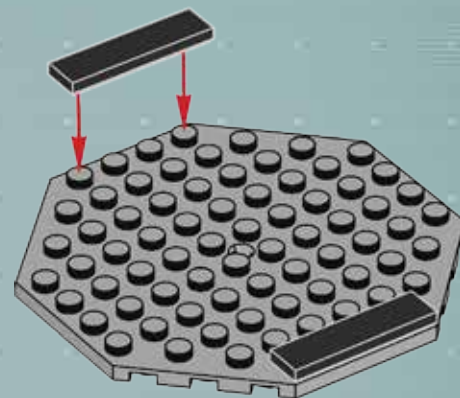

2

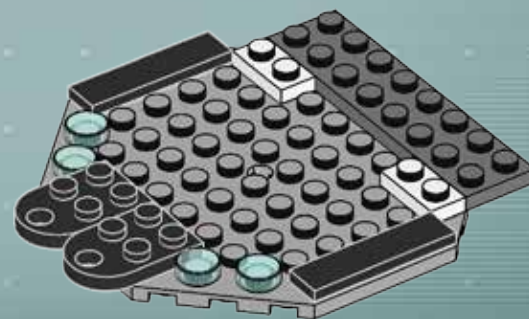

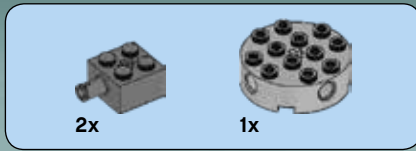
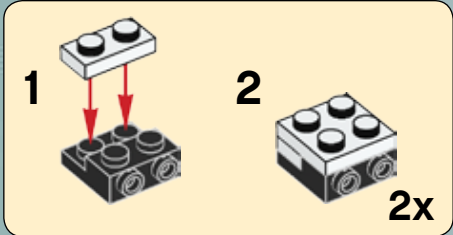
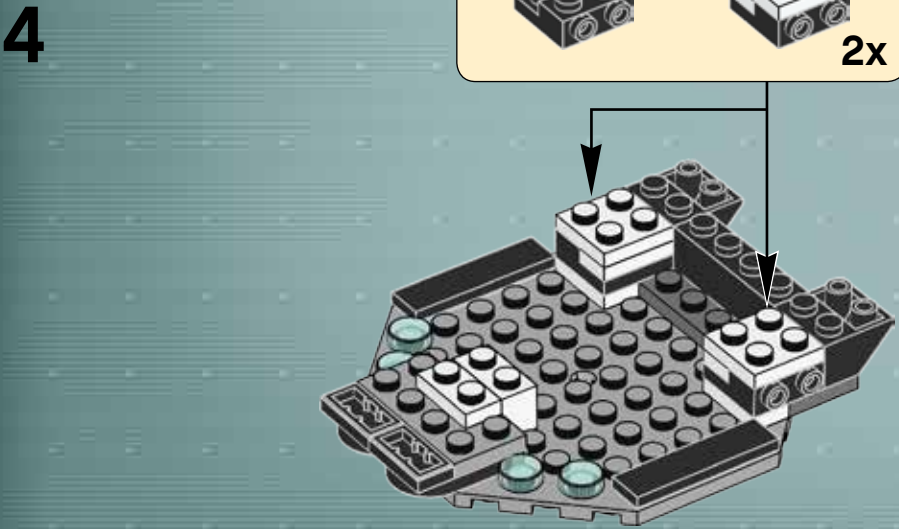
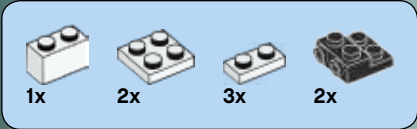
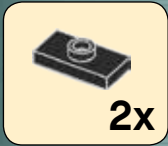
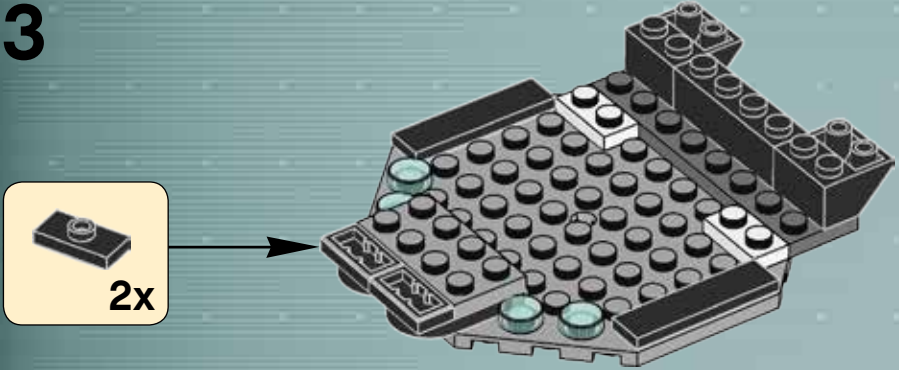
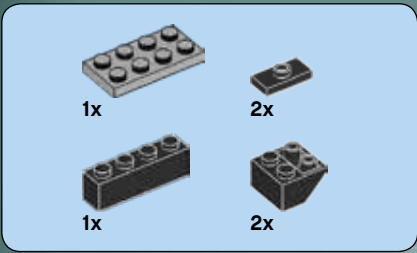

5

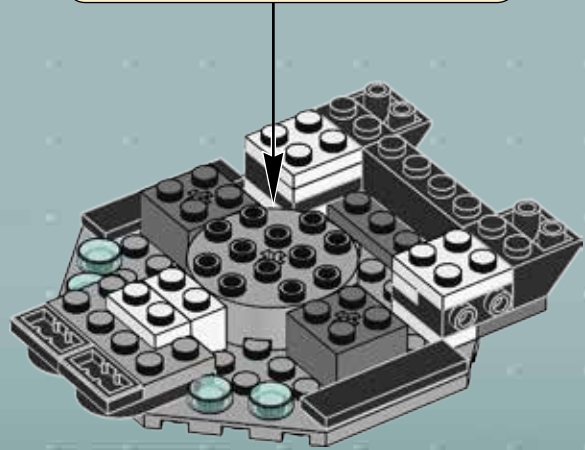
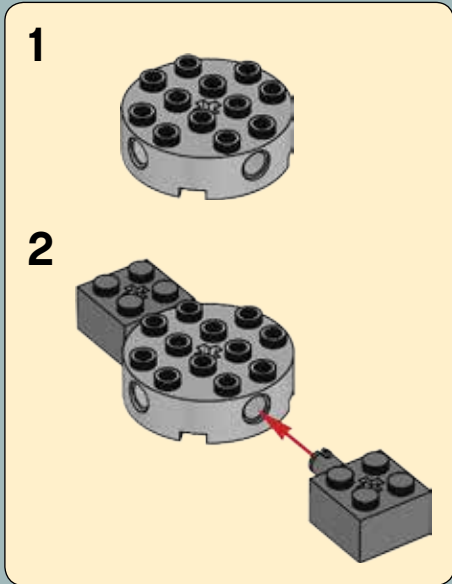

84

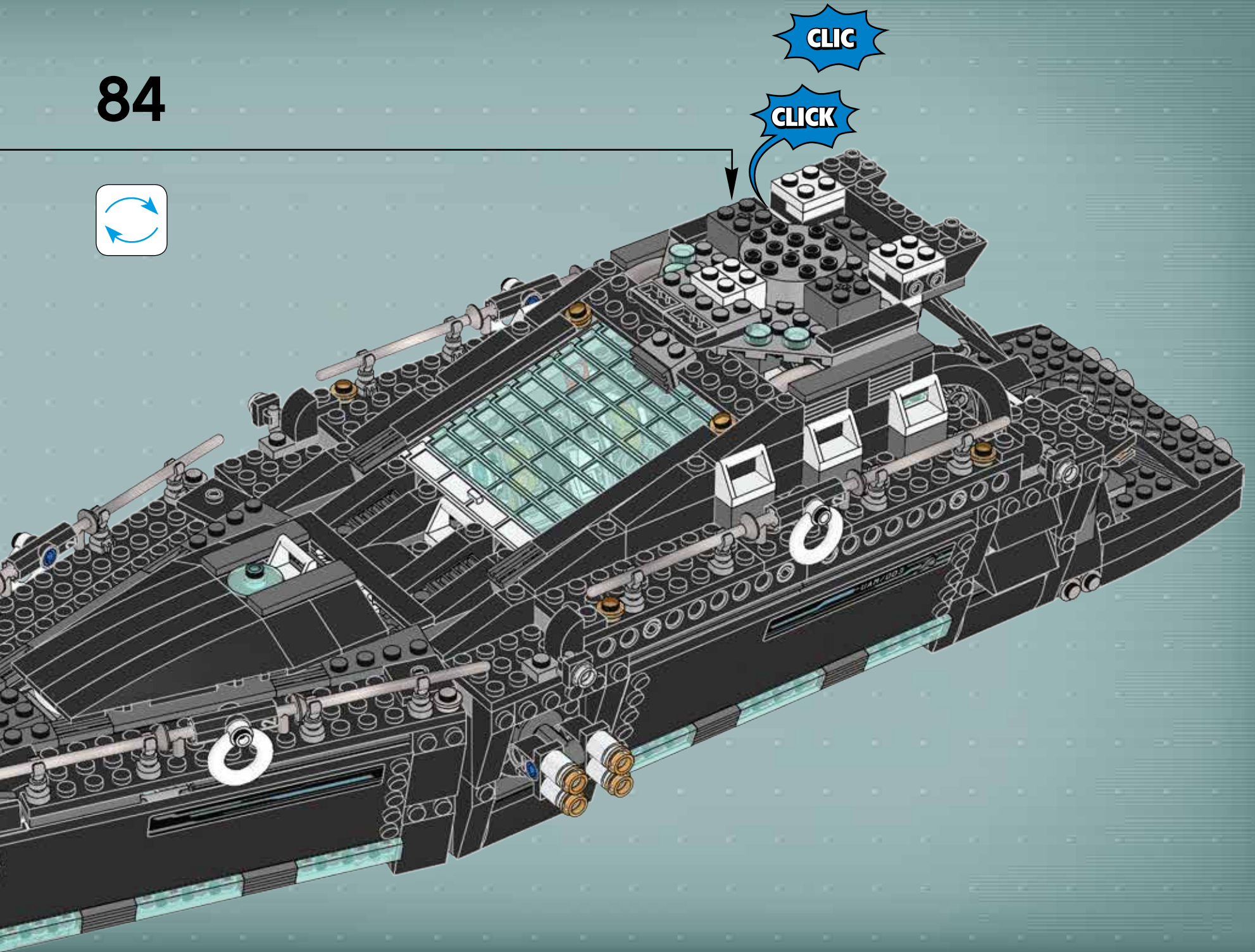

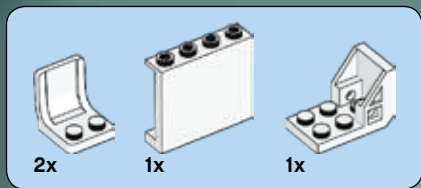

85

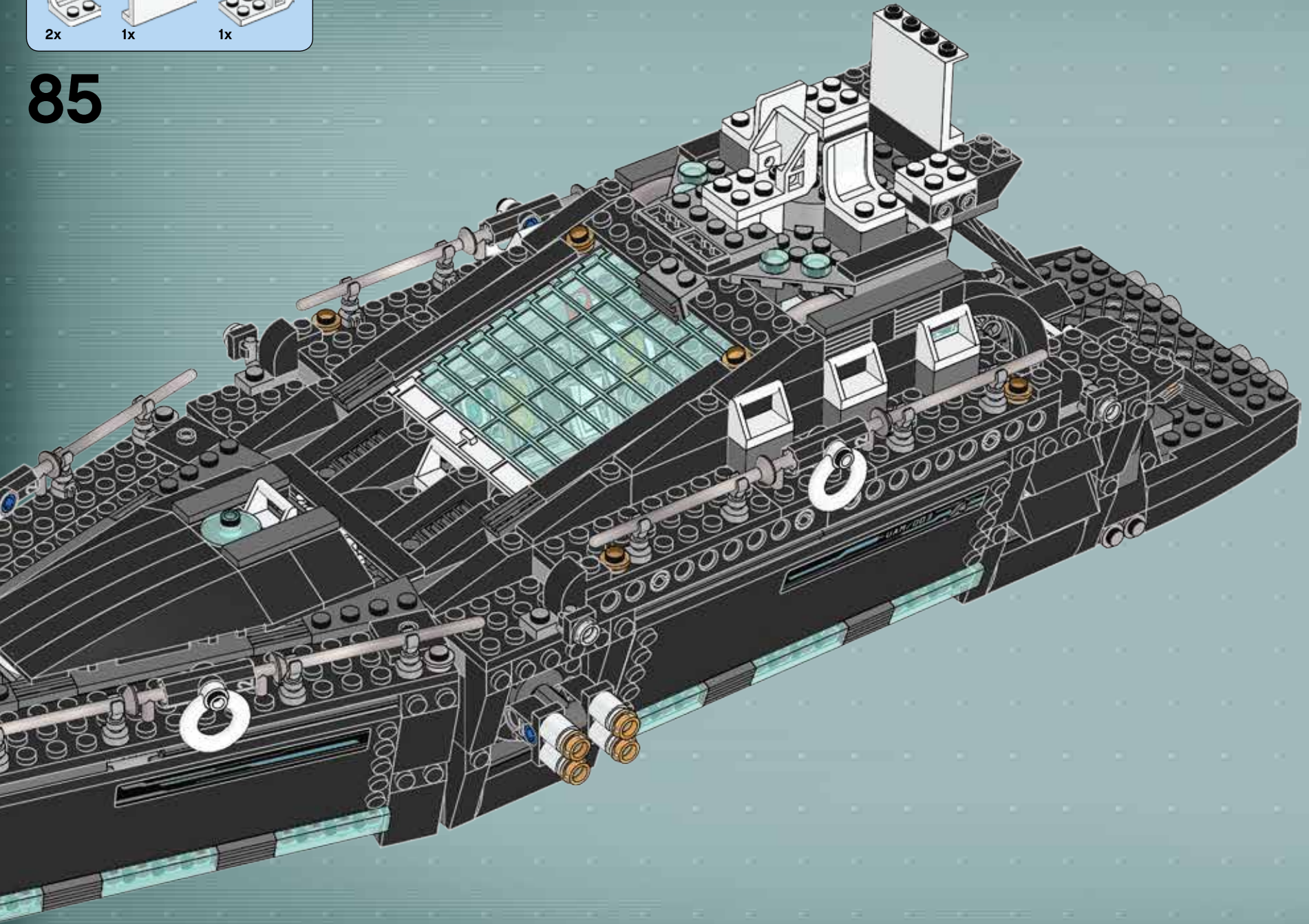

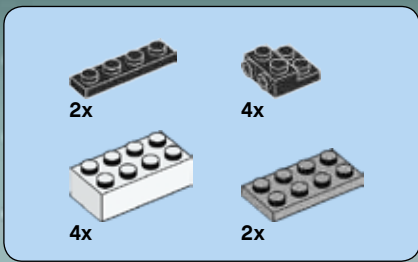

86

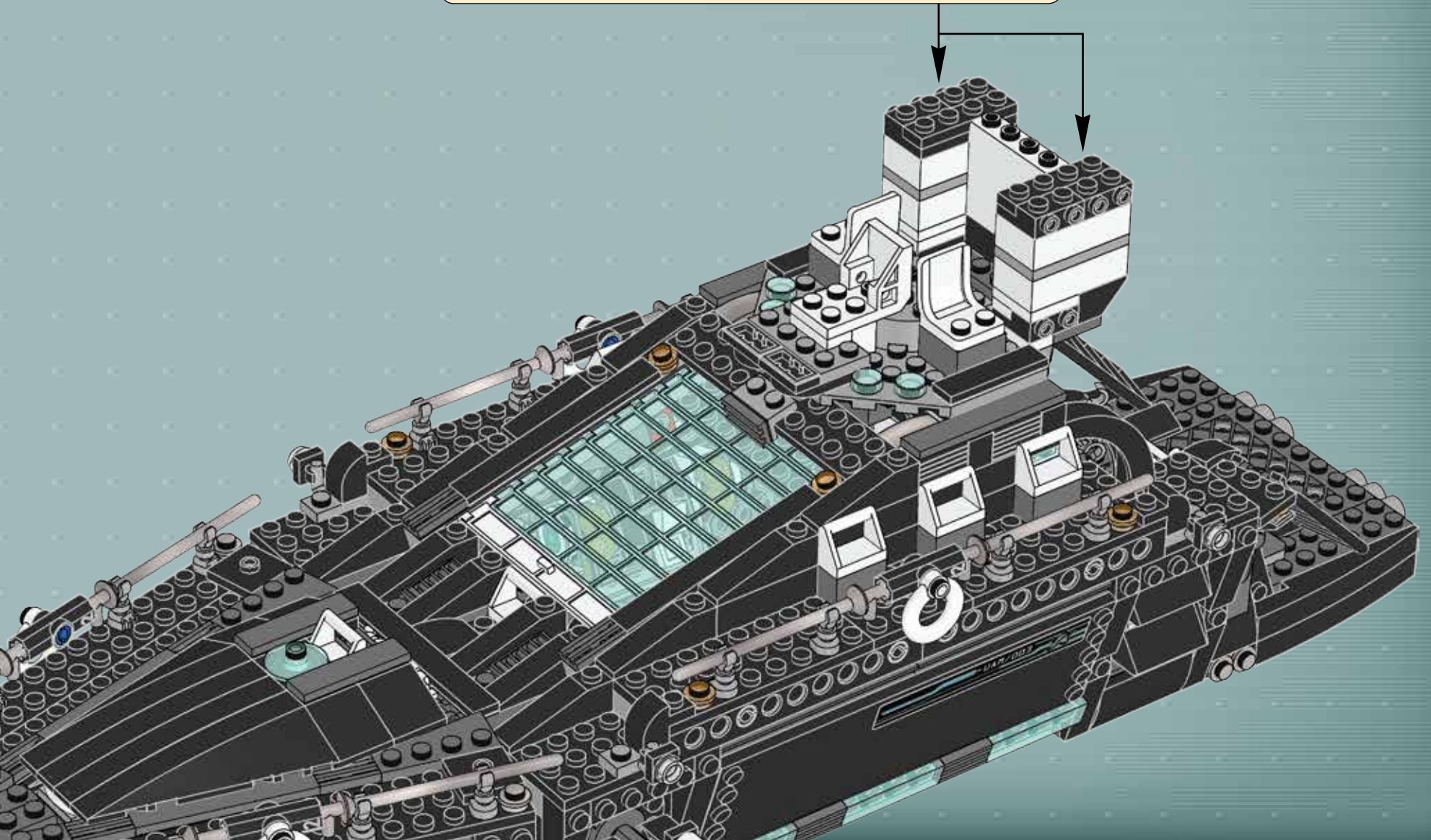
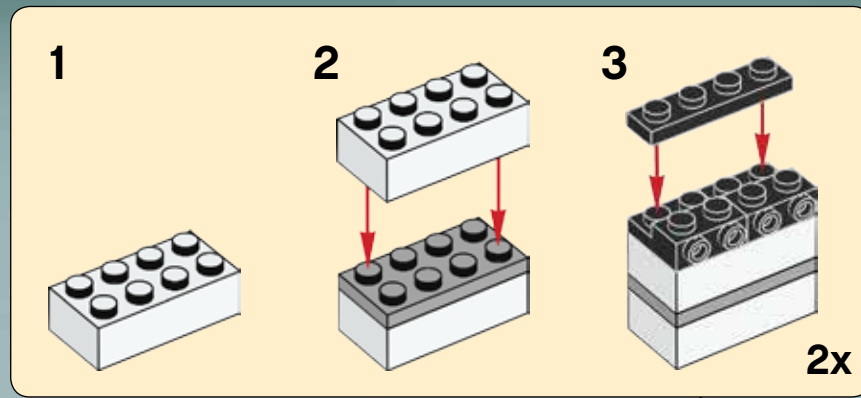

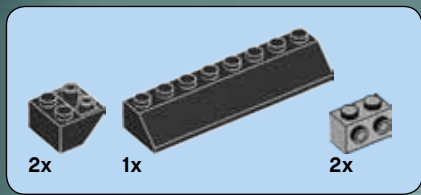

87

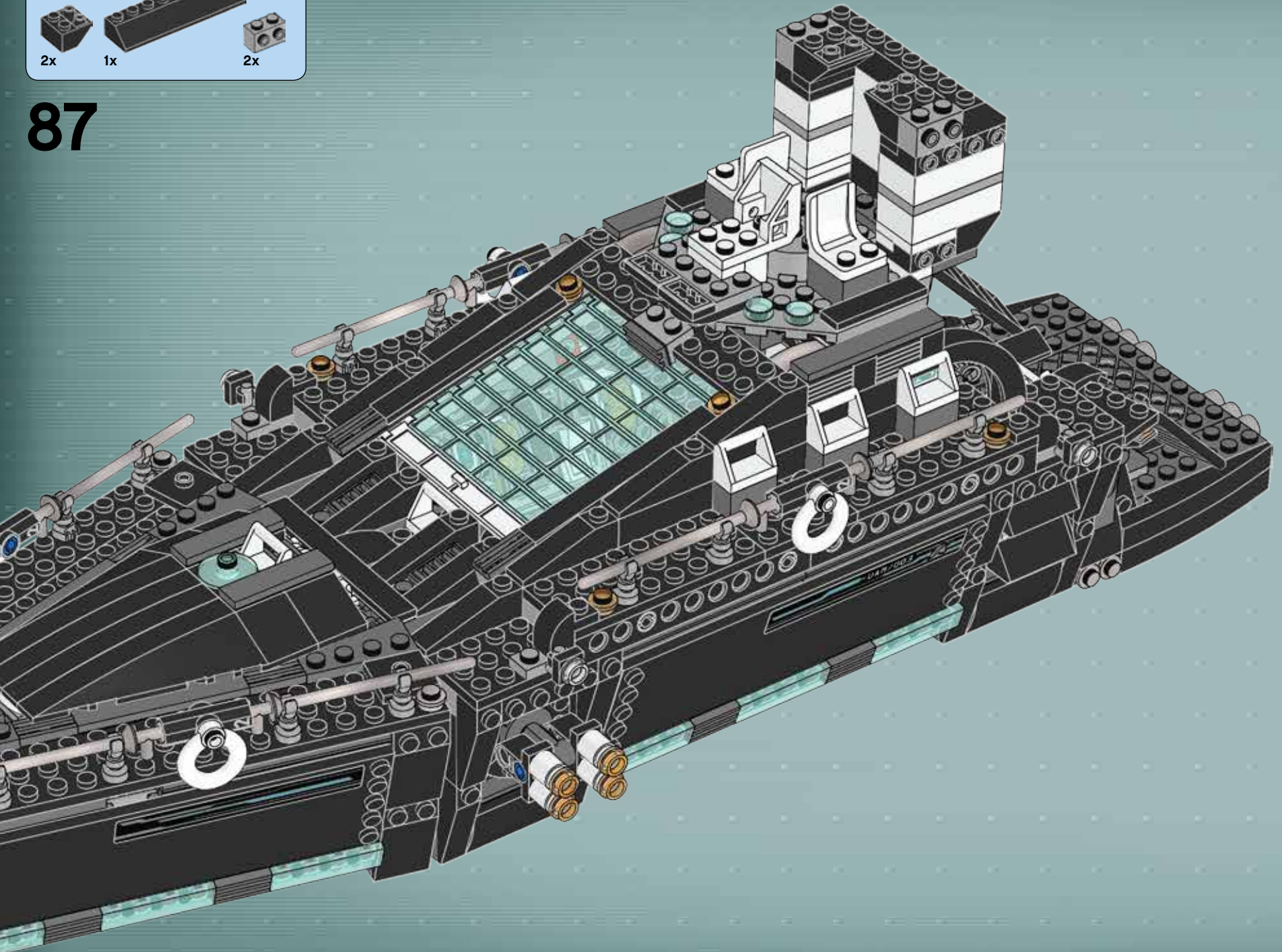

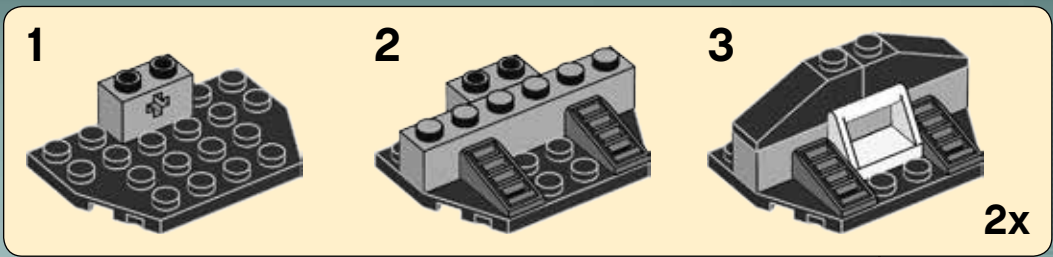
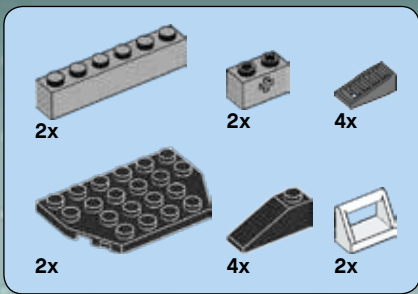

88

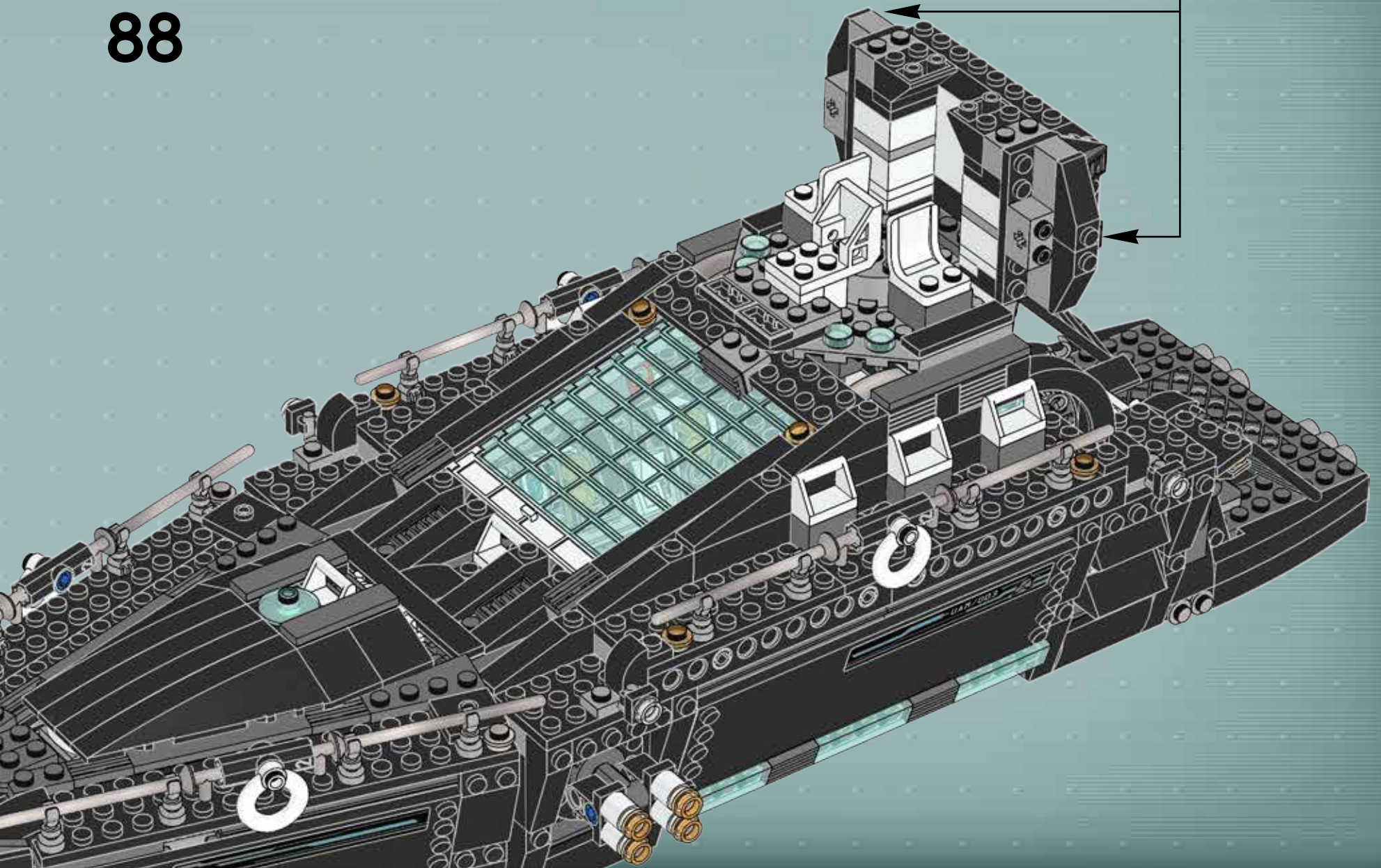



2x

89

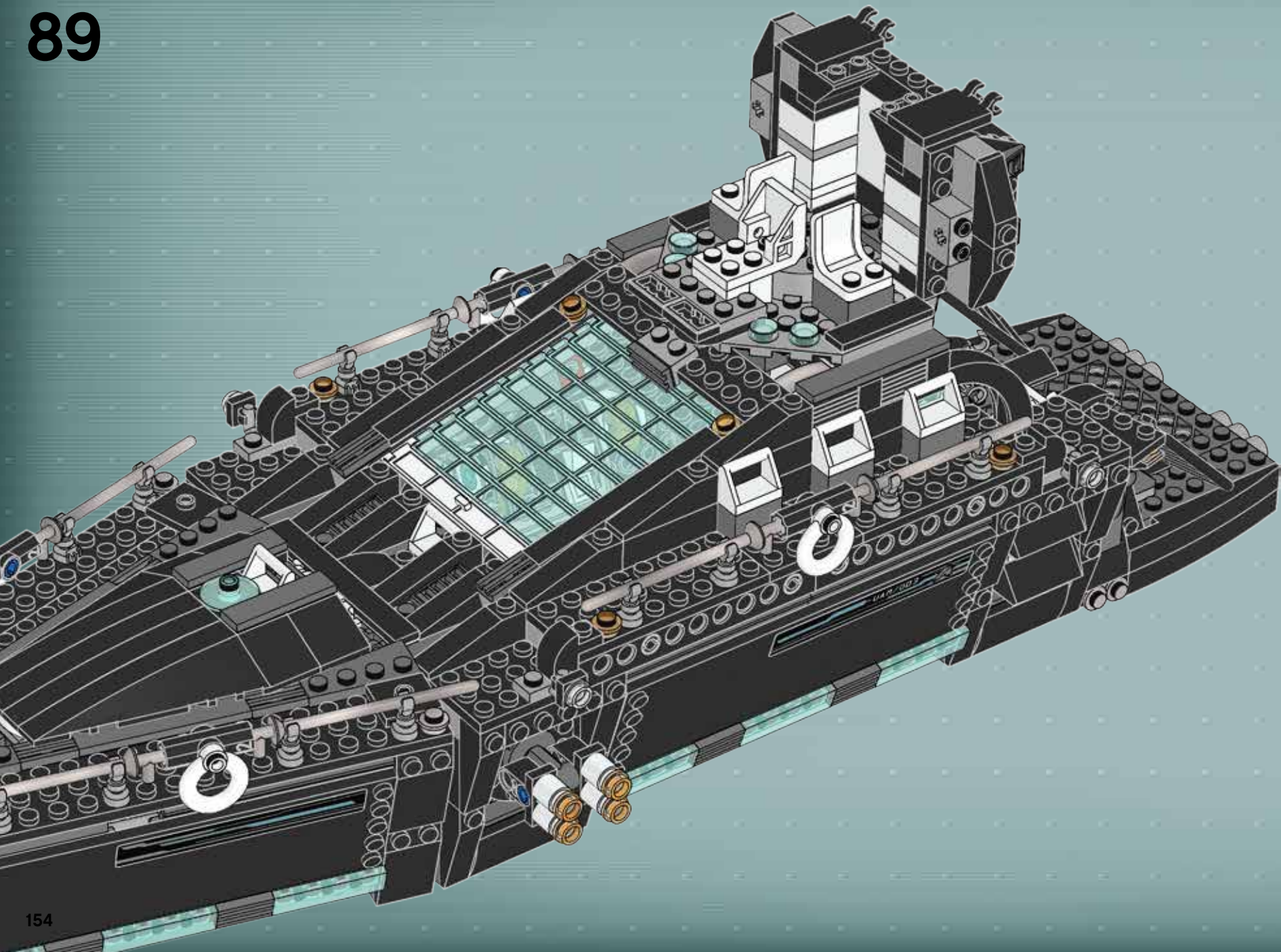

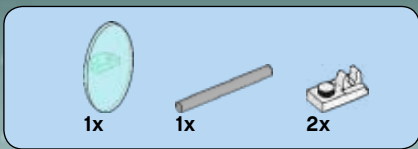

90

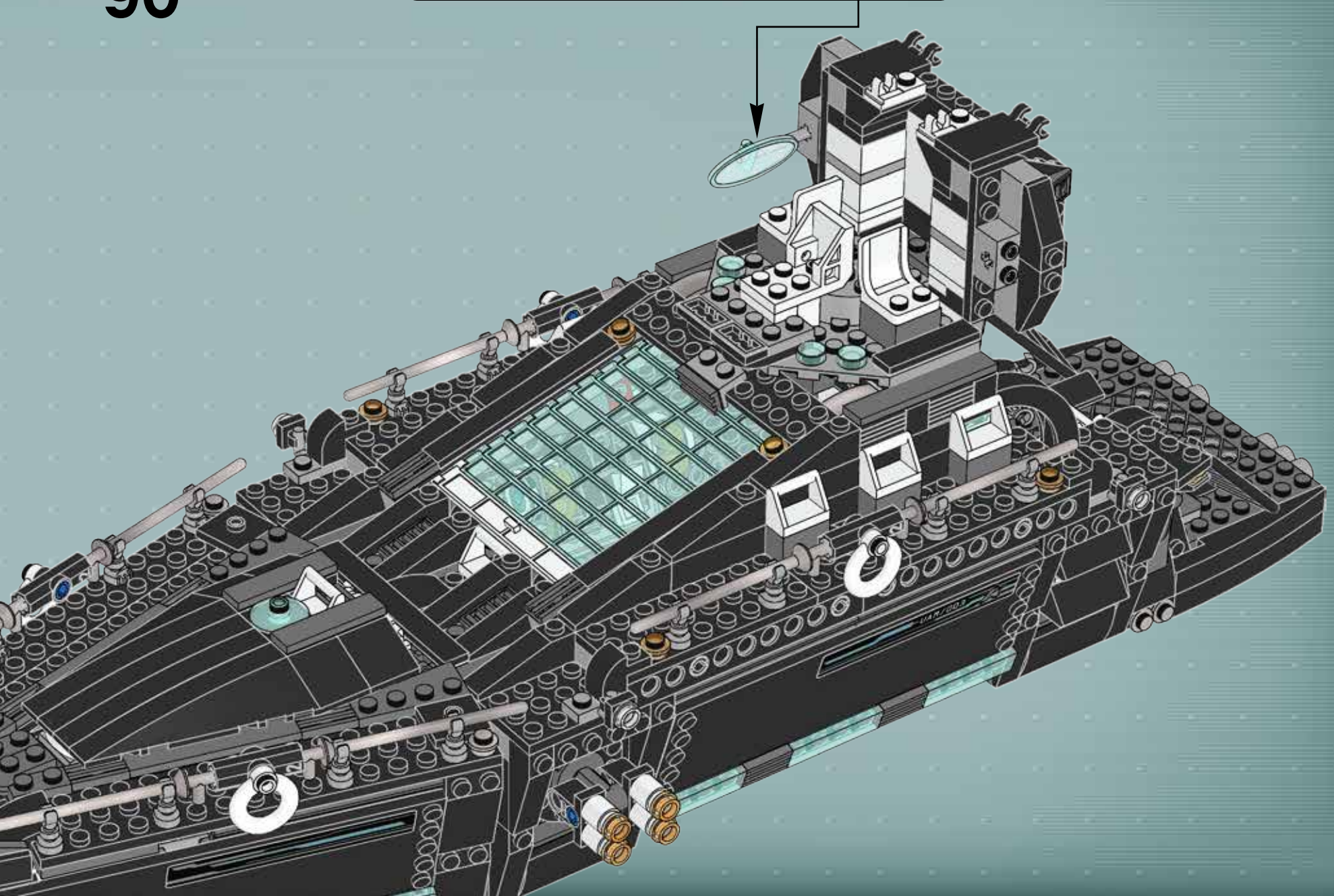
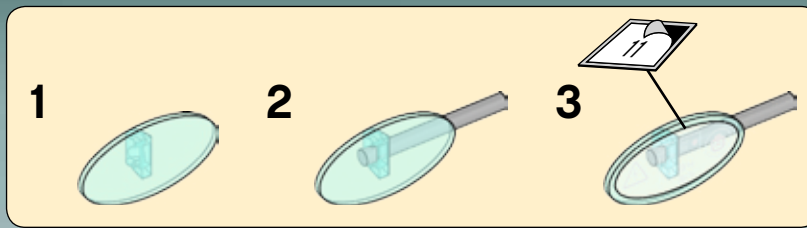

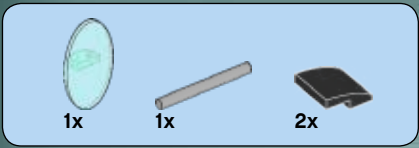

91

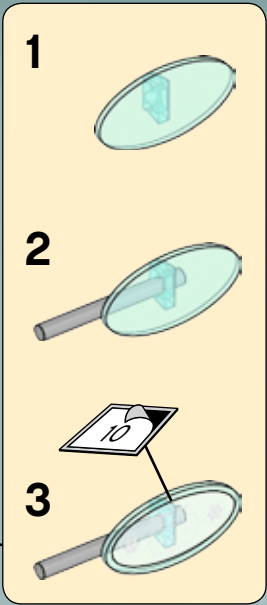
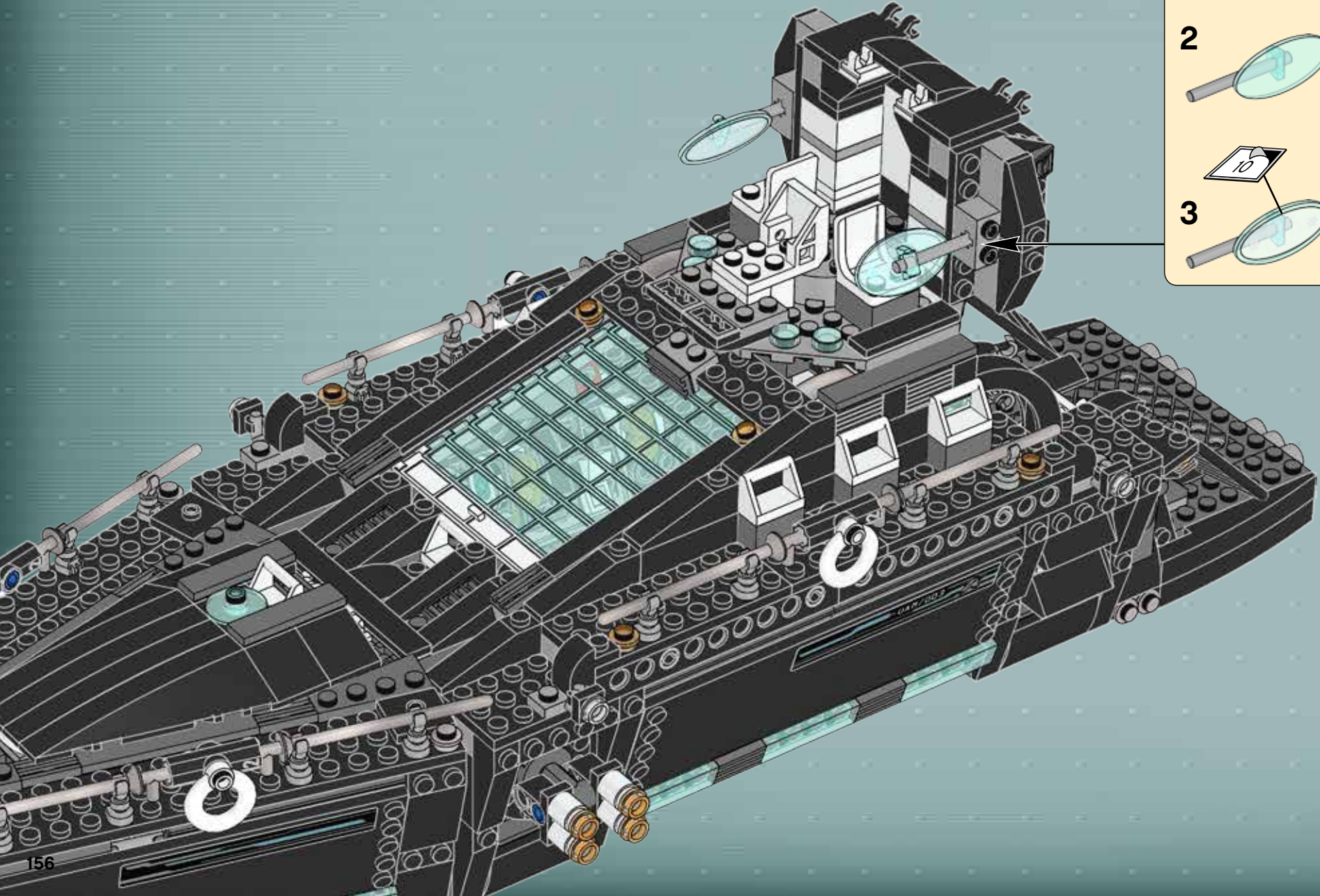

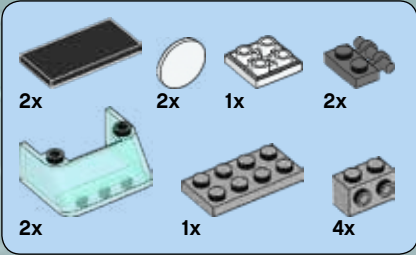

92

1



2

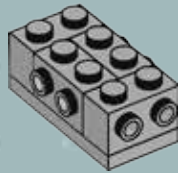

3

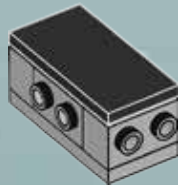

4

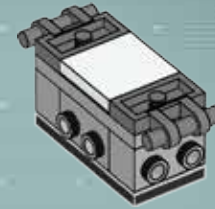

5

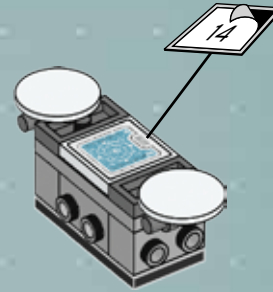

6

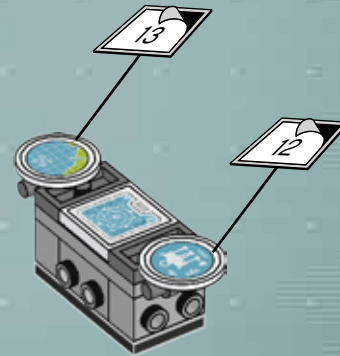

7



8

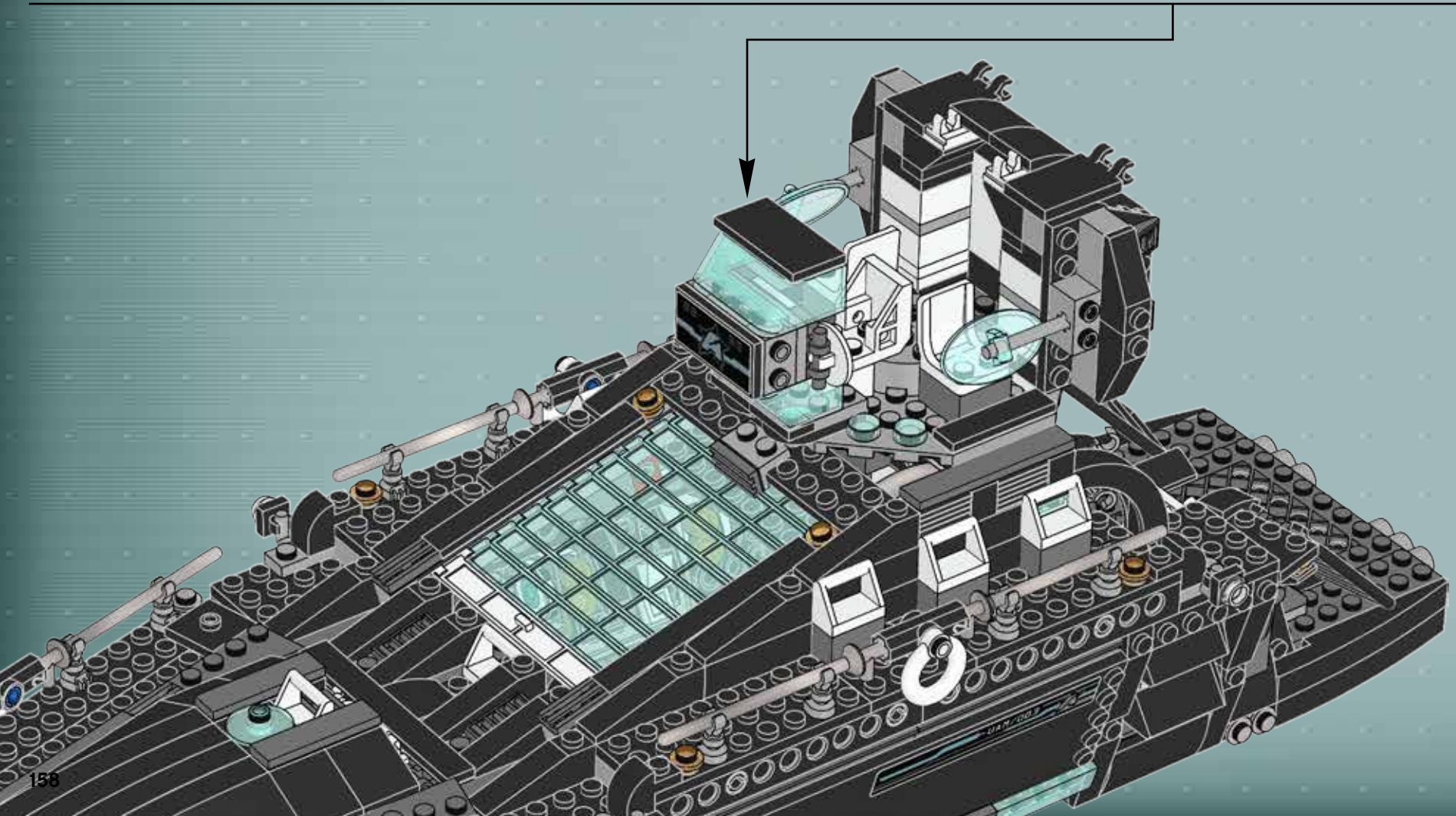
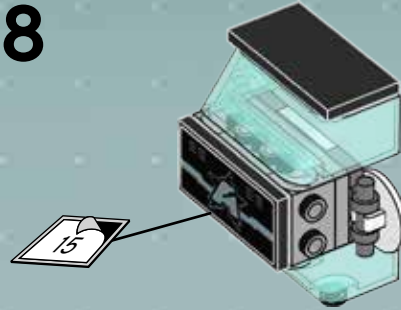

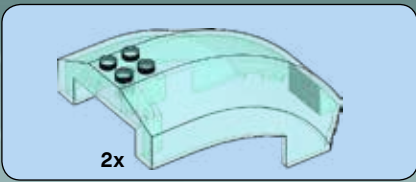

93

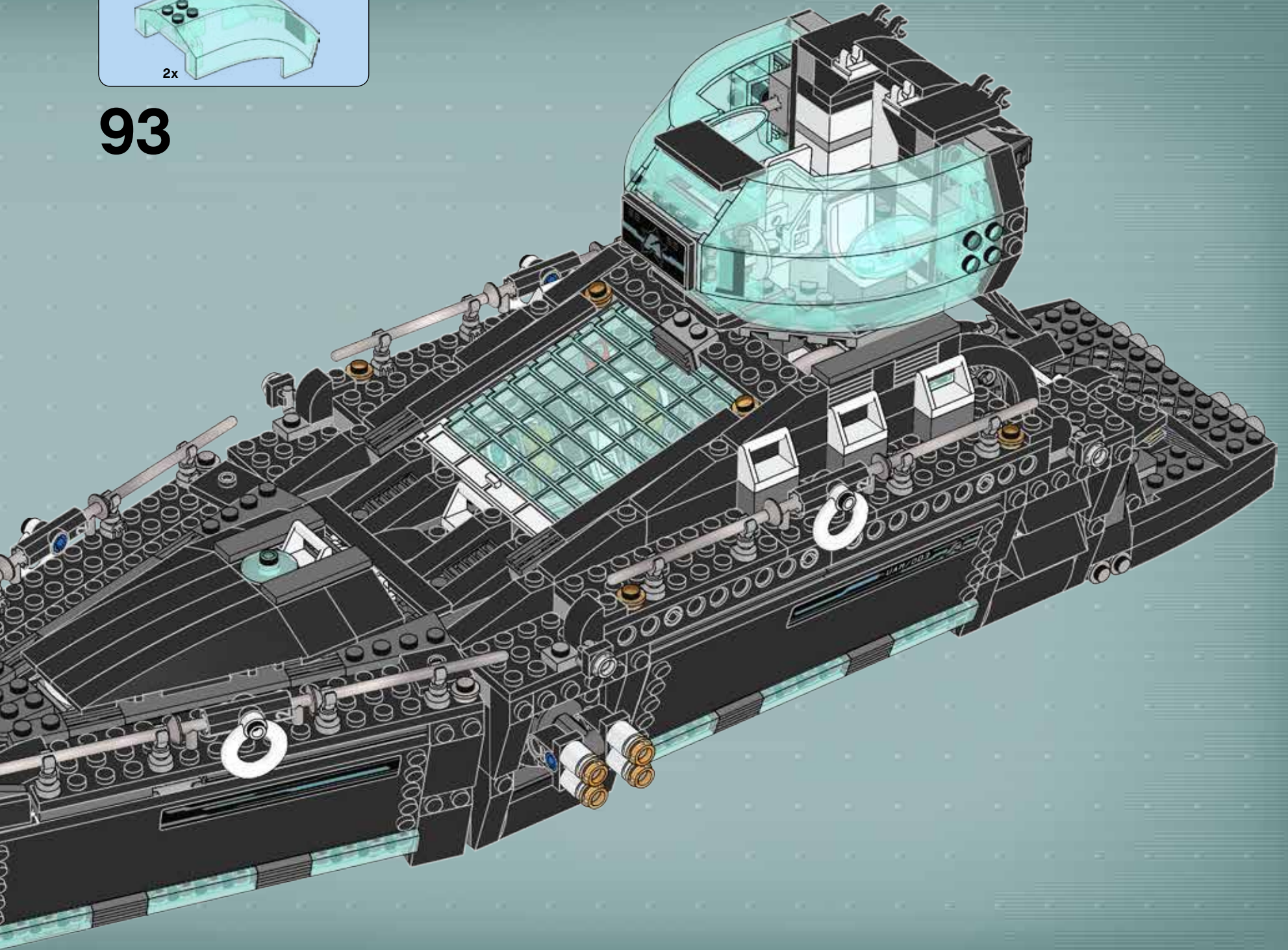

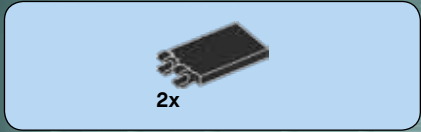

94

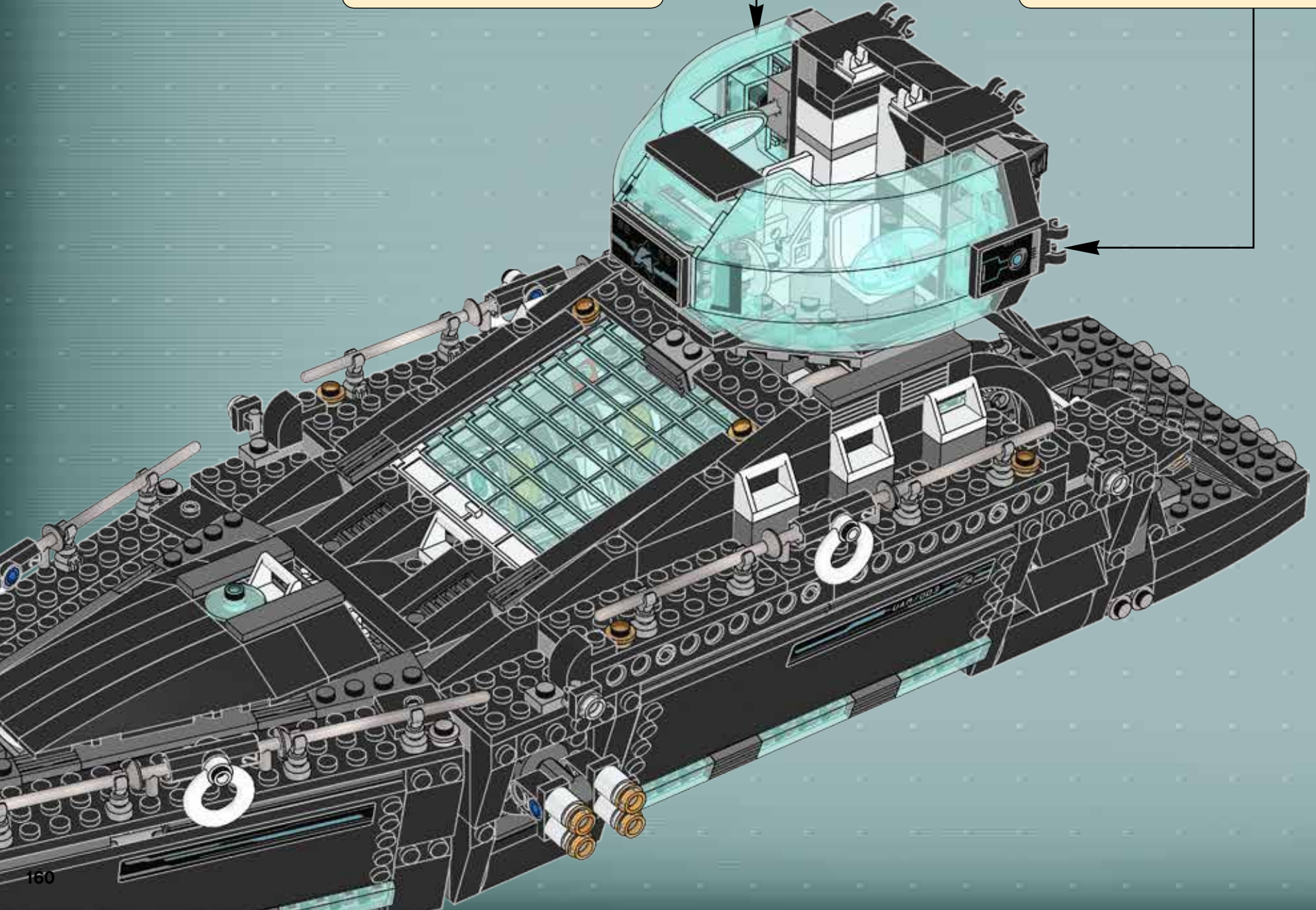
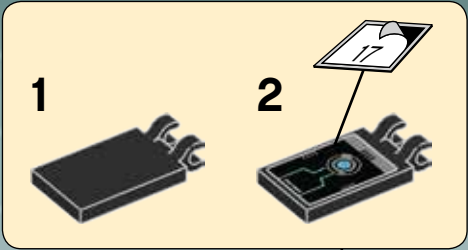
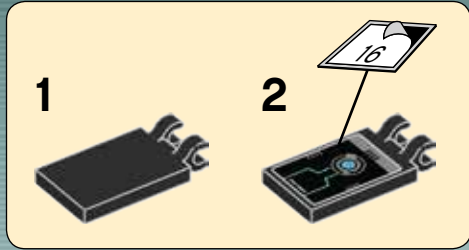

96

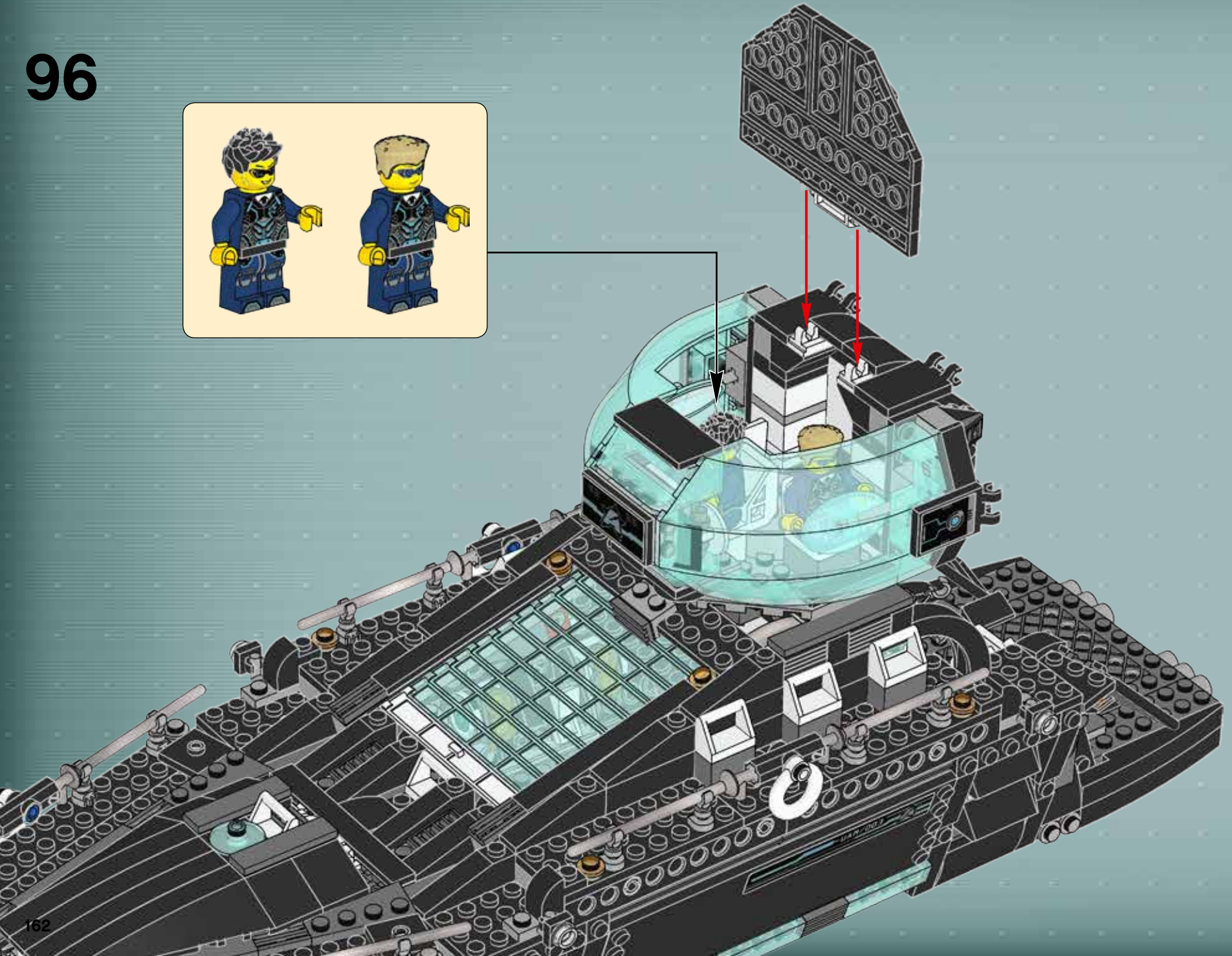

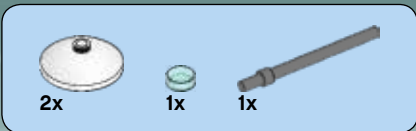

97

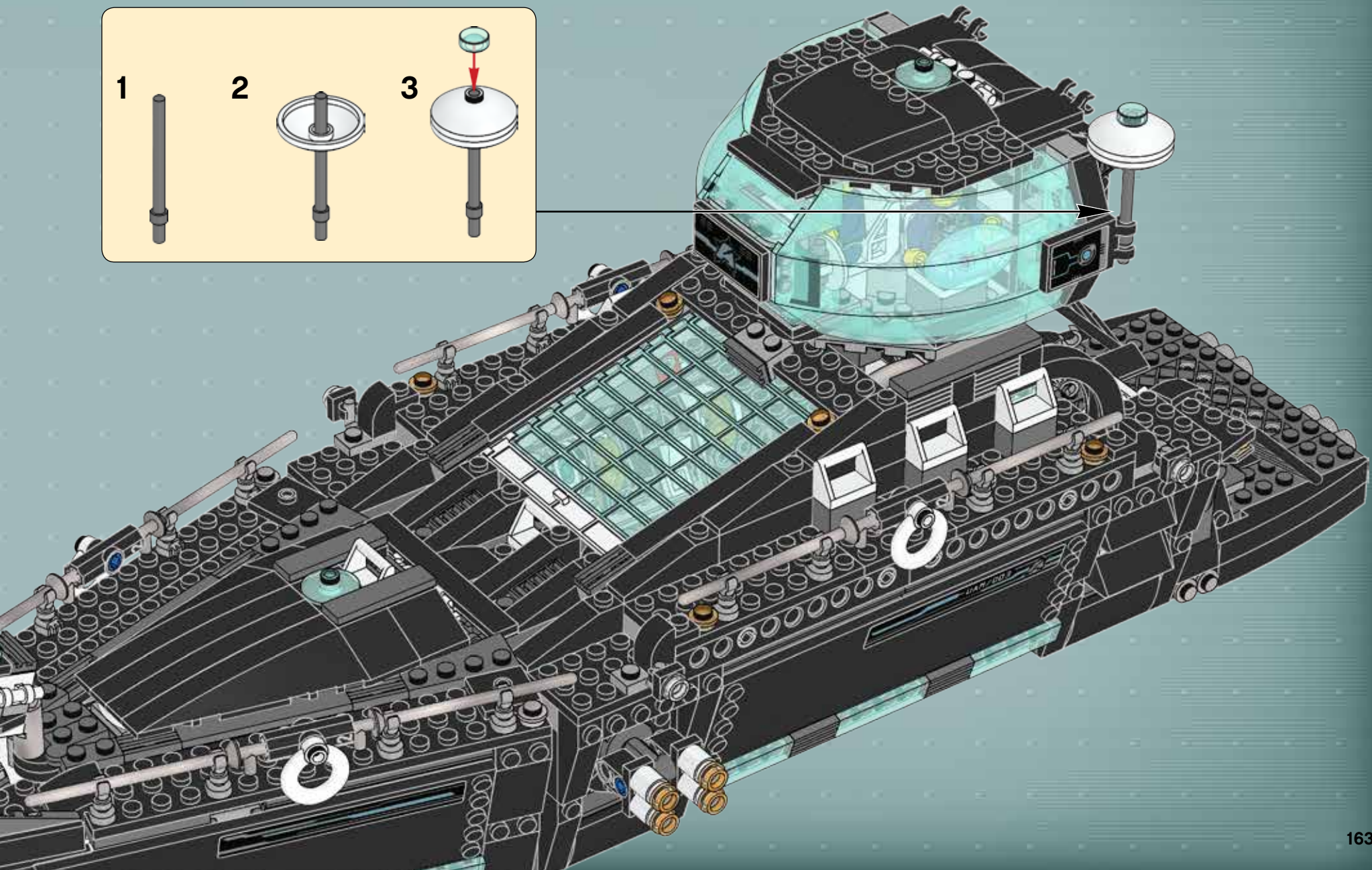
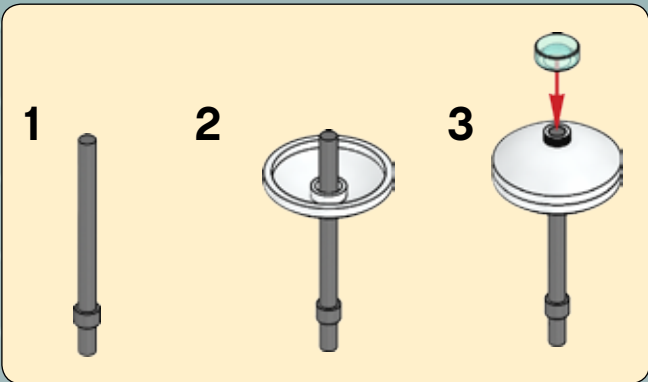

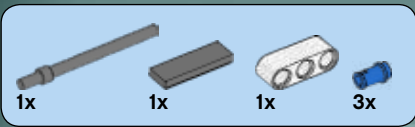

98

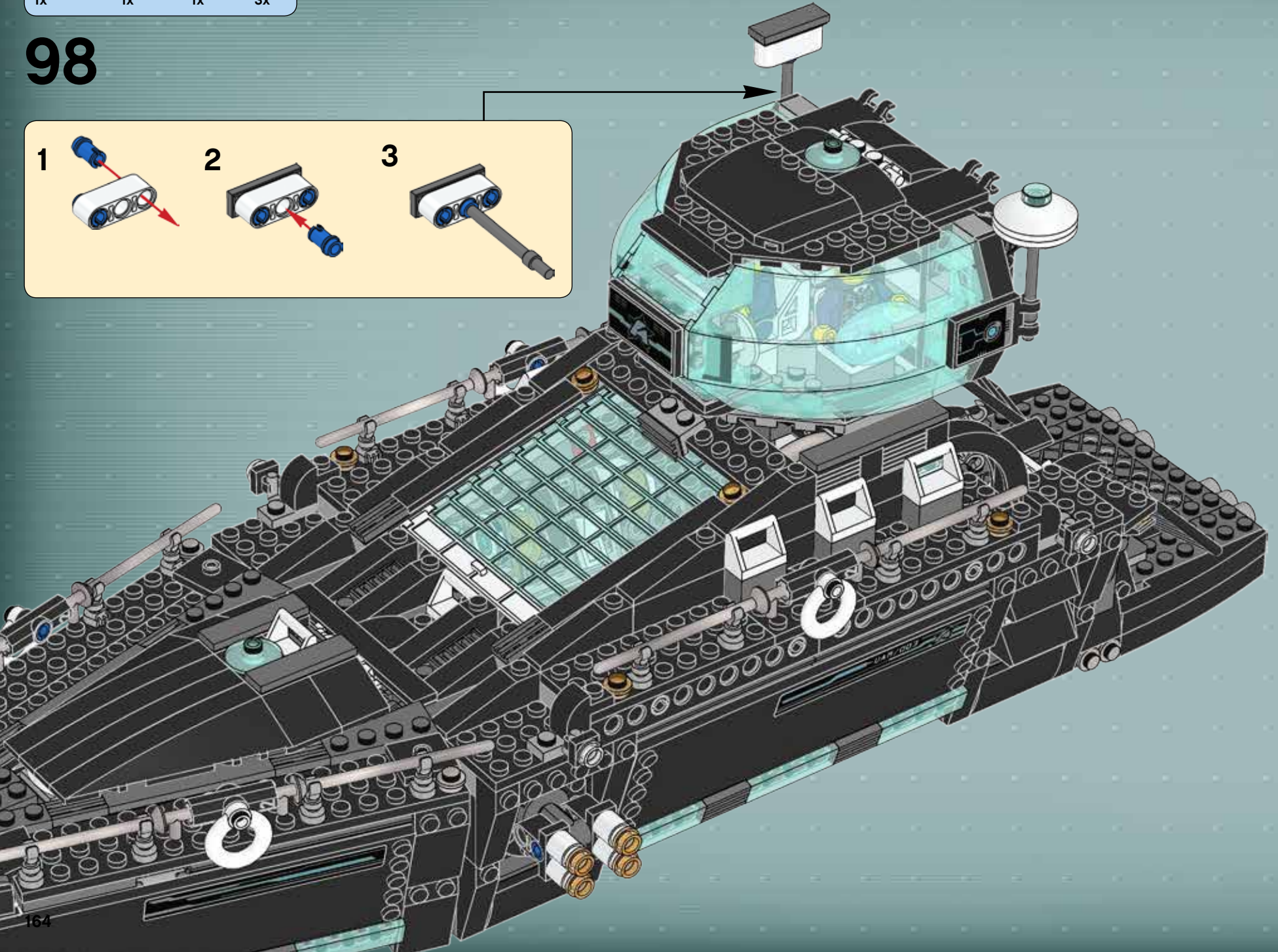
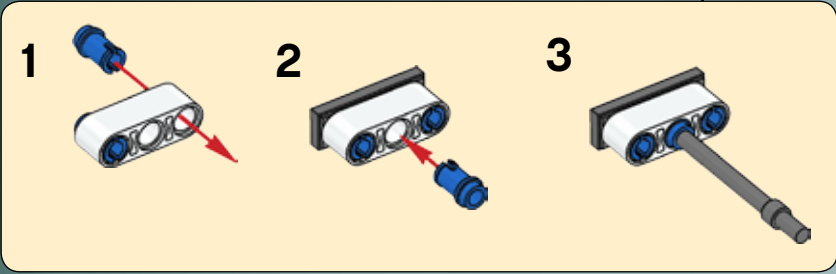

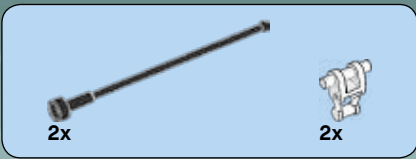

99

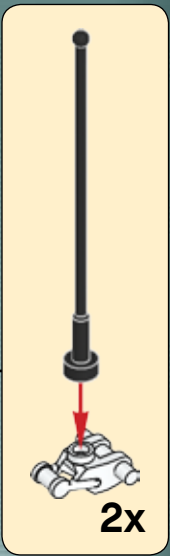
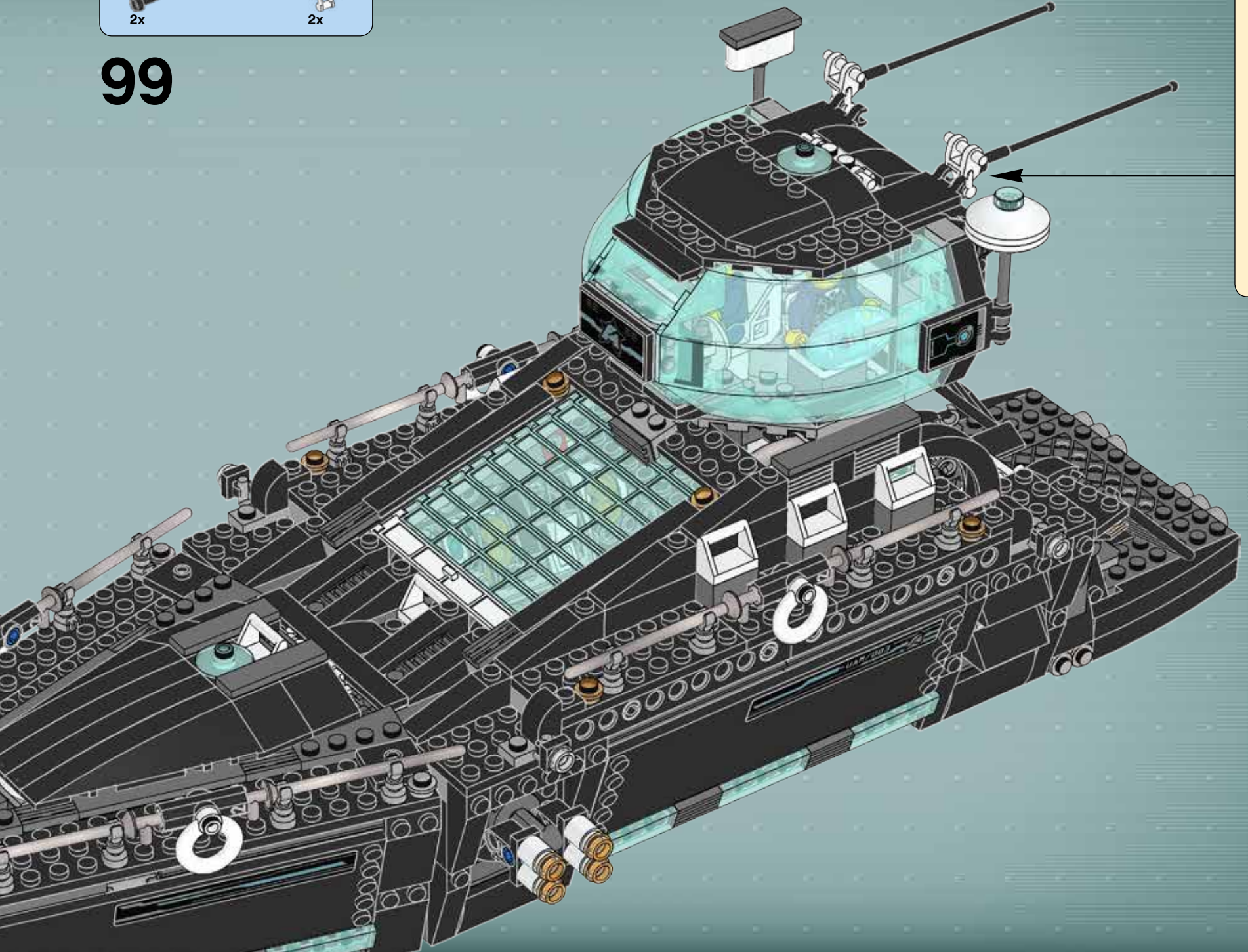

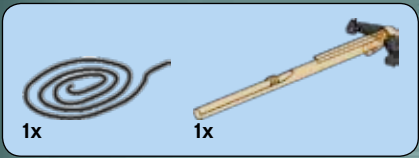

100

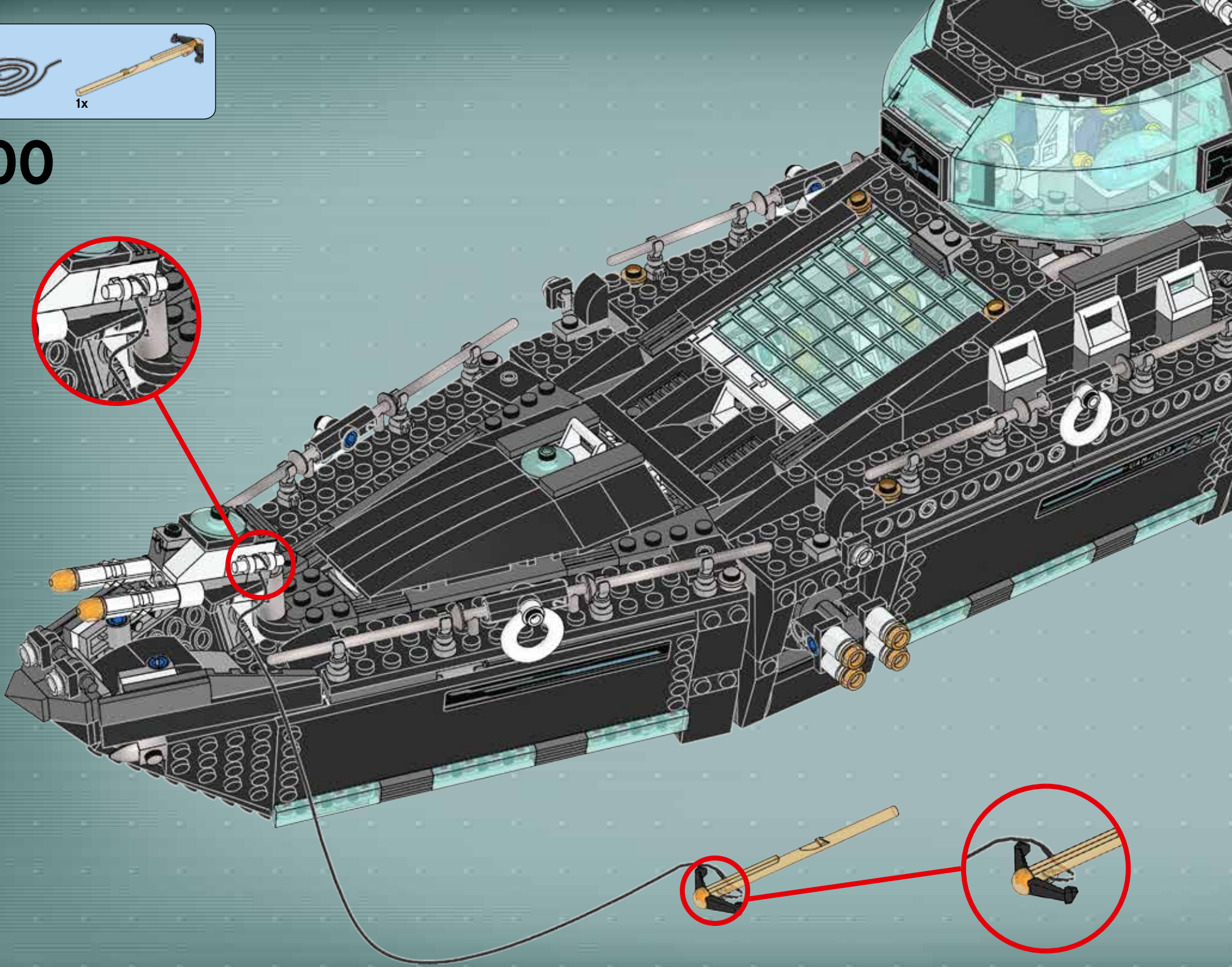

101

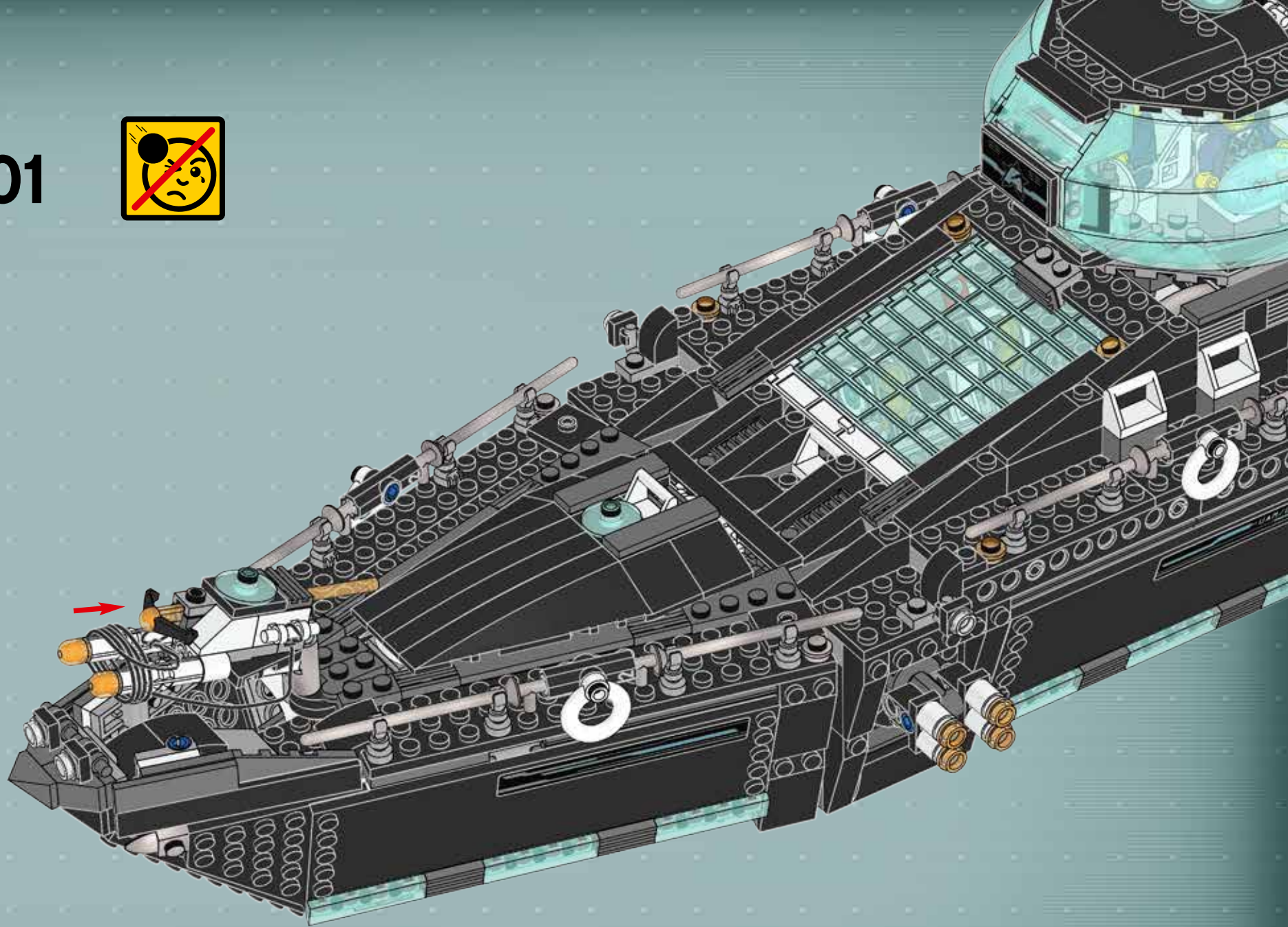



12x



102

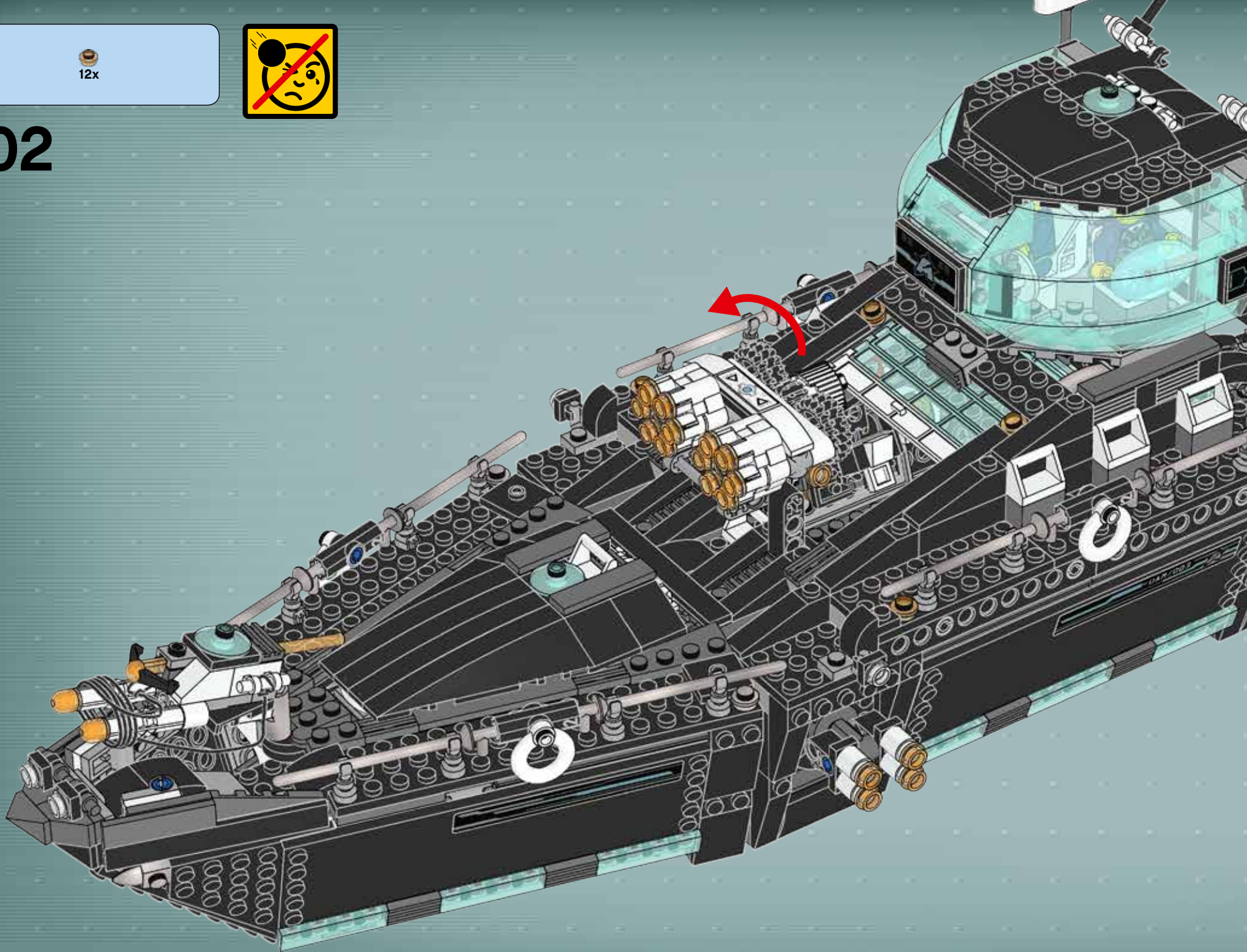

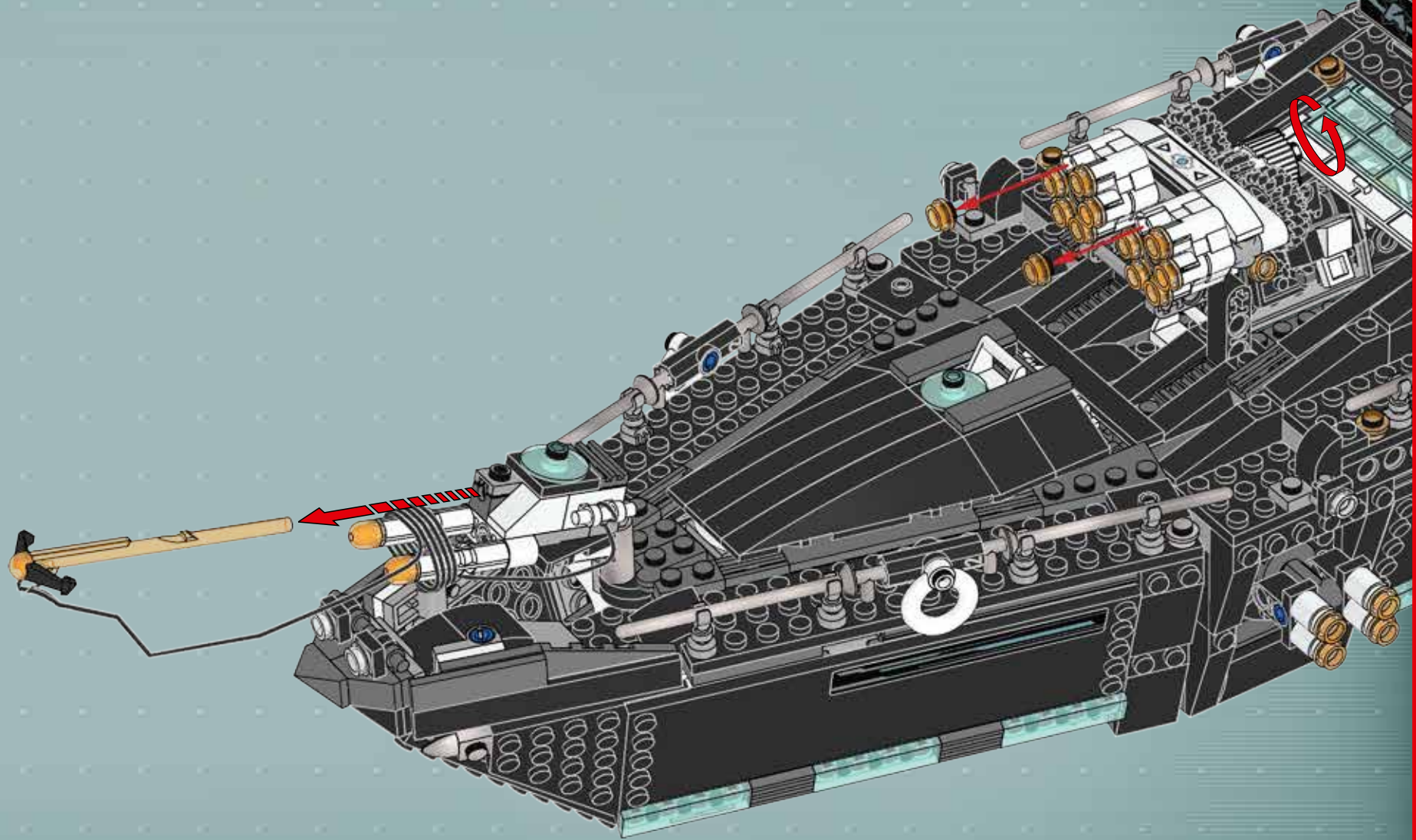

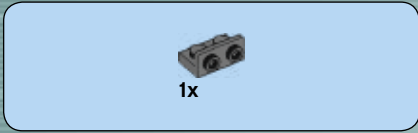

1

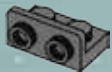

2

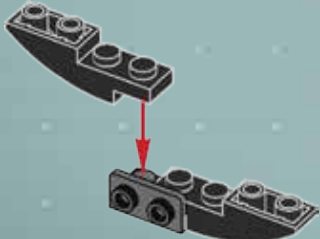

3

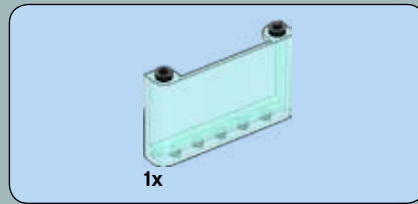

4

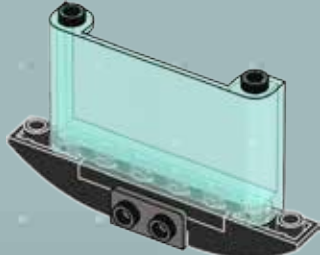

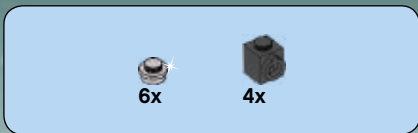

5

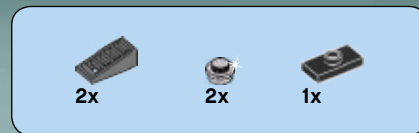
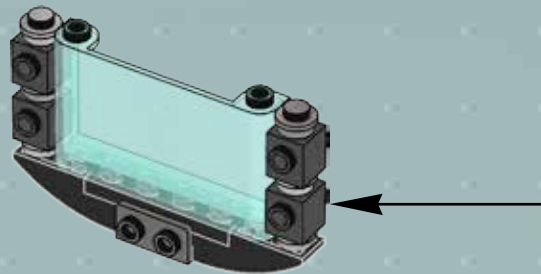
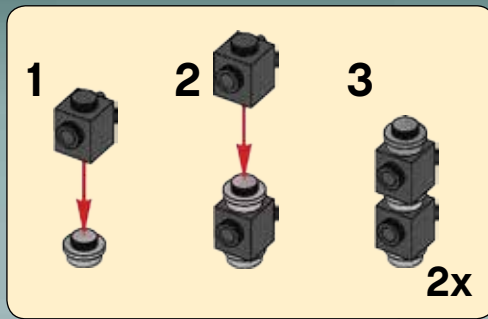

8

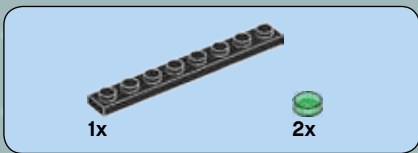
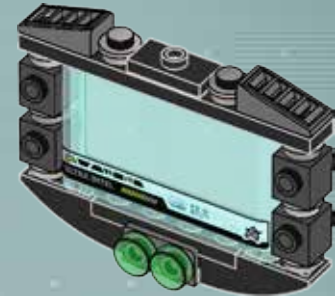

6

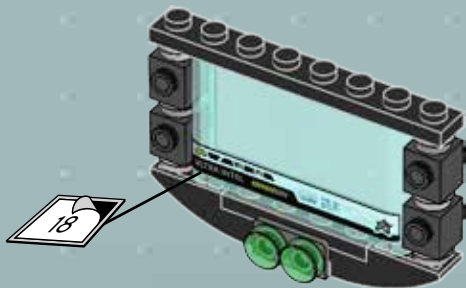

9



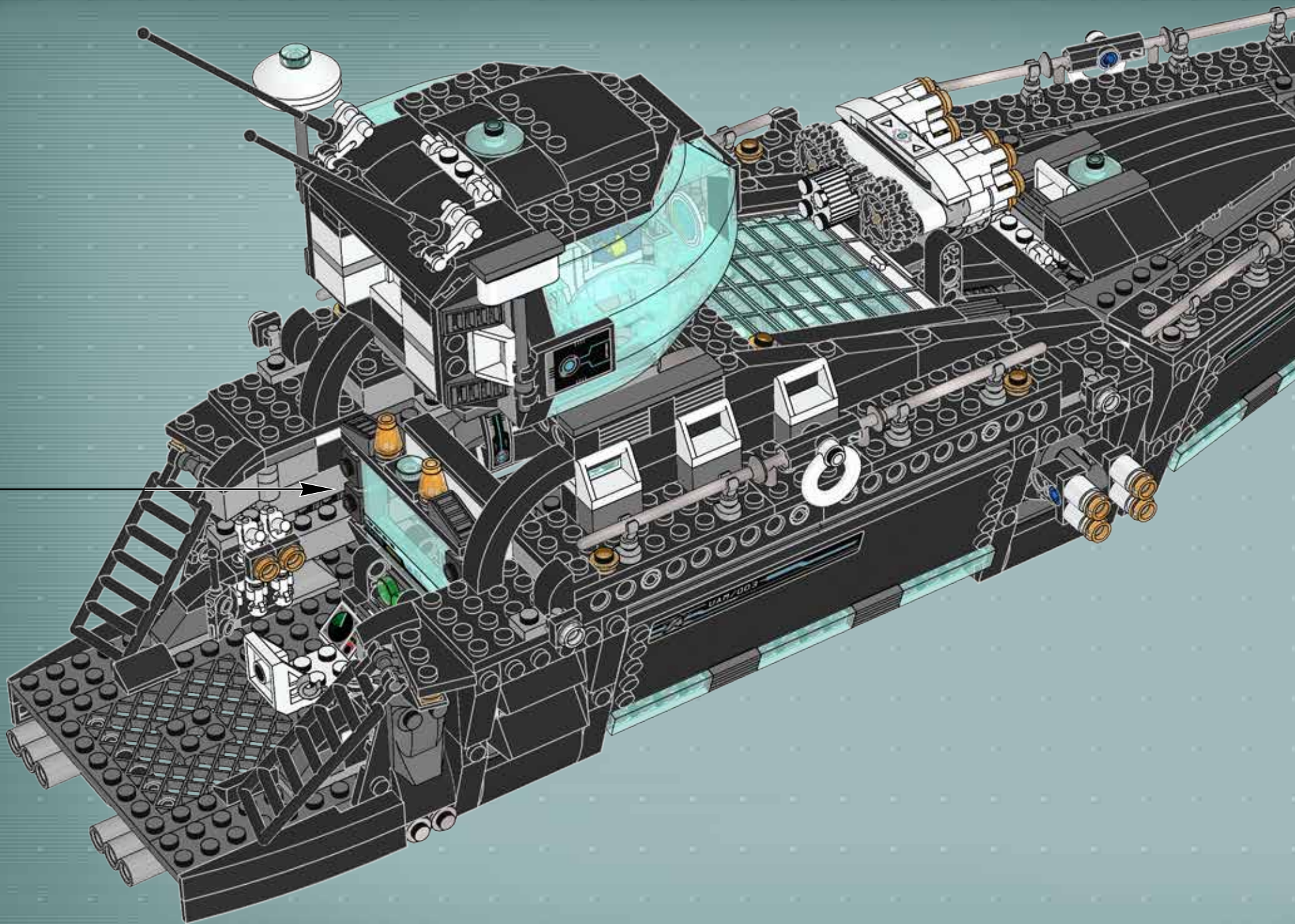



**Download the app and use the AppBrick
Gadget to complete the mission!**

**Télécharge l'appli et utilise le gadget
AppliBrique pour réussir la mission !**

**¡Descarga la app y usa el AppBrick
para completar la misión!**

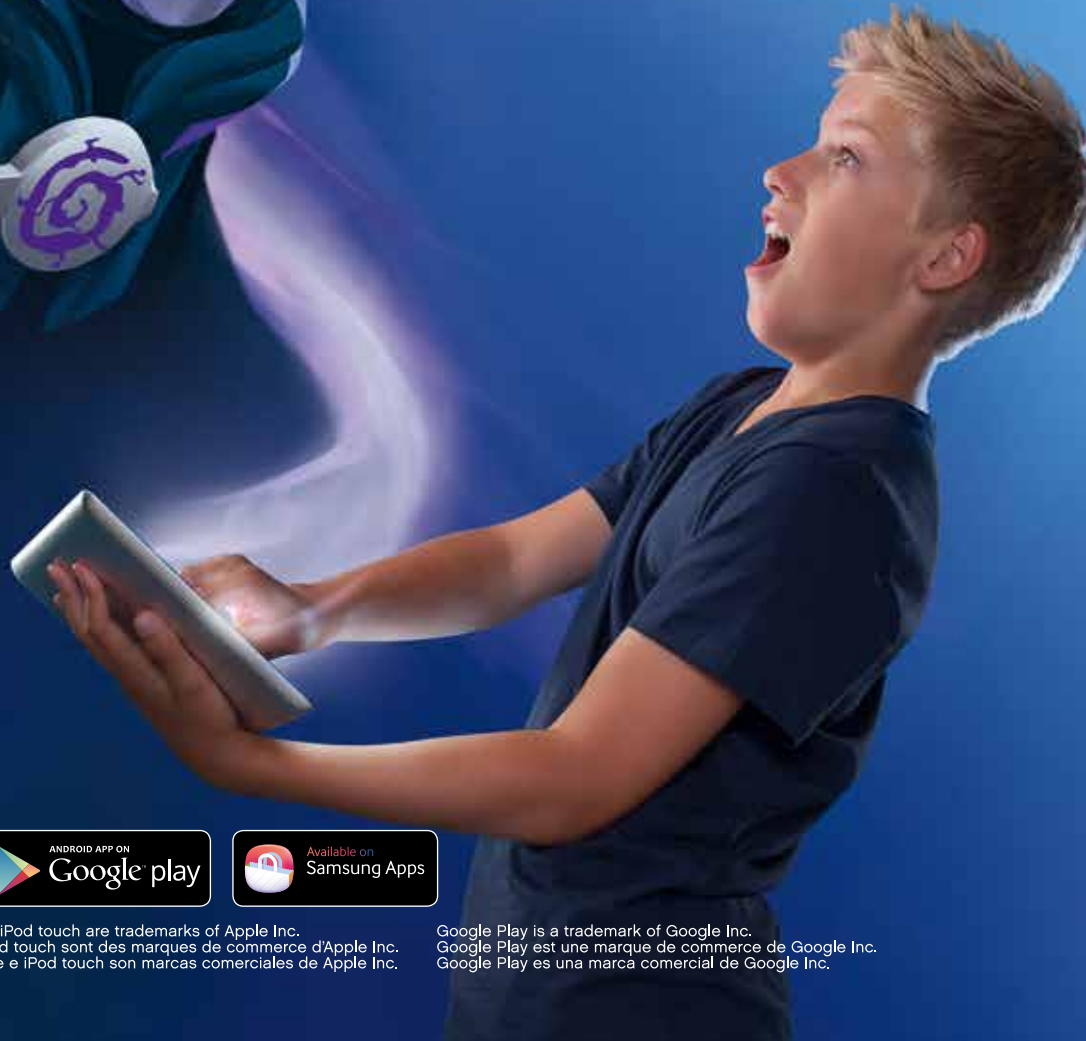

Apple, the Apple logo, iPad, iPhone and iPod touch are trademarks of Apple Inc.
Apple, le logo Apple, iPad, iPhone et iPod touch sont des marques de commerce d'Apple Inc.
Apple, el logotipo de Apple, iPad, iPhone e iPod touch son marcas comerciales de Apple Inc.

Google Play is a trademark of Google Inc.
Google Play est une marque de commerce de Google Inc.
Google Play es una marca comercial de Google Inc.

Unlock the secrets with the new AppBrick Gadgets

Découvre les secrets avec les nouveaux gadgets AppliBrique

Descubre los secretos con los nuevos AppBricks





ULTRA AGENTS



70171



70172



70173



70166



70167



70168



70169



70170





42036



42033



42034

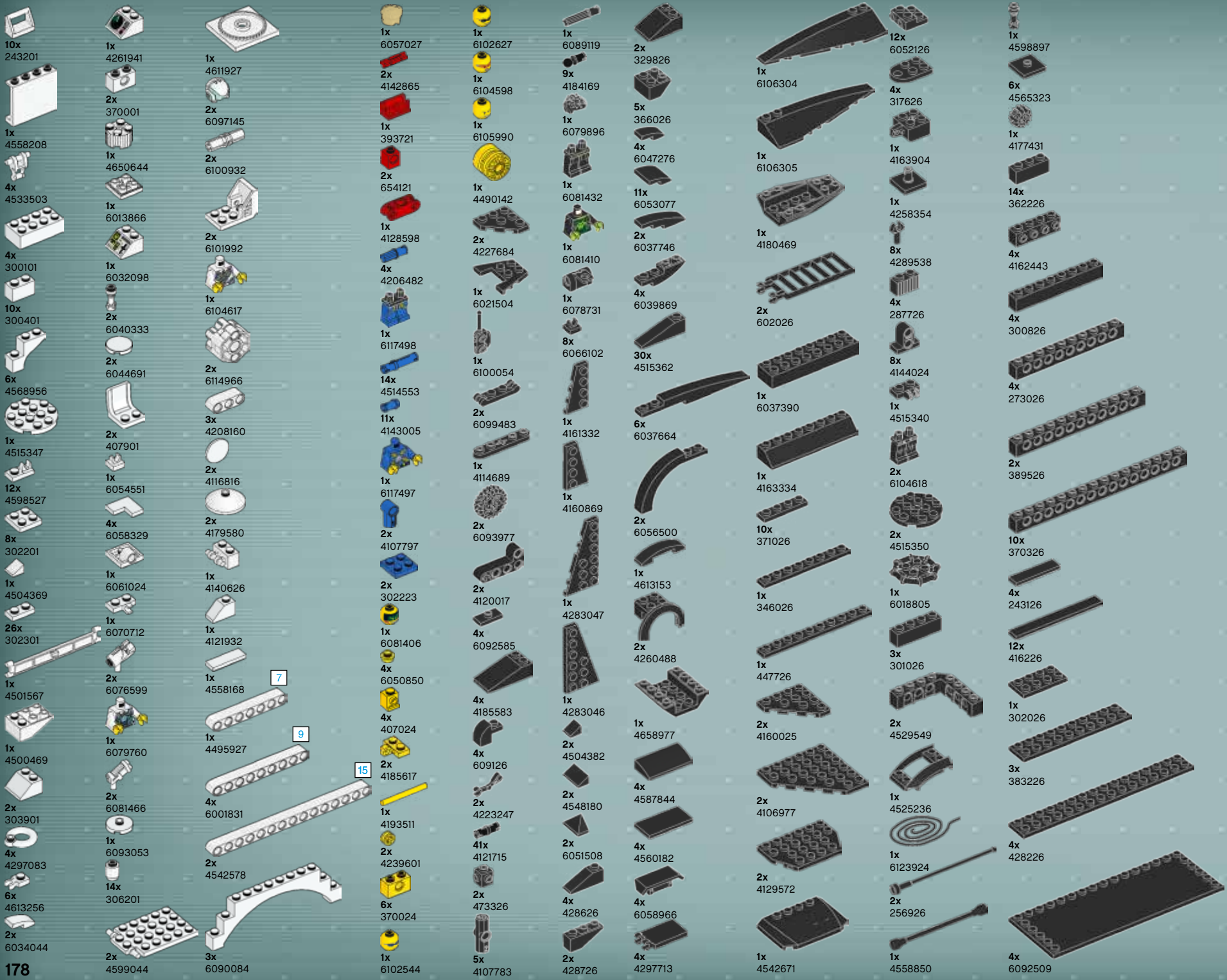

- 10x 243201
- 1x 4558208
- 4x 4533503
- 4x 300101
- 10x 300401
- 6x 4568956
- 1x 4515347
- 12x 4598527
- 8x 302201
- 1x 4504369
- 26x 302301
- 1x 4501567
- 1x 4500469
- 2x 303901
- 4x 4297083
- 6x 4613256
- 2x 6034044
- 1x 4261941
- 2x 370001
- 1x 4650644
- 1x 6013866
- 1x 6032098
- 2x 6040333
- 2x 6044691
- 2x 407901
- 1x 6054551
- 4x 6058329
- 1x 6061024
- 1x 6070712
- 2x 6076599
- 1x 6079760
- 2x 6081466
- 1x 6093053
- 14x 306201
- 2x 4599044
- 1x 4611927
- 2x 6097145
- 2x 6100932
- 2x 6101992
- 1x 6104617
- 2x 6114966
- 3x 4208160
- 2x 4116816
- 2x 4179580
- 1x 4140626
- 1x 4121932
- 1x 4558168
- 1x 4495927
- 4x 6001831
- 2x 4542578
- 3x 6090084
- 1x 6057027
- 2x 4142865
- 1x 393721
- 2x 654121
- 1x 4128598
- 4x 4206482
- 1x 6117498
- 14x 4514553
- 11x 4143005
- 1x 6117497
- 2x 4107797
- 2x 302223
- 1x 6081406
- 4x 6050850
- 4x 407024
- 2x 4185617
- 1x 4193511
- 2x 4239601
- 6x 370024
- 1x 6102544
- 1x 6102627
- 1x 6104598
- 1x 6105990
- 1x 4490142
- 2x 4227684
- 1x 6021504
- 1x 6100054
- 2x 6099483
- 1x 4114689
- 2x 6093977
- 2x 4120017
- 4x 6092585
- 4x 4185583
- 4x 609126
- 2x 4223247
- 41x 4121715
- 2x 473326
- 5x 4107783
- 1x 6089119
- 9x 4184169
- 1x 6079896
- 1x 6081432
- 1x 6081410
- 1x 6078731
- 8x 6066102
- 1x 4161332
- 1x 4160869
- 1x 4283047
- 1x 4283046
- 2x 4504382
- 2x 4548180
- 2x 6051508
- 4x 428626
- 2x 428726
- 2x 329826
- 5x 366026
- 4x 6047276
- 11x 6053077
- 2x 6037746
- 4x 6039869
- 30x 4515362
- 6x 6037664
- 2x 6056500
- 1x 4613153
- 2x 4260488
- 1x 4658977
- 4x 4587844
- 4x 4560182
- 4x 6058966
- 4x 4297713
- 1x 6106304
- 1x 6106305
- 1x 4180469
- 2x 602026
- 1x 6037390
- 1x 4163334
- 10x 371026
- 1x 346026
- 1x 447726
- 2x 4160025
- 2x 4106977
- 2x 4129572
- 1x 4542671
- 12x 6052126
- 4x 317626
- 1x 4163904
- 1x 4258354
- 8x 4289538
- 4x 287726
- 8x 4144024
- 1x 4515340
- 2x 6104618
- 2x 4515350
- 1x 6018805
- 3x 301026
- 2x 4529549
- 1x 4525236
- 1x 6123924
- 2x 256926
- 1x 4558850
- 1x 4598897
- 6x 4565323
- 1x 4177431
- 14x 362226
- 4x 4162443
- 4x 300826
- 4x 273026
- 2x 389526
- 10x 370326
- 4x 243126
- 12x 416226
- 1x 302026
- 3x 383226
- 4x 428226
- 4x 6092509

- 6x 4243819
- 5x 303526
- 1x 303026
- 1x 303326
- 2x 6109815
- 1x 4639346
- 1x 4546691
- 9x 4258476
- 2x 4228126
- 2x 6028411
- 8x 6022171
- 3x 4581214
- 1x 6103865
- 1x 6064345
- 1x 6006514
- 2x 4524365
- 65x 4222960
- 1x 6097148
- 2x 4567338
- 2x 4278409
- 4x 6055631
- 1x 6031821
- 2x 6102607
- 2x 6102608
- 5x 4494475
- 2x 6097090
- 6x 6089147
- 2x 4612621
- 6x 4611702
- 6x 4211386
- 9x 6015344
- 2x 4520320
- 2x 4211815
- 5x 616608
- 6x 4526985
- 2x 4211807
- 6x 4233493
- 1x 4654582
- 13x 4654580
- 2x 4225033
- 2x 4211436
- 16x 6064023
- 9x 6043656
- 1x 4211881
- 1x 6045988
- 1x 4211421
- 2x 4222047
- 4x 4211429
- 4x 4211438
- 1x 4514846
- 2x 4613165
- 19x 4211395
- 3x 4211452
- 10x 6011459
- 10x 4211461
- 1x 4211527
- 2x 4211640
- 2x 4211848
- 1x 6034493
- 14x 4211393
- 2x 6023978
- 2x 4211705
- 4x 4211566
- 1x 4211413
- 1x 4641048
- 2x 6028812
- 4x 6092649
- 6x 4211053
- 4x 4210651
- 2x 4218696
- 2x 4579354
- 2x 6051334
- 1x 6048898
- 20x 4210631
- 2x 6063277
- 2x 4213574
- 3x 4568734
- 2x 4213607
- 4x 6019987
- 4x 6015356
- 5x 4211135
- 1x 4211124
- 2x 6100030
- 4x 4211064
- 4x 4211060
- 3x 4211046
- 3x 4211044
- 12x 6117972
- 10x 4211043
- 13x 6000606
- 1x 4210718
- 6x 4211088
- 2x 4211068
- 2x 6081987
- 4x 4210900
- 2x 4210851
- 1x 6076203
- 2x 4271950
- 2x 6055313
- 1x 4299022
- 14x 4210660
- 2x 4210658
- 2x 4261908
- 8x 4540386
- 8x 4210998
- 6x 4210967
- 10x 4210997
- 3x 4211067
- 2x 6039176
- 2x 4243831
- 2x 4210794
- 4x 4256149
- 1x 4210469
- 4x 6102774
- 2x 4210788
- 2x 4210782
- 1x 6117394
- 4x 6103777
- 3x 6078279
- 2x 4515367
- 1x 6054858
- 2x 6047418
- 2x 4625146
- 18x 4633691
- 2x 4612827
- 8x 4611884

Customer Service
 Kundenservice
 Service Consommateurs
 Servicio Al Consumidor
 LEGO.com/service or dial

: 00800 5346 5555
 : 1-800-422-5346

WIN

GO TO WWW.LEGO.COM/PRODUCTFEEDBACK AND GIVE US YOUR SHORT **FEEDBACK** ABOUT THIS LEGO® SET FOR A CHANCE TO WIN A COOL LEGO PRIZE.



LEGO.com/productfeedback

GEWINNE



Erzähle uns auf www.LEGO.com/productfeedback

etwas über die Erfahrungen, die du mit diesem LEGO® Set gemacht hast, und sichere dir die Chance auf einen coolen LEGO Preis!

GAGNE



Rends-toi sur www.LEGO.com/productfeedback

et donne-nous quelques commentaires sur ce produit LEGO® pour avoir une chance de gagner un prix LEGO !

GANAN



Visita www.LEGO.com/productfeedback

y envíanos tu opinión acerca de este set LEGO®. ¡Participarás en el sorteo de un premio LEGO!

获取奖品



登录 www.LEGO.com/productfeedback

给出关于此乐高®套装的简短反馈，就有机会获得炫酷乐高奖品

경품 당첨 기회



www.LEGO.com/productfeedback

페이지로 이동하여 이 레고® 세트에 대한 간략한 피드백을 보내 주시고 멋진 레고 경품을 탈 수 있는 기회도 잡으십시오

ЗАПОЛНИ АНКЕТУ И ПОЛУЧИ ПРИЗ



Перейди по ссылке www.LEGO.com/productfeedback

ответь всего на несколько вопросов об этом наборе LEGO®, и у тебя появится шанс выиграть замечательный приз от компании LEGO.