



Mixels™

VAKA-WAKA

41553



 LEGO.com

6126530

1

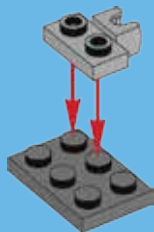

2



3



4

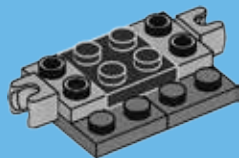

5

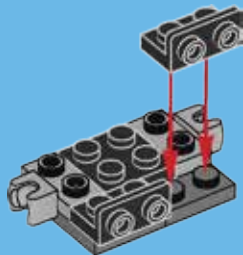

6

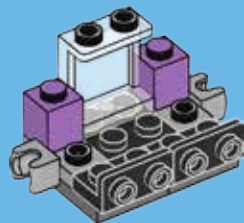

7

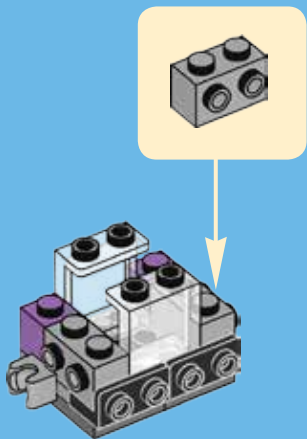

8

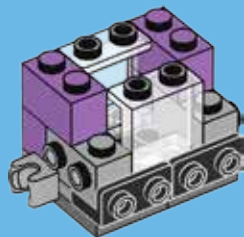

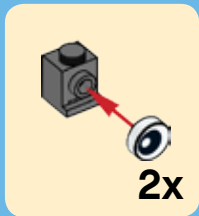

9

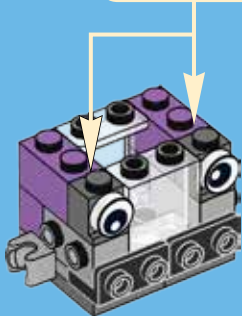

10

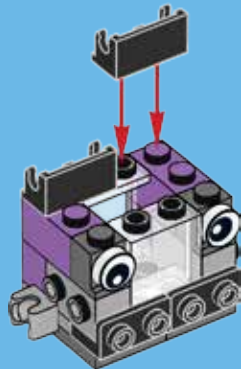

11

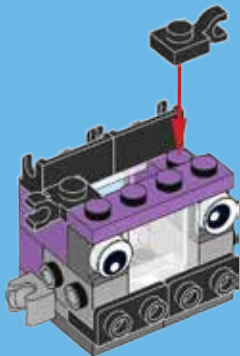

12

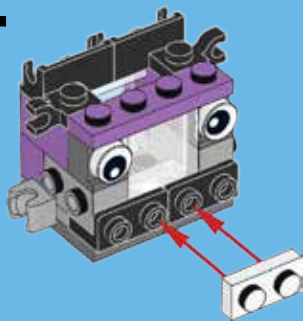

13

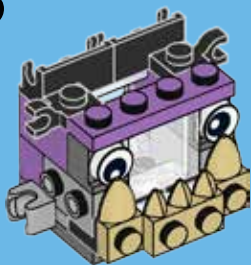

14

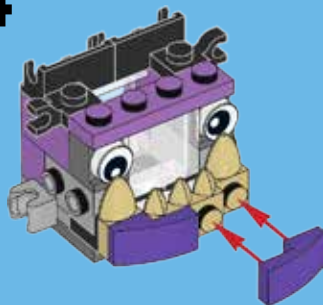

15

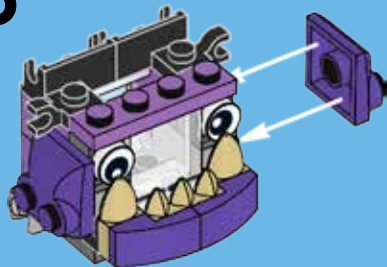

16

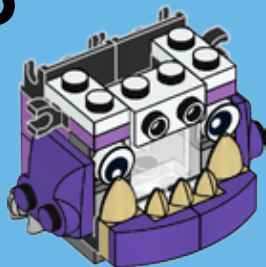

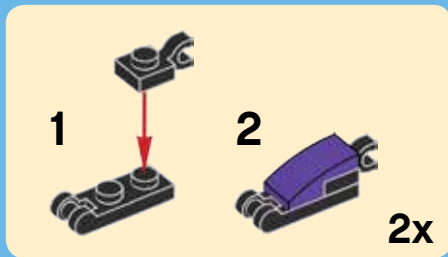

17

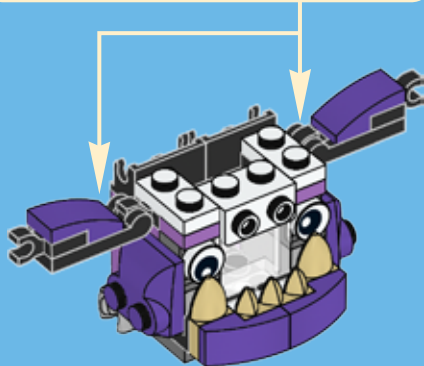

18

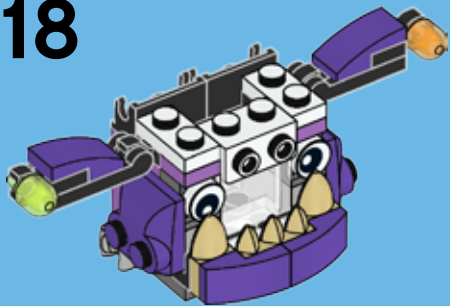

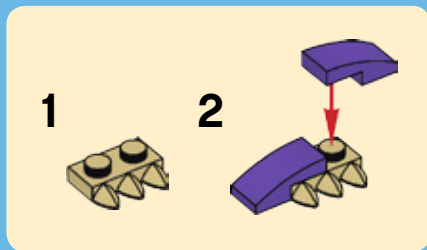

19

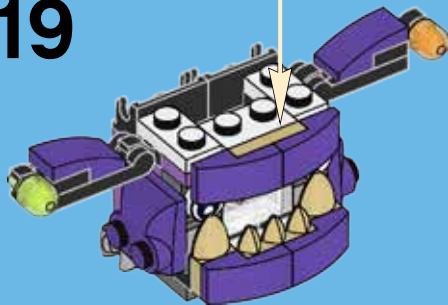

20

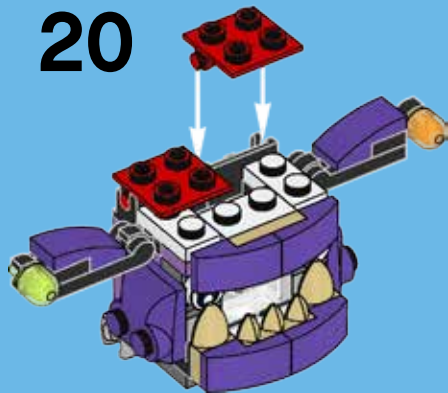

21

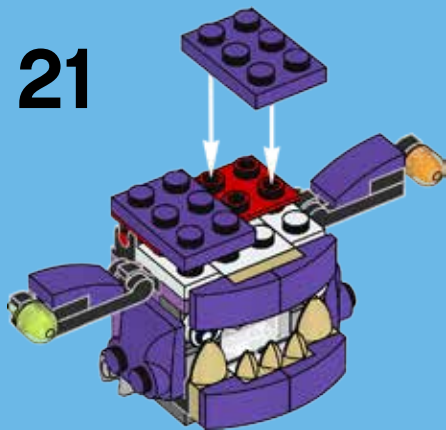

22

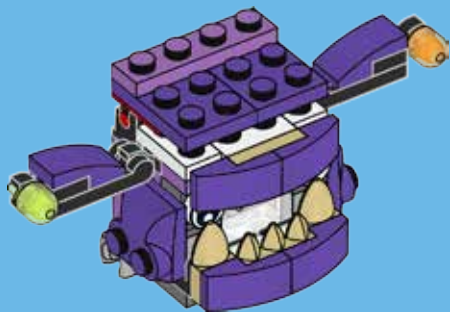

23

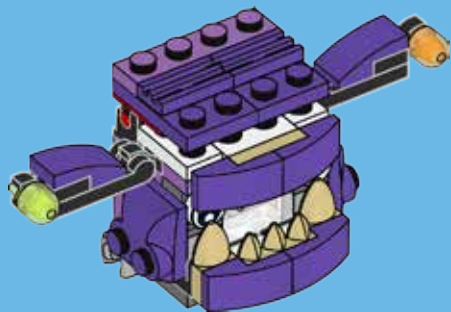

24

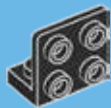

25

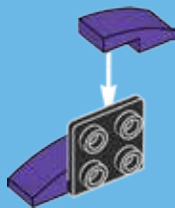

26

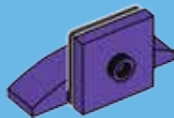

27



28

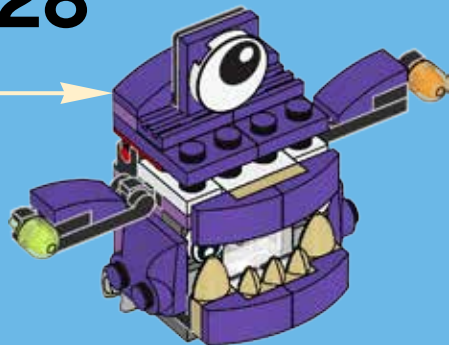

1

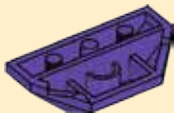

2

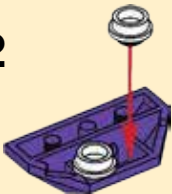

3



29

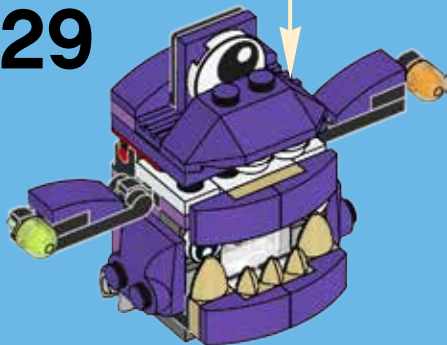



30

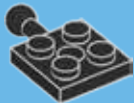

31



32

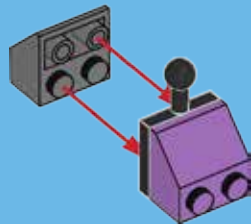

2x

33

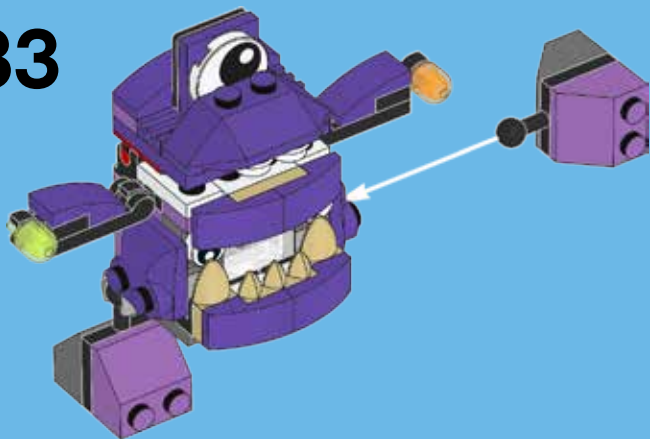

34

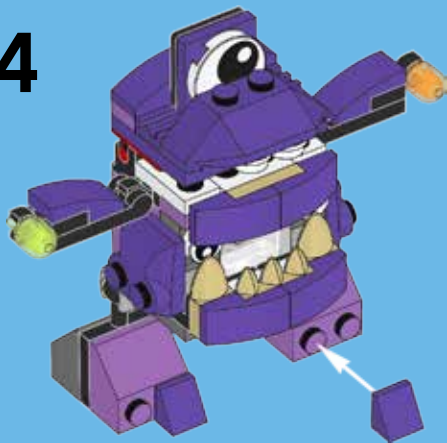



2x
4224793



2x
6000740



2x
613421



2x
4651903



3x
302301



1x
302226



2x
4567509



2x
6046907



2x
6015344



2x
4211044



2x
4623598



1x
6018774



1x
6000650



8x
6057390



1x
4524365



2x
6043656



2x
4211000



2x
6022023



2x
614101



2x
4515368



2x
4655690



1x
4570481



2x
6043656



2x
4211043



2x
4619524



2x
6029156



2x
6051038



1x
4659770



Customer Service

Kundenservice

Service Consommateurs

Servicio Al Consumidor

LEGO.com/service or dial



00800 5346 5555 :



1-800-422-5346 :



4x
4517925



2x
393726



2x
4225142



2x
6020193



1x
6109767



2x
6109766



SNAX
41551



MUNCHOS
MAX!



BERP
41552



VAKA-WAKA
41553



LEGO.com/mixels





Mixels™

SERIES
6



41545
KRAMM



41546
FORX



41547
WUZZO



41548
DRIBBAL



41549
GURGGLE



41550
SLUSHO



41551
SNAX



41552
BERP



41553
VAKA-WAKA



LEGO.com/mixels



Mixels RUSH



**YOU CAN
BUY THE
GAME!**

DOUB1ETROUB1E

IN GAME CODE!



Apple, the Apple logo, iPad, iPhone and iPod touch are trademarks of Apple Inc., registered in the U.S. and other countries. App Store is a service mark of Apple Inc. Google Play is a trademark of Google Inc.

WIN

GO TO WWW.LEGO.COM/PRODUCTFEEDBACK AND
GIVE US YOUR SHORT **FEEDBACK** ABOUT THIS
LEGO® SET FOR A CHANCE TO WIN
A COOL LEGO PRIZE.



LEGO.com/productfeedback

GEWINNE



Erzähle uns auf
www.LEGO.com/productfeedback

etwas über die Erfahrungen, die
du mit diesem LEGO® Set gemacht
hast, und sichere dir die Chance auf
einen coolen LEGO Preis!

GAGNE



Rends-toi sur
www.LEGO.com/productfeedback

et donne-nous quelques commen-
taires sur ce produit LEGO® pour
avoir une chance de gagner un
prix LEGO !

GANA



Visita
www.LEGO.com/productfeedback

y envíanos tu opinión acerca de este
set LEGO®. ¡Participarás en el sorteo
de un premio LEGO!

获取奖品



登录
www.LEGO.com/productfeedback

给出关于此乐高®套装的简短反馈，
就有机会获得炫酷乐高奖品

LEGO, the LEGO logo and MIXELS are trademarks and/or copyrights of the LEGO Group.
©2015 The LEGO Group. All rights reserved.
TM & © 2015 Cartoon Network

6126530