



Mixels™



41540



7 LEGO.com

6126516

1

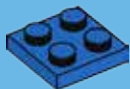

2

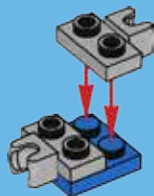

3



4

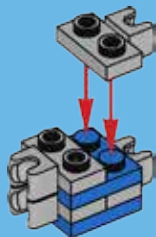

5



6

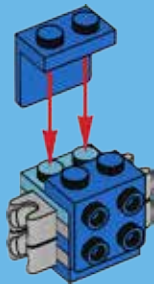

7

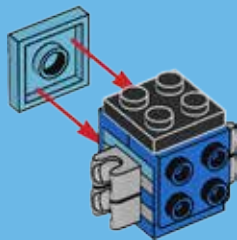

8

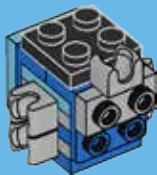

9

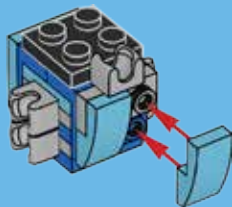



10



11



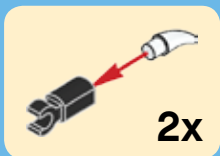

12

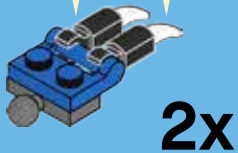

13

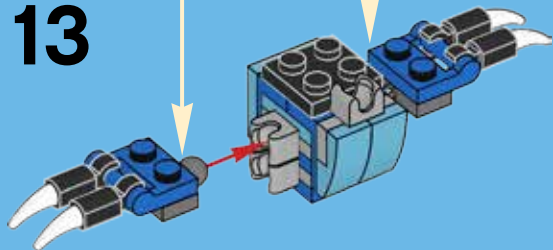



14

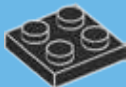

15



16



17



18

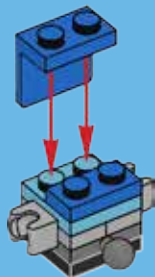

19

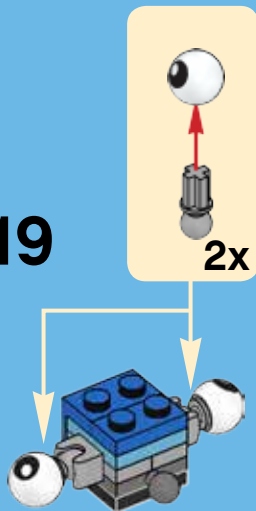

20

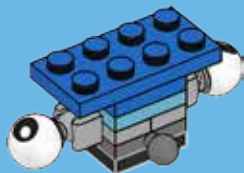

21

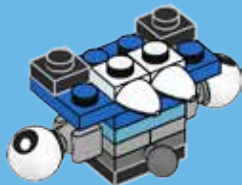

22

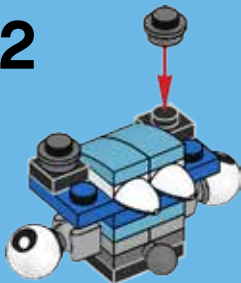

23





24

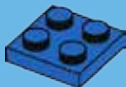

25



26



27

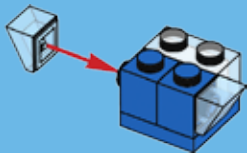

28

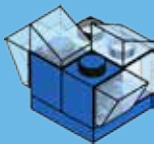

29

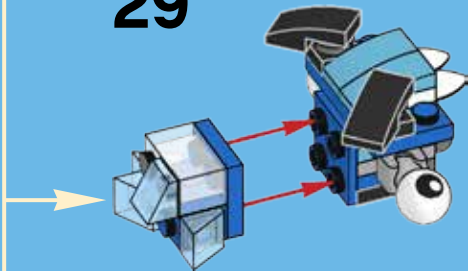

30

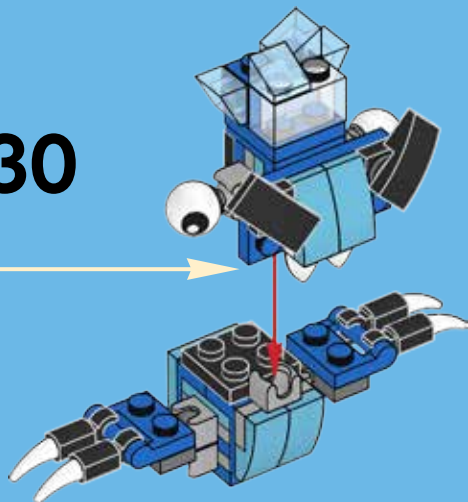



31

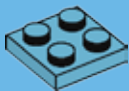

32



33

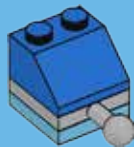

34

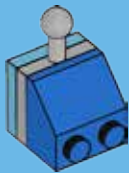

2x

35

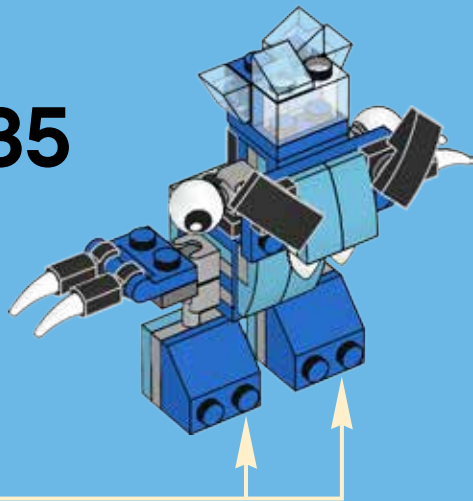

36

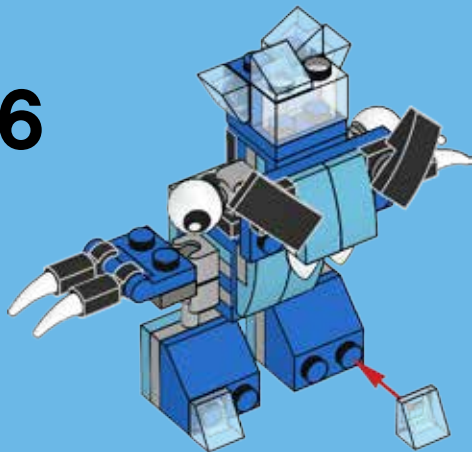

37

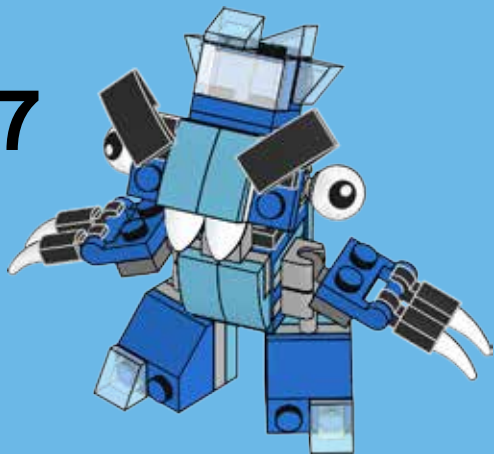



4x
6071246



6x
4611464



7x
6043656



4x
4568387



2x
302426



3x
6117968



5x
4625032



3x
6039479



2x
6063611



2x
4224792



2x
302226



2x
4514398



1x
306540



2x
4210633



2x
4211375



2x
6056225



4x
6015891



2x
302323



Customer Service

Kundenservice

Service Consommateurs

Servicio Al Consumidor

LEGO.com/service or dial



00800 5346 5555 :



1-800-422-5346 :



2x
6047276



2x
4583862



3x
302223



2x
303923



1x
302023



**KROG
41539**



**FROSTICONS
MAX!**



**CHILBO
41540**



**SNOOF
41541**



LEGO.com/mixels





Mixels™

SERIES
5



**41536
GOX**



**41537
JINKY**



**41538
KAMZO**



**41539
KROG**



**41540
CHILBO**



**41541
SNOOF**



**41542
SPUGG**



**41543
TURG**



**41544
TUNGSTER**



LEGO.com/mixels





**YOU CAN
BUY THE
GAME!**

S N 8 W I T A 1 1

IN GAME CODE!

MIXELS RUSH



Apple, the Apple logo, iPad, iPhone and iPod touch are trademarks of Apple Inc. Google Play is a trademark of Google Inc.

WIN

GO TO WWW.LEGO.COM/PRODUCTFEEDBACK AND
GIVE US YOUR SHORT **FEEDBACK** ABOUT THIS
LEGO® SET FOR A CHANCE TO WIN
A COOL LEGO PRIZE.



LEGO.com/productfeedback

GEWINNE



Erzähle uns auf
www.LEGO.com/productfeedback

etwas über die Erfahrungen, die
du mit diesem LEGO® Set gemacht
hast, und sichere dir die Chance auf
einen coolen LEGO Preis!

GAGNE



Rends-toi sur
www.LEGO.com/productfeedback

et donne-nous quelques commen-
taires sur ce produit LEGO® pour
avoir une chance de gagner un
prix LEGO !

GANA



Visita
www.LEGO.com/productfeedback

y envíanos tu opinión acerca de este
set LEGO®. ¡Participarás en el sorteo
de un premio LEGO!

获取奖品



登录
www.LEGO.com/productfeedback

给出关于此乐高®套装的简短反馈，
就有机会获得炫酷乐高奖品

LEGO, the LEGO logo and MIXELS are trademarks and/or copyrights of the LEGO Group.
©2015 The LEGO Group.
TM & © 2015 Cartoon Network

6126516