

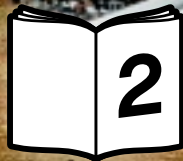

CITY

60075



 [LEGO.com/city](https://www.lego.com/city)



WARNING: CHOKING HAZARD.
Small parts. Not for children under 3 years.





+

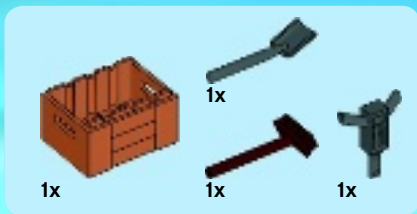

1





1x



1x



2x



AVERTISSEMENT : RISQUE D'ÉTOUFFEMENT.
Contient des petites pièces. Ne convient pas aux enfants de moins de 3 ans.



ADVERTENCIA: PELIGRO DE ASFIXIA.
No recomendado para niños menores de 3 años. Contiene piezas pequeñas.

2

1



2



3



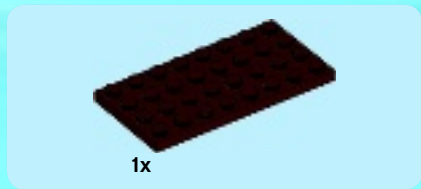

1





2x

2



4x

3

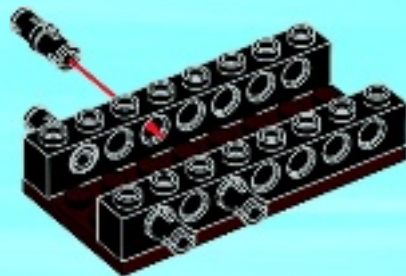



2x

4

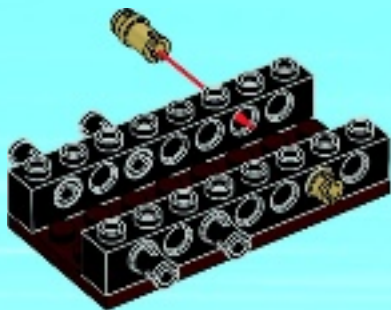



2x



1x

5

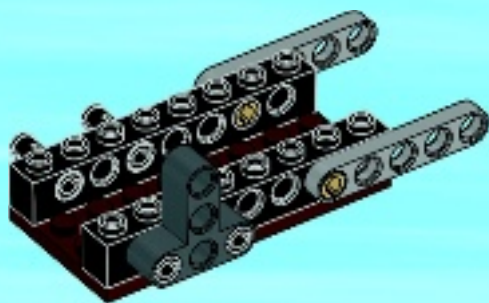



1

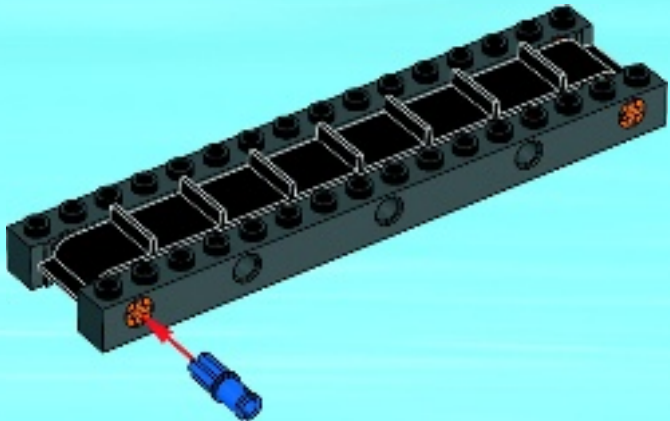



2x

2

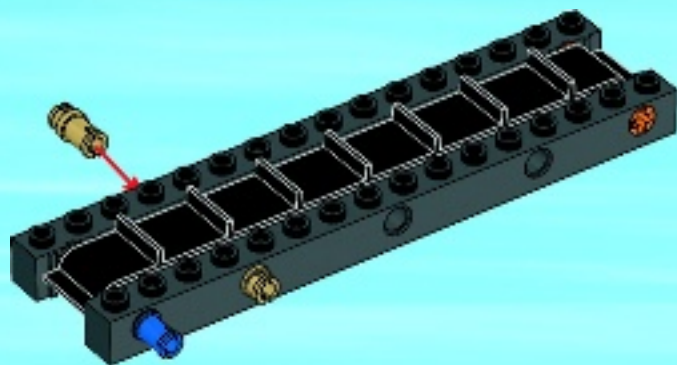



2x

4

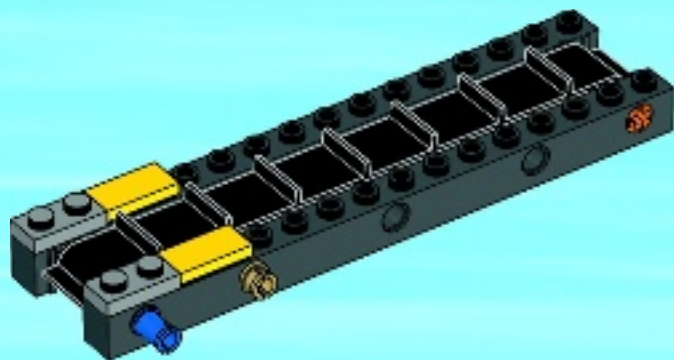



6x

5

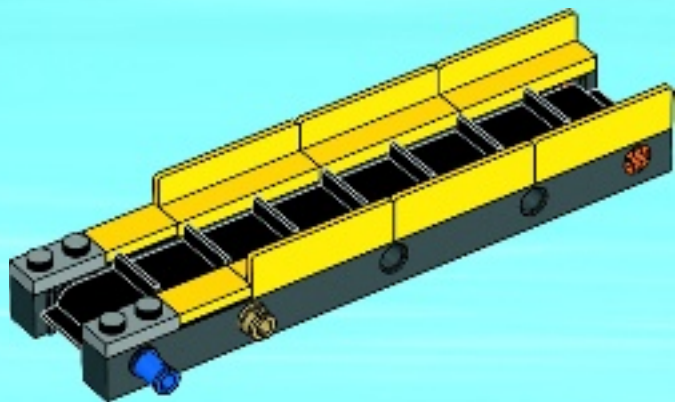

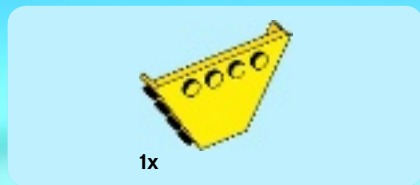

6

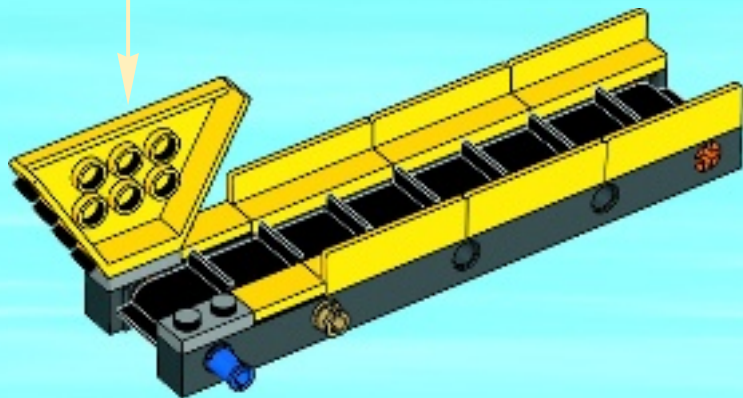

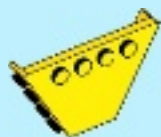

1x

7

1

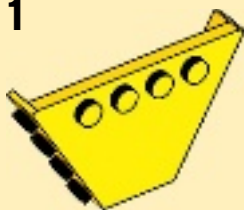

2

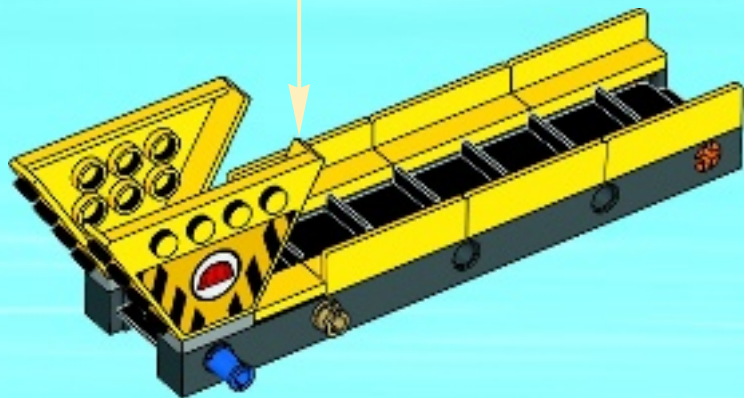



1x

8

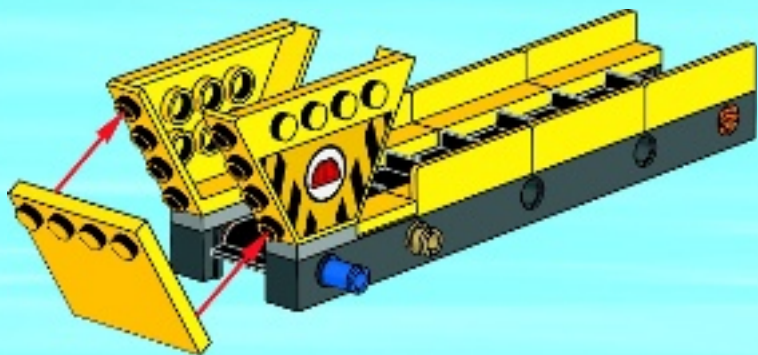



1x

9

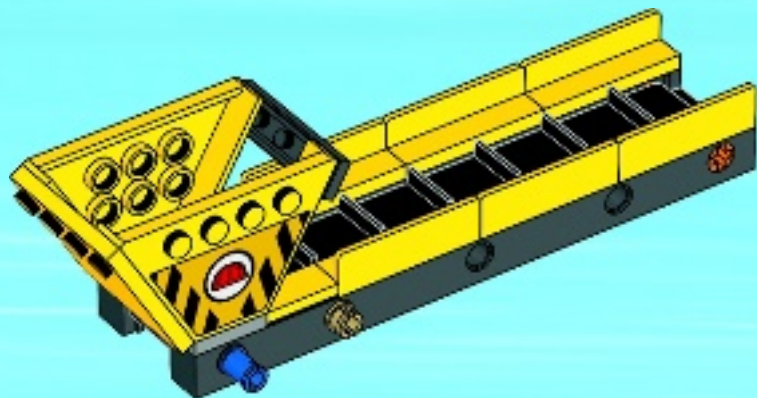

10

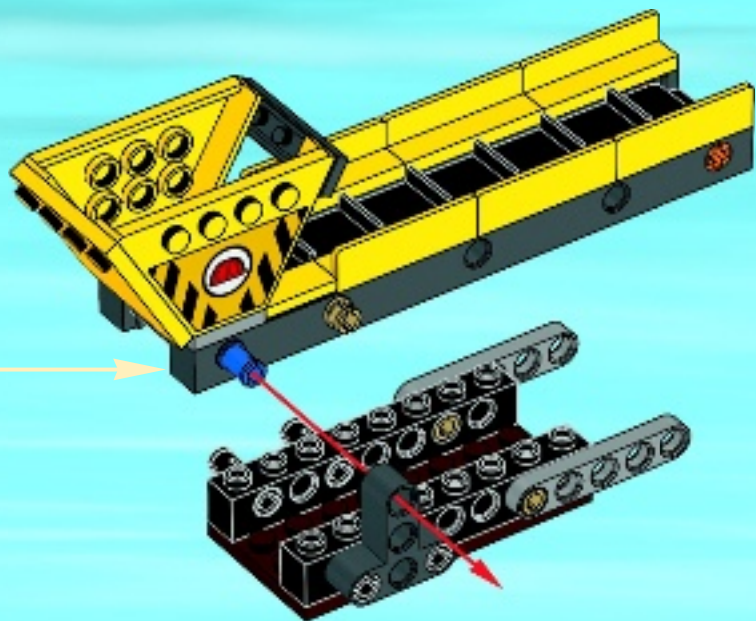



1x

11





1x

12

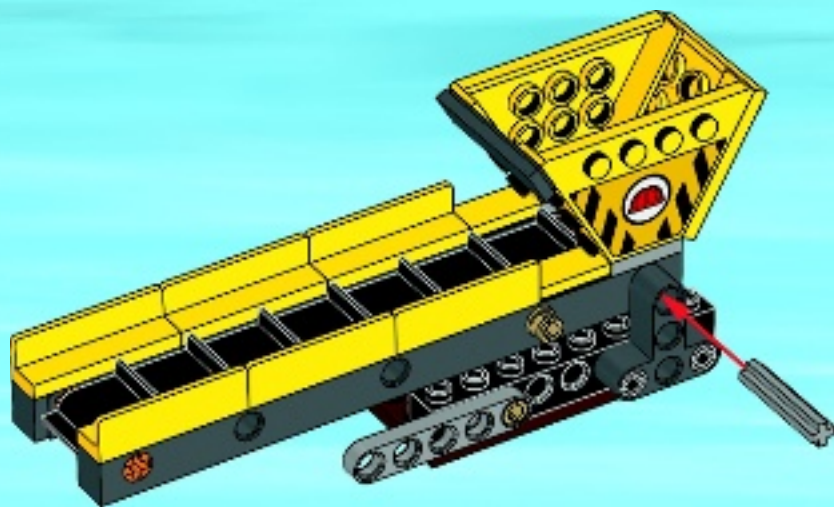



1x



1x

1



2



3



13

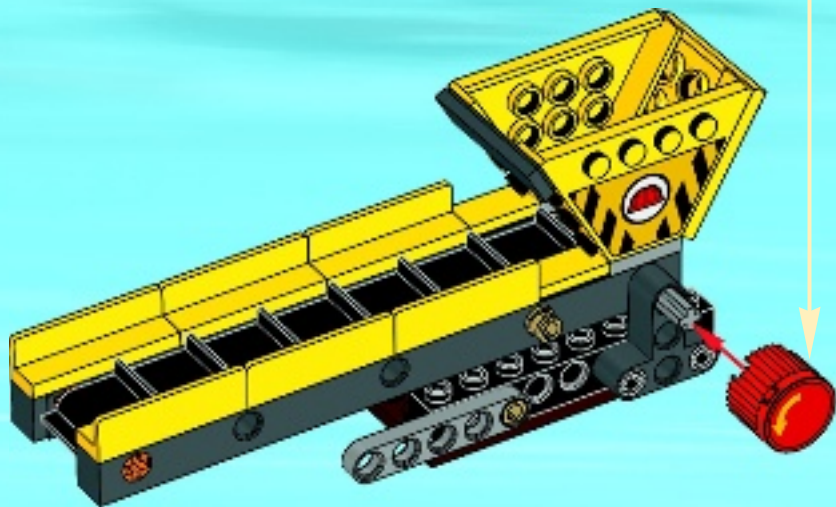

14

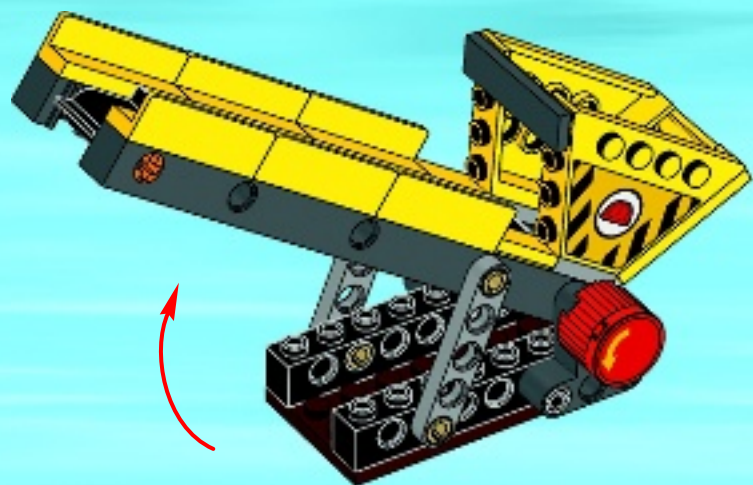



15

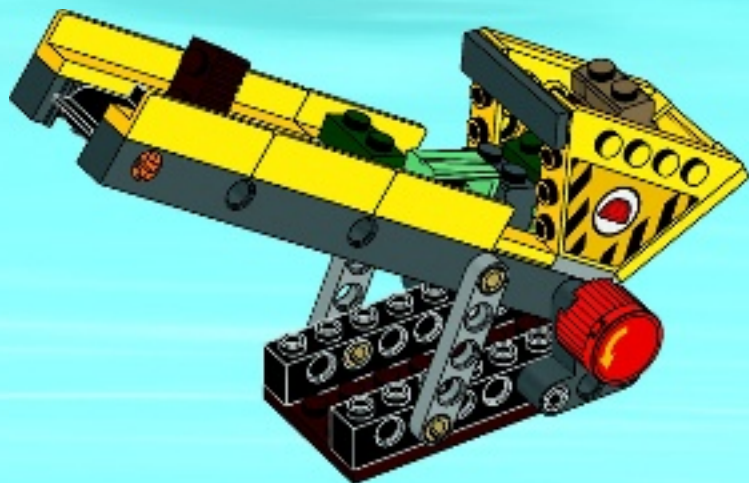

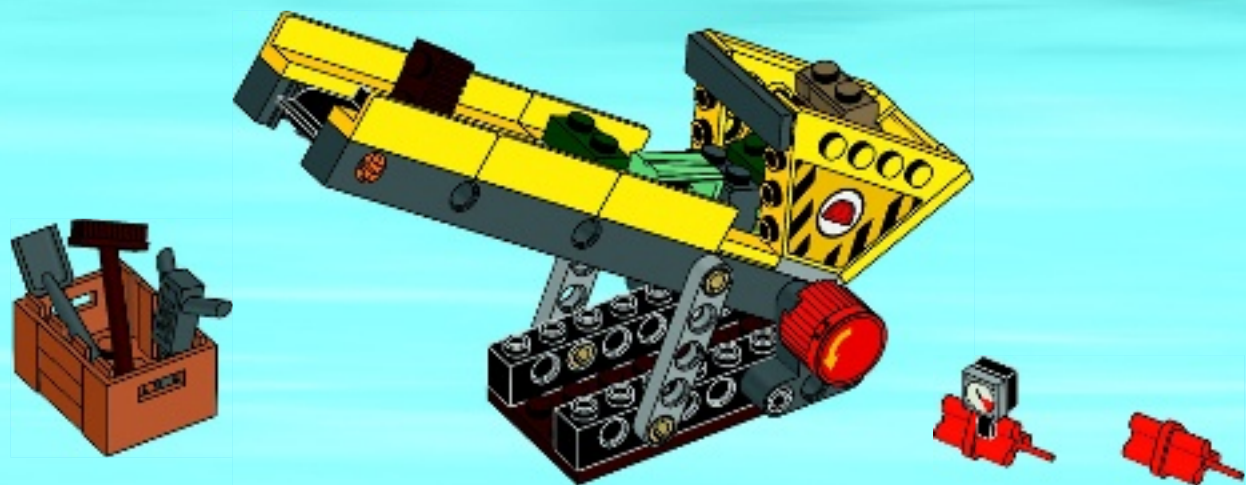



FREE ONLINE GAME & APP!
JEU EN LIGNE ET APPLI GRATUITS !
¡JUEGO ONLINE Y APP GRATIS!



LEGO and the LEGO logo are trademarks of the/
 sont des marques de commerce de/
 son marcas registradas de LEGO Group.
 ©2015 The LEGO Group. 6109363



LEGO.COM/CITY

GET IT ON
Google play

Download on the
App Store



Apple, the Apple logo, iPad, iPhone and iPod touch are trademarks of Apple Inc., registered in the U.S. and other countries. App Store is a service mark of Apple Inc. /Apple, le logo Apple, iPad, iPhone et iPod touch sont des marques de commerce d'Apple Inc., déposées aux États-Unis et dans d'autres pays. App Store est une marque de service d'Apple Inc. /Apple, et logotipo de Apple, iPad, iPhone e iPod touch son marcas comerciales de Apple Inc. registrado en EE. UU. y otros países. App Store es una marca de servicio de Apple Inc. Google Play is a trademark of Google Inc. /Google Play est une marque de commerce de Google Inc. /Google Play es una marca comercial de Google Inc.