

The LEGO logo, consisting of the word "LEGO" in white capital letters on a red square background.

# HEROFACTORY



HeroFactory.LEGO.com

# DRILLDOZER

2192

2068





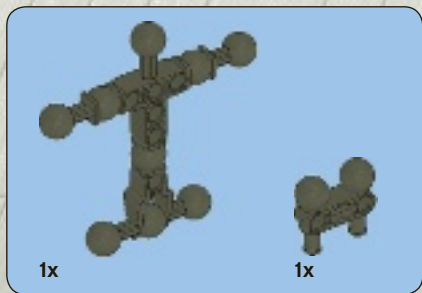

1

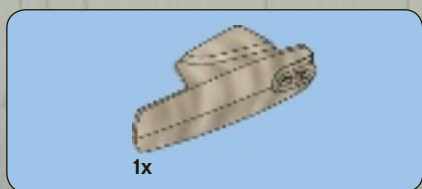
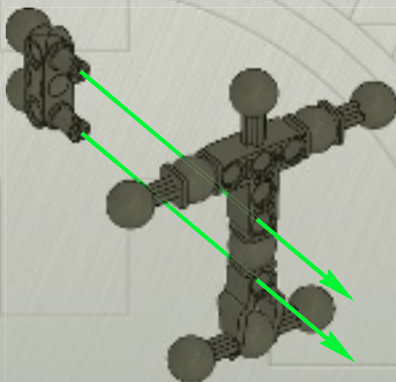

2

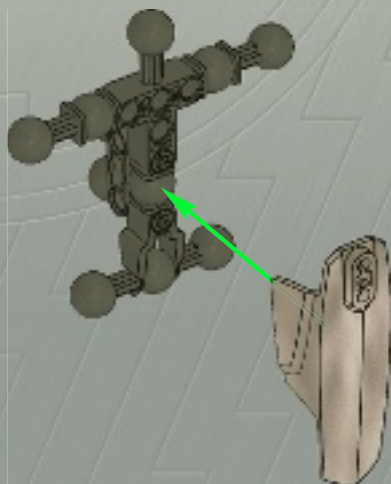

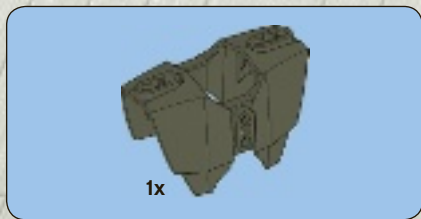

3

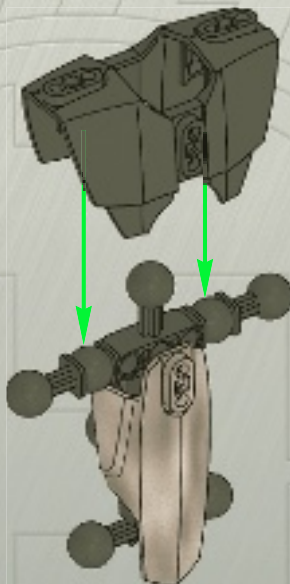

4

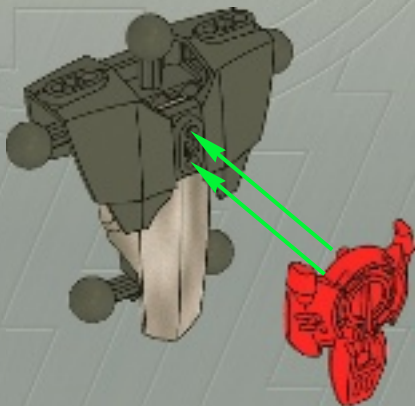

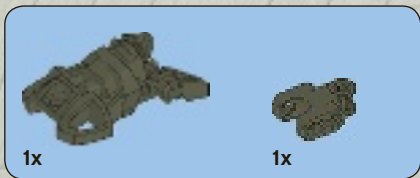

1

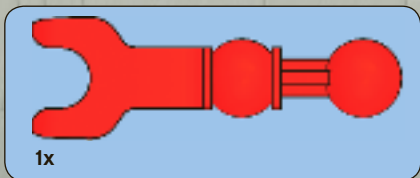
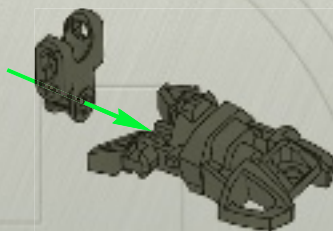

2

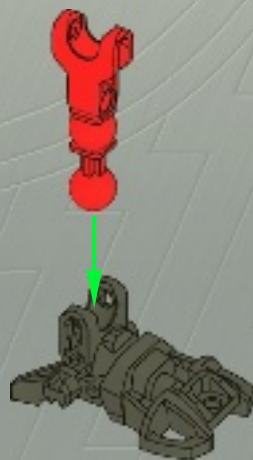



**3**

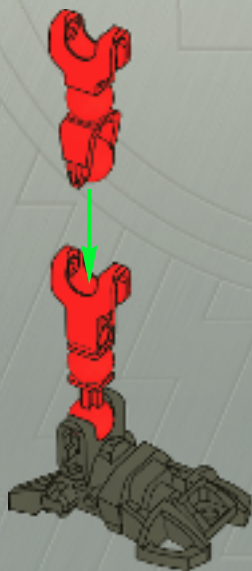

**2x**

**5**

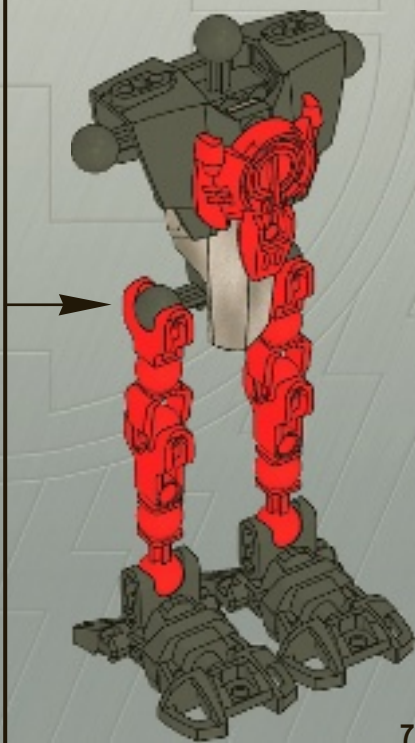



6

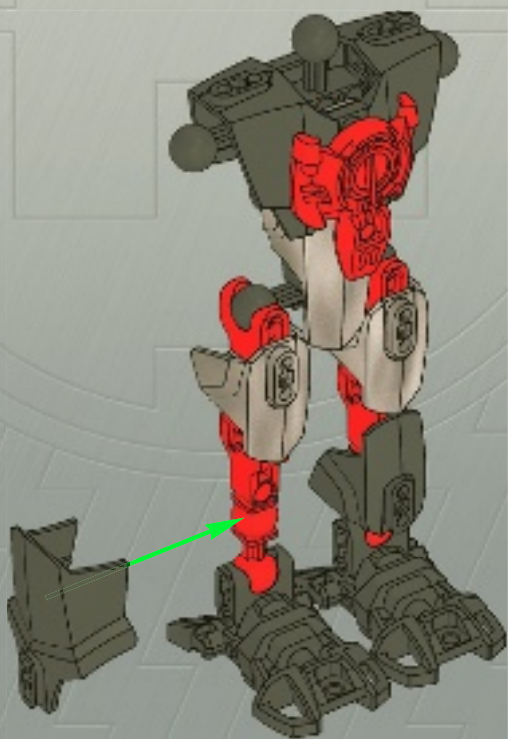







3

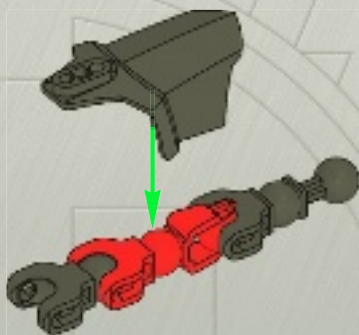

4

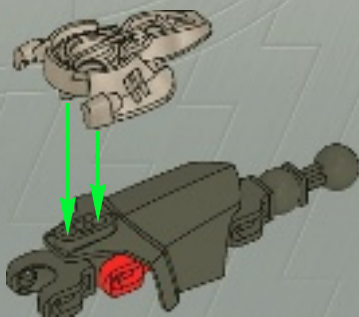



5

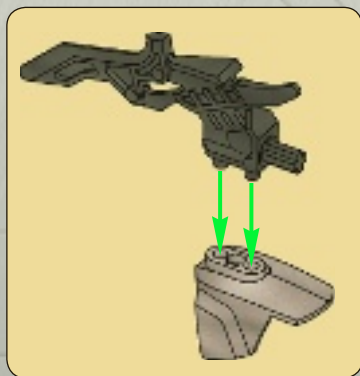

7

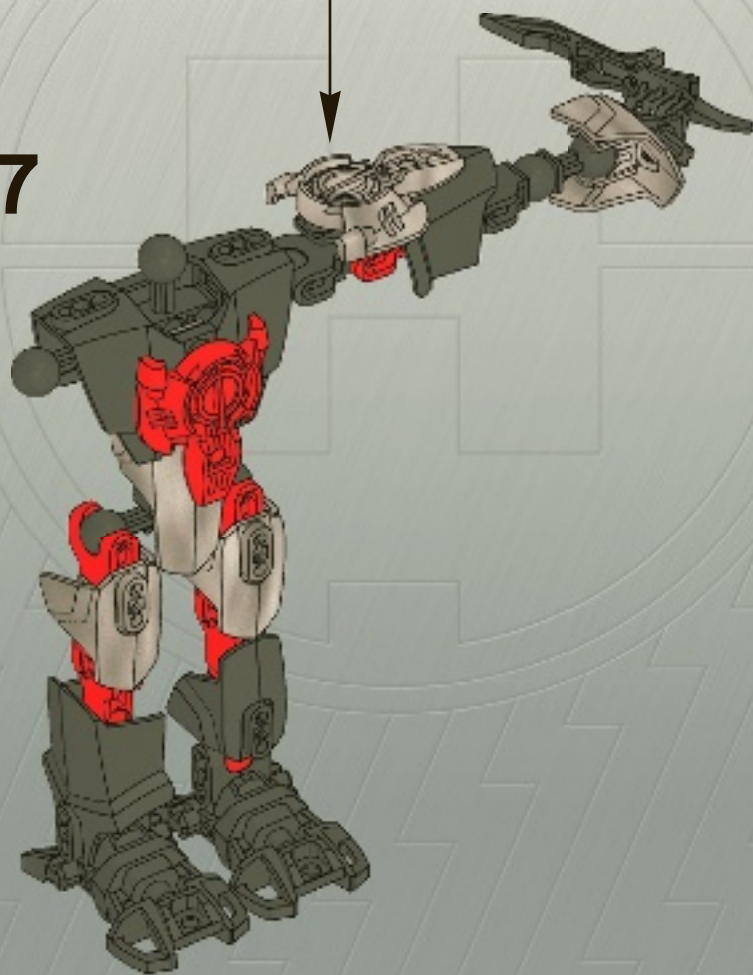



1



2

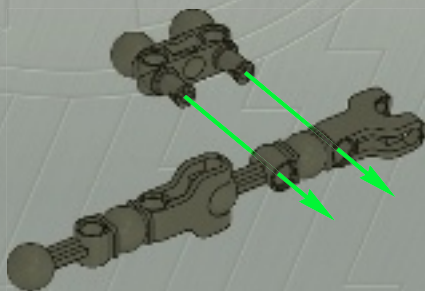



3

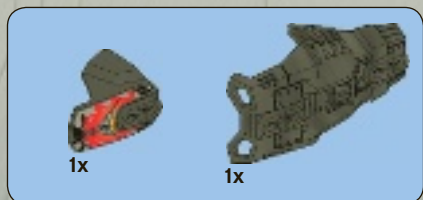
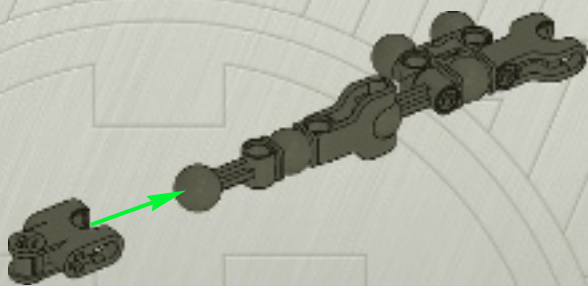

4

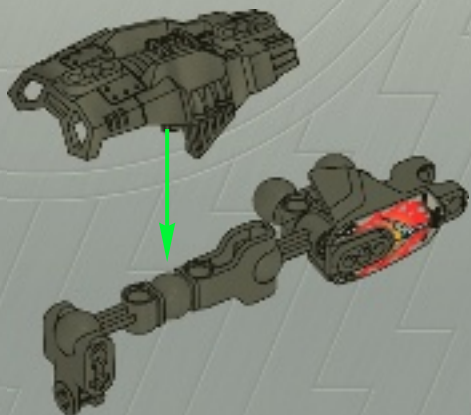



5

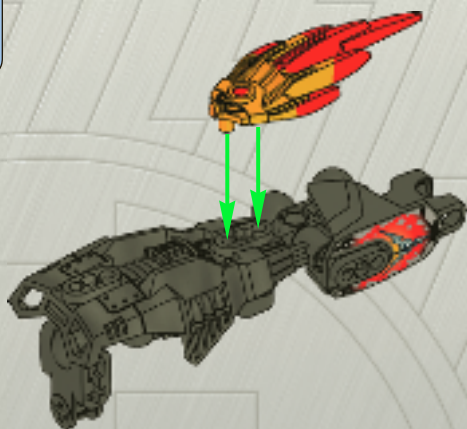

8

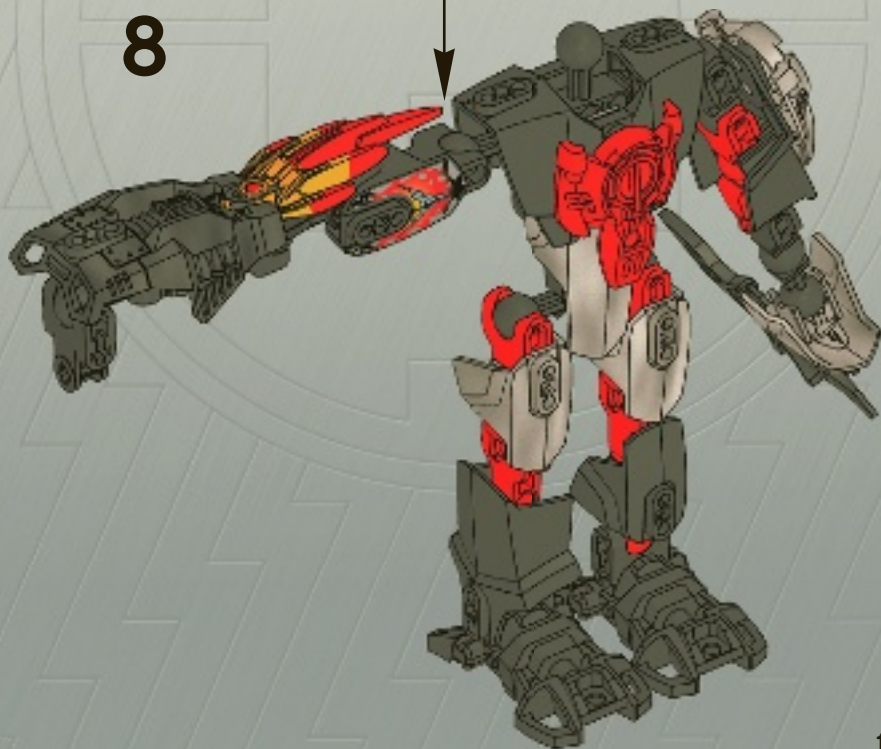



# 9

1



2



3



4





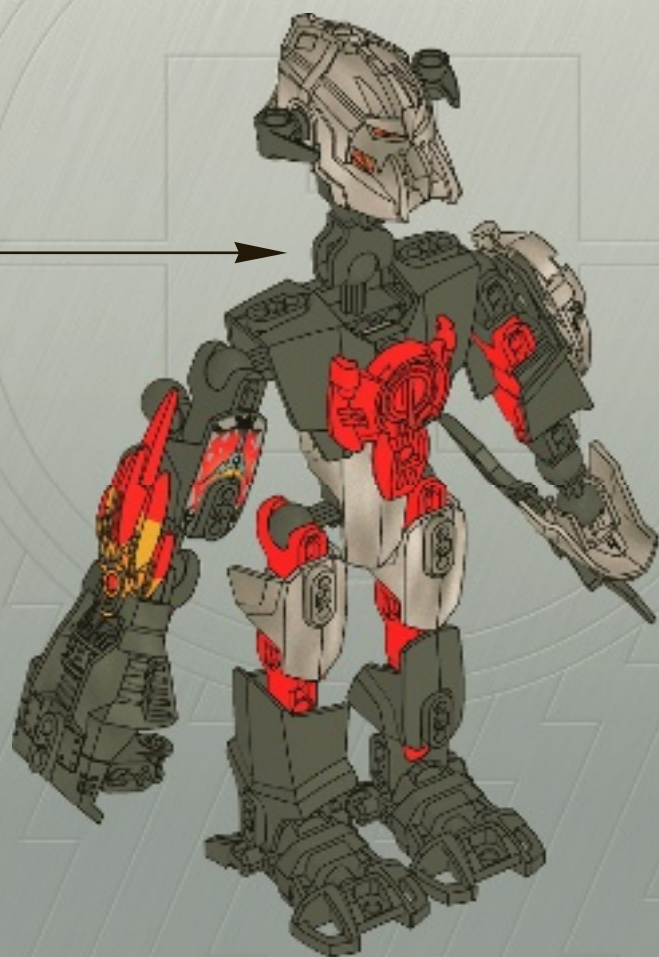

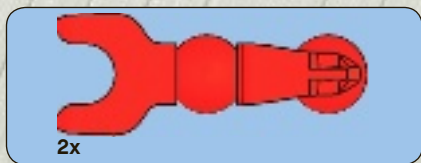

1

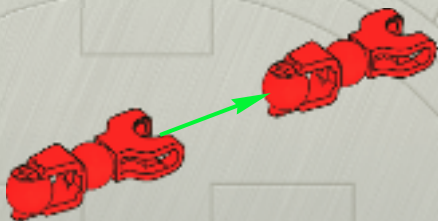

2

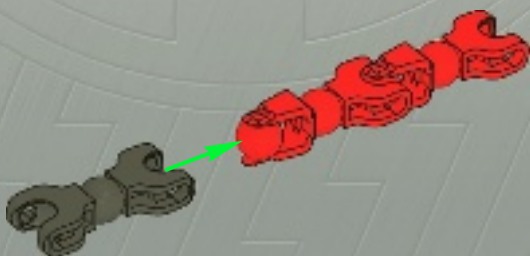



10

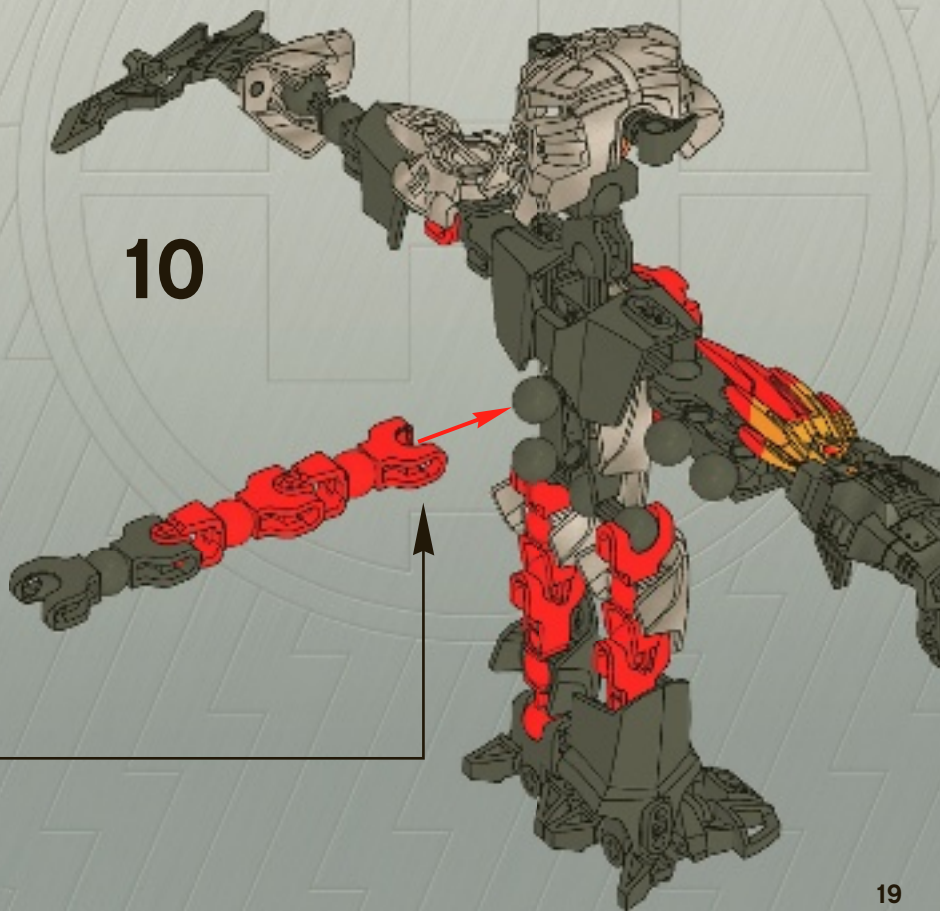



1

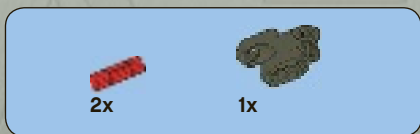
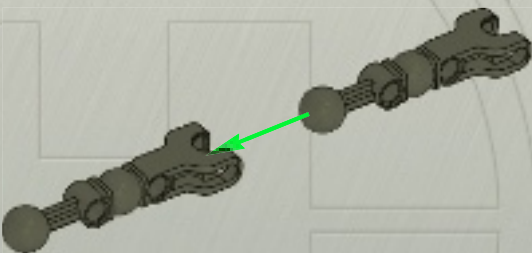

2

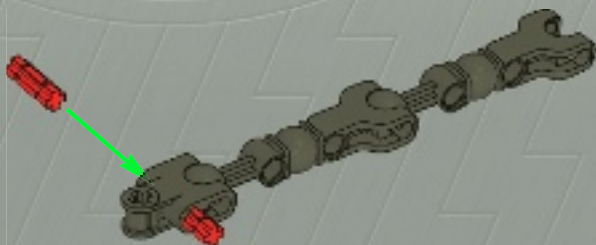



3

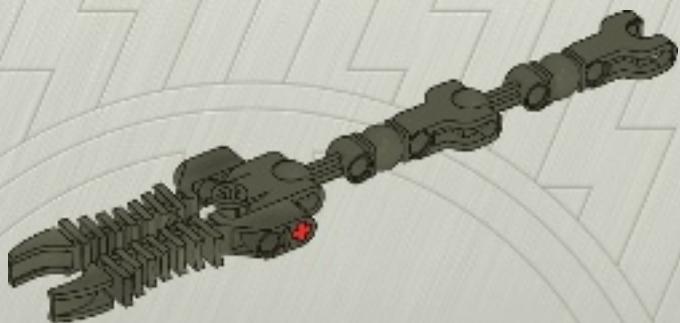

11

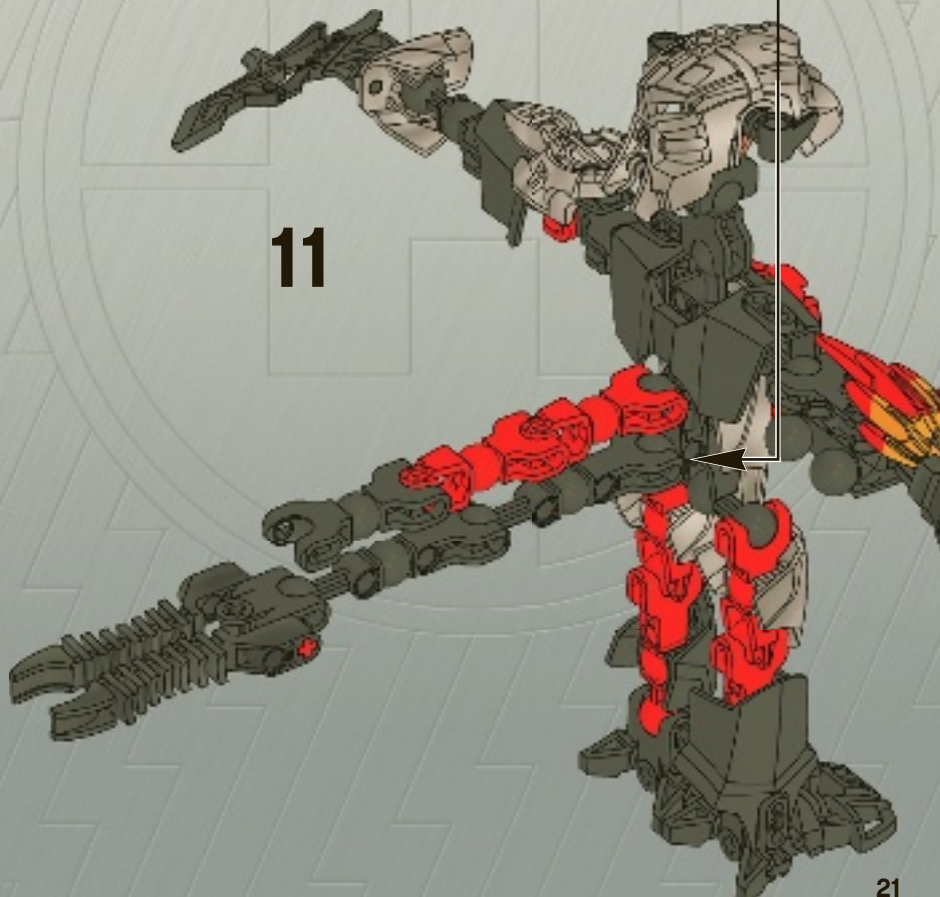



12

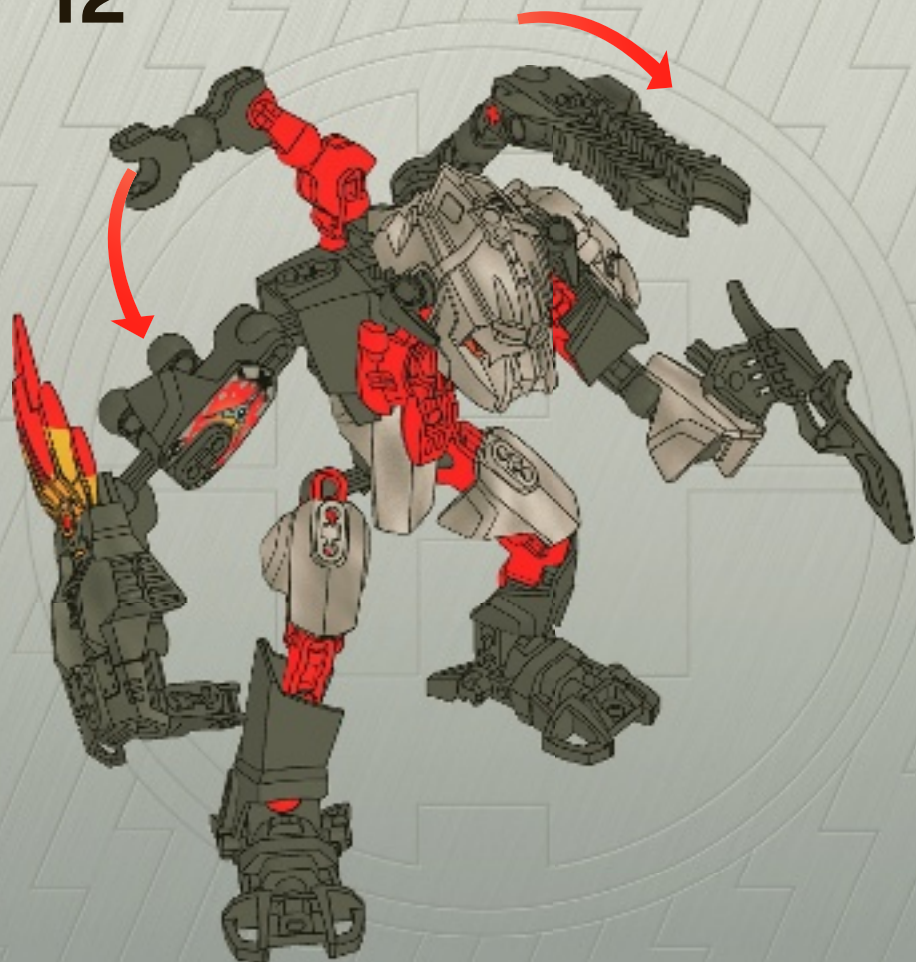



13

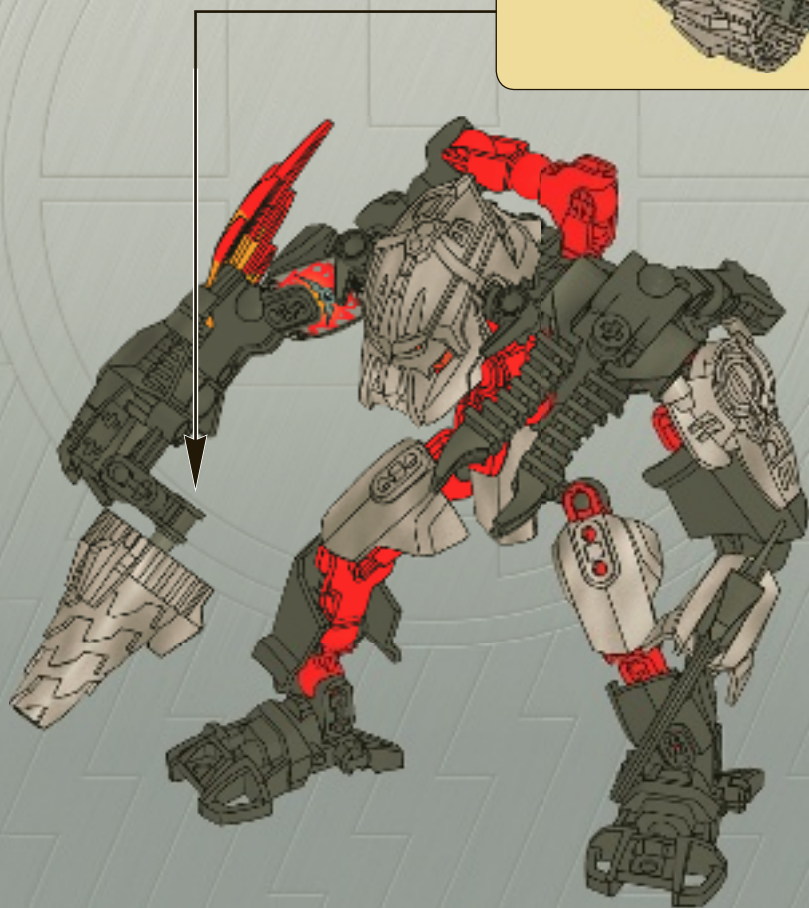
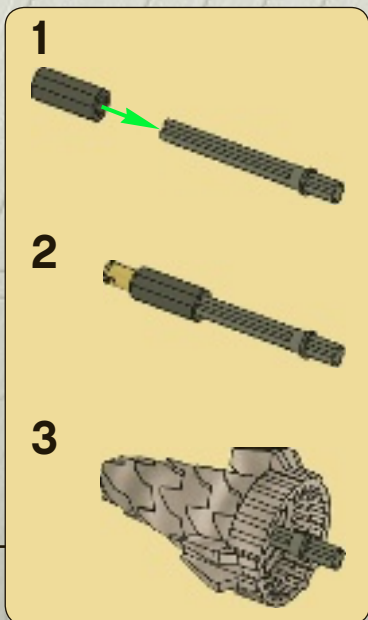



8x

14

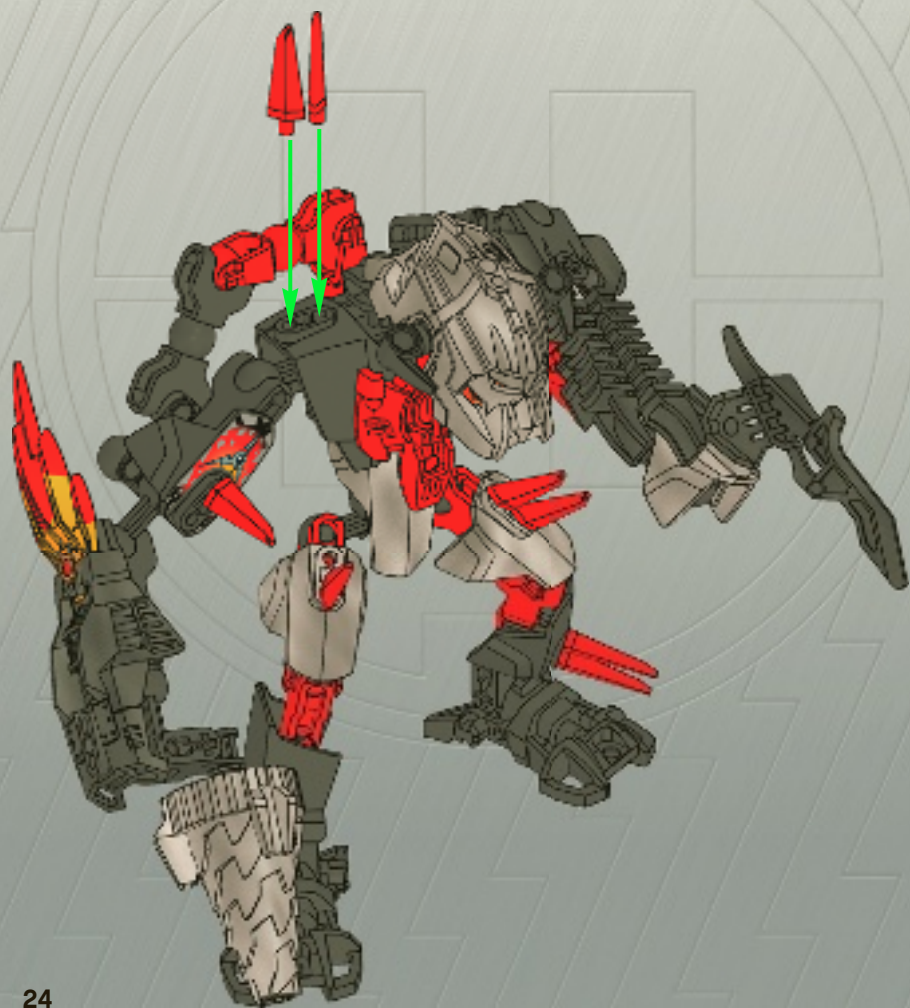





15

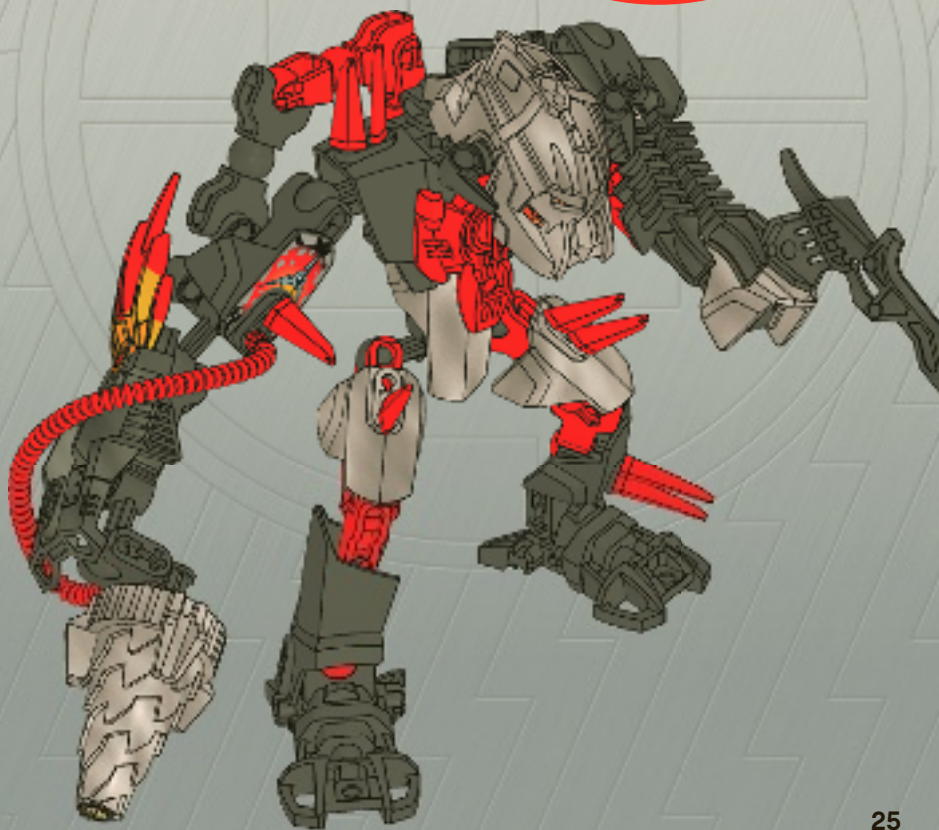
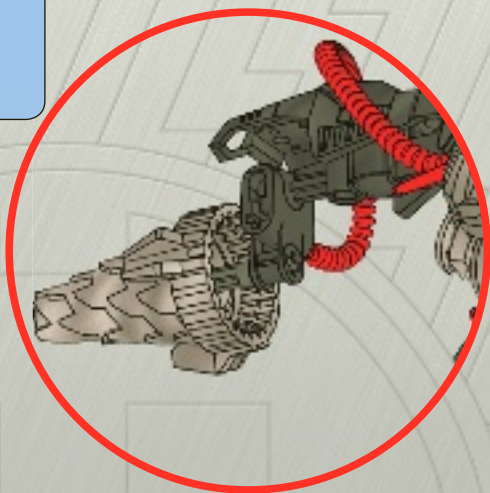



1x

# 16

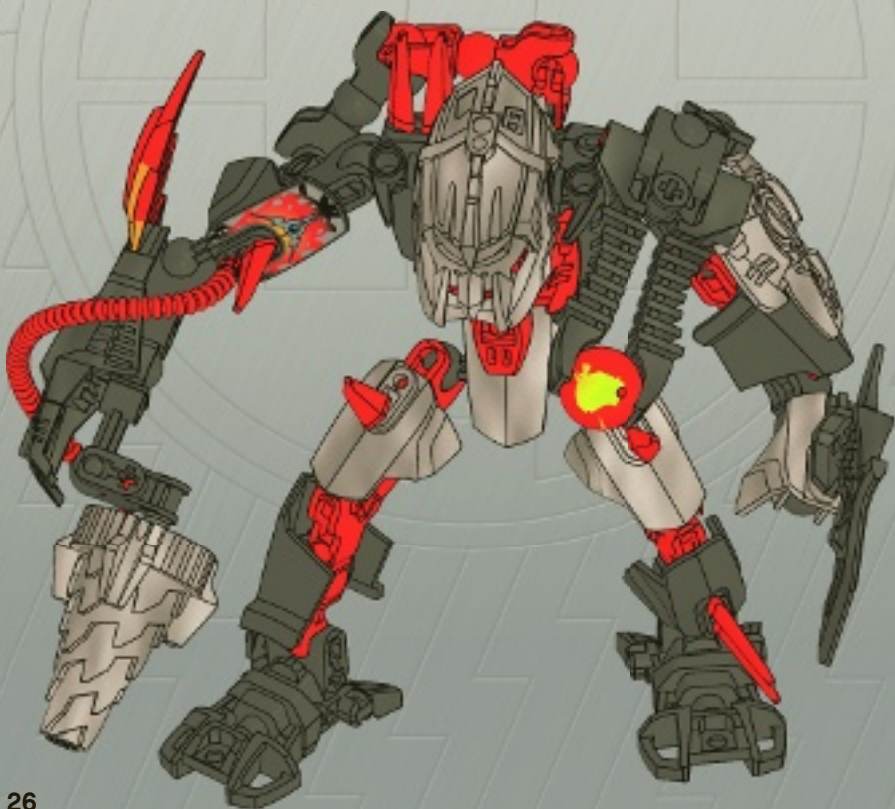
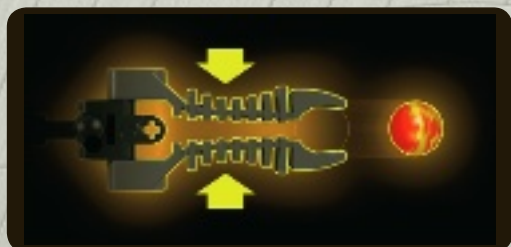

1x  
4512363

1x  
4540702

1x  
4508553

1x  
4186017

8x  
4616842

5x  
4603782

2x  
4611614

1x  
4622390

1x  
4591604

1x  
4591614

2x  
4142865

1x  
4609780

1x  
4612489

2x  
4609686

1x  
4609731

1x  
4591610

1x  
4614349

3x  
4632619

1x  
4632598

1x  
4609774

2x  
4593576

4x  
4610948

3x  
4593557

1x  
4593567

1x  
4593555

4x  
4593553

2x  
4612590

1x  
4632618

1x  
4632622

2x  
4609820

2x  
4565616

1x  
4610708

1x  
4593571

**Customer Service**

**Kundenservice**

**Service Consommateurs**

**Servicio Al Consumidor**

[www.lego.com/service](http://www.lego.com/service) or dial

				: 00800 5346 5555			
		: 1-800-422-5346					





**LEGO**

# HERO FACTORY



NATALIE BREEZ  
NATHAN EVO  
PRESTON STORMER

JULIUS NEX  
WILLIAM FURNO  
MARK SURGE

# HeroFactory.LEGO.com





# HERO RECON TEAM

 DESIGN by ME



[HeroFactory.LEGO.com](http://HeroFactory.LEGO.com)

**Coming spring 2011**

DE: Ab frühling 2011, FR/FRCA: Sortie au printemps 2011,

ES/ESSA: Disponible en primavera de 2011,

PT: Próxima primavera 2011, HU: 2011 tavaszán érkezik.



www.LEGOclub.com

**LEGO club**™

**FREE! GRATIS! GRATUIT!**



LEGO® Club Magazine



LEGO® Club Email

**SIGN UP ONLINE!**  
**www.LEGOclub.com**

VISIT THE WORLD'S  
BIGGEST LEGO® SHOP!  
**www.LEGOshop.com**

00800 5346 5555

 1-866-534-6258 • 1-877-518-5346

USA & Canada only

EUROPE



\* Freephone. Mobile charges may apply. \* Numéro sans frais. Des frais peuvent s'appliquer avec les téléphones cellulaires. \* Gebührenfrei, Kosten für Anrufe aus Mobilfunknetzen können abweichen. \* Gratis telefoonnummer vanaf vaste lijn. \* Det er et gratis nummer, når du ringer fra fasttelefon. \* Det är gratis, när du ringer från en fast telefon. \* Numéro sans frais. Des frais peuvent s'appliquer avec les téléphones portables.

B1112



# WIN!

Go to [www.LEGOsurvey.com/product](http://www.LEGOsurvey.com/product) to fill out a survey for a chance to win a cool LEGO® Product.

No purchase necessary.

Open to all residents where not prohibited.



[www.LEGO.com](http://www.LEGO.com)



## [www.LEGOsurvey.com/product](http://www.LEGOsurvey.com/product)

### GEWINNE!

Nimm an der Umfrage auf [www.LEGOsurvey.com/product](http://www.LEGOsurvey.com/product) teil und hab die Chance ein cooles LEGO® Produkt zu gewinnen!

Die Teilnahme am Gewinnspiel führt zu keinerlei Kaufverpflichtungen. Teilnahme in allen nicht ausgeschlossenen Ländern möglich.

4620948

### WIN!

Ga naar [www.LEGOsurvey.com/product](http://www.LEGOsurvey.com/product), vul een enquêteformulier in en maak kans op een cool LEGO® product.

Geen aankoopverplichting. Iedereen mag deelnemen, uitgezonderd ingezetenden van landen waar een enquêteverbod geldt.

### GAGNE!

Visite [www.LEGOsurvey.com/product](http://www.LEGOsurvey.com/product) pour répondre à un questionnaire et avoir une chance de gagner un produit LEGO® très cool!

Aucune obligation d'achat. Ouvert à tous les résidents des pays autorisés.

### 当てよう!

[www.LEGOsurvey.com/product](http://www.LEGOsurvey.com/product) にアクセスして、アンケートにご記入ください。当選者にはレゴ®製品を差し上げます。

お買い上げの必要はありません。禁止されていない限り、すべての皆様にご利用いただけます。