

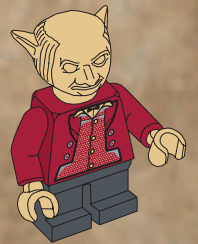

Harry Potter™

4714

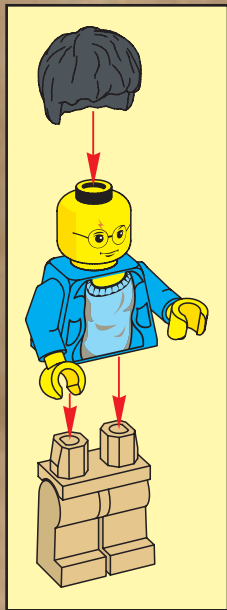

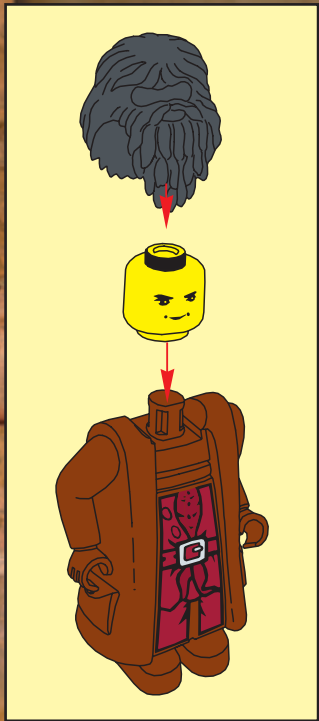



1

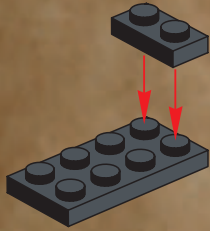

2

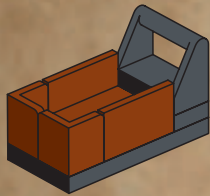

3

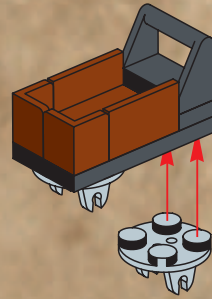

4

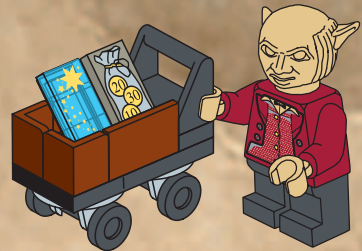



1

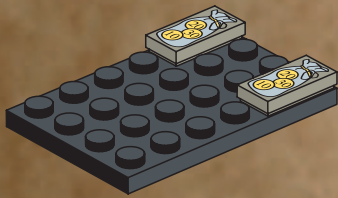

2

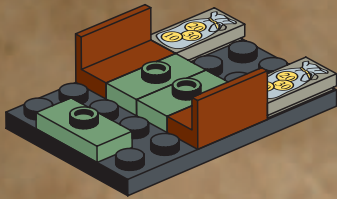

3

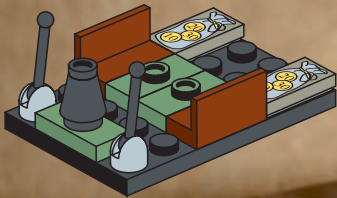

4

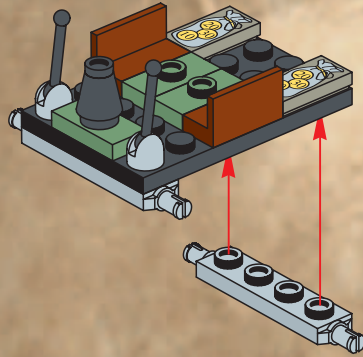

5

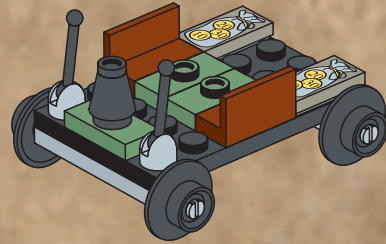

6



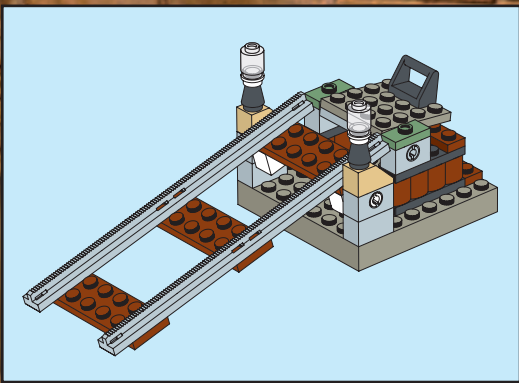

1

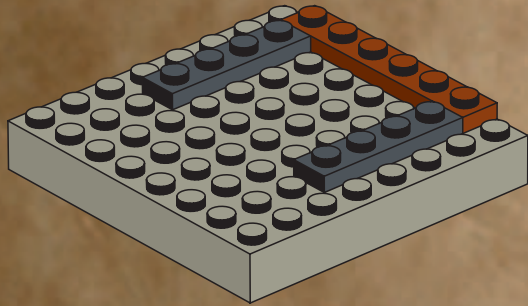

2

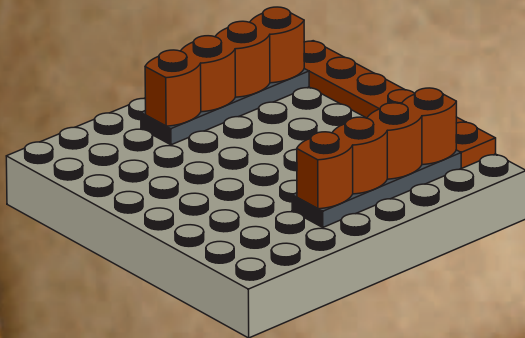

3

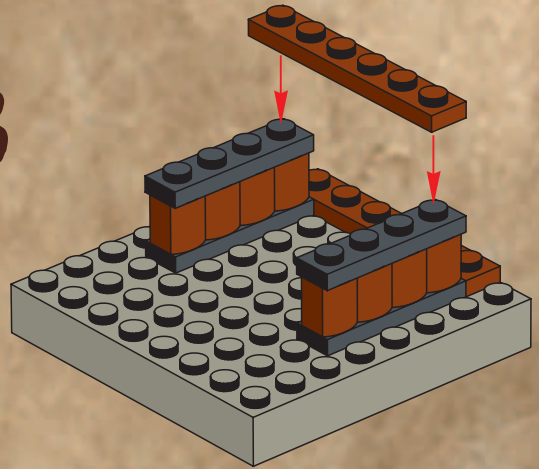

4

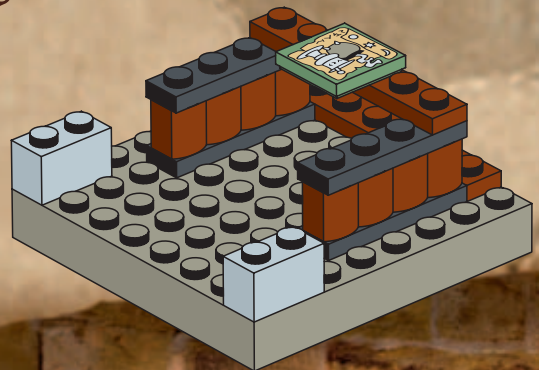

1

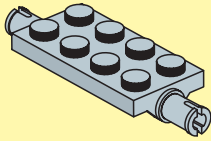

2

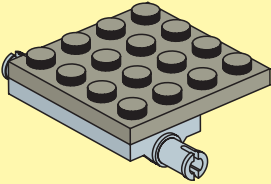

3

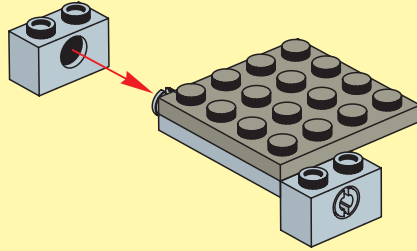

4

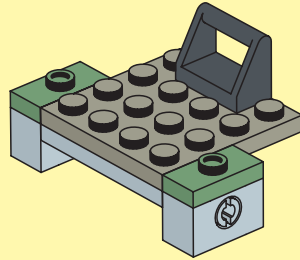

5

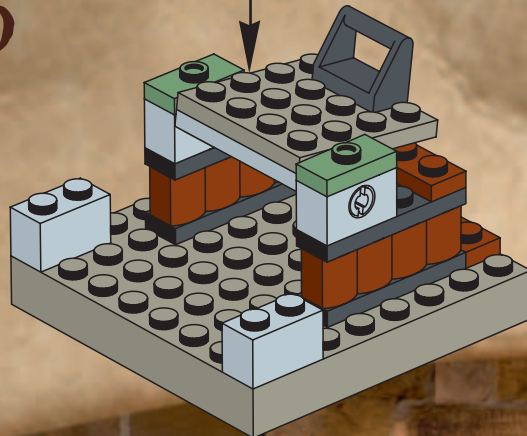

1

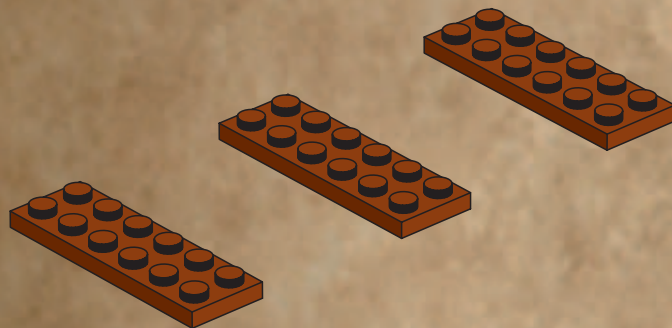

2

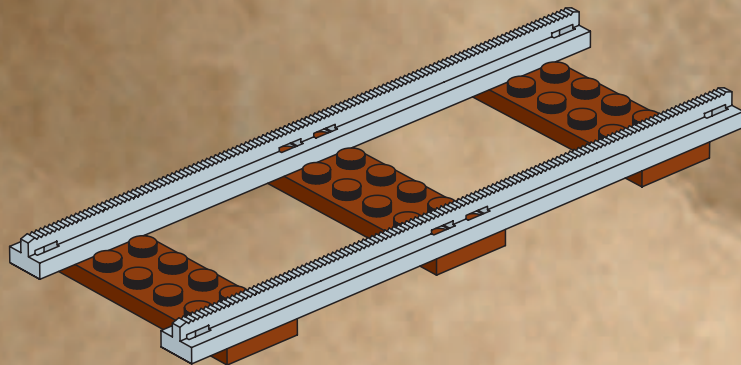

3

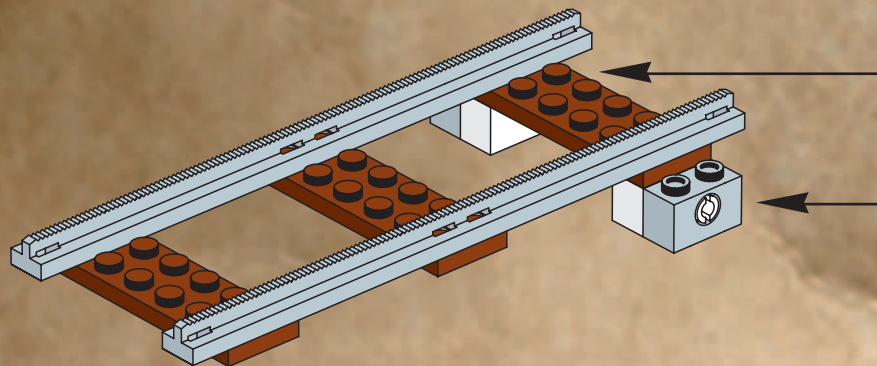
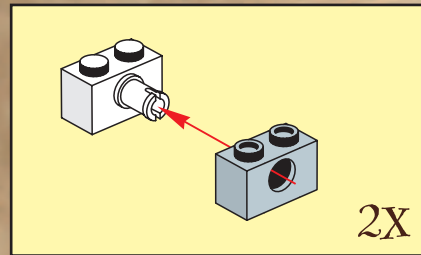

6

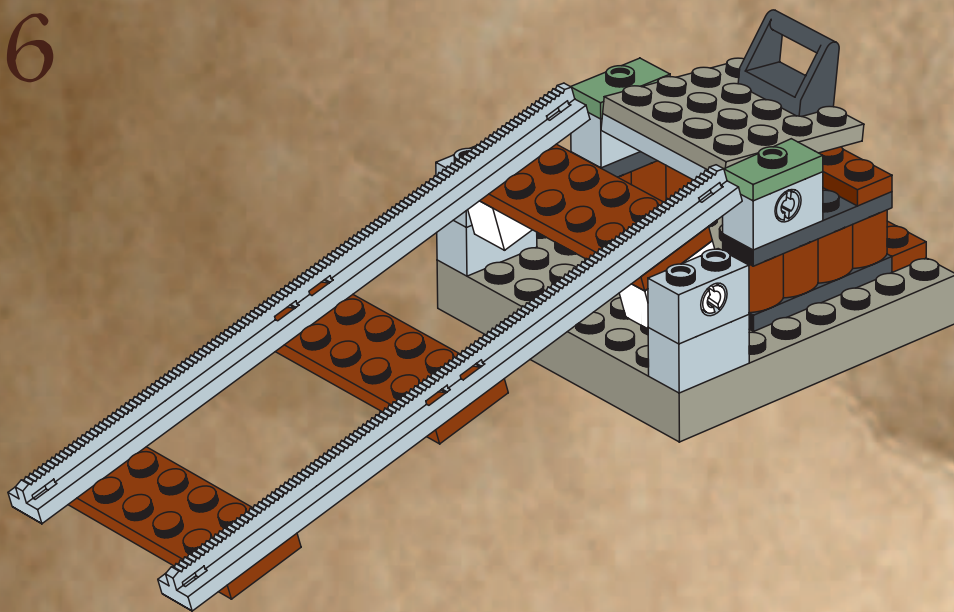

7

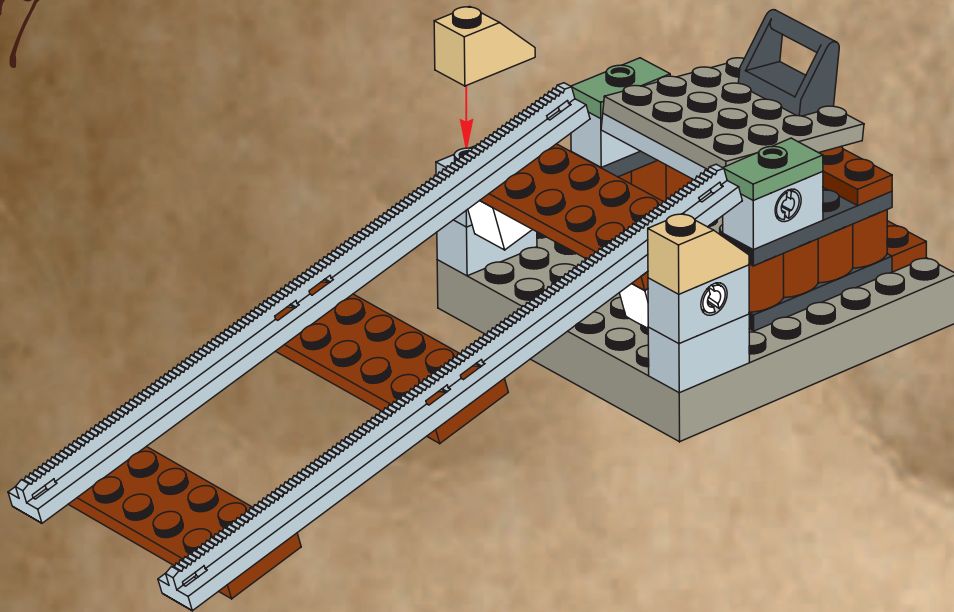

8

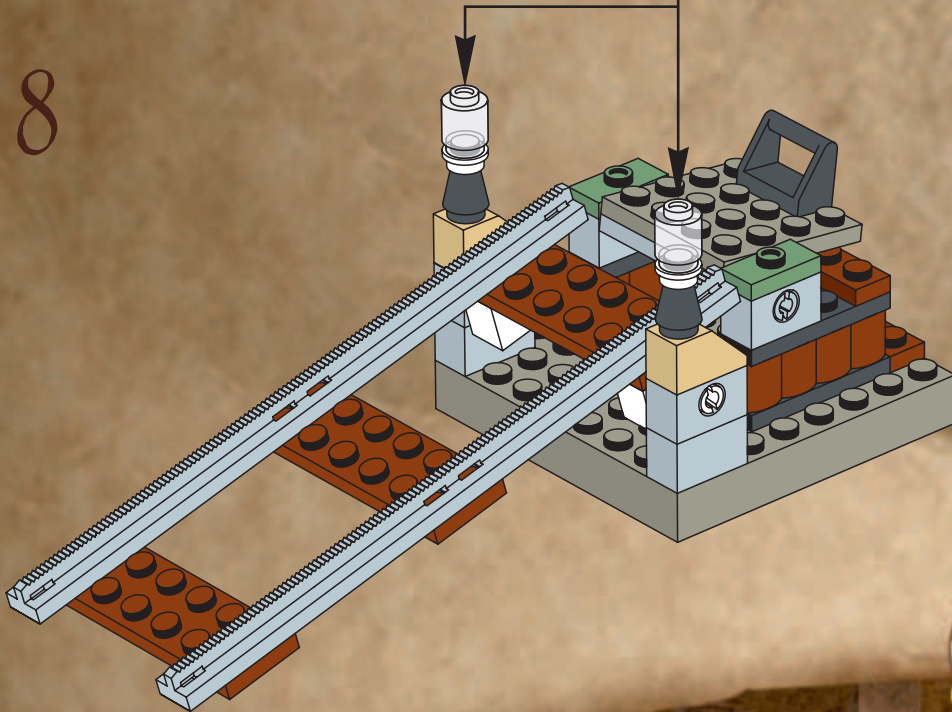
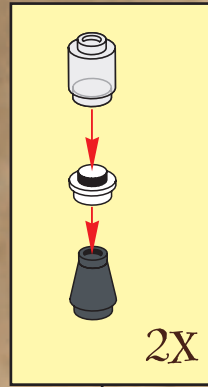

11



1

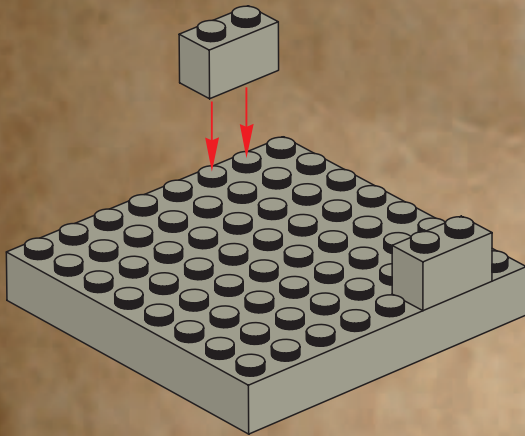

2

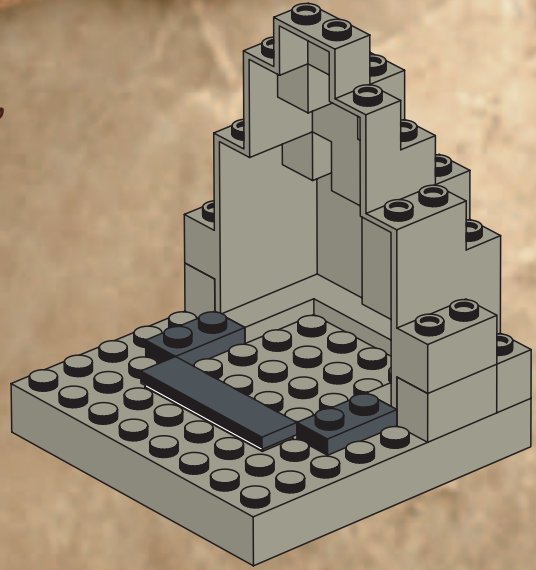

3

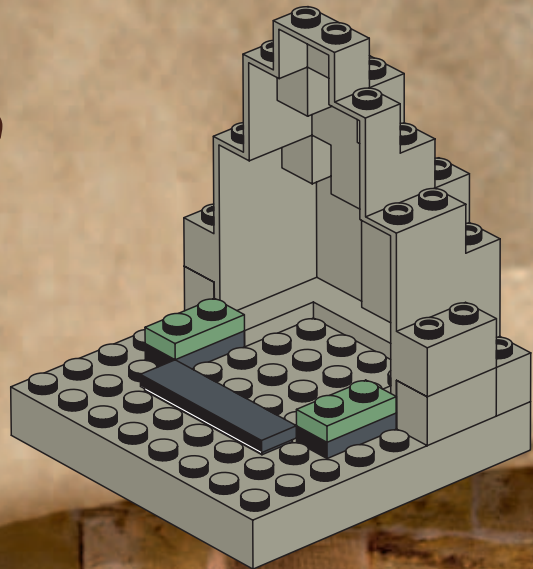

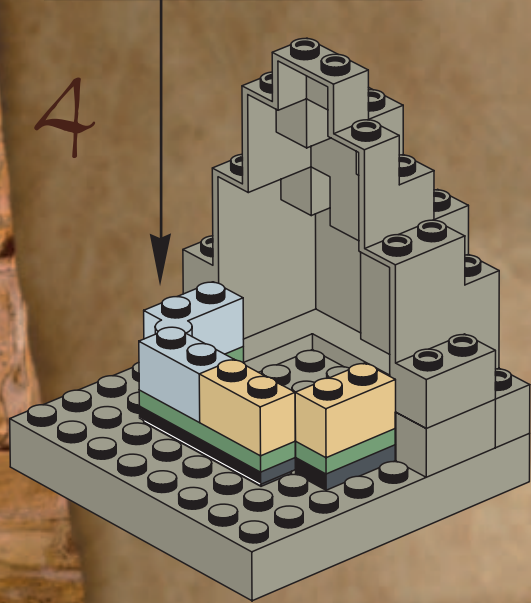
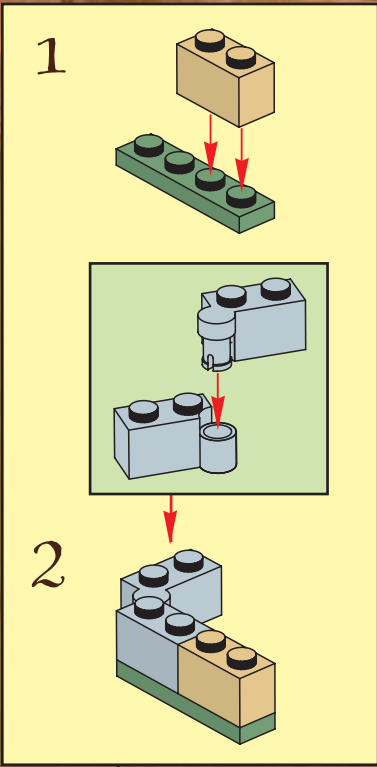

5

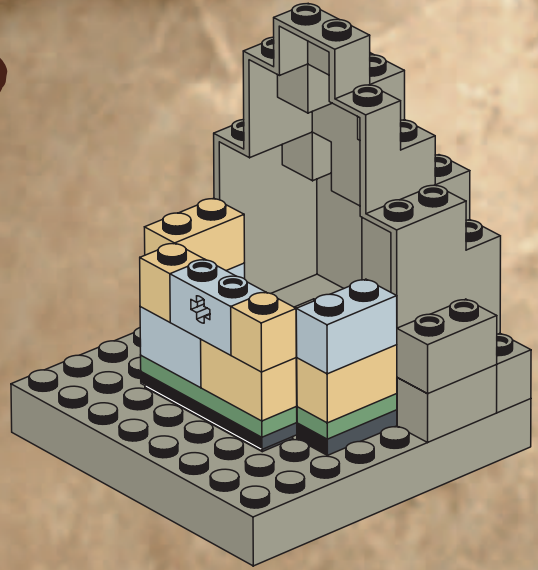

6

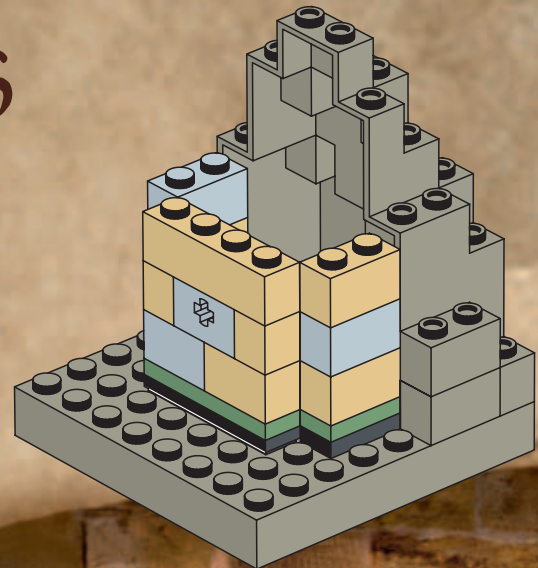

7

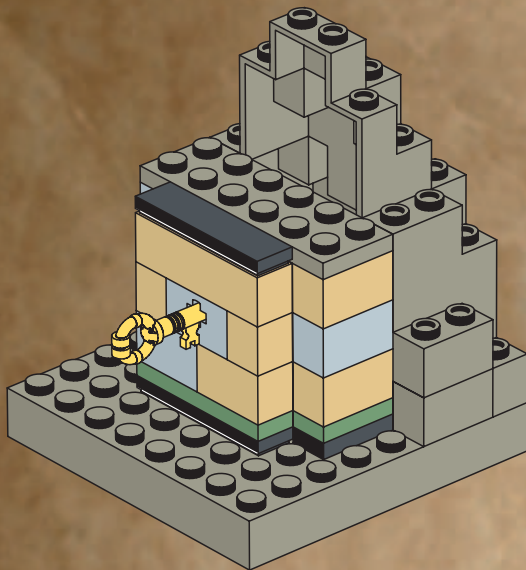

8

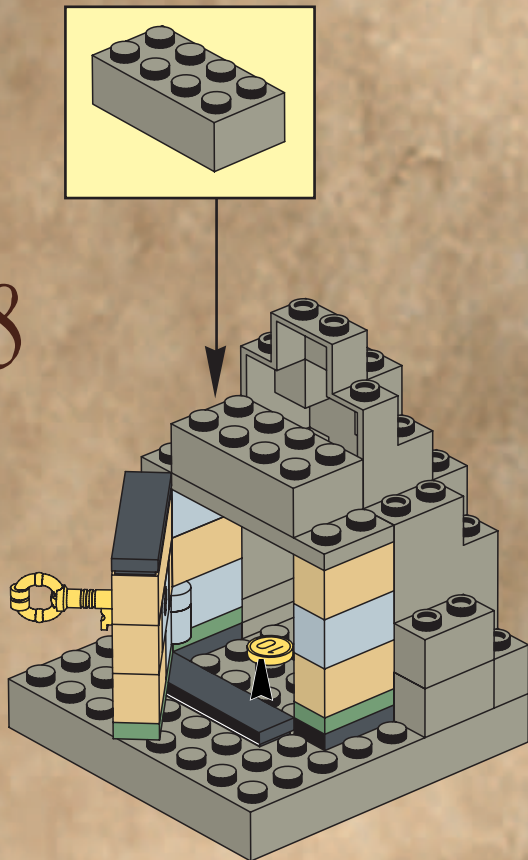

9

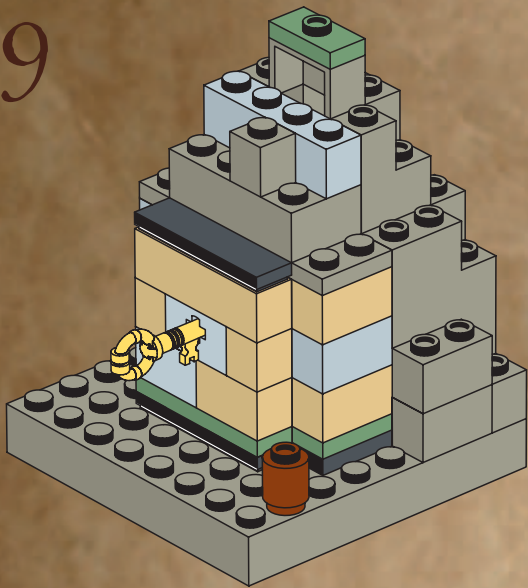

10

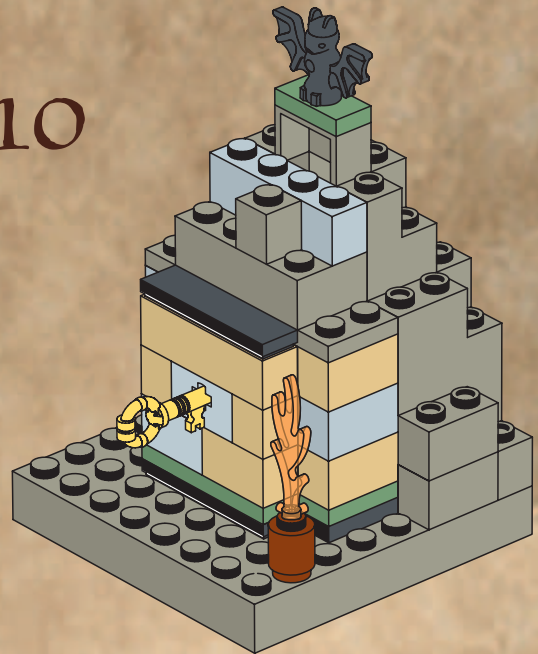

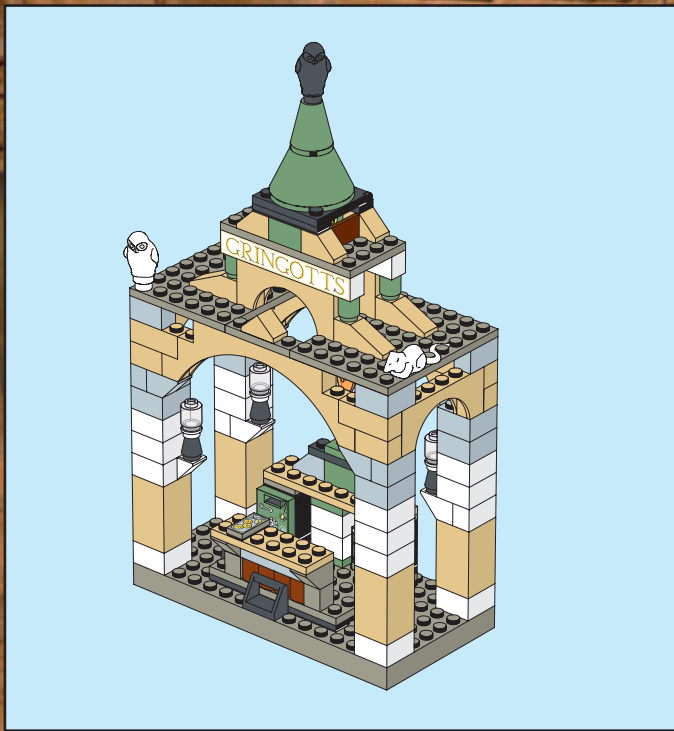

1

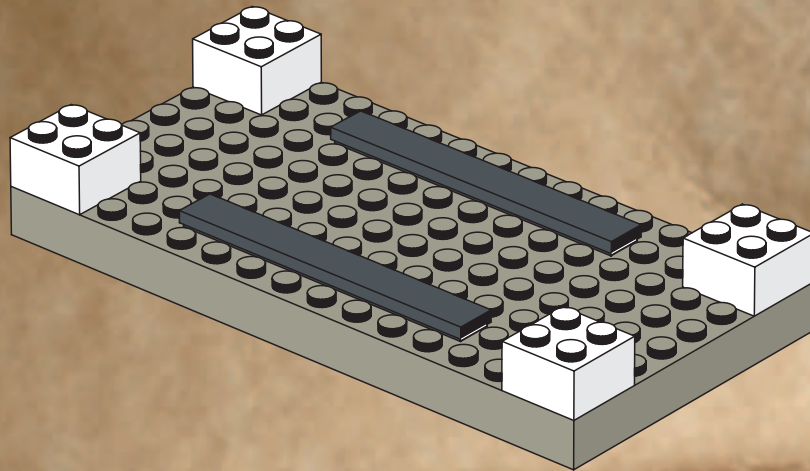

2

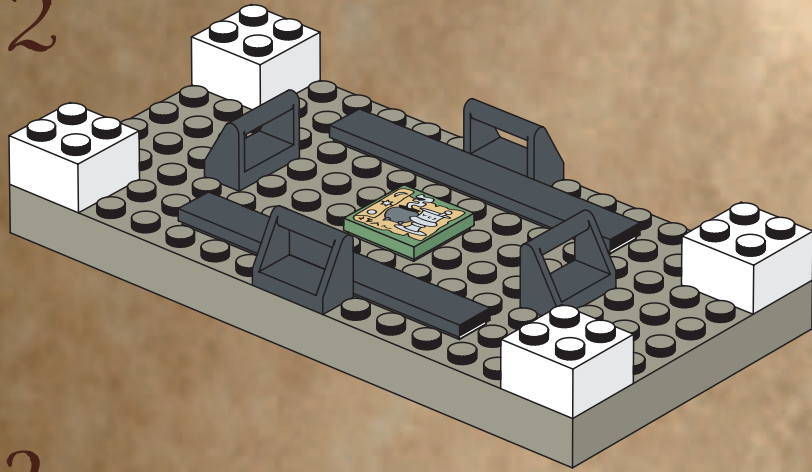

3

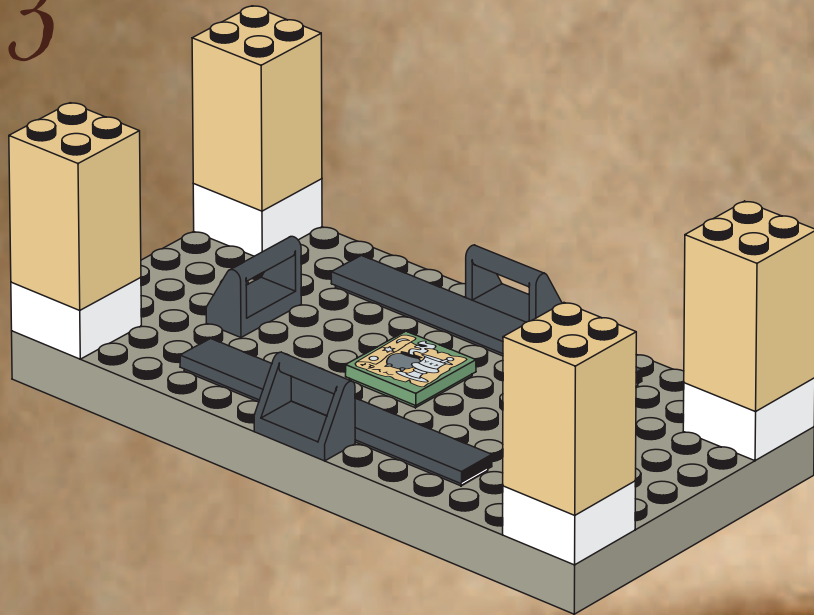

4

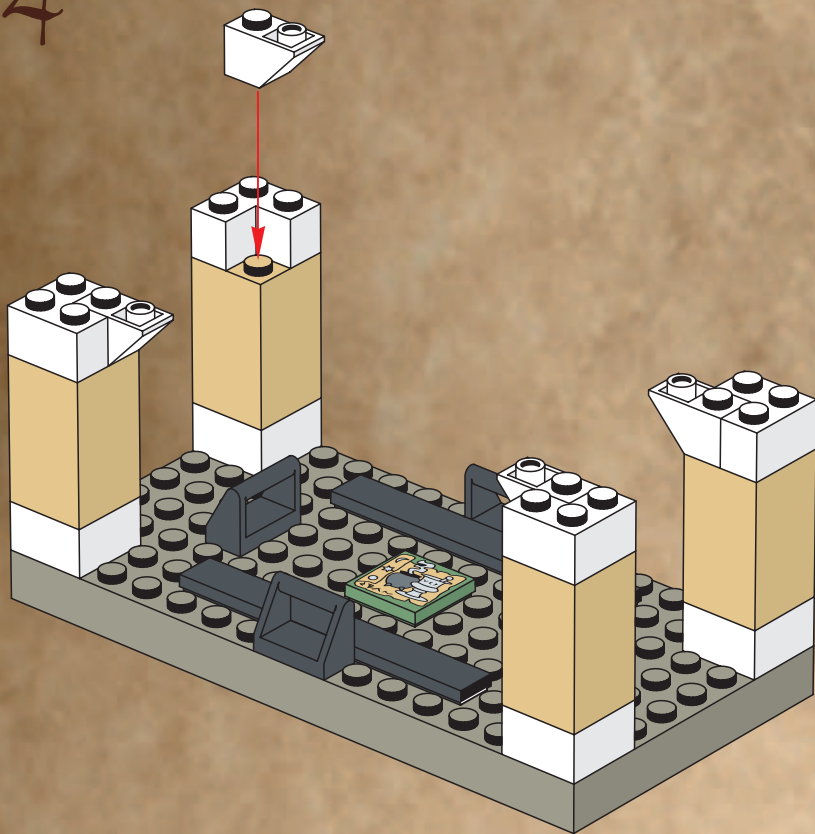

5

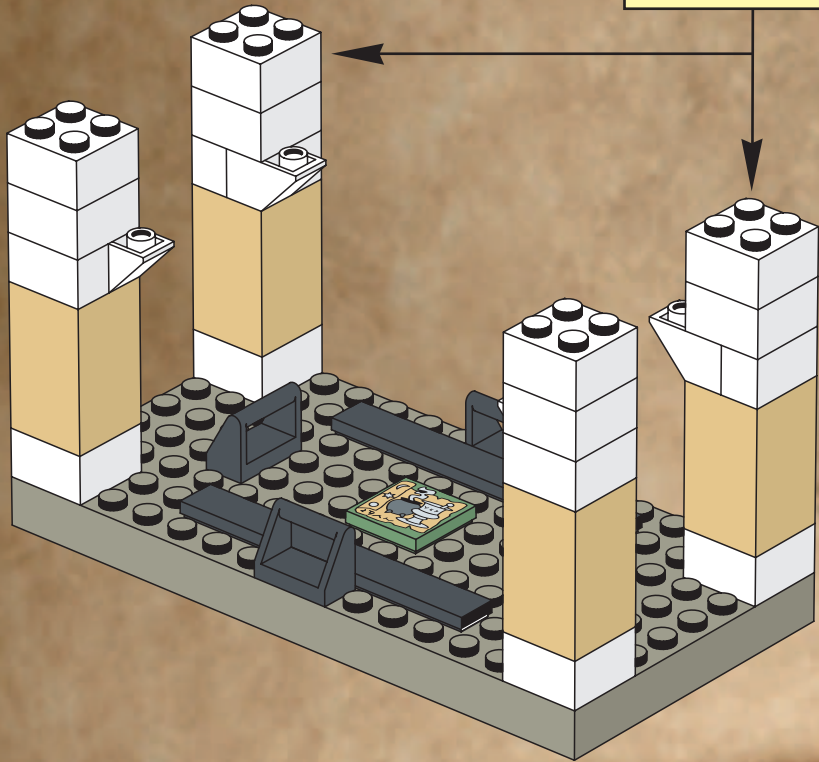
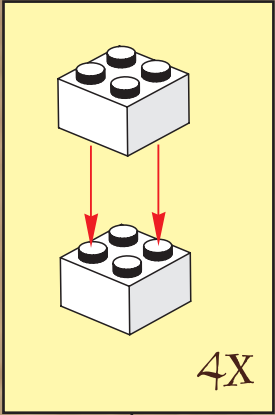

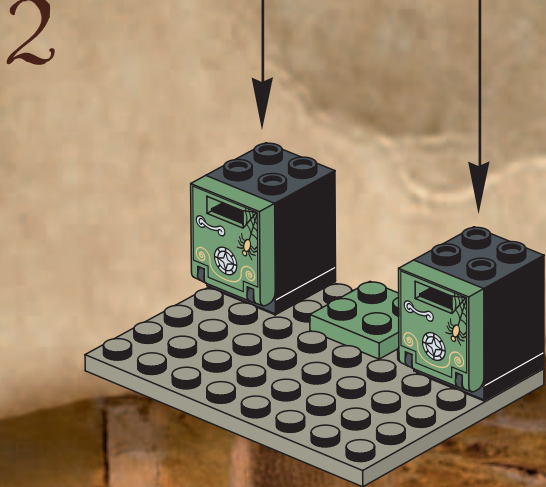
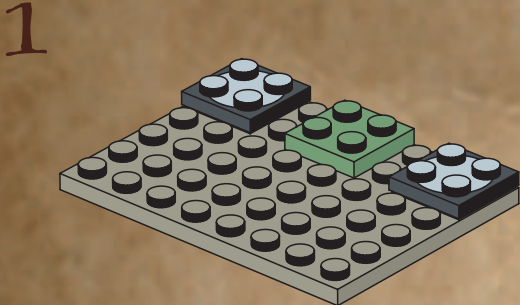
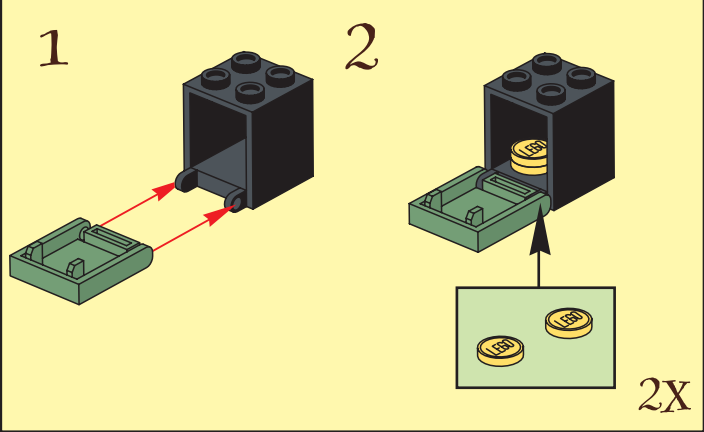

3

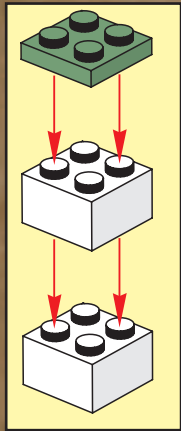
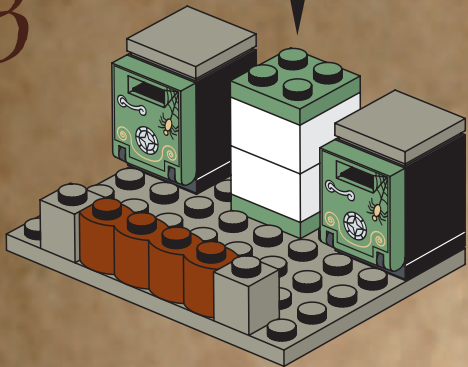

4

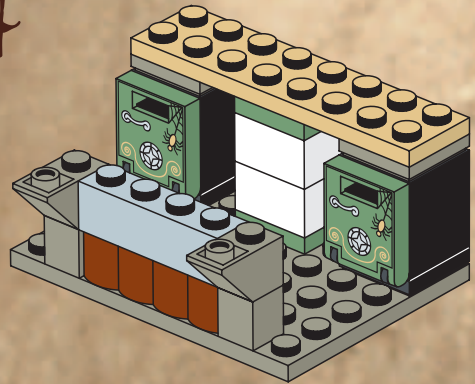

5

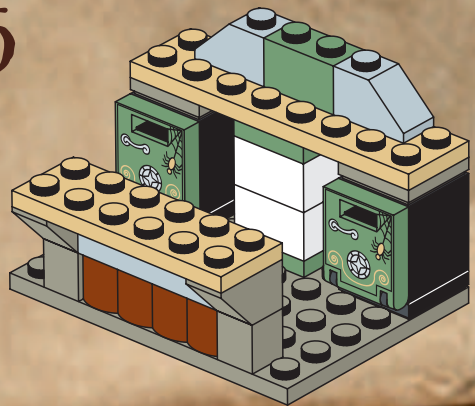

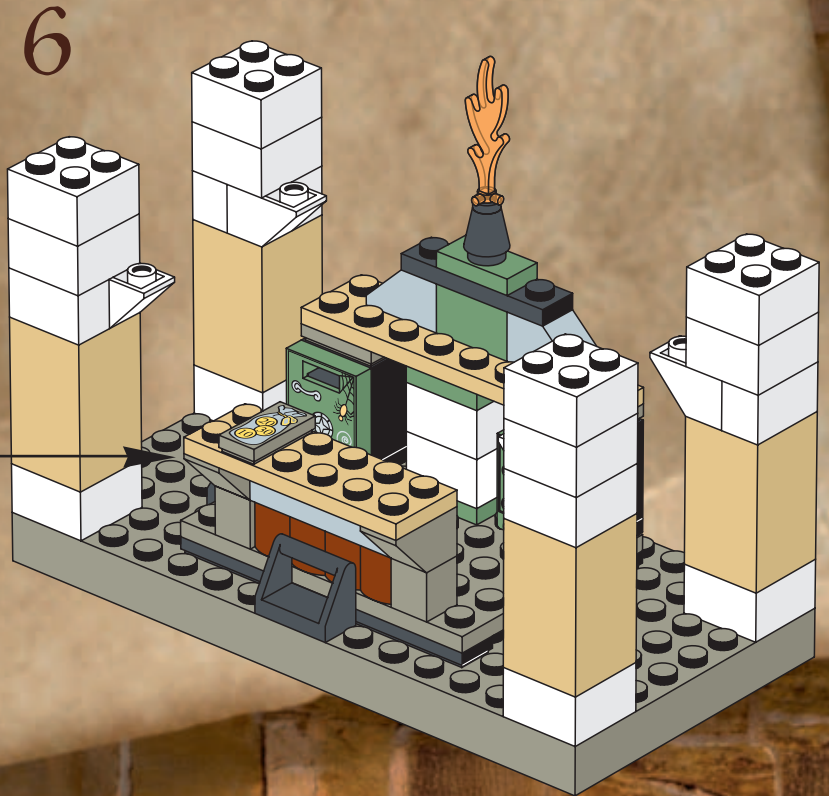
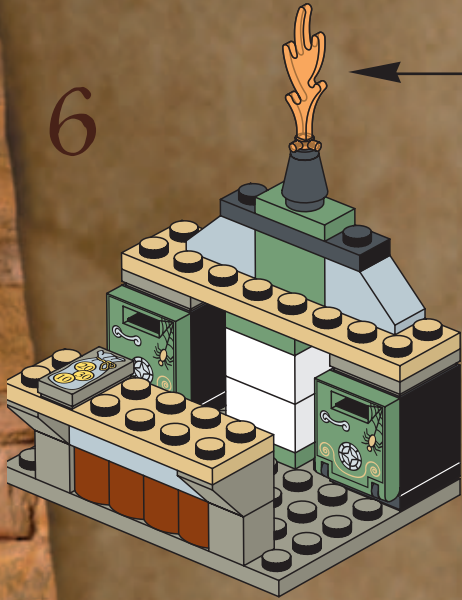
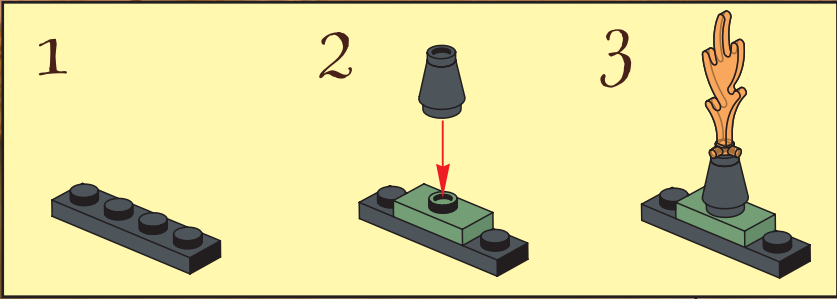

7

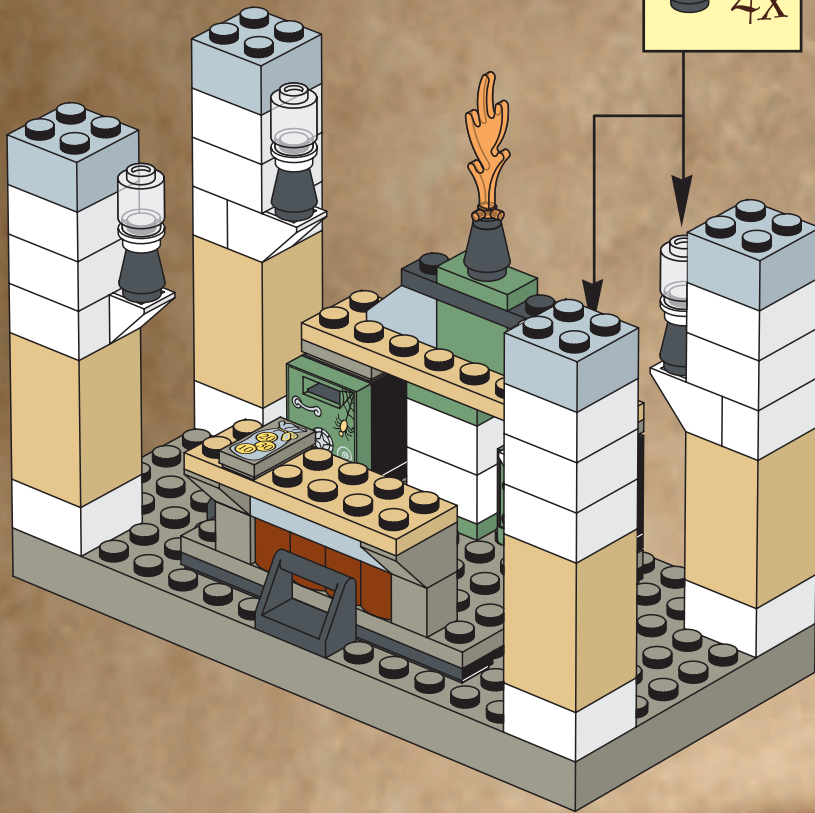

8

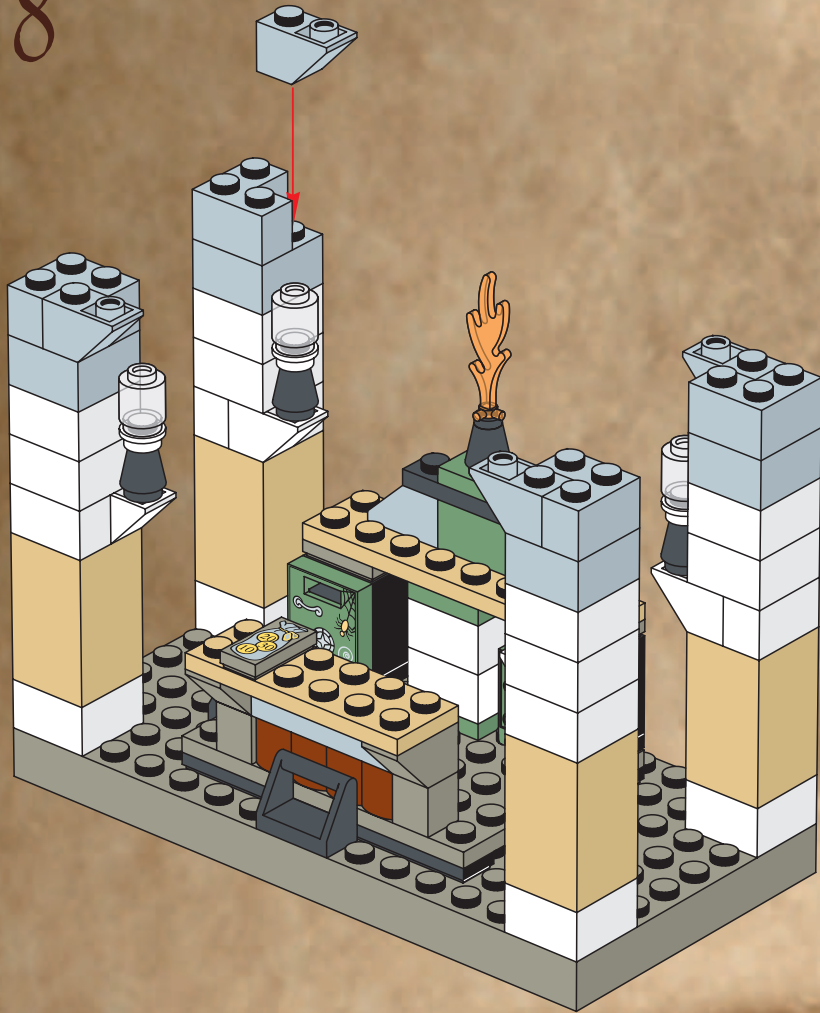

9

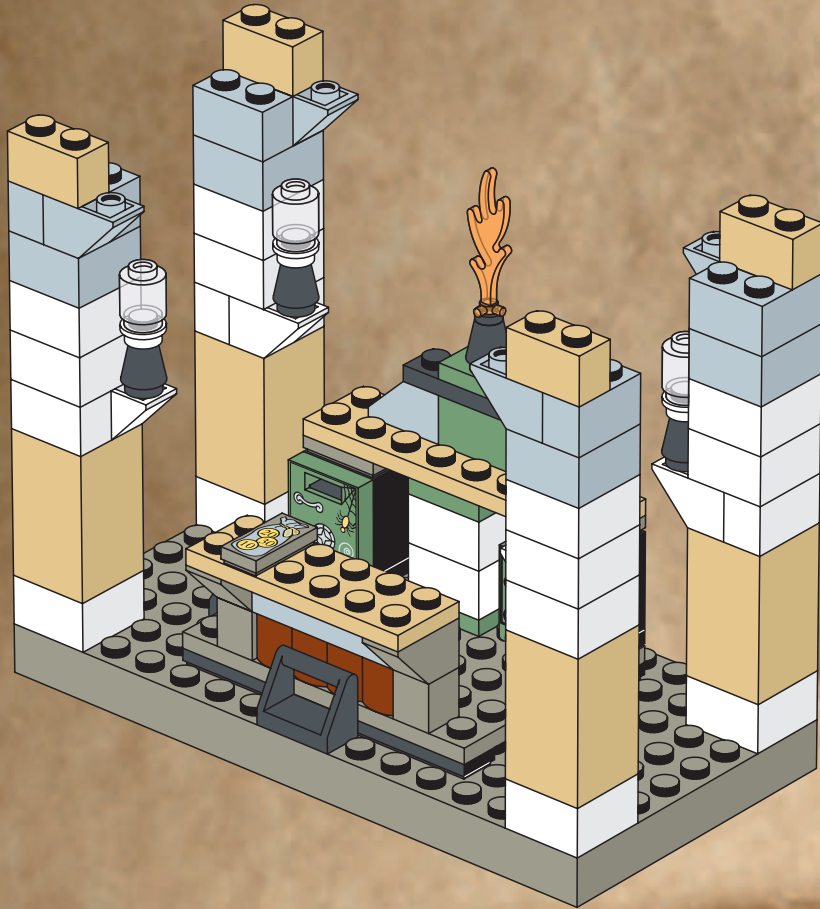

10

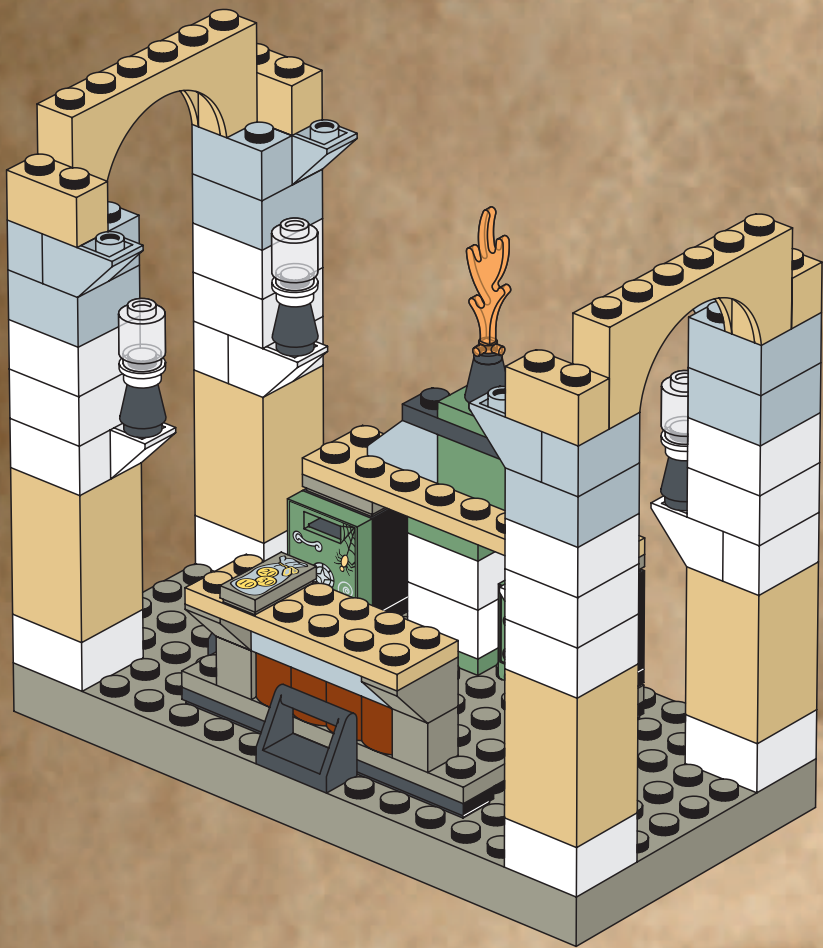

26

11

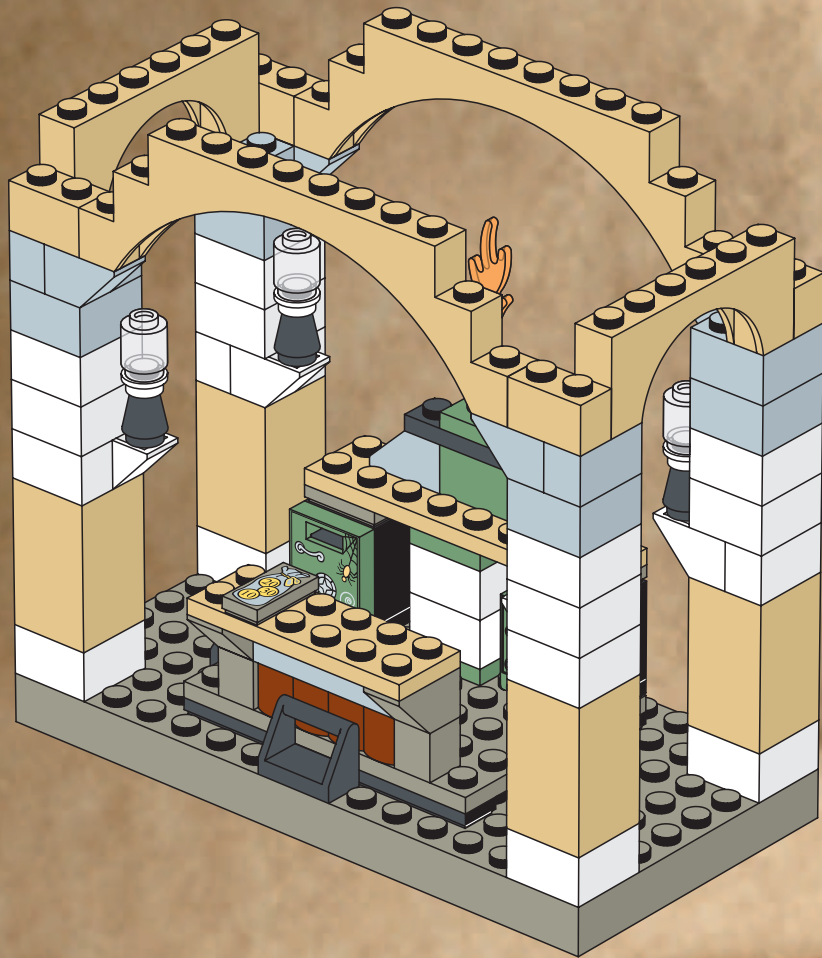

12

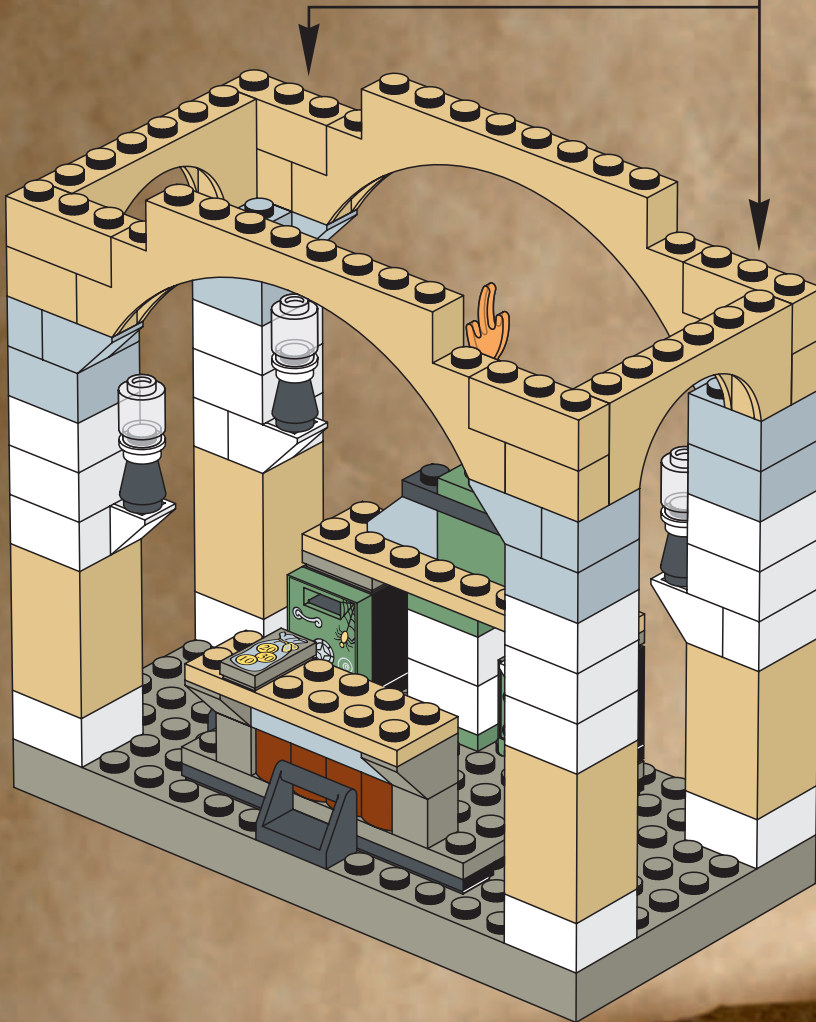
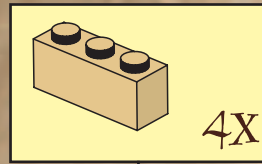

14

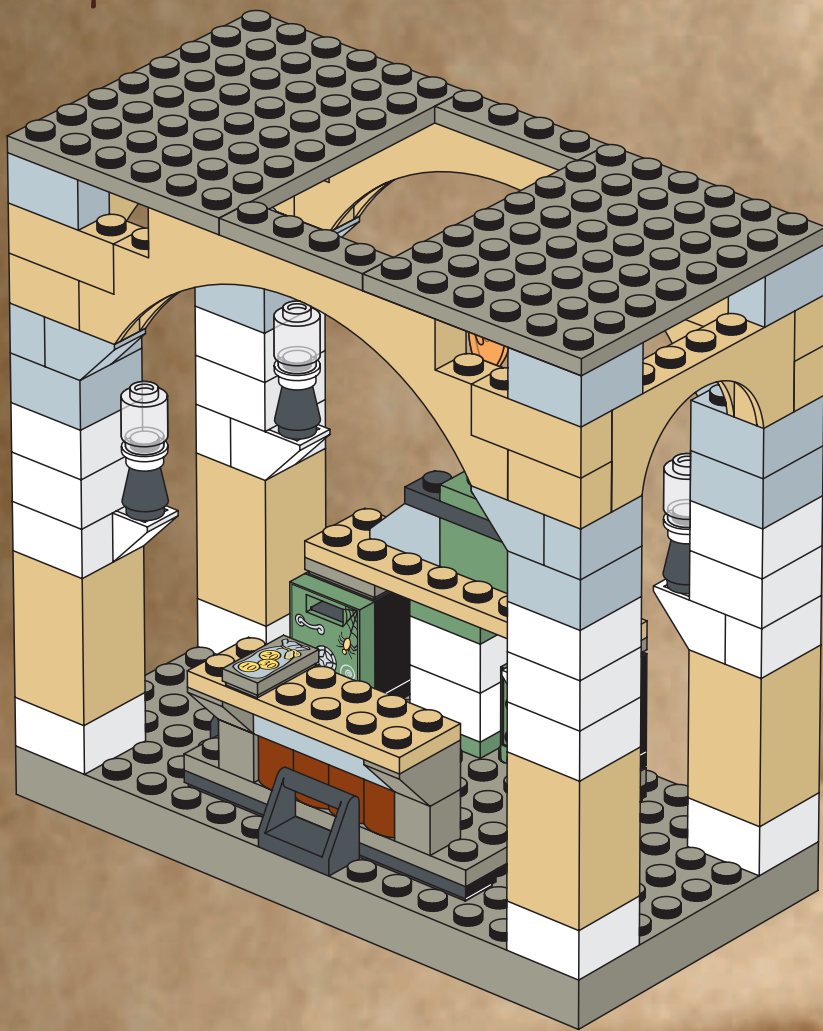

15

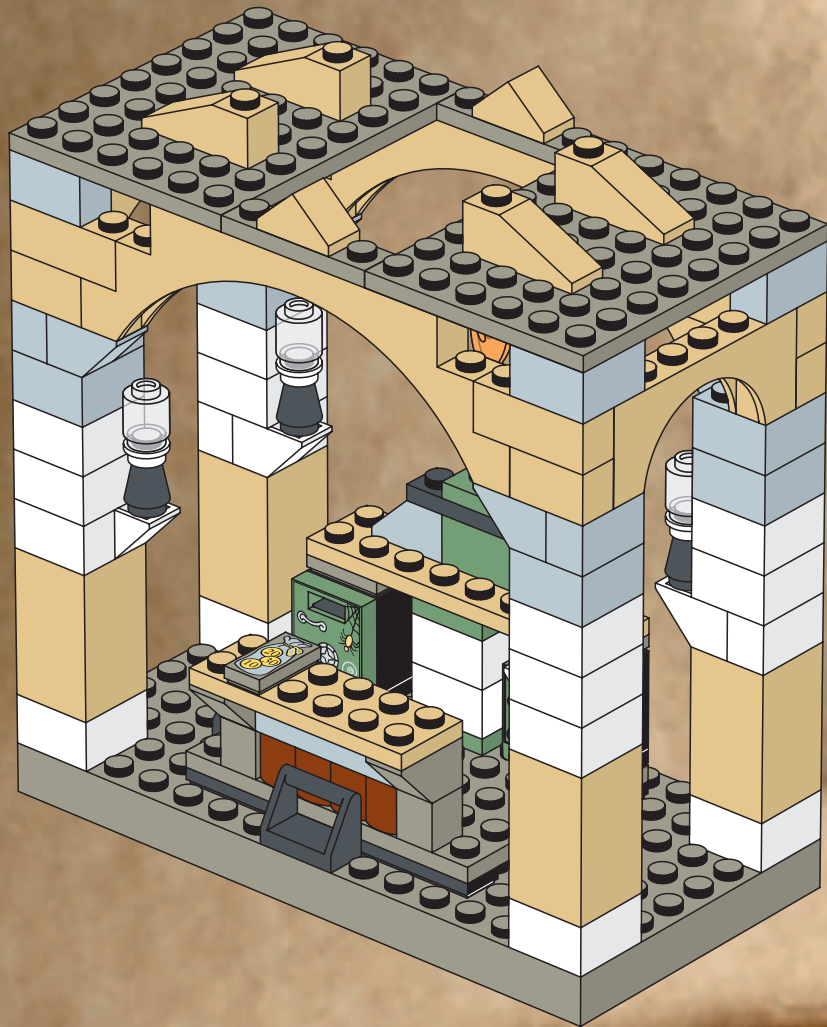

16

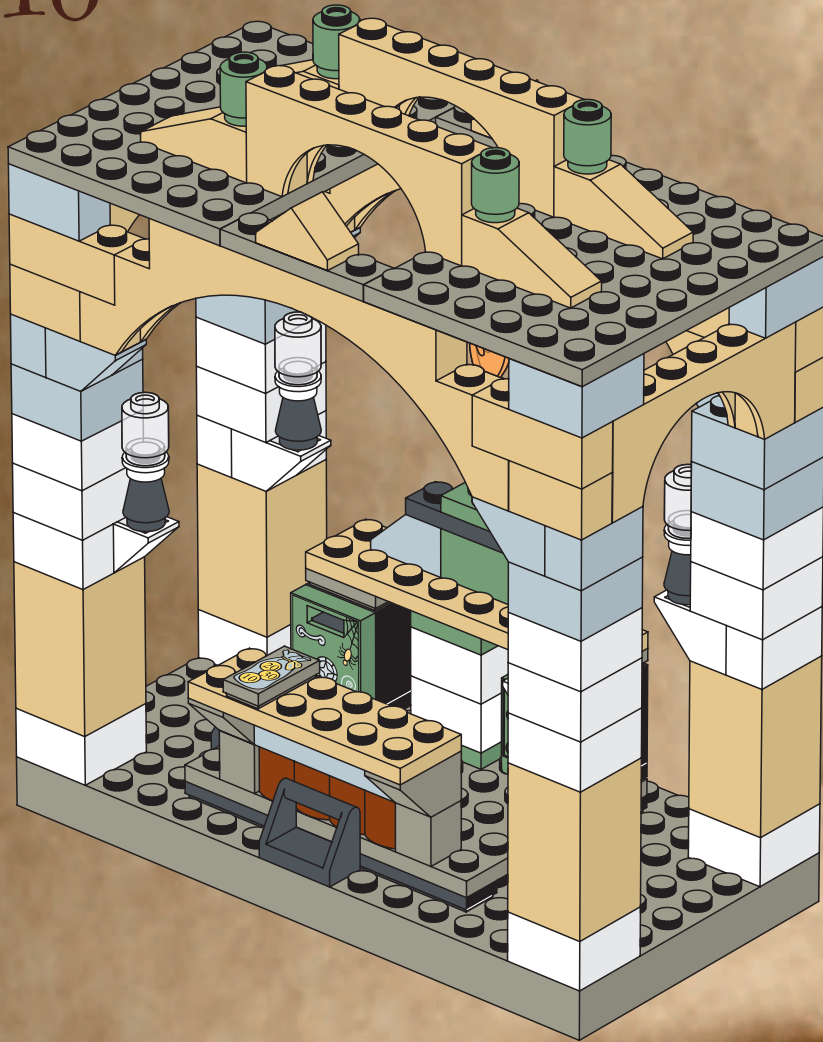

32

17

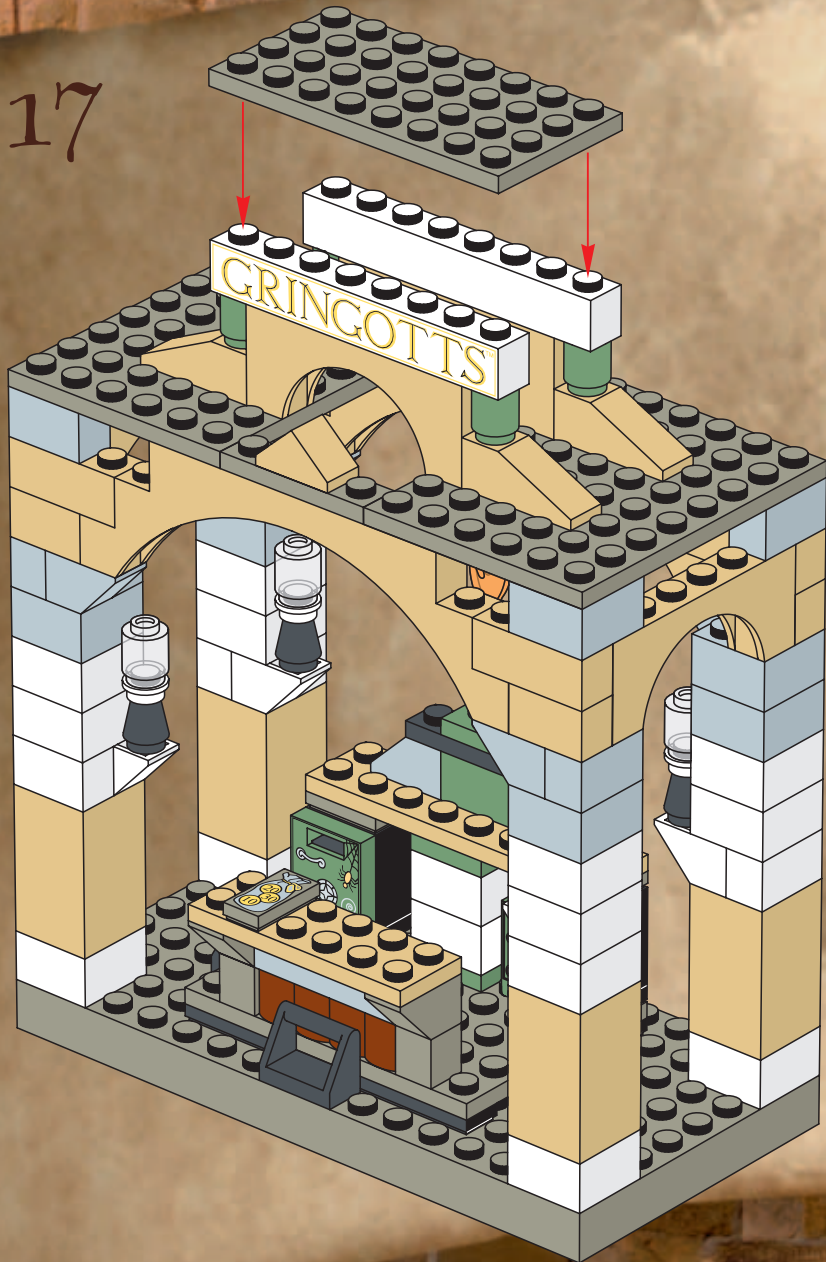

18

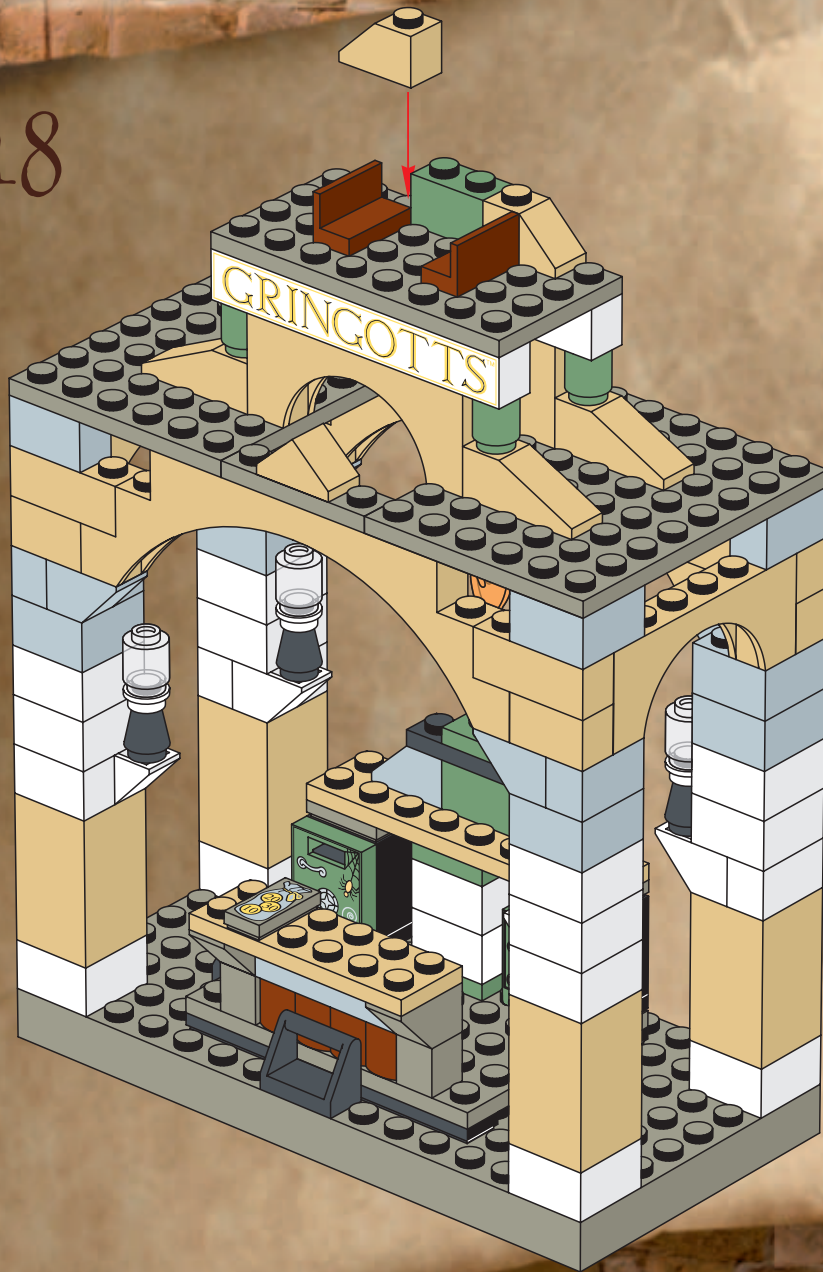

19

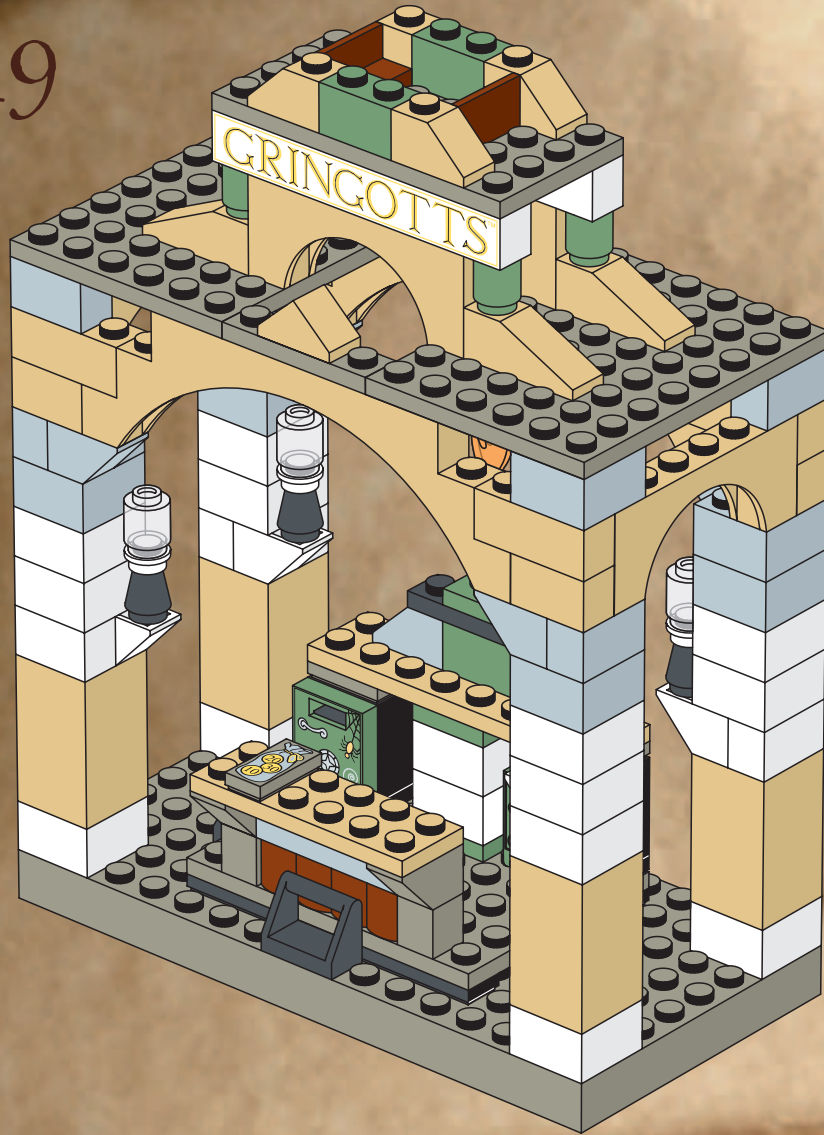

20

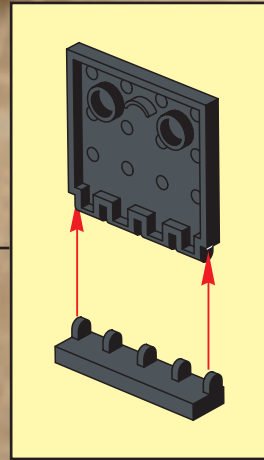
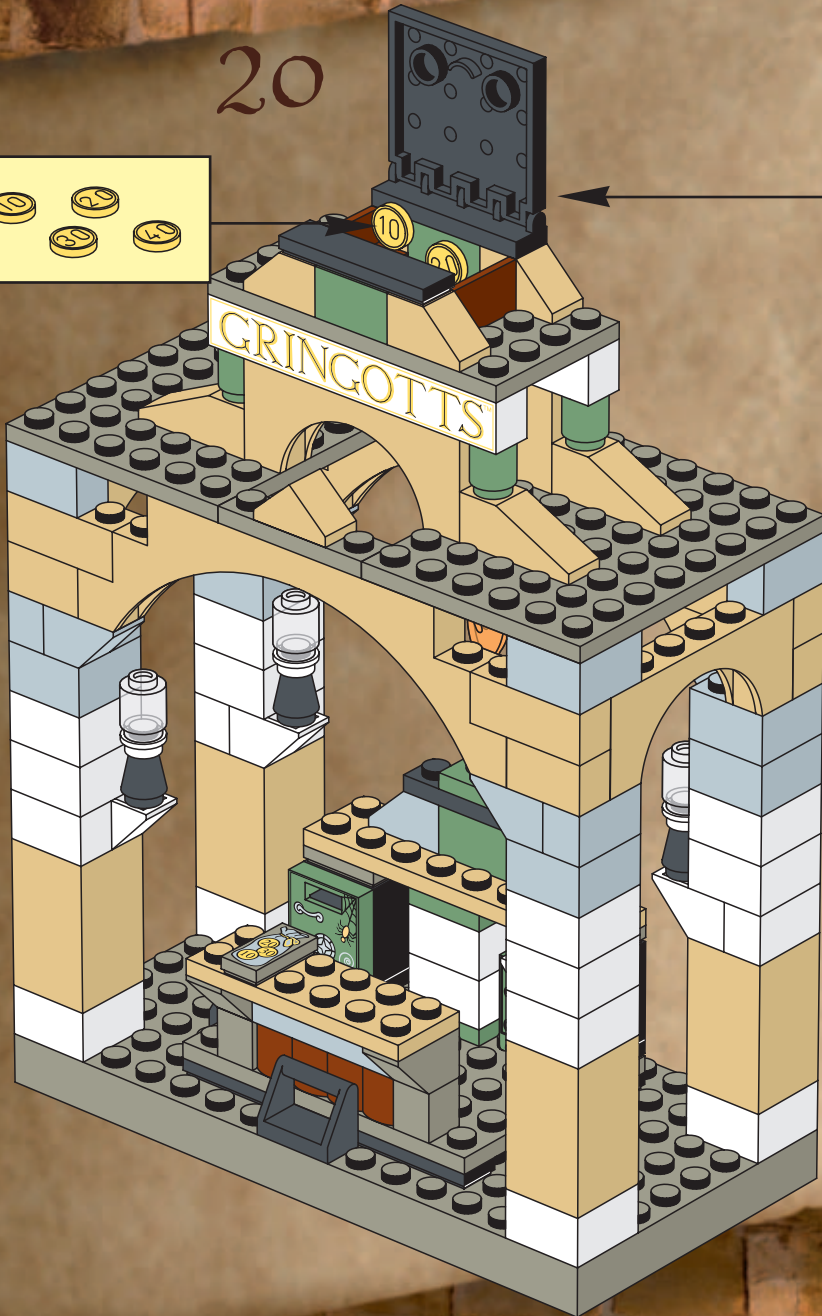
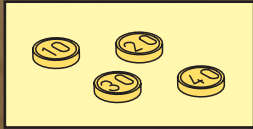

21

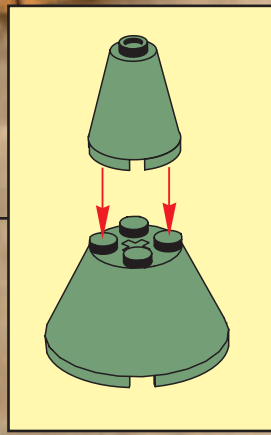
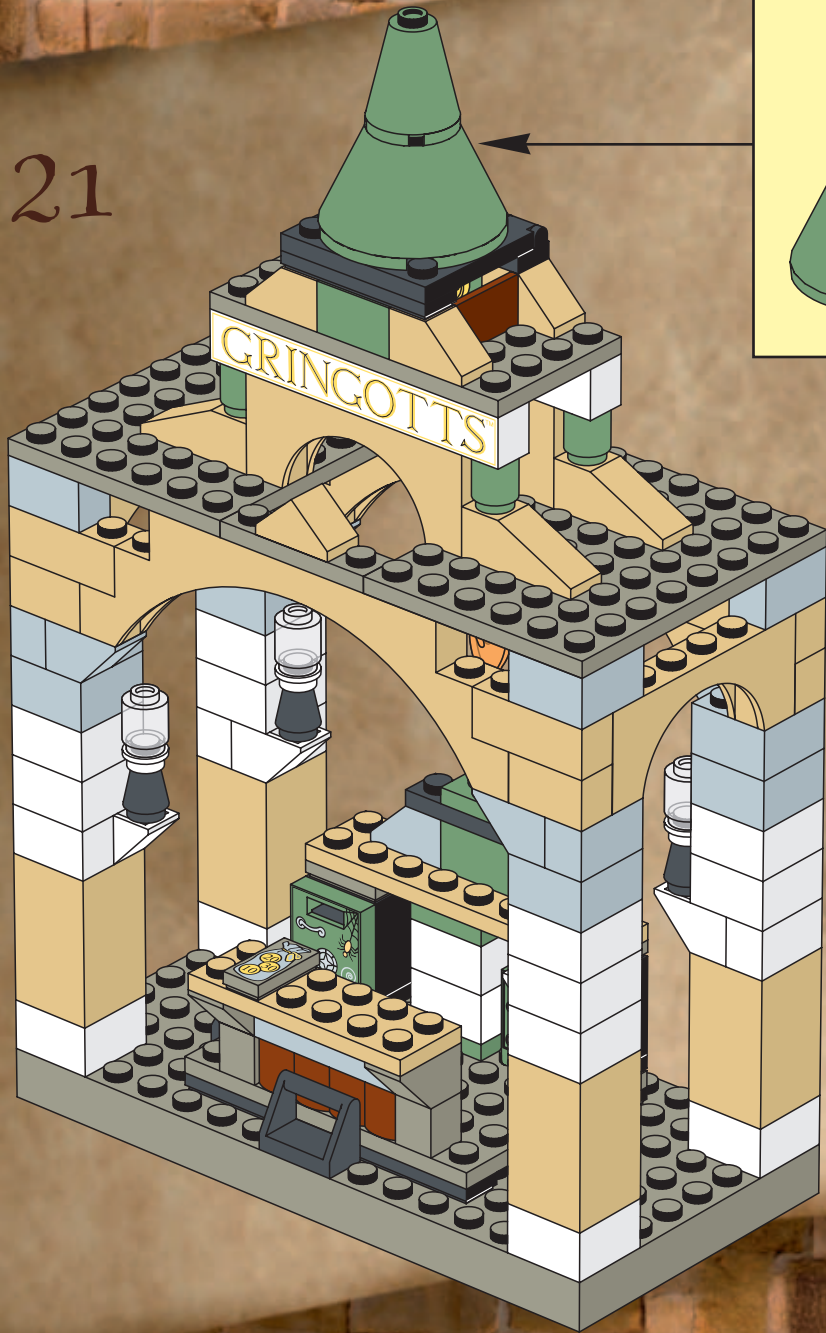

22

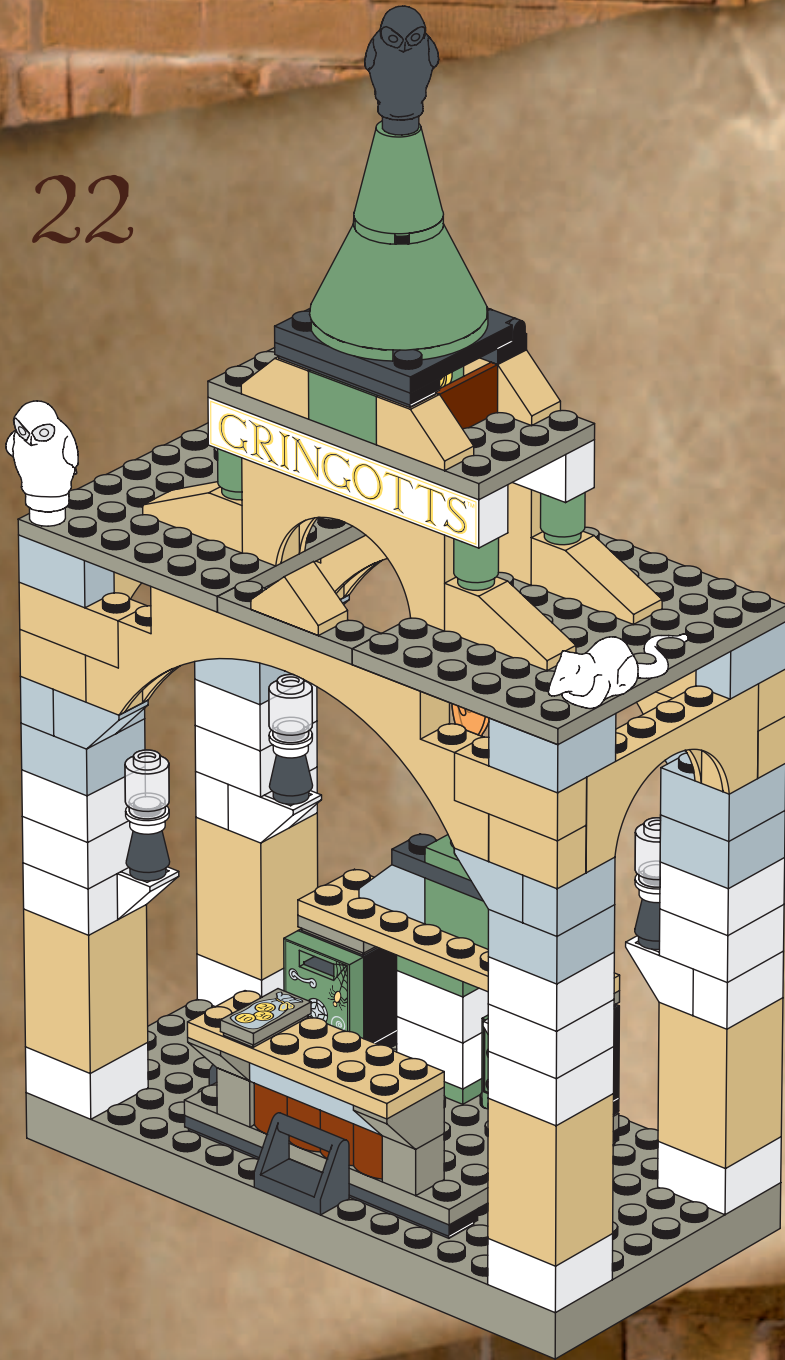

38







1

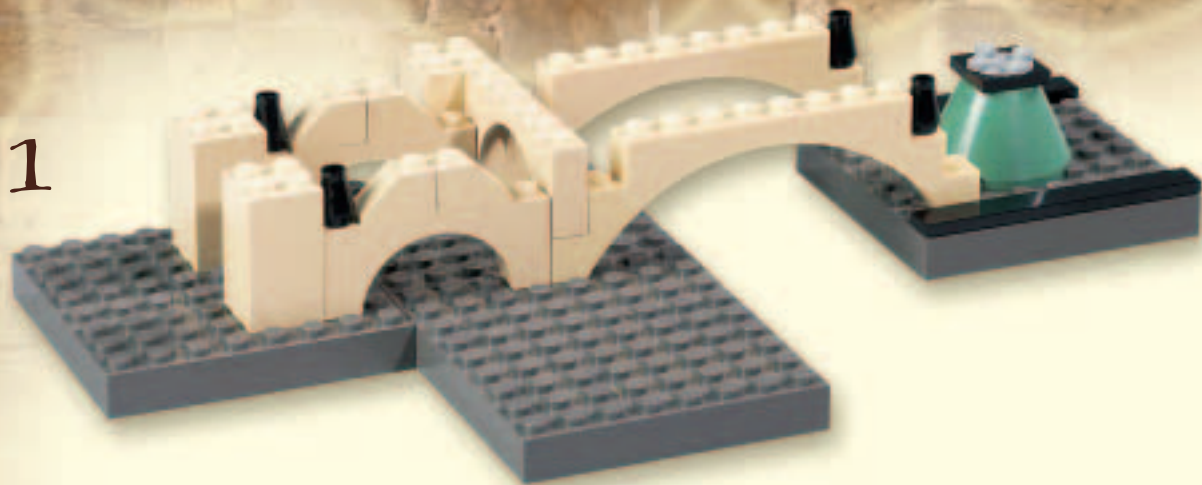

2

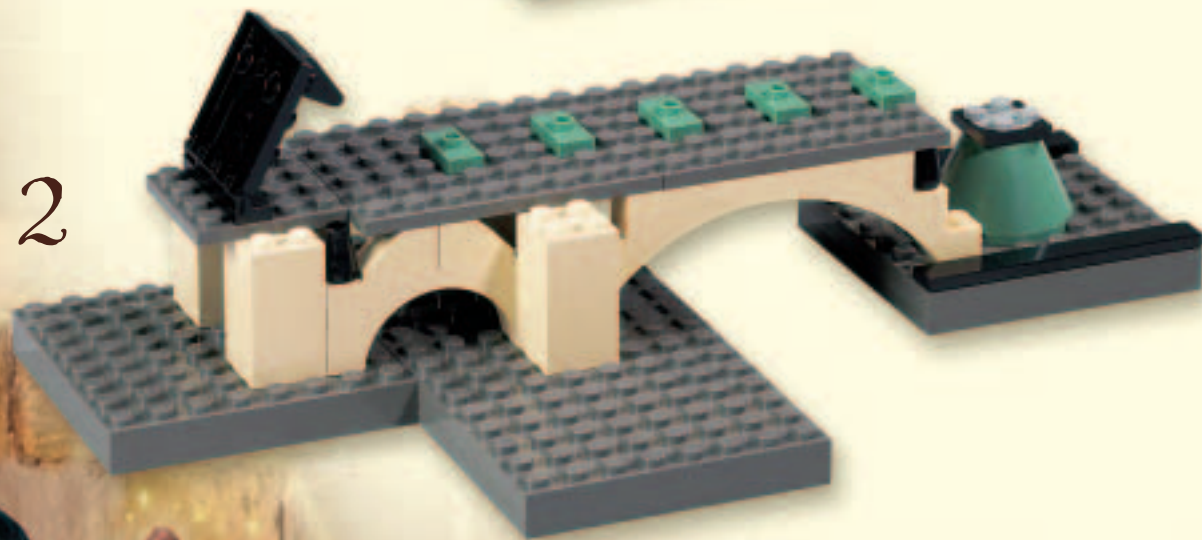



1



2



3



1

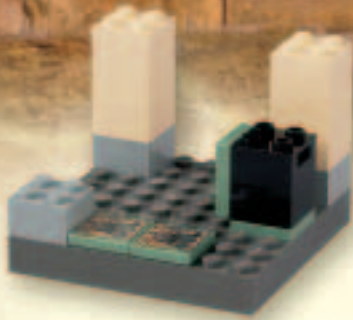

2



3



4



1

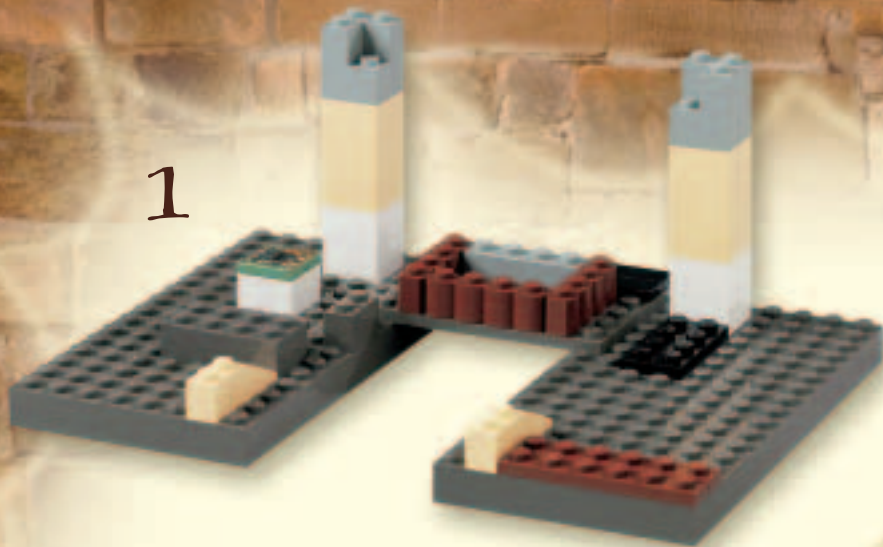

2

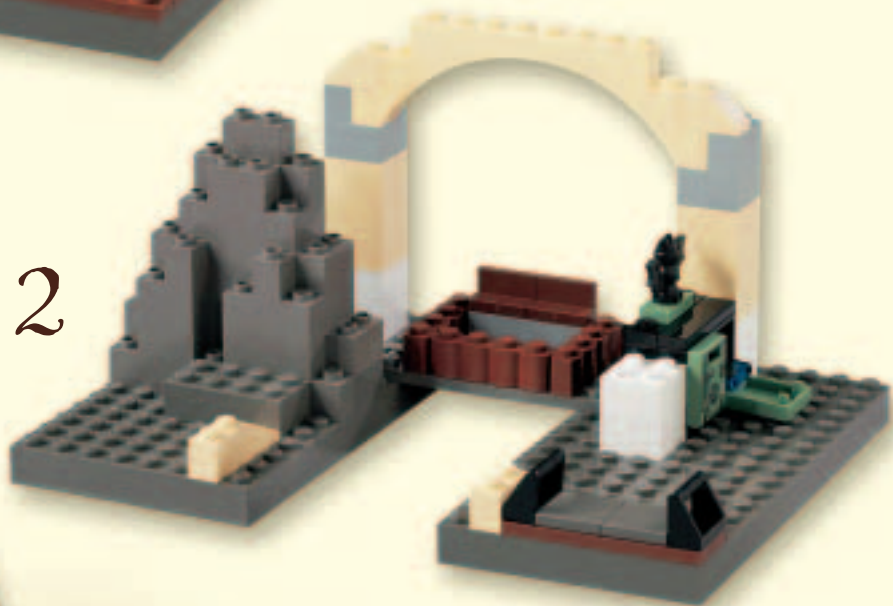

3

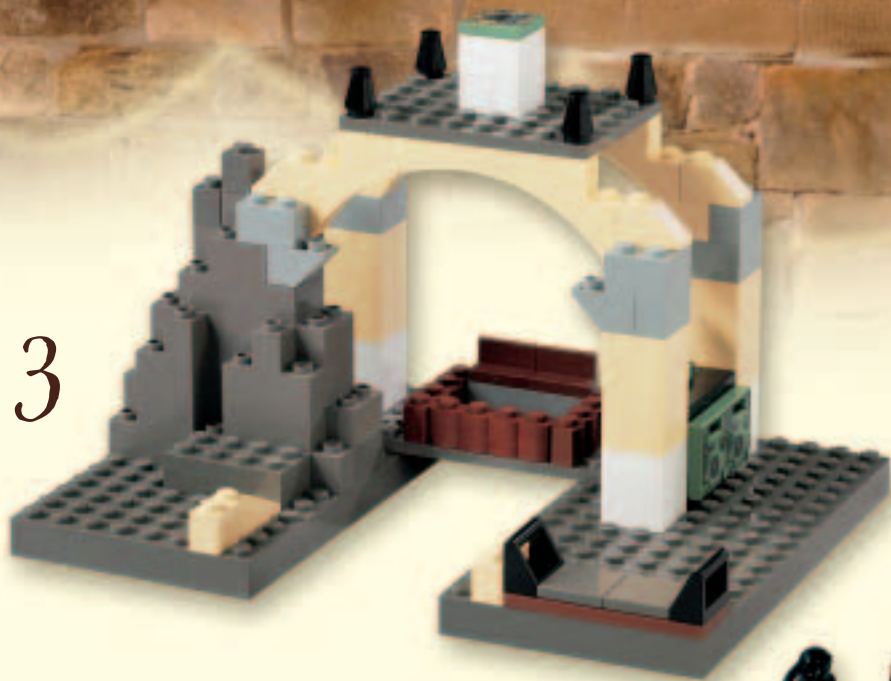

4





SOFTWARE



www.harrypotter.com



 HARRY POTTER, characters, names and related indicia are trademarks of and © Warner Bros. (s02)

HARRY POTTER, characters, names and all related indicia are trademarks of and © Warner Bros. (s02)

 WB SHIELD: TM & © 2002 Warner Bros.

© 2002 The LEGO Group.

4170453