

ZNAQ

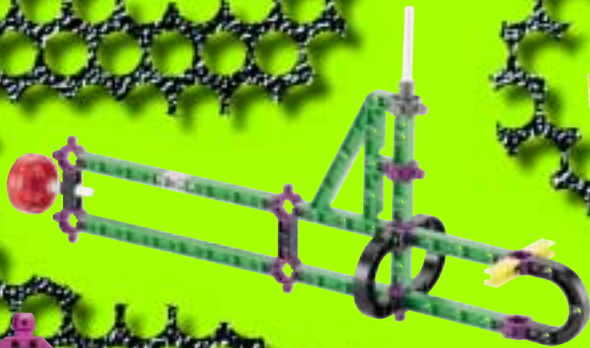

LEGO

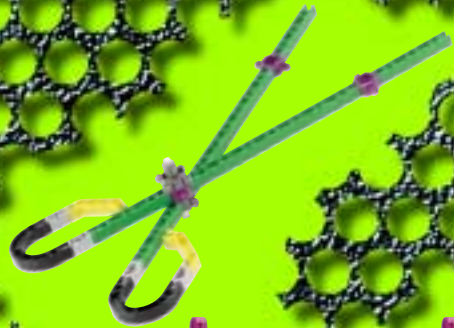



52

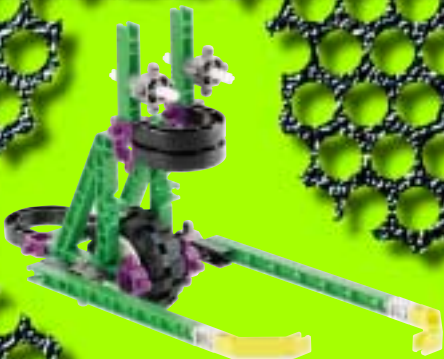

70



84

108



3



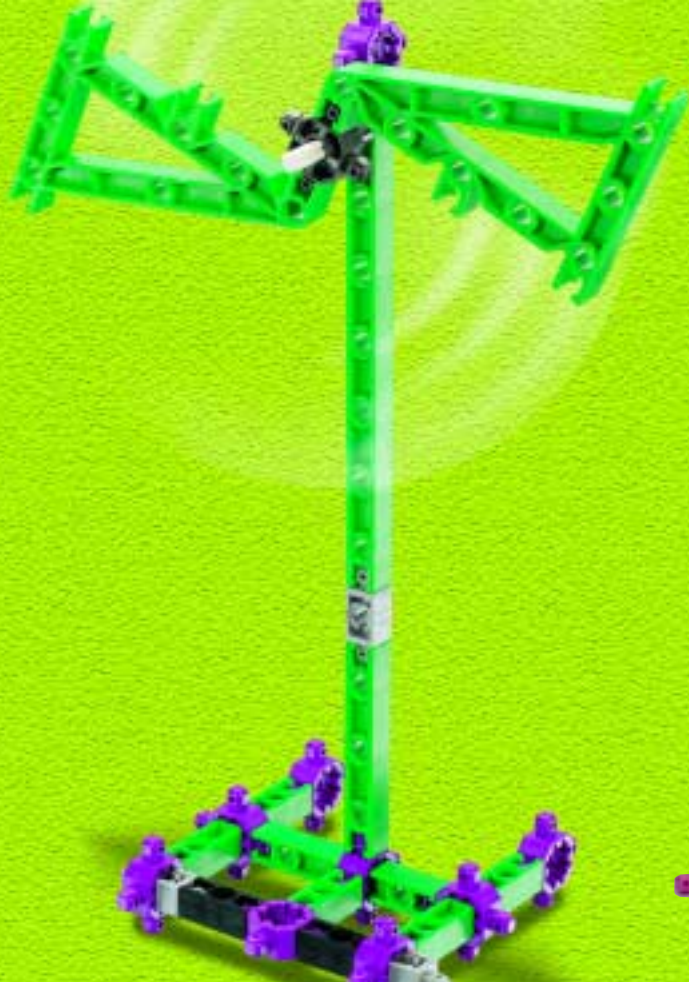

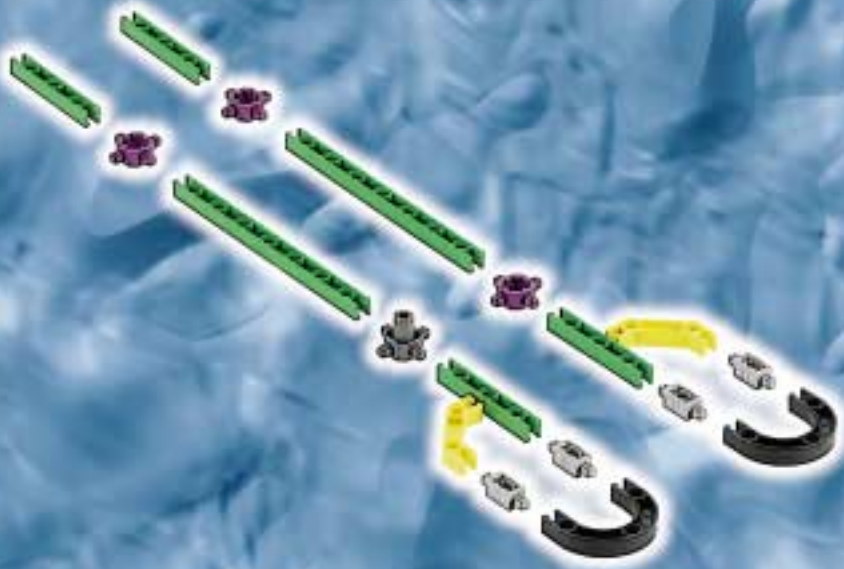

2



3

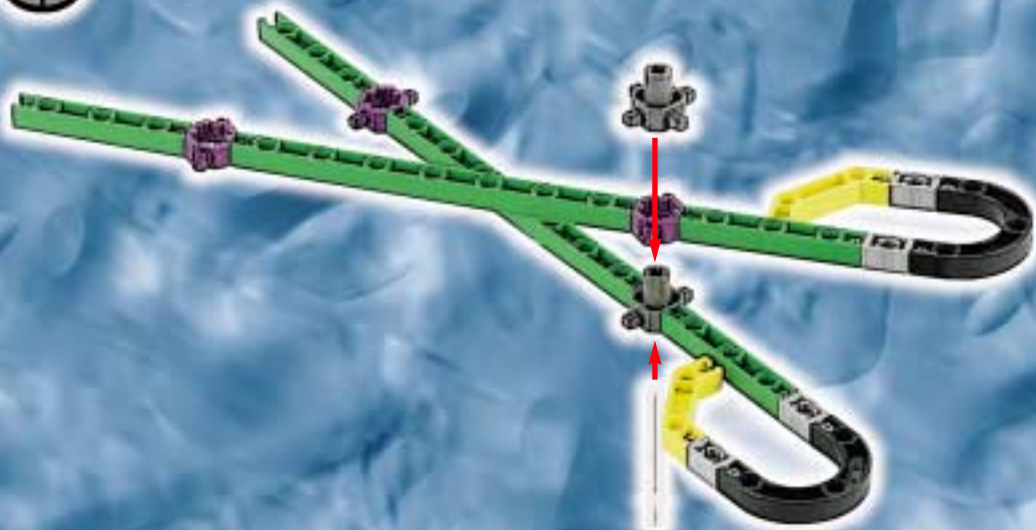

4

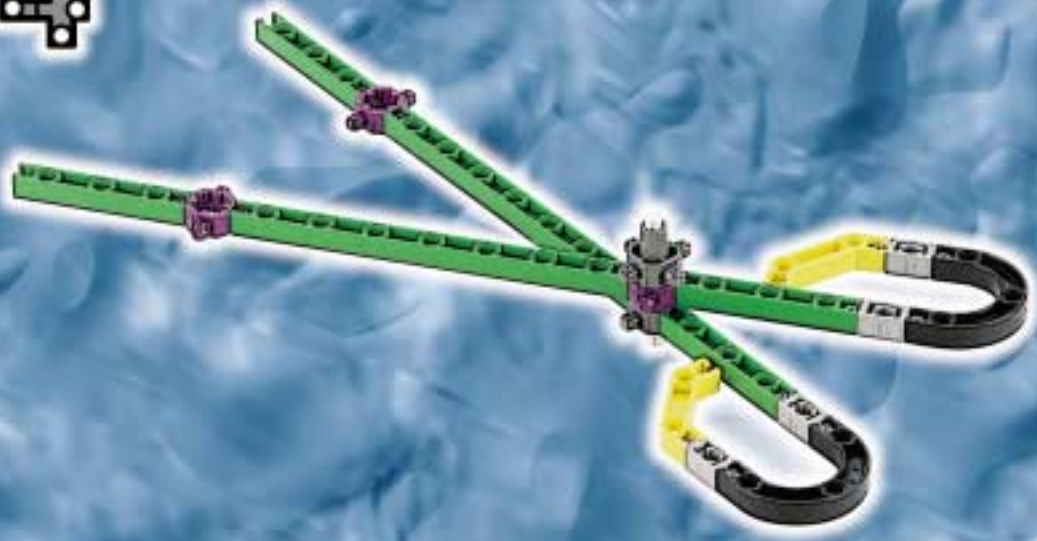



1



2



3



4



5



6



7



8





9

10



15

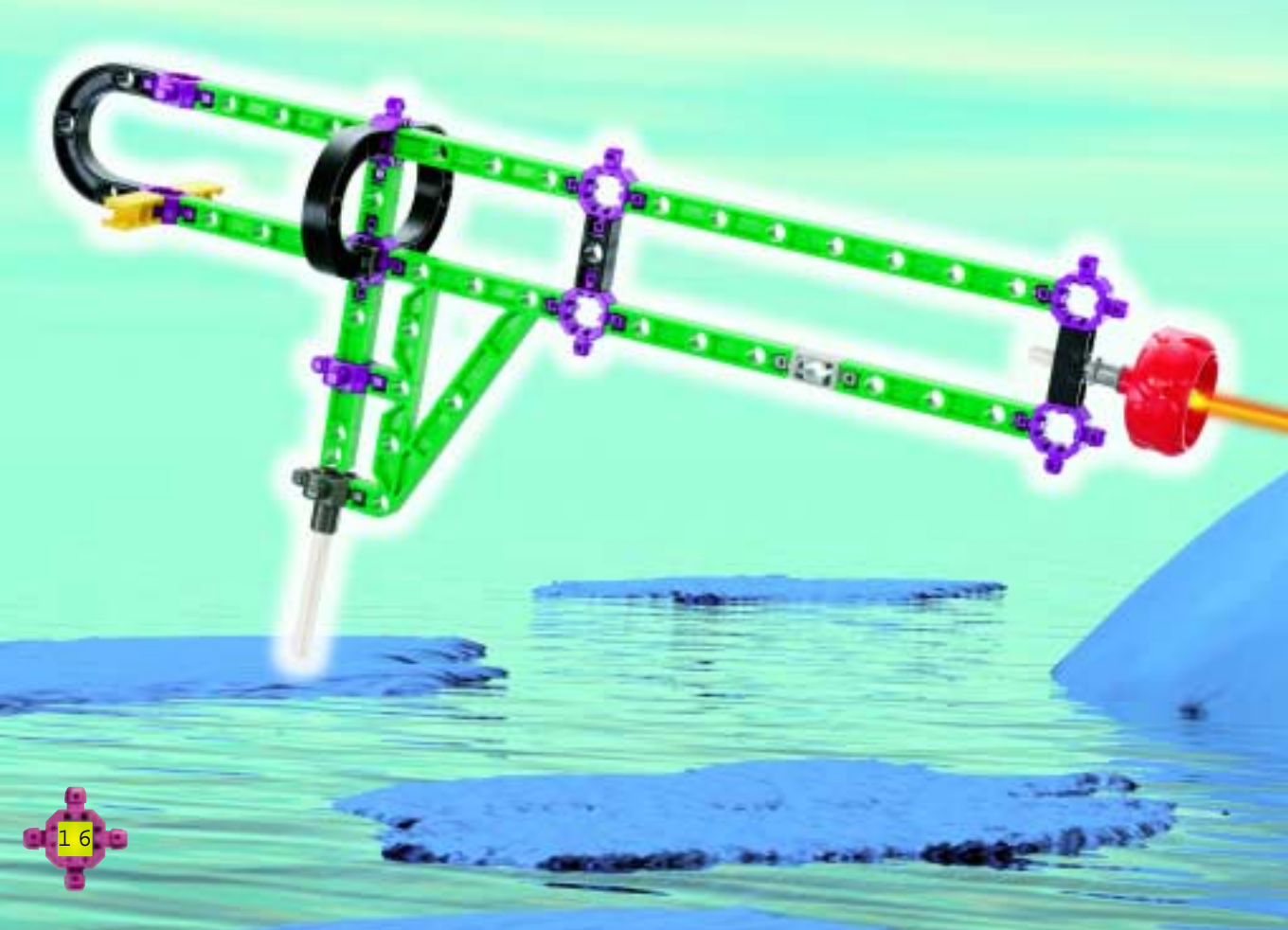

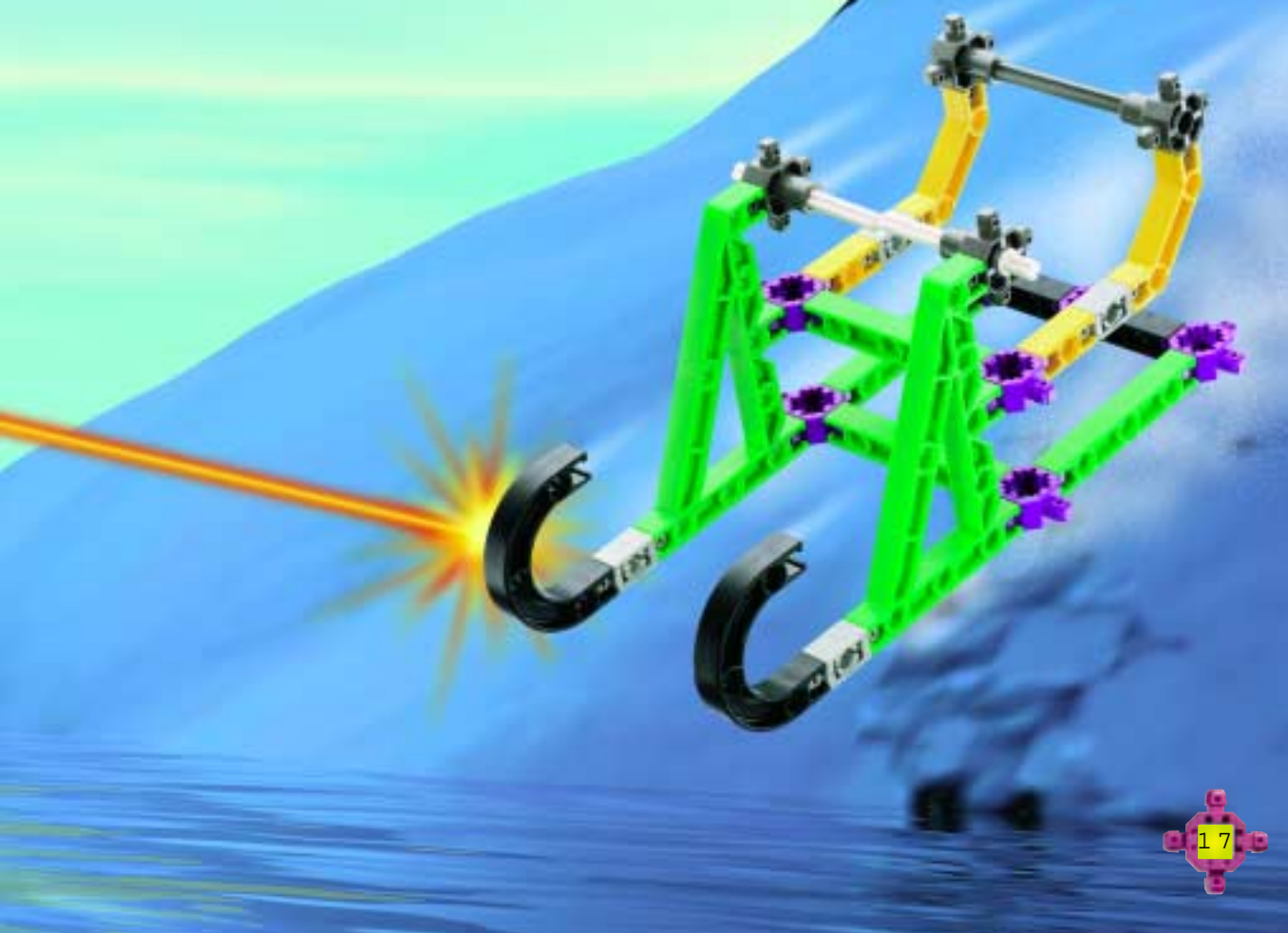



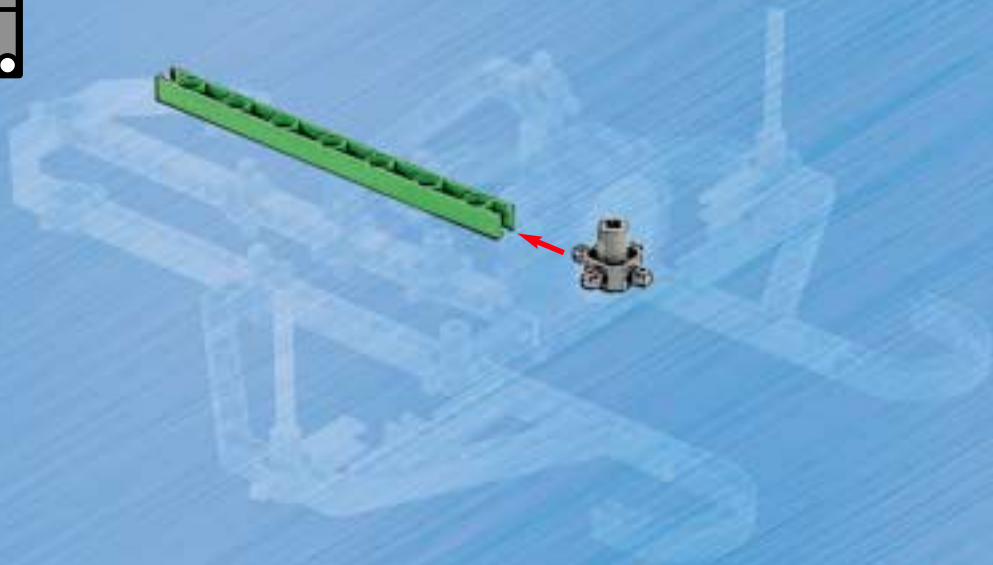

2

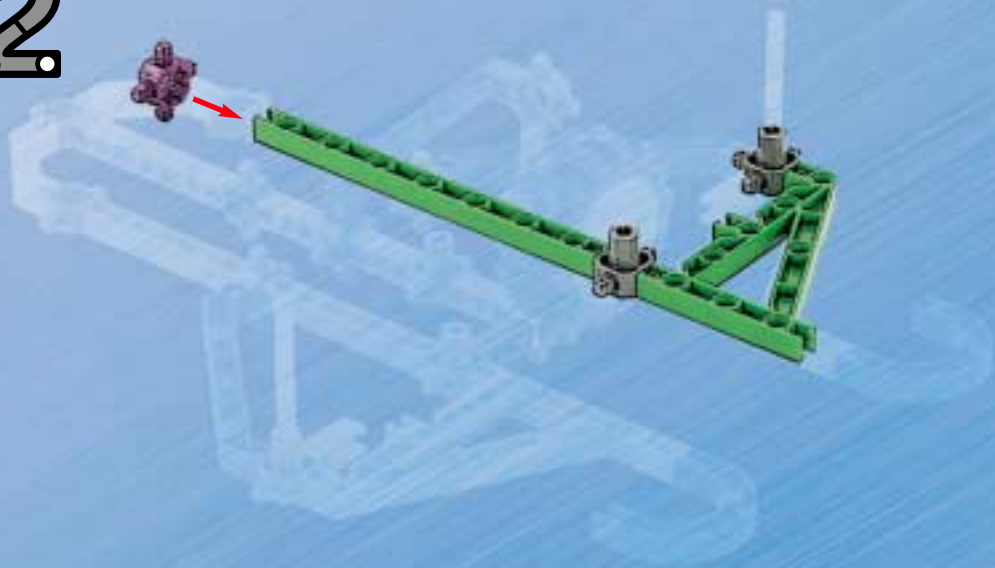

3

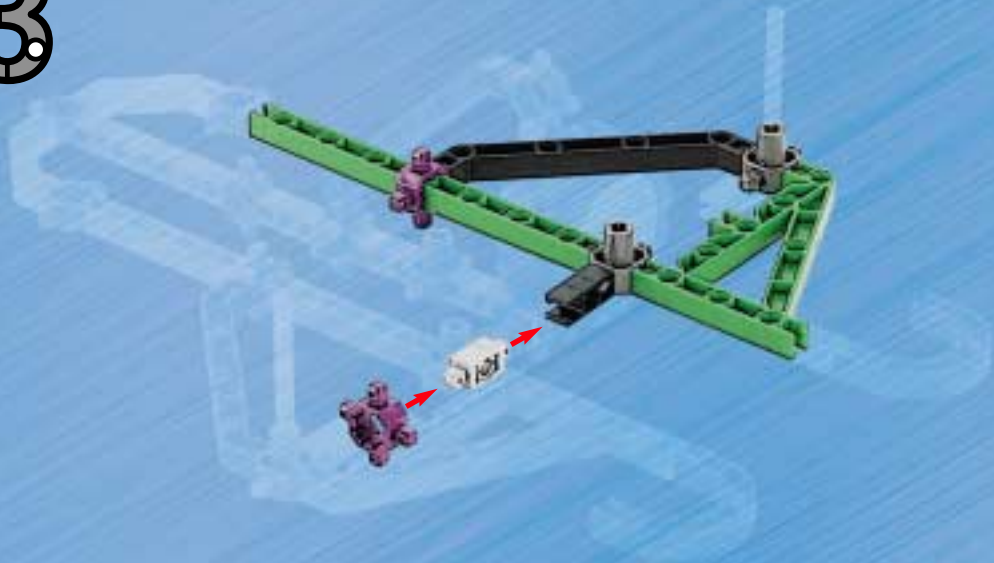

4

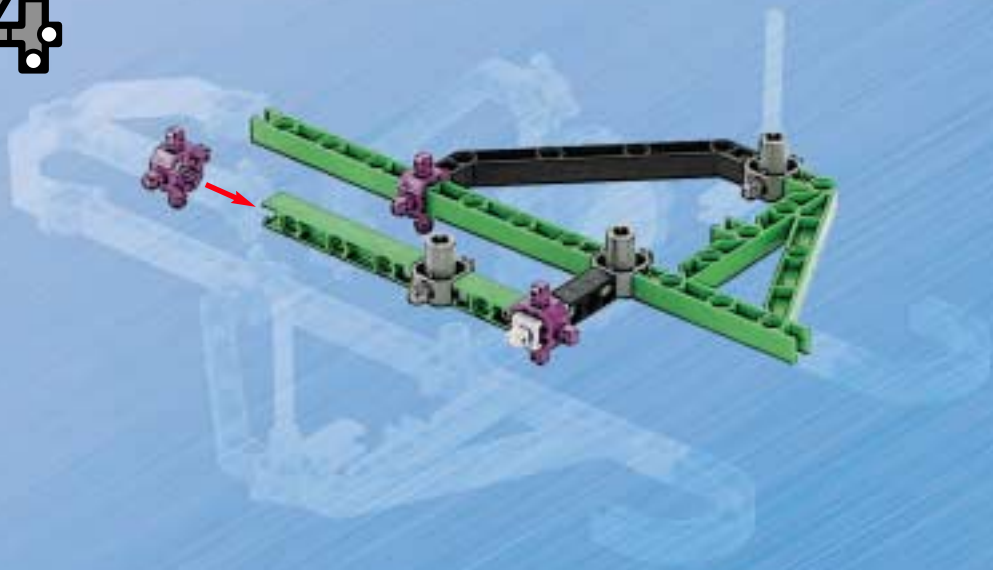

5

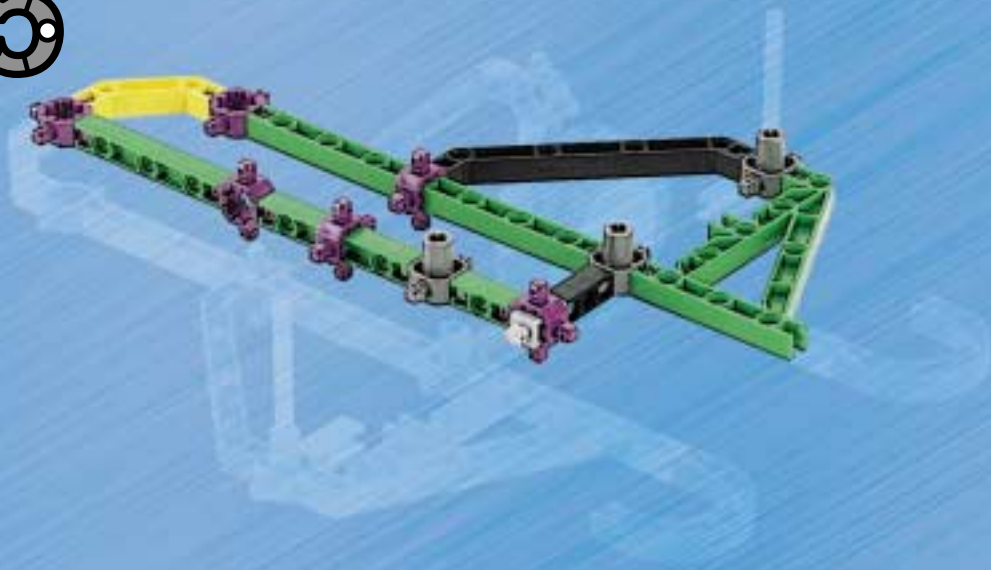

6



7





9



10

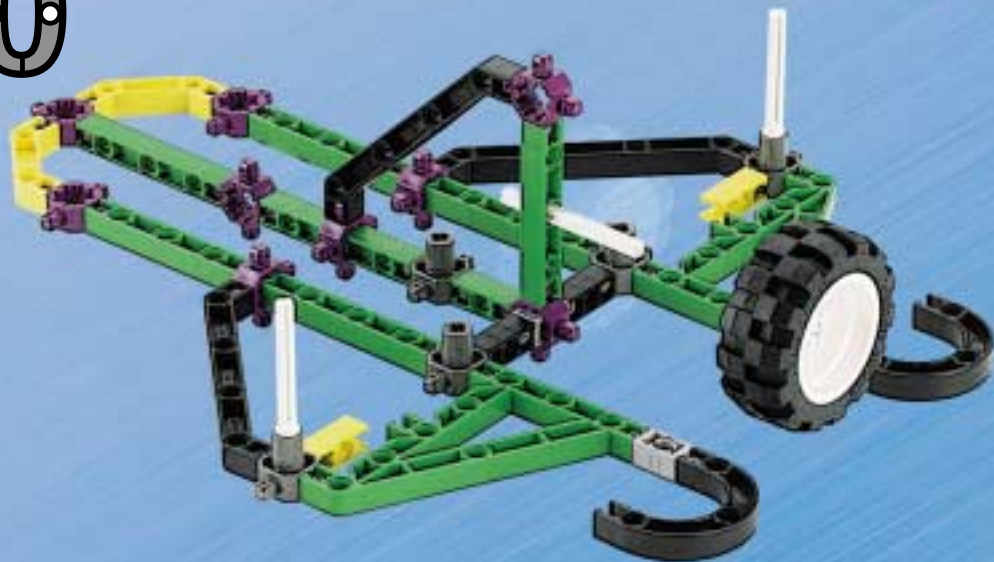

11



TRANS  FORM



2



3







2

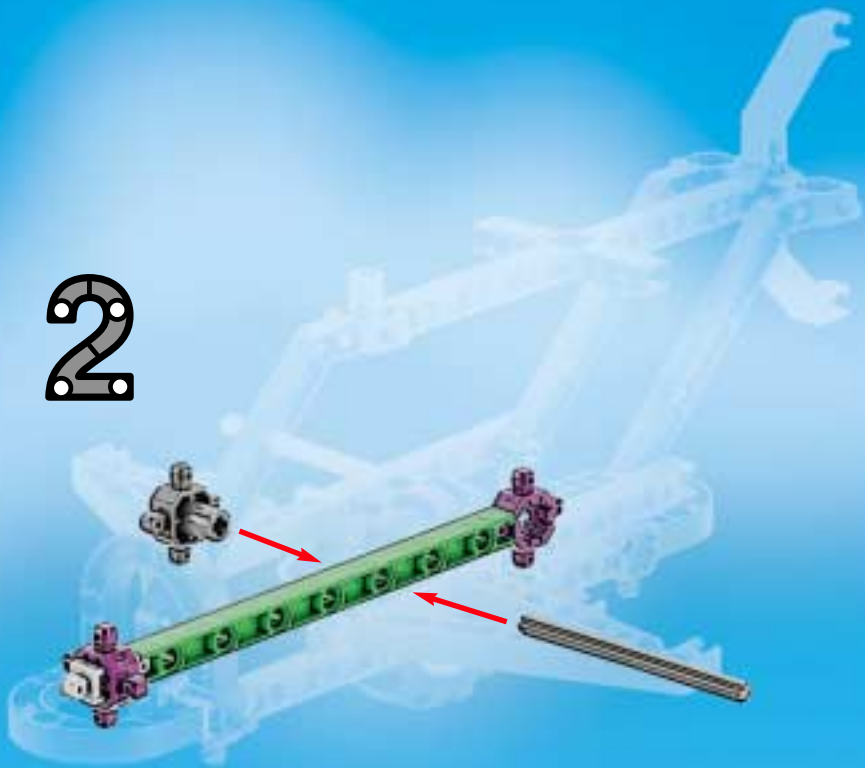

3

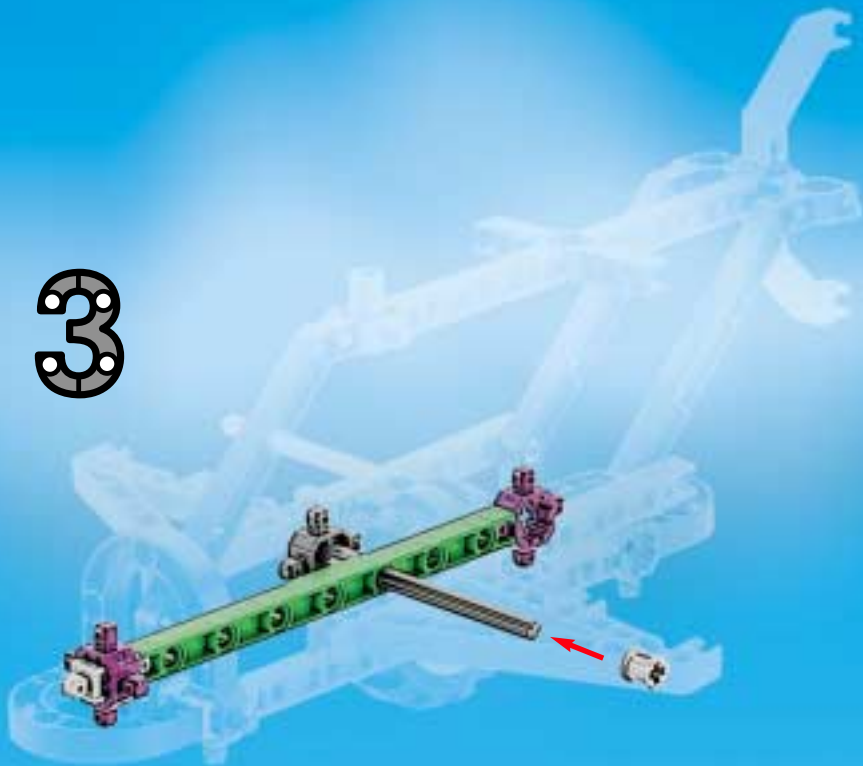

4



5



6



7





9



10



11



12



13



14



15



16



17





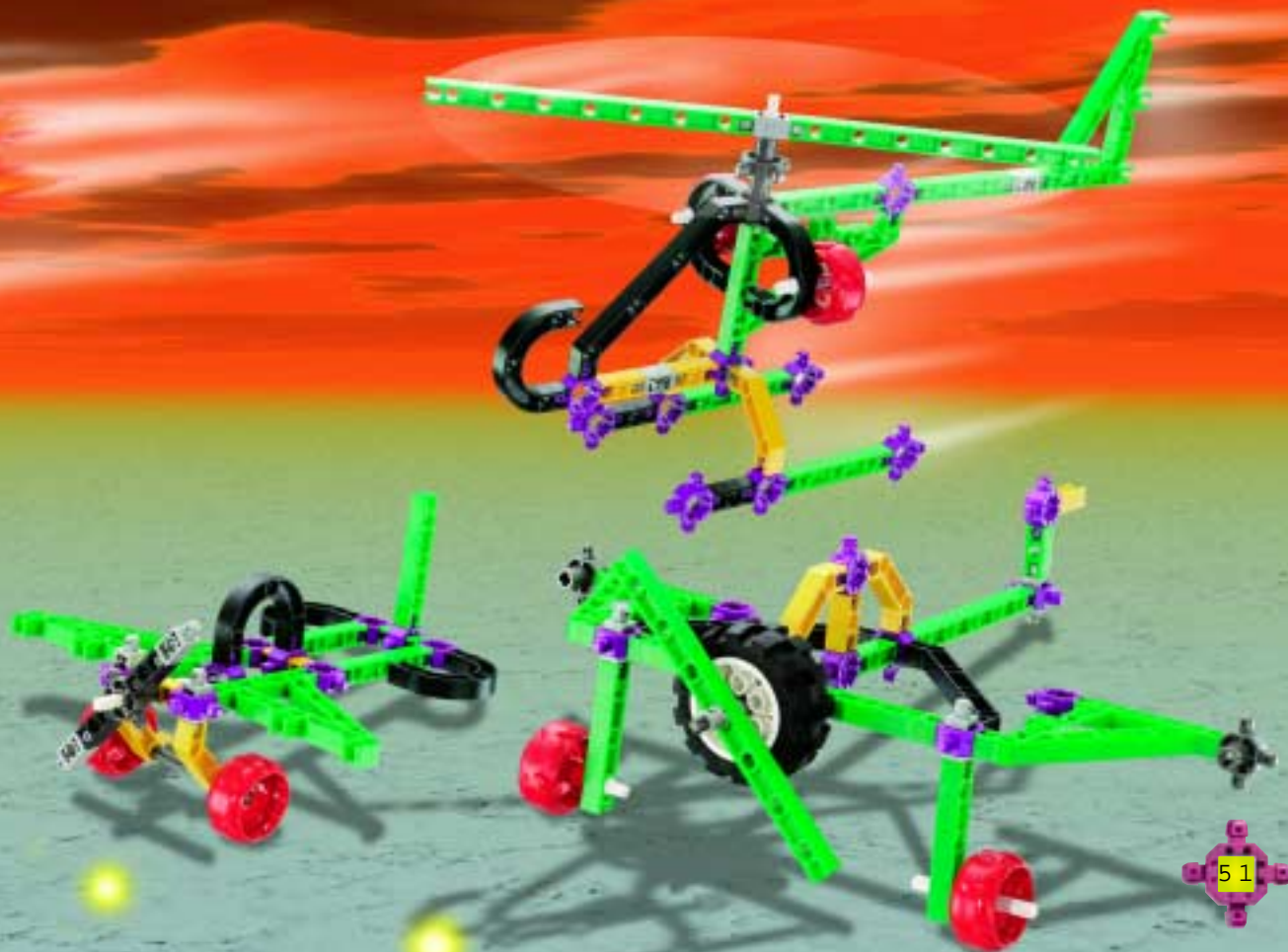



2



3



4



5



6



7





10



11



12



13



14



15



16









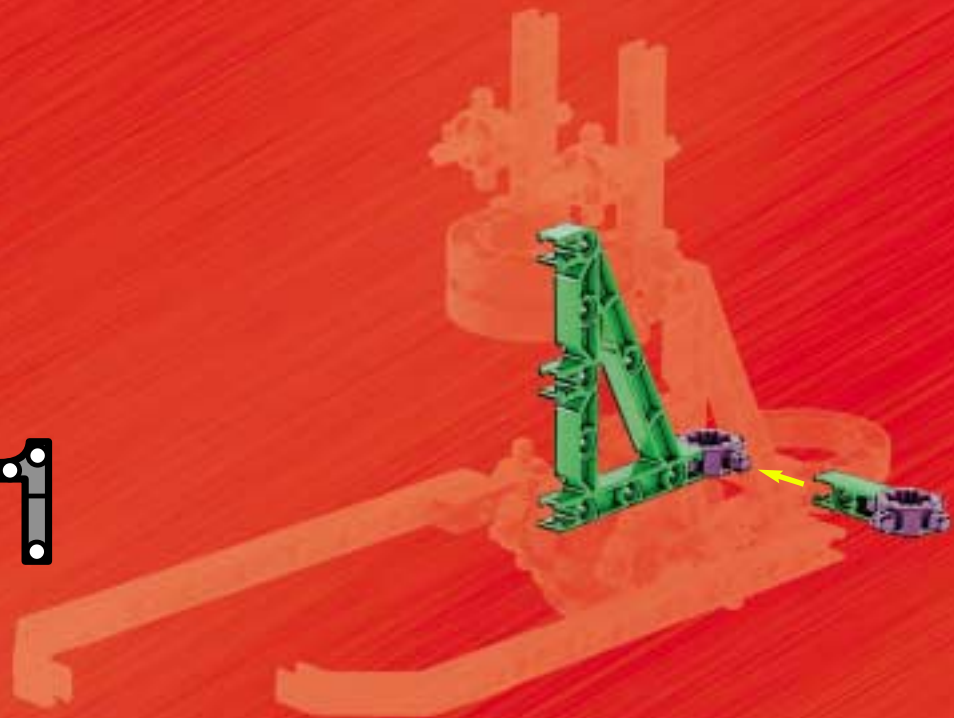

2



3



4



5

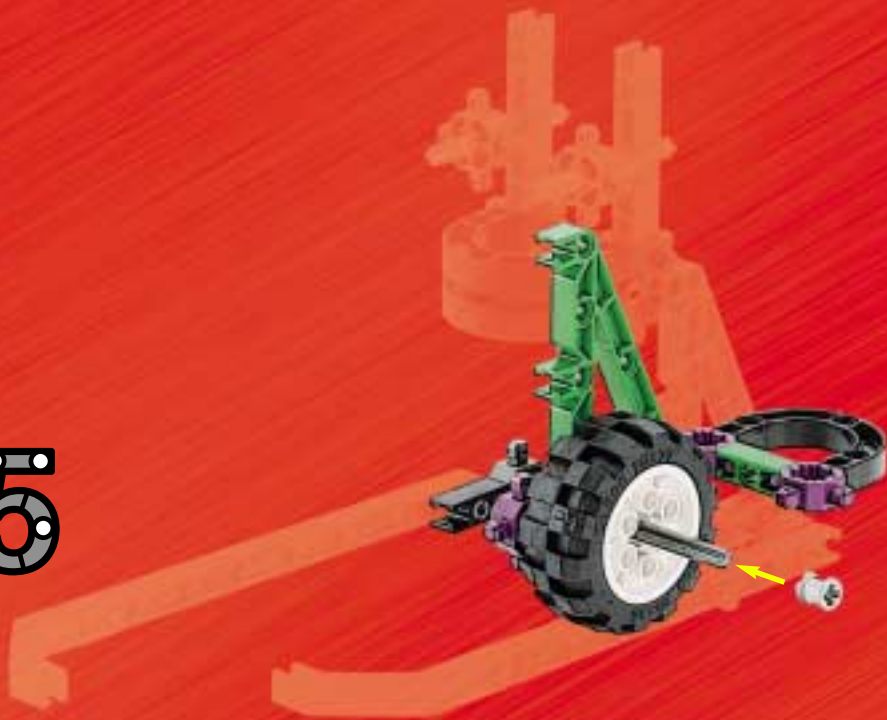

6



7

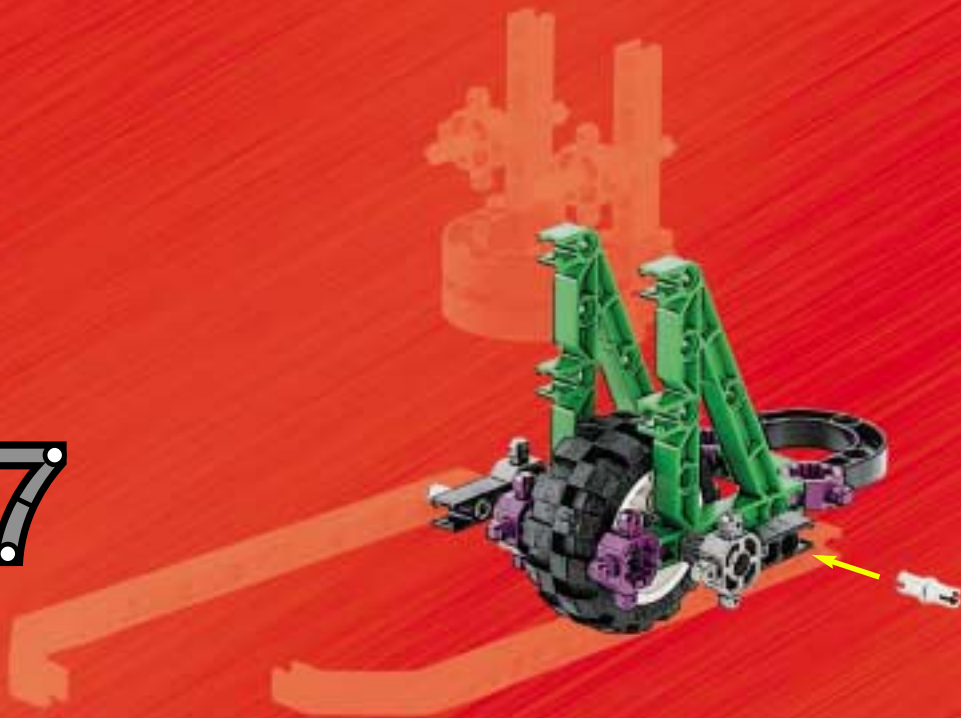

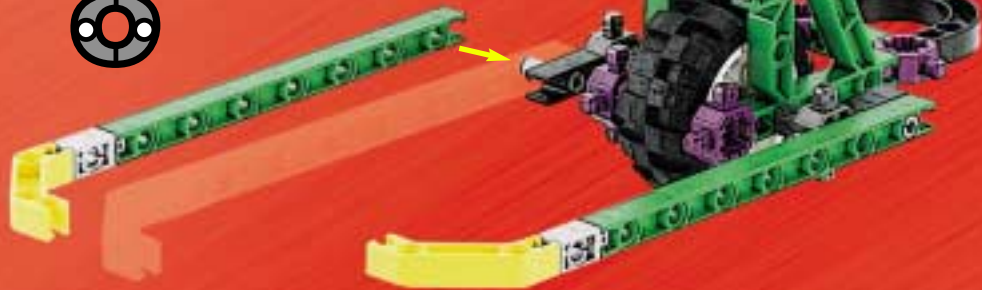

9



10



11









1



2

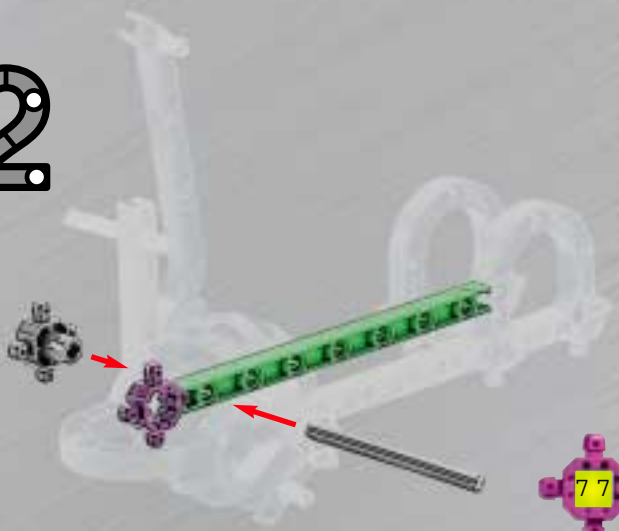

3



4

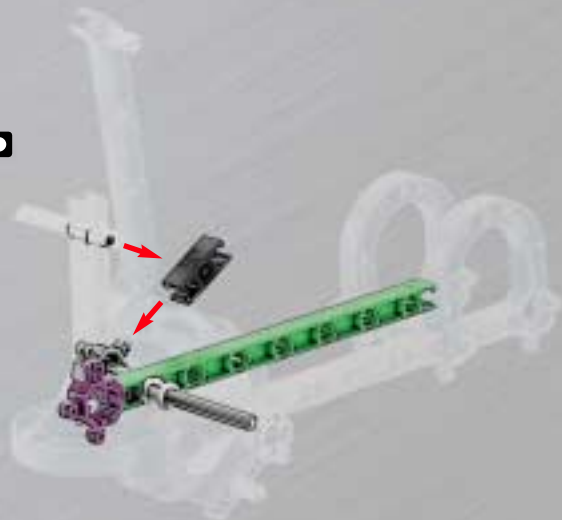

5

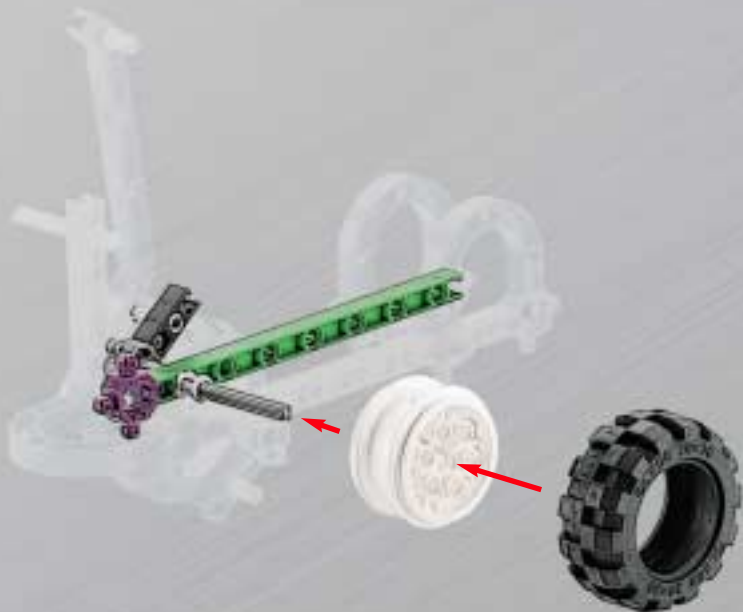

6

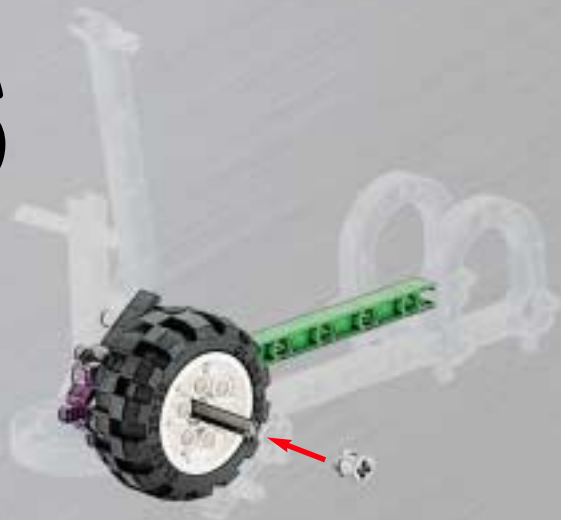

7

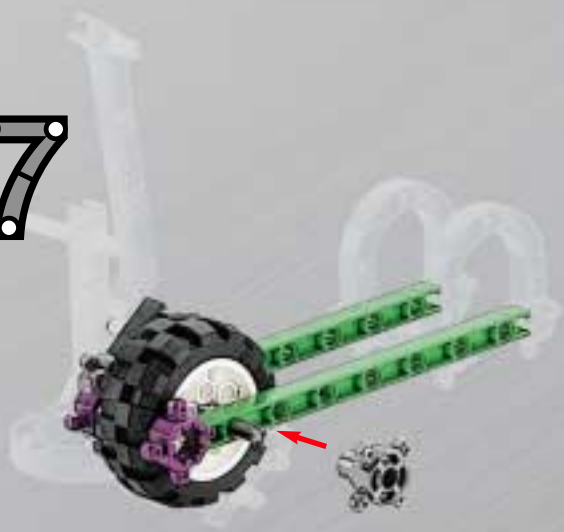



9

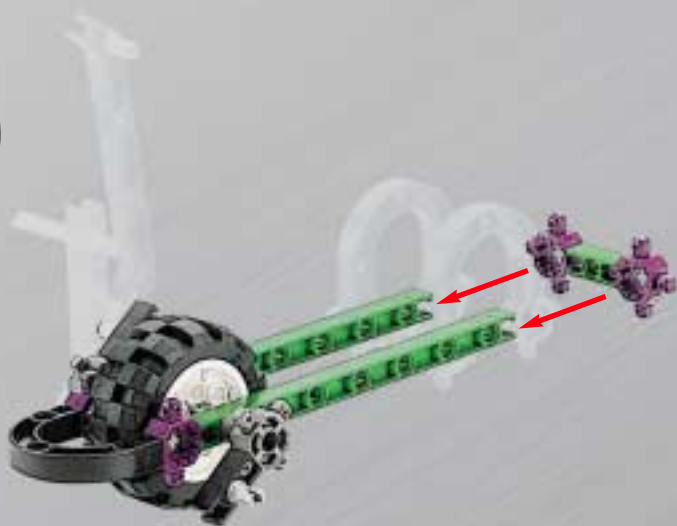

10



11

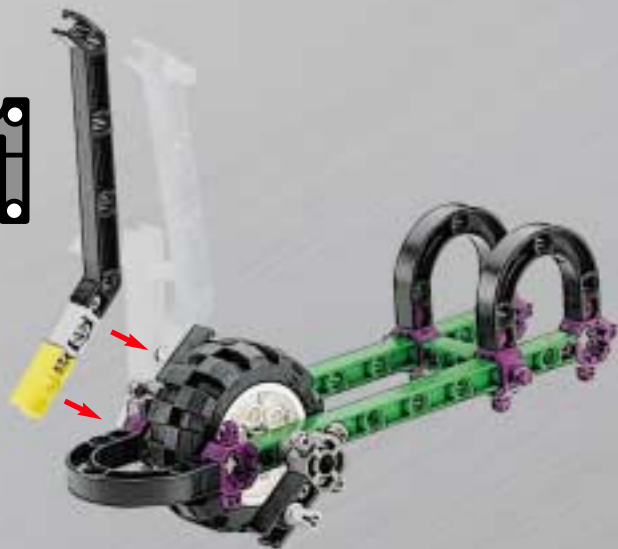

12



13



14



15



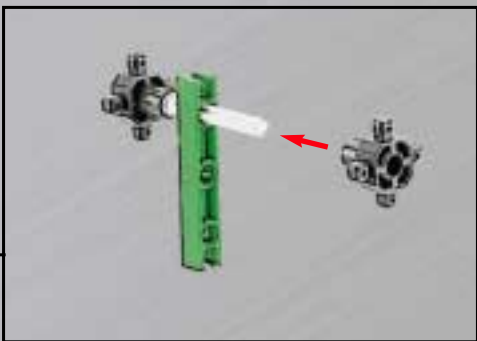

16



17

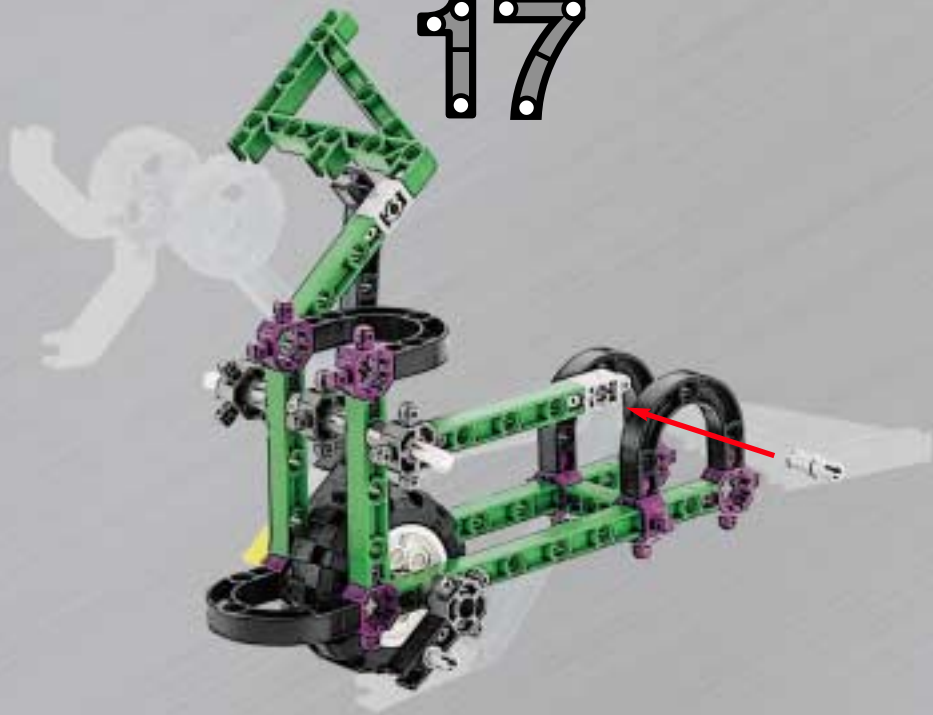

18



19



20



21



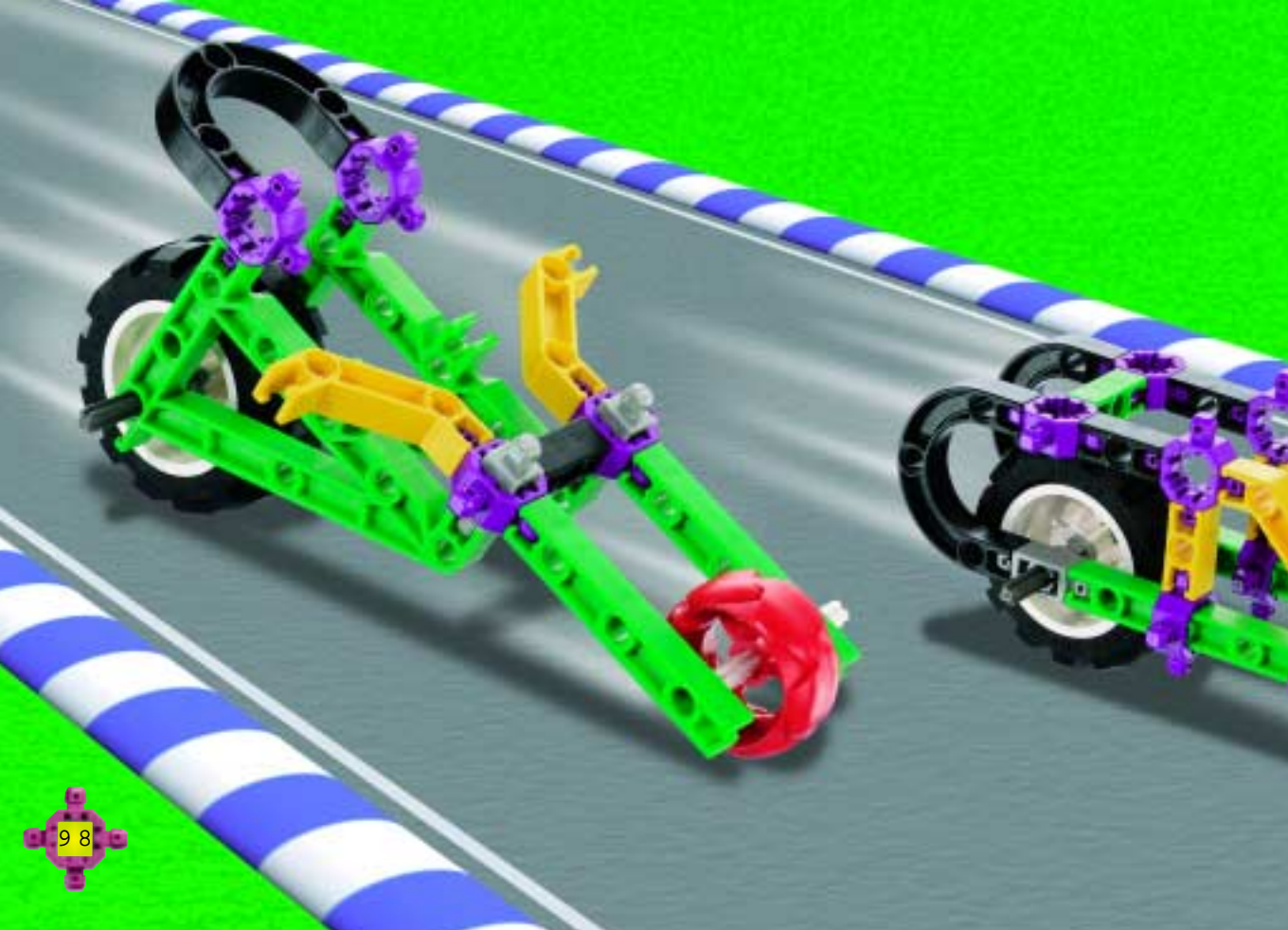



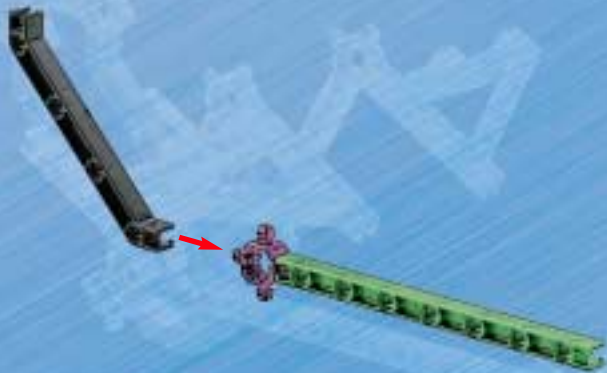

100

2

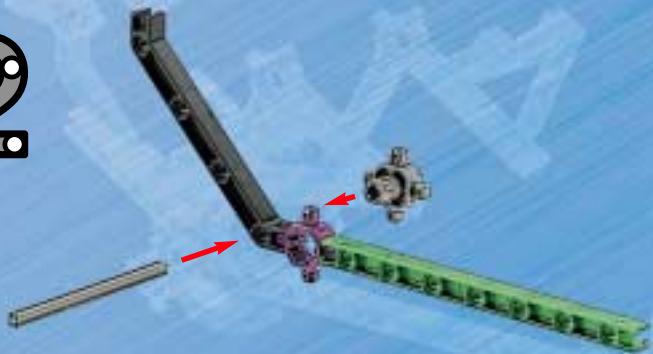

3



4



5



104

6



7







9

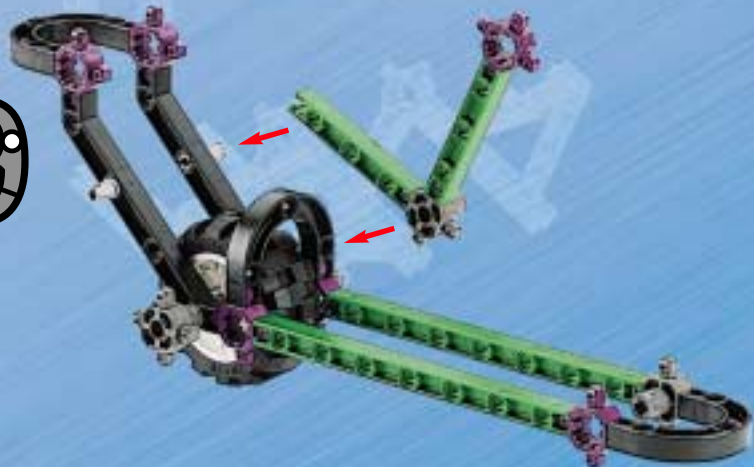

10



11



12



13



14







The LEGO logo is displayed in its characteristic white, bold, rounded font with a black outline, set against a red rectangular background.

4123873

© LEGO is a registered trade-
mark

© 1999 LEGO Group.

<http://www.LEGO.com>

