

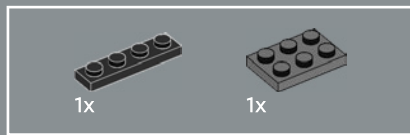

76444

Harry Potter





1

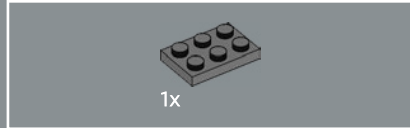
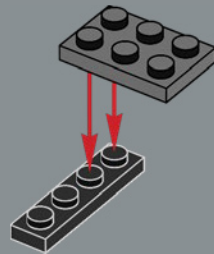

2

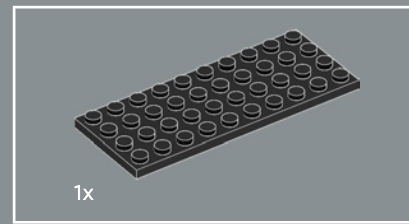
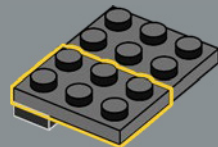

3

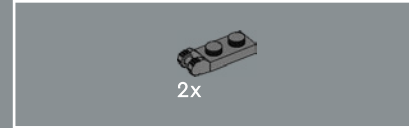
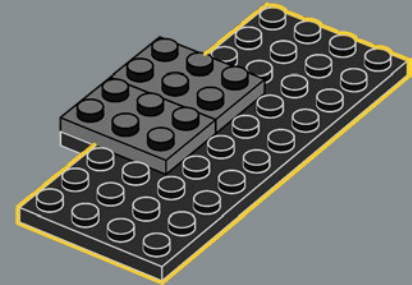

4

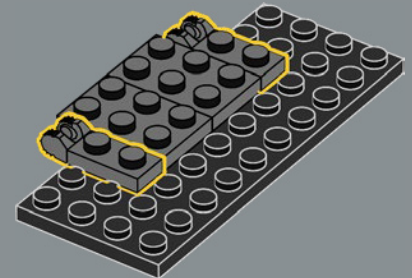

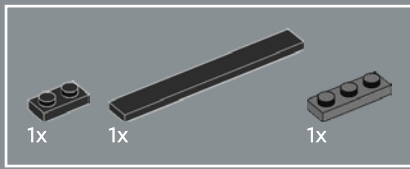

5

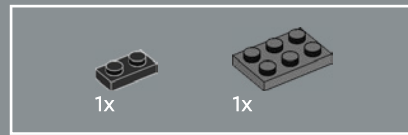
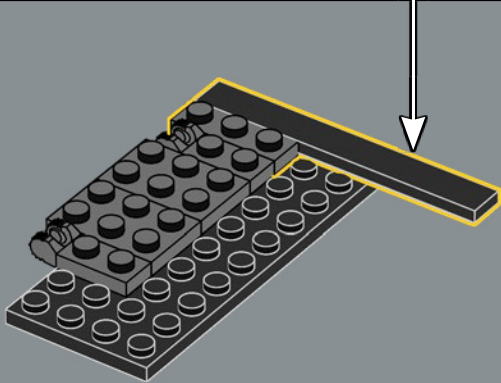
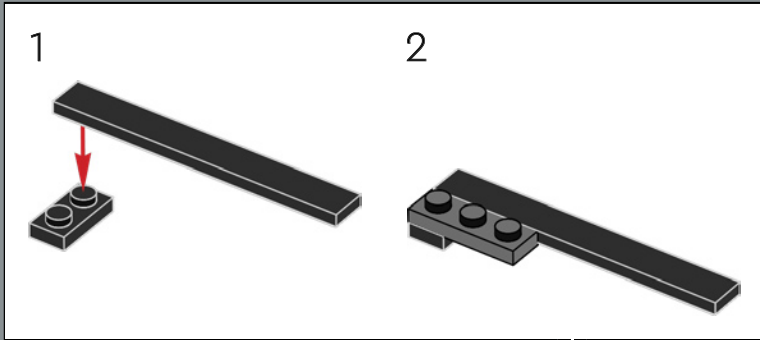

6

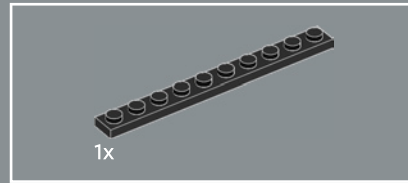
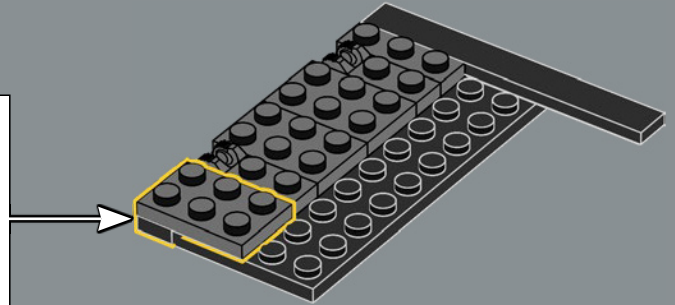
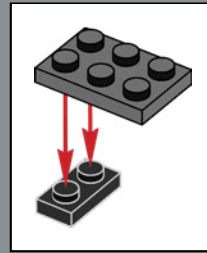

7

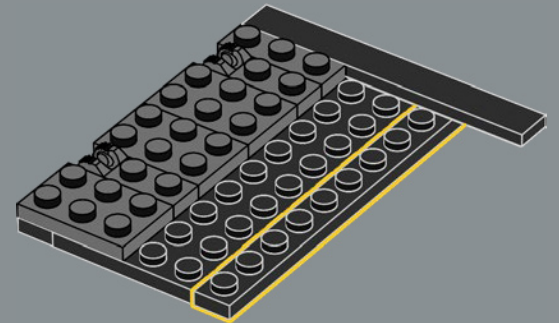

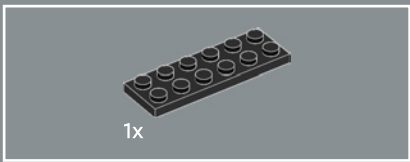

8

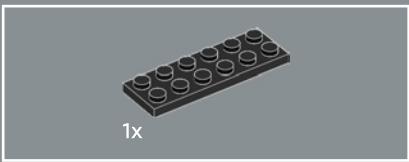
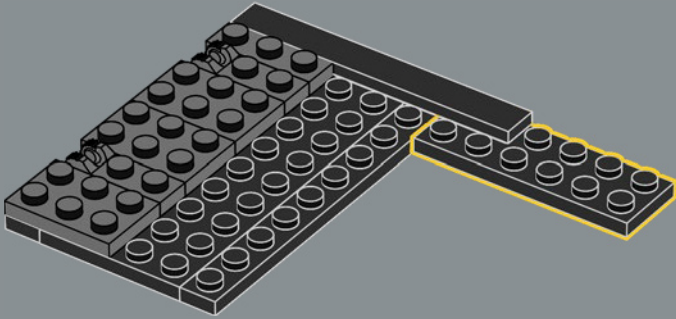

10

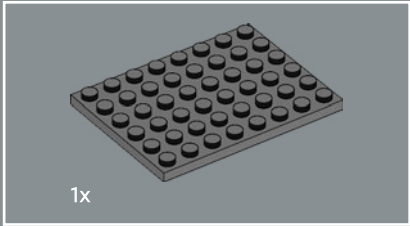
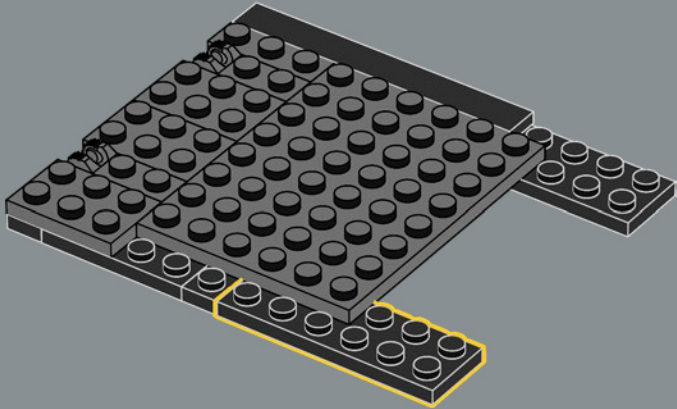

9

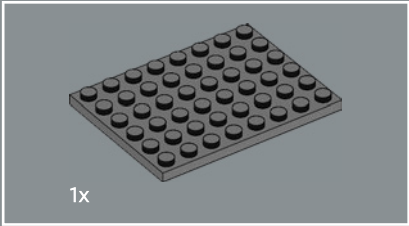
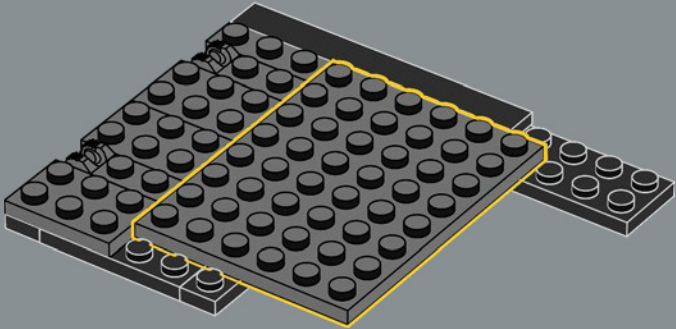

11

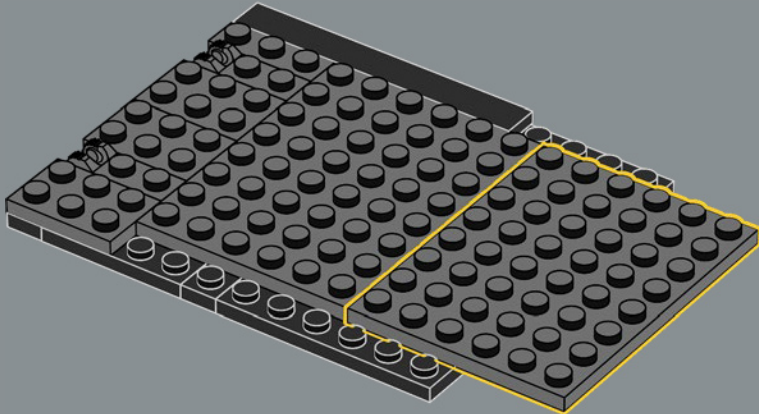

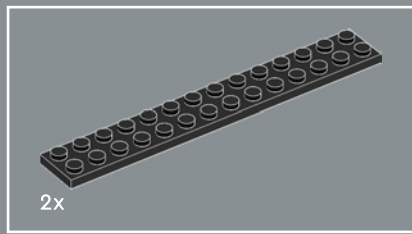

12

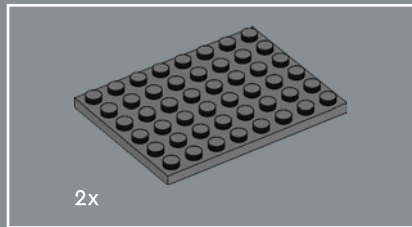
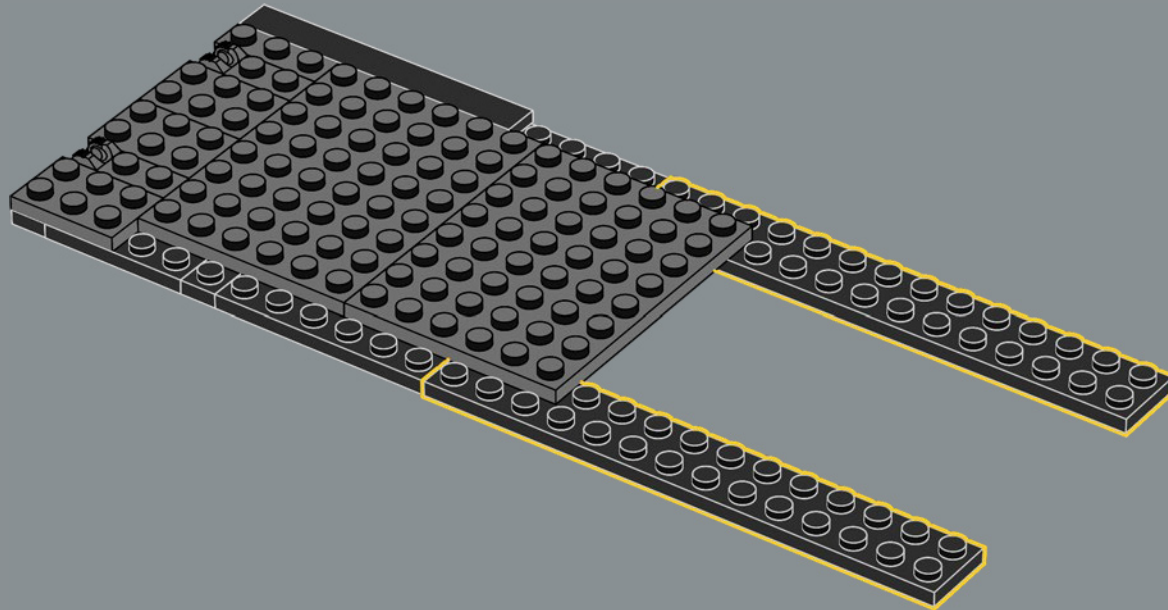

13

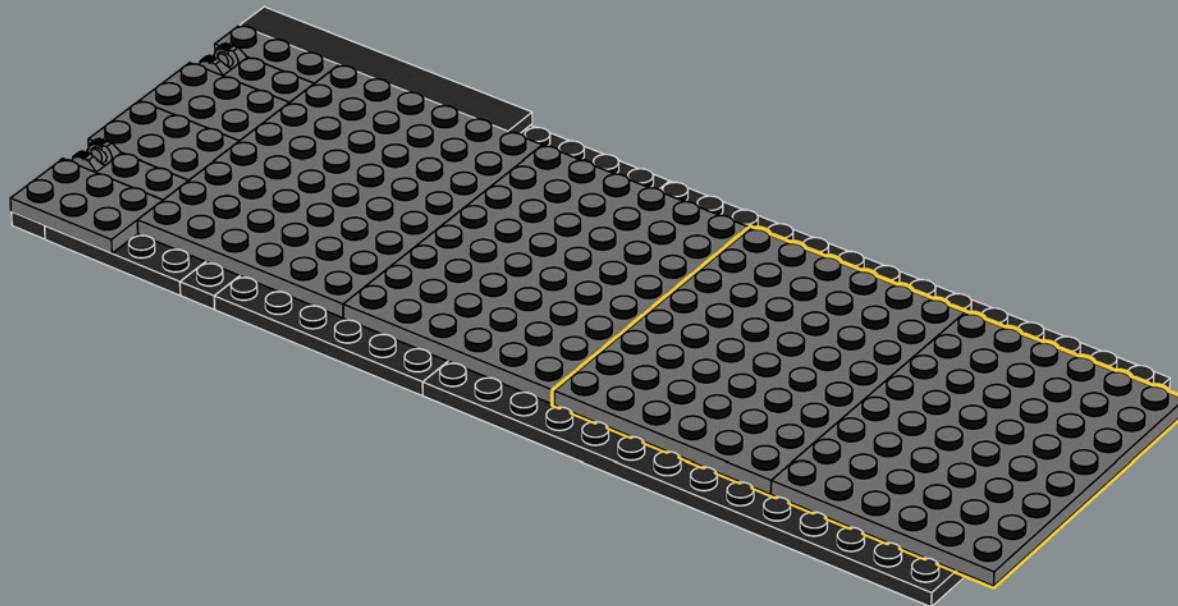

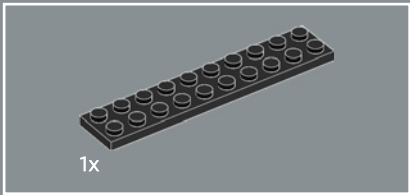

14

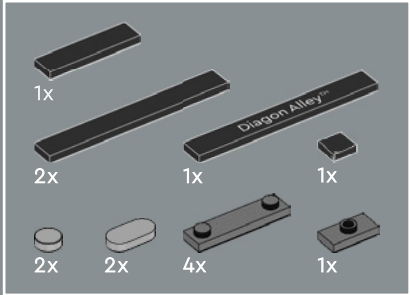
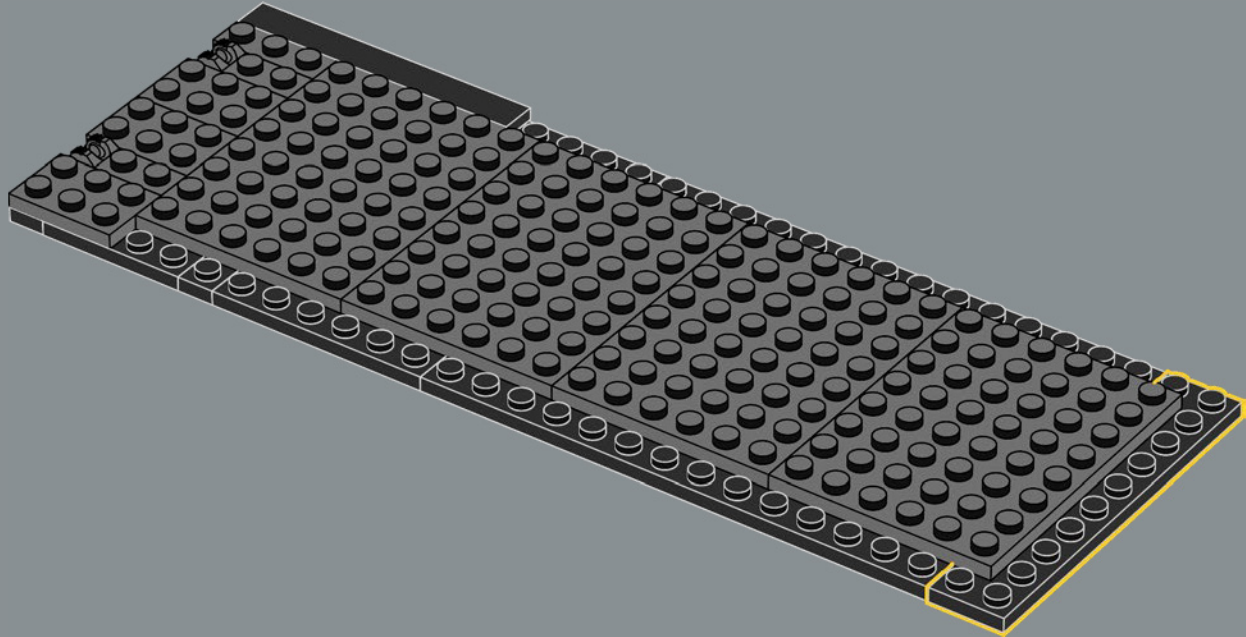

15

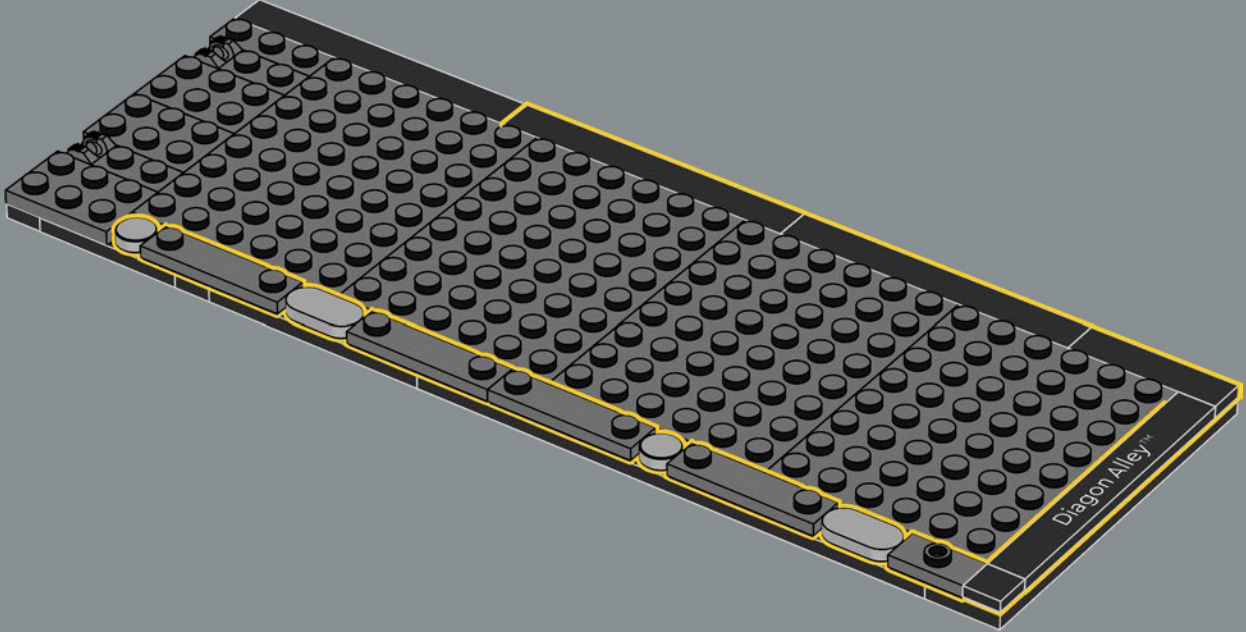

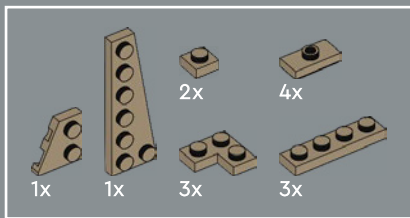

16

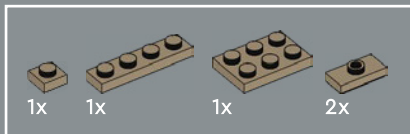
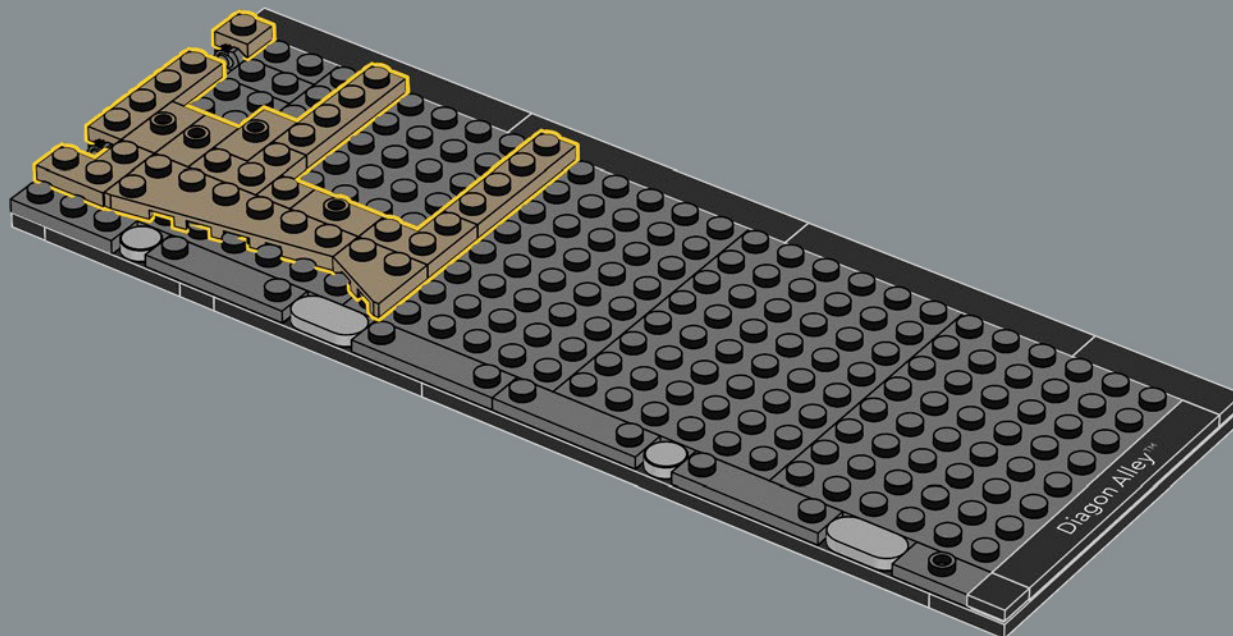

17

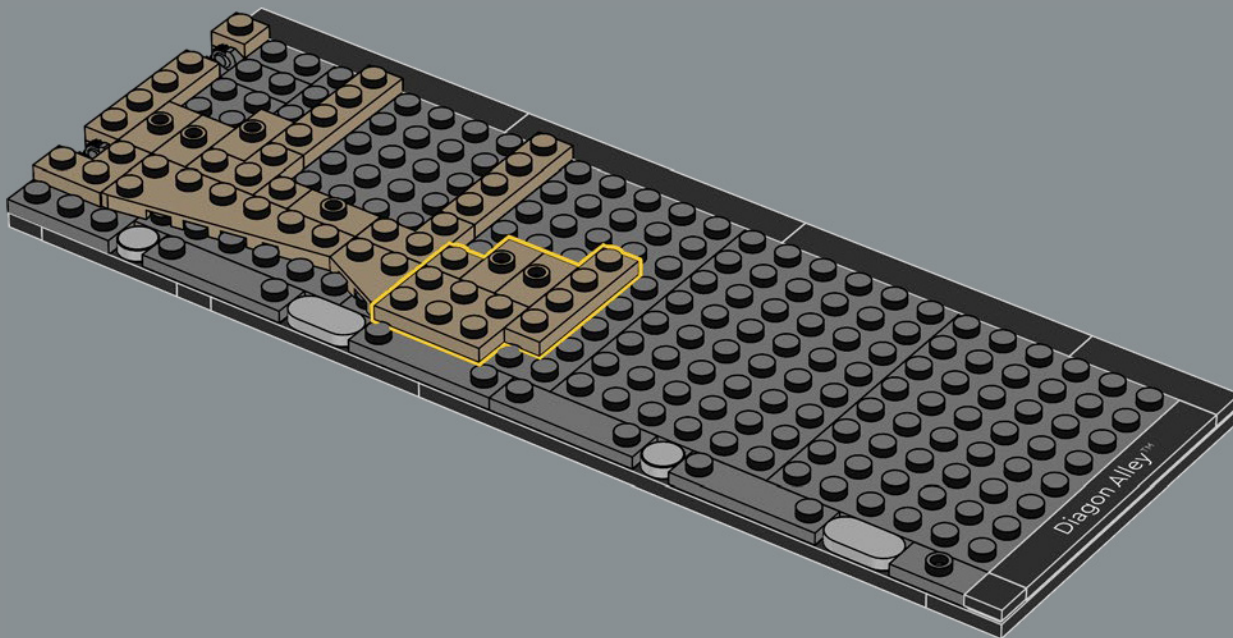

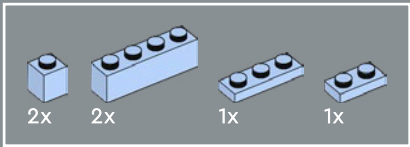

18

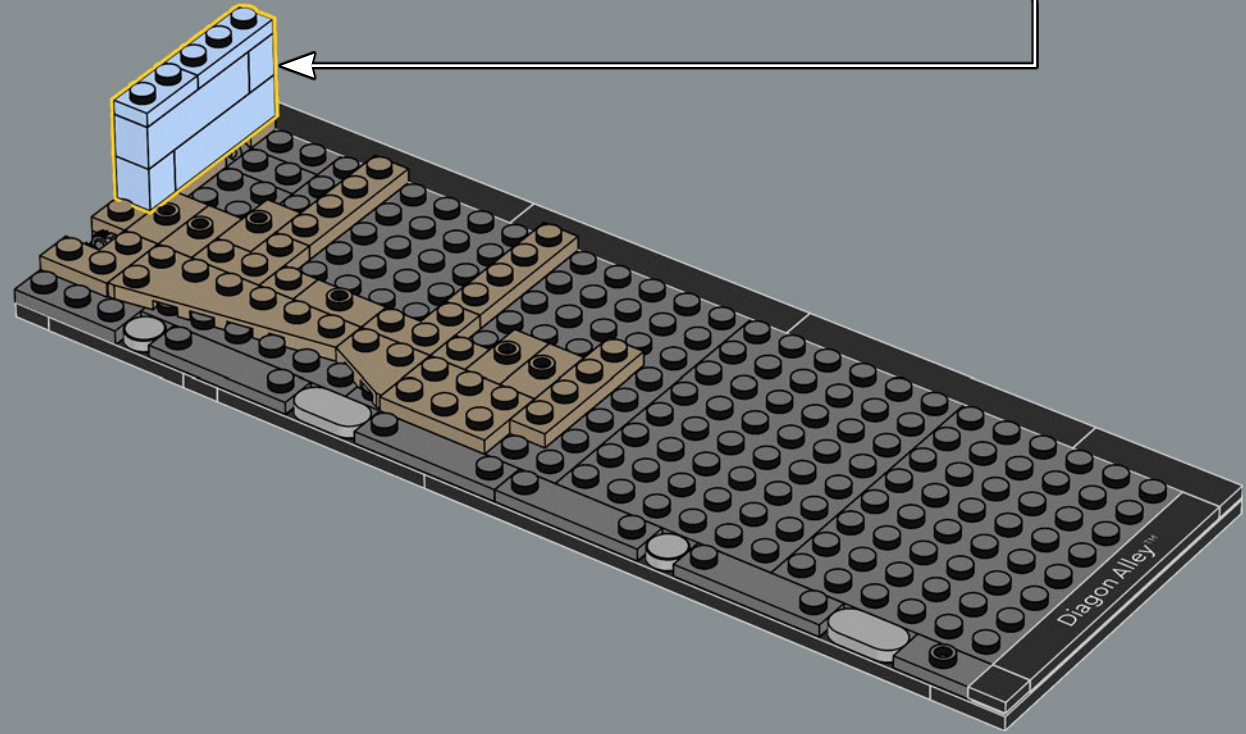
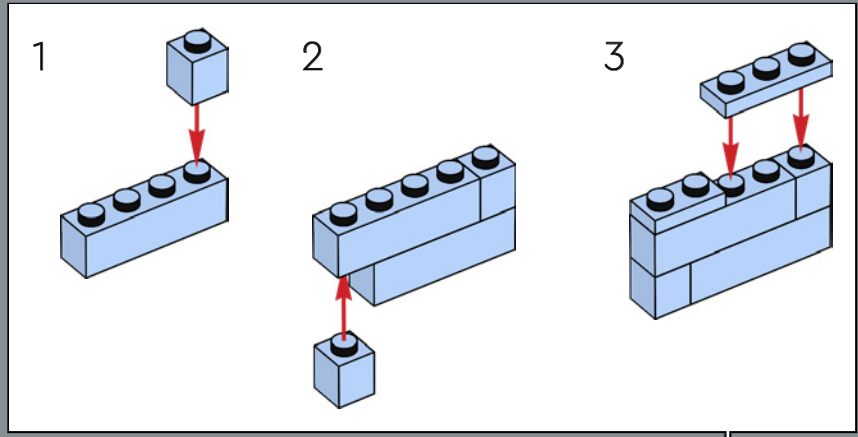

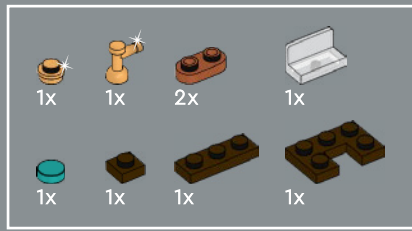

19

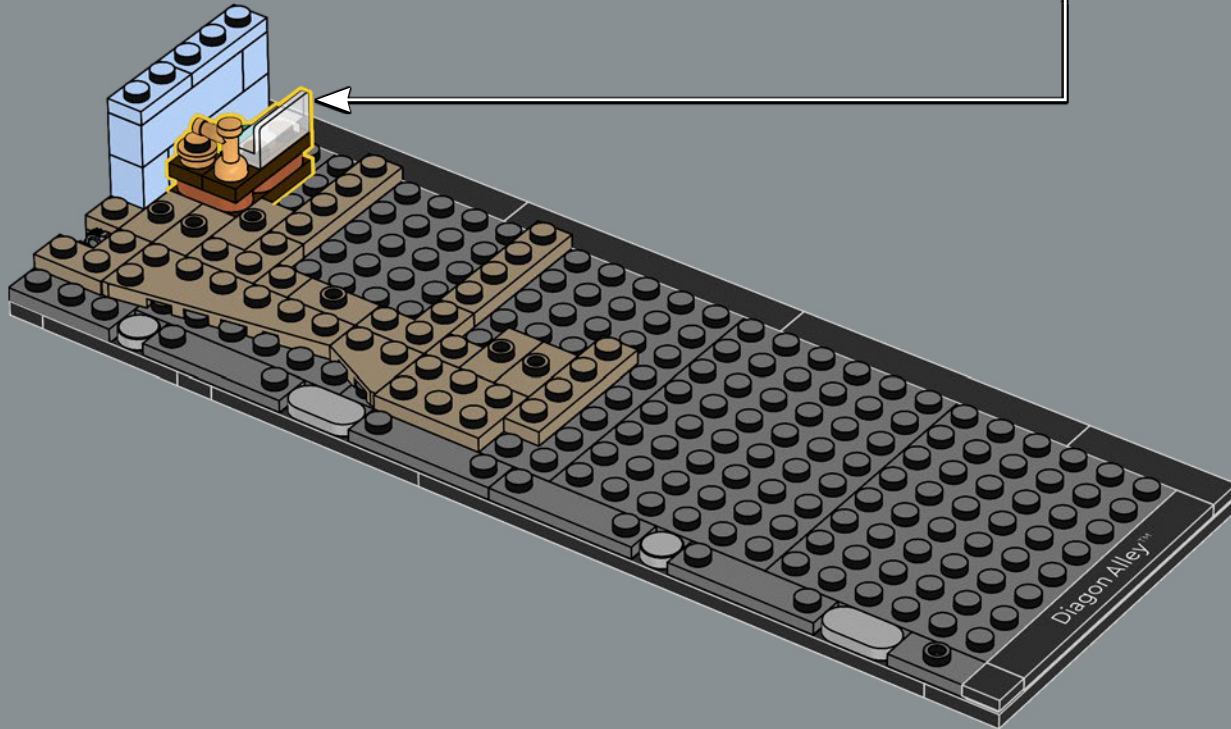
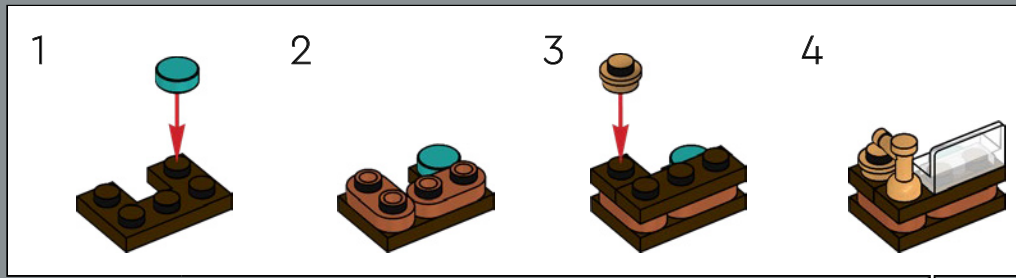



20

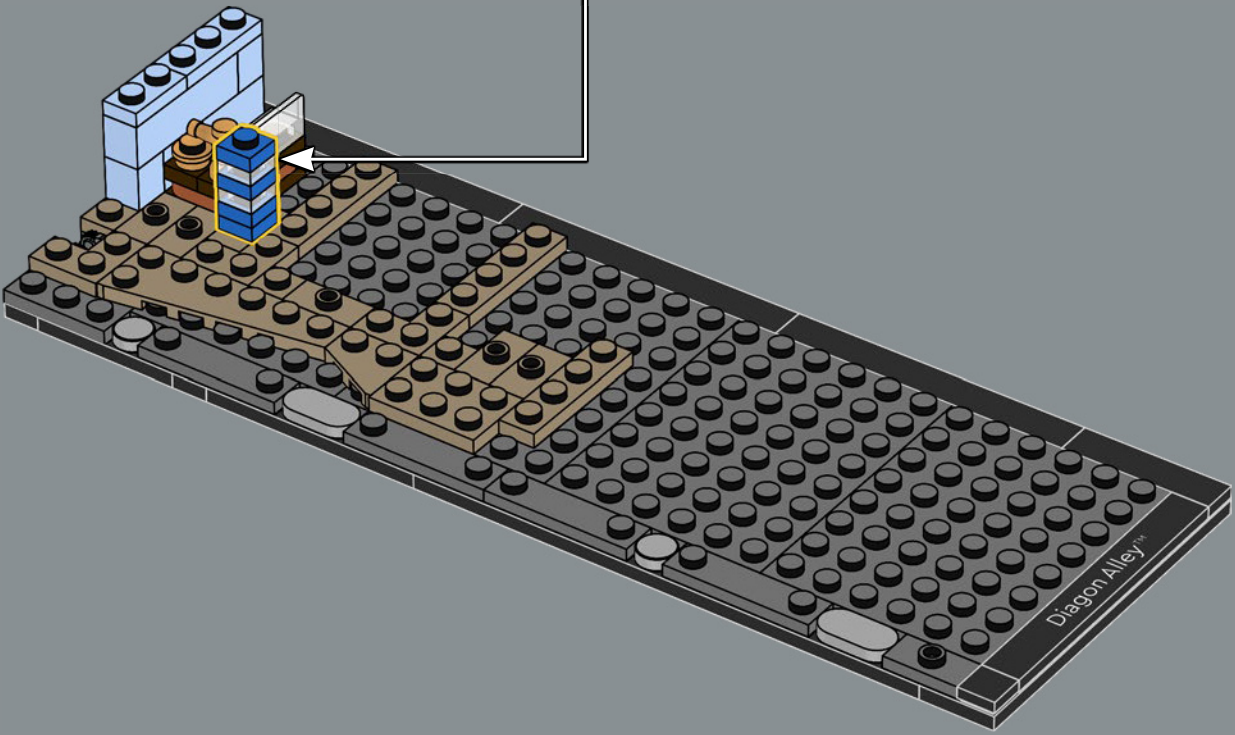
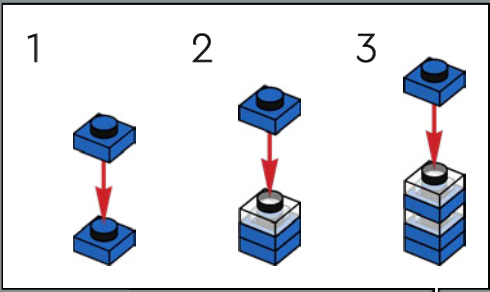

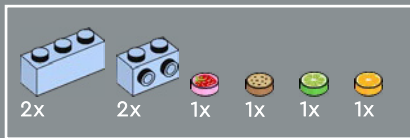

21

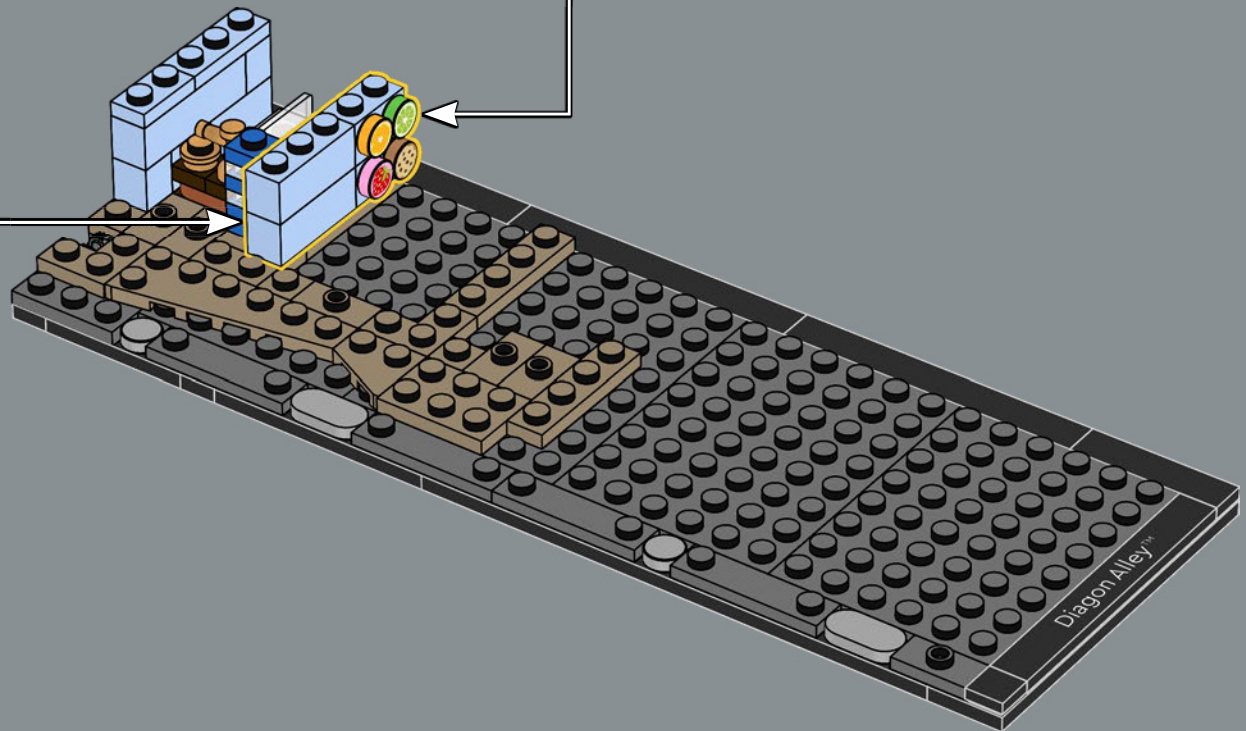
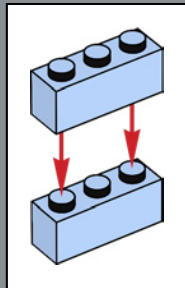
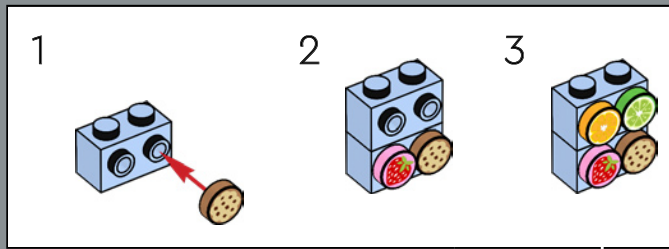

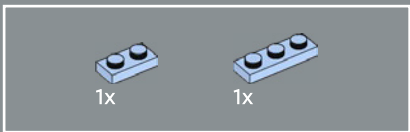

22

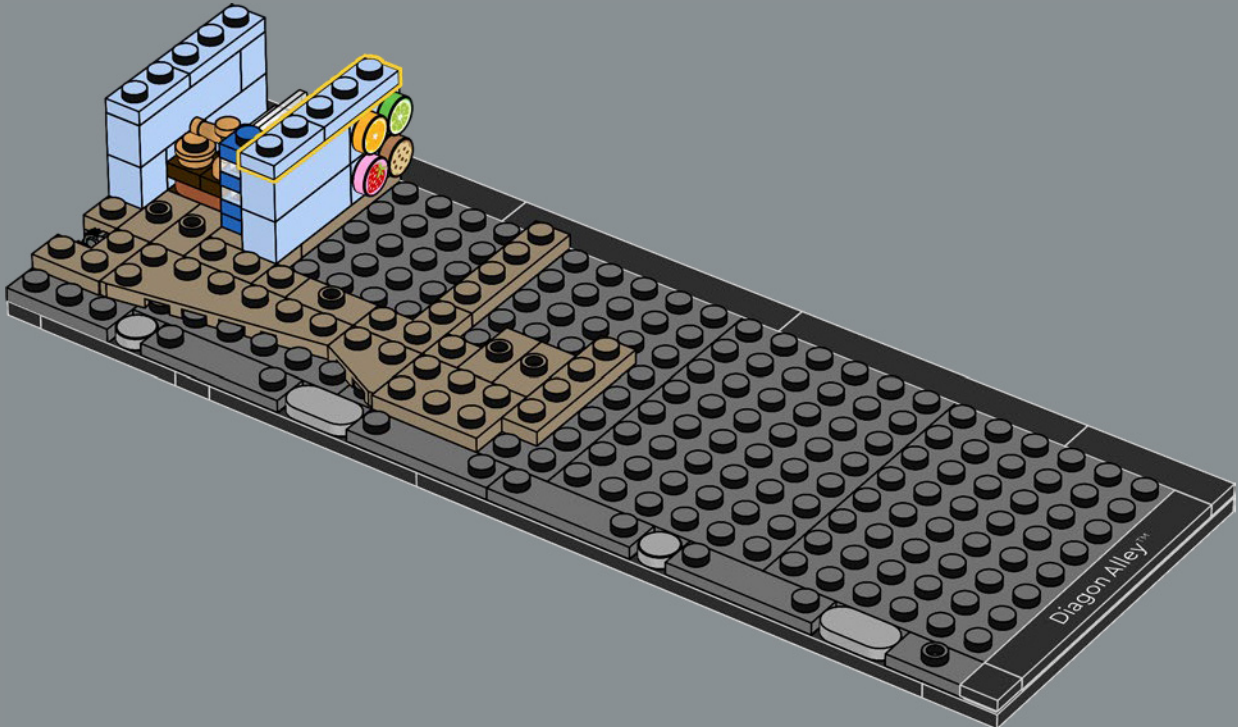



23

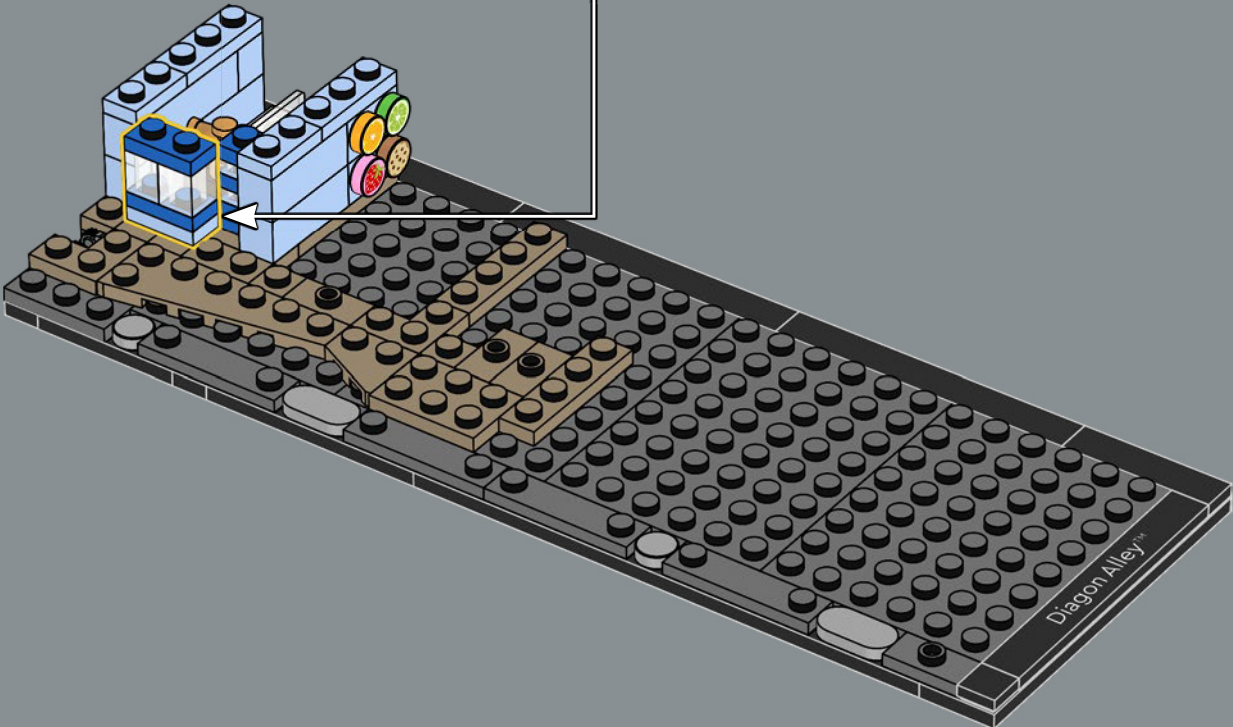
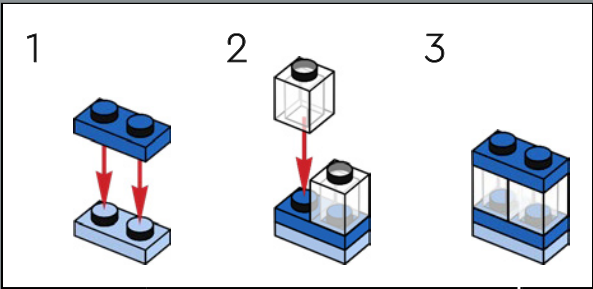



3x

24

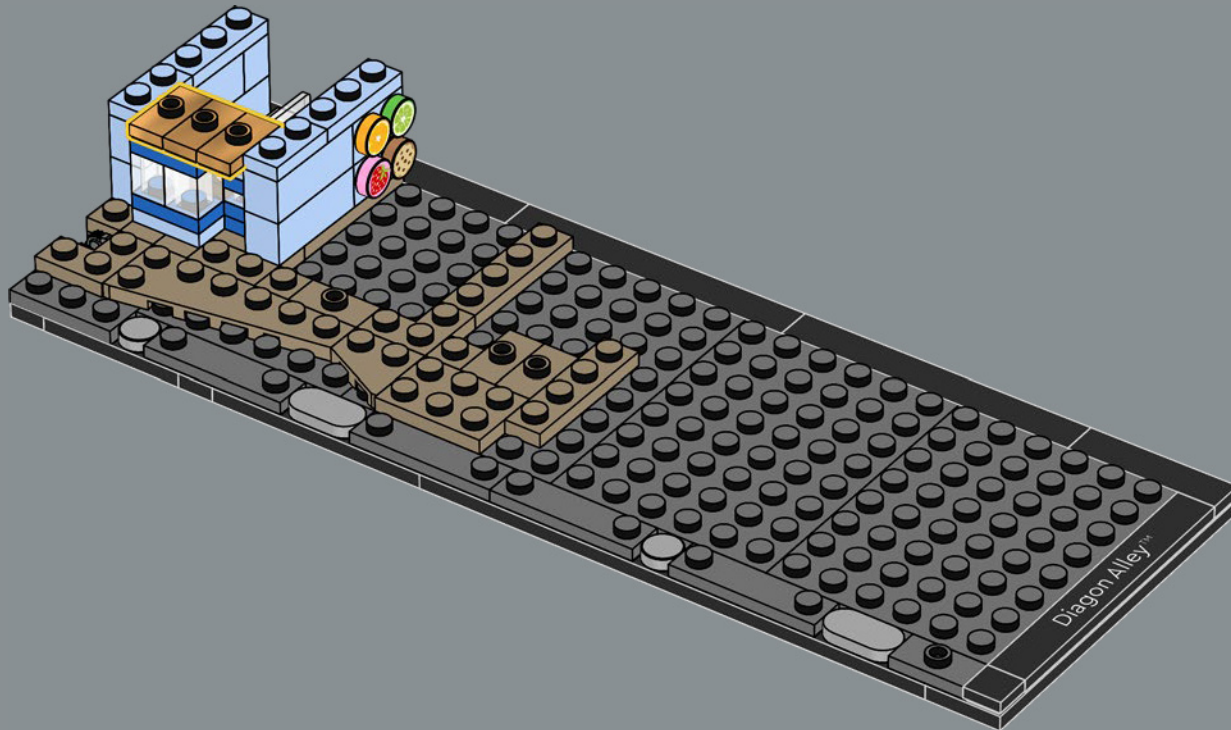

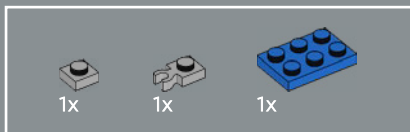

25

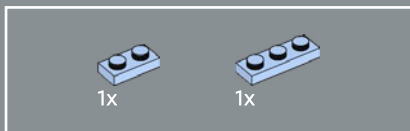
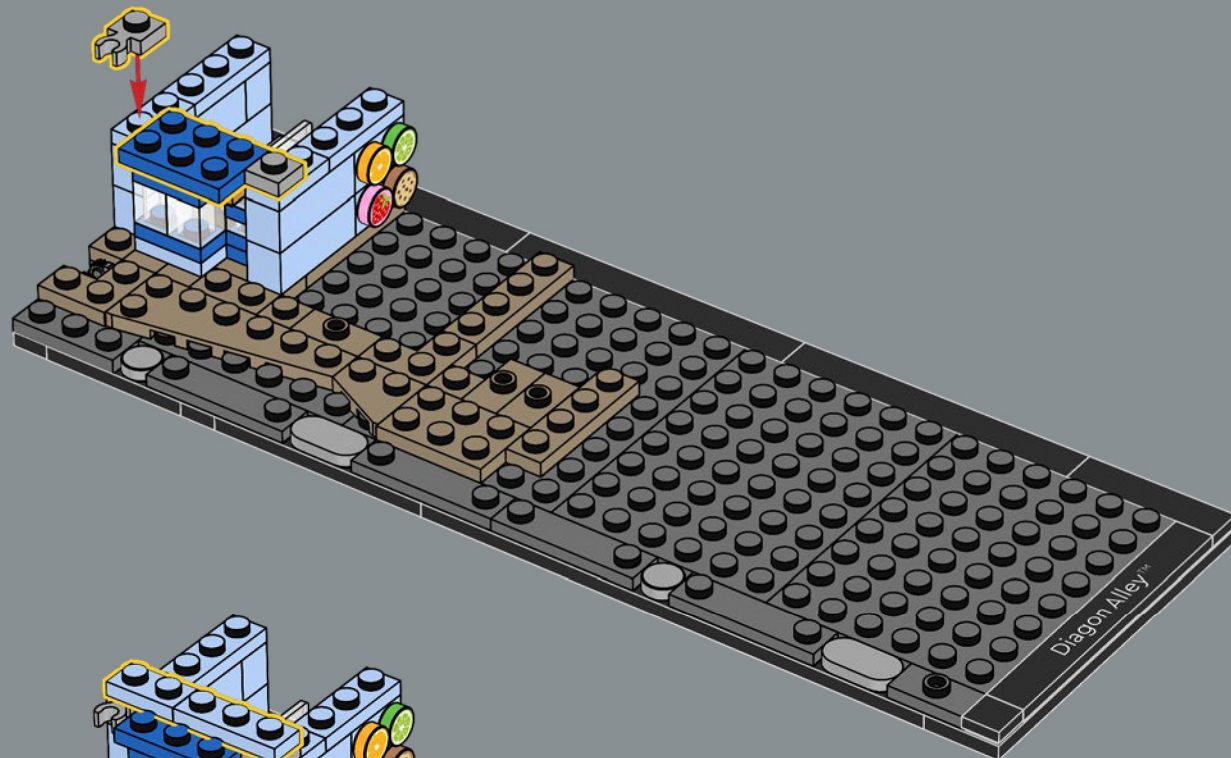

26

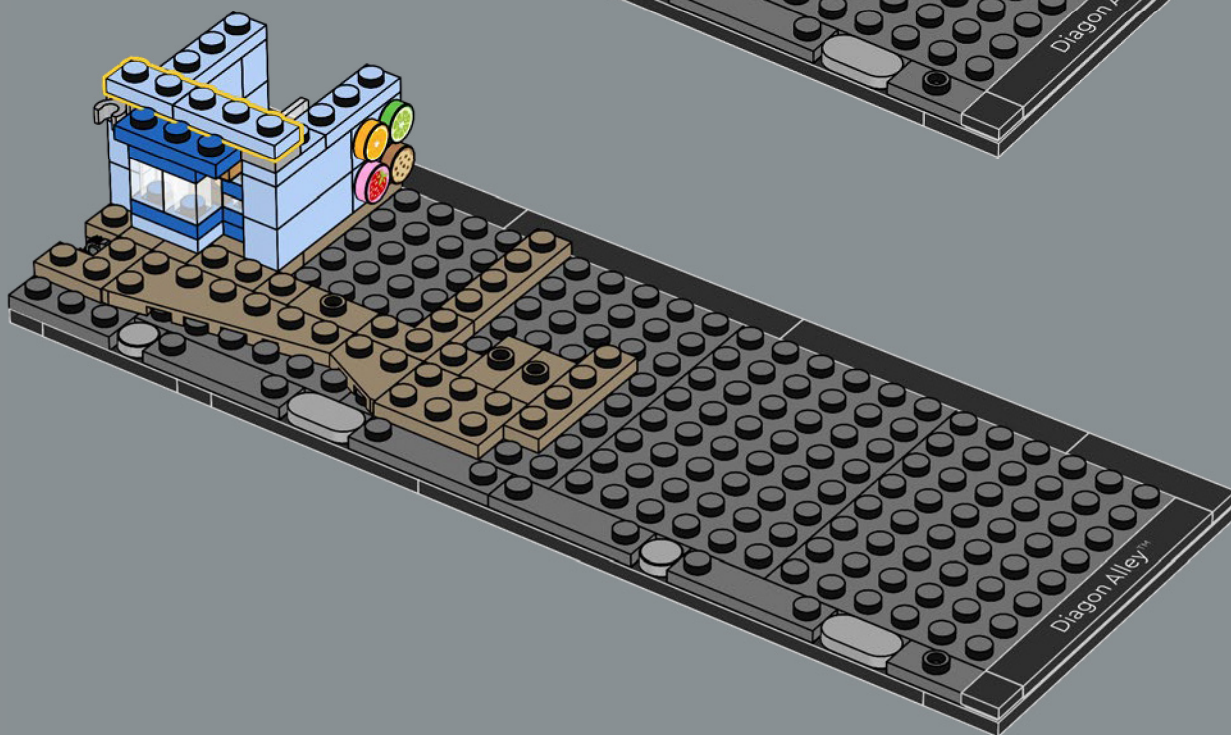

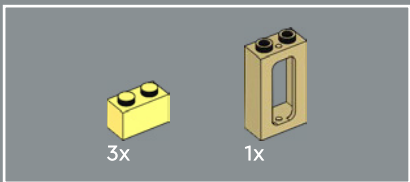

27

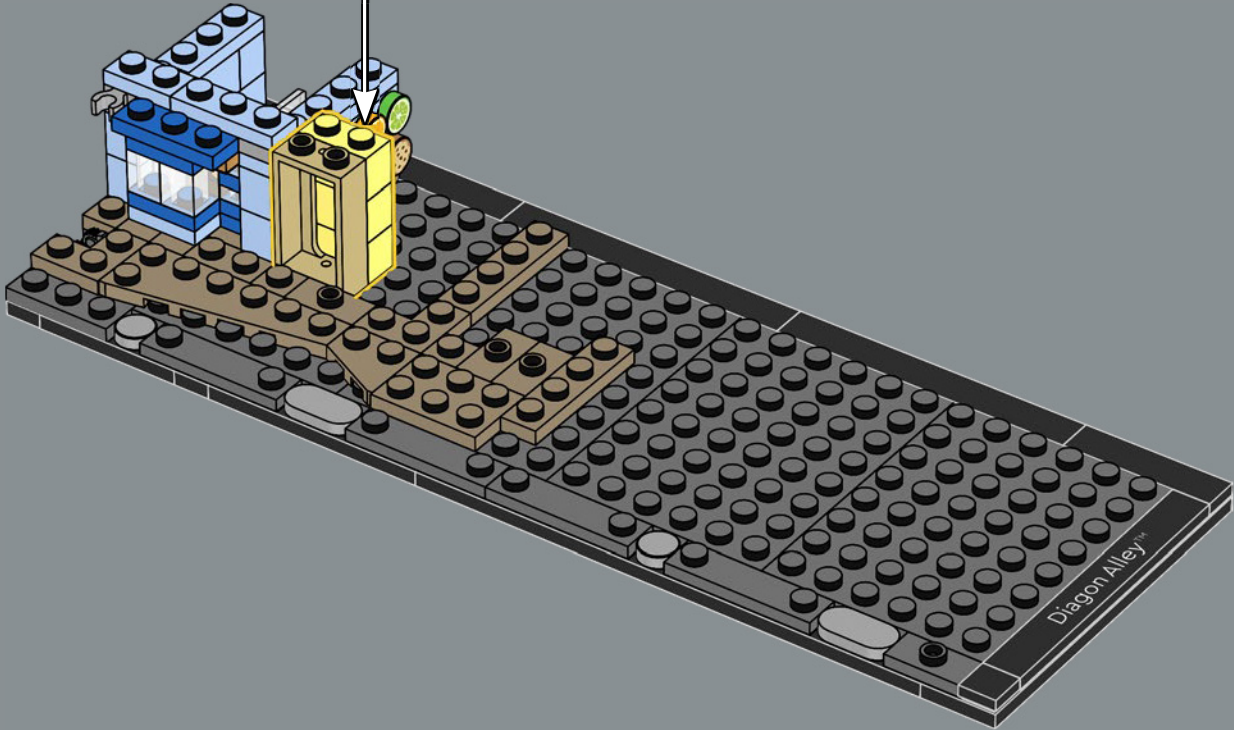
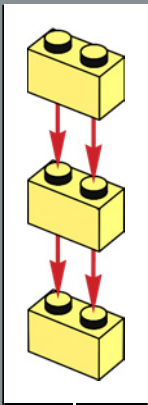

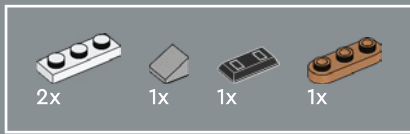

28

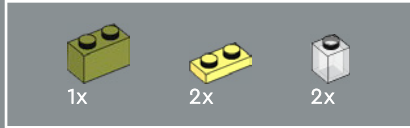
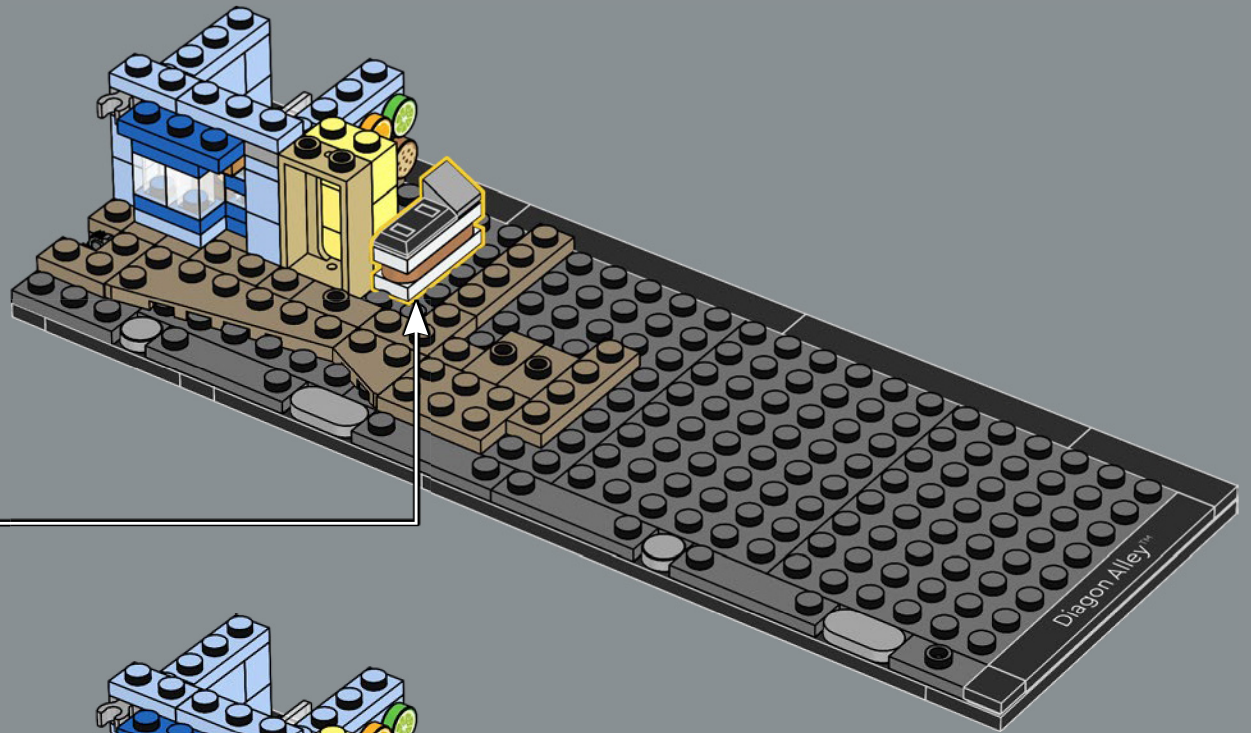
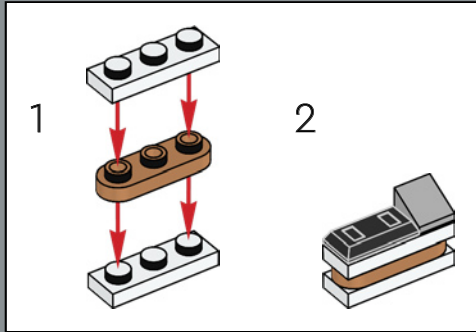

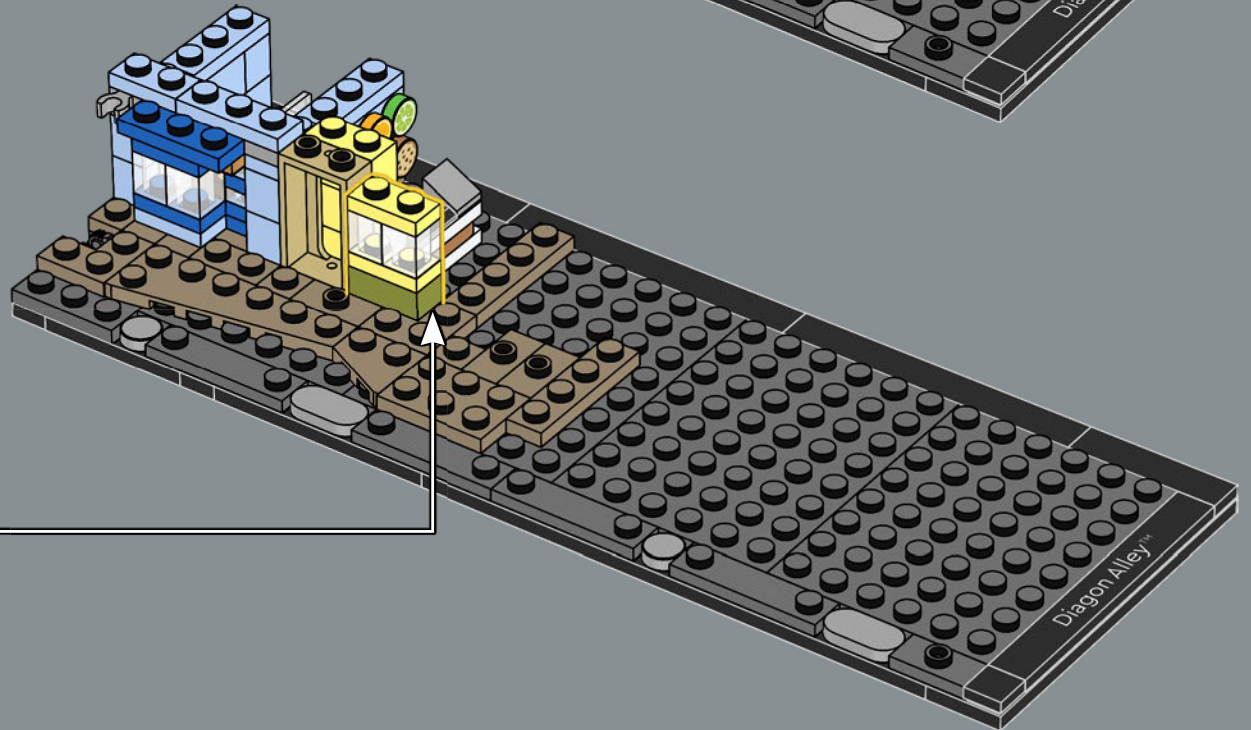
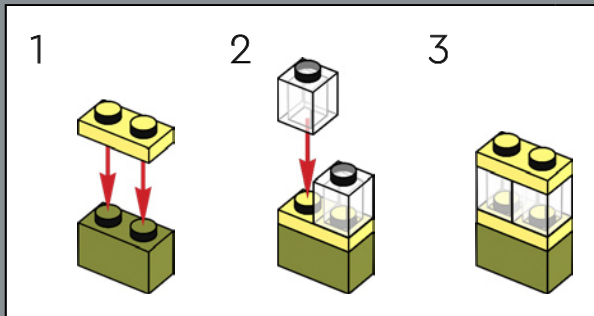

29



2x  2x 

30

  2x

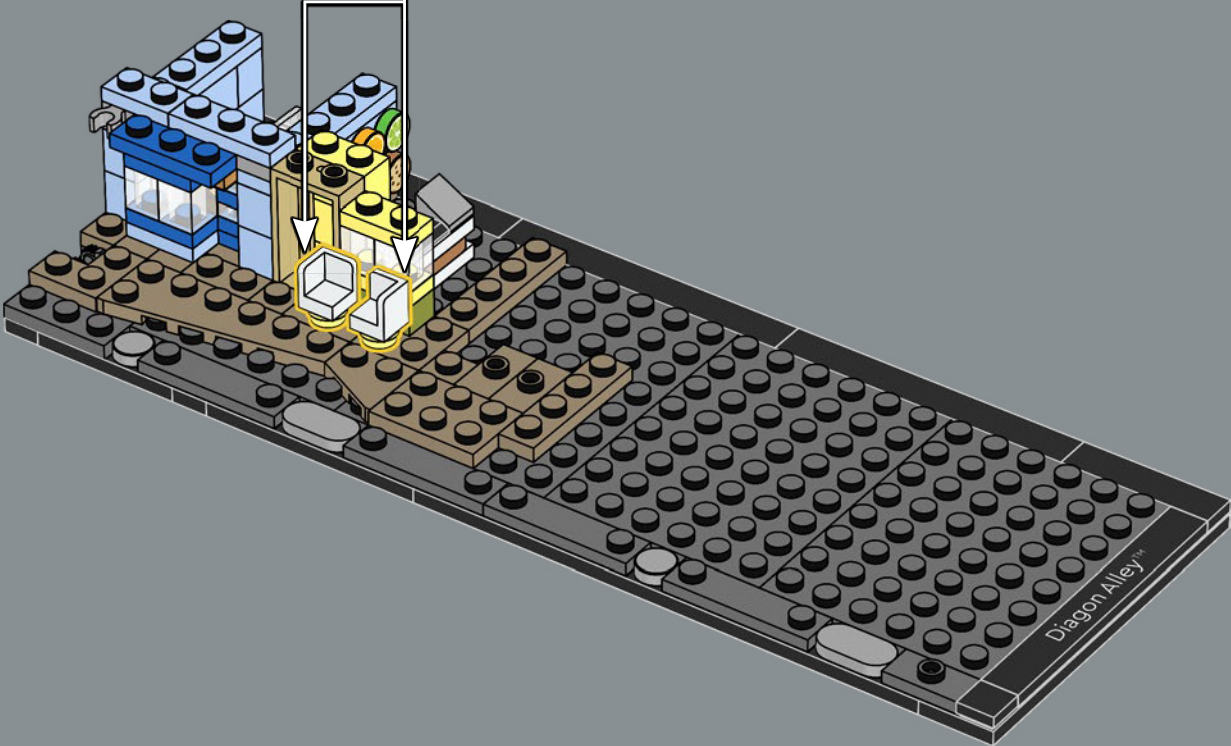

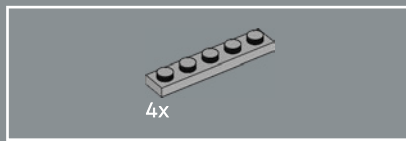

31

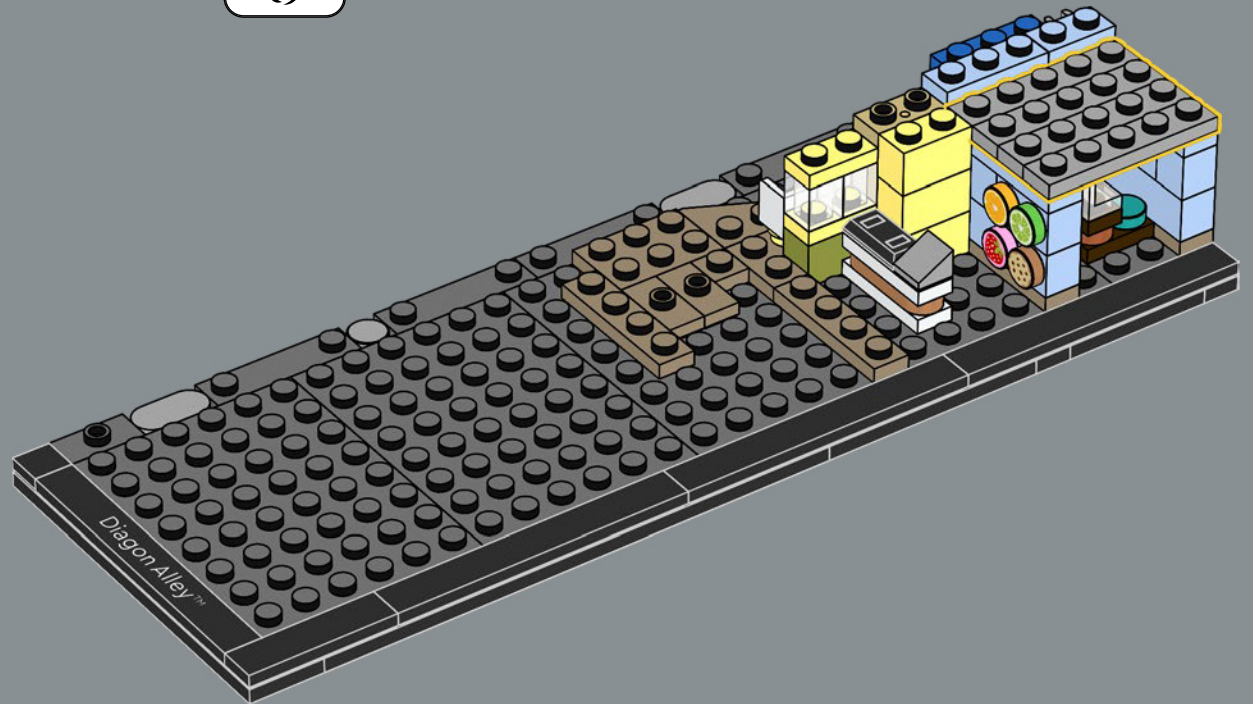

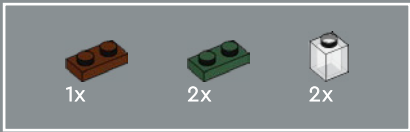

32

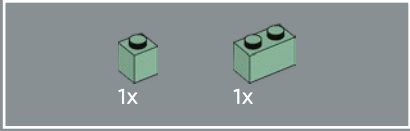
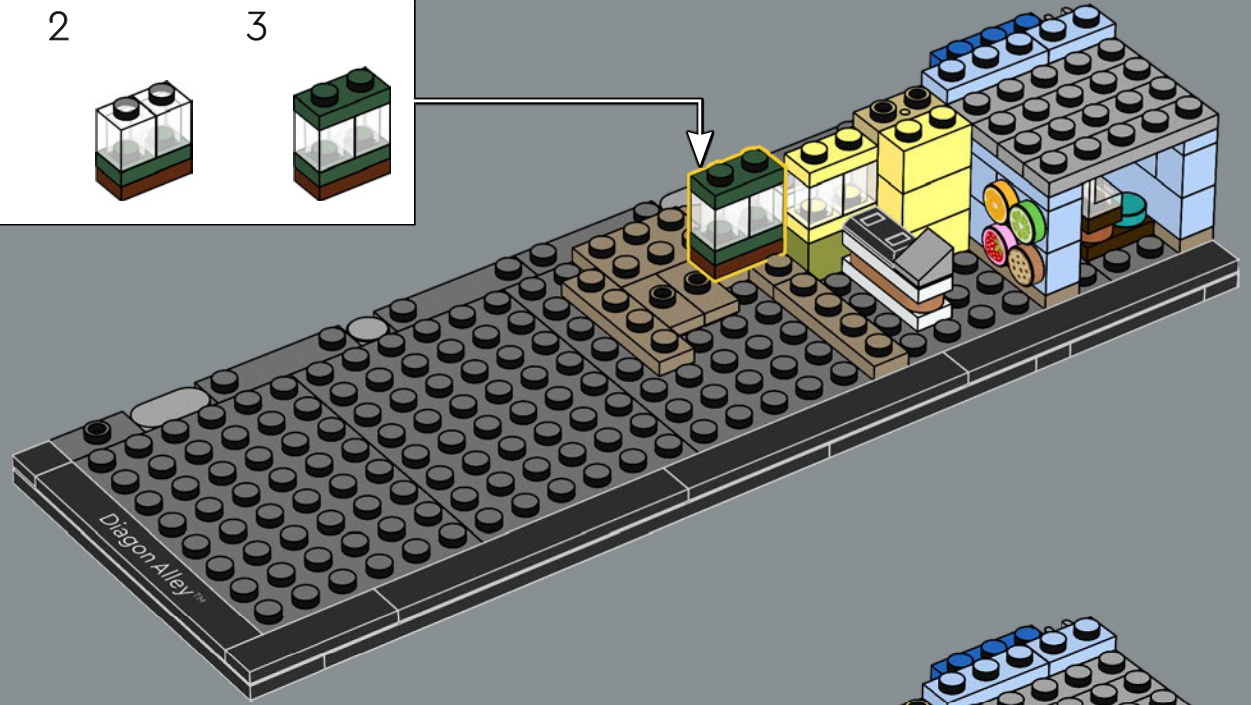
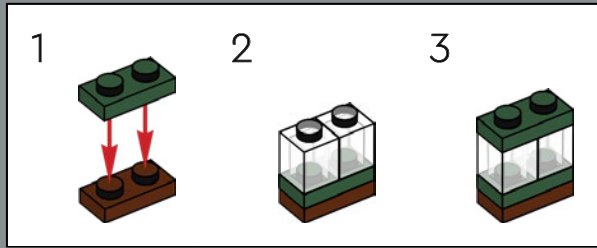

33

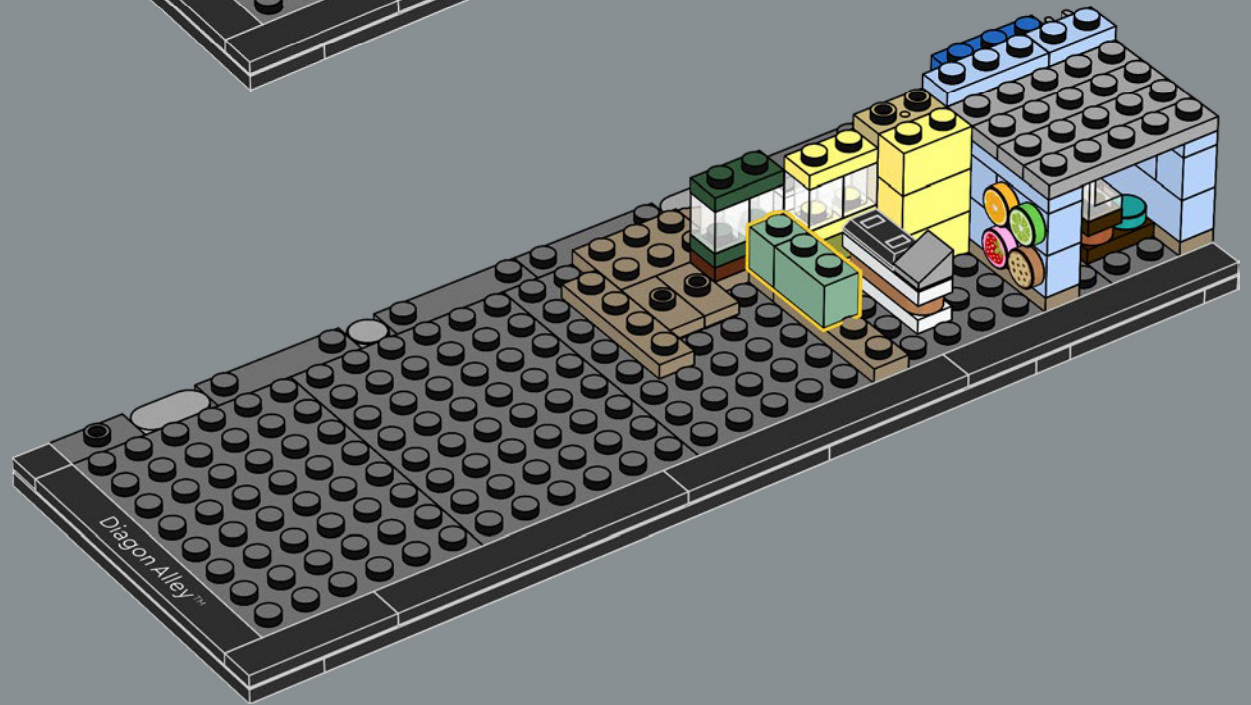

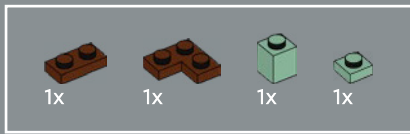

34

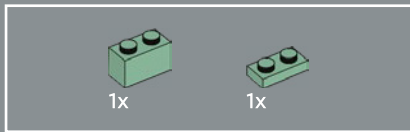
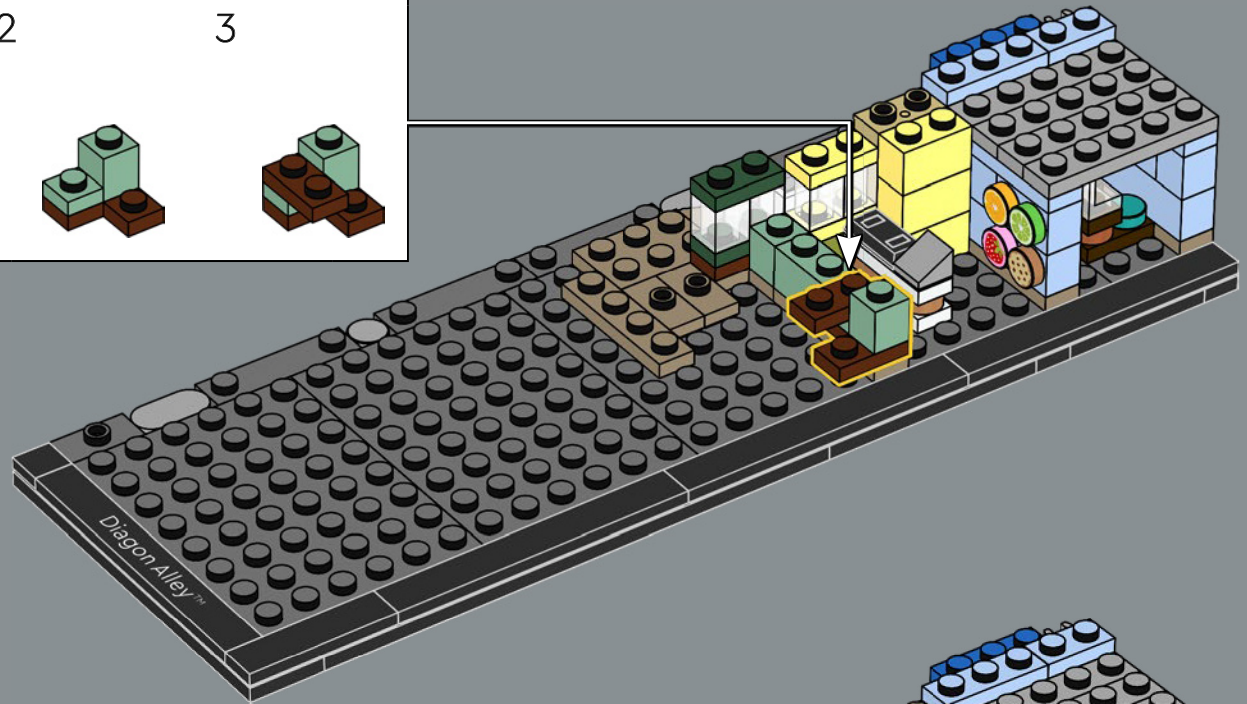
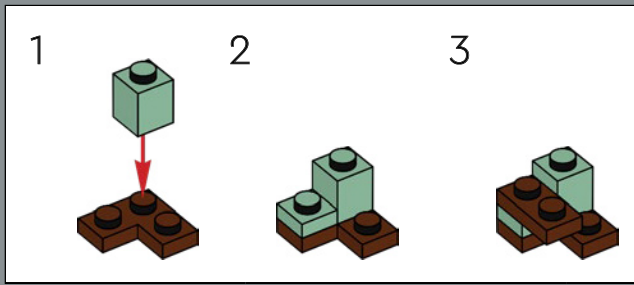

35

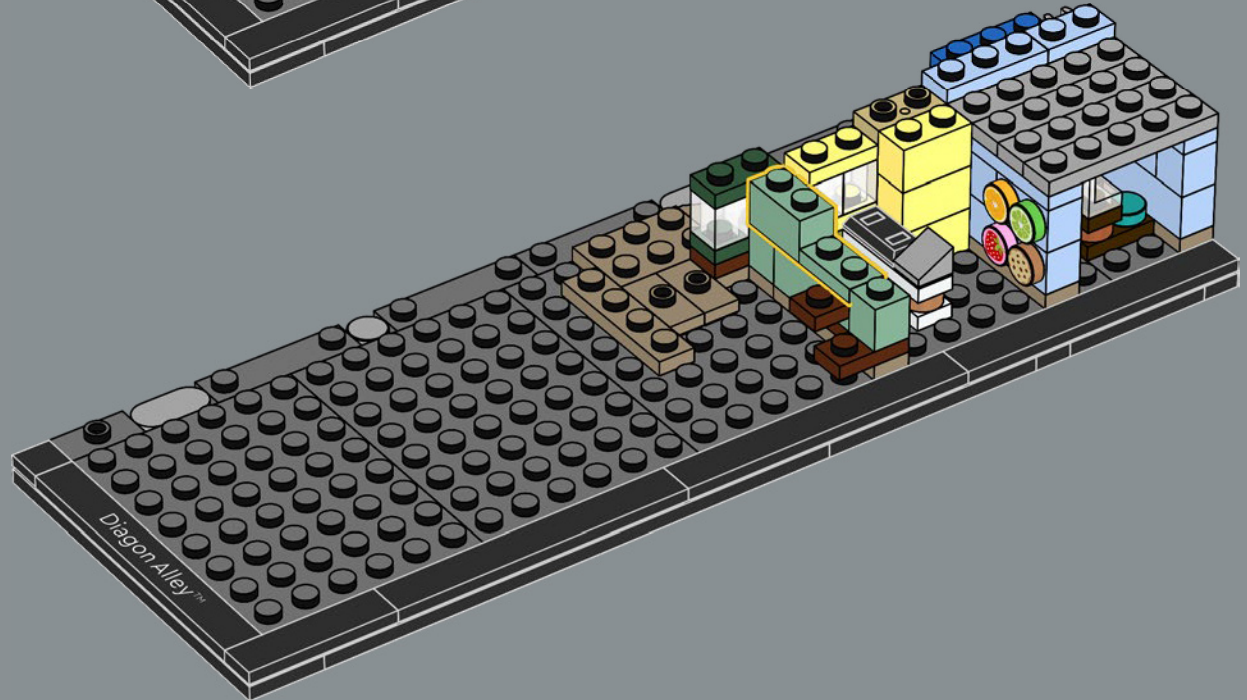

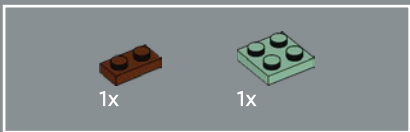

36

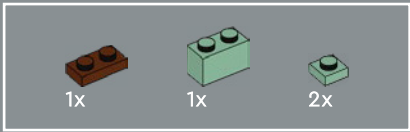
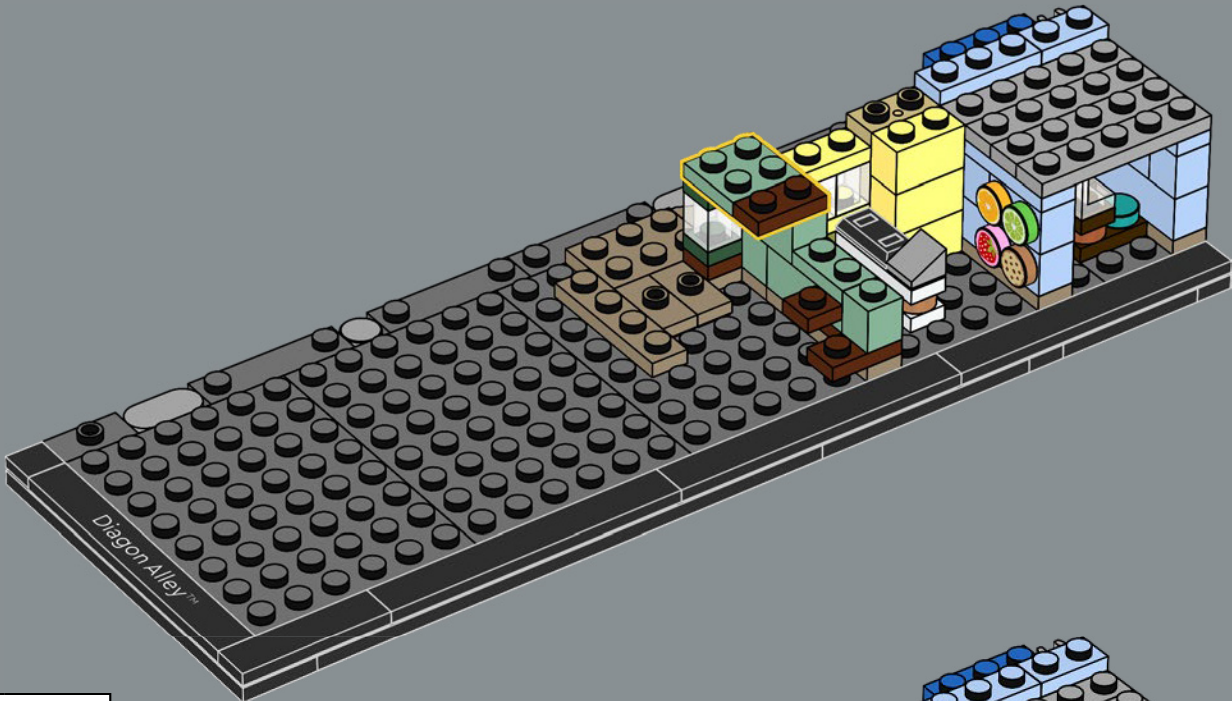

37

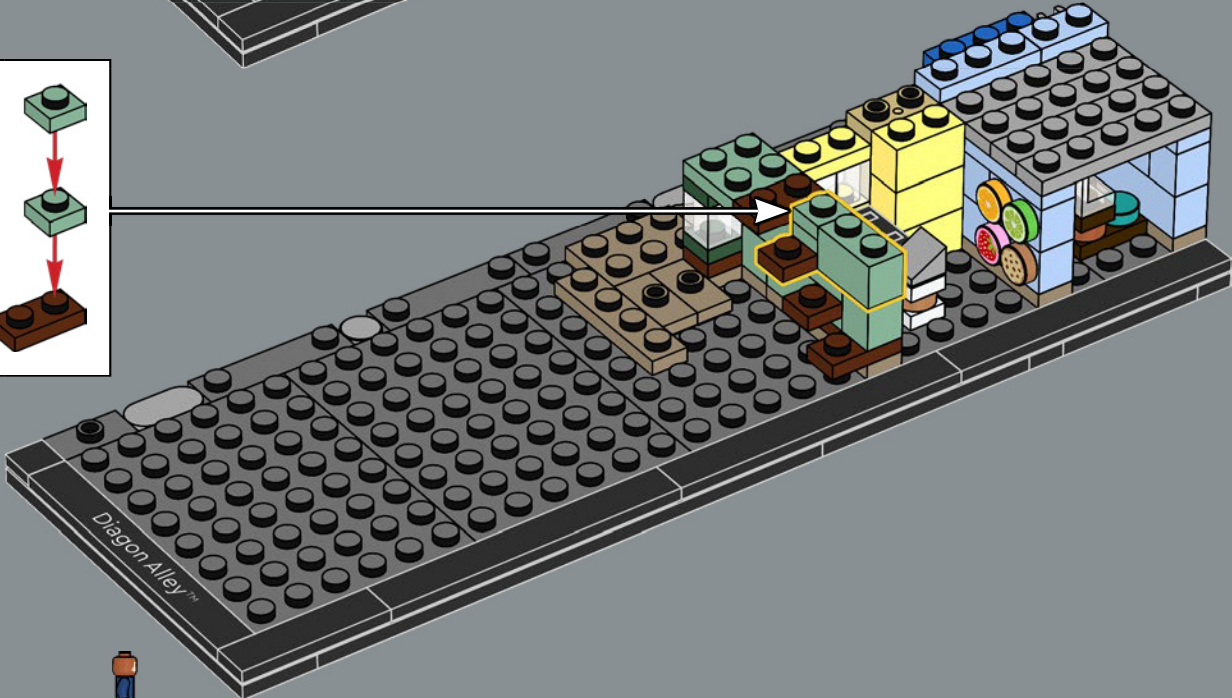
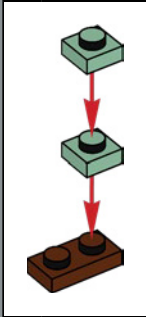

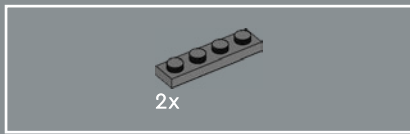

38

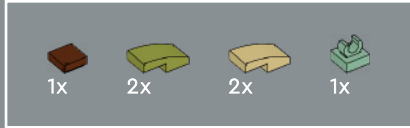
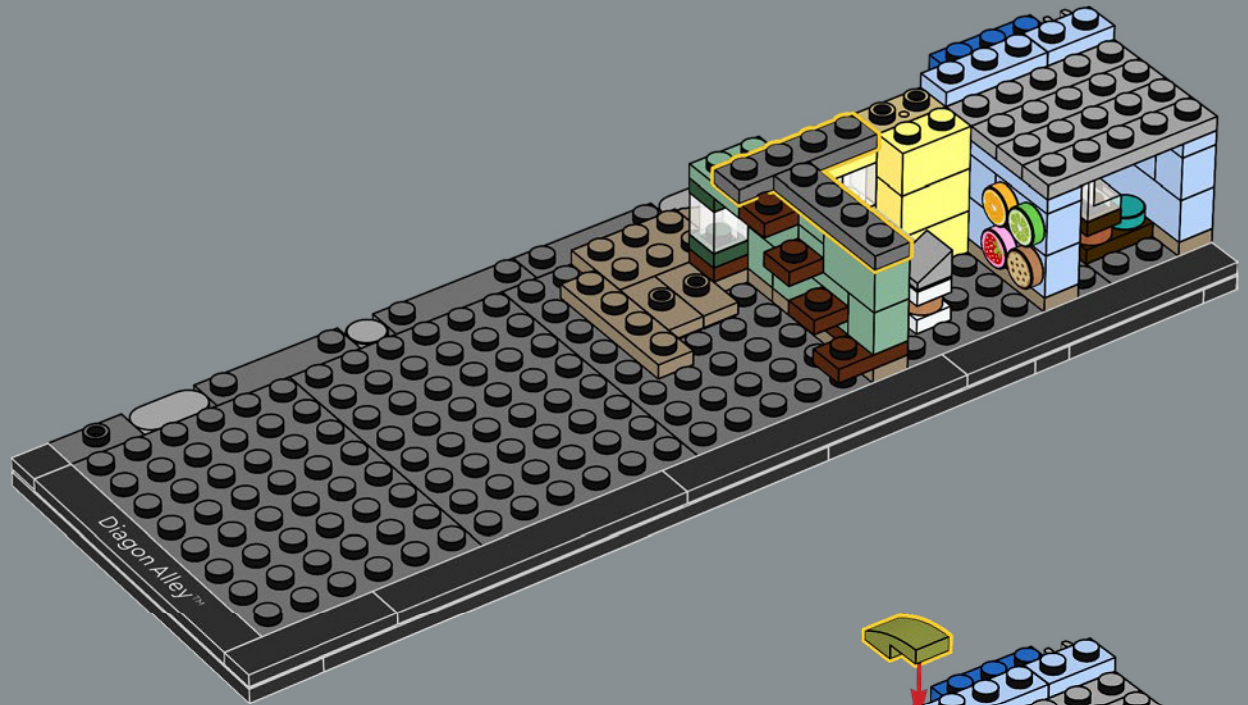

39

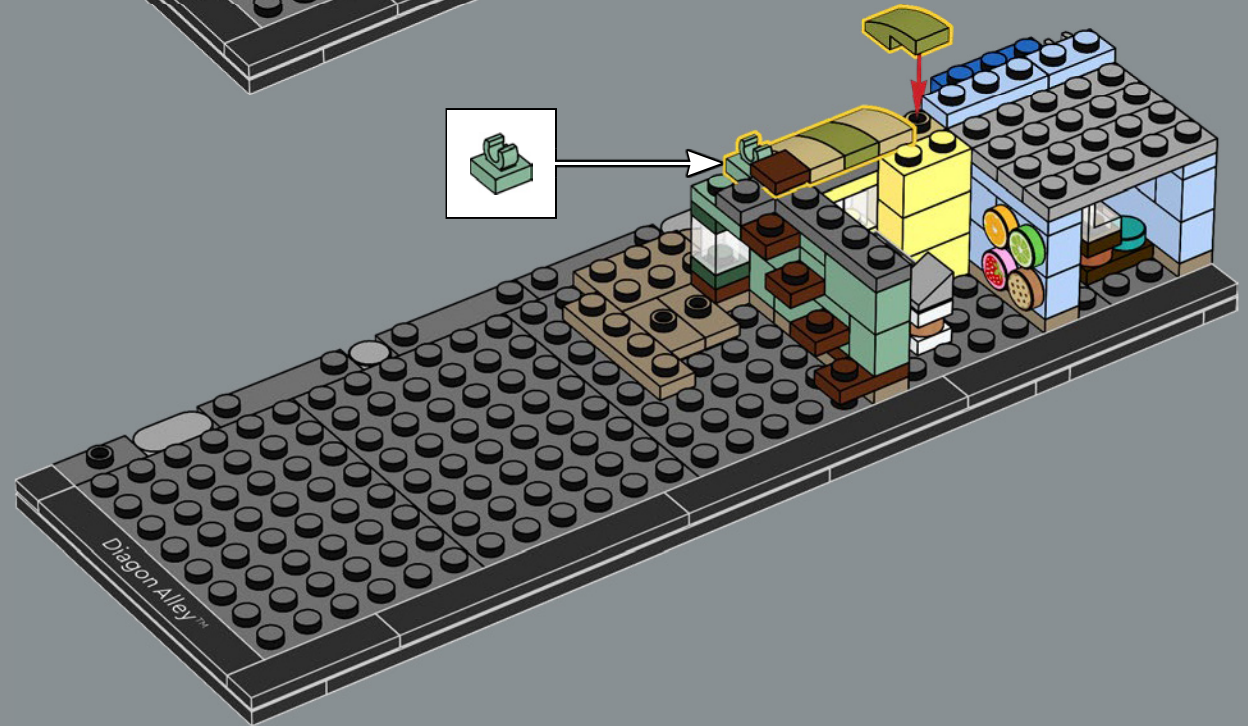
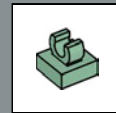

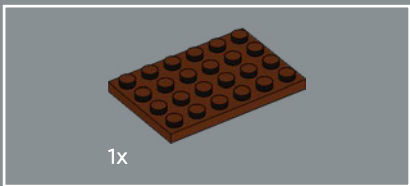

40

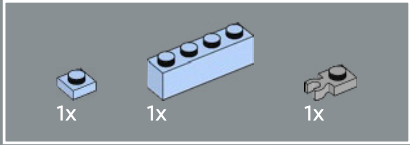
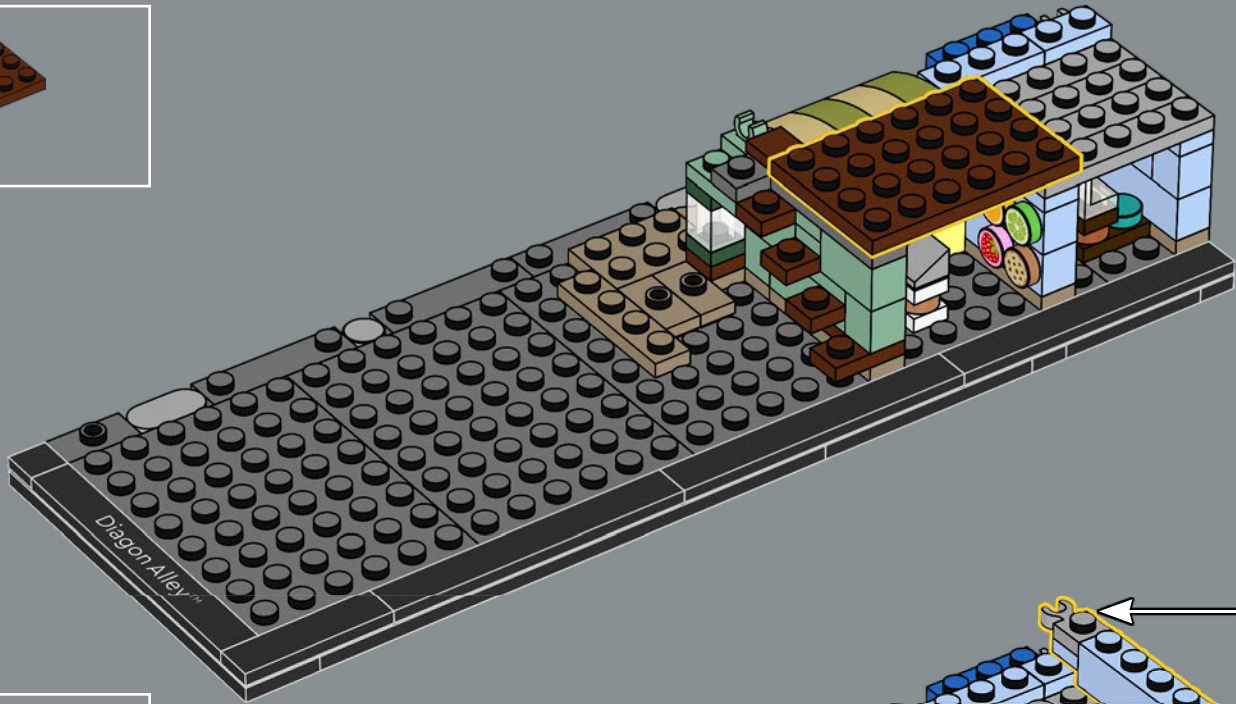

41

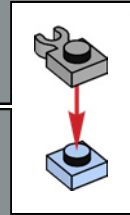

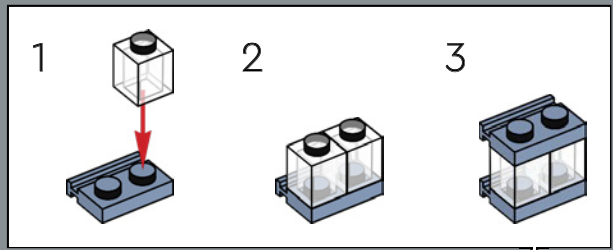
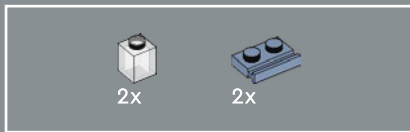

42

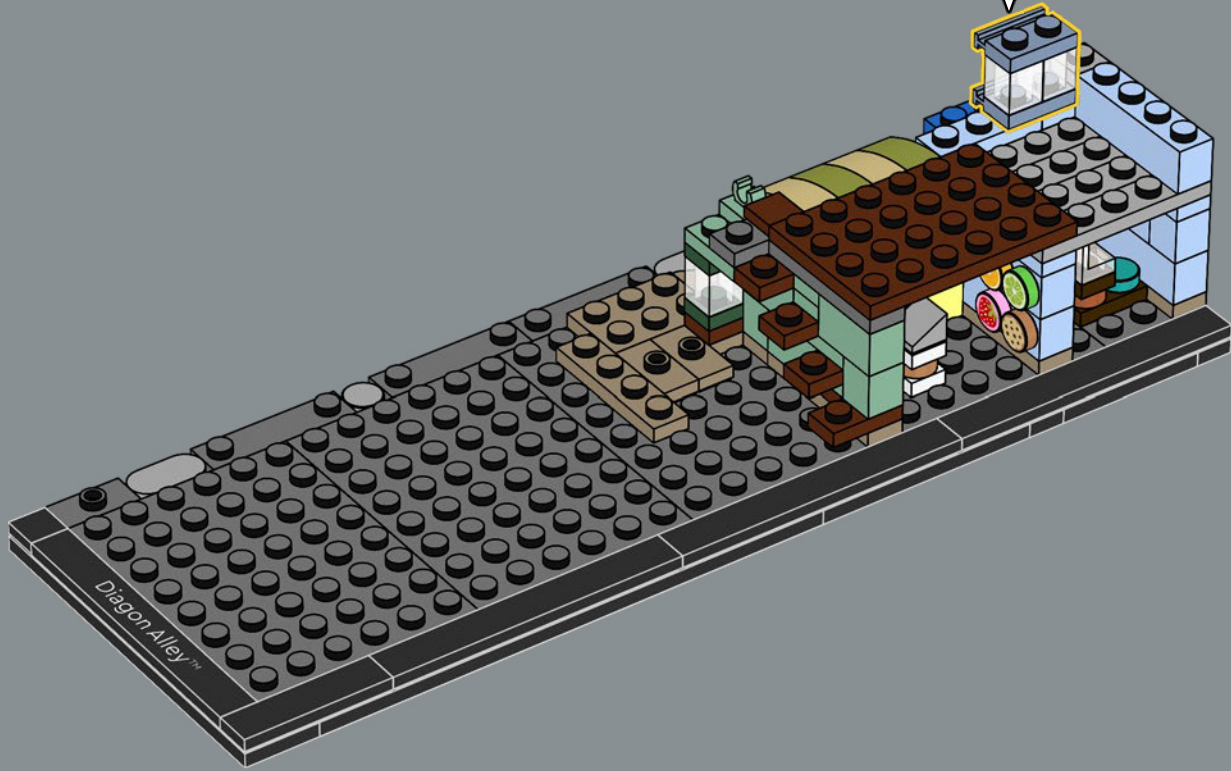

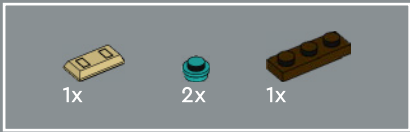

43

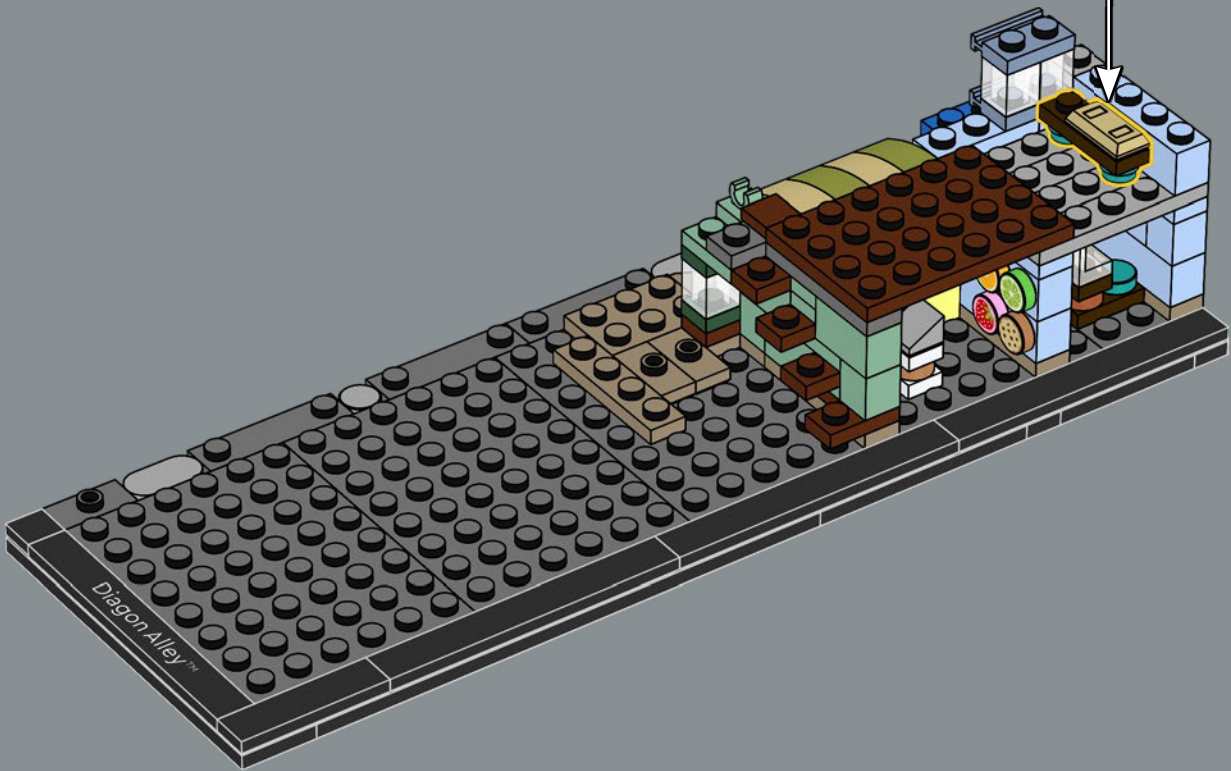
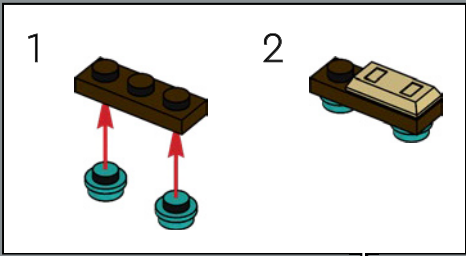

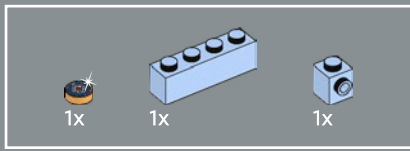

44



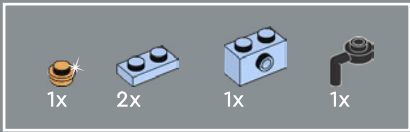

45

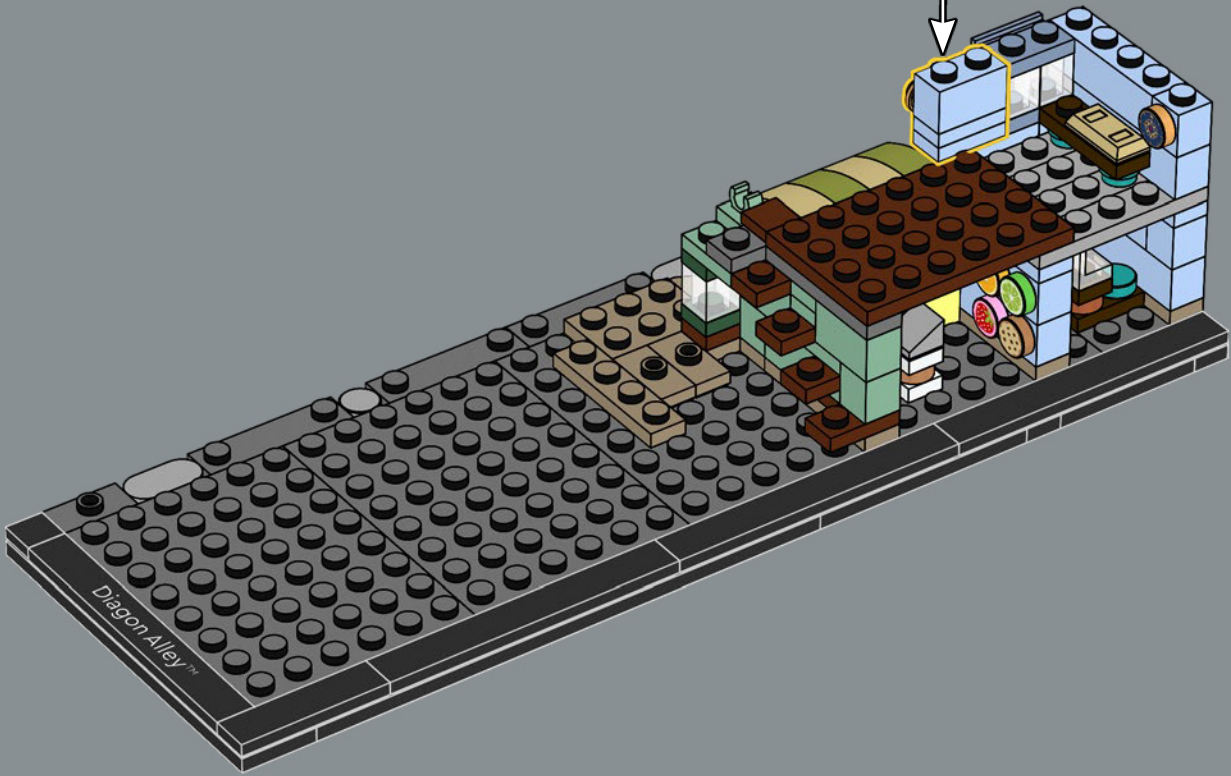
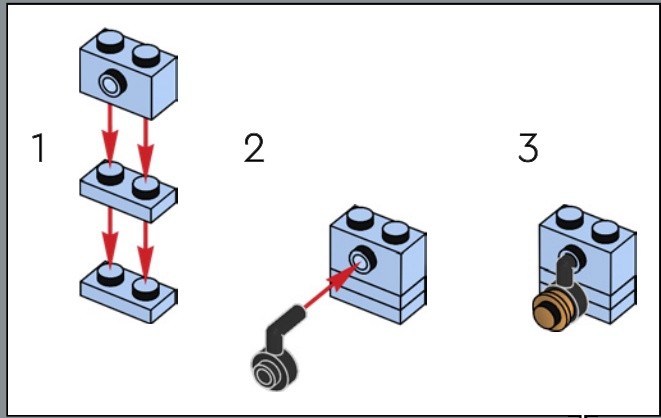



46

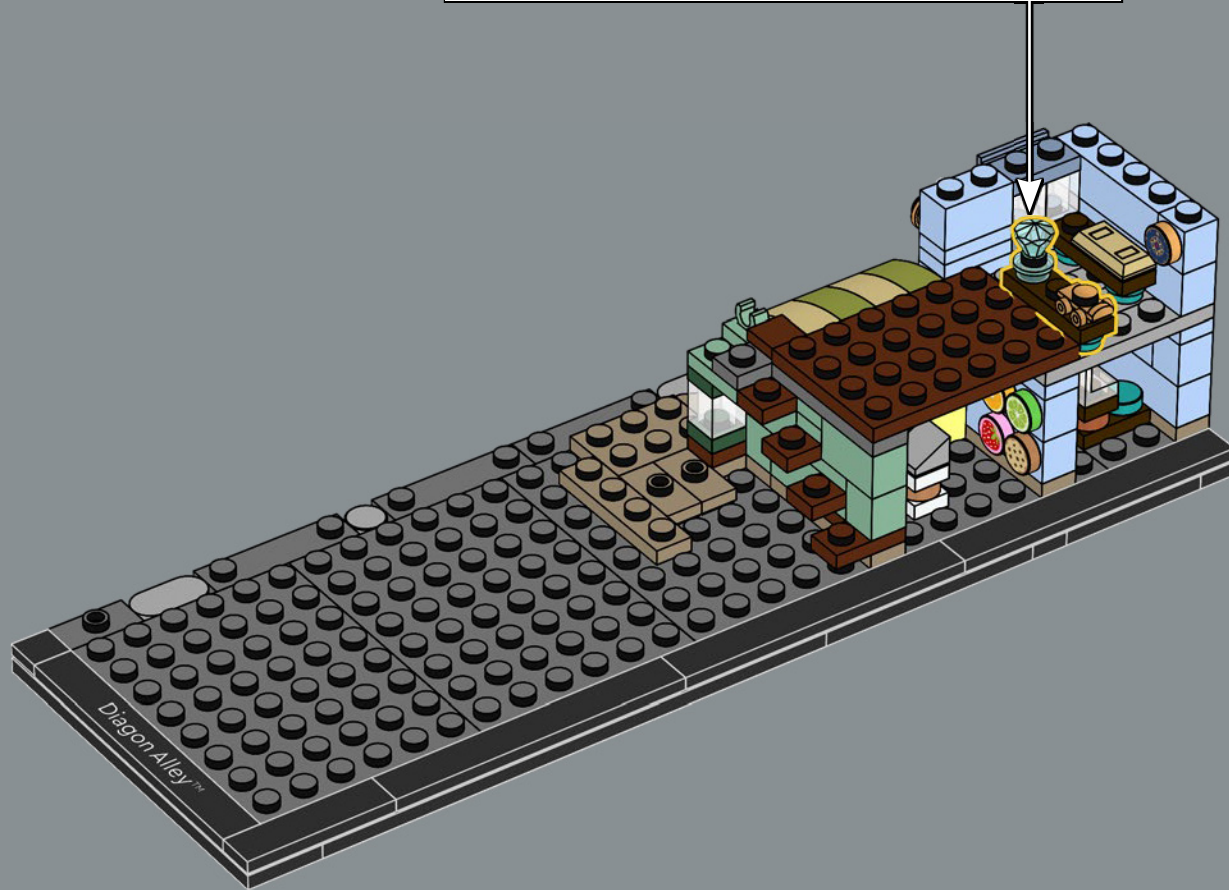
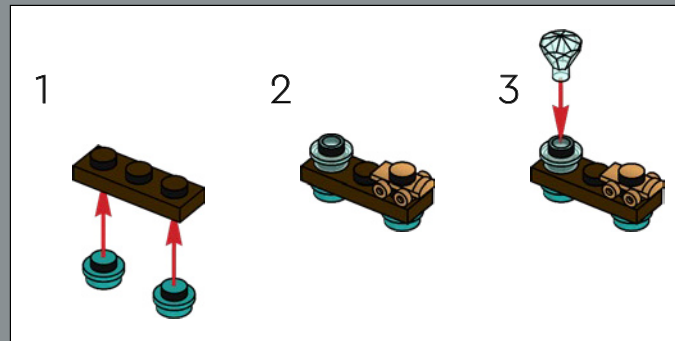

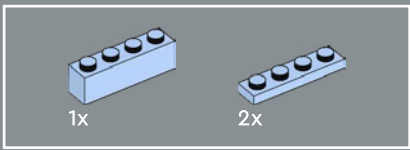

47

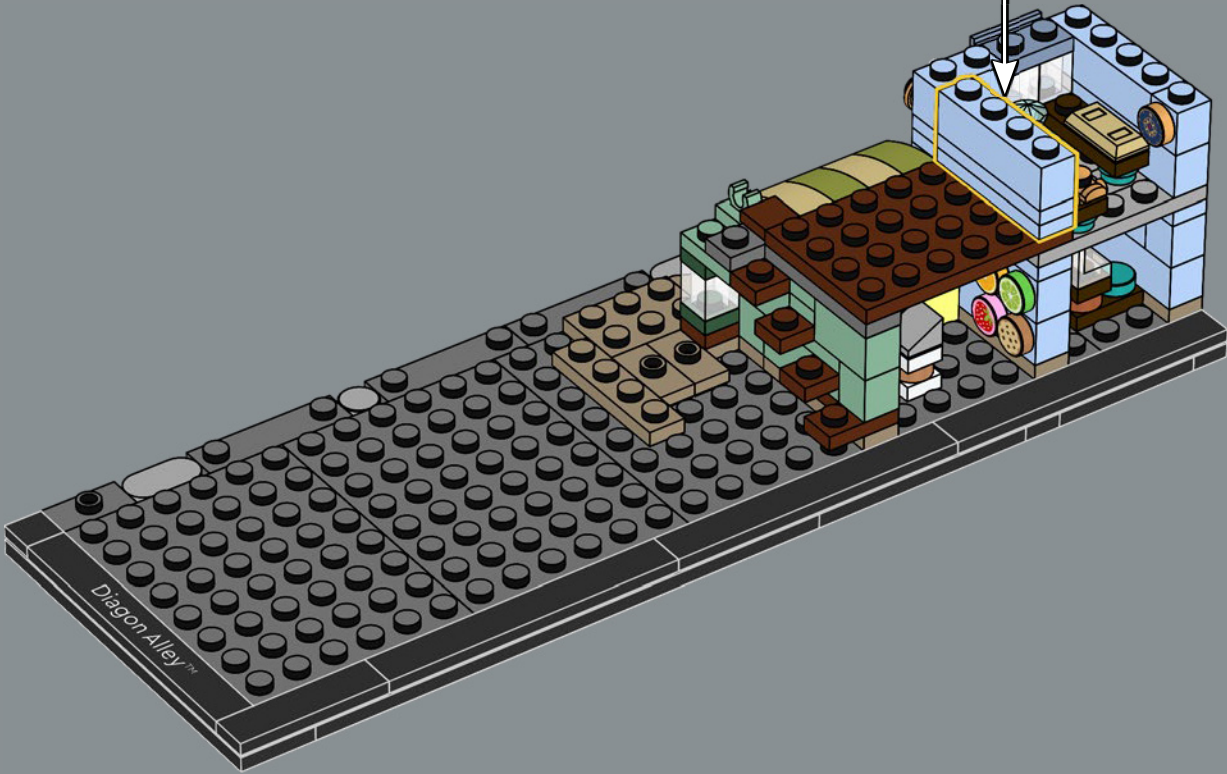
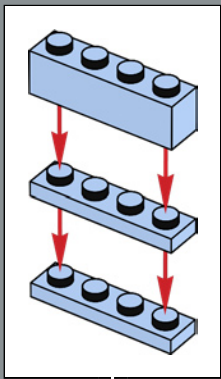

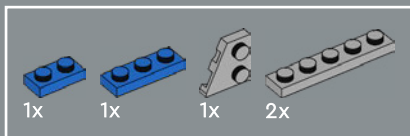

48

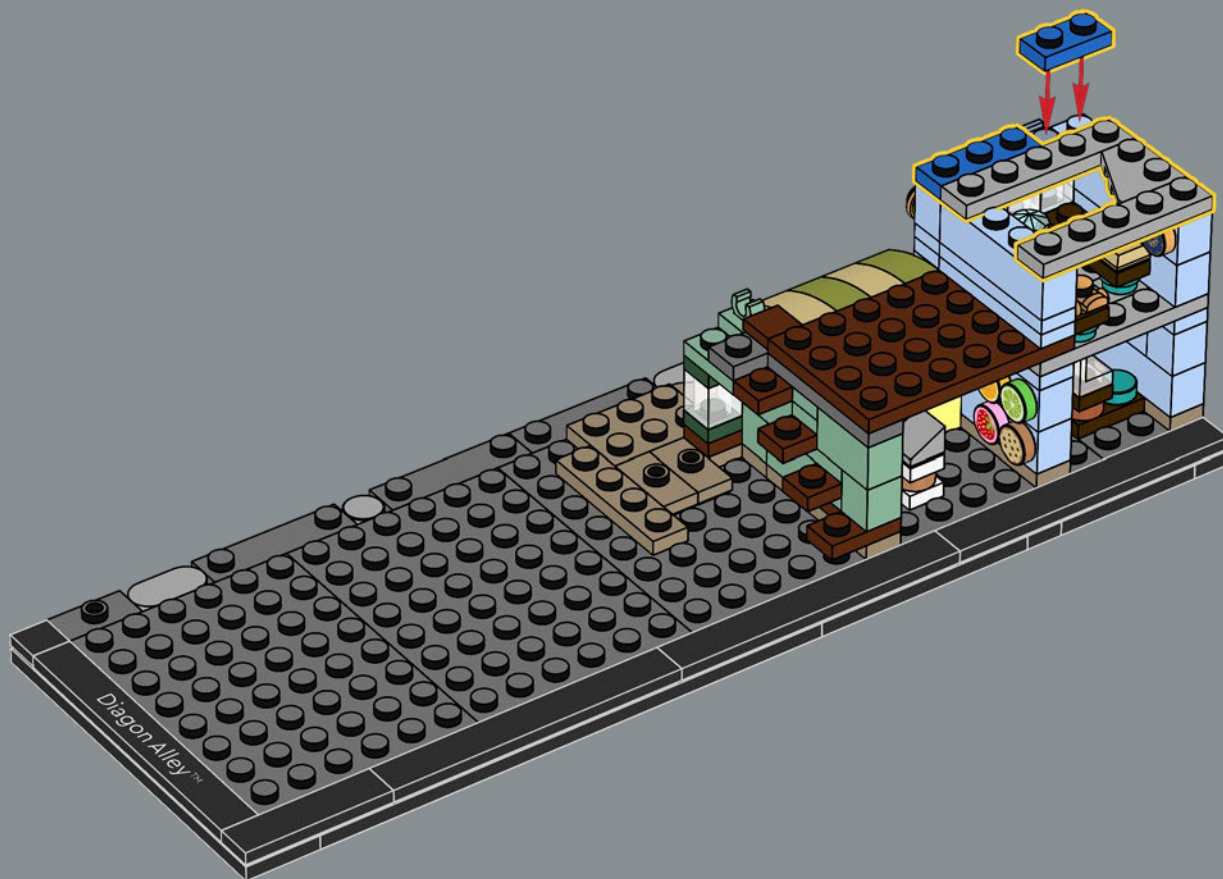

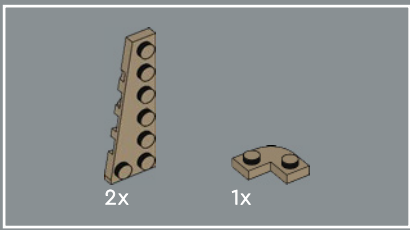

49

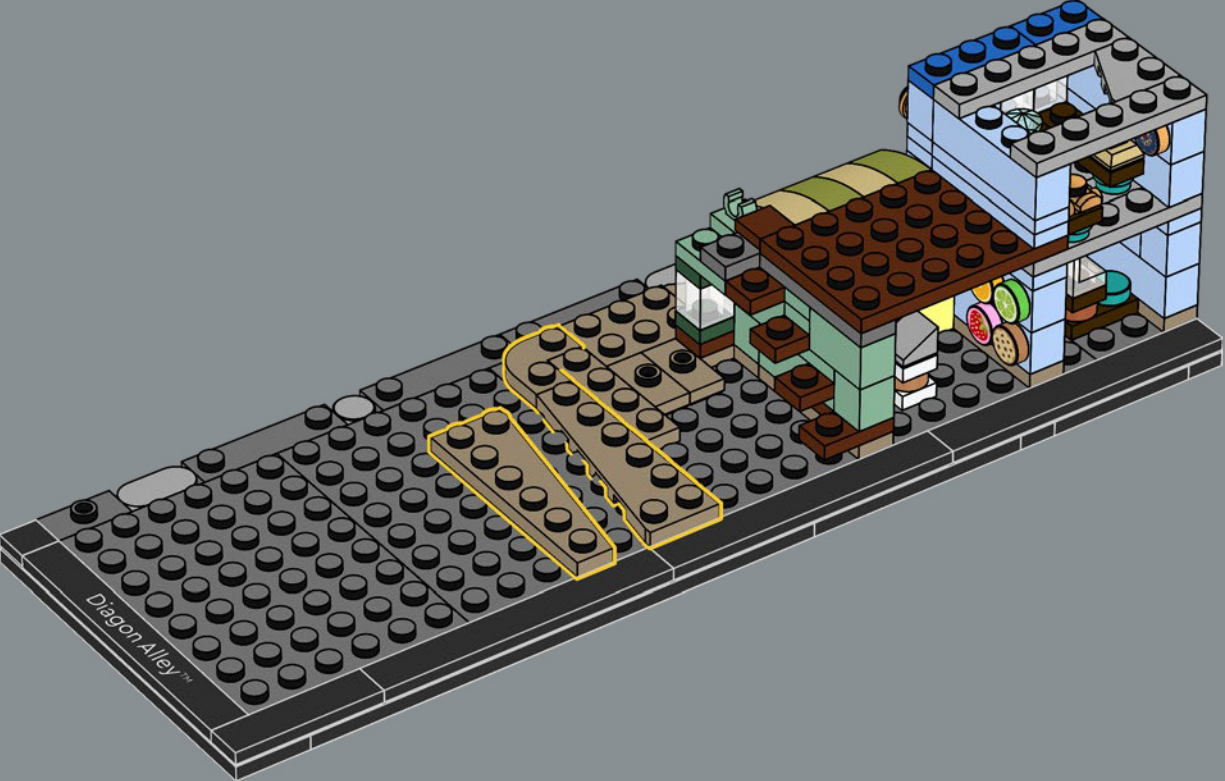

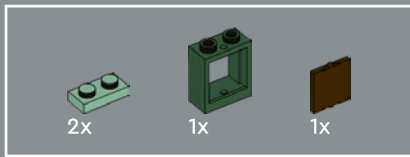

50

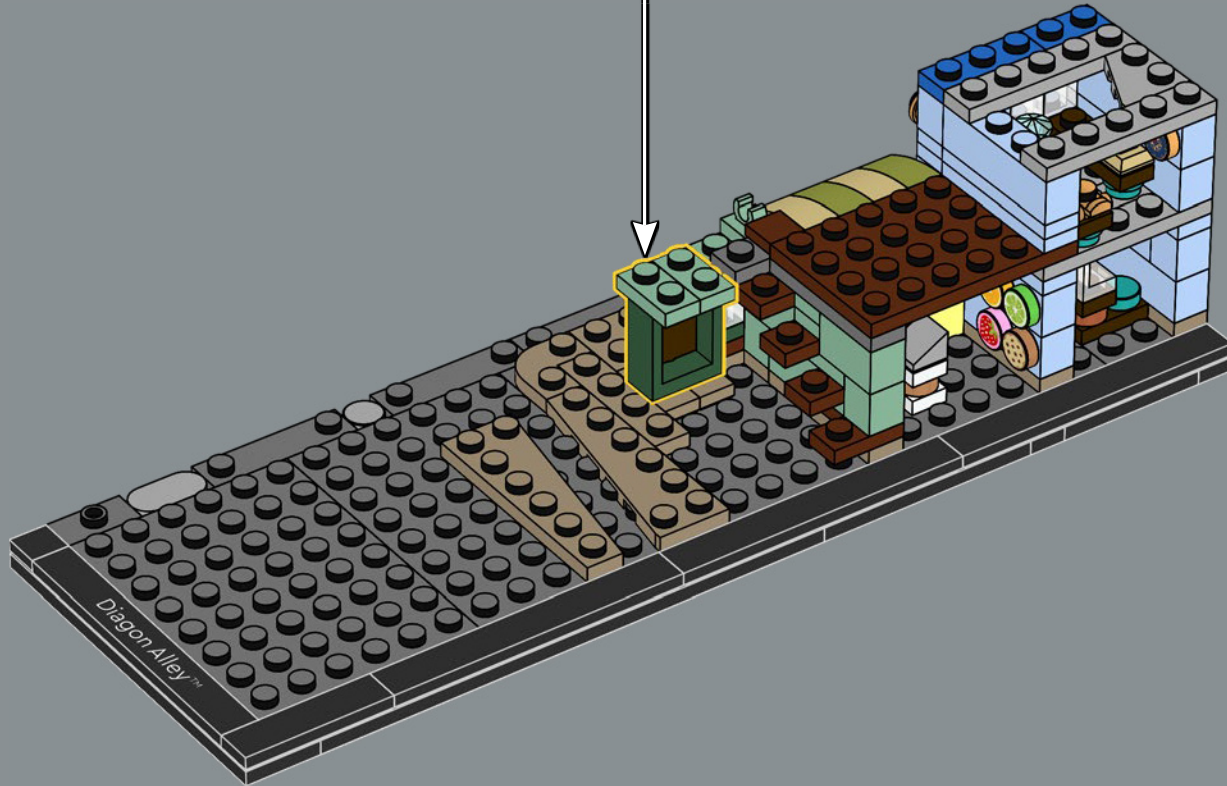
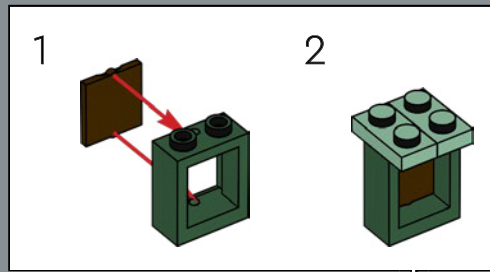

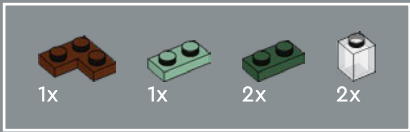

51

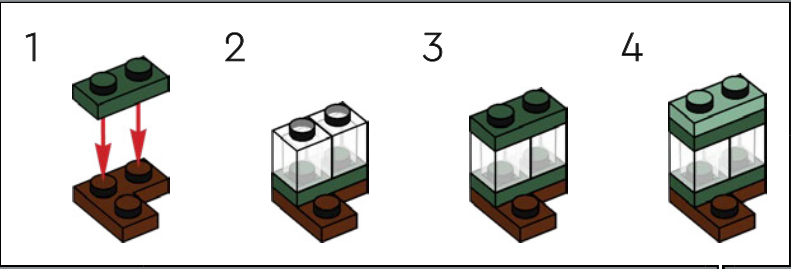



52

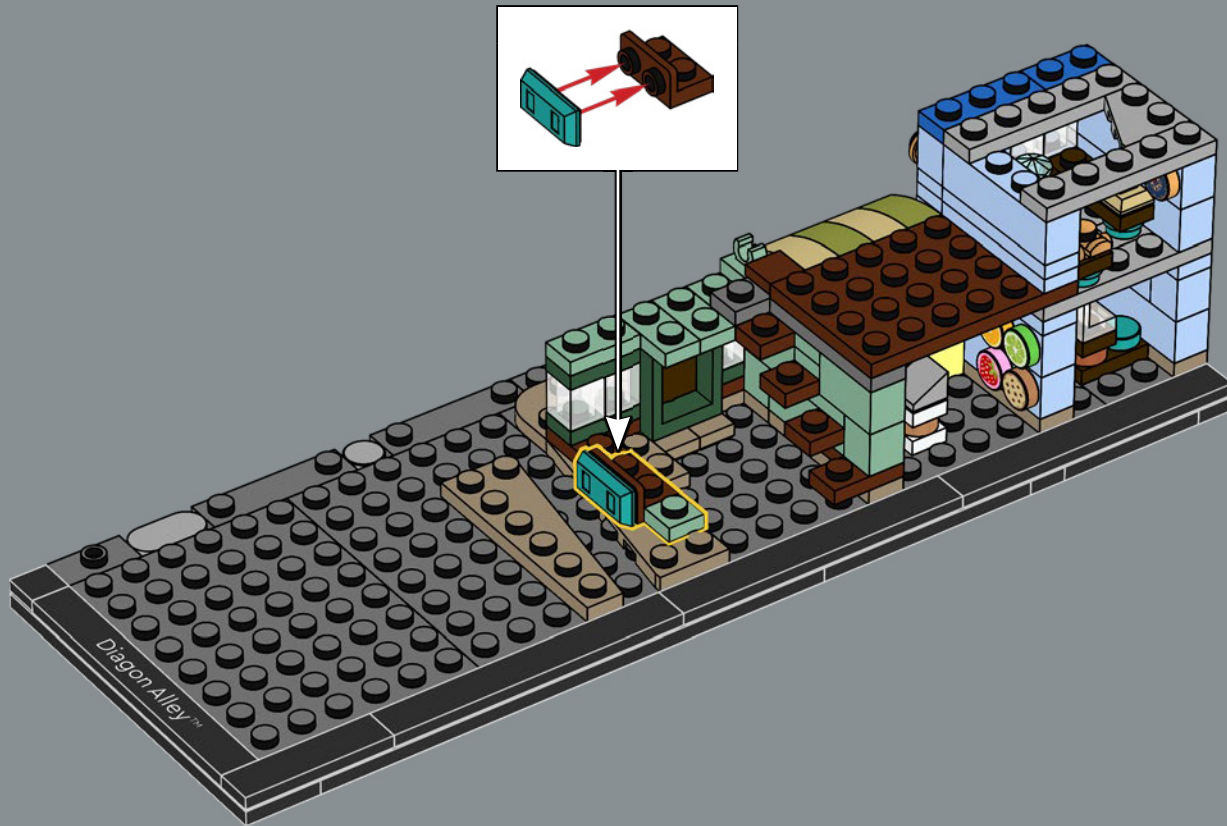

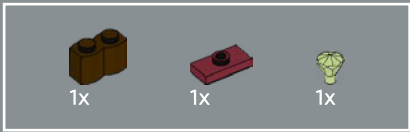

53

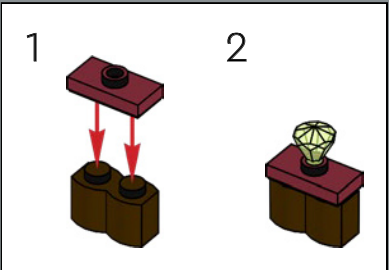



54

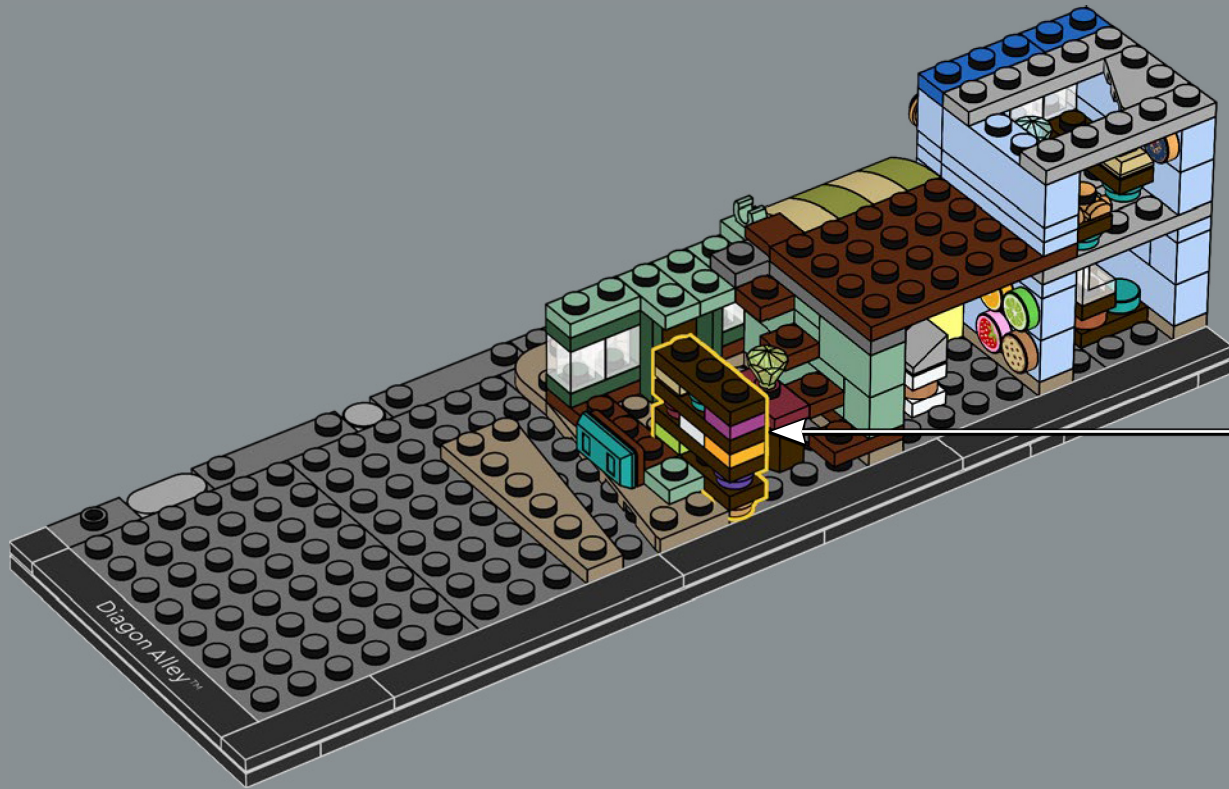
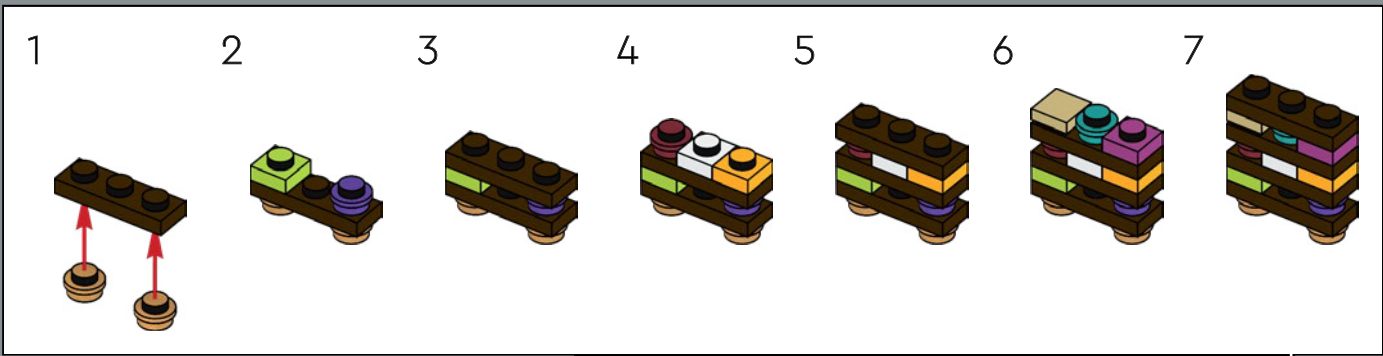

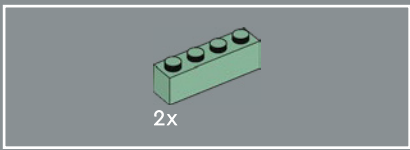

55

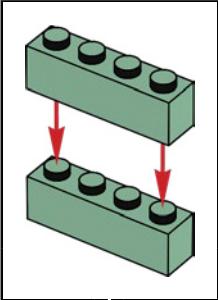

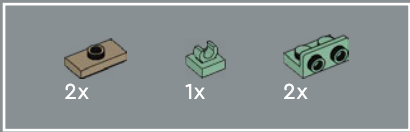

56

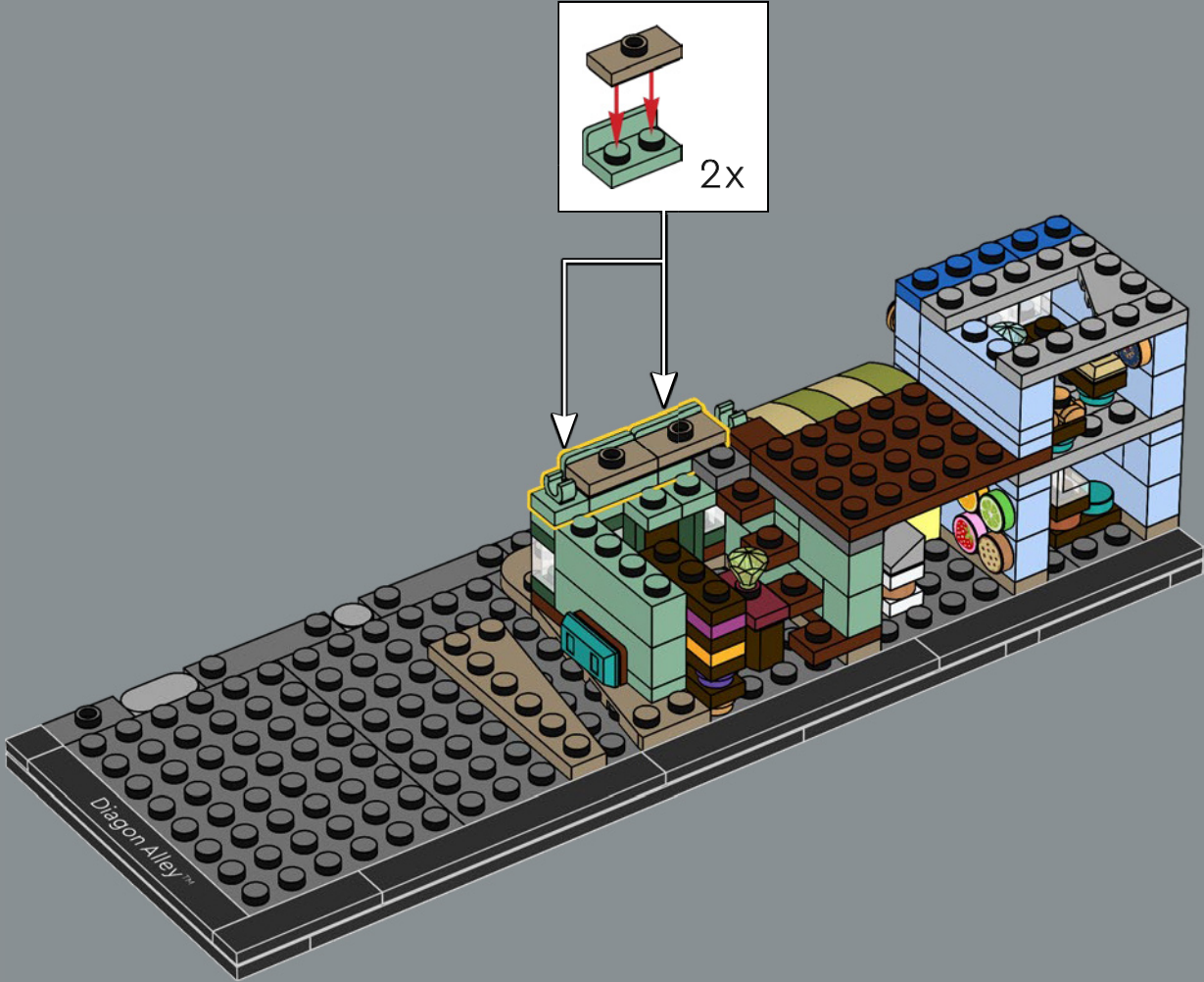

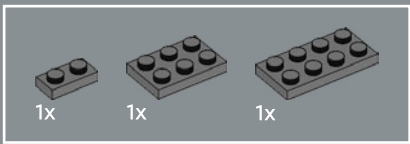

57

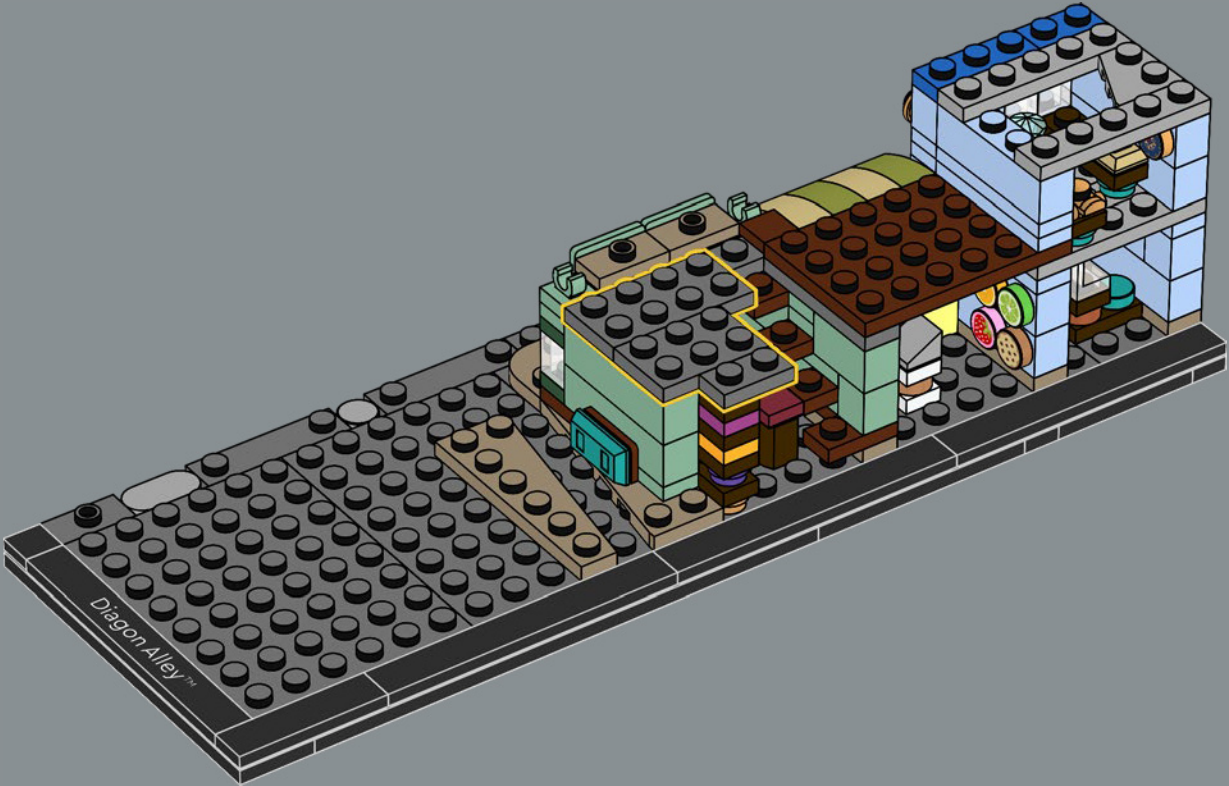

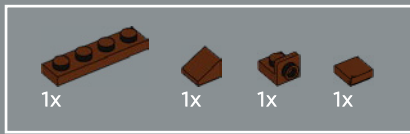

58

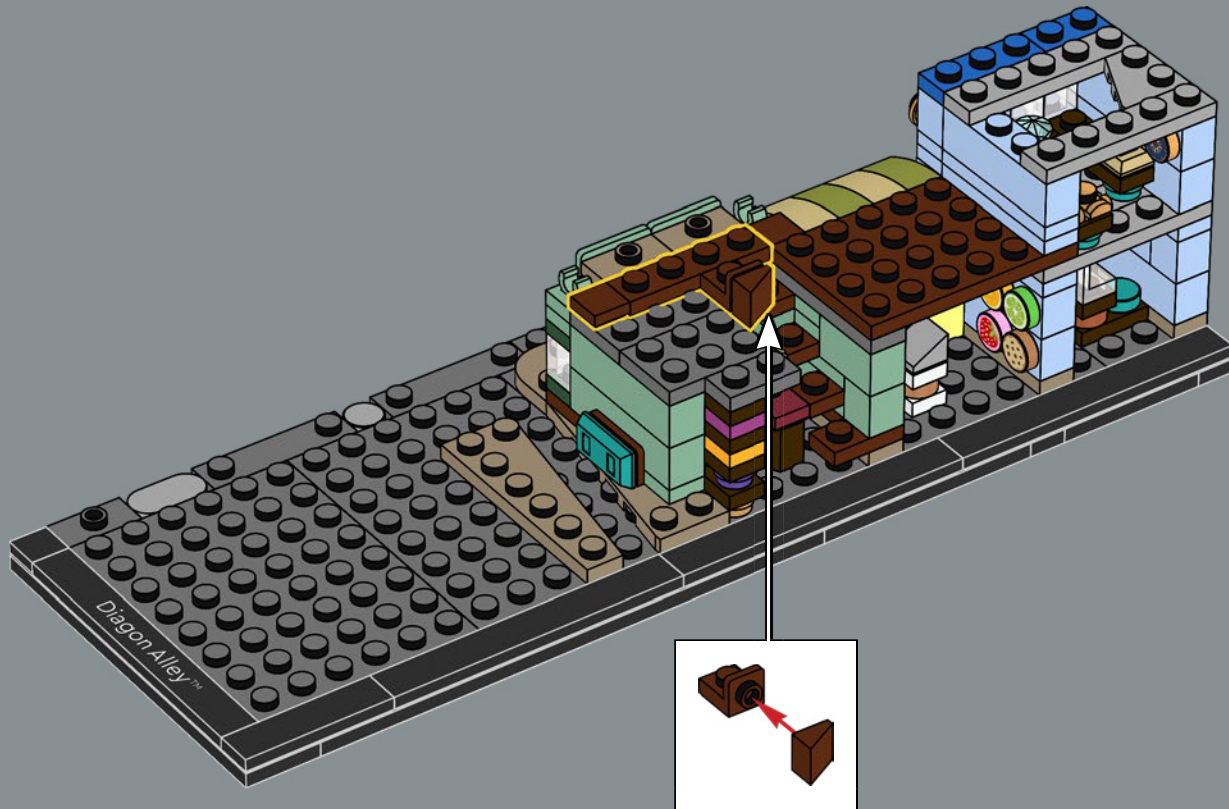

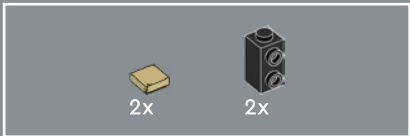

59

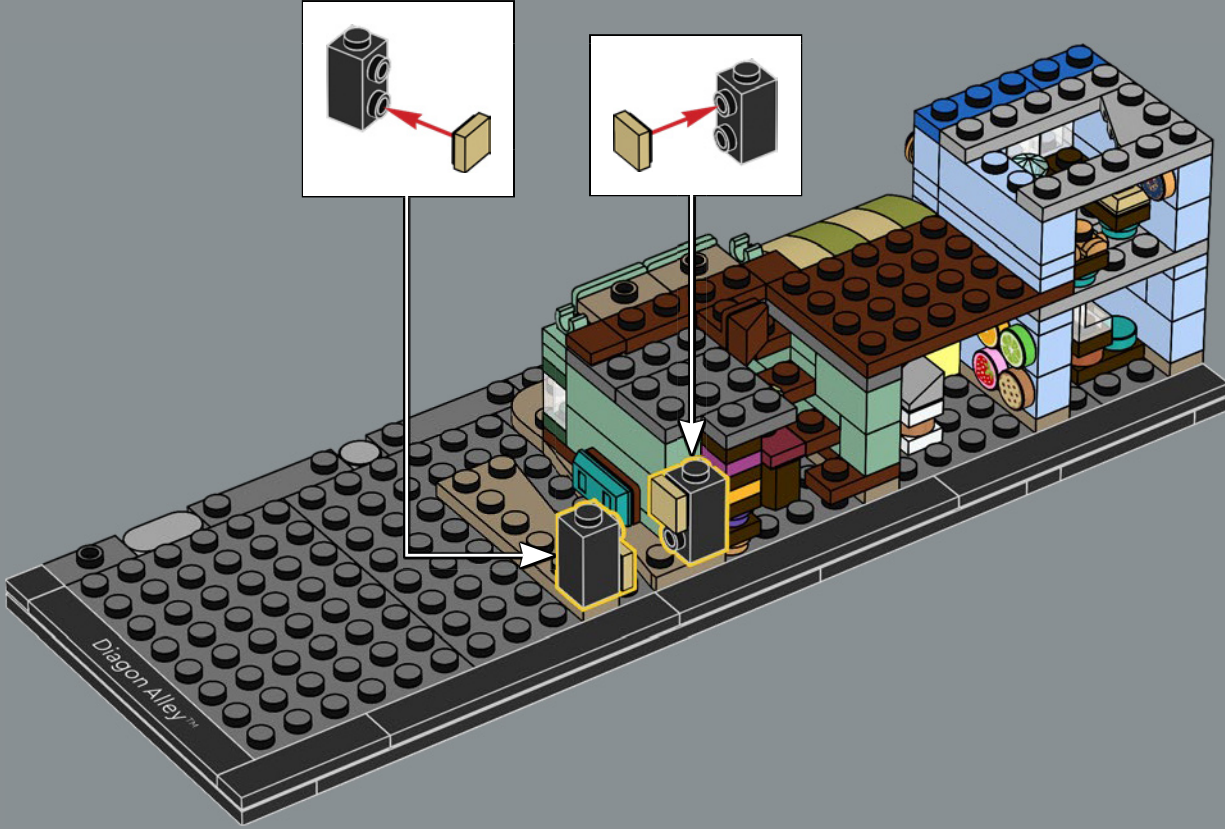

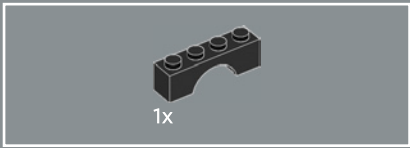

60

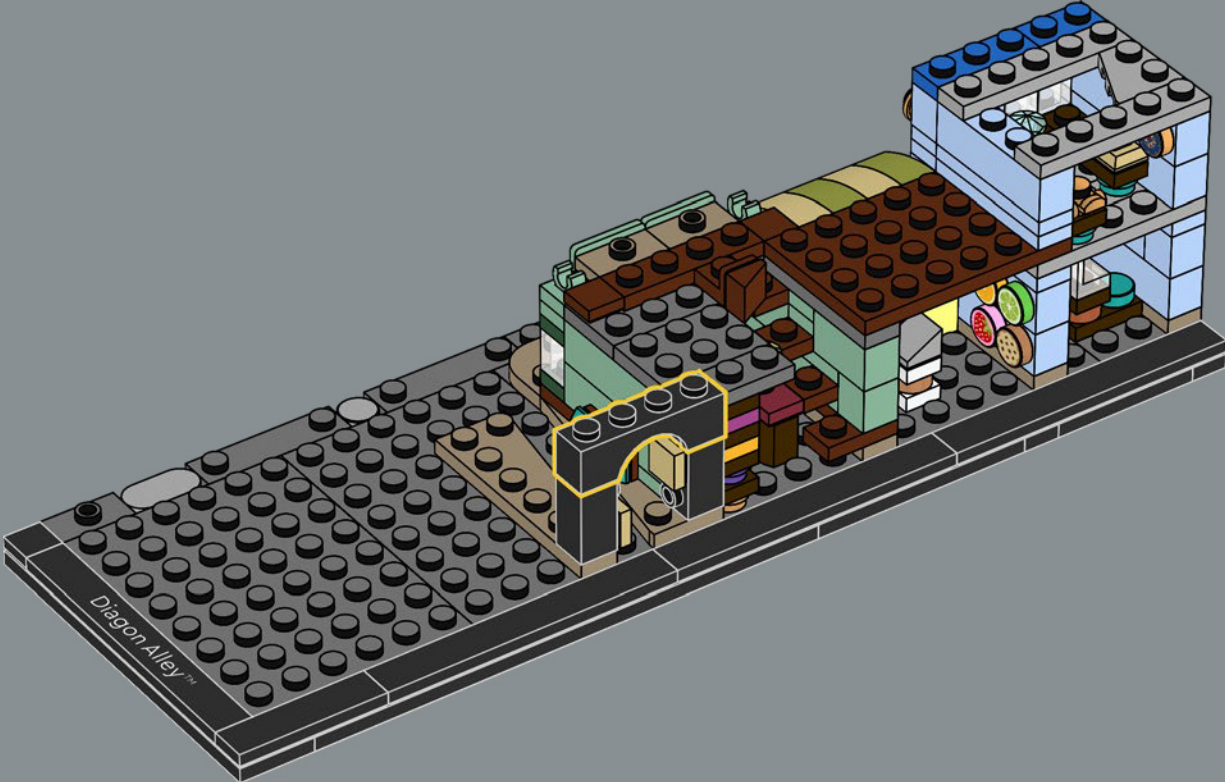

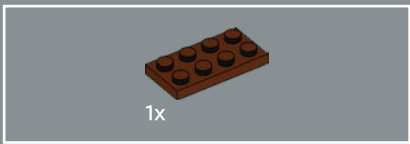

61

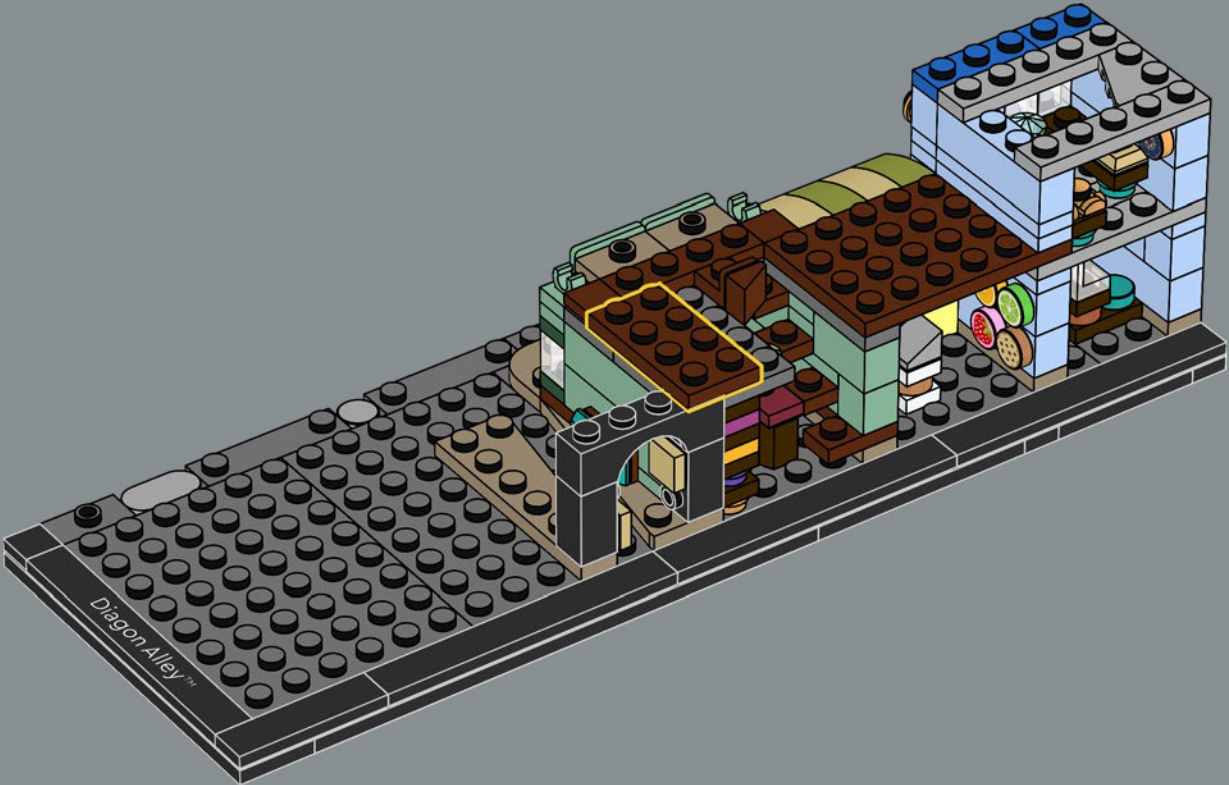

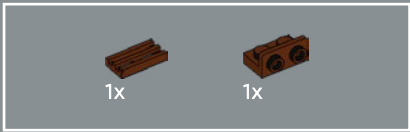

62





63



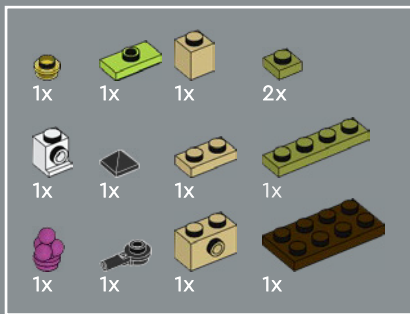

64

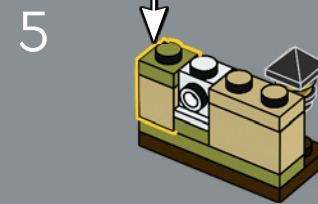
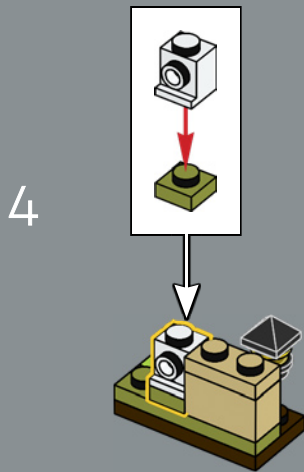
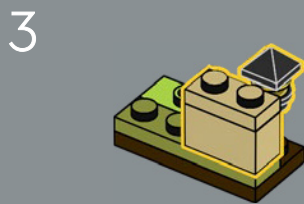
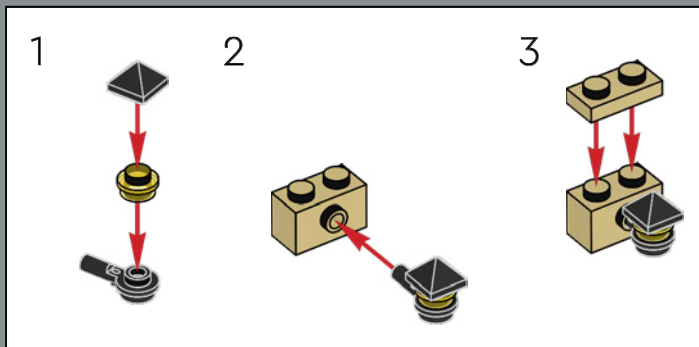
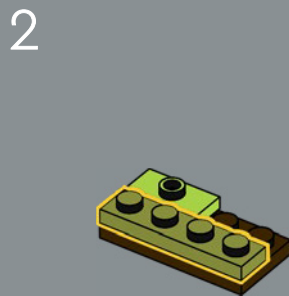
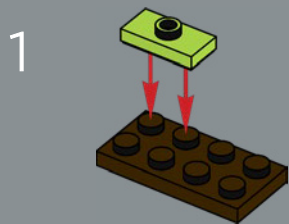

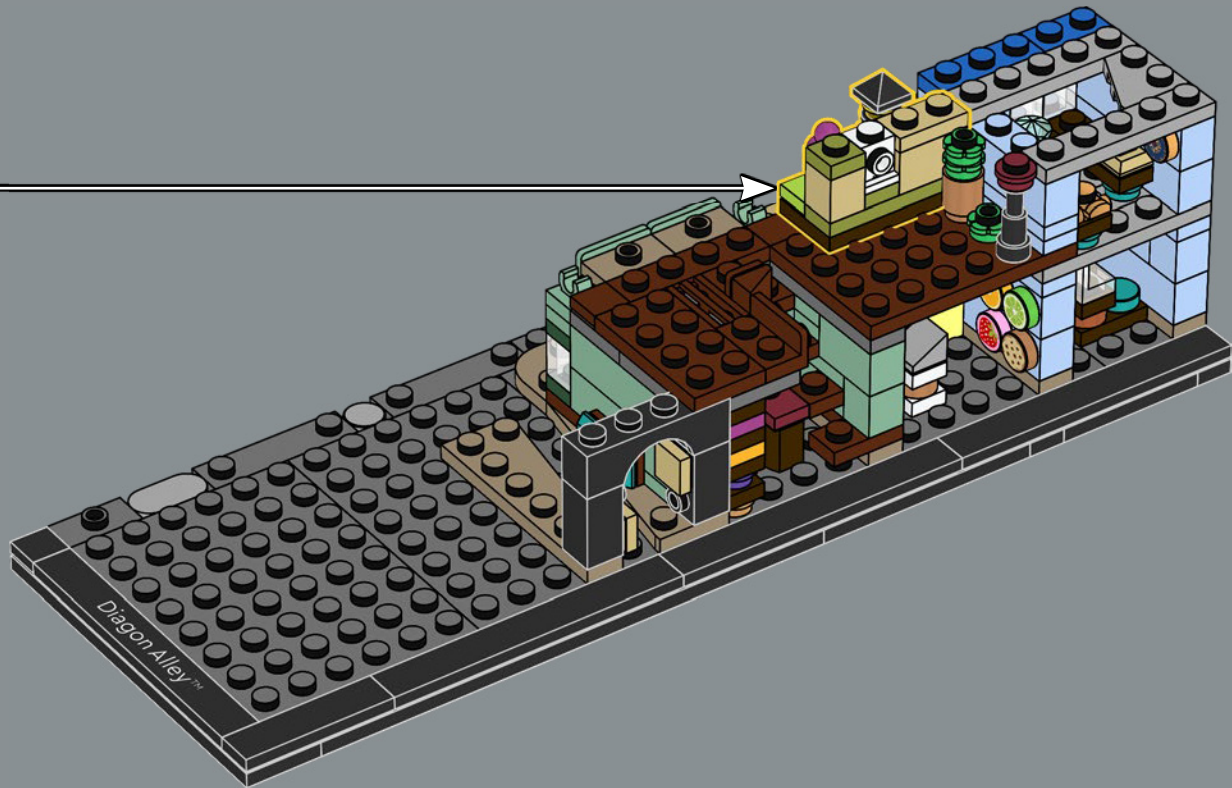



1x

65





66

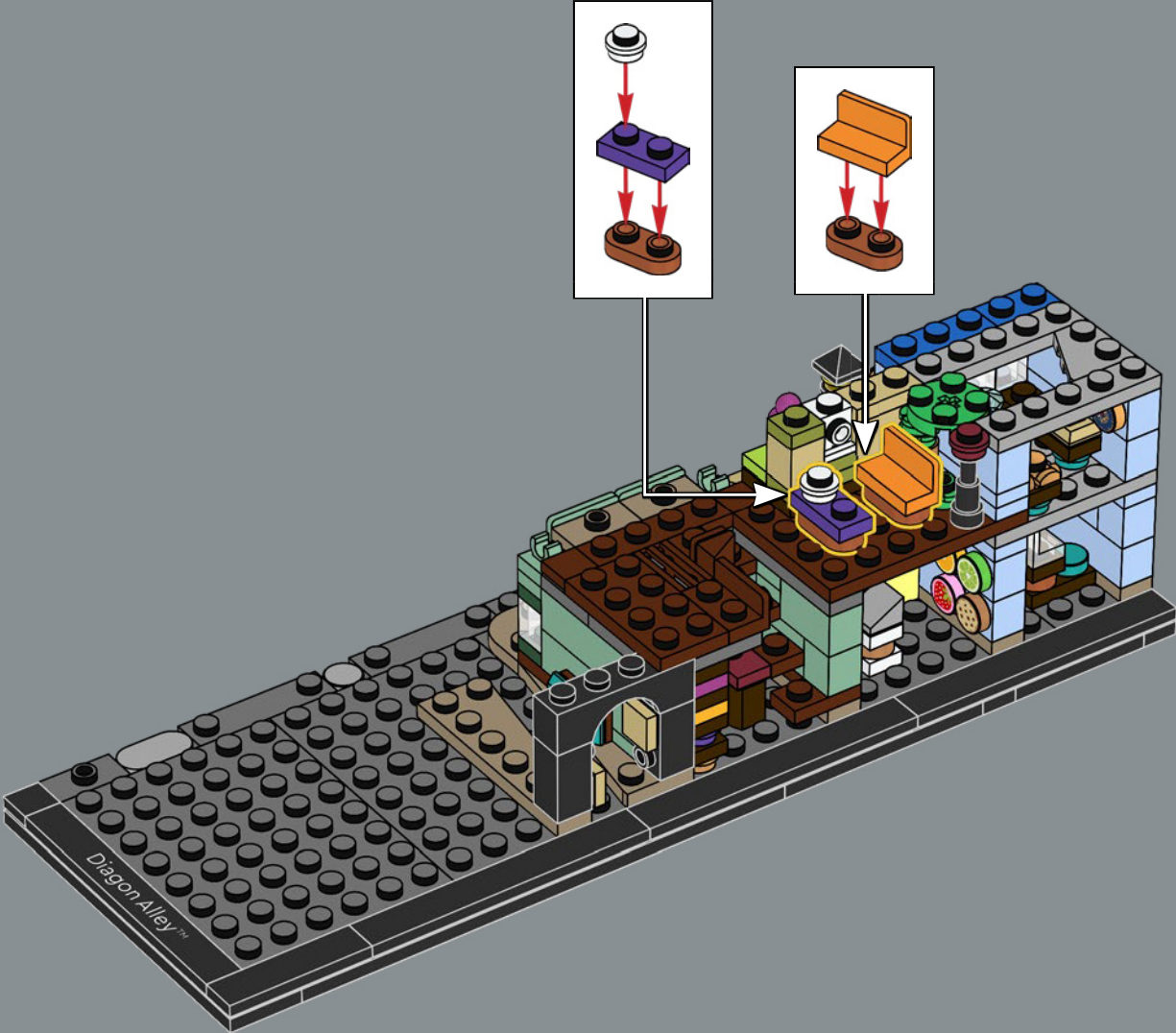

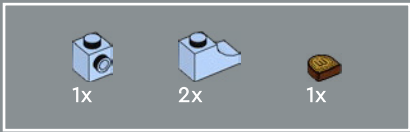

67

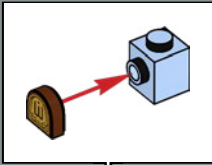

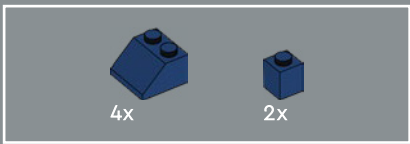

68



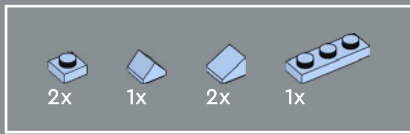

69

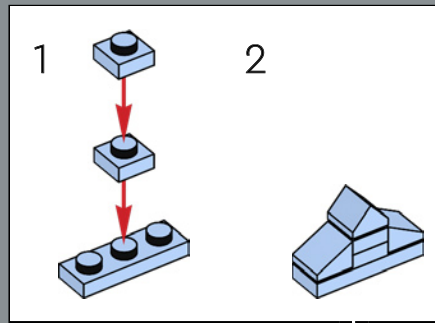

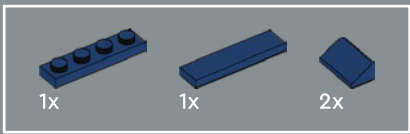

70

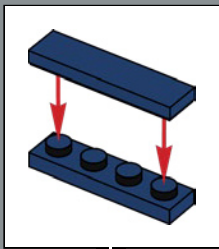

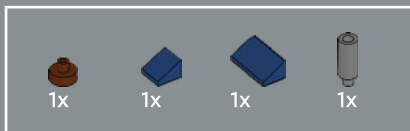

71



**Wiseacre's:
Il Telescopio**
Streghe e maghi interessati agli strumenti scientifici e ai gadget magici possono trovare qui i telescopi più provati, testati e affidabili, le mappe magiche, le clessidre incantate e molto altro ancora.

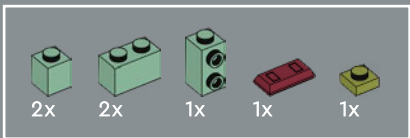

72

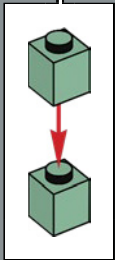
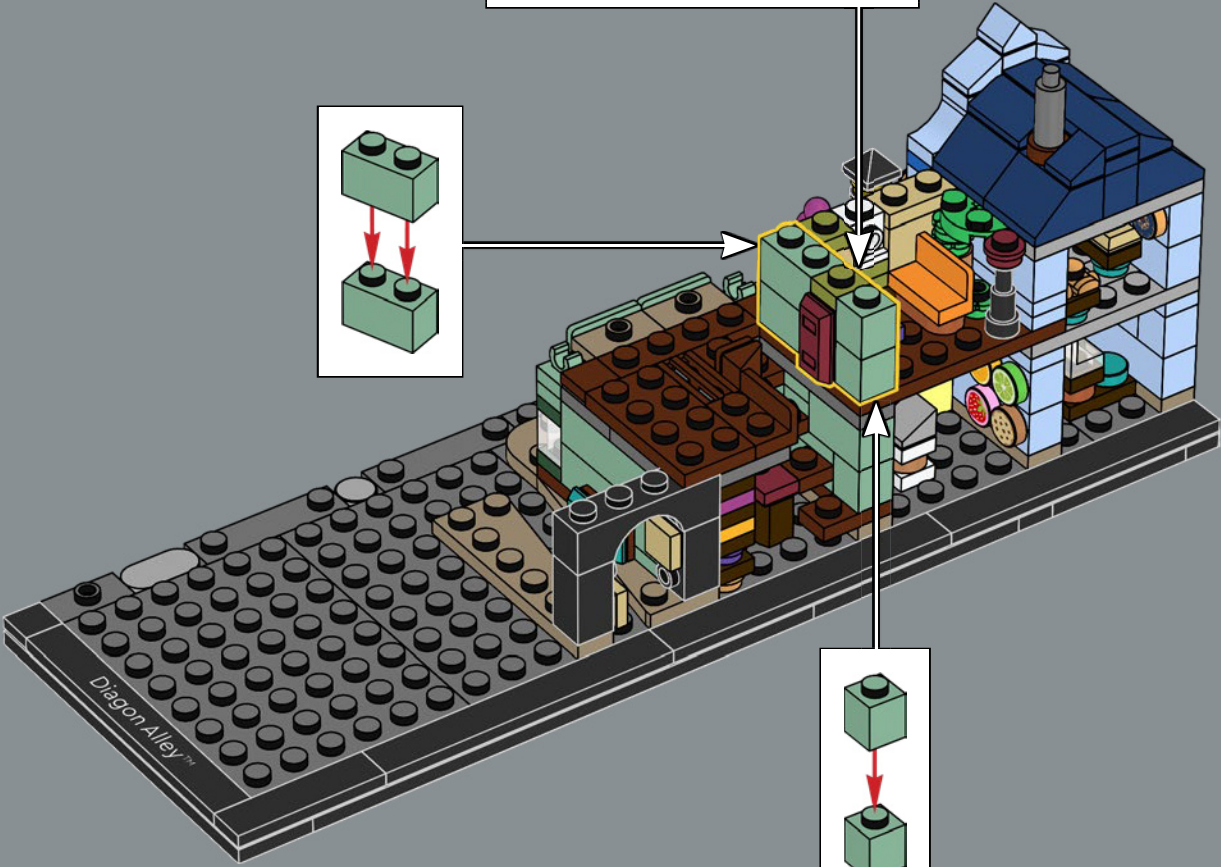
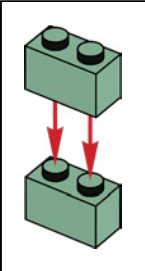
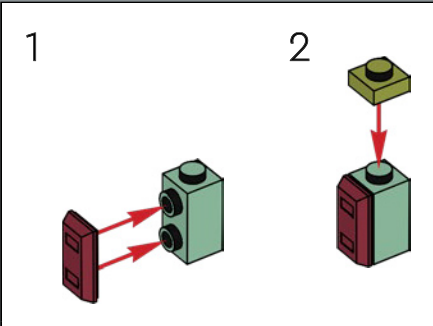

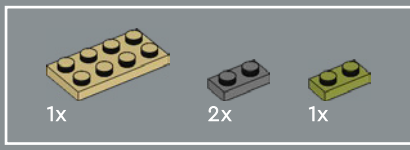

73



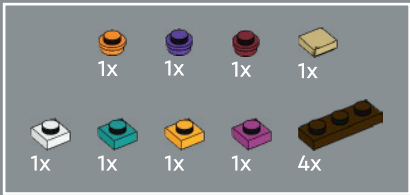

74

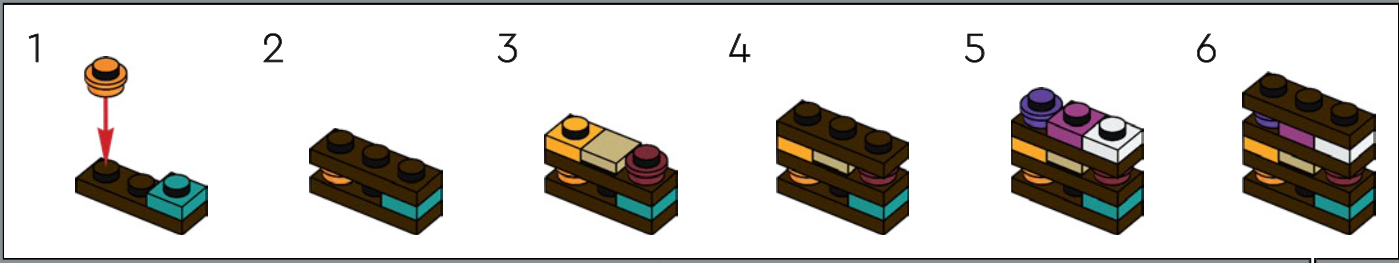

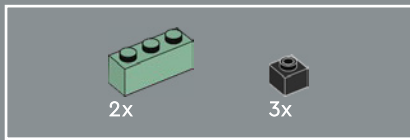

75

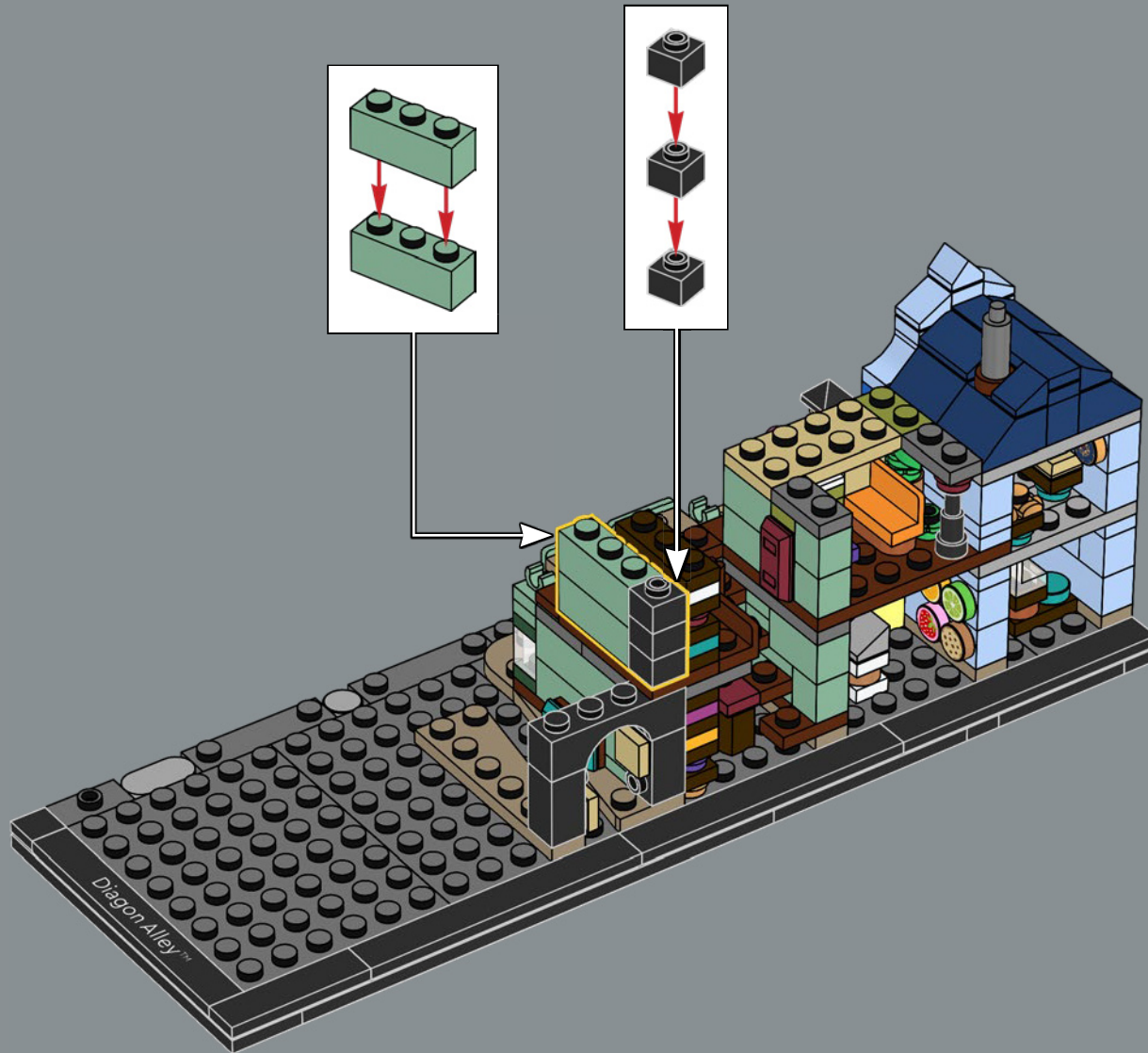

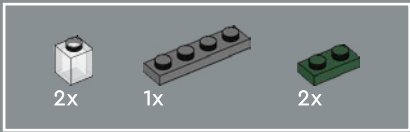

76

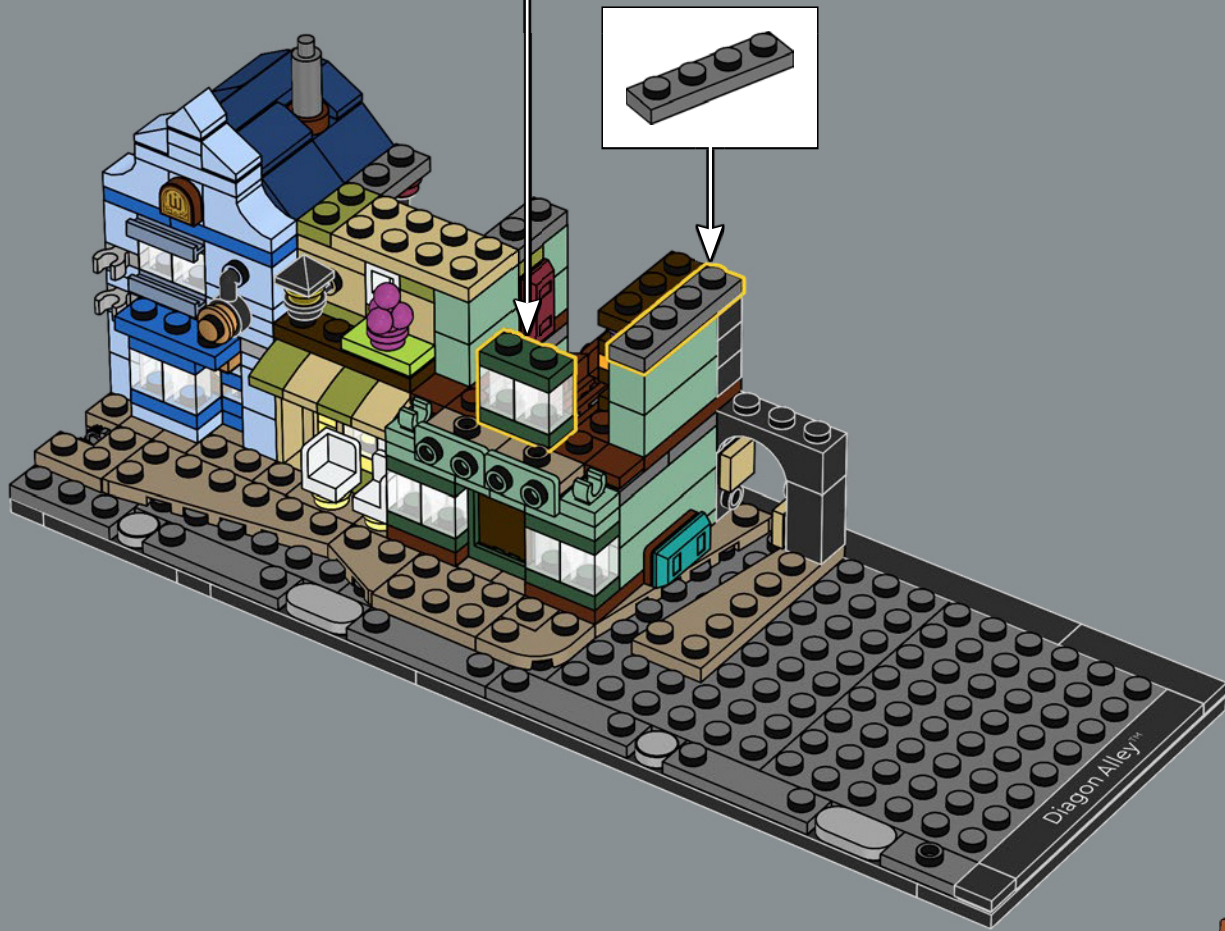
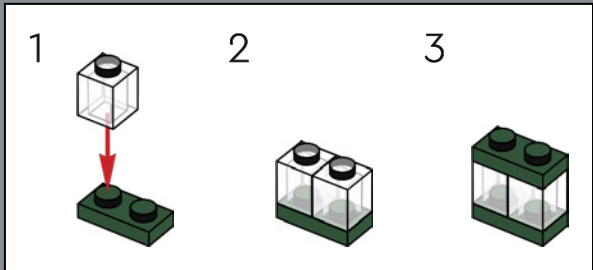

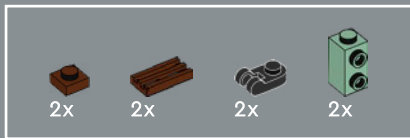

77

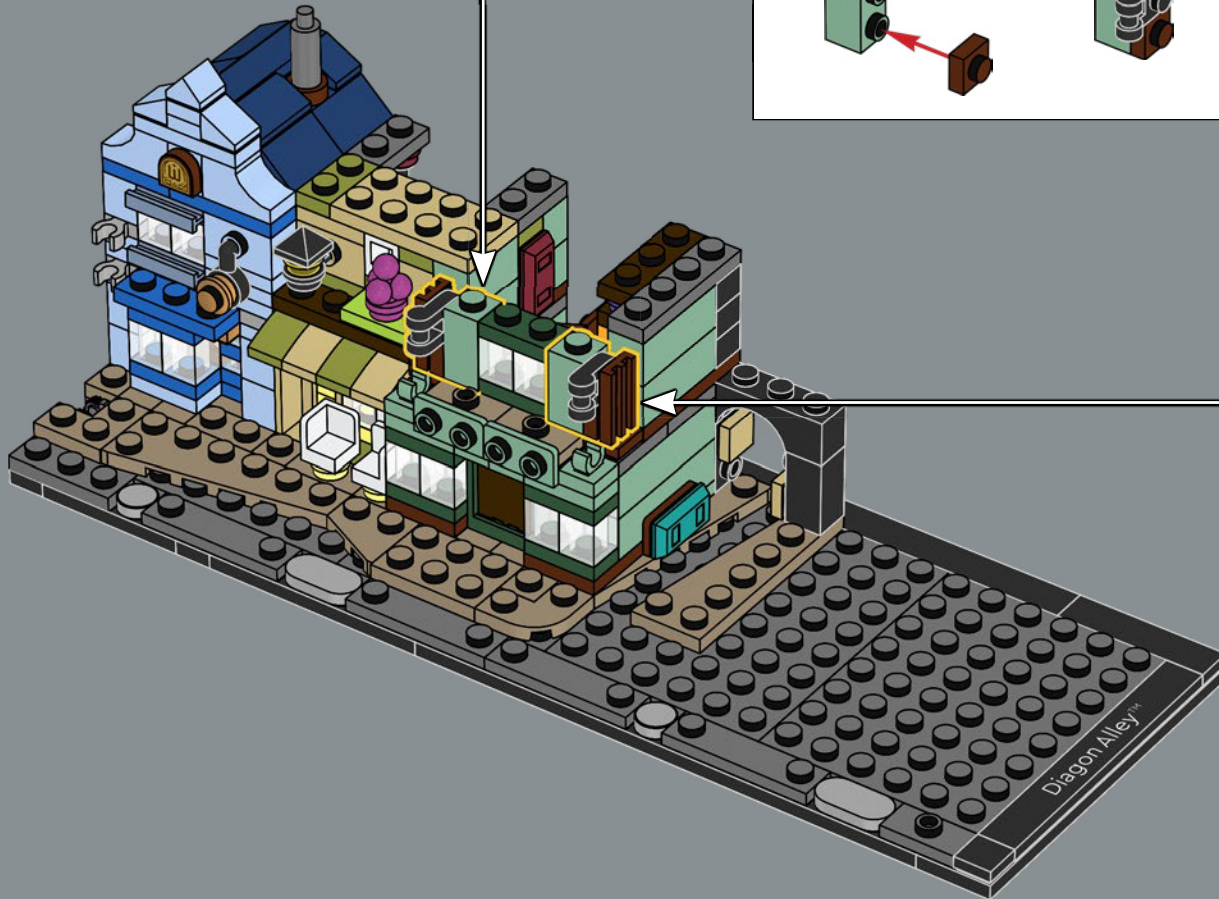
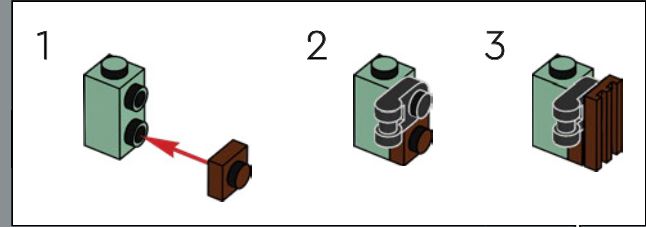
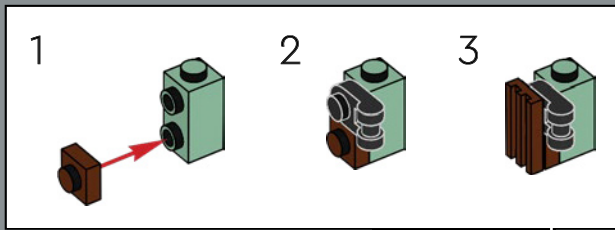



2x

78



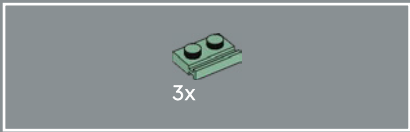

79

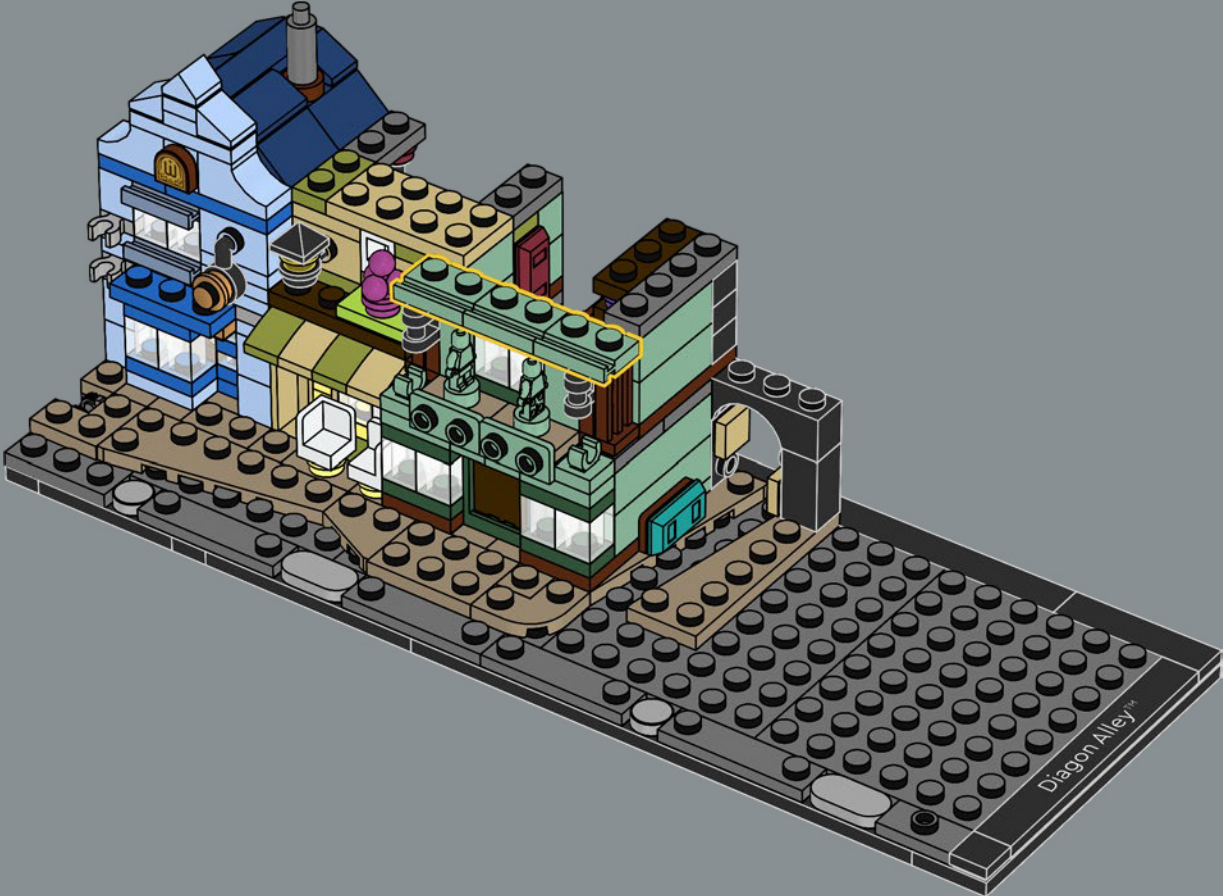



80



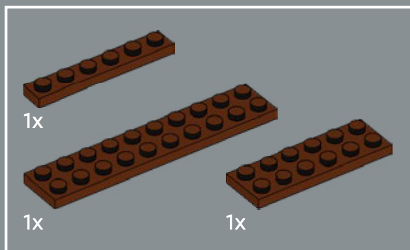

81

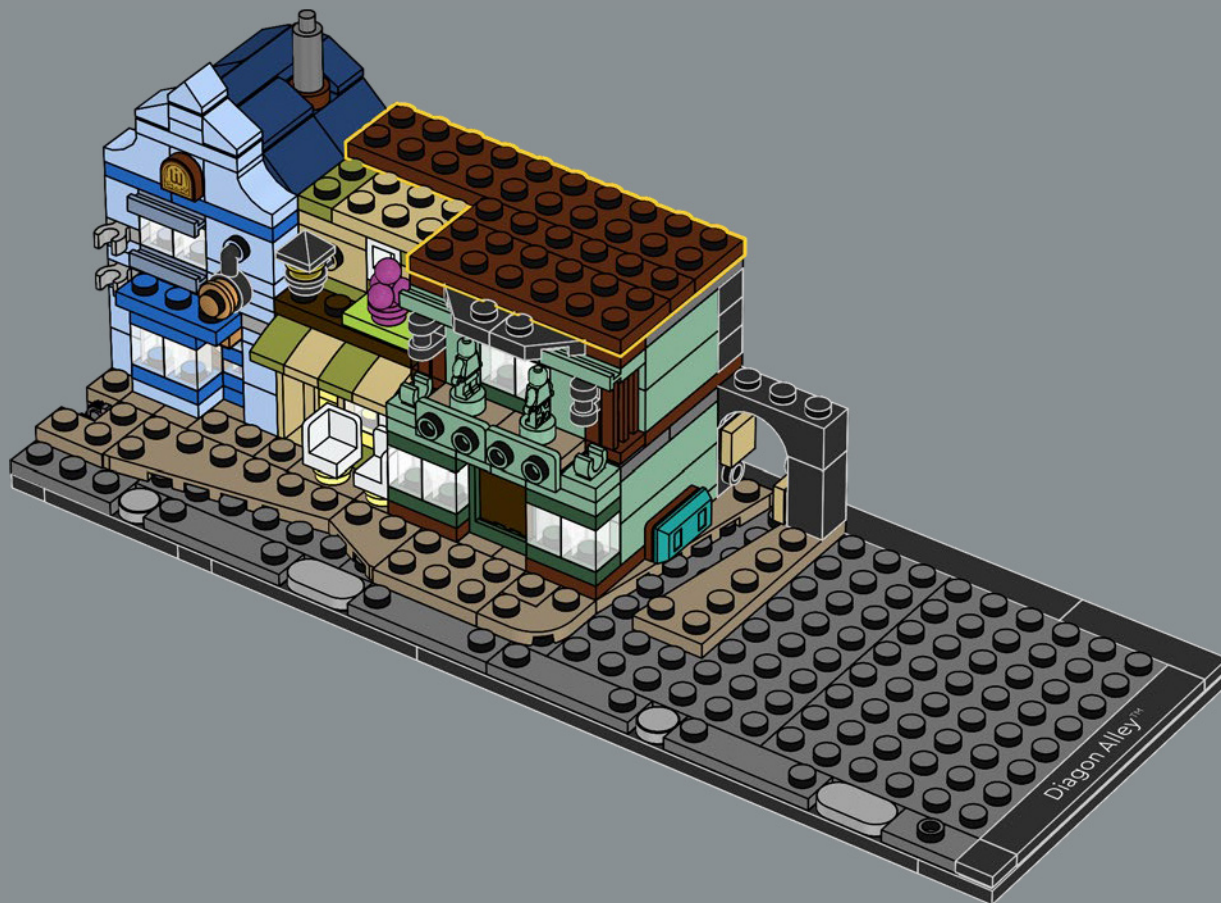



82

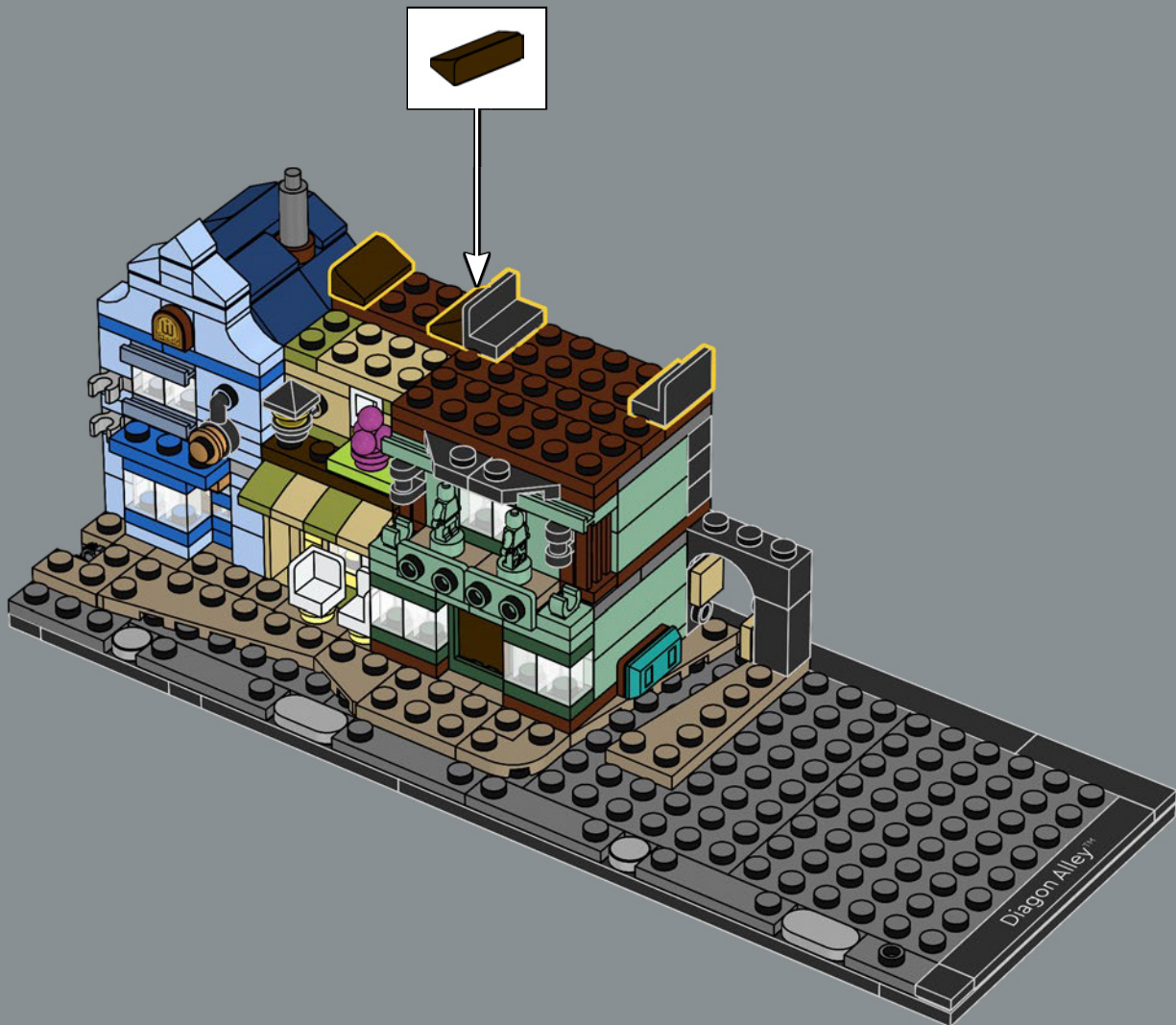



83

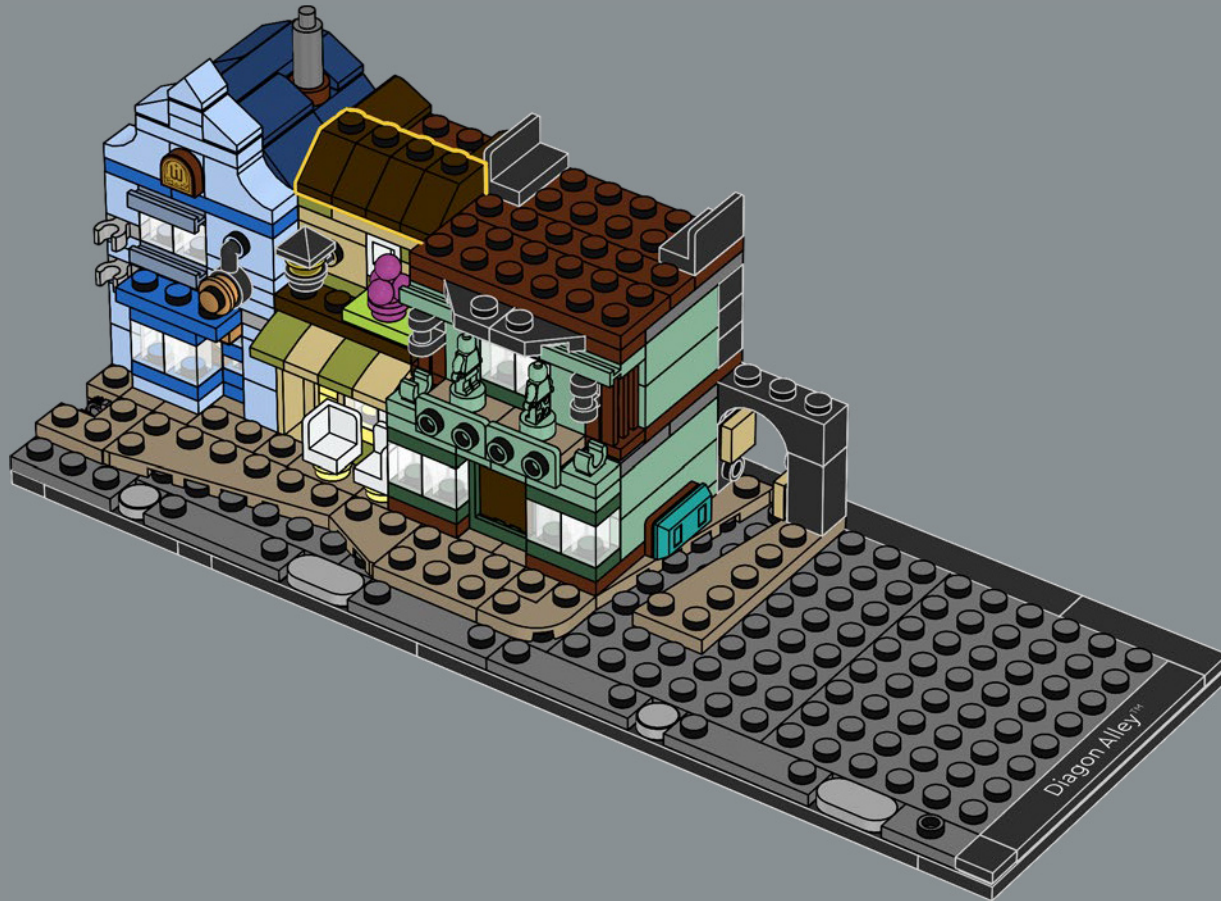

Gelateria Fortebraccio

Qui troverai il miglior gelato al cioccolato e al lampone di Diagon Alley. Alcuni studenti potrebbero anche avere la fortuna di assaggiare una pallina gratuita.



84

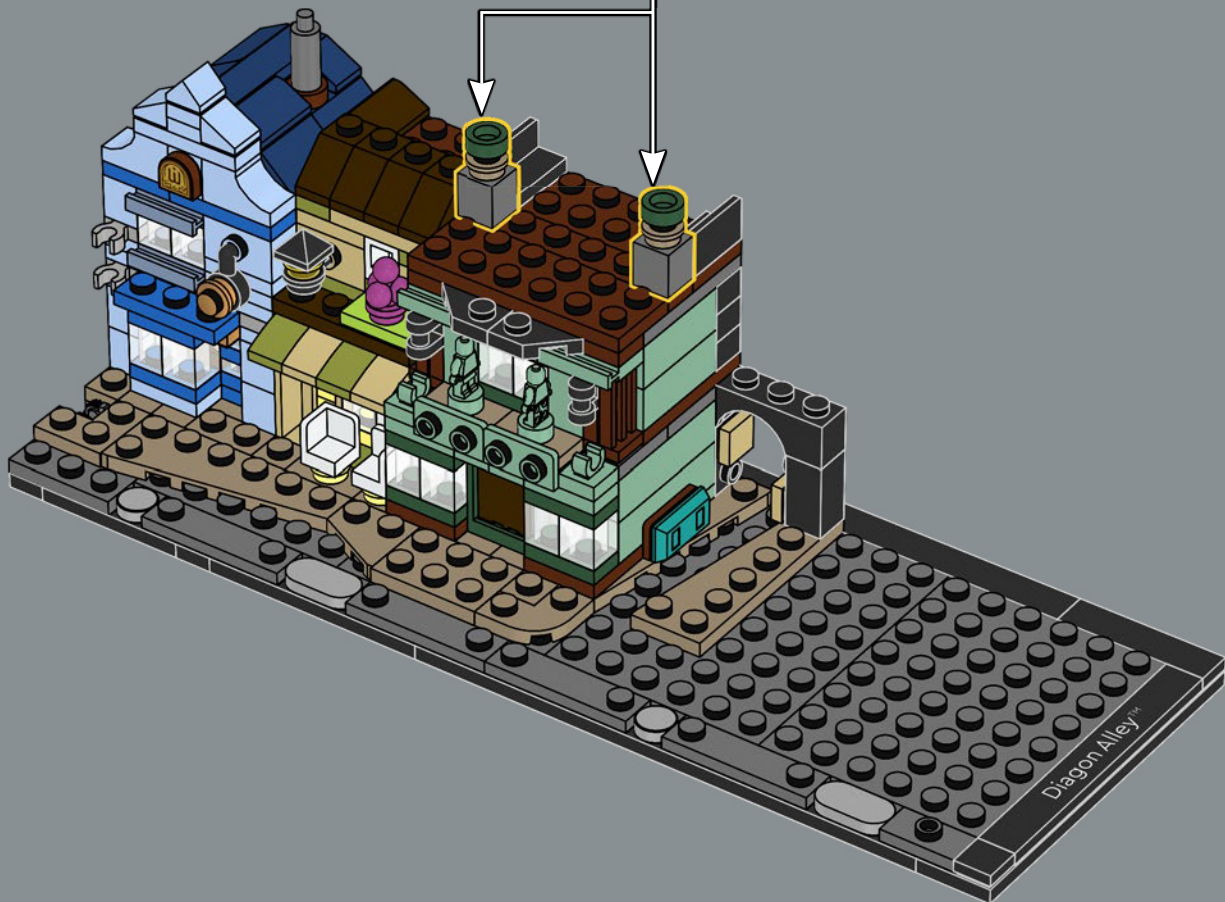
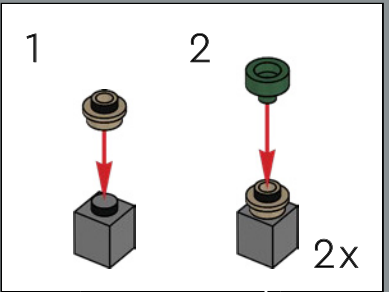

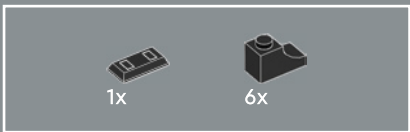

85

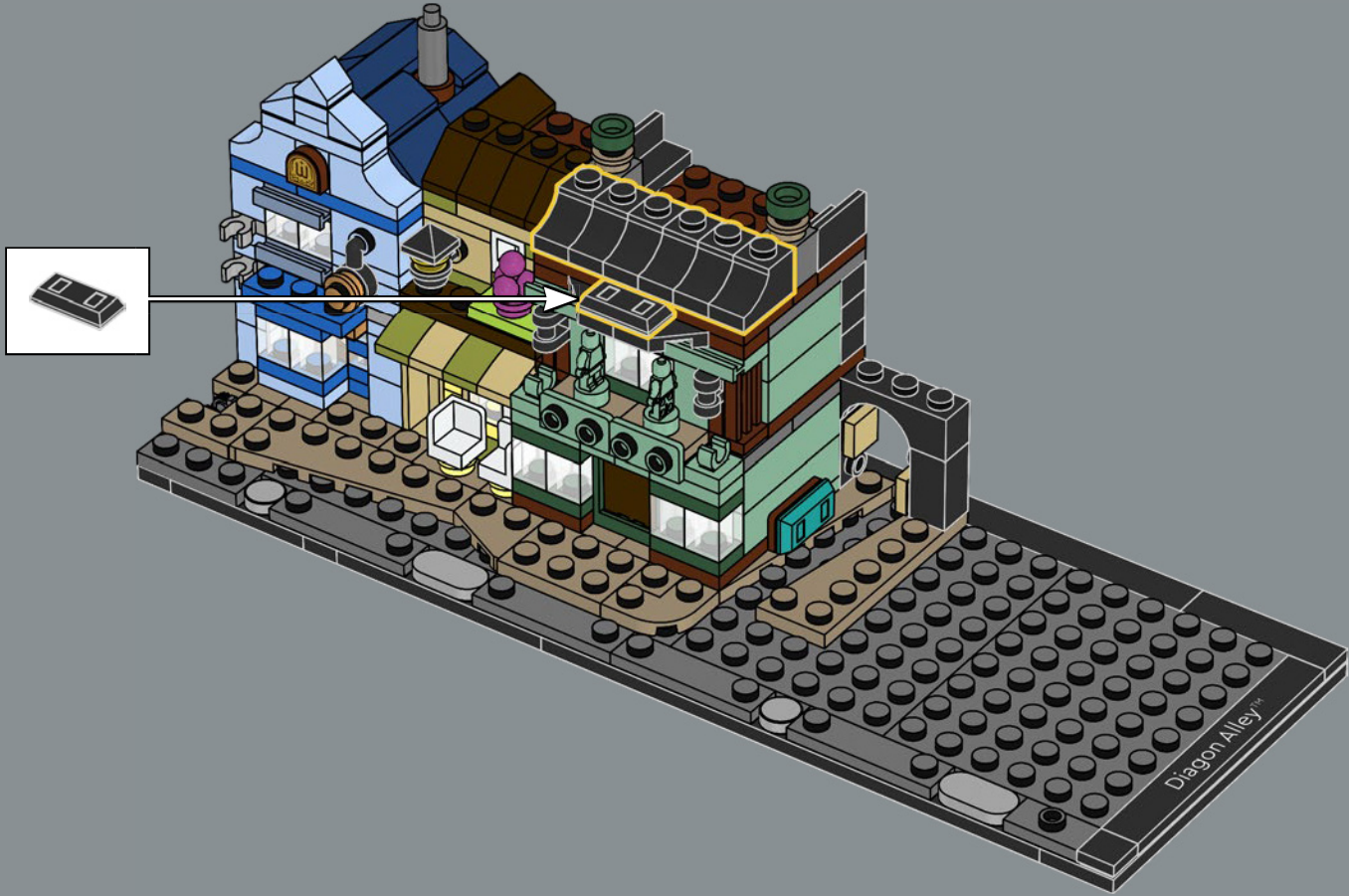

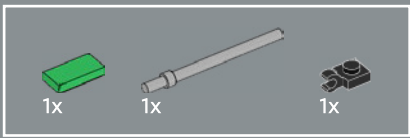

86

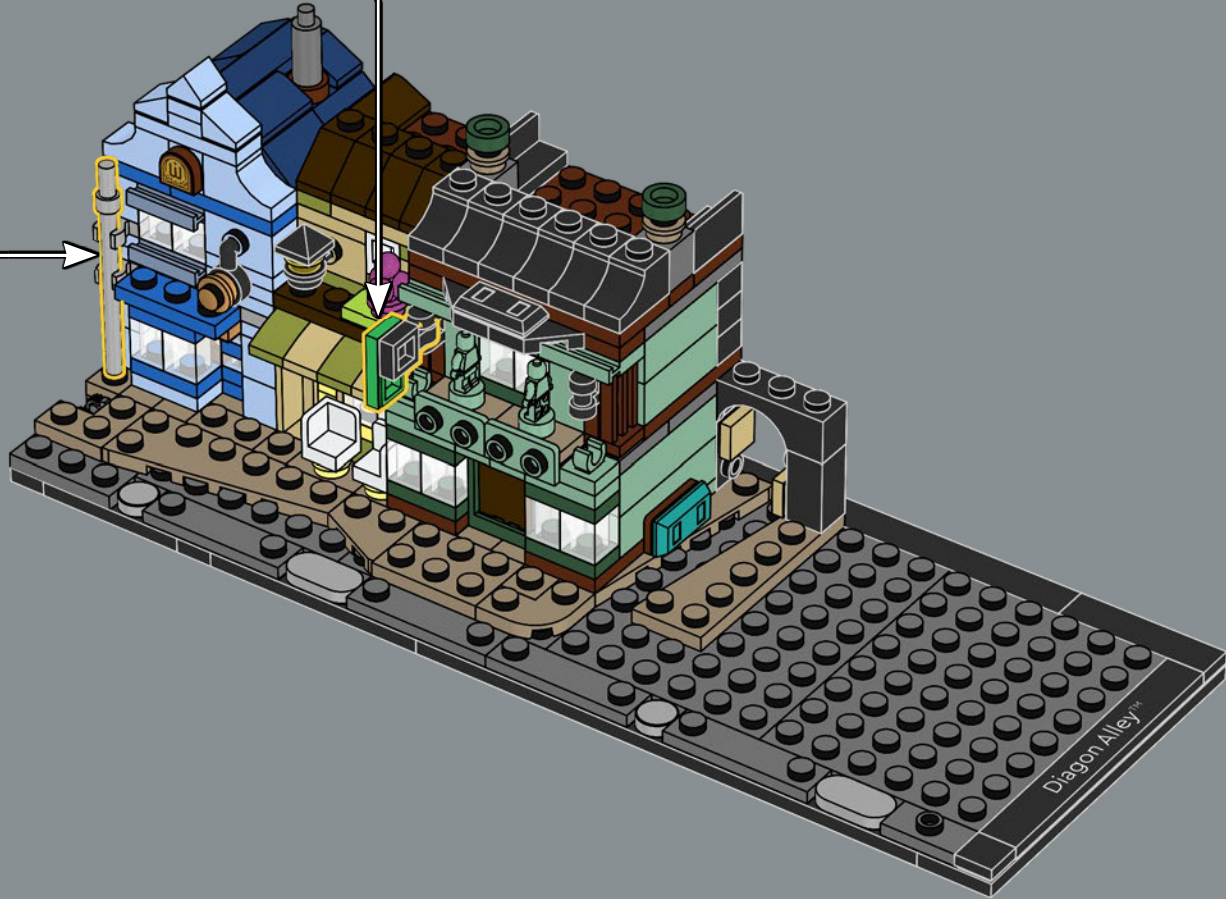
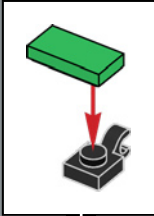

Il Ghirigoro di Flourish e Blotts

Dai libri scolastici ai racconti improbabili fino alla restrizione delle arti magiche, gli scaffali del Il Ghirigoro racchiudono tanti meravigliosi volumi. Ma attenzione: alcuni libri hanno una vita propria, come lo sfuggente Libro Invisibile dell'Invisibilità e il terrificante Libro dei Mostri!

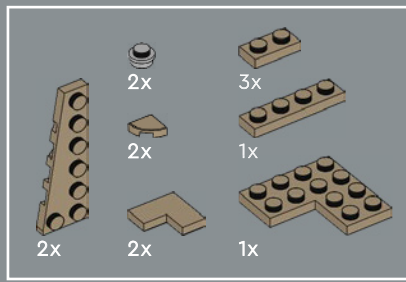

87

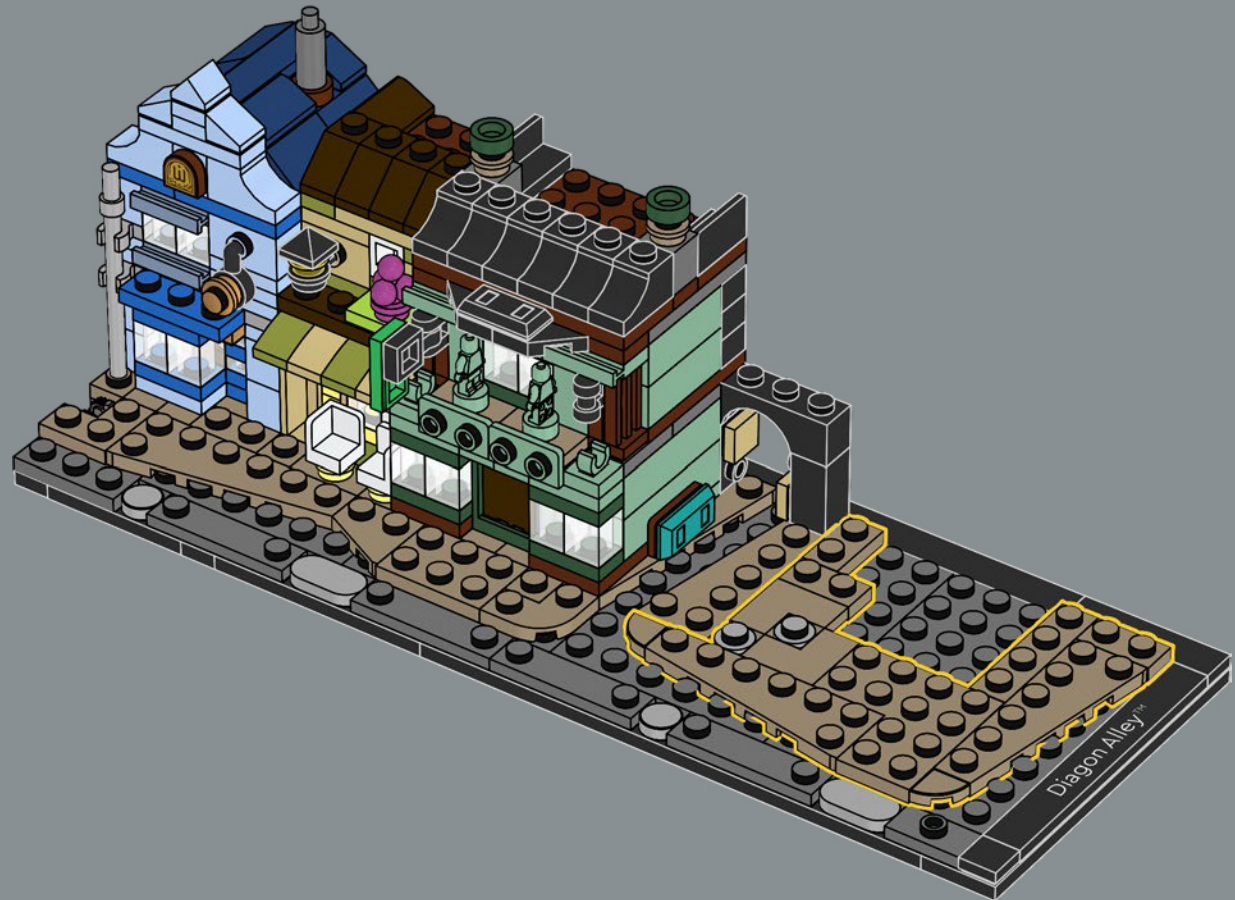

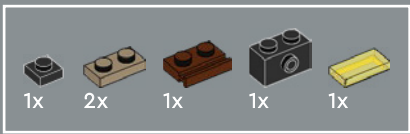

88

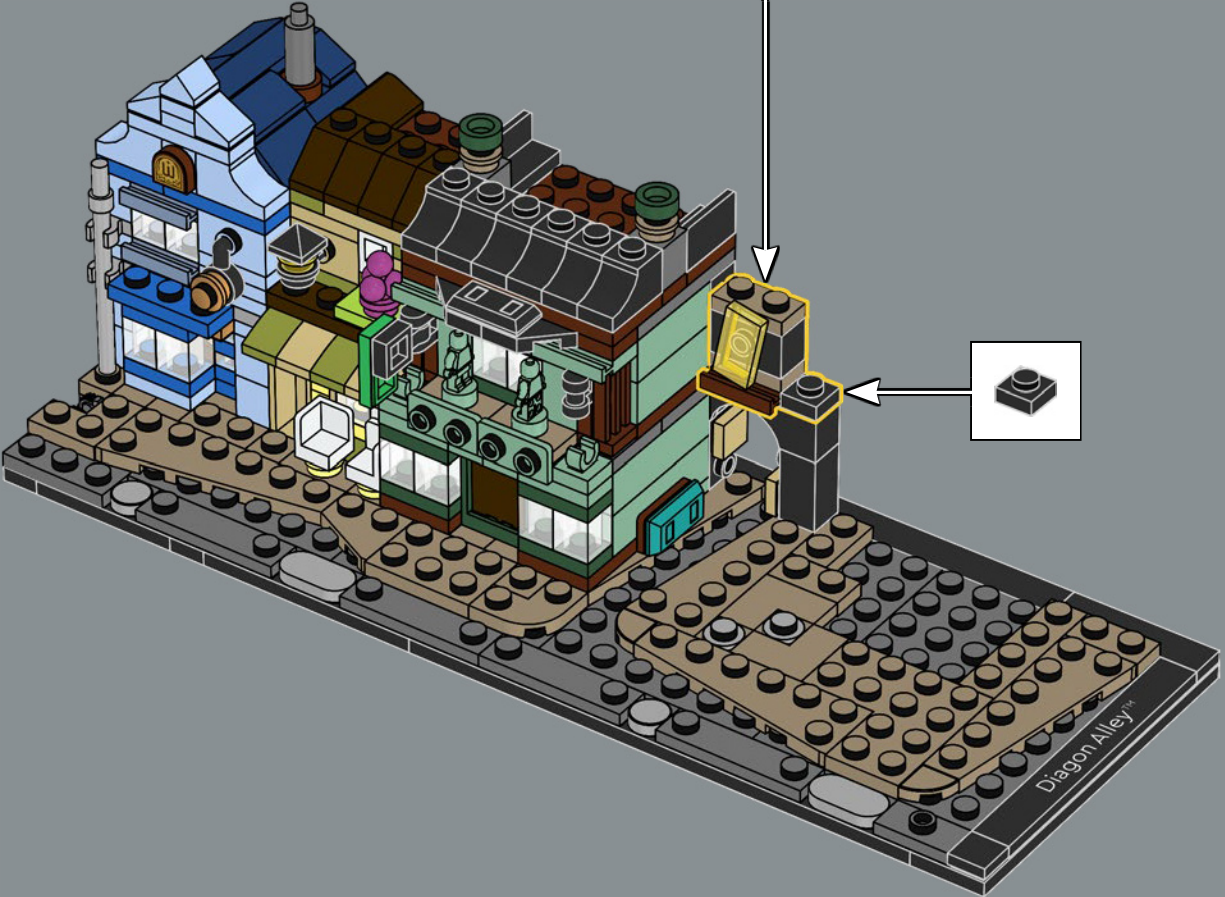
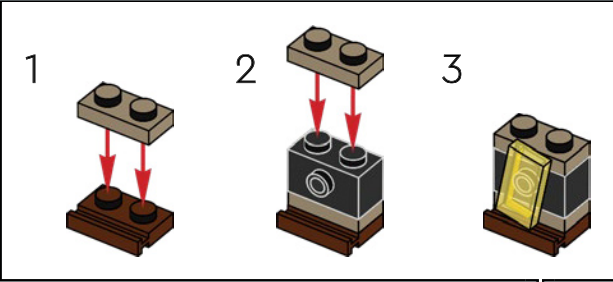

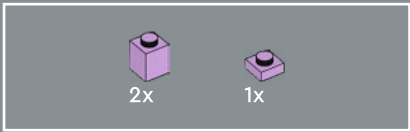

89

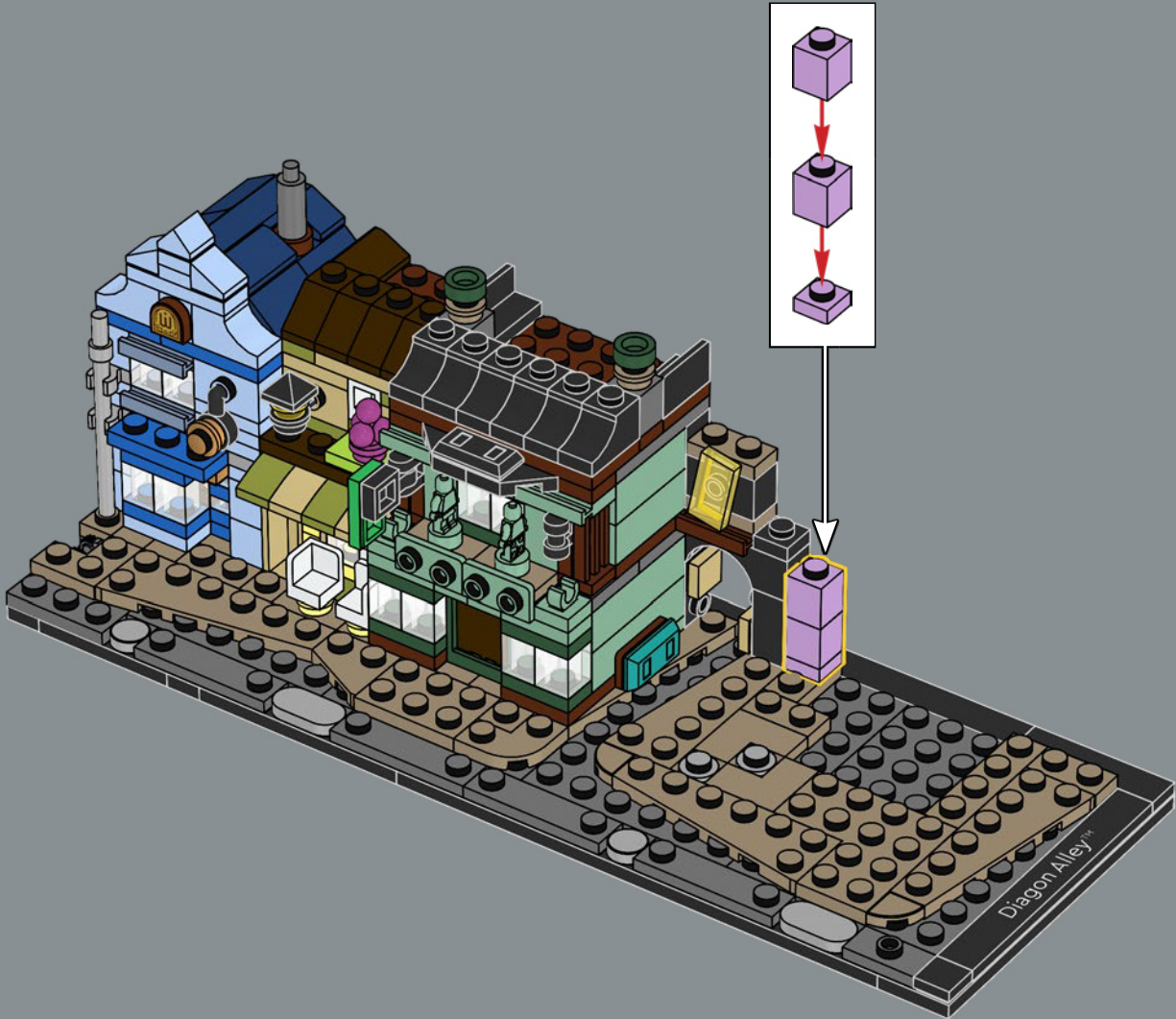



90

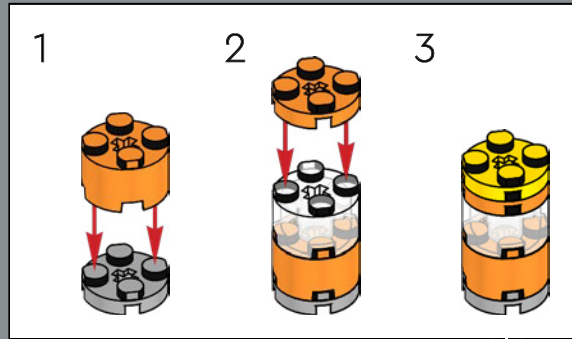

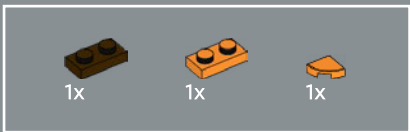

91





1x



1x

92



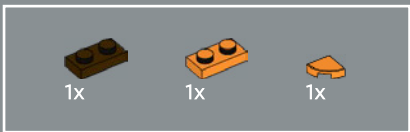

93

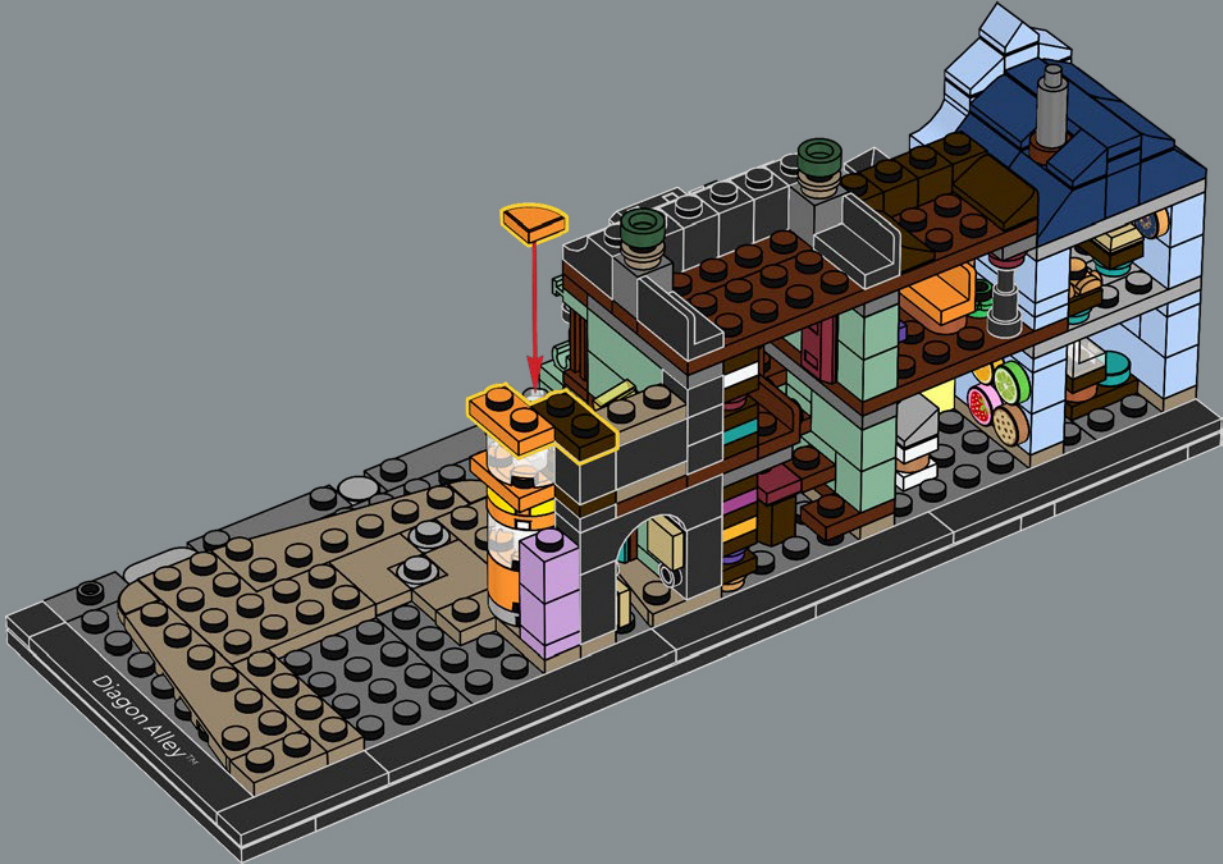



94



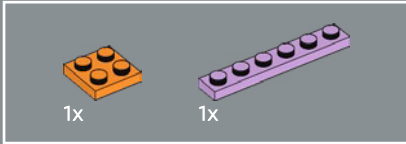
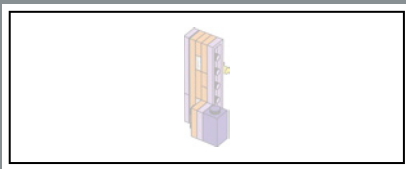

95

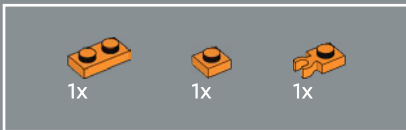
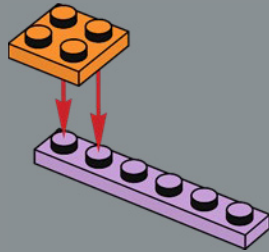

96

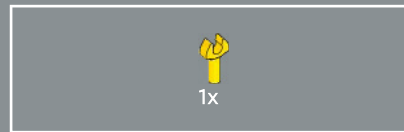
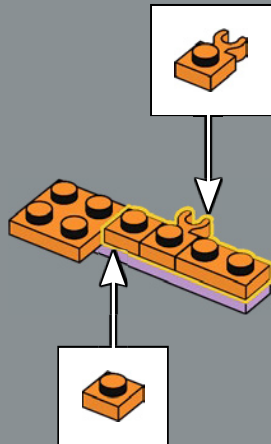

97

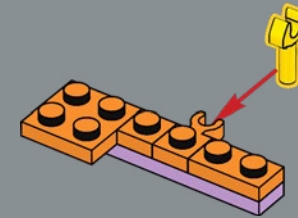

98

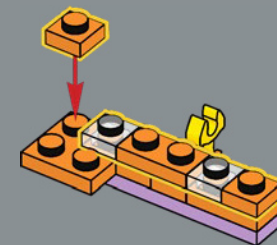

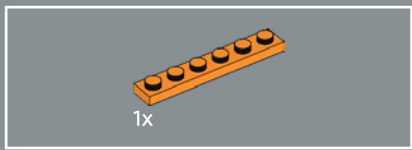

99

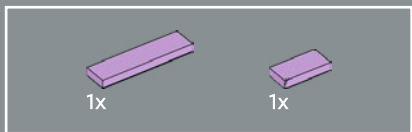
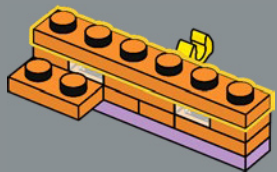

100

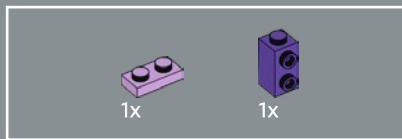
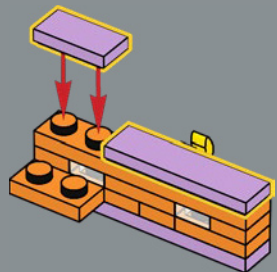

101

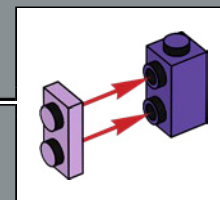

102



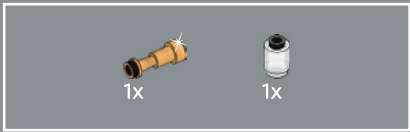

103



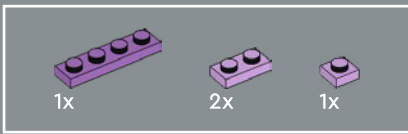

104

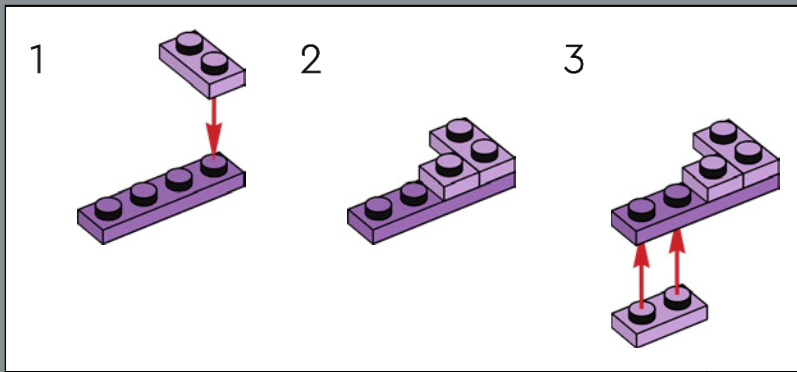

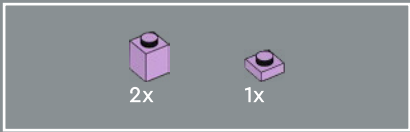

105

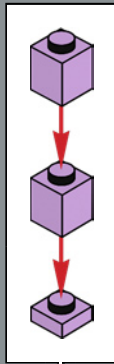

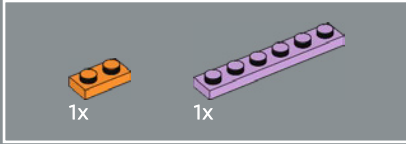
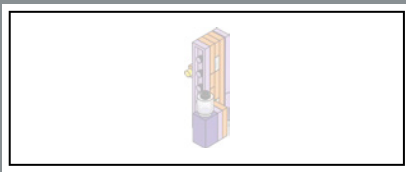

106

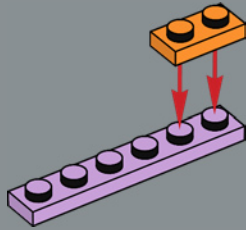

107

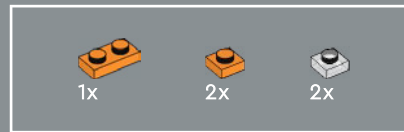
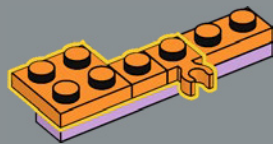

108

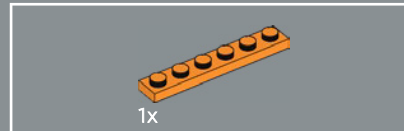
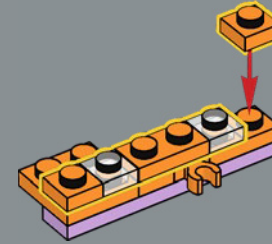

109

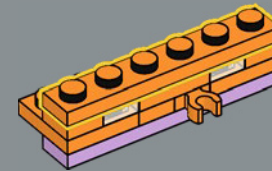

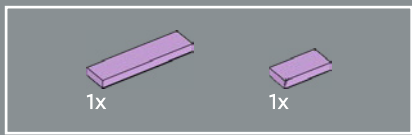

110

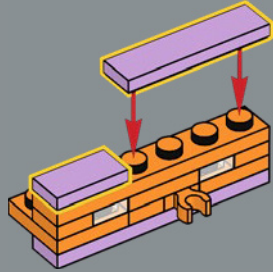

111

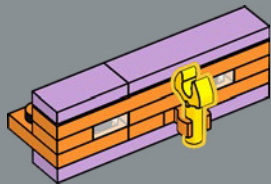

112

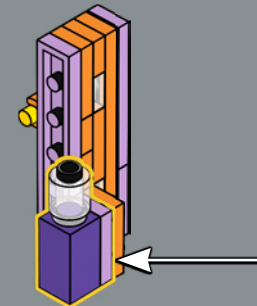
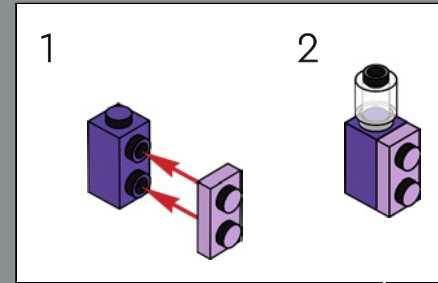

113



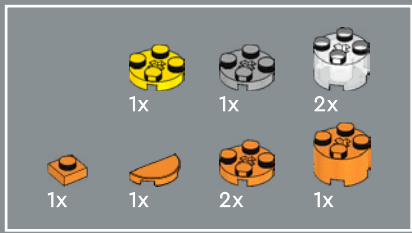

114

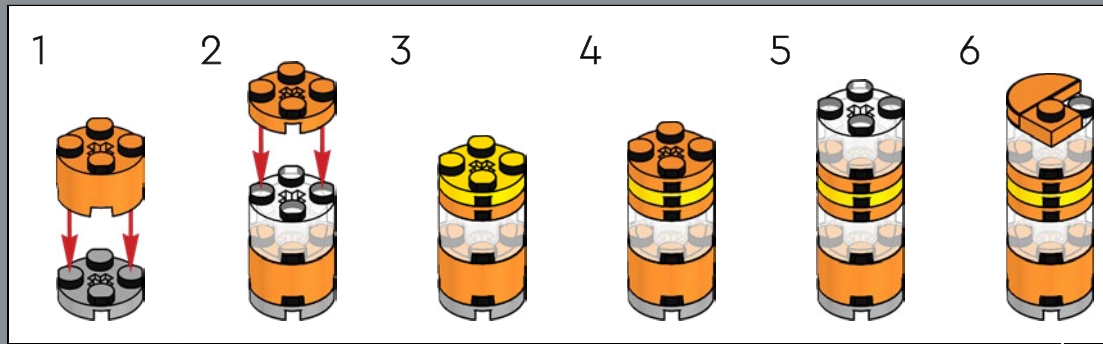

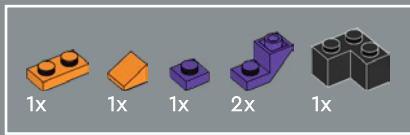

115

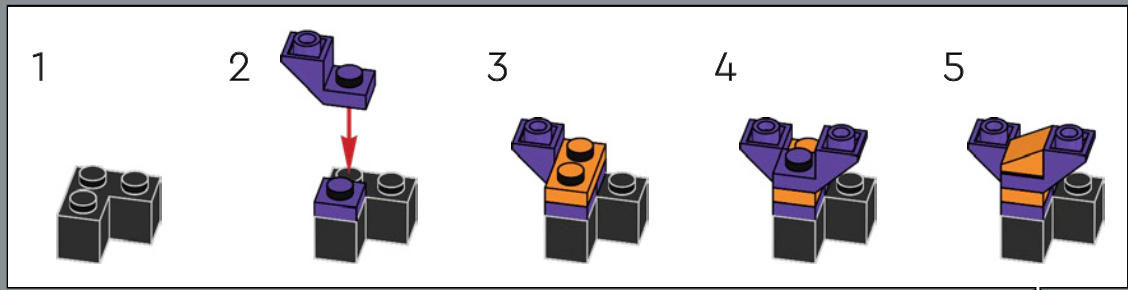

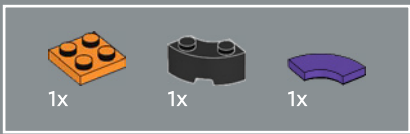

116



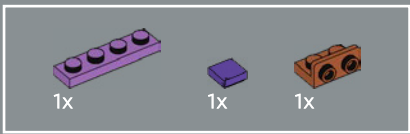

117

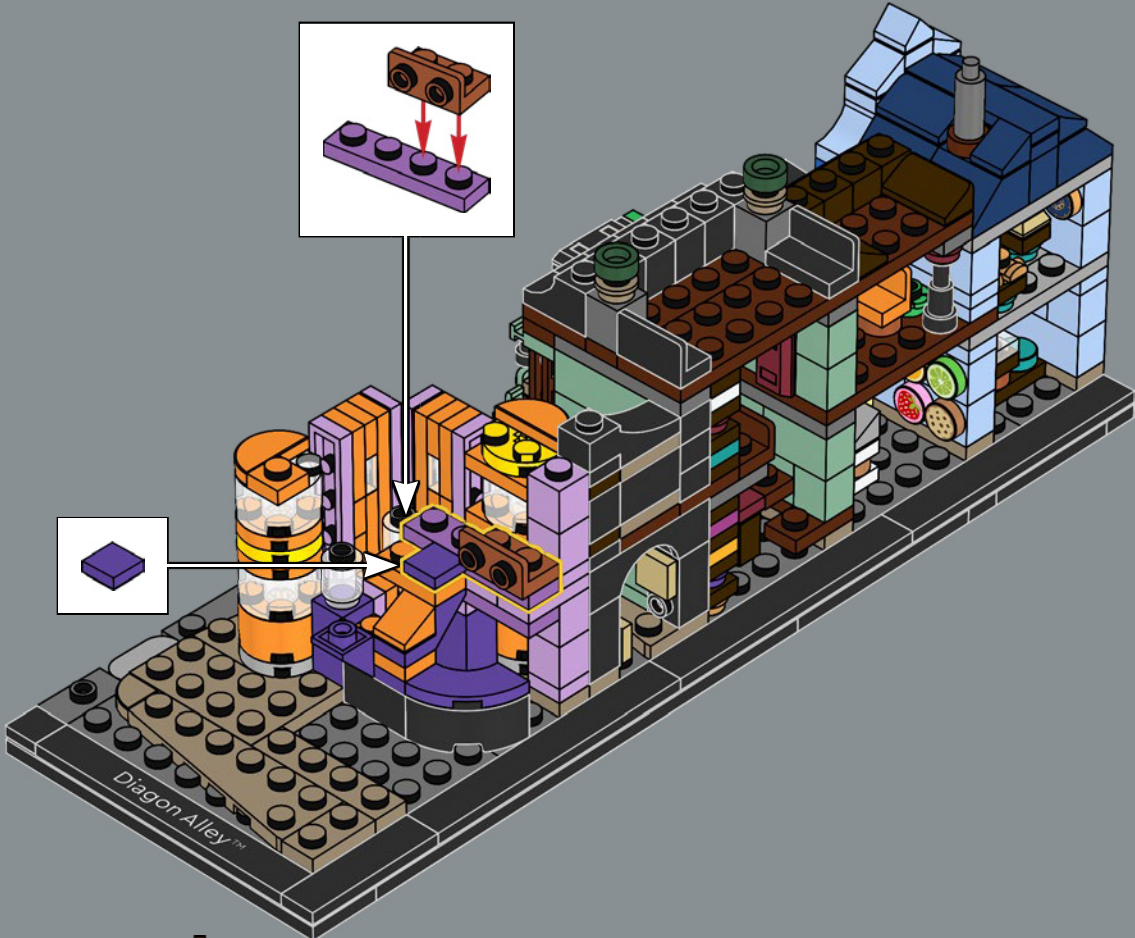

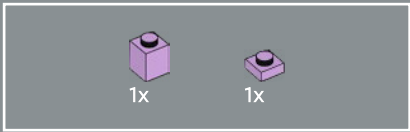

118

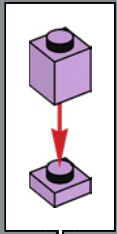



119

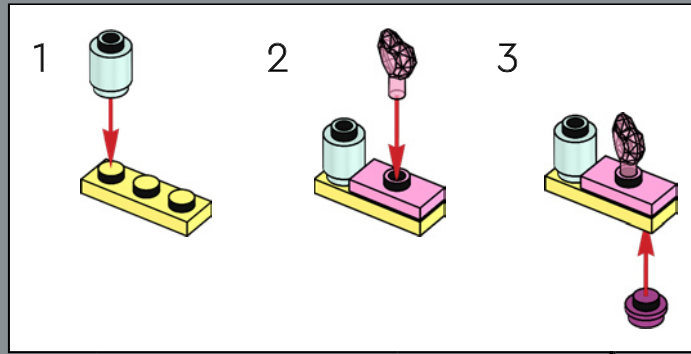



1x

120





121





122

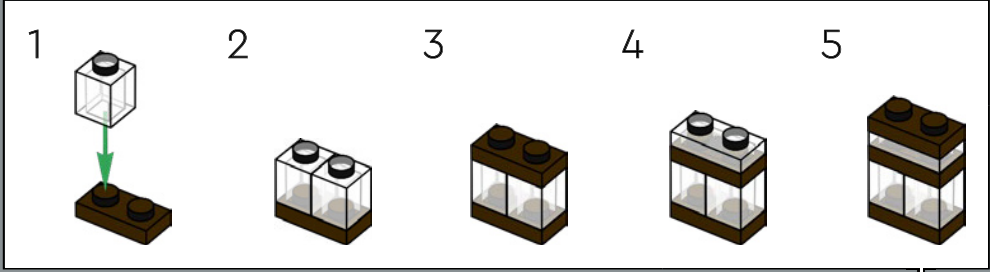

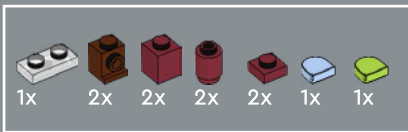

123

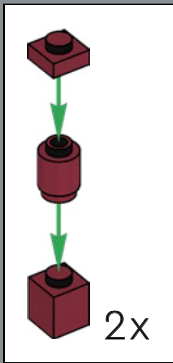
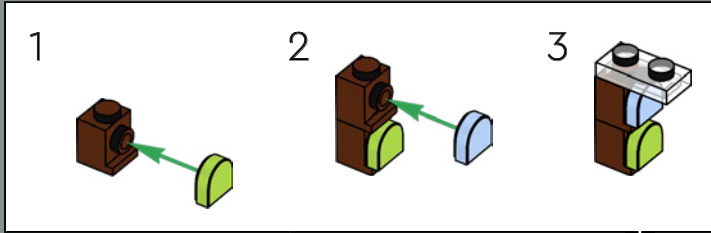



3x

124



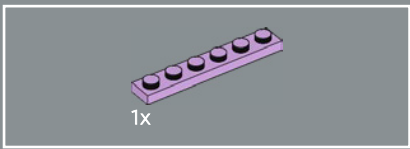

125



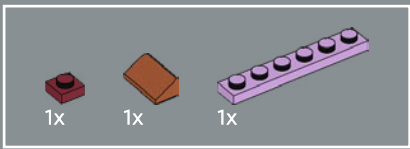

126

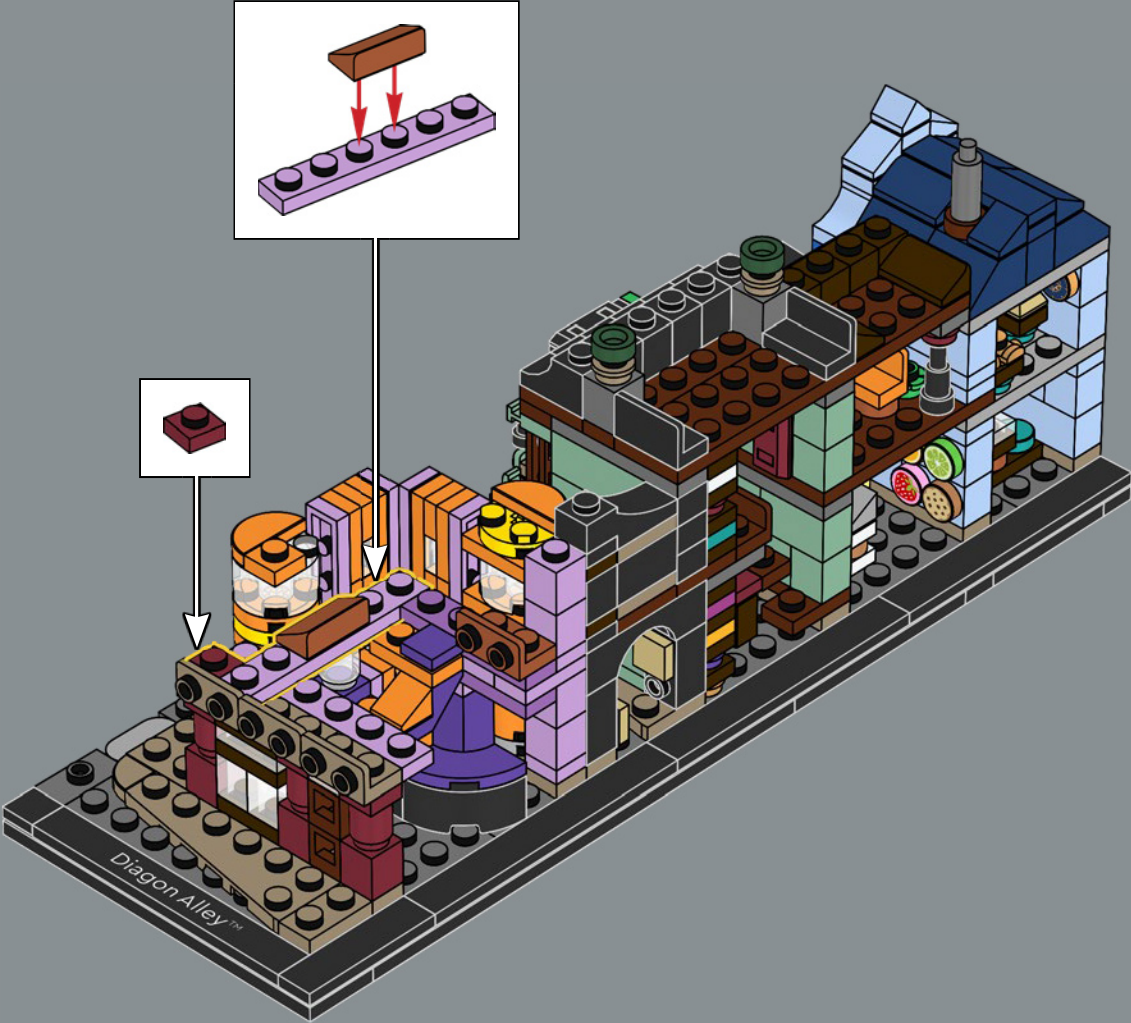

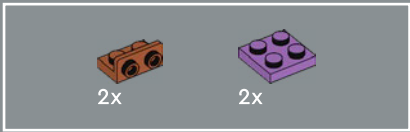

127



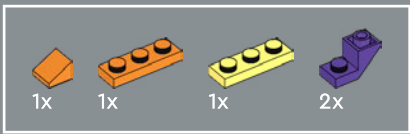

128

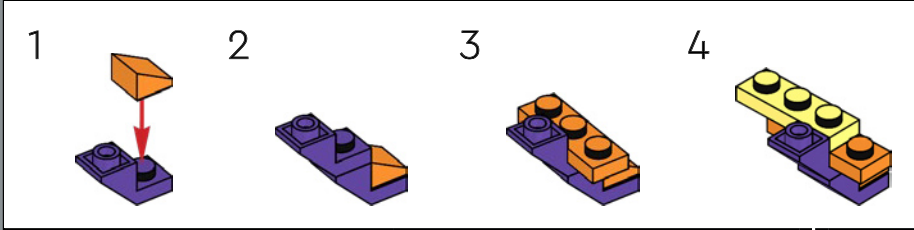



129



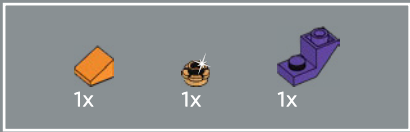

130

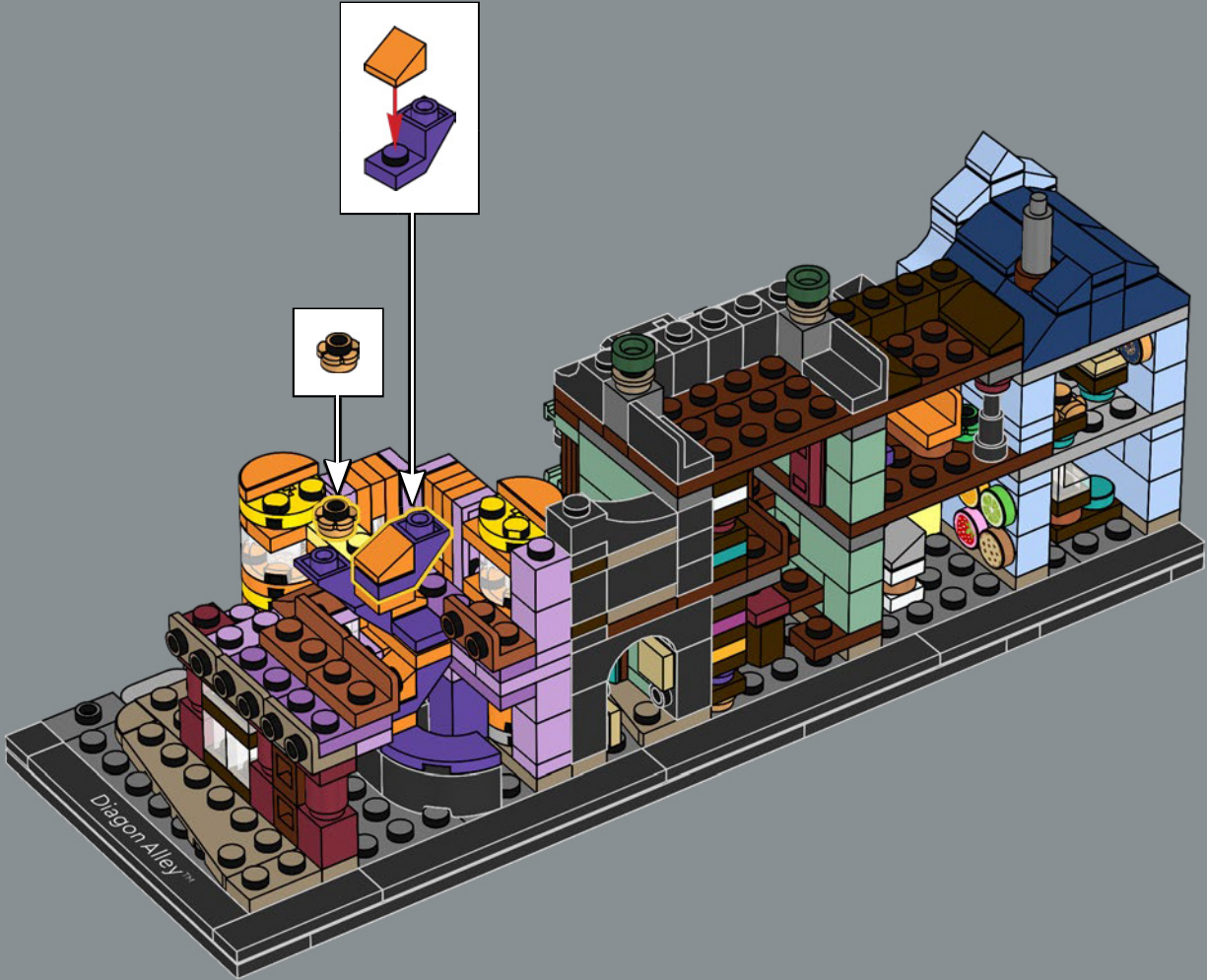

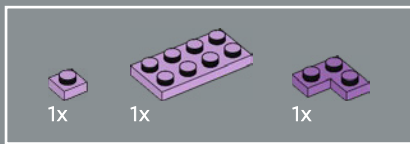

131

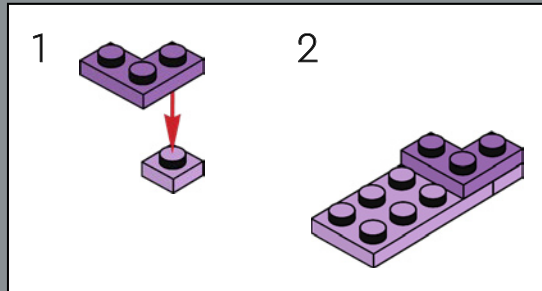

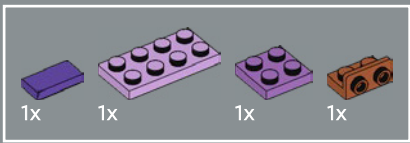

132

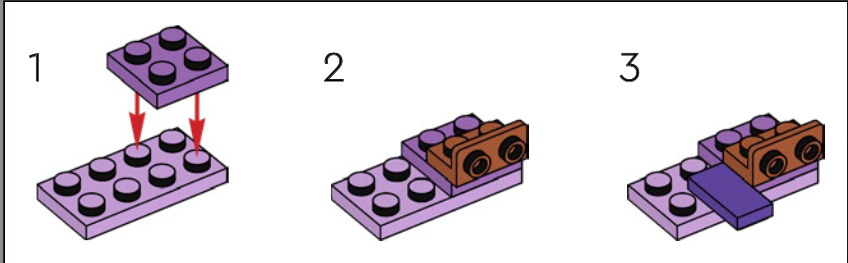



133





2x



3x

134

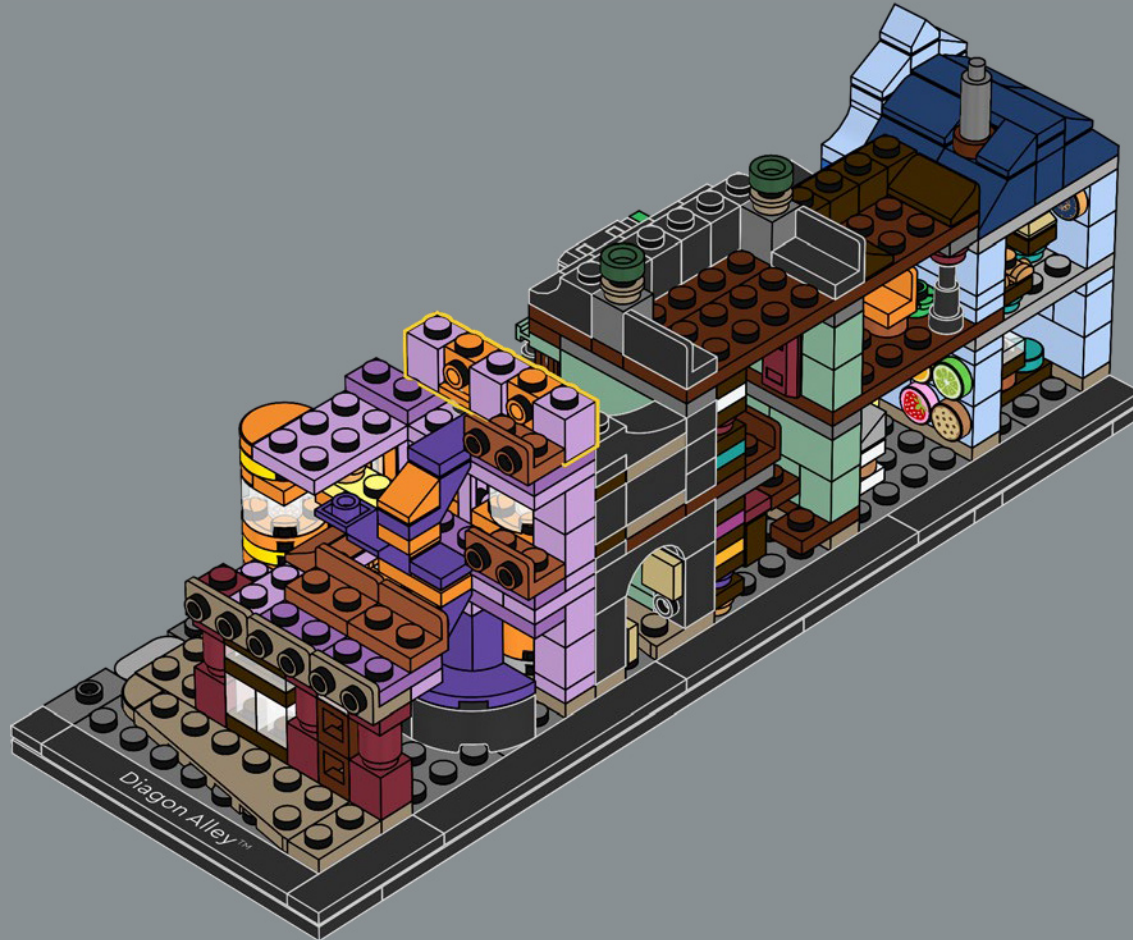

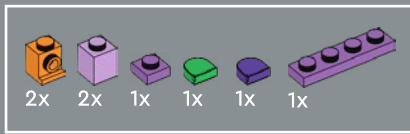

135

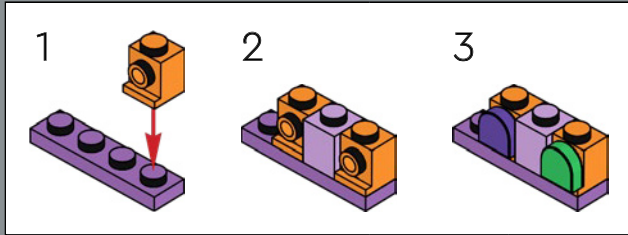
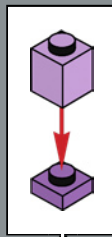



136





2x

137

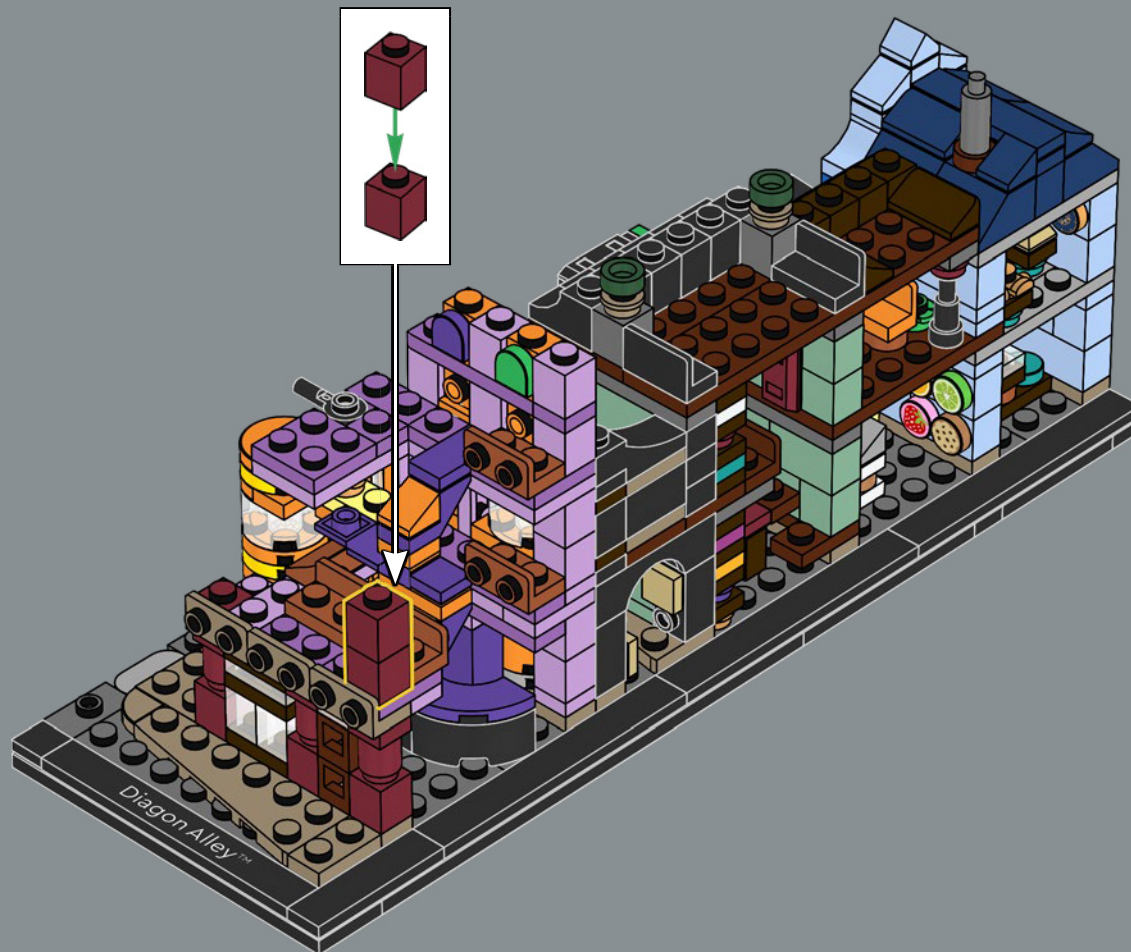



138

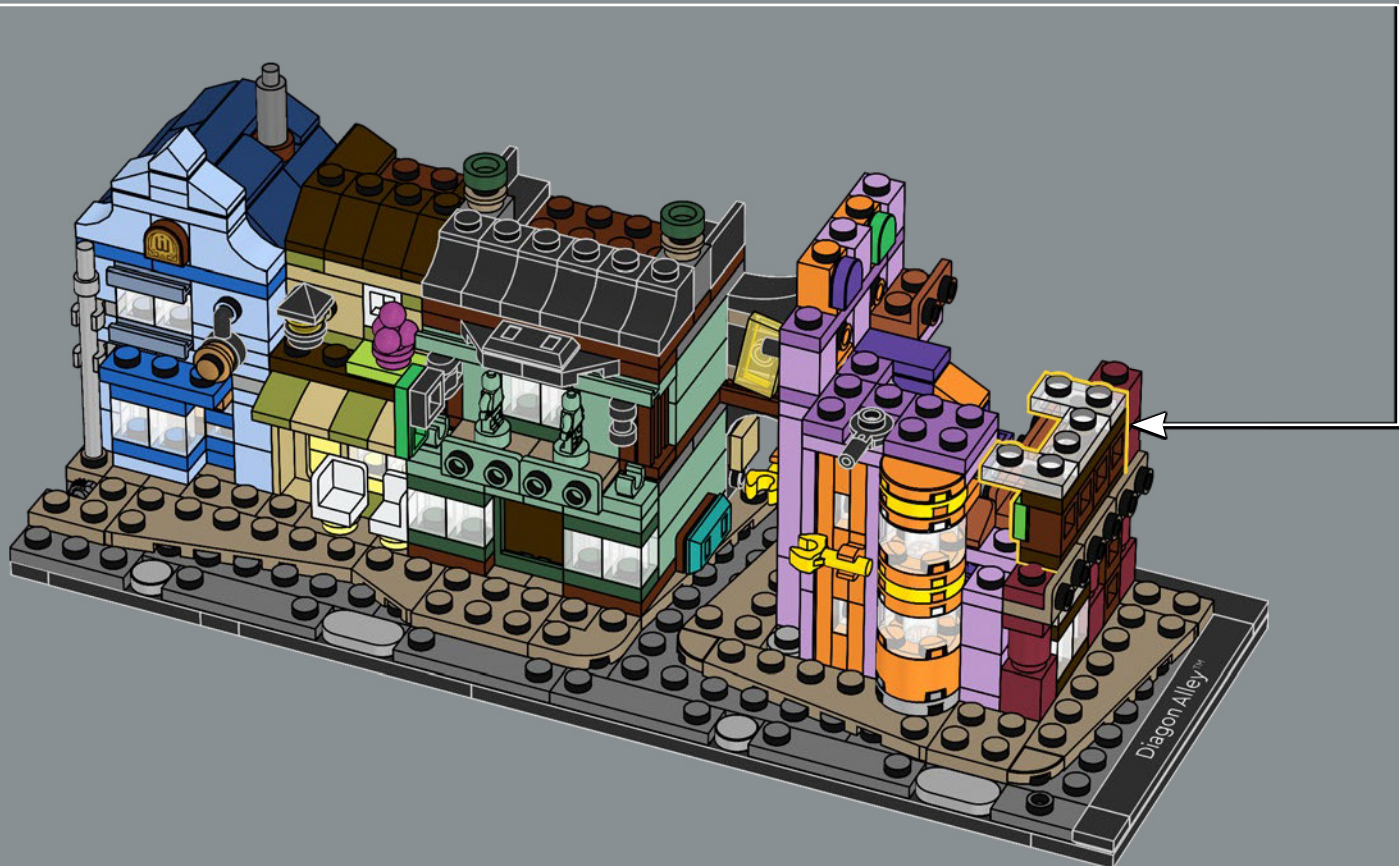
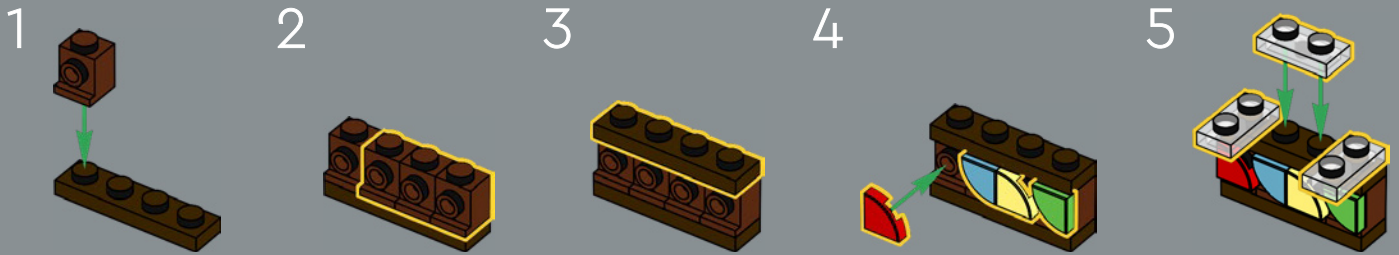

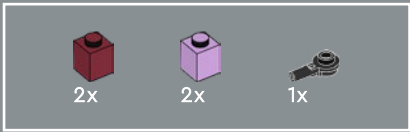

139





3x

140

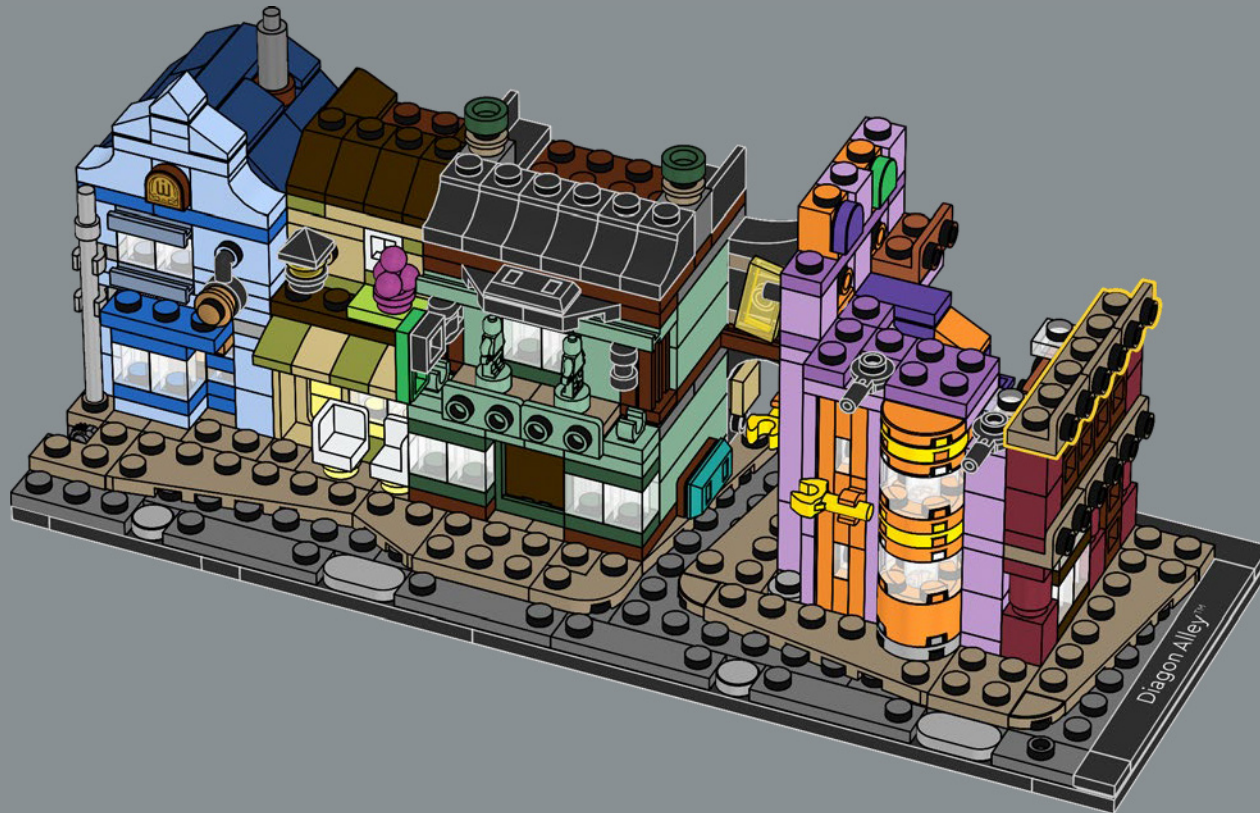

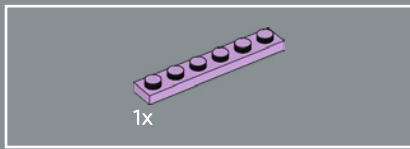

141

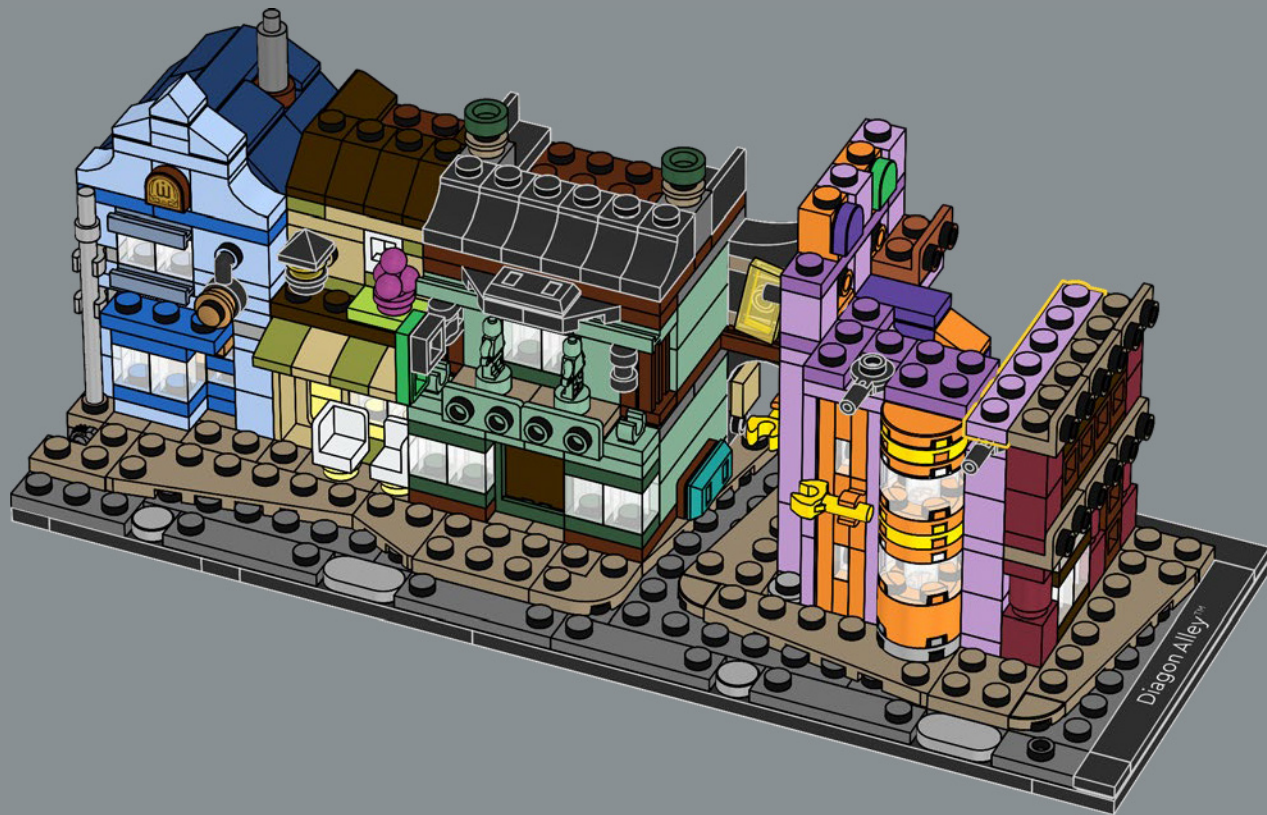

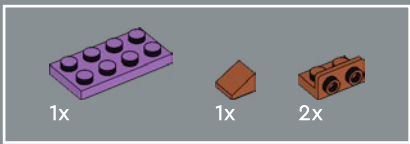

142

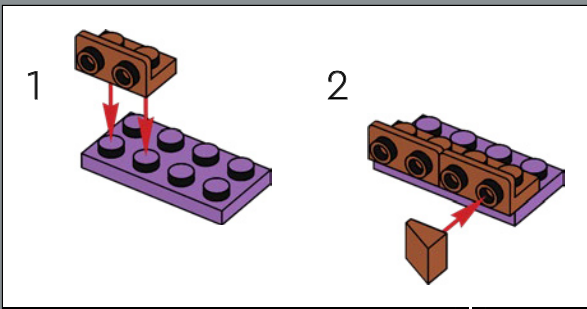



143



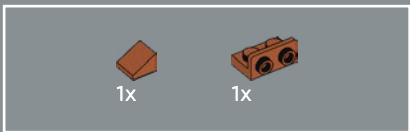

144

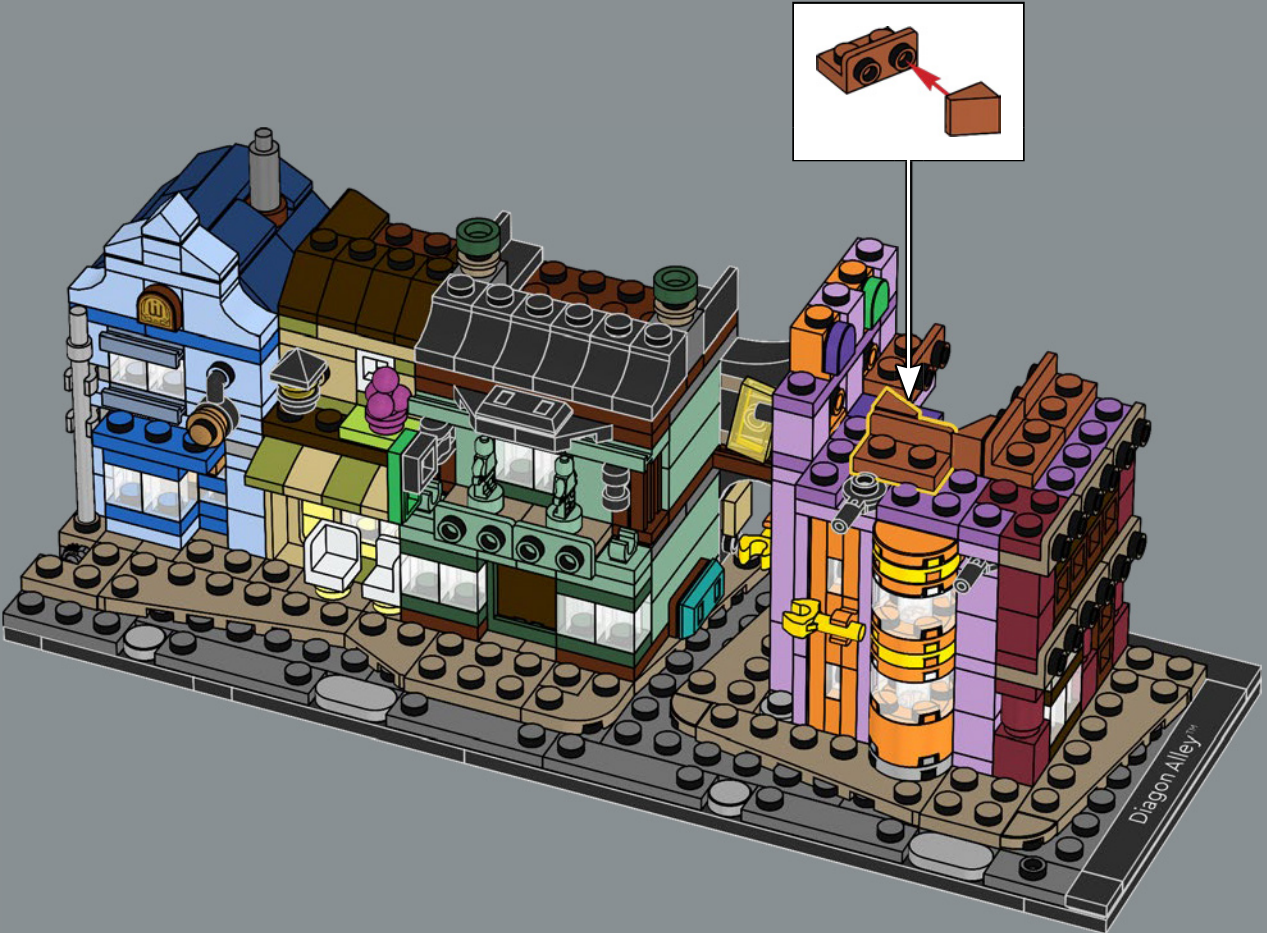

Dragon Alley™

2x 3x 4x

145

2x





146



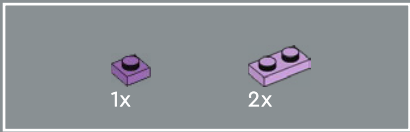

147

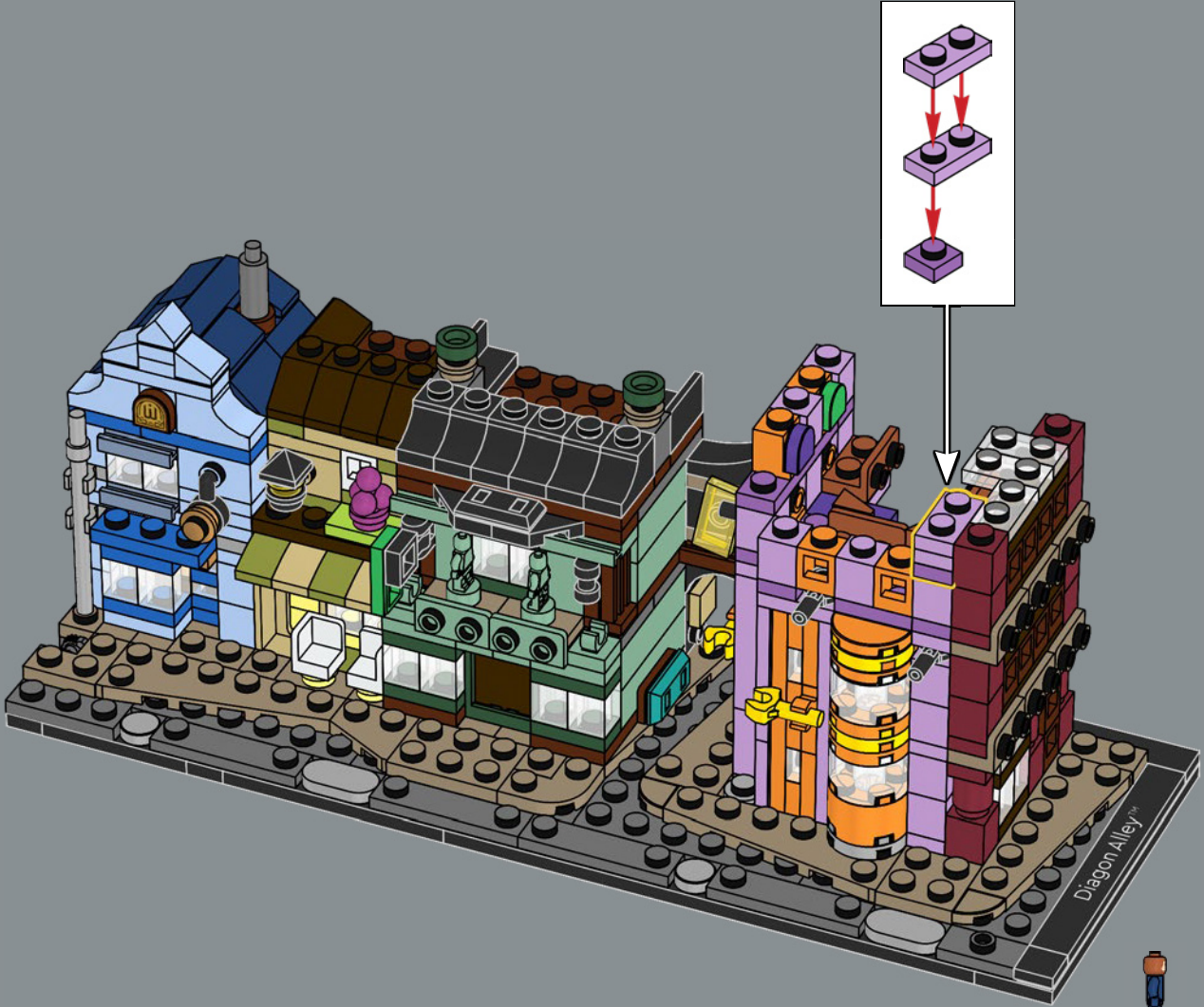

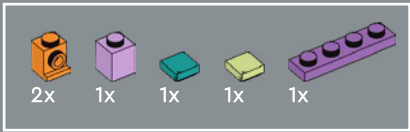

148

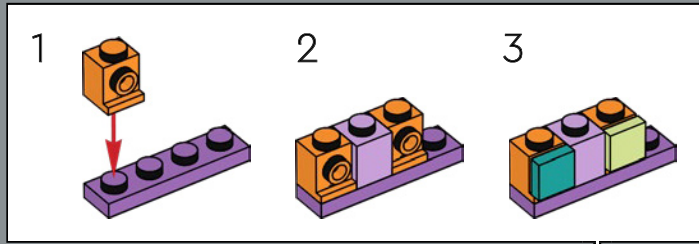



149



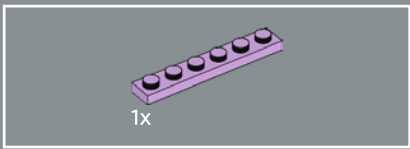

150



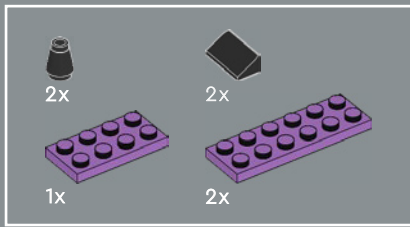

151

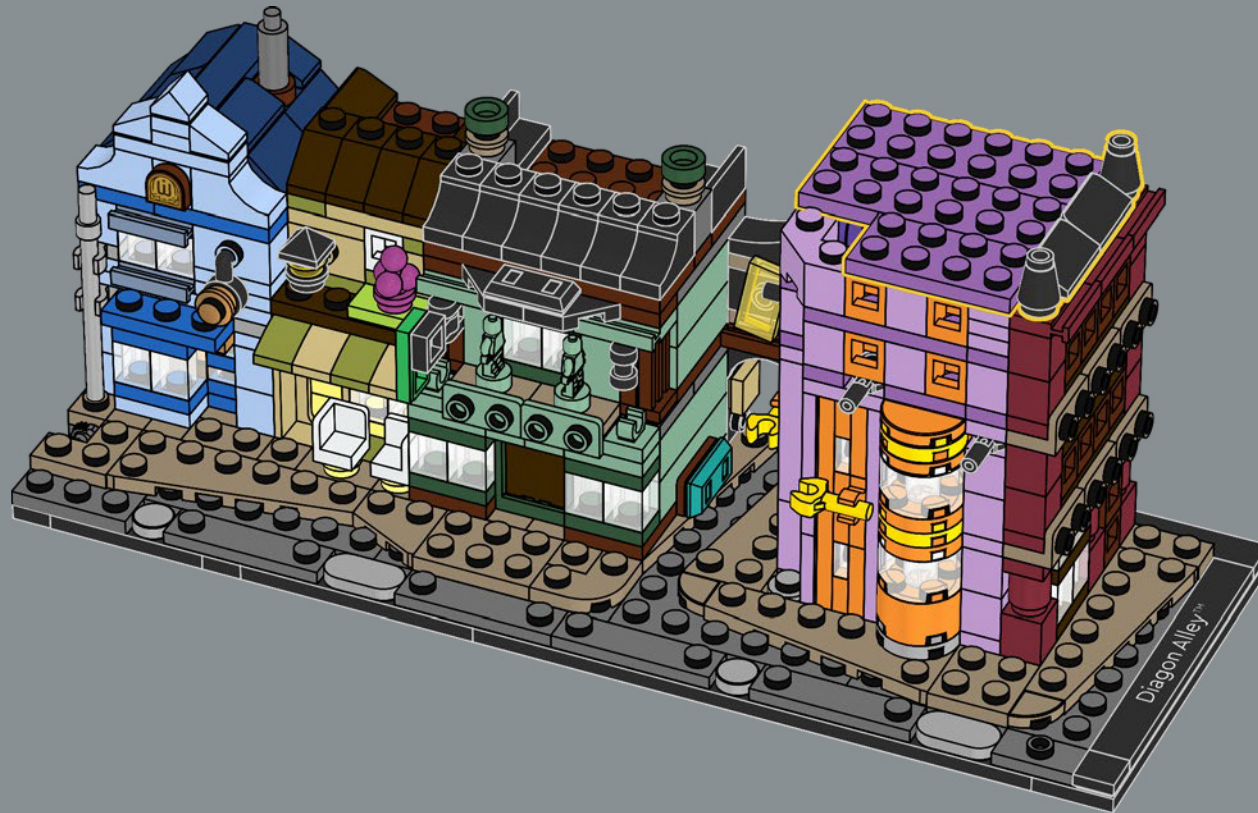

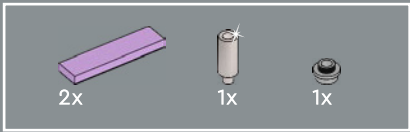

152

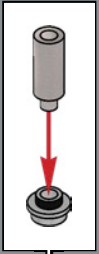



153

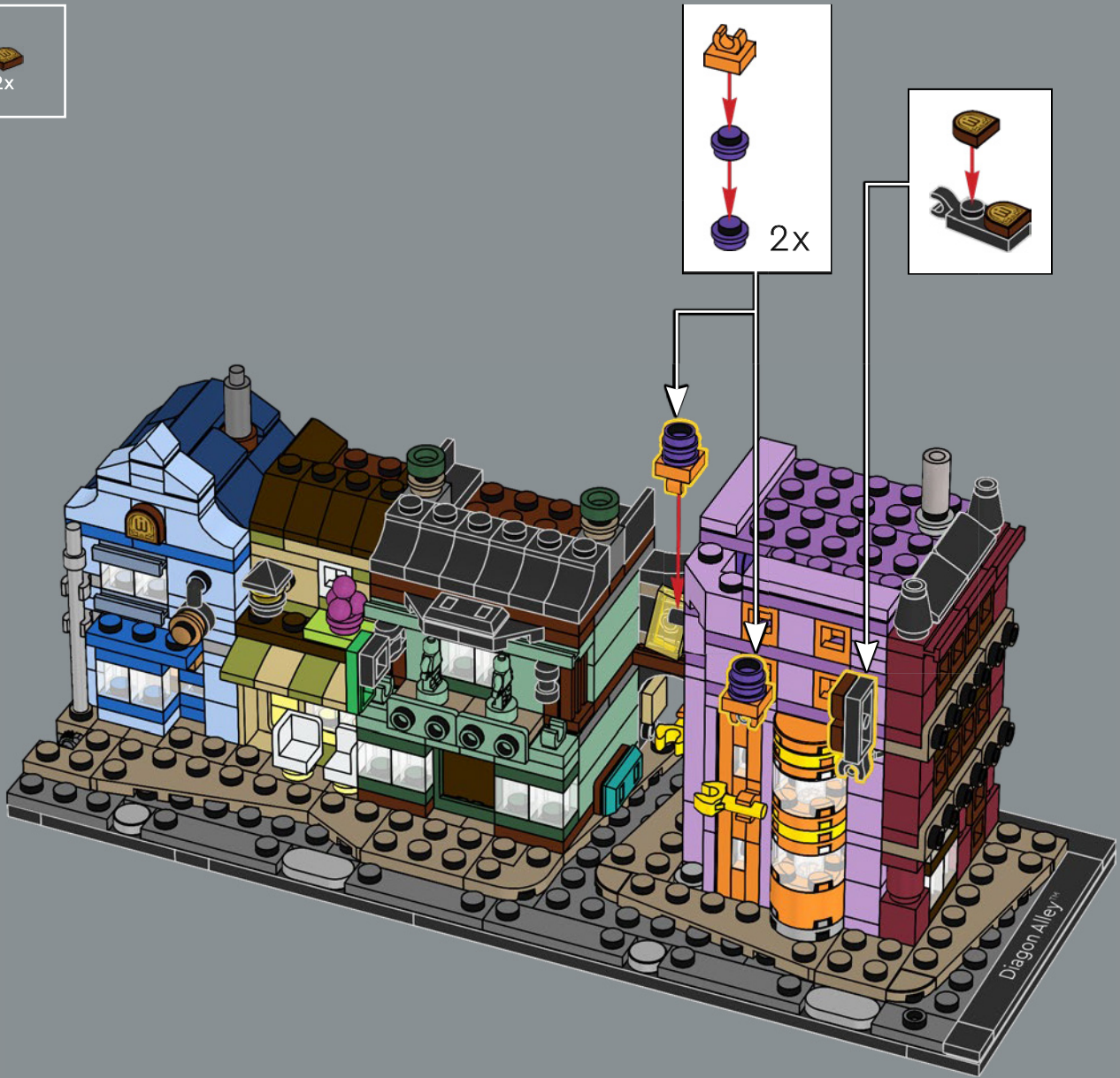

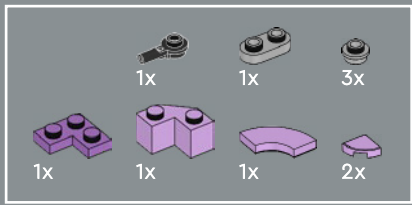

154

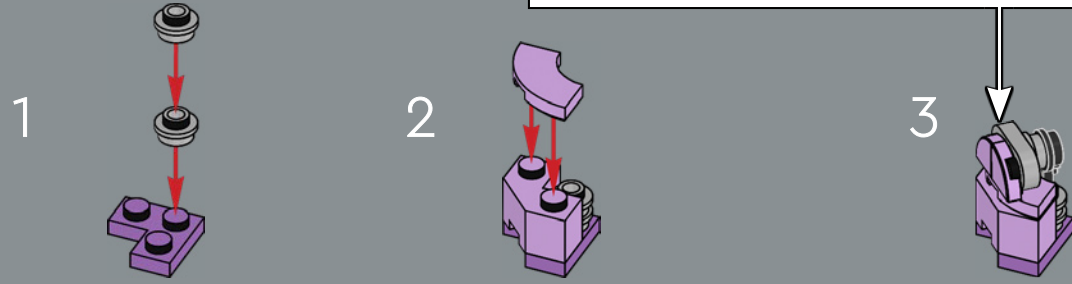

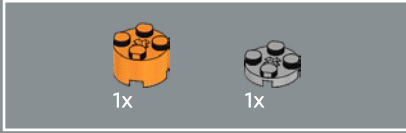
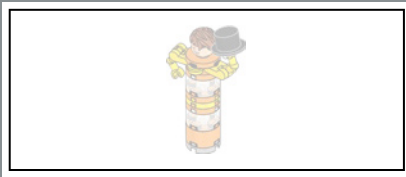

155

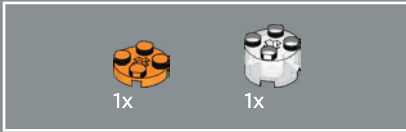
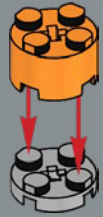

156



157

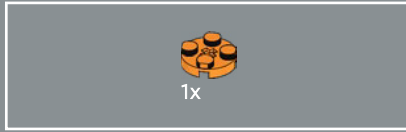

158



159



160





1x

161



1x



1x

162

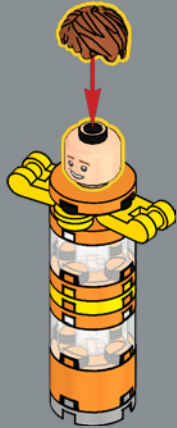

2x

163



1x



1x

164

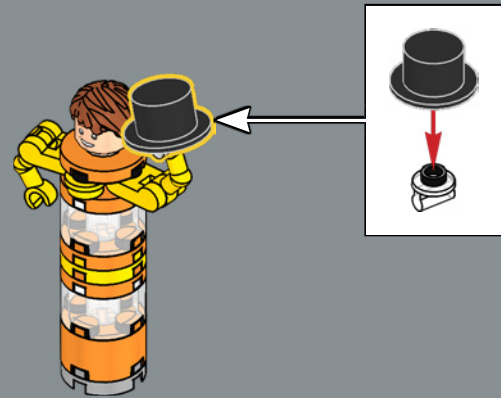



Tiri vispi Weasley

L'emporio di scherzi per eccellenza di Diagon Alley. Fondato da due amanti del divertimento, i gemelli Weasley, il negozio è un bizzarro vortice di magico caos. Dalle Puffole Pigmee alle Merendine Marinare, tante birichinate ti attendono!

			
1x	1x	3x	1x

166

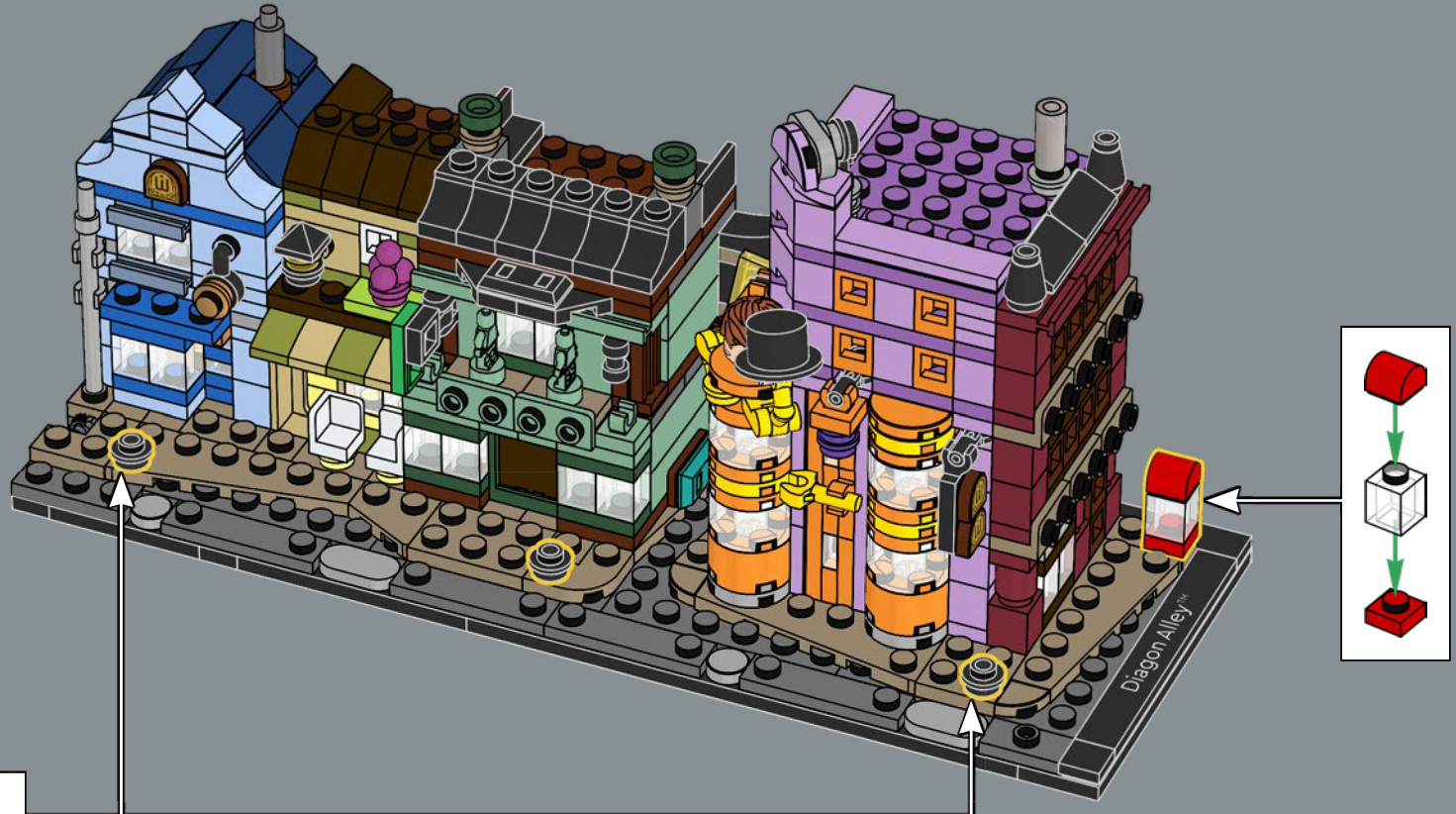

	3x
---	----



167

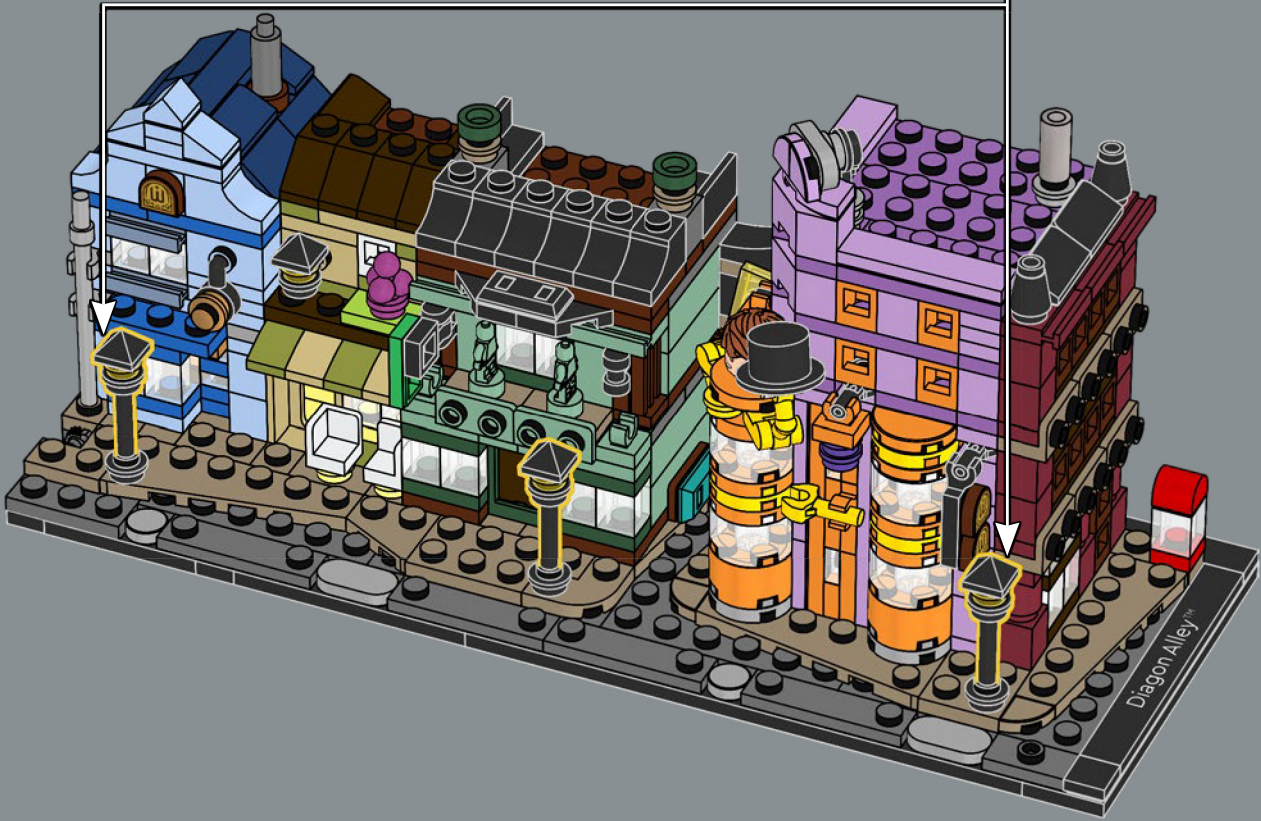
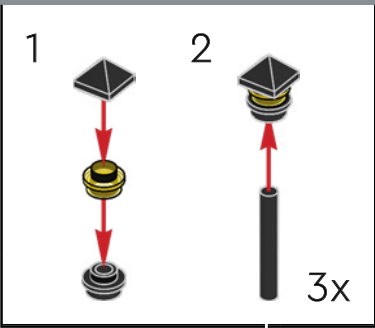



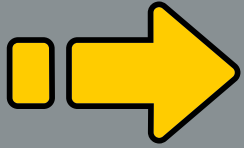



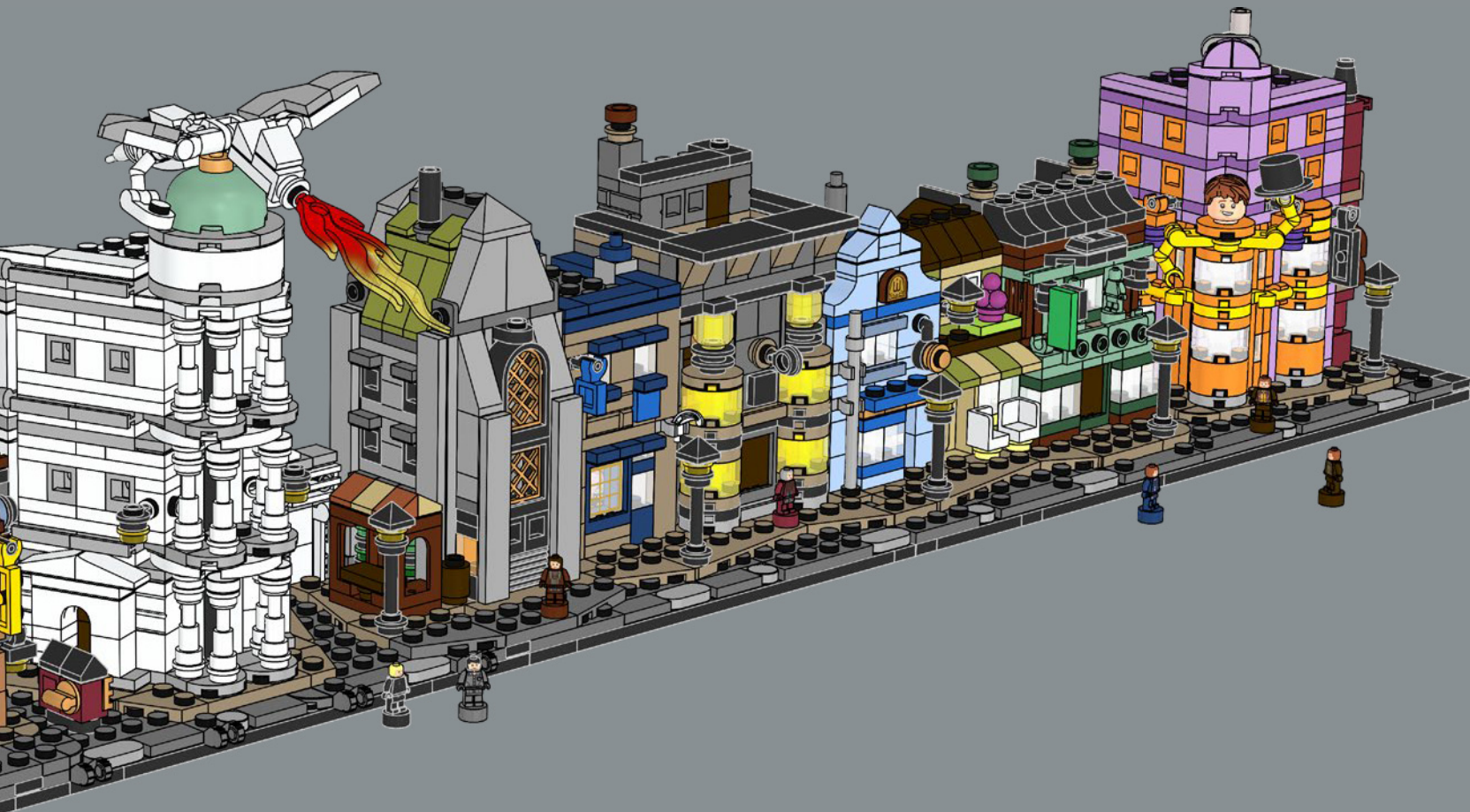

1x 6448949	2x 6224811	4x 4113261	2x 6195371	1x 4125220	1x 4114309	1x 6347291	1x 6523416	6x 307026	1x 6092664	1x 6266207	3x 303926
1x 6299492	2x 6296132	1x 6172927	2x 362301	1x 6232037	2x 6351905	2x 6421701	1x 6321194	7x 302426	4x 403226	1x 6382697	1x 4163373
2x 6322489	1x 4111971	1x 306901	2x 371001	1x 4642933	1x 6215539	3x 302323	29x 6168646	2x 6228987	1x 4105175	1x 6408578	1x 235726
9x 6284572	1x 4626882	12x 6070327	2x 4515347	5x 4642933	1x 6439048	1x 362323	2x 6186675	3x 6388352	2x 4644456	1x 6408578	1x 235726
21x 614101	1x 6510140	4x 6361170	2x 4515347	3x 6092587	1x 6439048	1x 302123	3x 306226	3x 6388352	1x 6510125	2x 4584274	3x 4584274
12x 6168642	1x 6510140	4x 6174937	1x 4558956	2x 6271228	1x 6258973	1x 302123	4x 614126	3x 6476097	1x 6510125	1x 4567436	1x 4567436
1x 6206149	4x 6174937	1x 4287707	6x 6497109	3x 4113917	2x 6224794	1x 6500394	3x 4529236	2x 6478177	1x 287726	2x 6146220	4x 362326
1x 6439046	1x 4533503	1x 4287707	1x 302001	1x 6333212	3x 302421	2x 614124	1x 6256435	1x 6508269	5x 306926	2x 6174243	3x 362226
3x 6406415	4x 6513919	1x 4287708	12x 6350399	1x 6329369	1x 4190219	3x 6439051	1x 6424674	1x 6424674	1x 302326	6x 6369578	1x 4558170
1x 6250591	2x 6252200	2x 6372037	2x 6443061	1x 6236728	1x 6170390	1x 6300104	6x 6508152	2x 6510139	1x 302326	1x 4538456	1x 4558170
18x 302401	1x 6510126	1x 6269074	3x 4161734	1x 6278441	1x 6510141	1x 4201587	2x 6477141	1x 6371584	1x 6308000	1x 6020193	2x 6272184
13x 300501	7x 6152409	1x 6431329	5x 4516055	1x 6510141	1x 6346804	1x 6248971	9x 407026	1x 6308000	4x 6210270	3x 4121966	6x 6199908
8x 6172366	22x 302301	4x 242001	2x 6435914	1x 6366181	1x 6366181	2x 6448638	5x 6439560	4x 6210270	4x 6196548	2x 6475339	1x 6382491
2x 6218841	4x 241201	2x 235701	4x 4113915	1x 6268862	1x 6268862	2x 6529042	10x 6312449	2x 6330189	2x 6330189	4x 6092585	1x 6328095
5x 4504369	4x 241201	2x 235701	3x 4579260	1x 6482746	1x 6482746	5x 403224	1x 6335388	2x 6157554	1x 6261348	1x 6093525	1x 4227392
1x 407001	3x 6529041	2x 4558168	12x 4159553	1x 4206330	1x 4206330	1x 6347284	7x 300526	4x 6458180	1x 300426	3x 302226	4x 6493691
2x 623101	2x 6176240	3x 4520970	9x 4125253	1x 6313611	4x 302423	1x 6315887	3x 6065496	1x 6051508	4x 6192309	2x 242026	1x 6162892

1x 302126	2x 303426	1x 403228	5x 6369194	3x 6507895	1x 6507870	1x 4157103	1x 6504995	1x 6264062	3x 6234348	1x 6480358
6x 243126	2x 303426	2x 302328	1x 6188477	1x 6510217	1x 6510163	1x 6439042	1x 4159007	1x 6092592	2x 6062089	2x 6385277
4x 371026	4x 447726	1x 306928	11x 4570877	1x 6454463	1x 6247792	2x 4558595	1x 6147047	1x 6248970	1x 6398673	1x 6480359
1x 6457282	5x 383226	2x 4157120	2x 4614158	2x 6254254	2x 6240551	2x 6173925	2x 4173332	1x 6459341	1x 611685	1x 6480359
1x 365926	2x 303026	1x 302128	4x 6361813	4x 6245250	1x 6254563	8x 4521571	1x 6311437	1x 6395622	2x 611685	2x 6388214
1x 365926	2x 303026	1x 6206150	4x 6468067	37x 6220959	18x 6514056	3x 4504371	5x 6325978	4x 6022035	3x 6248957	2x 6388214
3x 6439175	2x 303026	1x 6435099	2x 6092602	6x 6528235	1x 6247795	7x 4524929	1x 6213782	2x 6096942	2x 6484410	5x 6385281
1x 4560182	1x 302926	1x 6331100	1x 6092602	14x 6513962	2x 6513997	2x 4524929	1x 6213782	1x 6101073	1x 6523410	1x 6231386
1x 6350415	1x 302926	1x 6375605	1x 6314383	1x 6513962	1x 6277483	1x 6510144	1x 6213778	3x 6103415	5x 6300322	1x 6231386
1x 366626	8x 6001494	1x 6275873	7x 6440767	1x 6254552	1x 6315923	1x 6474196	1x 6391344	1x 6037658	2x 6300320	2x 6385280
2x 663626	1x 306228	13x 6315782	2x 6228839	1x 6245306	1x 6315923	1x 6347295	1x 6391344	1x 6037658	2x 6300320	2x 6385280
4x 379526	1x 6338221	1x 6359273	2x 4615606	10x 6514281	1x 6315923	3x 6510077	1x 6254100	1x 6247799	4x 6362967	6x 6002843
12x 416226	3x 6135287	7x 6104342	3x 6186007	22x 6514001	1x 6513987	2x 6352223	1x 6247796	6x 6429608	15x 6055172	6x 6002843
1x 4558593	1x 6374150	10x 6186012	7x 6074892	1x 6514223	4x 6514285	6x 6030521	1x 6240042	7x 6257079	5x 6273590	3x 6328445
	2x 6250600	1x 6439726	2x 6223040	1x 6246888	1x 6514221	3x 4141089	1x 6448749	2x 6062686	5x 6310988	6x 6454938
	1x 4529239	1x 6374150	2x 6223040	2x 6514051	2x 6514234	1x 6109909	3x 6209692	2x 6382727	13x 4549436	2x 6132767
	2x 6250600	4x 6254484	2x 6514232	1x 6247785	2x 6514057	1x 6092599	1x 6250601	3x 6198156	5x 6001824	16x 6092591
	1x 4558593	1x 4529755	1x 6247798	1x 6514003	1x 6247788	7x 4177932	1x 4621557	2x 6212055	4x 6040126	15x 4528604

3x 4521914	5x 6328307	3x 4255413	1x 6312450	4x 6099189	2x 4539092	2x 6322822	4x 4221744	6x 4645103	1x 6436421	1x 6163478	2x 6383177
1x 6146234	6x 6035540	1x 4184108	2x 6392975	1x 6125672	3x 6314247	1x 6435103	10x 4225469	1x 6295302	1x 6347715	6x 6510058	2x 4211388
2x 4496699	18x 4626904	1x 4504374	5x 4521915	1x 6303004	1x 6311108	9x 6073040	1x 6238874	2x 4211257	7x 6284071	12x 6507791	3x 6261353
1x 6449563	5x 6001822	9x 6236571	2x 4504375	2x 4616578	13x 4539114	2x 6396678	1x 6248944	10x 6251470	3x 4211525	2x 6311384	6x 4515374
1x 4646577	1x 6257599	3x 6216905	3x 6382733	3x 6449861	11x 4541376	2x 6359662	1x 6153863	4x 4211152	9x 6168647	1x 6248890	6x 4515374
6x 6250168	1x 6175927	4x 4528488	13x 6013102	5x 4616581	3x 6212040	1x 6523415	2x 6153863	2x 4211152	2x 6258831	6x 6225246	1x 6066097
1x 4616711	1x 6175927	2x 6382723	2x 6013102	4x 4616581	5x 4539097	7x 6186673	1x 6092568	2x 4211189	1x 6481838	1x 6225142	1x 6313114
1x 6210495	3x 4267874	9x 6092588	2x 6020923	2x 6423391	1x 6382785	1x 6215659	5x 6063447	1x 4211189	2x 6250597	2x 6296894	15x 4211568
5x 6047415	1x 6015424	4x 6384915	2x 6020923	3x 6222362	2x 4541506	4x 4216581	9x 4224243	1x 4595889	10x 4211415	1x 6446028	15x 4211568
7x 4550168	1x 6015424	2x 6363600	4x 4245571	1x 6186823	1x 6448315	2x 6328180	3x 6397820	4x 4211190	17x 4211476	1x 6354568	1x 6446028
2x 6456637	1x 6151537	1x 4586057	4x 4245571	1x 6186823	1x 6092597	3x 4211288	6x 4620075	1x 4211186	2x 6075075	2x 4211807	1x 6354568
2x 6126075	2x 6156492	2x 6335936	1x 6529040	1x 6186823	3x 6186005	6x 4620075	3x 4211288	1x 4211590	1x 6225139	7x 4211475	1x 6122077
2x 6398654	1x 6132566	6x 6403175	2x 6330616	1x 6529040	1x 4585751	4x 6062574	4x 6092590	1x 4221590	1x 4211389	4x 6163990	2x 6177078
1x 6523411	1x 6132566	2x 4652205	2x 4521947	1x 6529040	1x 4585751	4x 6062574	1x 6291040	1x 4211247	3x 4211399	1x 4642934	4x 6211969
10x 6132768	1x 6132566	4x 4521948	2x 6330616	1x 6523418	1x 4539062	4x 6062574	2x 6361793	1x 4211247	1x 6308012	8x 4211398	1x 4211429
16x 6449594	1x 6523409	4x 4521948	2x 6330616	4x 4539099	2x 6507868	4x 6062574	4x 4211150	1x 4211247	8x 6225242	6x 4211414	10x 4211445
1x 6015452	1x 6450979	3x 6328131	2x 6330616	4x 4539099	2x 6240550	4x 4539099	4x 4504376	1x 4211247	11x 6401023	6x 4211414	2x 6257593
2x 6429553	2x 6384913	2x 6348059	2x 6330616	1x 6186645	4x 6254252	2x 6371437	2x 6174856	1x 4211214	3x 4521921	2x 6435915	



1x 6047422	1x 6335932	4x 6146054	3x 4538126	2x 6404033	1x 6474266	1x 6489195	4x 4619524	13x 6058245	5x 6062697
1x 6199899	1x 6445157	1x 6132266	1x 6342678	4x 4518557	1x 6380634	5x 6343854	2x 4619516	7x 6002841	1x 6186030
1x 6366705	5x 6209691	2x 6477142	5x 6338242	1x 6347286	2x 6433634	1x 6214214	2x 4625027	4x 6469109	1x 6408049
1x 4626935	1x 6328909	7x 6069887	1x 6523412	2x 6454543	2x 4656783	1x 6336564	1x 6214235	3x 6058242	1x 6408049
1x 6030277	15x 4523159	2x 6508110	1x 6523413	18x 6518013	4x 6218360	6x 4619636	2x 6439052	1x 6398008	1x 6217492
1x 6167472	1x 6372427	1x 6173106	7x 6315780	1x 6336664	1x 6021997	1x 6150307	16x 6097053	7x 6312356	2x 6475308
2x 6030277	8x 6190252	2x 6503258	2x 6022105	9x 6252667	1x 6492538	1x 6248486	5x 6099363	5x 6016483	1x 6422223
1x 6167472	1x 6287847	4x 6284379	3x 6322813	1x 6473454	2x 6346464	1x 6523414	2x 6240465	3x 6469108	9x 6287309
1x 6314968	5x 6186672	3x 6335111	4x 6512546	1x 6226792	6x 6192922	1x 6335549	6x 6099190	5x 6024722	2x 6514199
	1x 4529247	1x 6219088	5x 6226437	1x 6507869	3x 6292145	1x 6523419	1x 6099352	2x 6345796	2x 6514203
	1x 6501299	1x 6218047	7x 6492338	1x 6247800	5x 6365746	12x 6209684	2x 6345796	1x 6473447	2x 6376825
	2x 6453281	1x 4490599	29x 6194729	1x 6247800	3x 6252194	6x 4619521	1x 6522797	1x 6024722	2x 6376825
	1x 6489198	8x 6218047	2x 6473752	5x 6300103	1x 6287854	1x 6210460	2x 6529044	4x 6101169	1x 6483784
		2x 6207933	2x 6127366	1x 6287854	9x 6057986	4x 6335182	4x 6101169	2x 6099355	1x 6483784
		3x 6092594	3x 4519970	1x 6287854	10x 6215606	4x 6485862	2x 6099355	6x 6204071	2x 6278088
			2x 6127366	9x 6057986	3x 6252194	1x 6210460	2x 6099355	1x 6204071	1x 6304896
			3x 4566688	10x 6215606	1x 6467273	4x 6335182	2x 6099355	2x 6278088	
			7x 6058221	2x 6422082	1x 6438781	2x 4619517	6x 6204071		



 [LEGO.com/service](https://www.LEGO.com/service)



YOU COULD WIN



YOU COULD WIN

Your feedback will help shape the future development of this product series.

Visit:

DU KÖNNTEST GEWINNEN

Dein Feedback trägt zur Weiterentwicklung dieser Produktreihe bei.

Geh auf:

VOUS POURRIEZ GAGNER

Vos commentaires nous aideront à concevoir les futurs produits de cette gamme.

Visitez :

POTRESTI VINCERE TU

La tua opinione ci aiuterà a migliorare la creazione futura di questa linea di prodotti.

Visita:

PUEDES GANAR

Tu opinión contribuirá al futuro de esta serie de productos.

Visita:

轻松获奖

您的反馈将有助于我们在今后改进本产品系列。

请访问:

[LEGO.com/productfeedback](https://www.lego.com/productfeedback)

You also have the chance to win a LEGO® set.

Terms and conditions apply.*

Außerdem hast du die Chance, ein LEGO® Set zu gewinnen.

Es gelten die Teilnahmebedingungen.*

Vous pourriez également gagner un ensemble LEGO®.

Des conditions s'appliquent.*

Hai anche la possibilità di vincere un set LEGO®.

Termini e condizioni sono applicabili.*

También tienes la oportunidad de ganar un set LEGO®.

Aplican términos y condiciones.*

您还有机会赢取乐高®套装。

条款和条件适用。*

*[LEGO.com/productfeedback-terms](https://www.lego.com/productfeedback-terms)



LEGO and the LEGO logo are trademarks of the LEGO Group. ©2025 The LEGO Group.

All HARRY POTTER characters and elements © & ™ Warner Bros. Entertainment Inc.
Publishing Rights © JKR. (s25)