



21062





LEGO.com/sustainable-packaging



FR  
**DONNEZ  
OU  
RECYCLEZ**



ASSOCIATION

OU



MAGASIN

OU



DÉCHÈTERIE

Adresses sur [quefairedemesdechets.fr](http://quefairedemesdechets.fr)



# BUILDER



Apple and the Apple logo are trademarks of Apple Inc., registered in the U.S. and other countries and regions. App Store is a service mark of Apple Inc. Google Play and the Google Play logo are trademarks of Google LLC. Tencent and the Tencent logo are trademarks of Tencent Inc.

LEGO.com/devicecheck



LEGO® Builder



# 罗马情缘/ 罗马许愿池

自 1762 年竣工以来，罗马许愿池 (Trevi Fountain) 以其现在的形式承载了几个世纪的深厚罗马历史和建筑传承。喷泉所在地长期以来为这座城市的发展和繁荣发挥着重要的作用。自公元前 19 年以来，它的天然泉水一直流经罗马最古老的渡槽之一：少女水道 (Acqua Vergine)。

这座喷泉是一件令人叹为观止的巴洛克艺术作品，通过大量的雕塑及对古代神灵、罗马传奇人物和大自然的富足的象征性致敬，体现了罗马人的智慧。它的名字源自 *tre vie* (三岔路)，突出了它位于三条古老街道交汇处的重要交通位置，它曾经用来引导朝圣者和市民，现在每年接待约 1000 万游客。

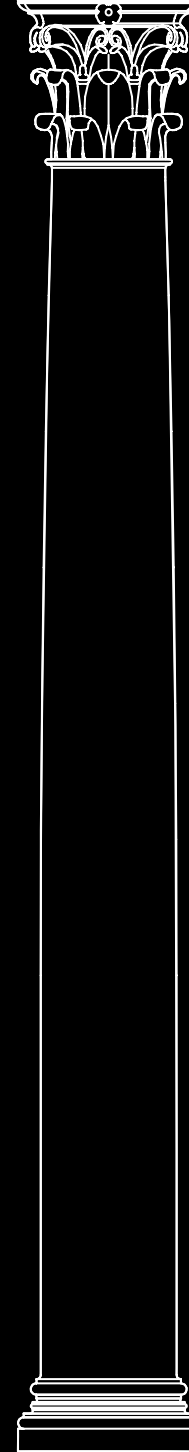

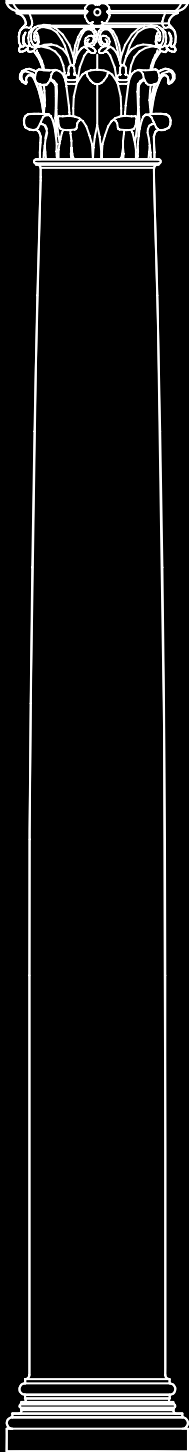

## 乐高®建筑设计团队寄语

罗马许愿池不仅仅是一件视觉艺术瑰宝，作为文化标志，它为无数的艺术作品、文学作品甚至电影带来了灵感。继深受欢迎的 2014 年乐高®建筑罗马许愿池 (21020) 套装之后，该版本以更宏大的比例重现了这座建筑，对真实结构进行了诠释，为了贴合场景，对一些细节进行了抽象处理。

我们的主要目标是捕捉夏日罗马的巴洛克风格和氛围，罗马许愿池周围色彩鲜艳的建筑物在广场上反射出温暖的光线。立面内部的深度对自身和水池投下阴影，为表面的颜色带来微妙的变化。我们采用了粉红色、棕褐色、灰色和白色色调，希望捕捉建筑、雕像、水和岩石中这些错综复杂的细微差别的精髓。



**Mary Wilson**  
乐高 建筑设计师





## AGRIPPA

展现了罗马将军兼建筑师 Marcus Vipsanius Agrippa  
(公元前 63-12 年) 批准渡槽建造计划的情景。



## 少女

向在几千年前为罗马士兵指出泉水位置的  
年轻女孩(根据神话)致敬。



## 健康女神

健康女神手拿水碗, 让蛇  
畅饮, 象征着水的纯洁和  
治愈能力。



## 富足女神

富足女神用大罐子往出倒水, 象征着从渡槽流出  
的水以及它带来的肥沃土地。



## 特里同

神话中的半人半鱼海洋生物。  
一个在努力控制狂野的海马(大海的汹涌),  
另一个牵引温顺的海马(罗马人控制的水域)。



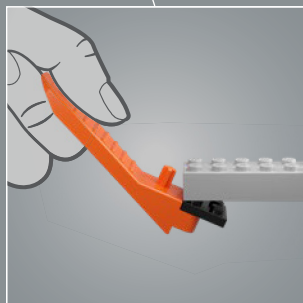
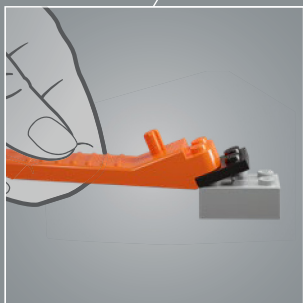
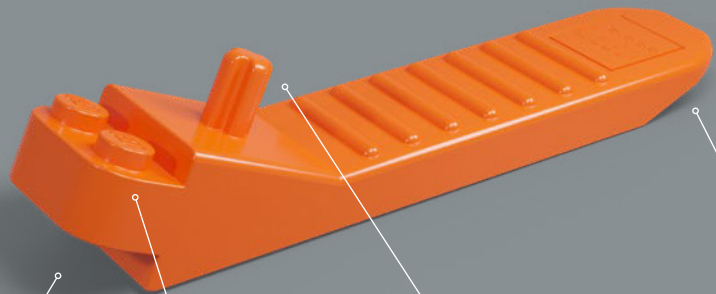



罗马许愿池由 Nicola Salvi 设计, Salvi 的好友——雕塑家 Pietro Bracci 修建, 历时 30 年建成。到 1762 年喷泉竣工时, Salvi 已去世 11 年。

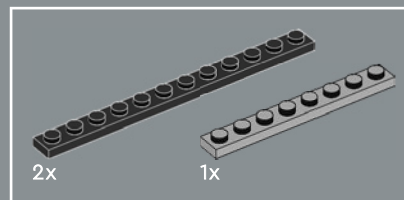

1

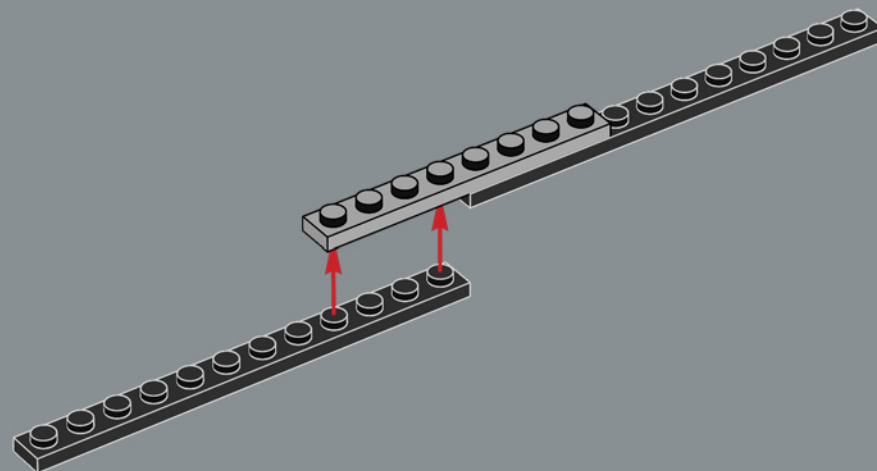

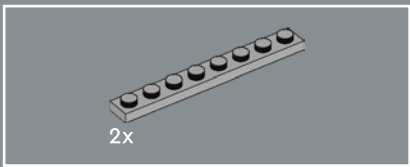

2

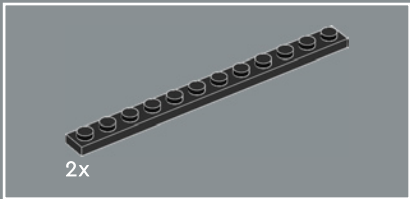
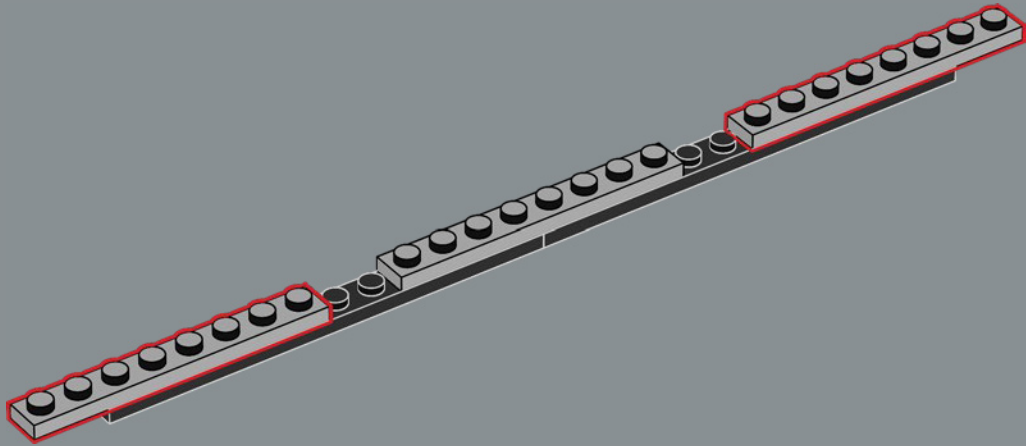

3

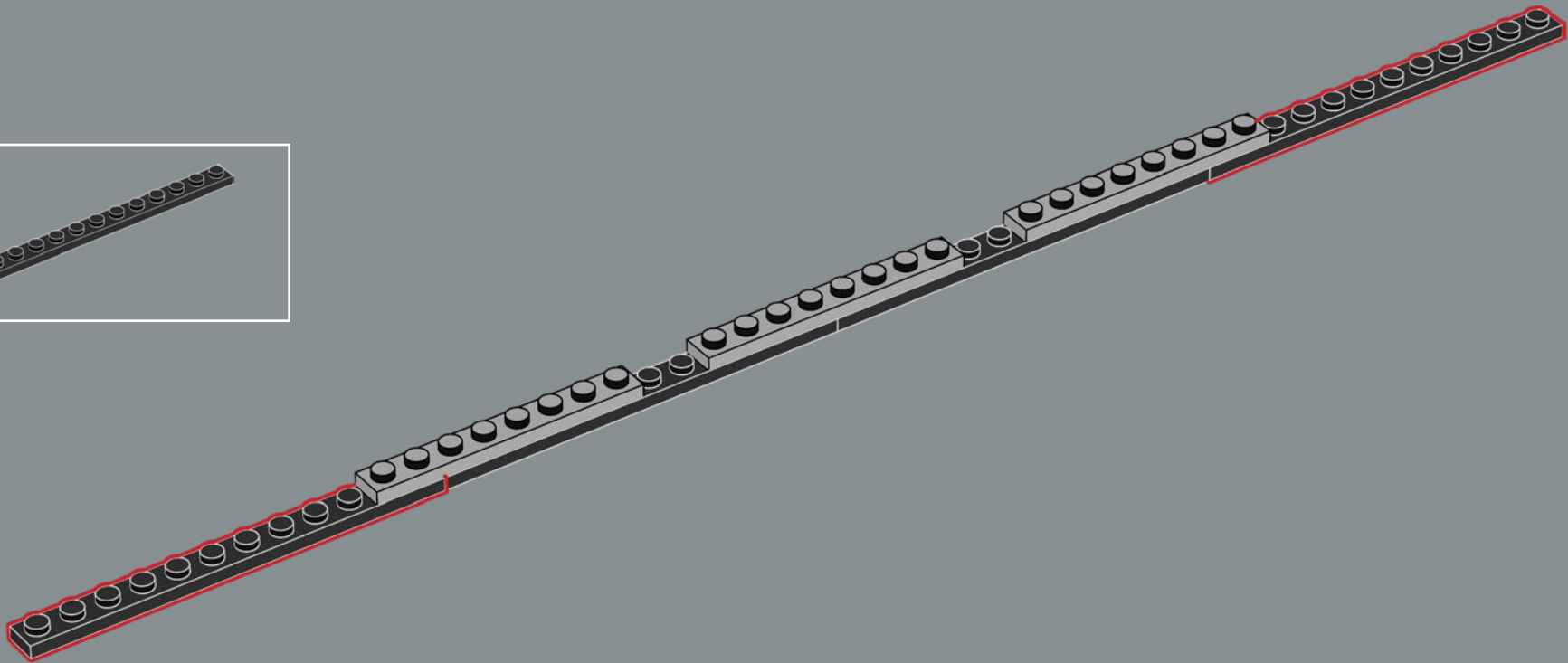

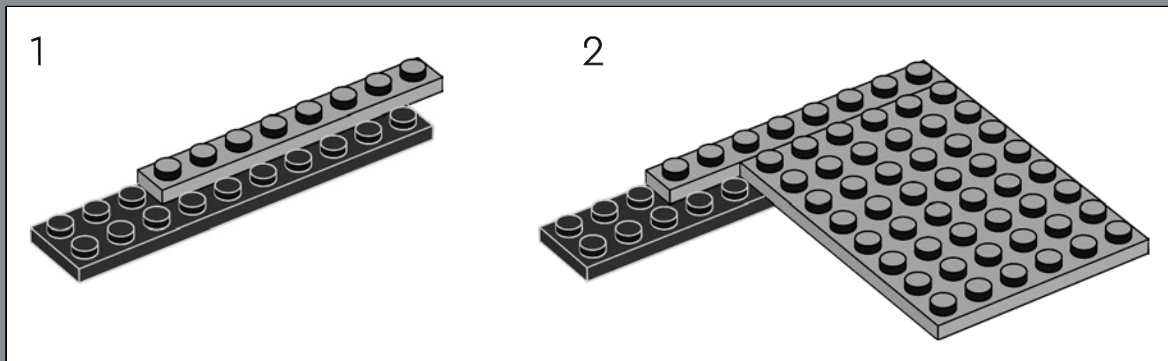
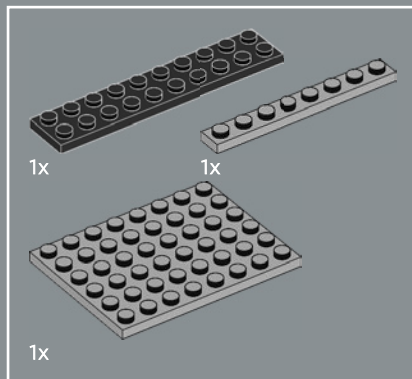

4

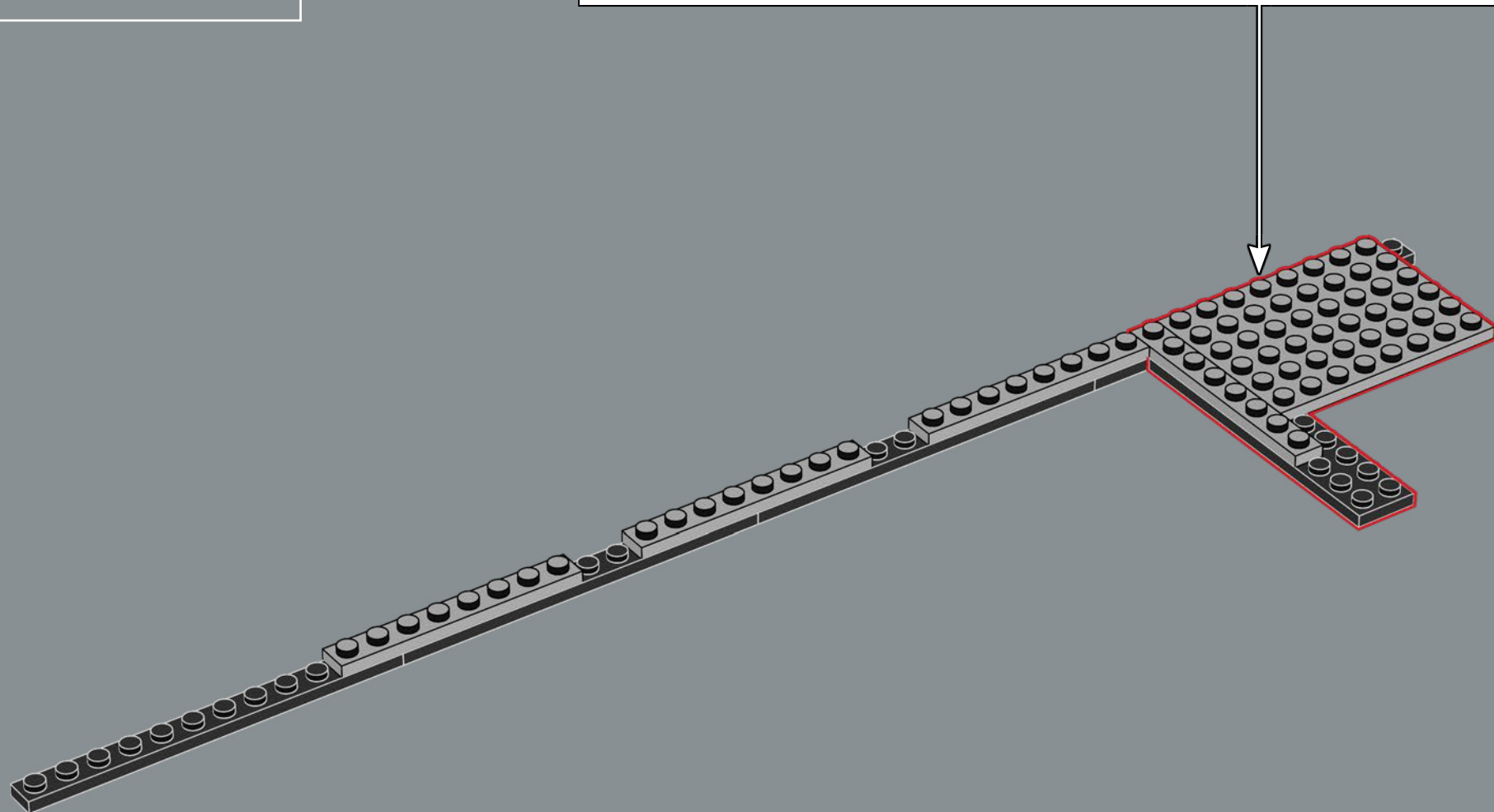

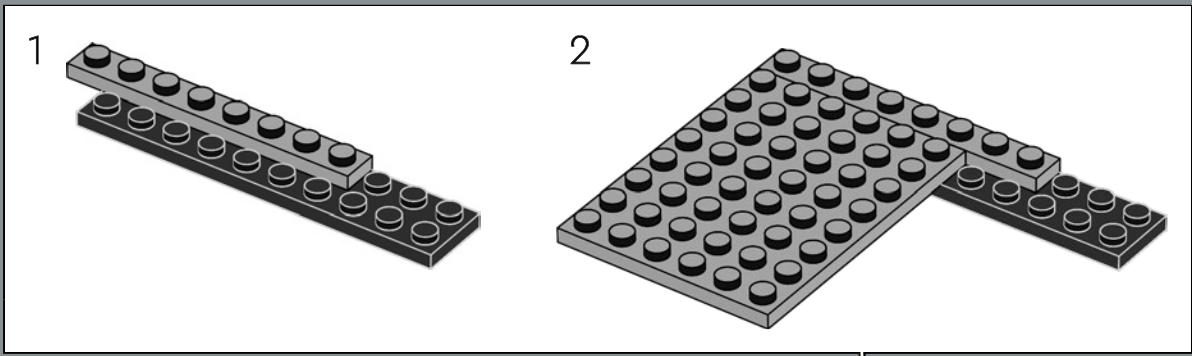
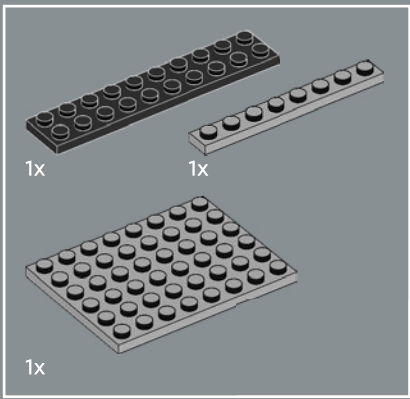

5

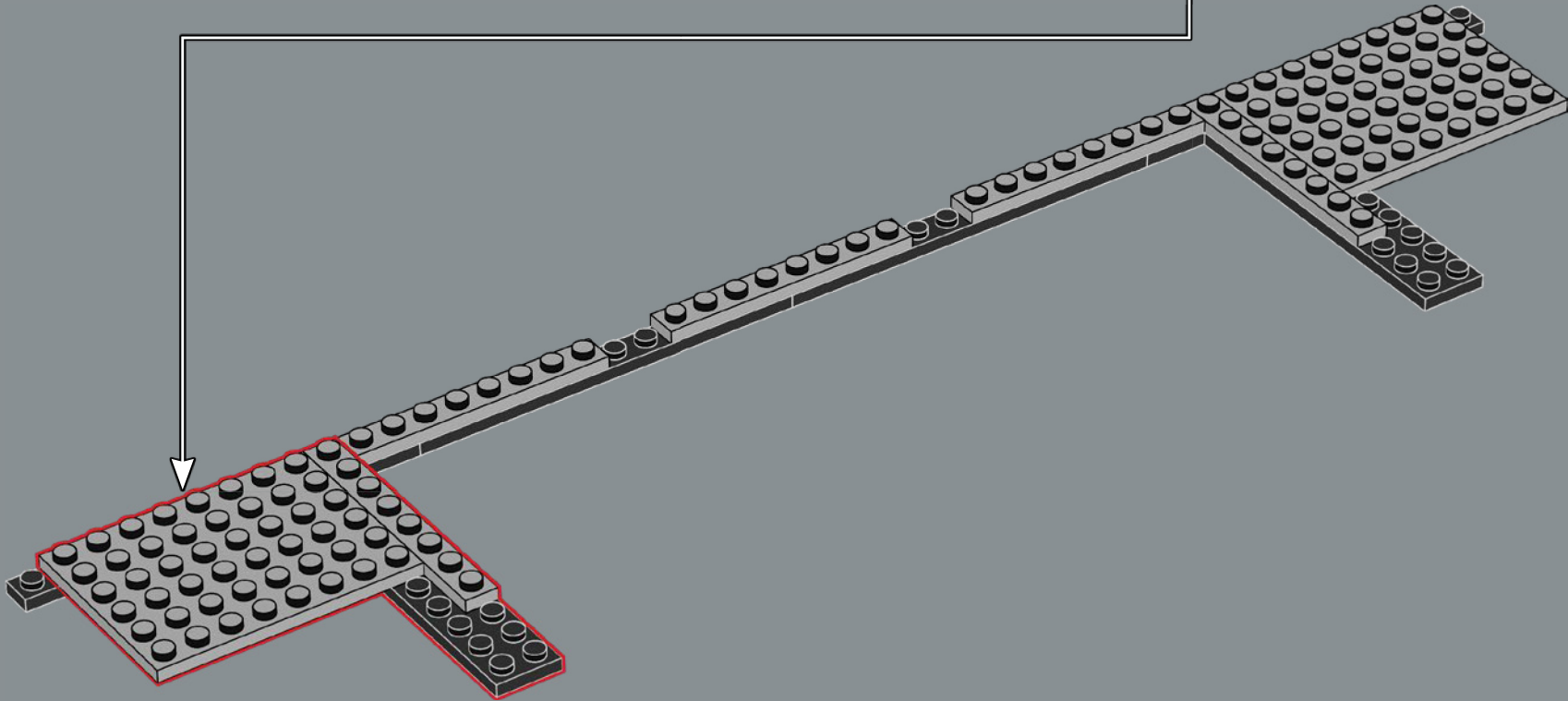

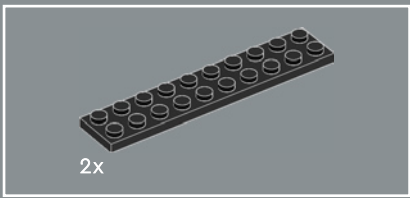

6

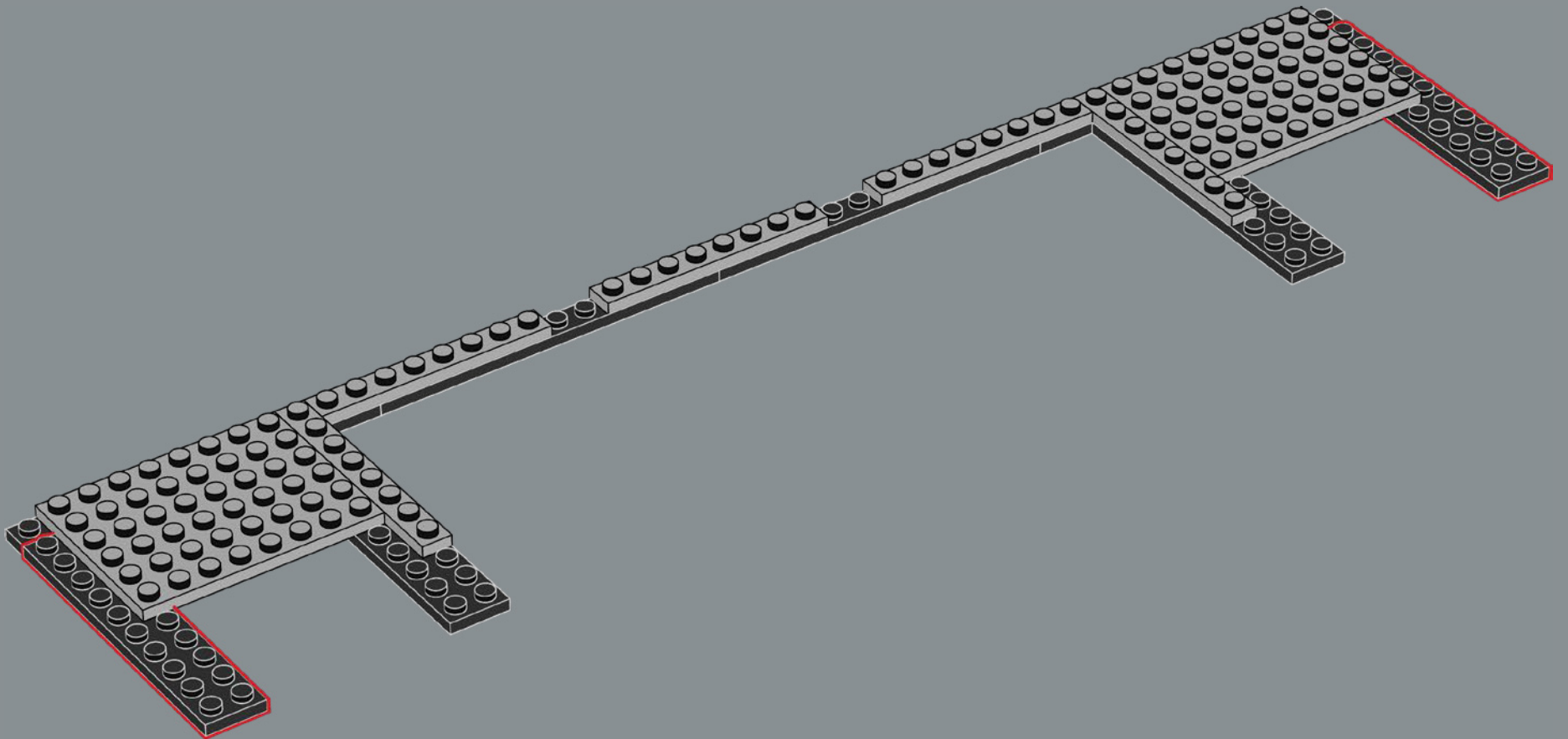

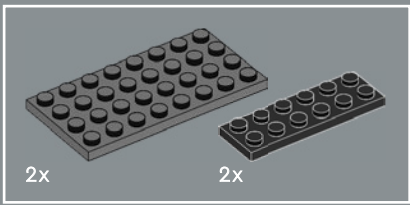

7

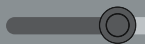
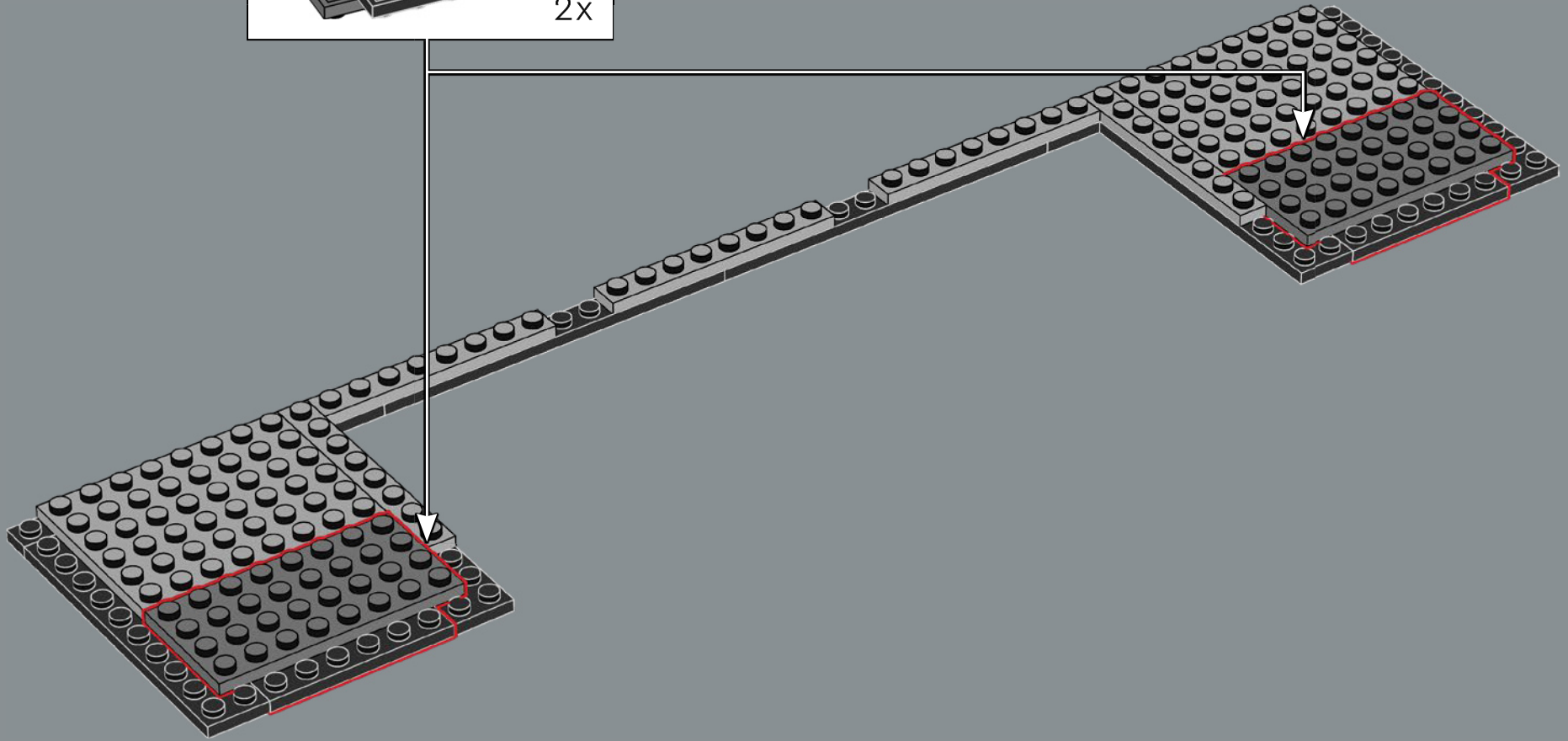
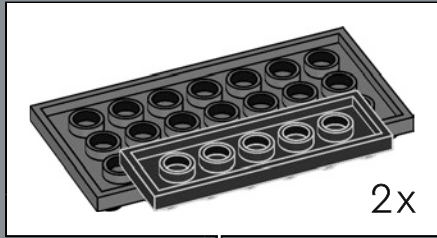



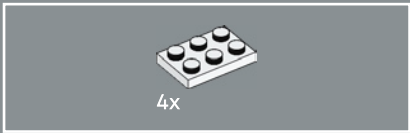

8

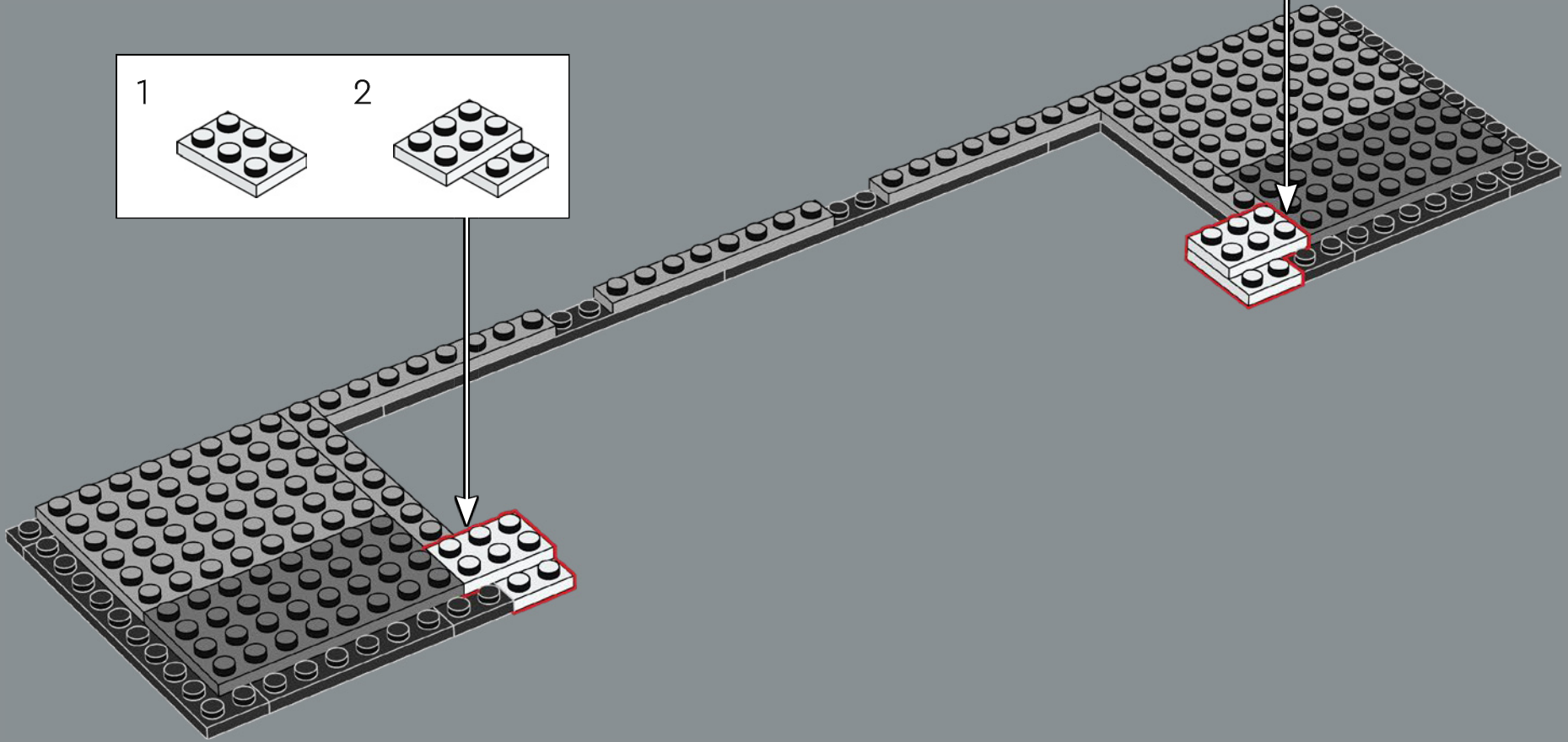
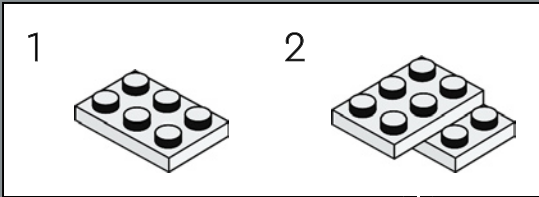
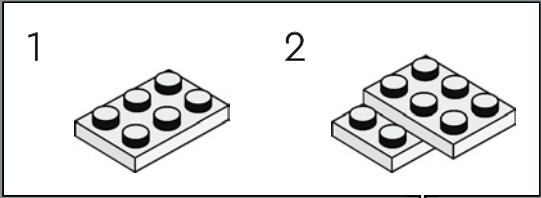

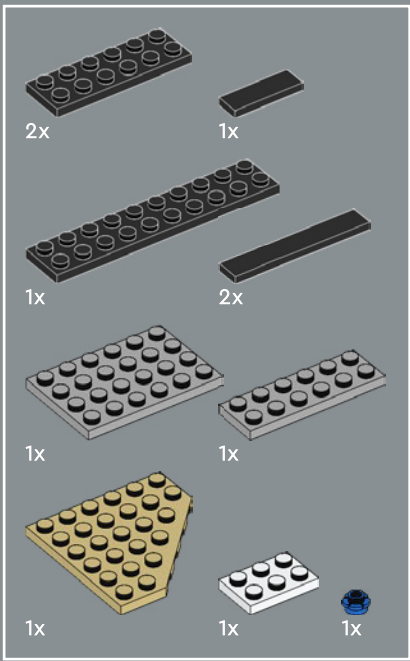

9

1

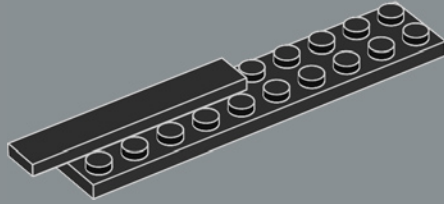

2

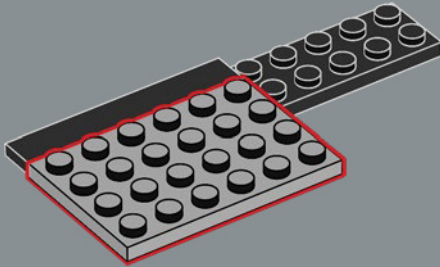

3

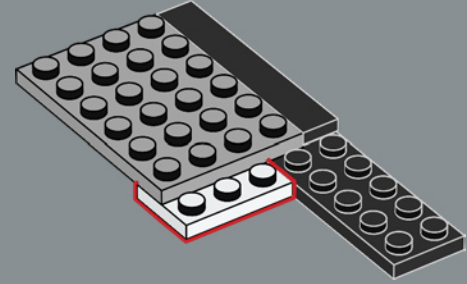

4

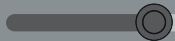
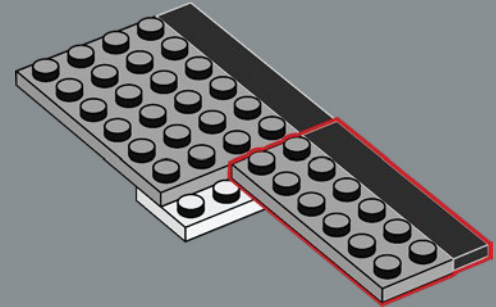

5

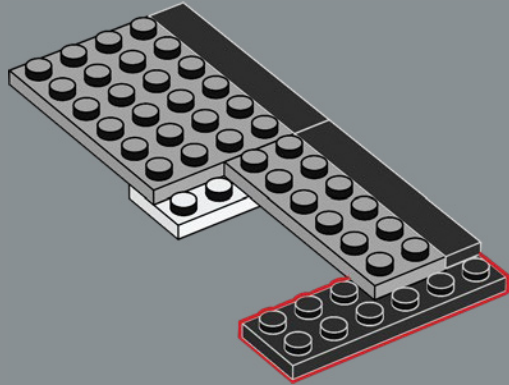

6

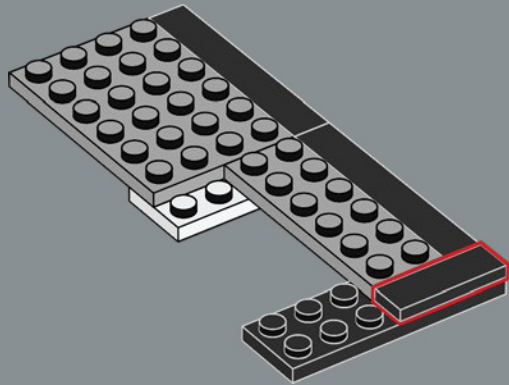

7

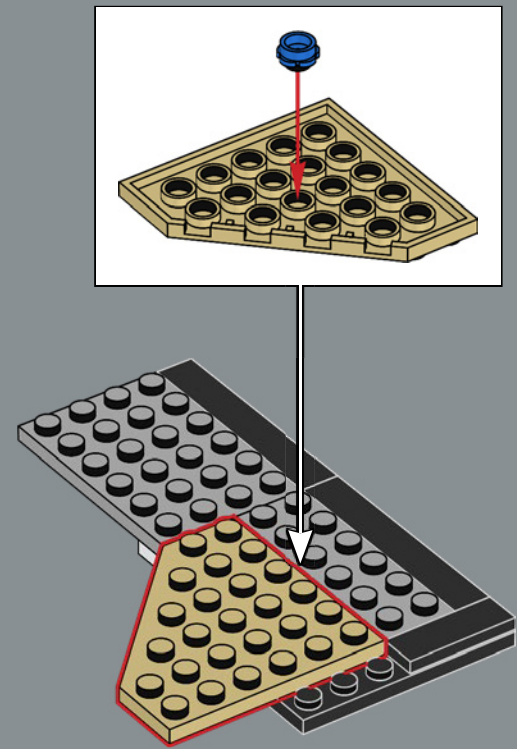

8

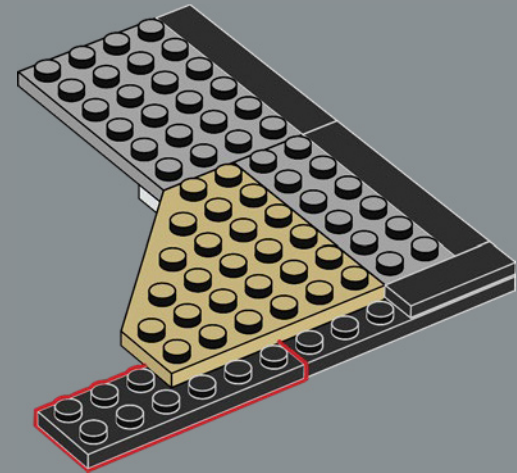

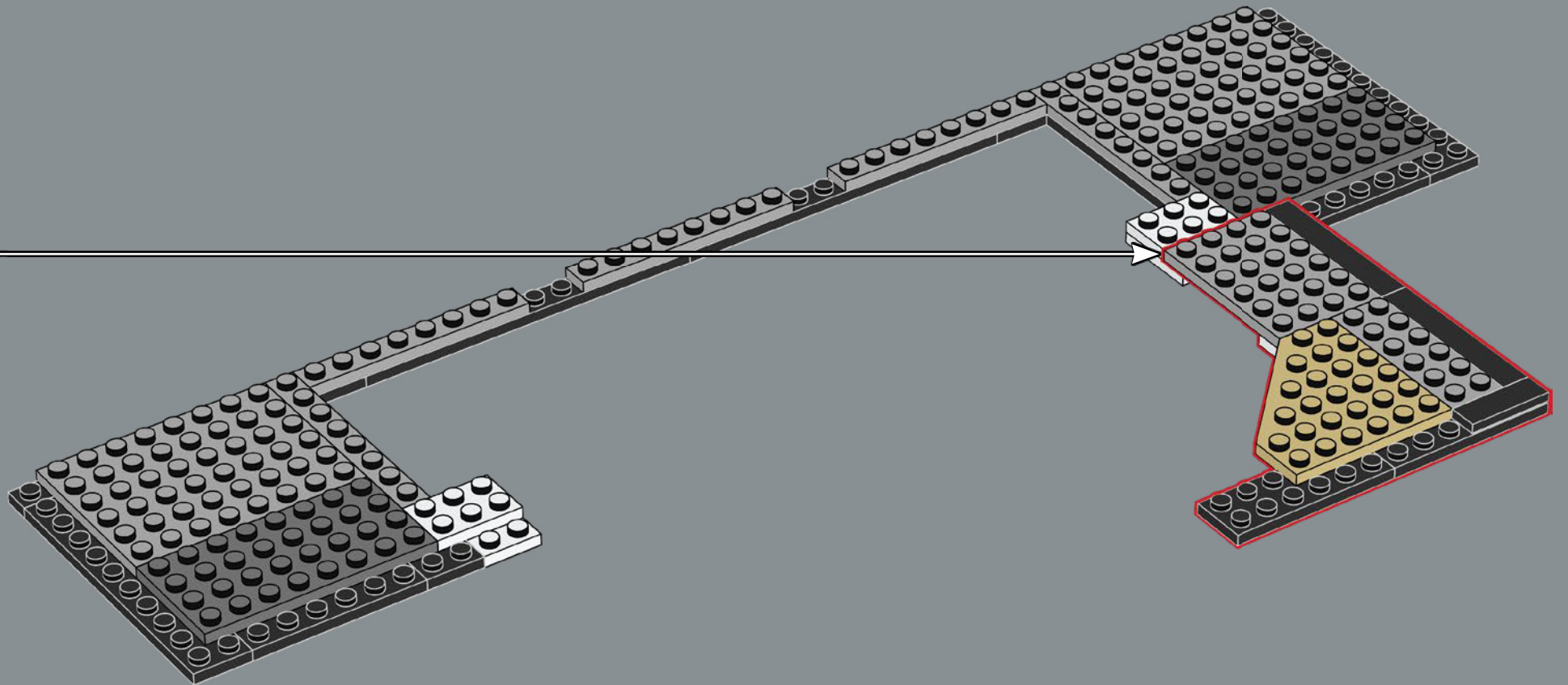

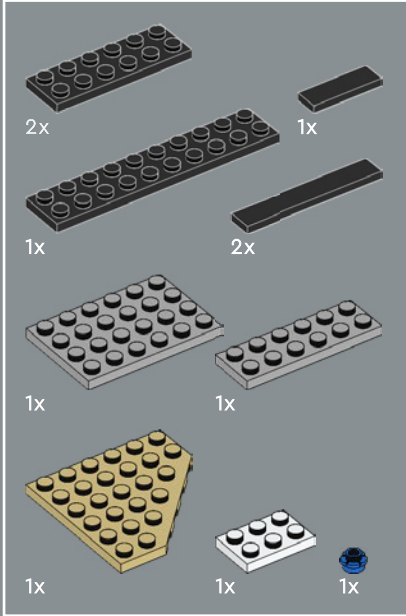
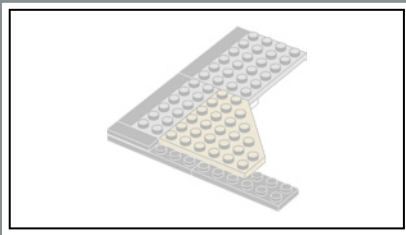

10

1

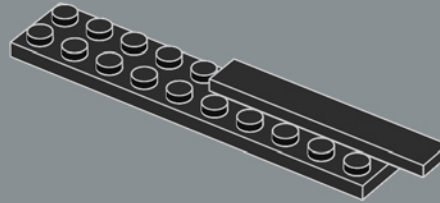

2

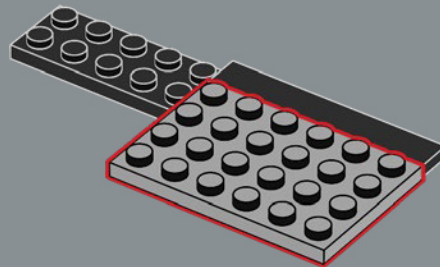

3

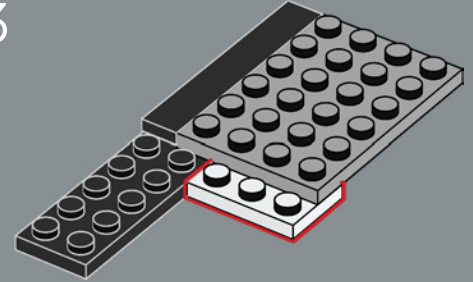

4

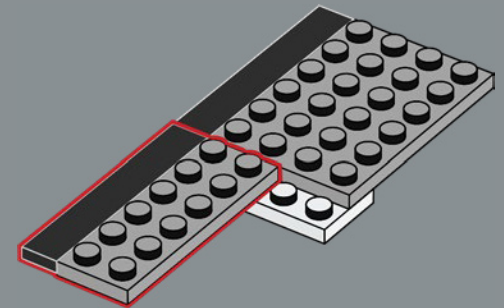

5

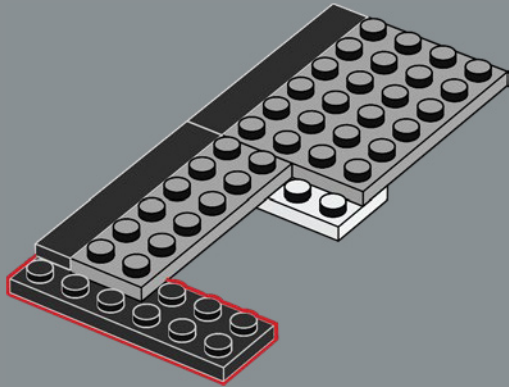

6

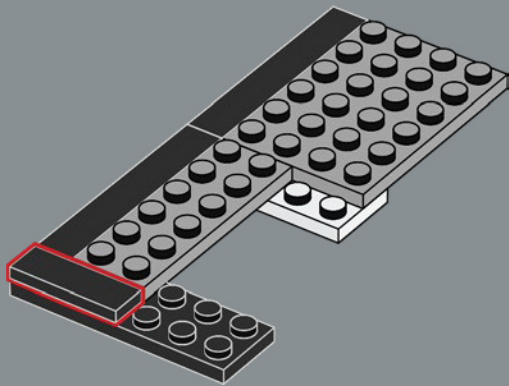

7

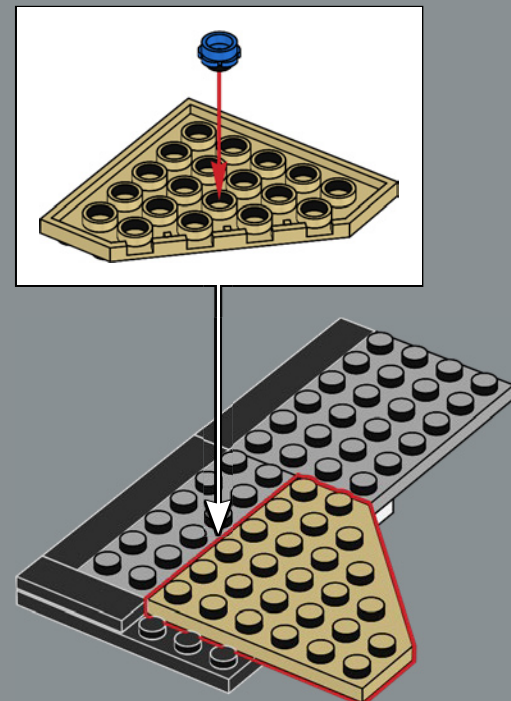

8

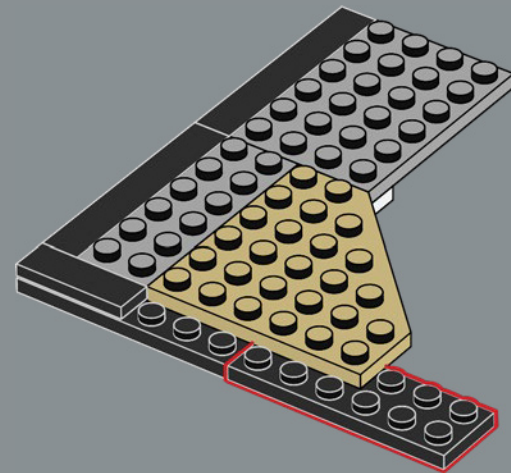

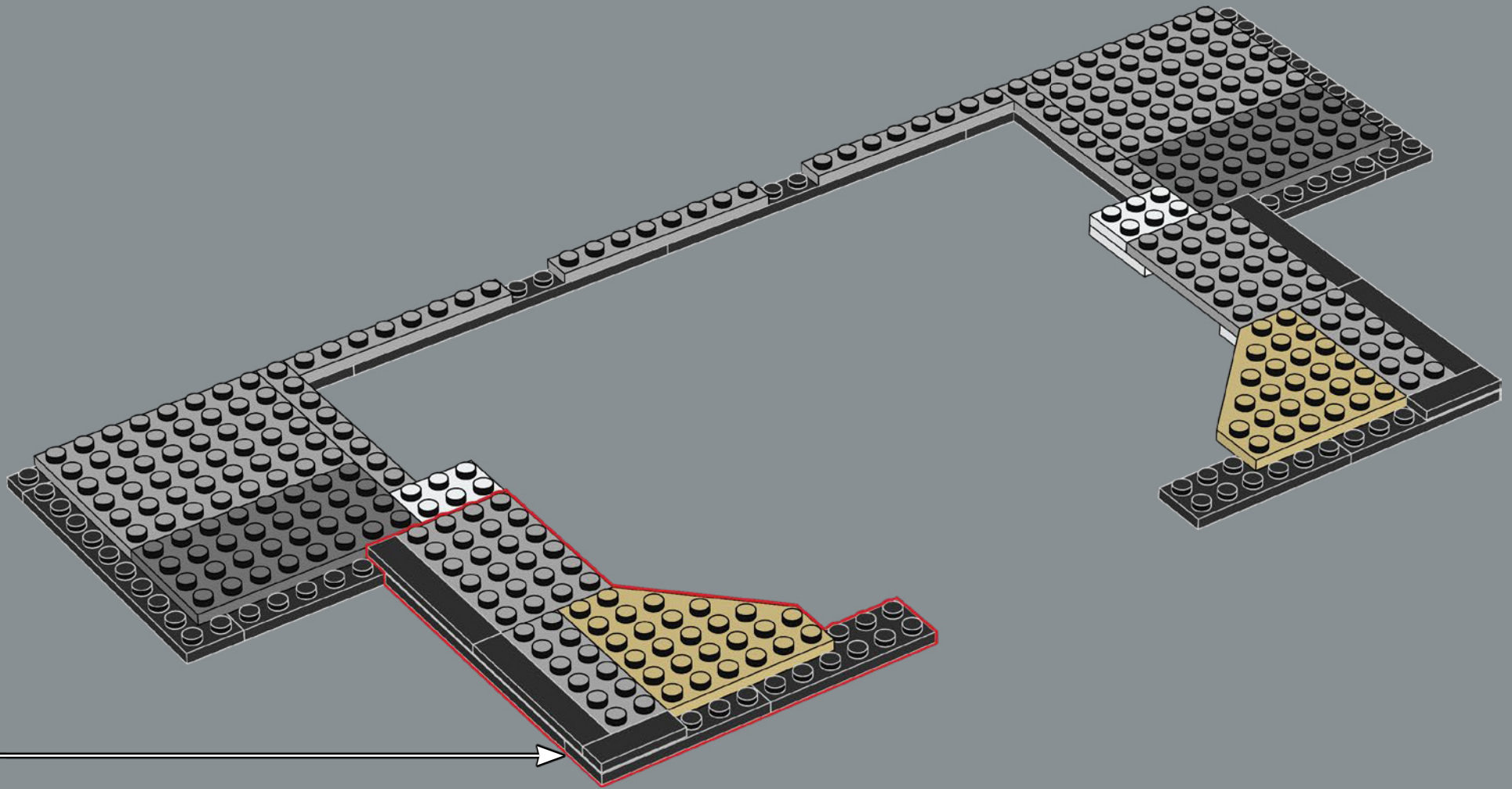

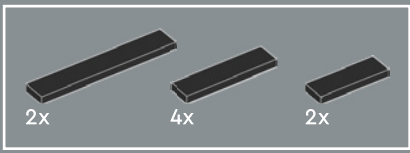

11

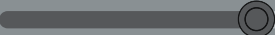
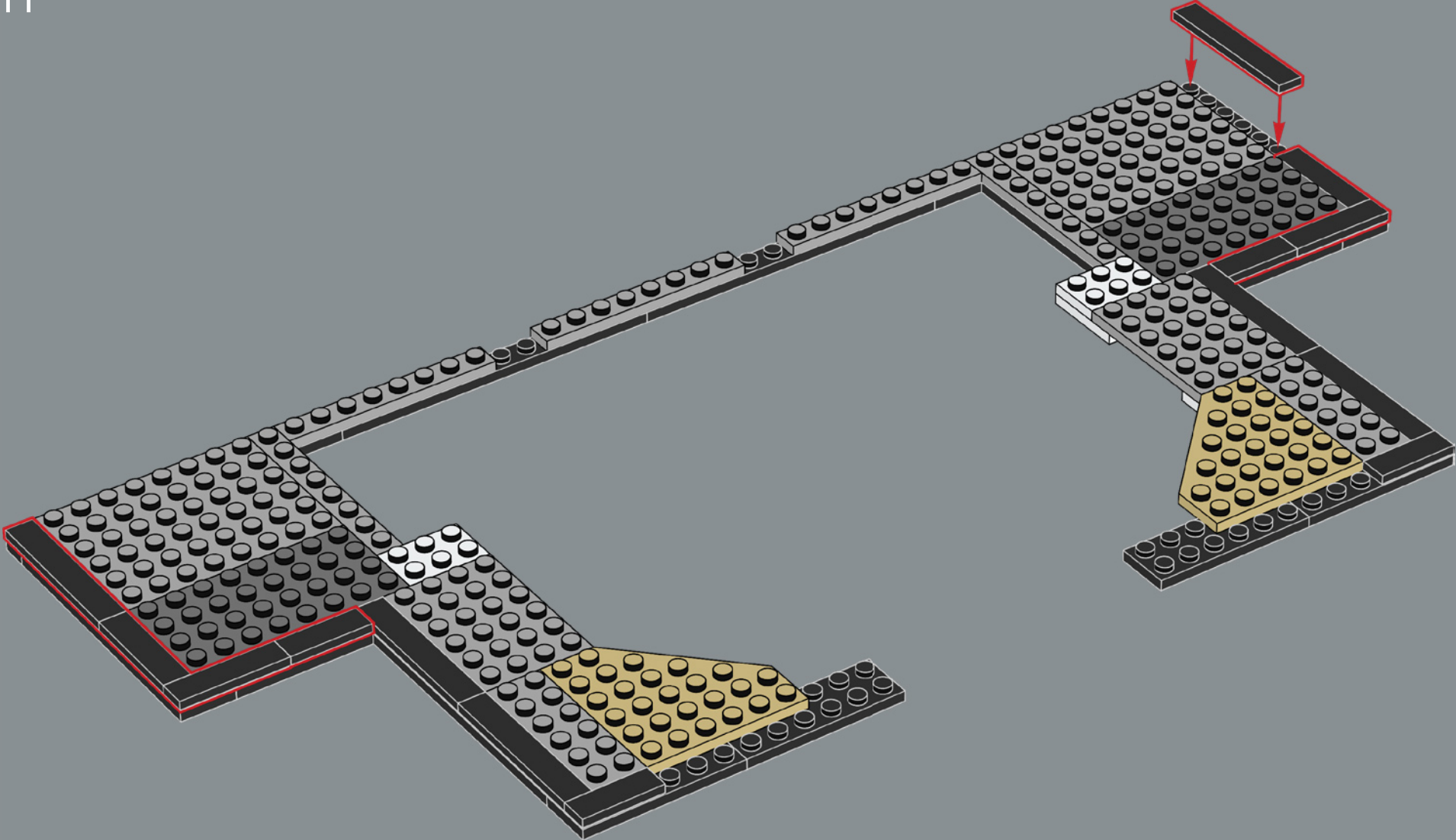



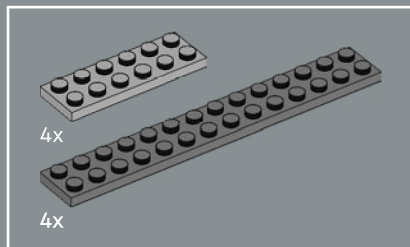

12

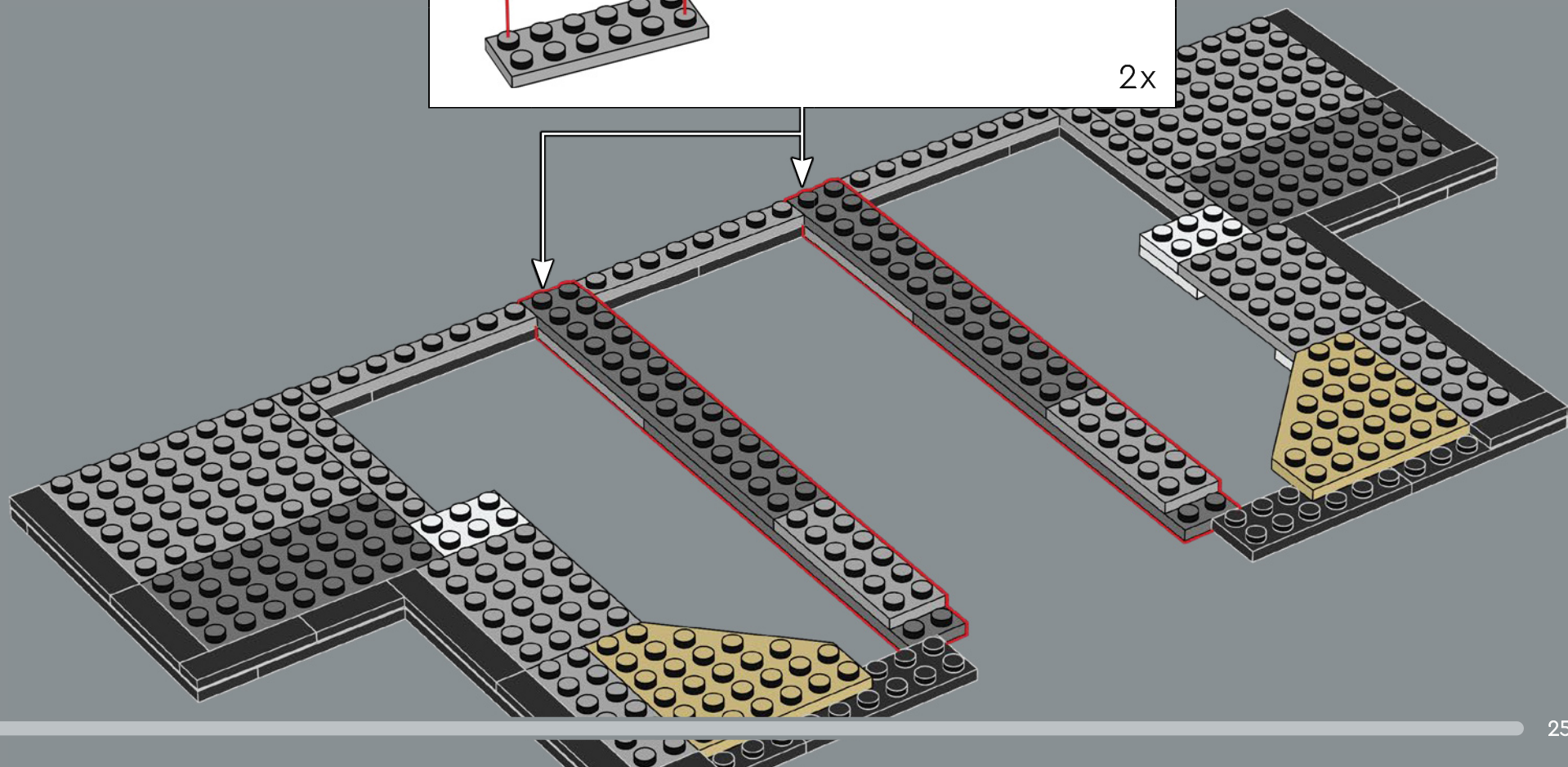
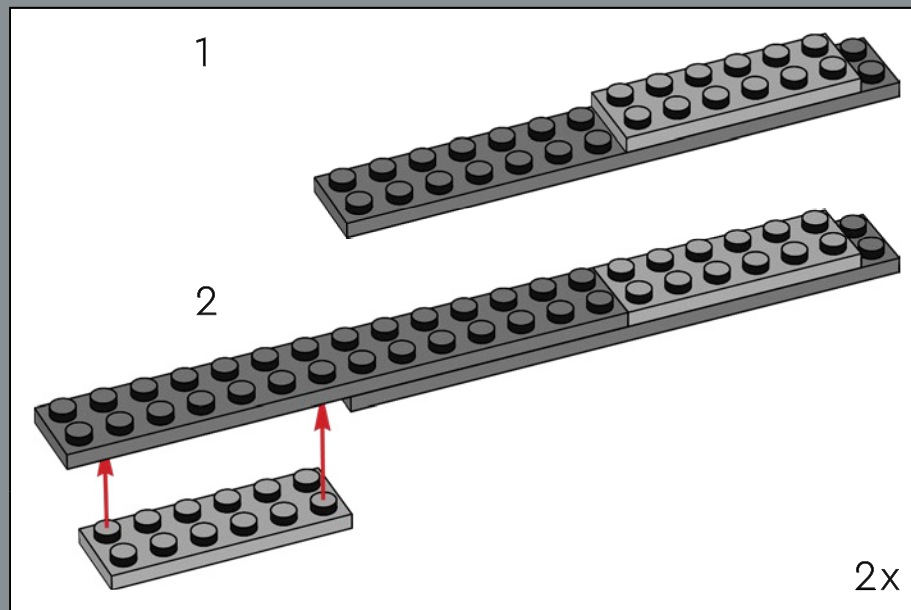

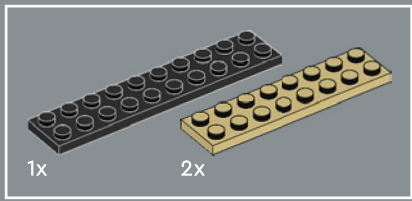

13

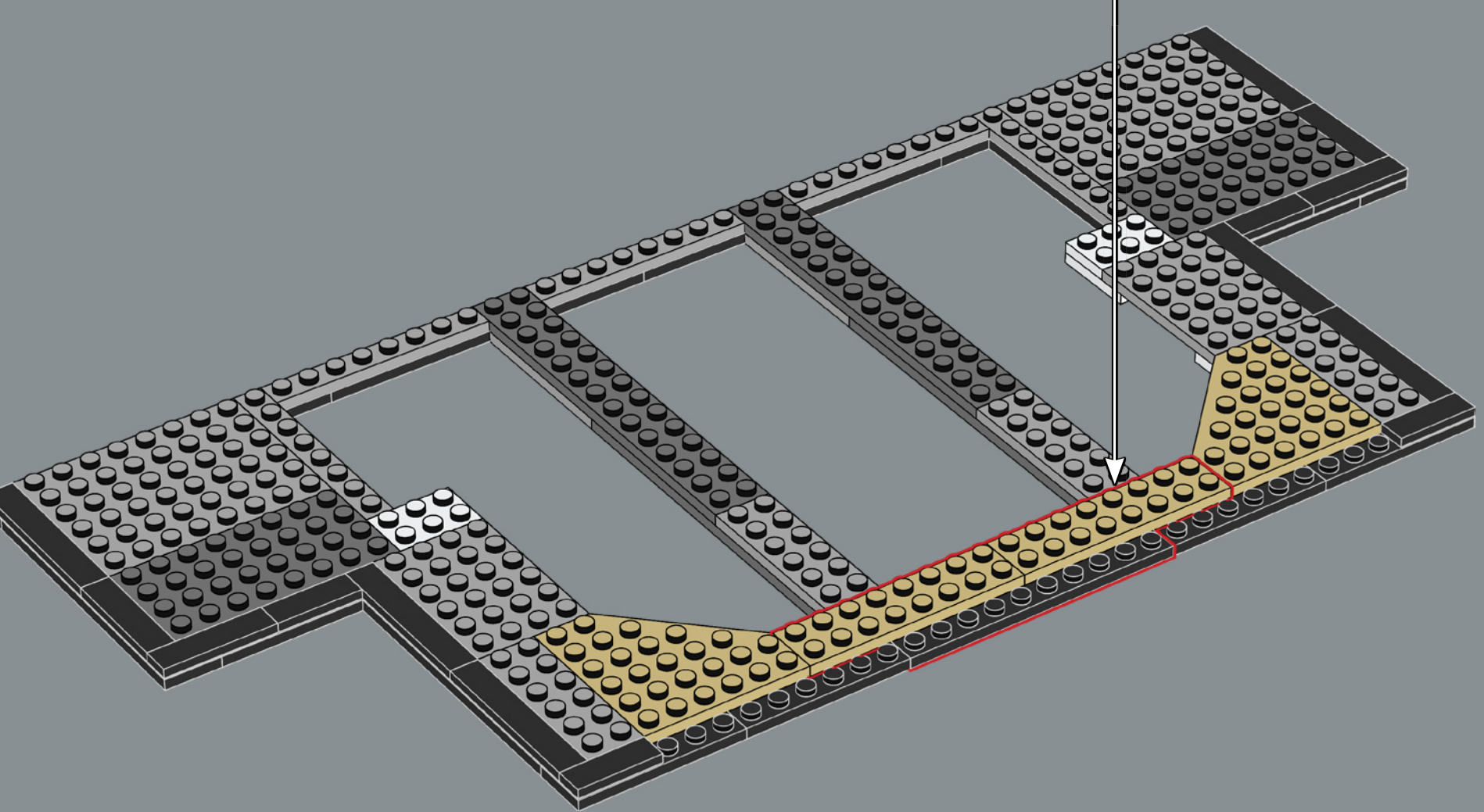
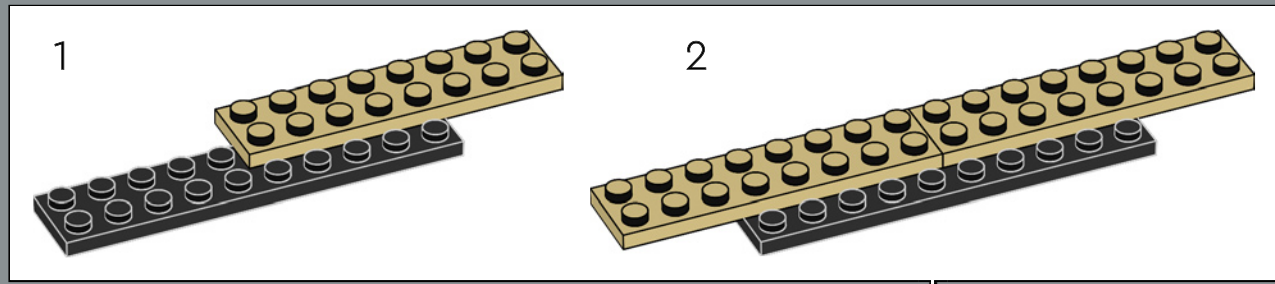

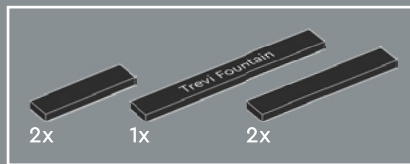

几个世纪以来，罗马许愿池 (Trevi Fountain) 名称由来的“三条道路”不断扩容，现在有五条道路通向这座著名的广场。

14

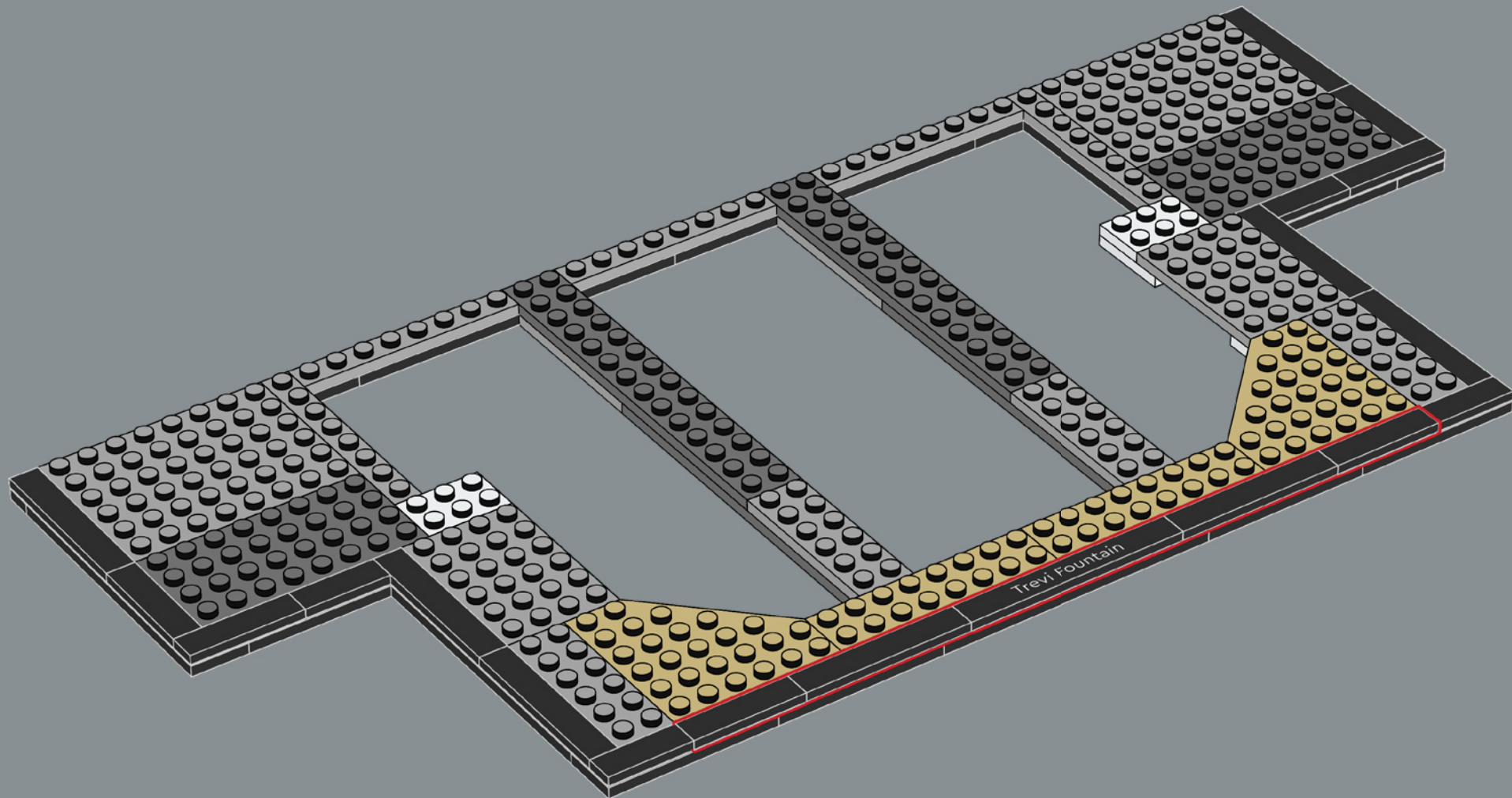

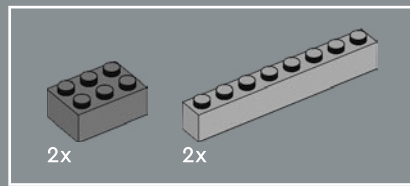

15

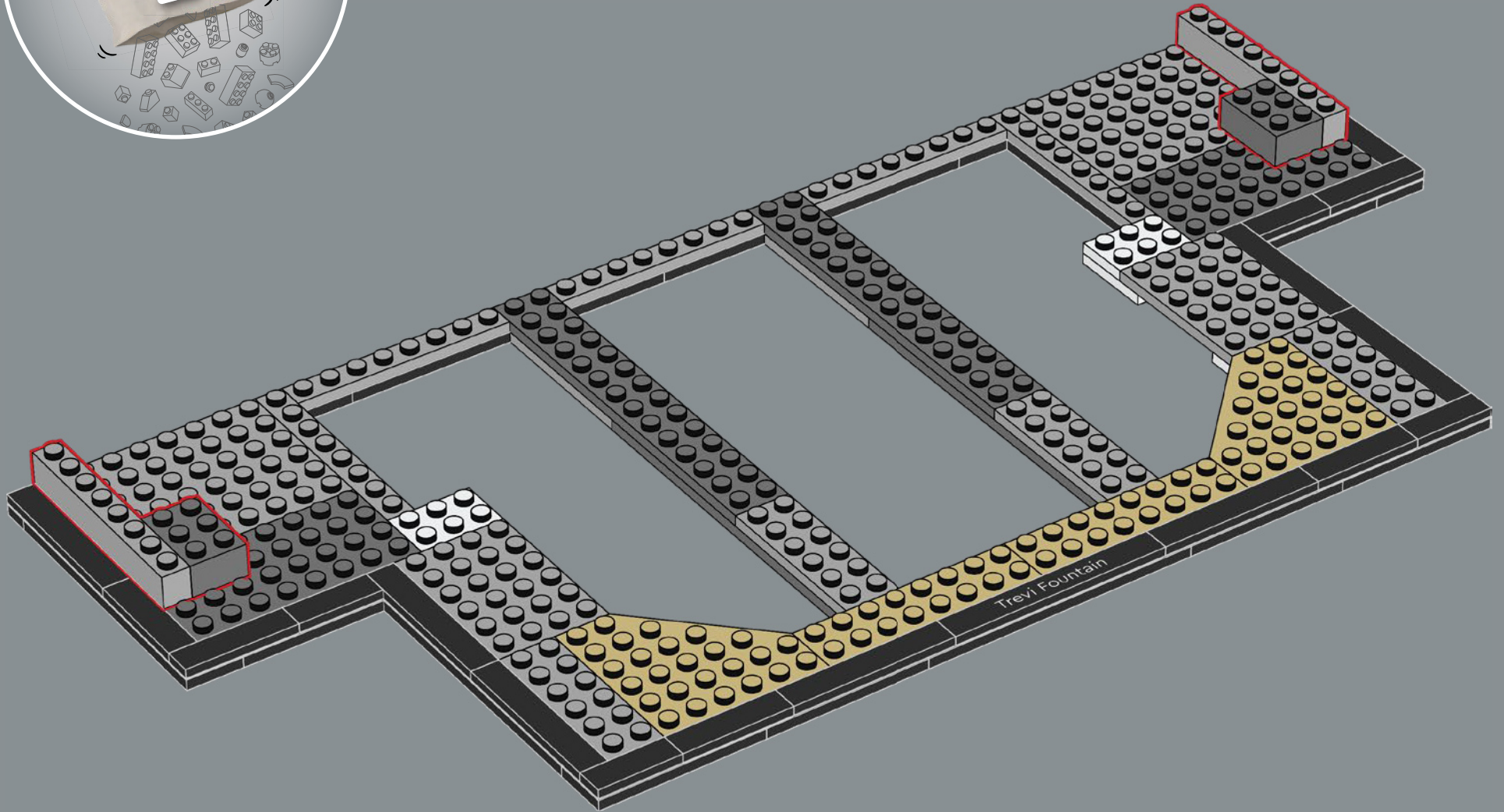

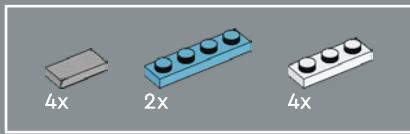

16

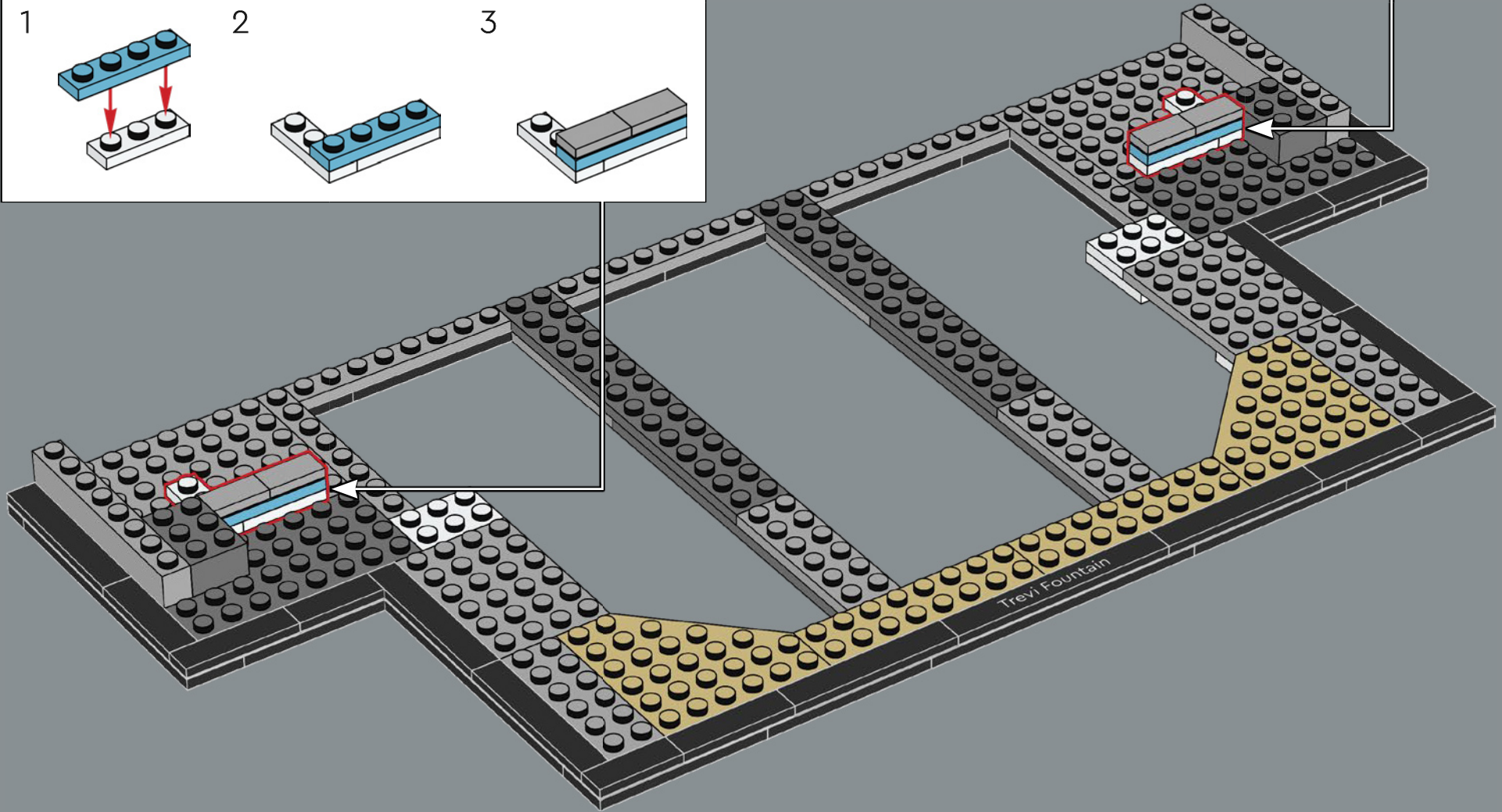
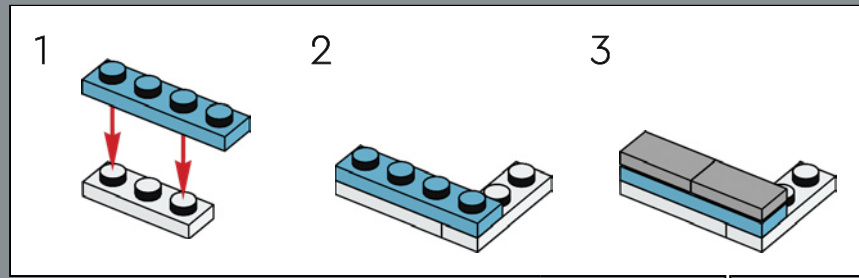
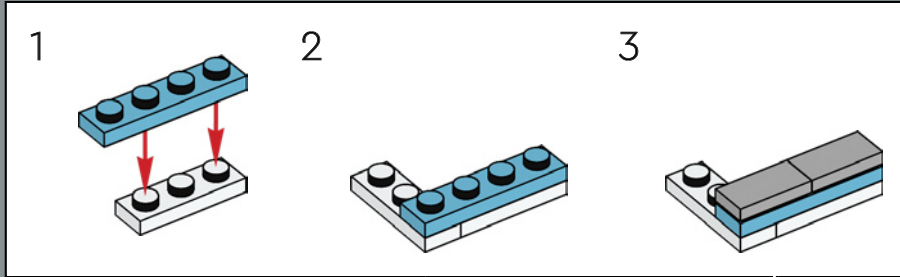

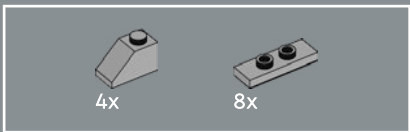

17

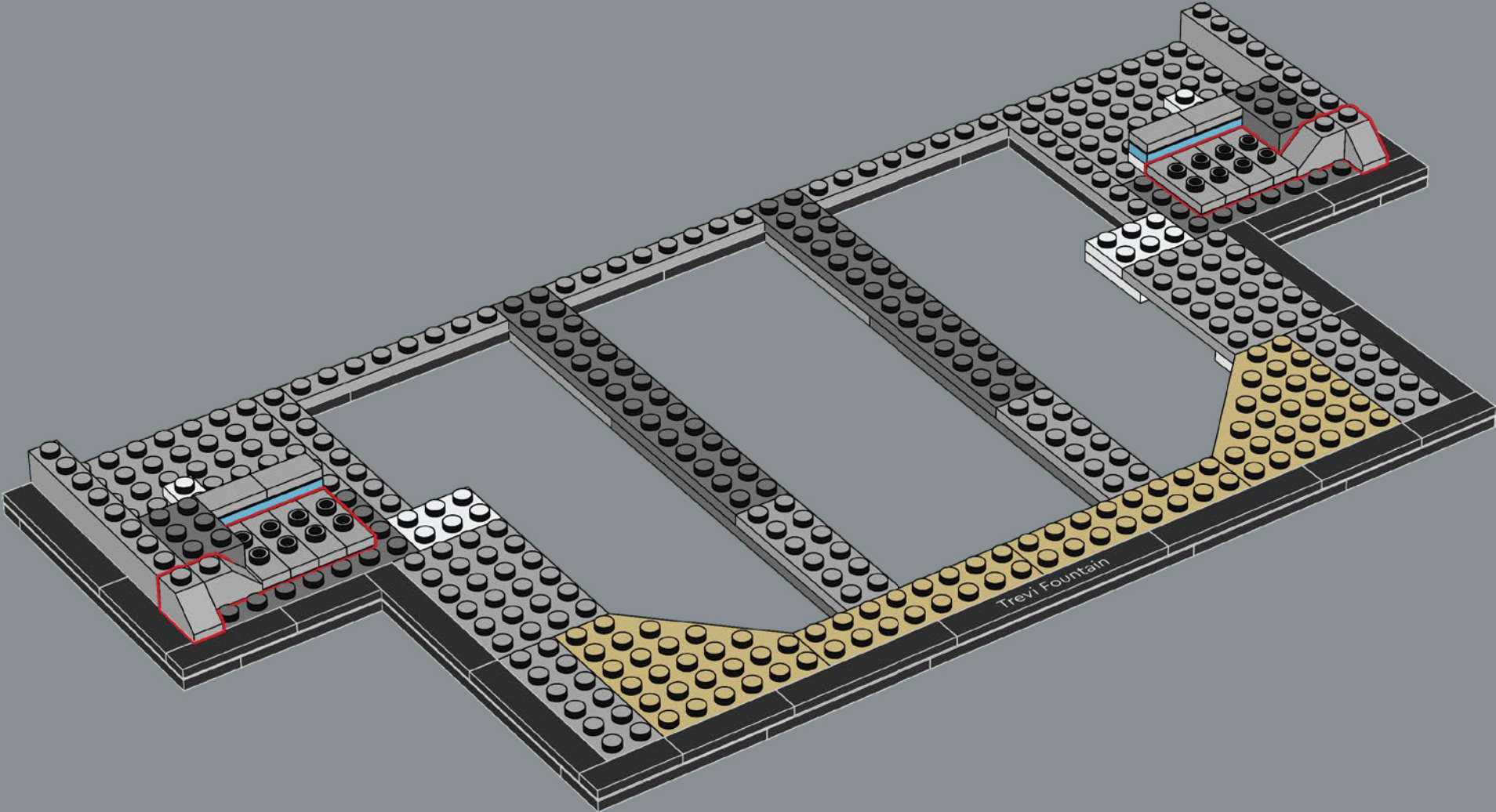

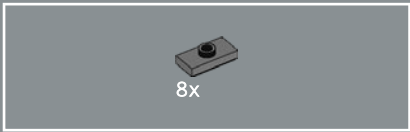

18

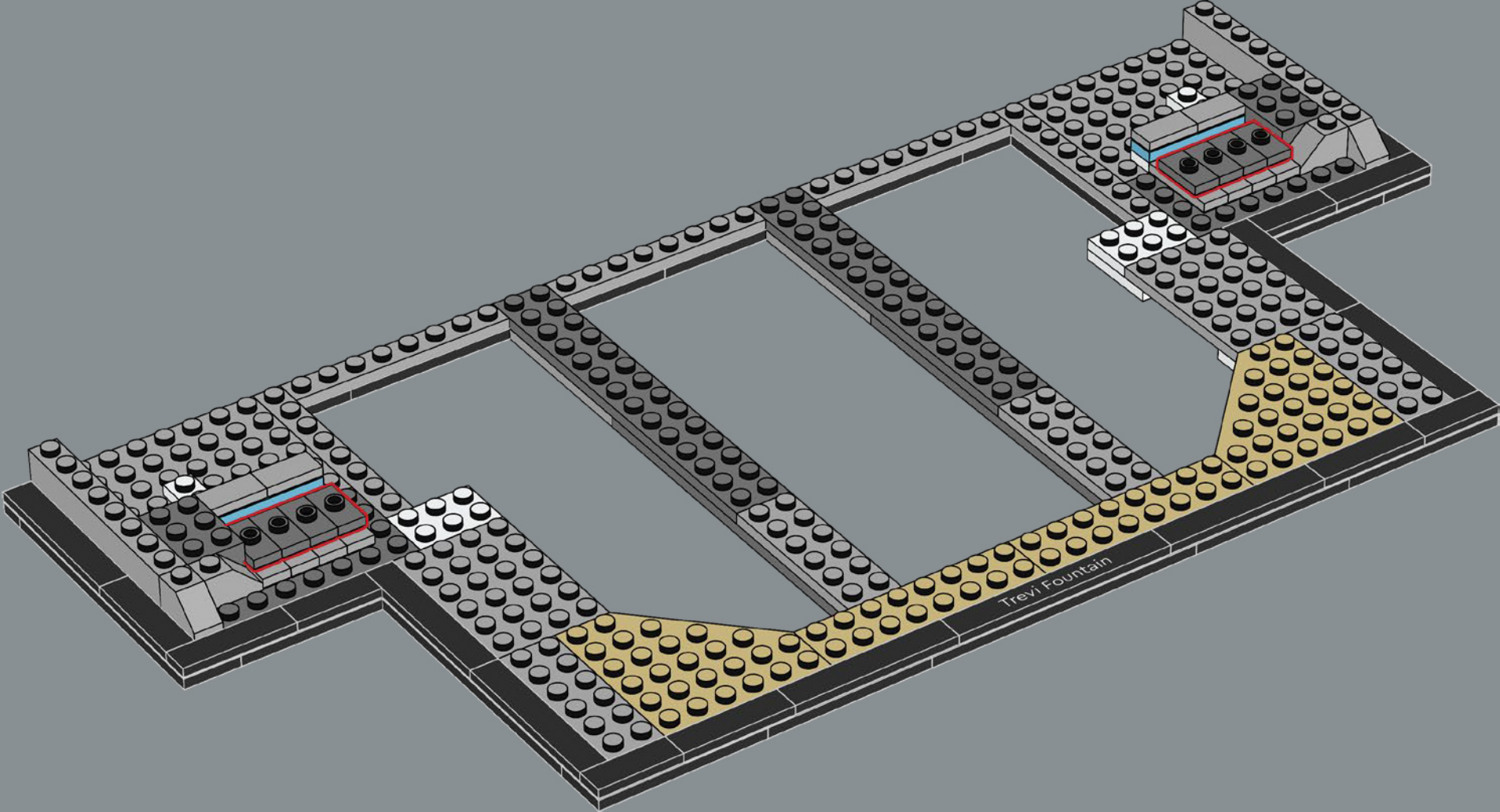



8x

19

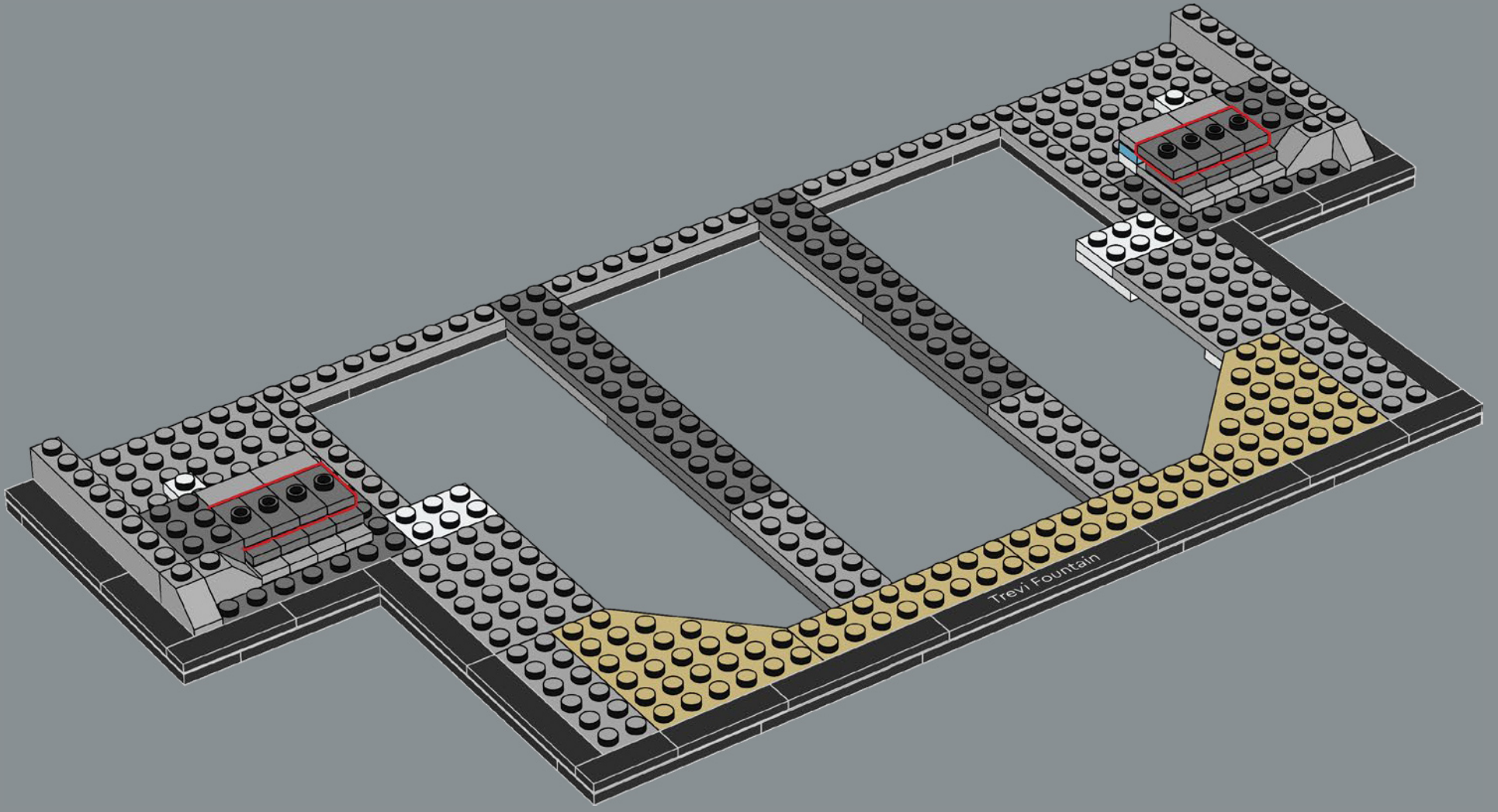



由于前往这座历史遗迹的人流量极大,导致人行道、台阶和较低处的岩石逐渐变色。

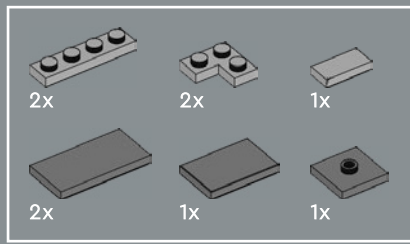

20

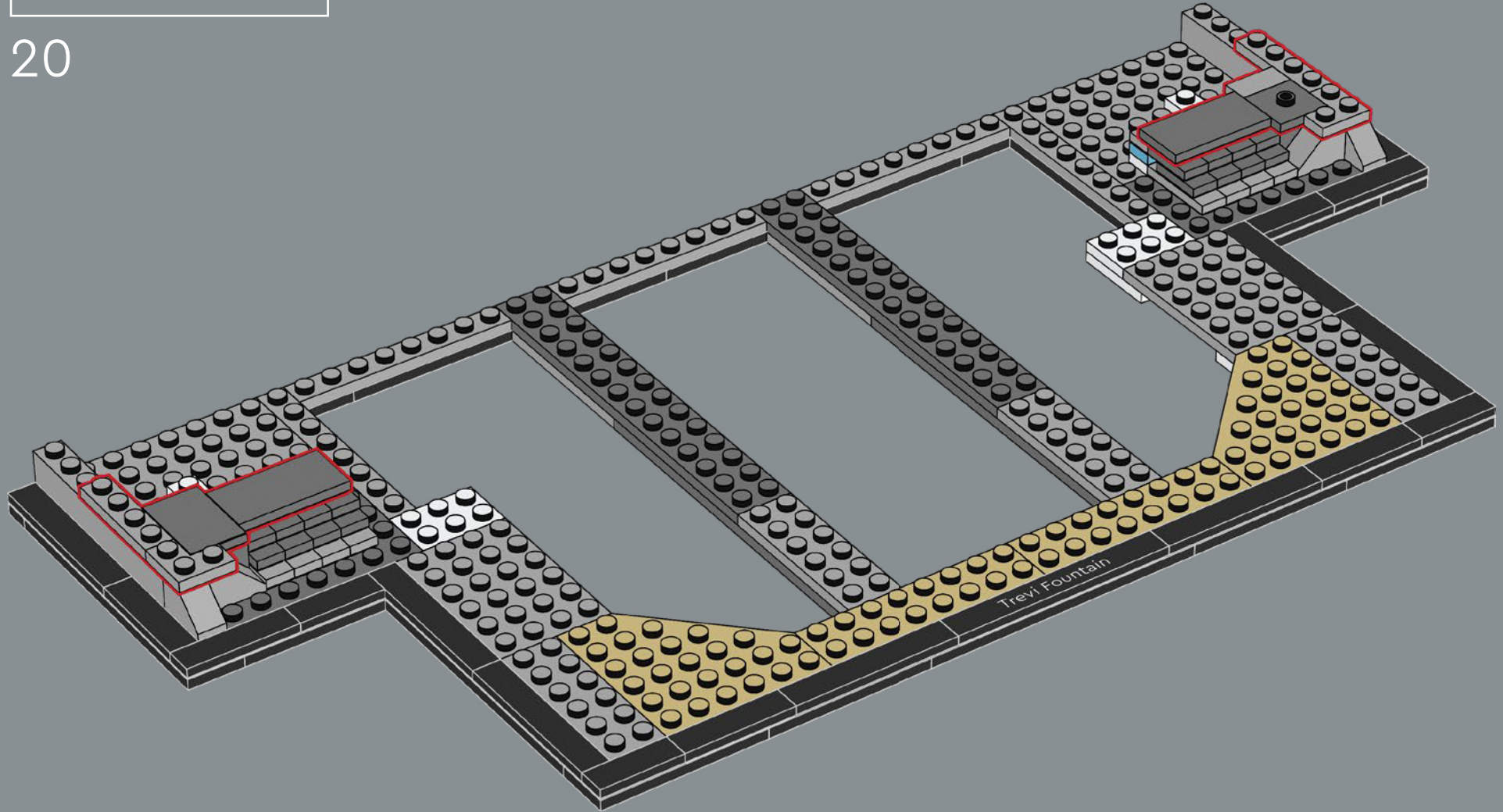

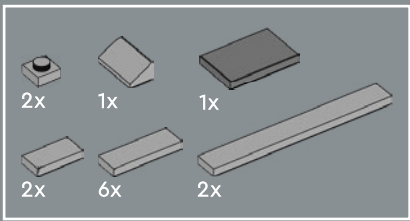

21

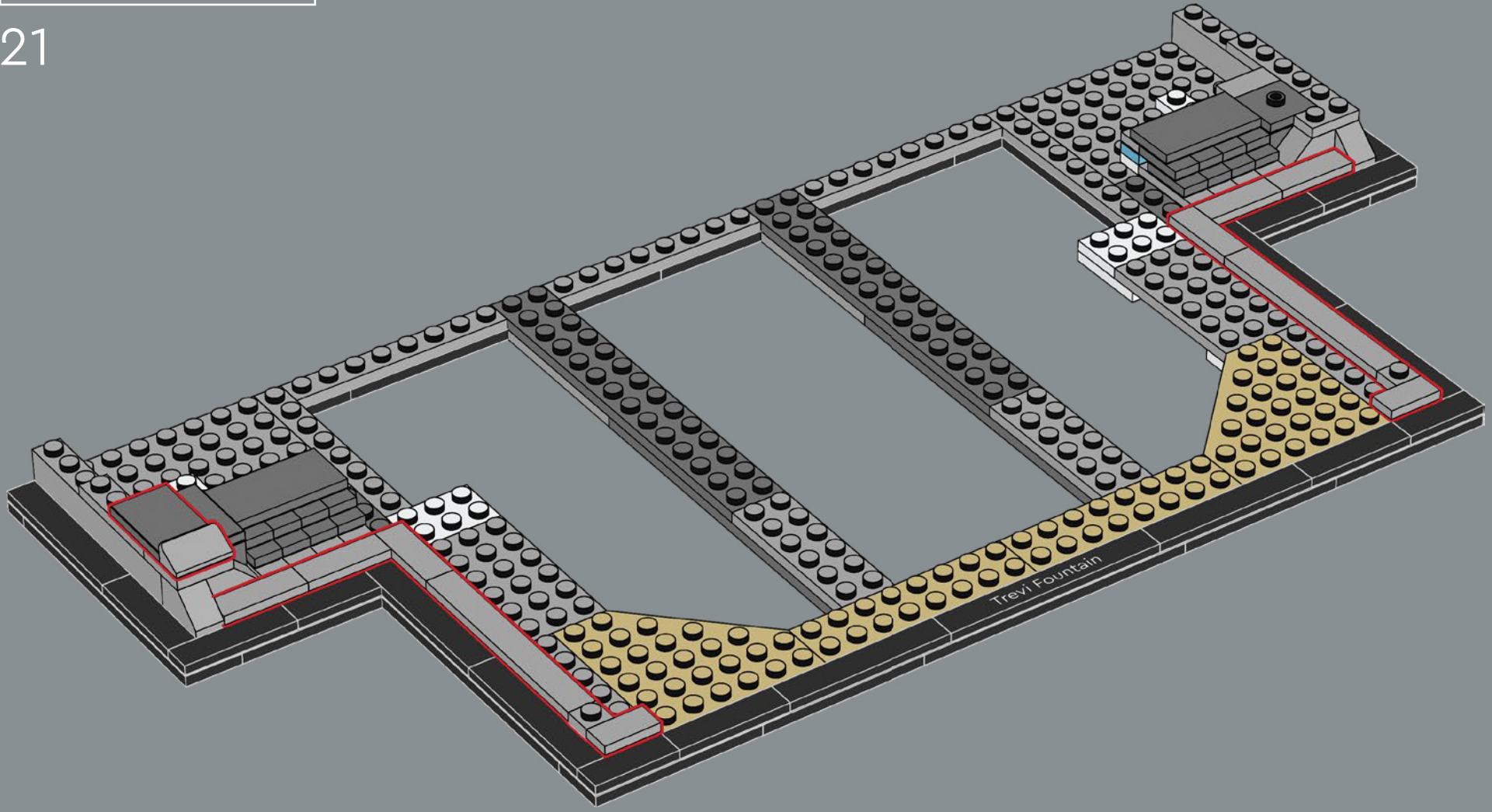

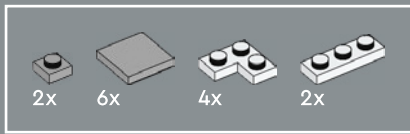

22

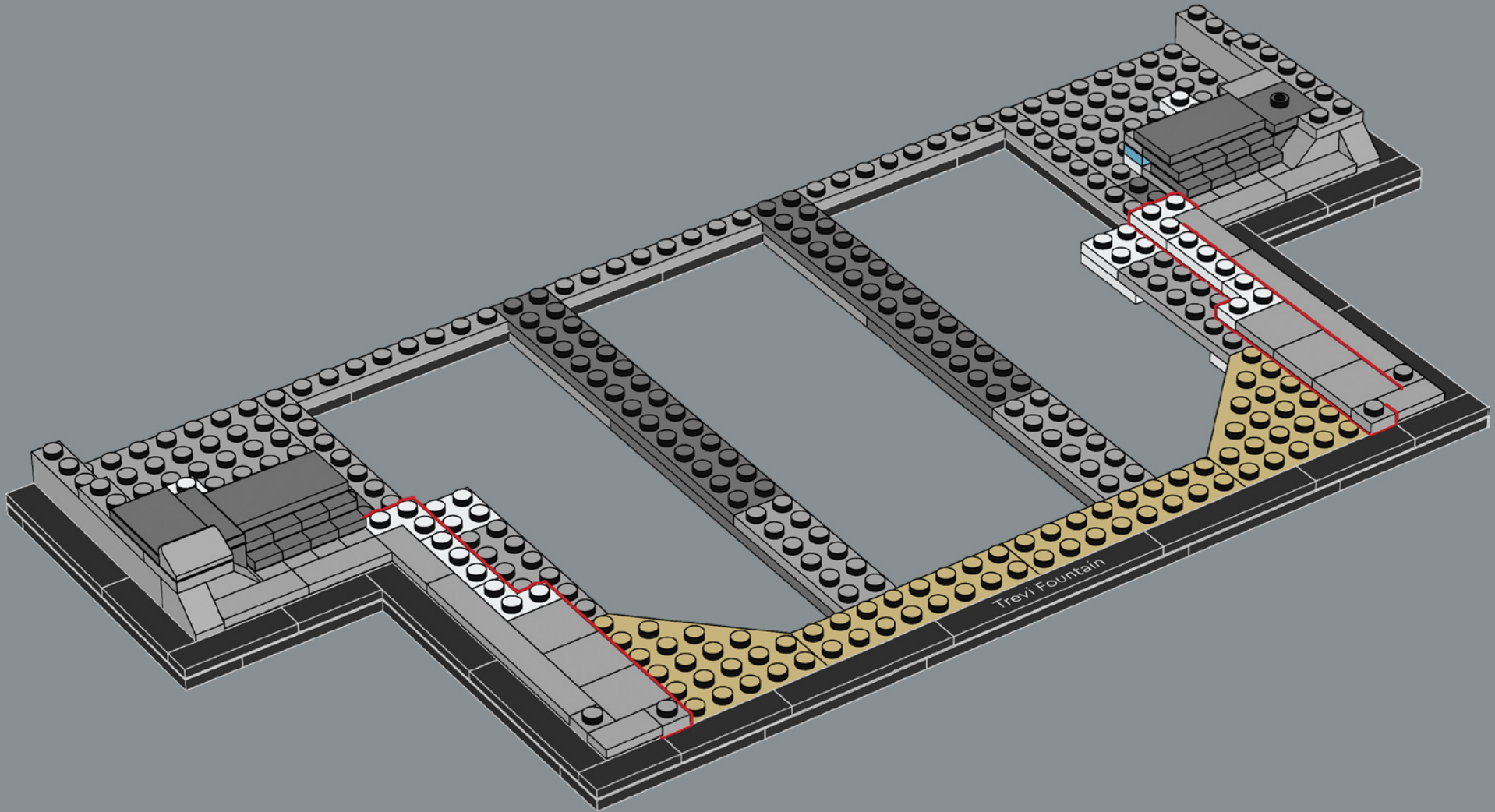

特雷维广场每年接待约 1000 万游客，使其成为意大利最受欢迎的旅游目的地之一。

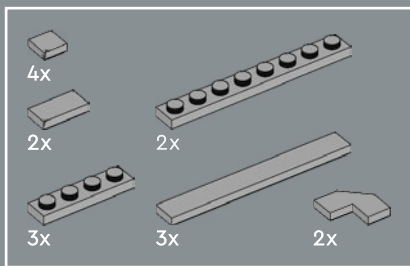

23

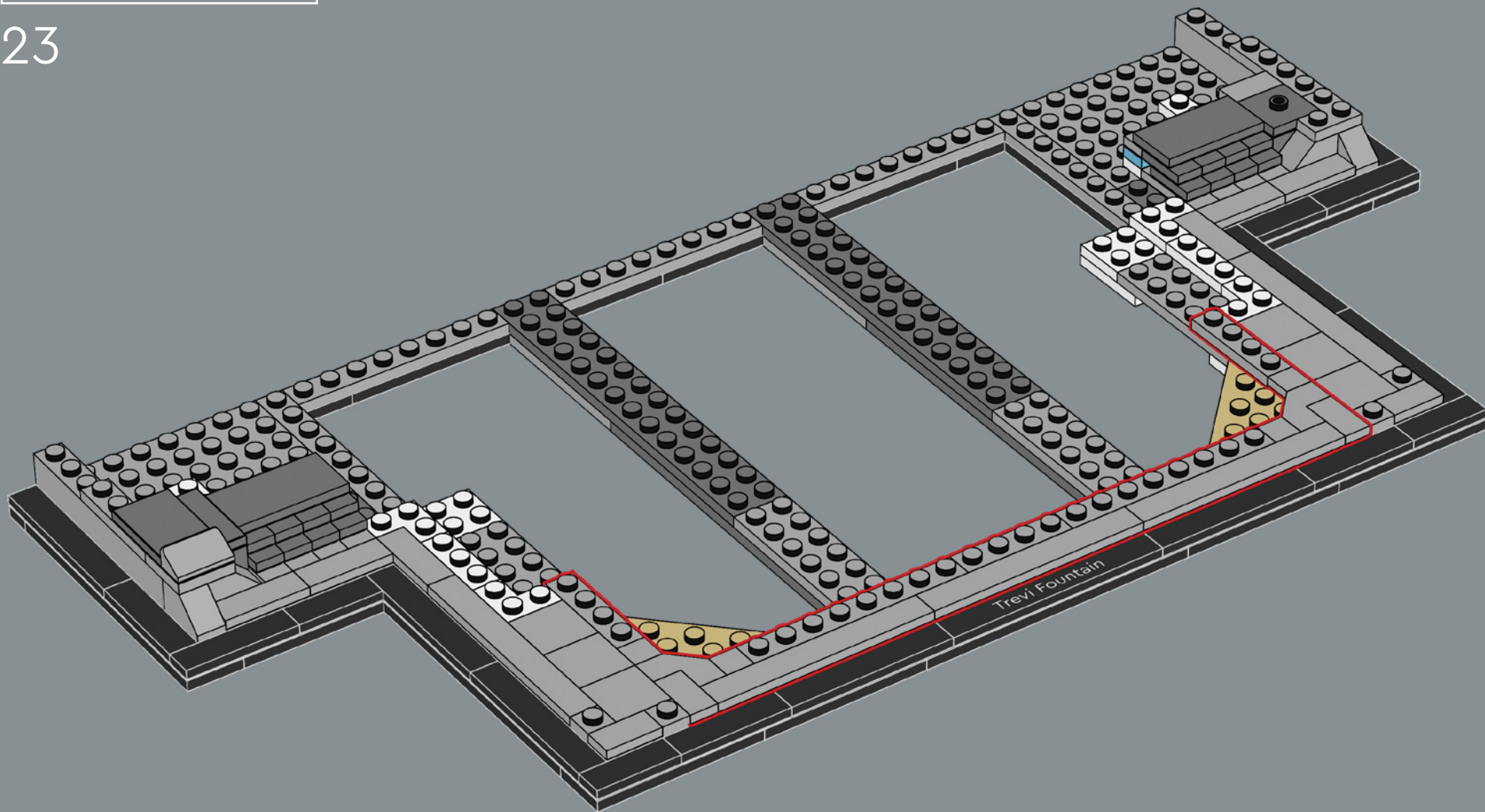

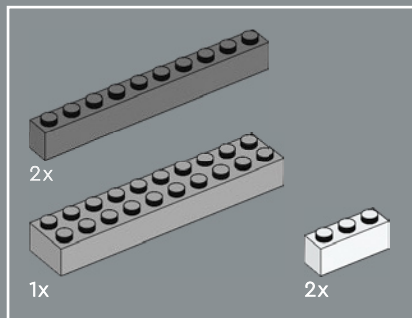

24

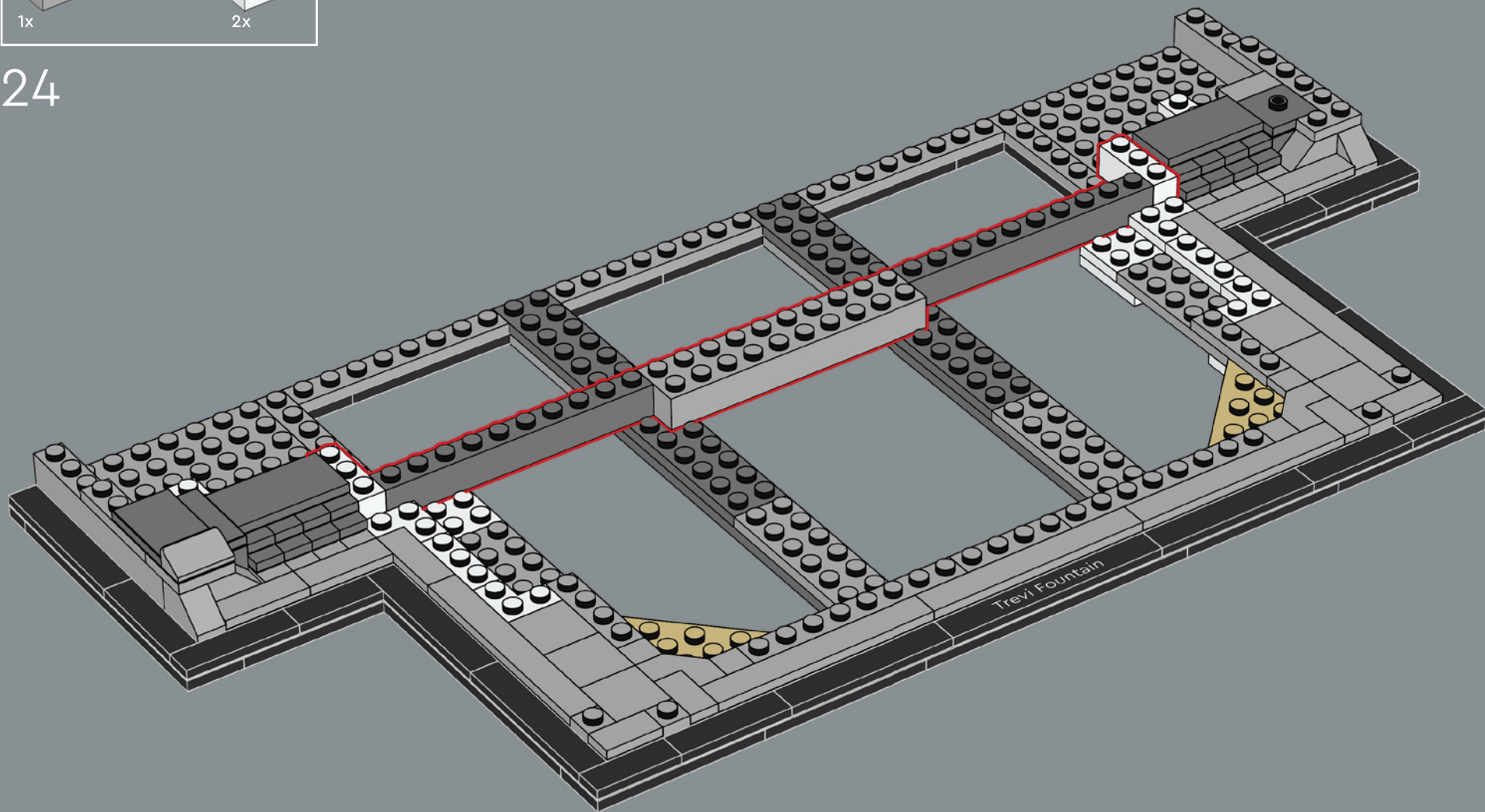

2x

25

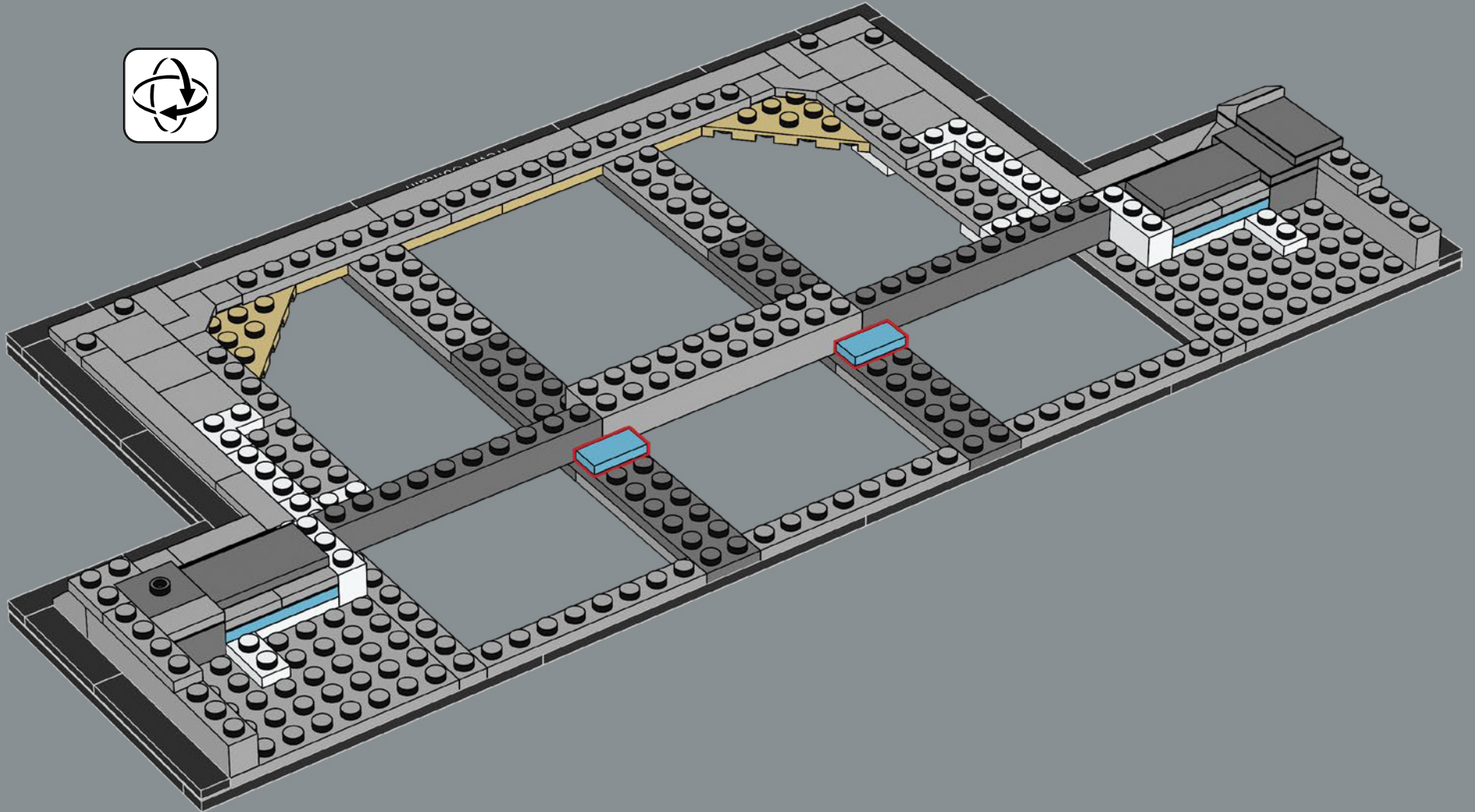

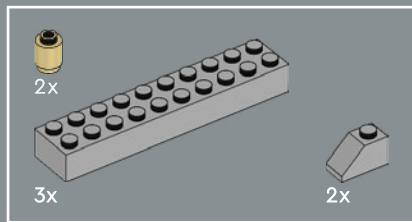

26

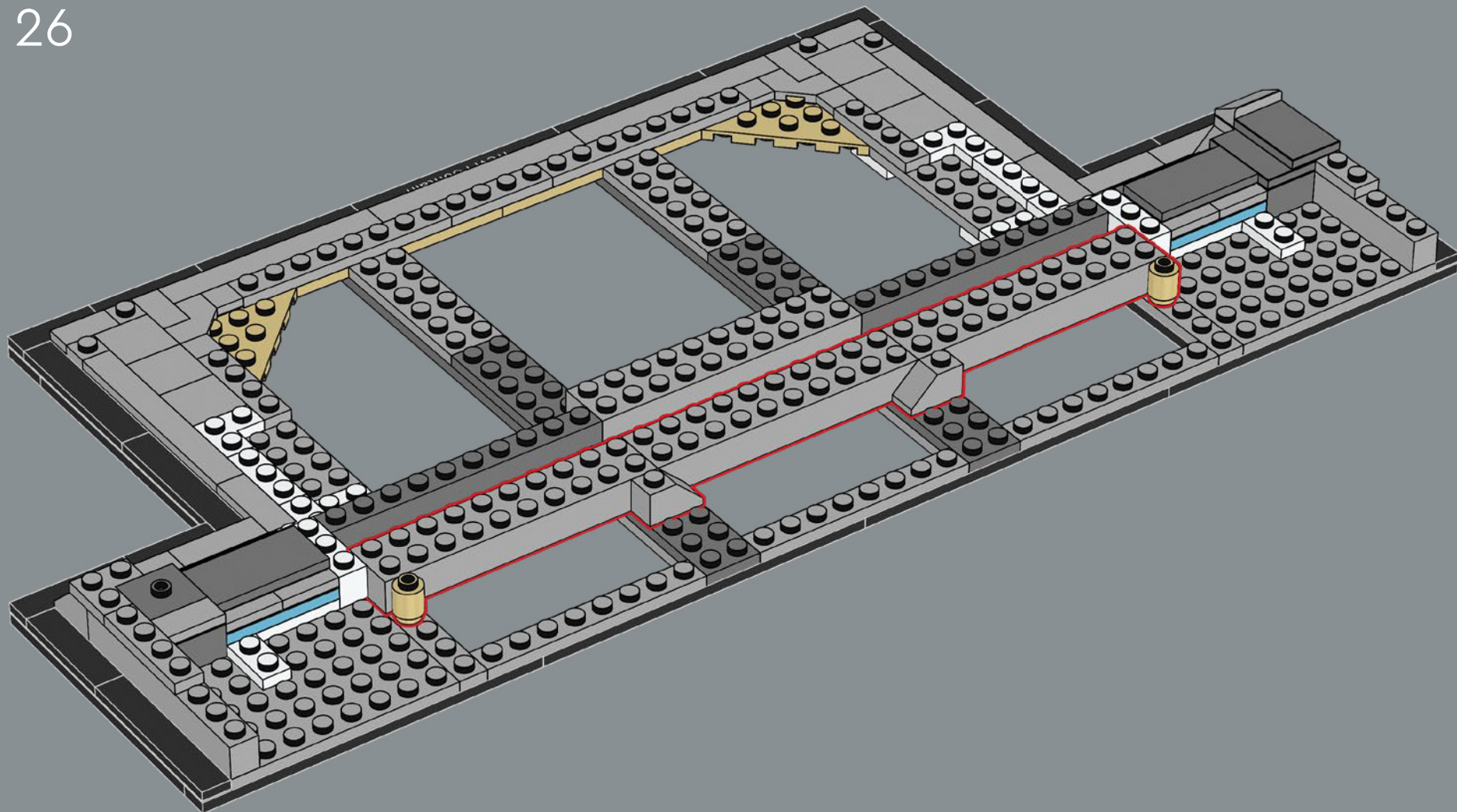

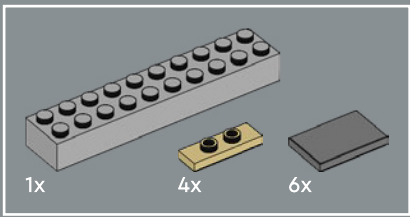

27

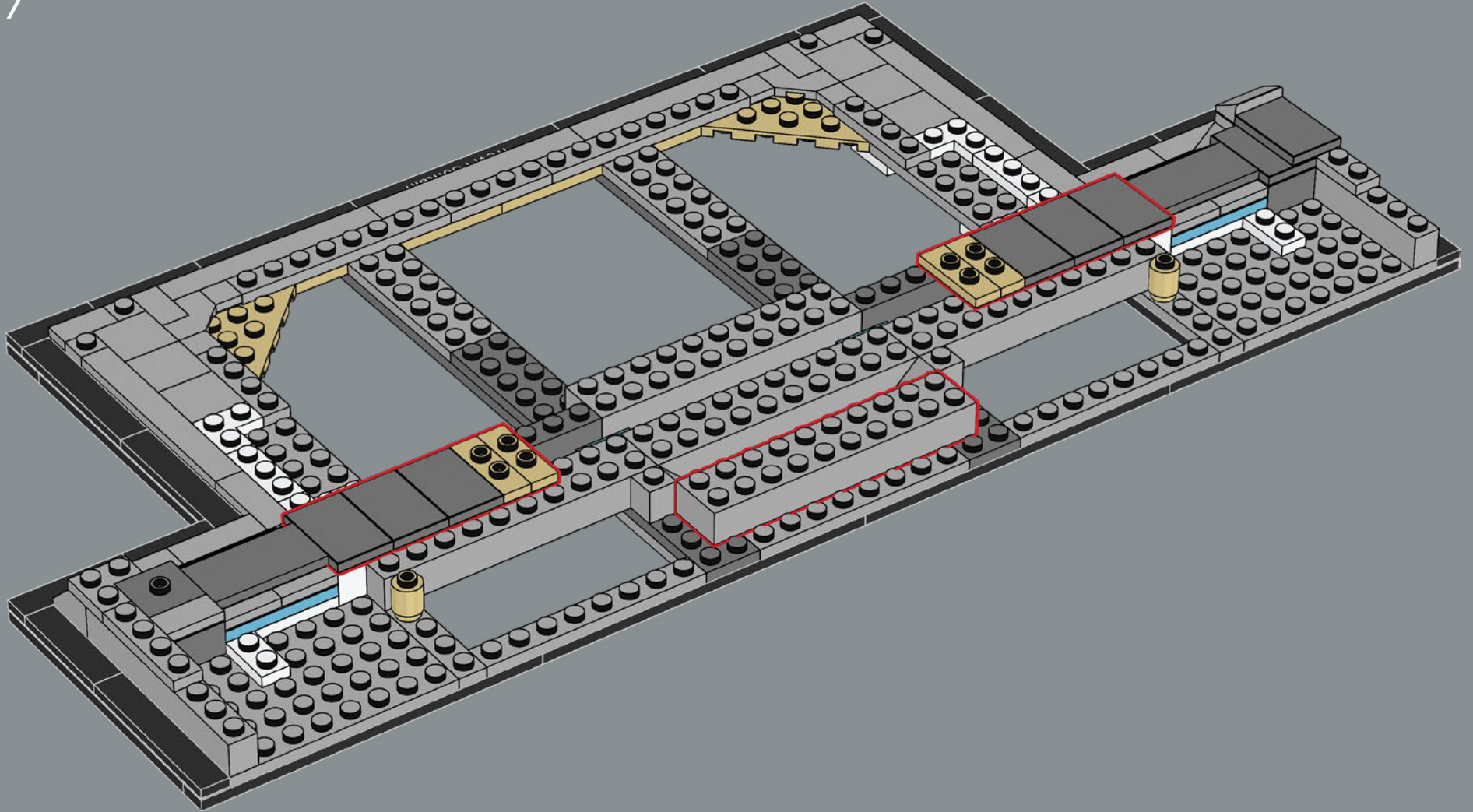



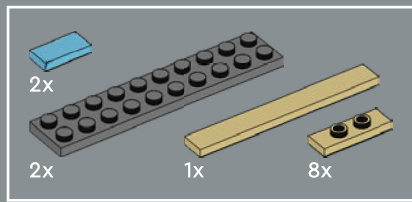

28

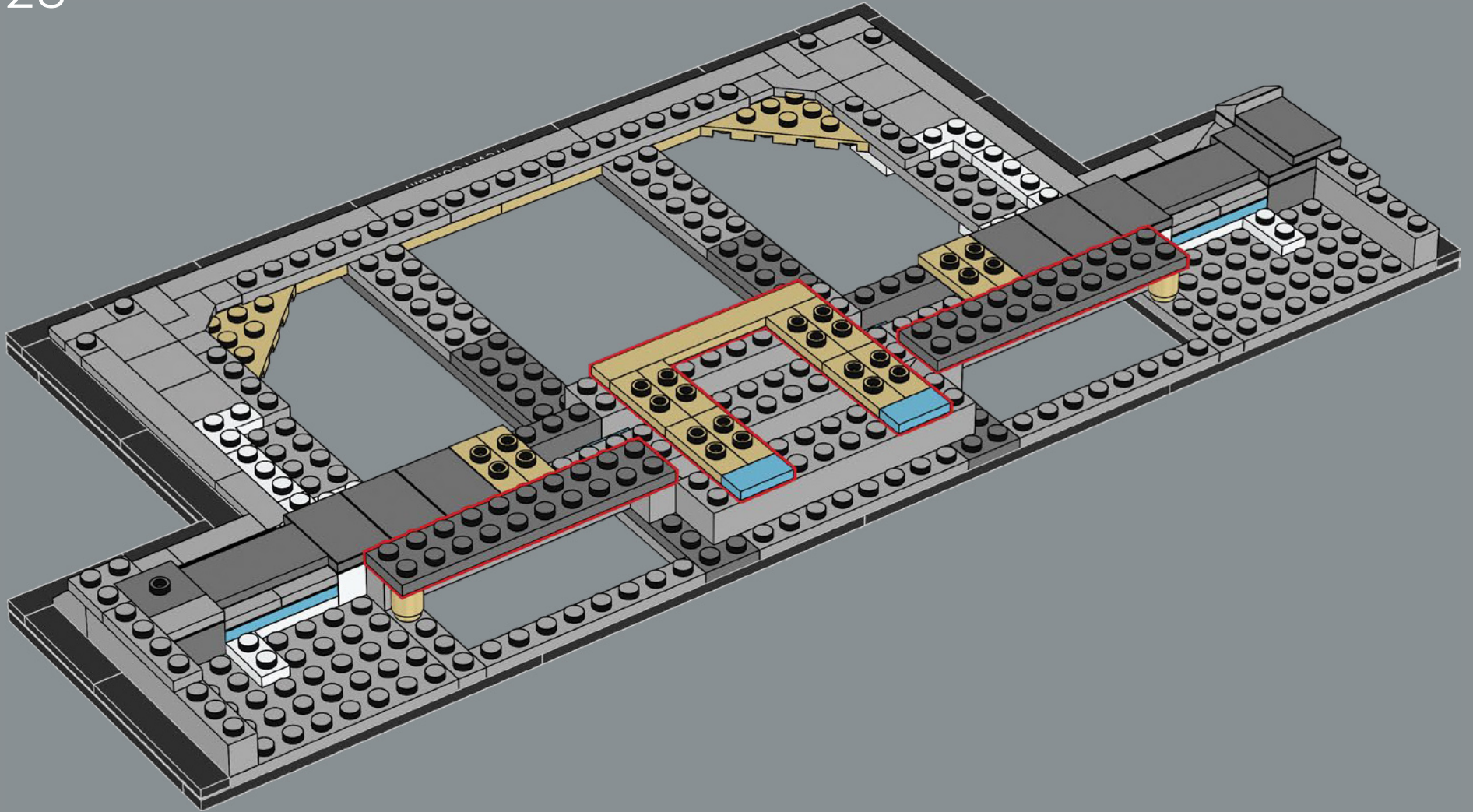

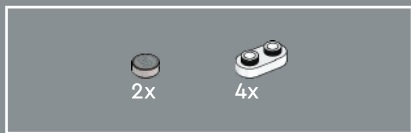

29

根据当地传说,如果你把一枚硬币抛入喷泉,那么你一定会回到罗马。  
如果抛入两枚硬币,你会在喷泉边与命中注定的另一半邂逅。如果你  
提供三枚硬币,你们可能会永远在一起!

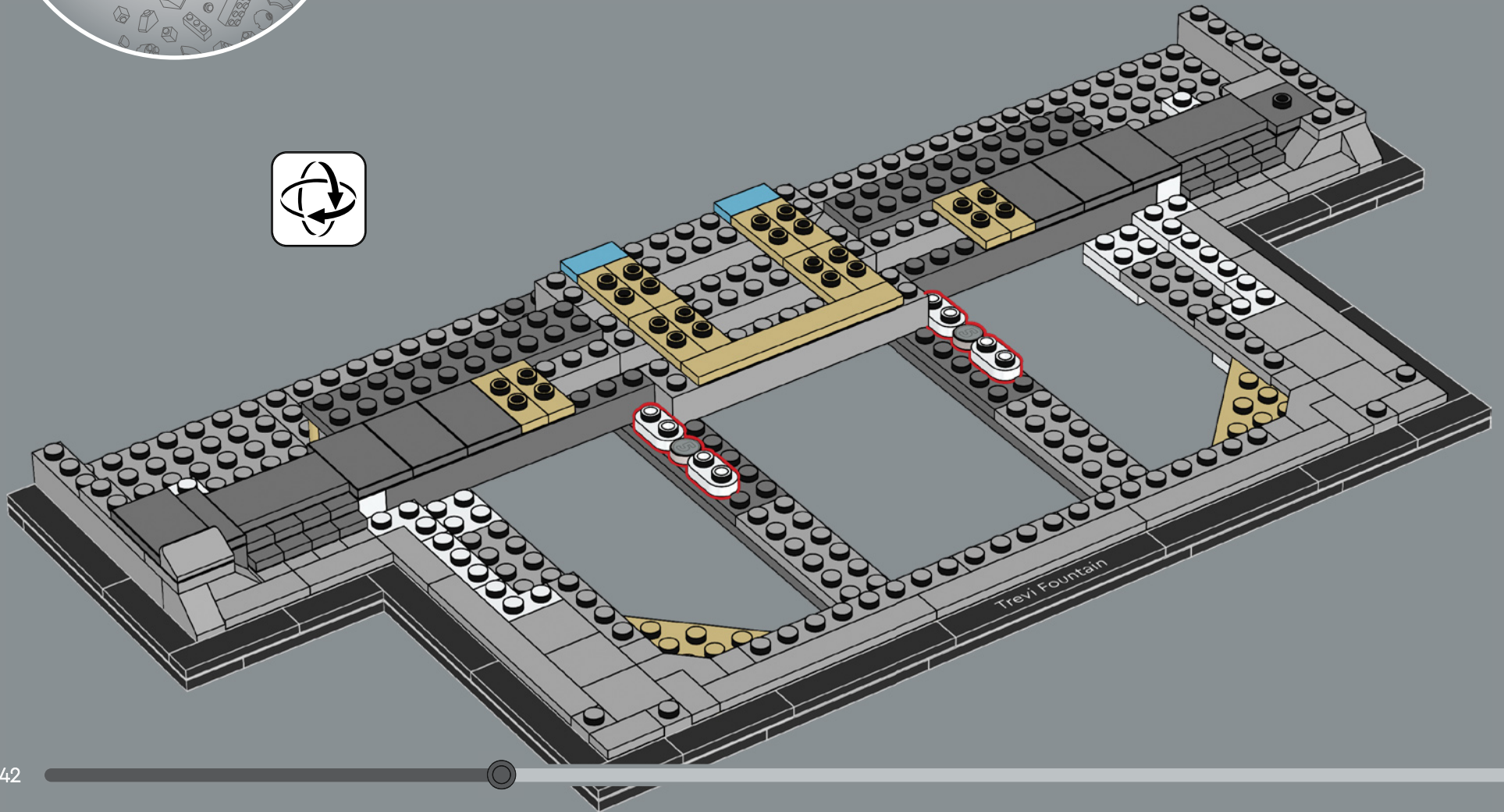

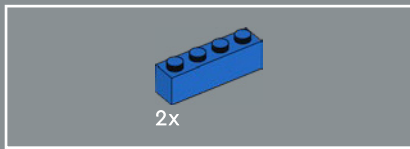

30

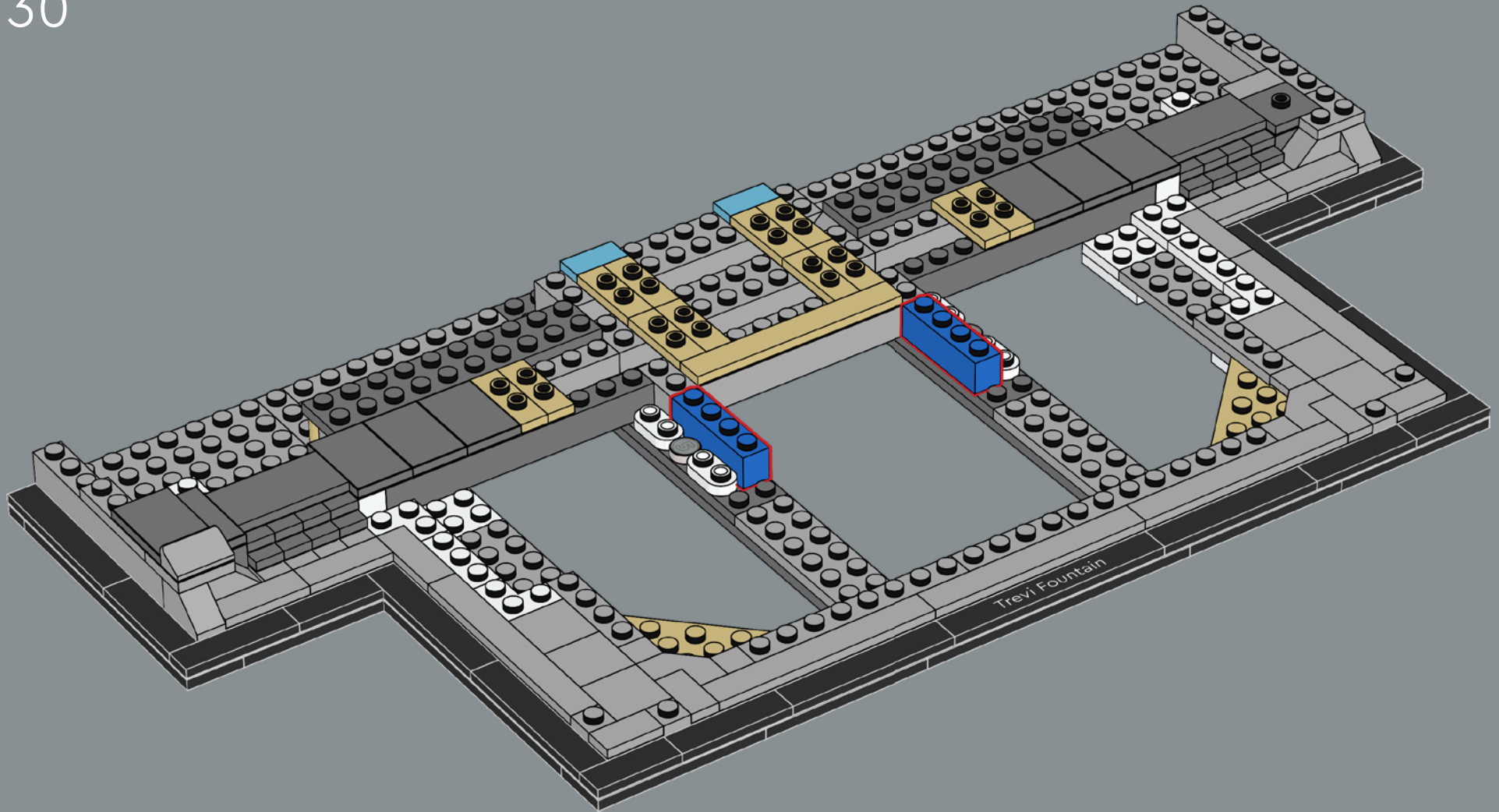

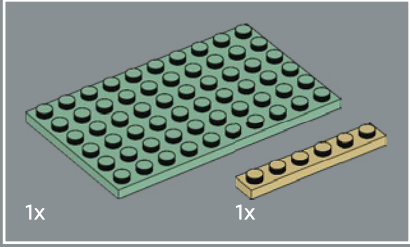
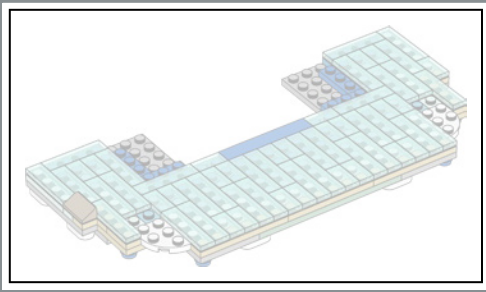

31

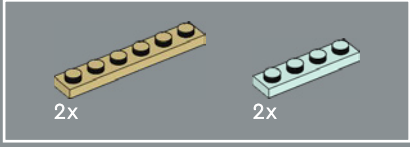
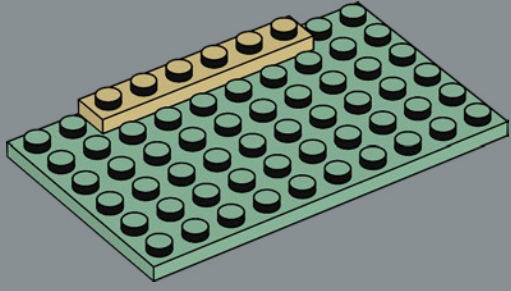

32

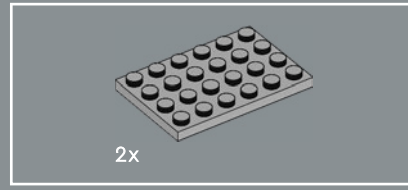
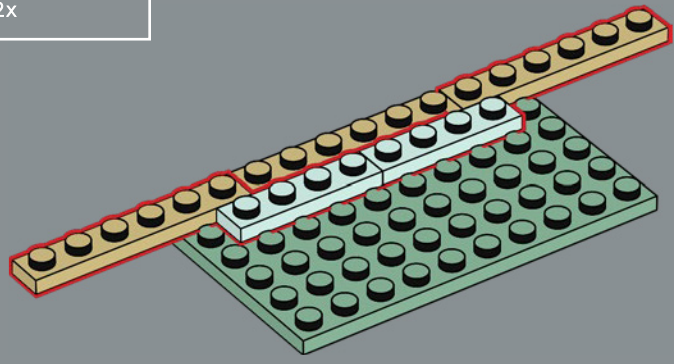

33

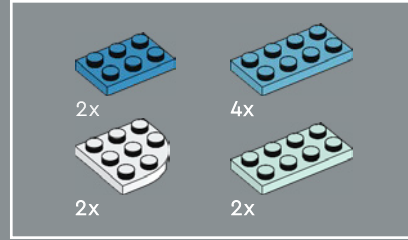
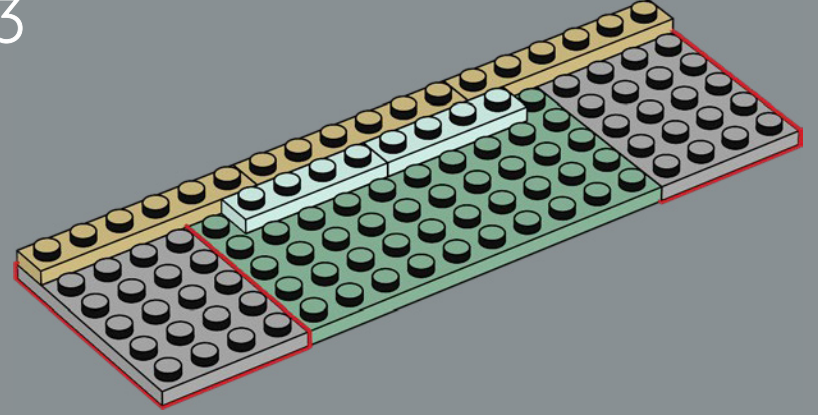

34

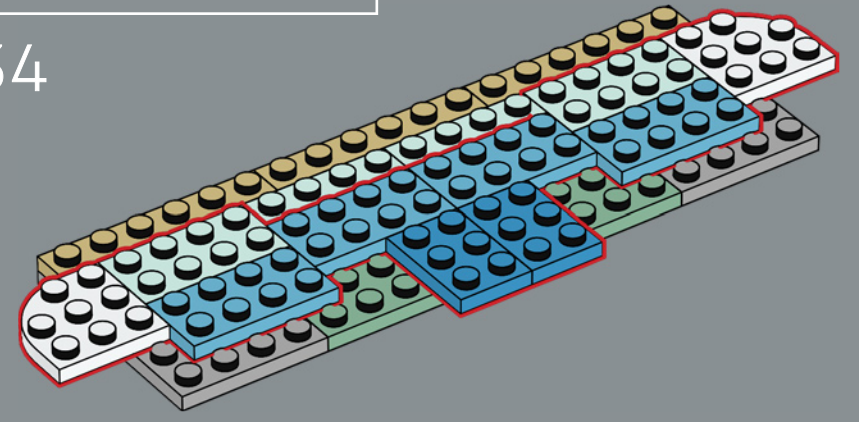

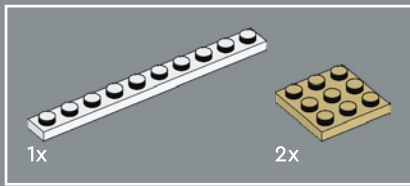

35

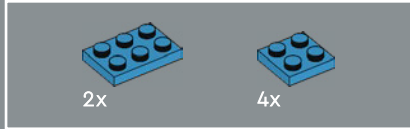
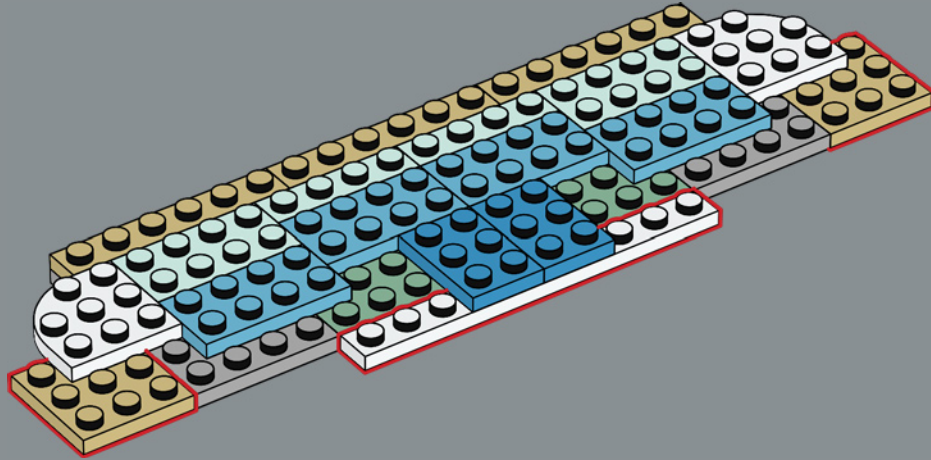

36

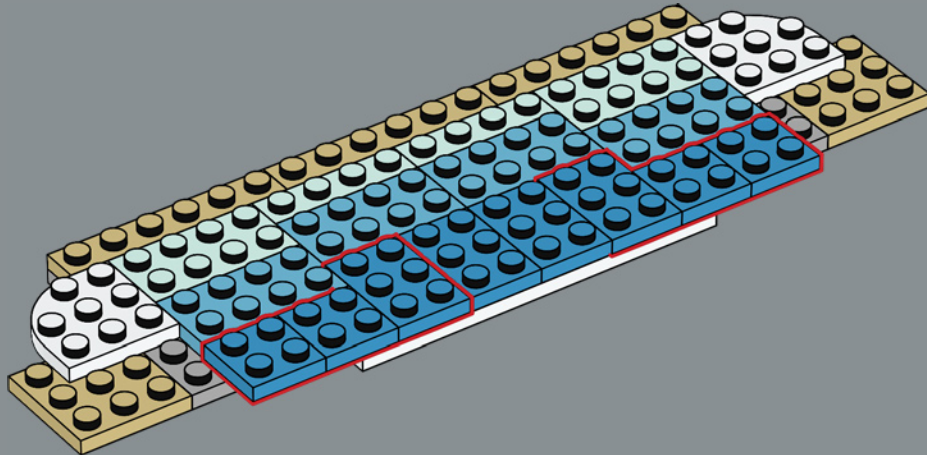

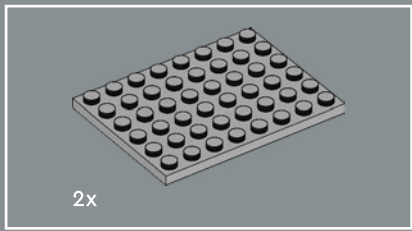

37

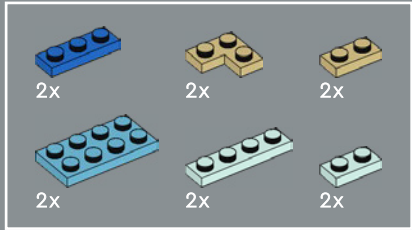
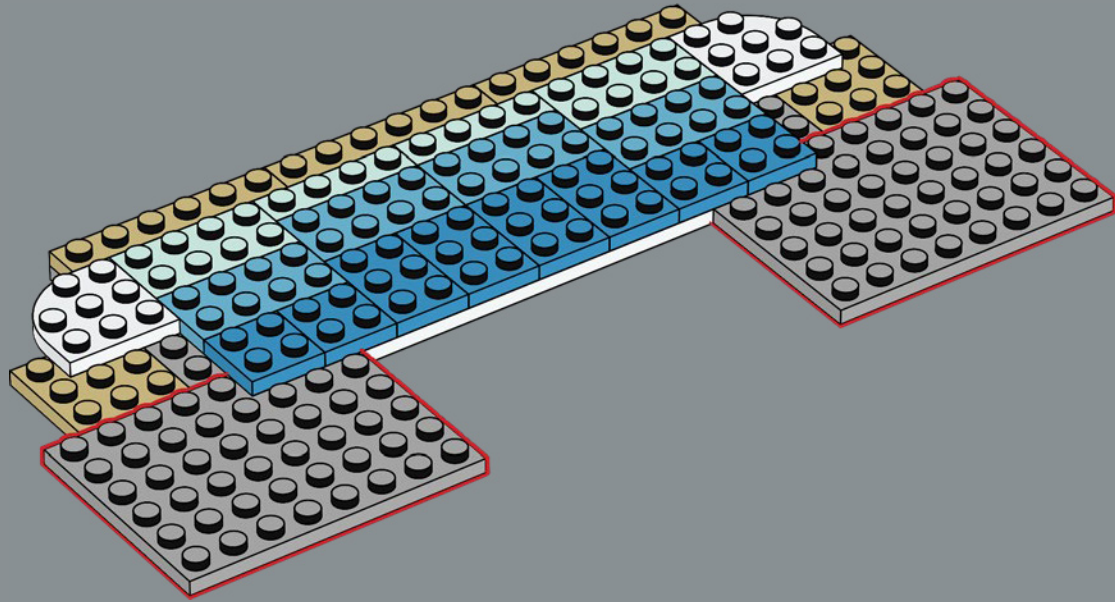

38

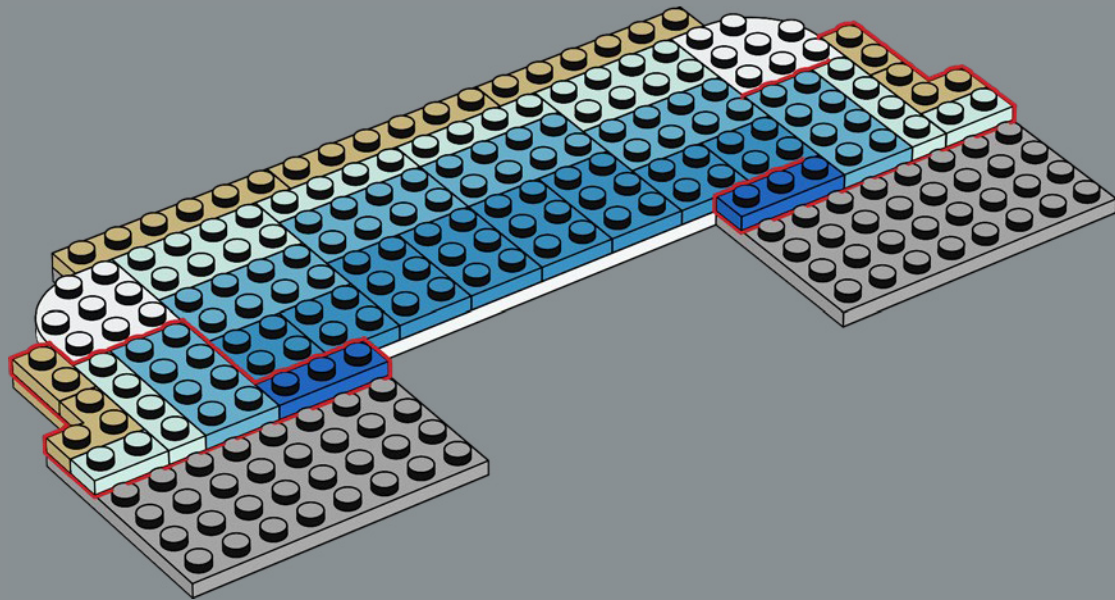

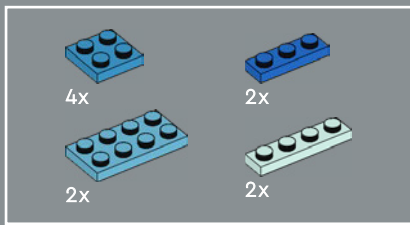

39

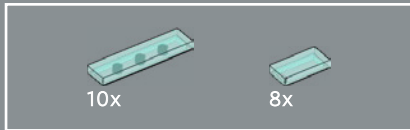
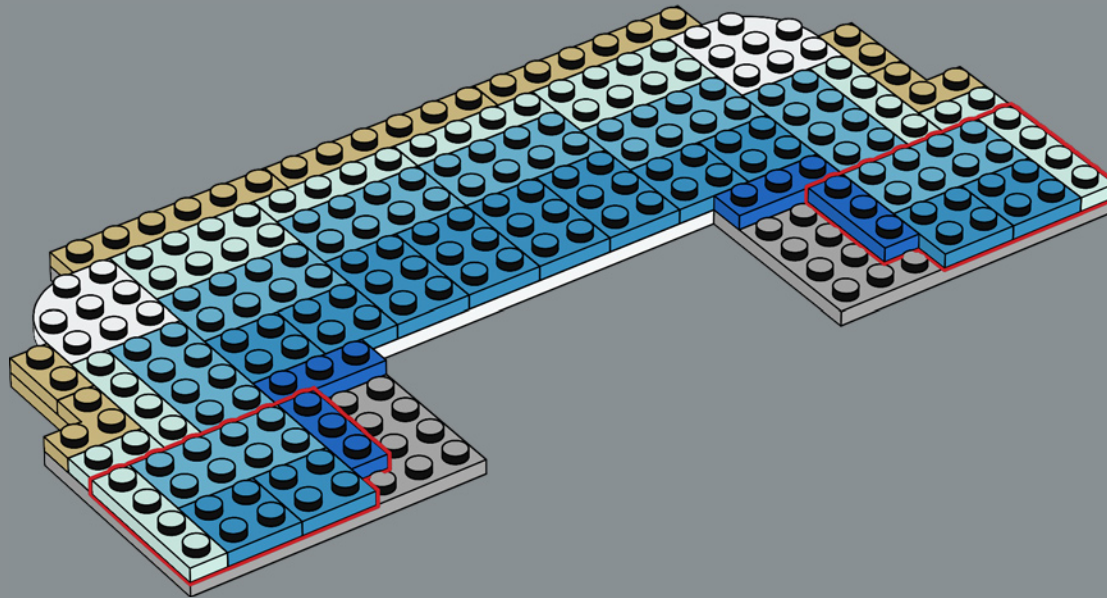

40

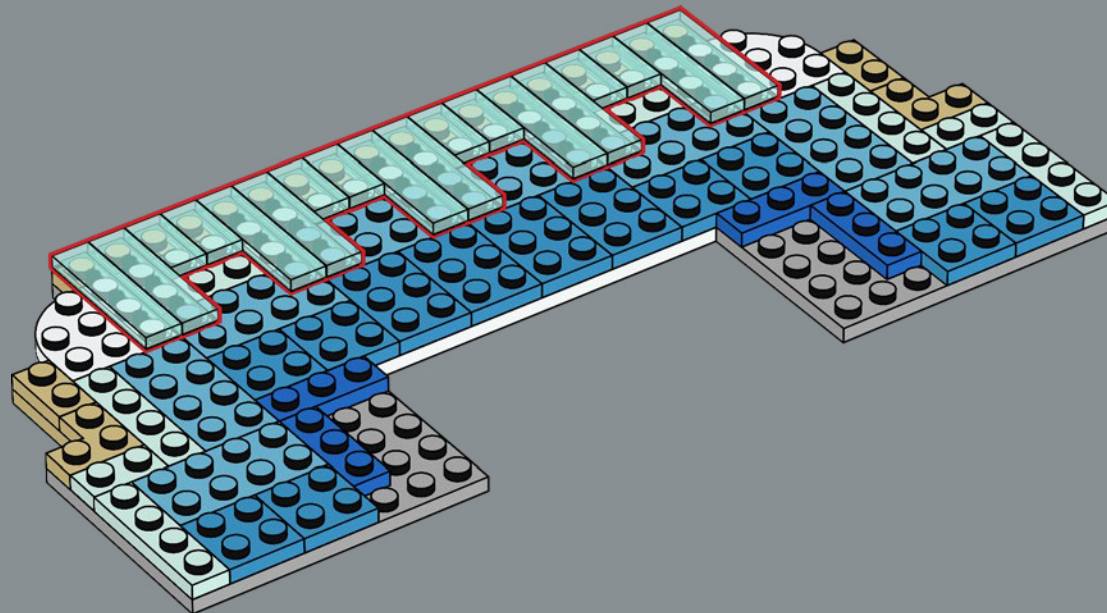

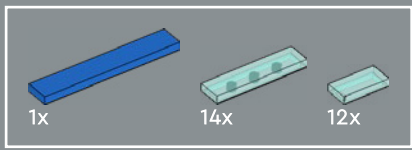

41

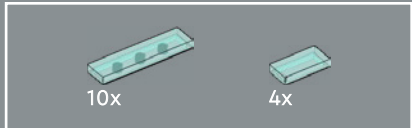
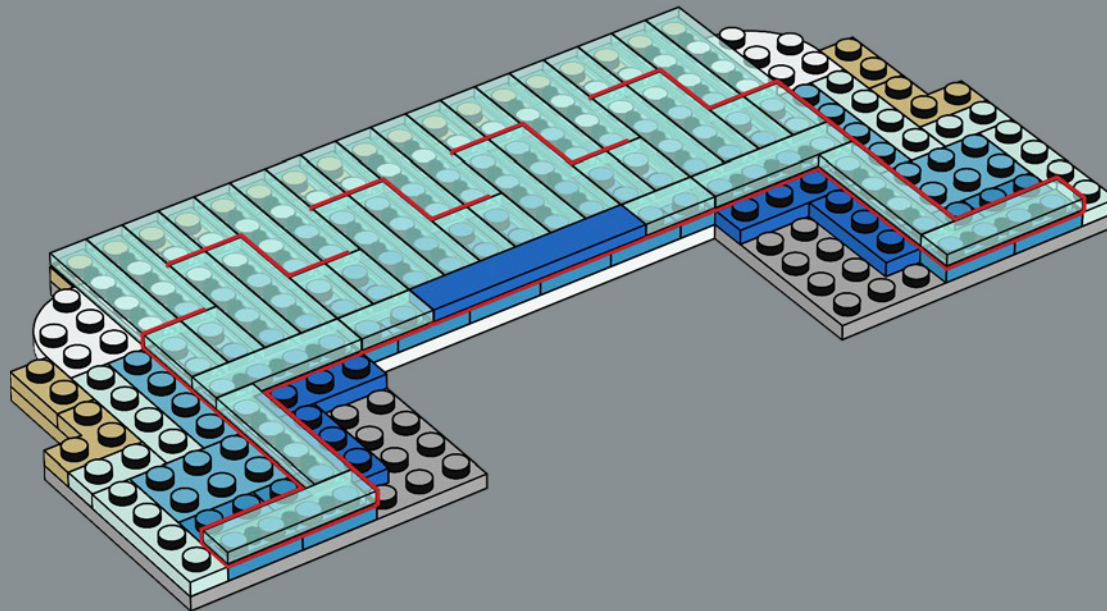

42

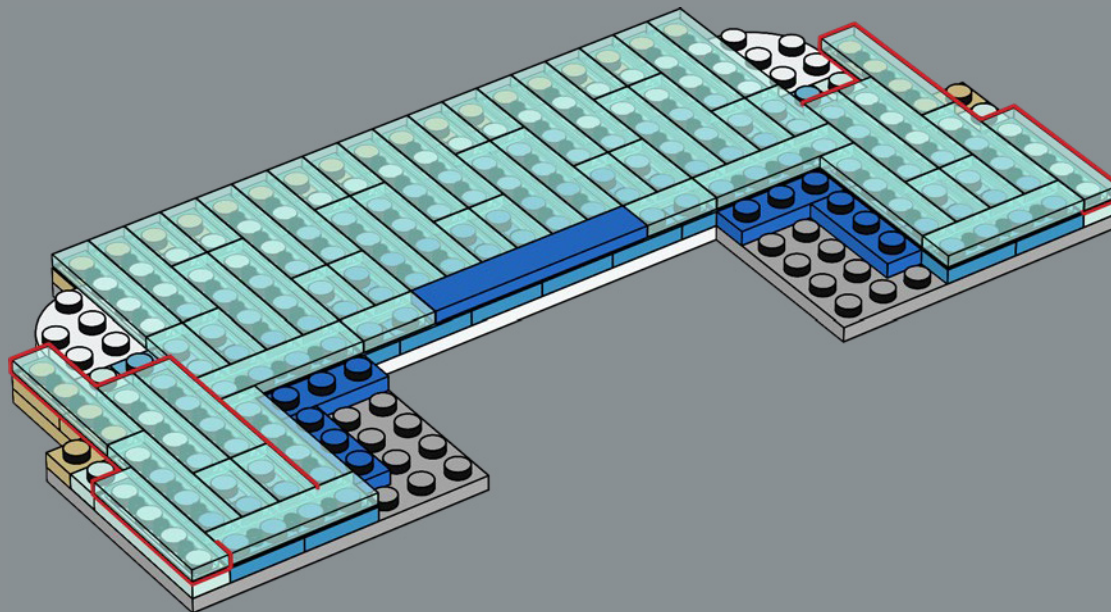



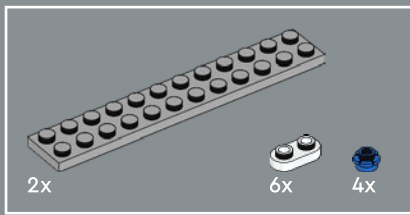

43

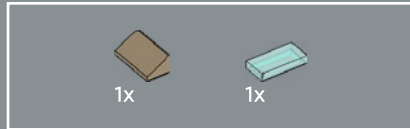
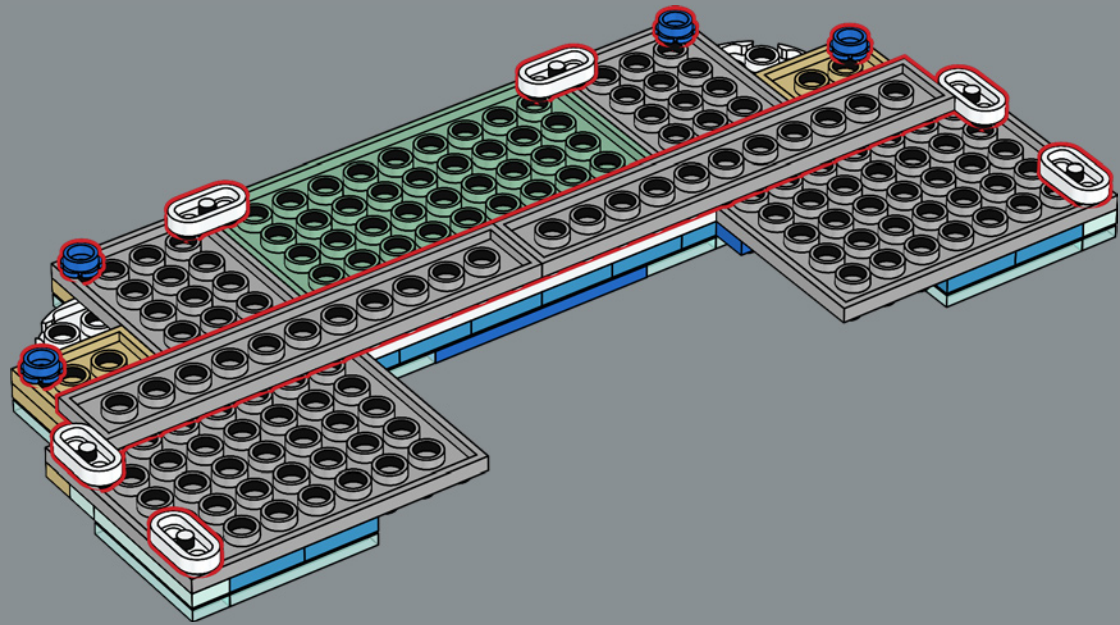

44

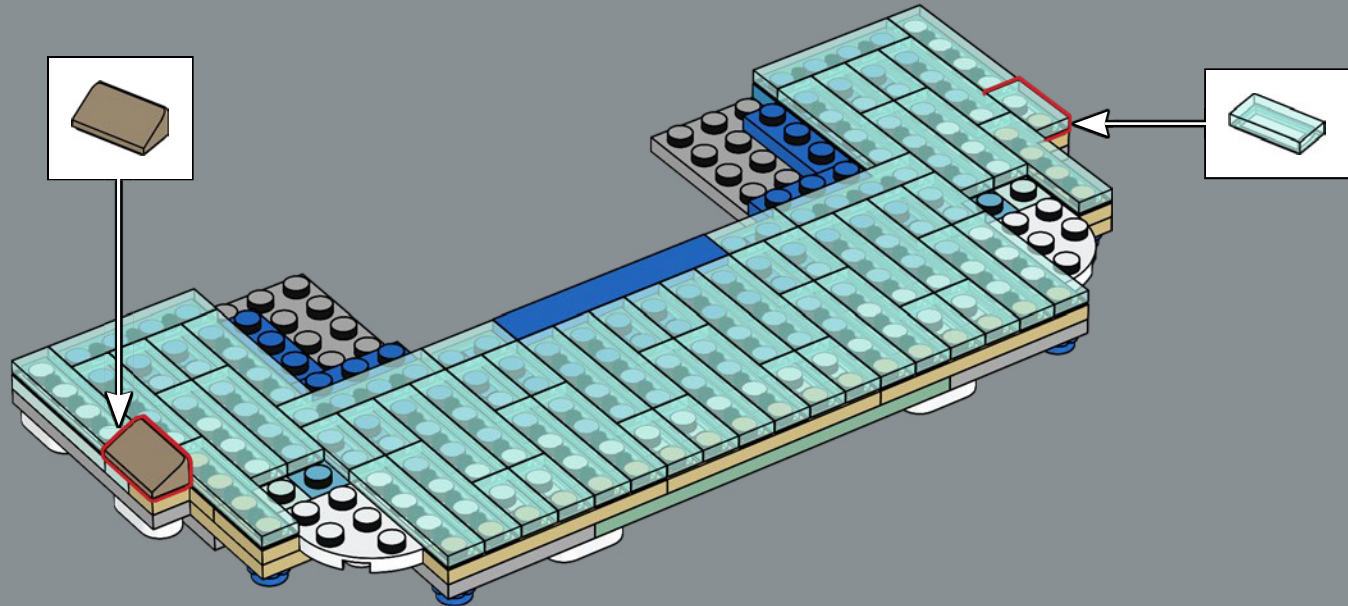

每天大约有价值 3000 欧元/3200 美元的硬币被抛入喷泉。在一天结束时,这些硬币会被收集起来,大部分会捐赠给慈善机构。

45

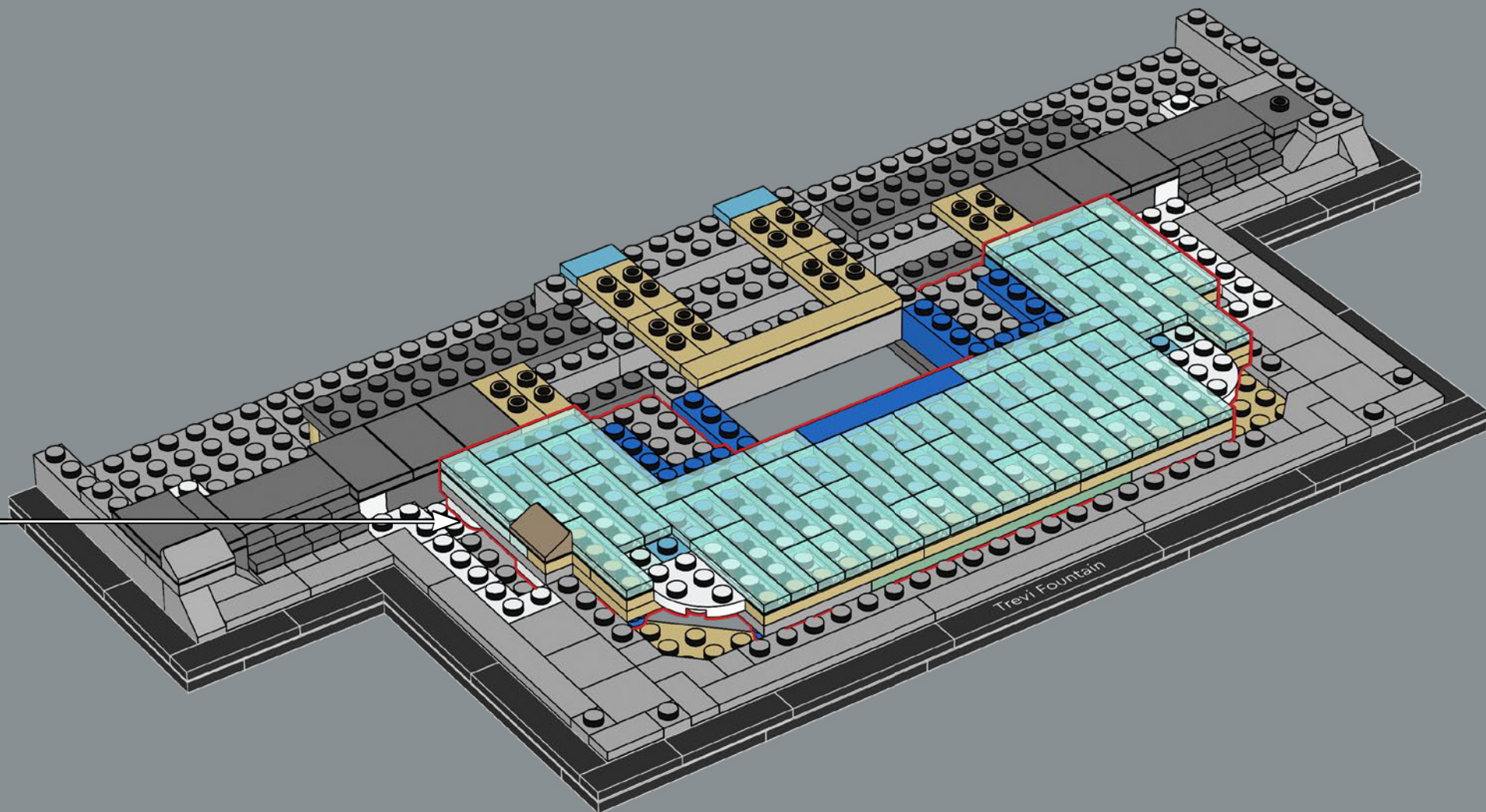



46

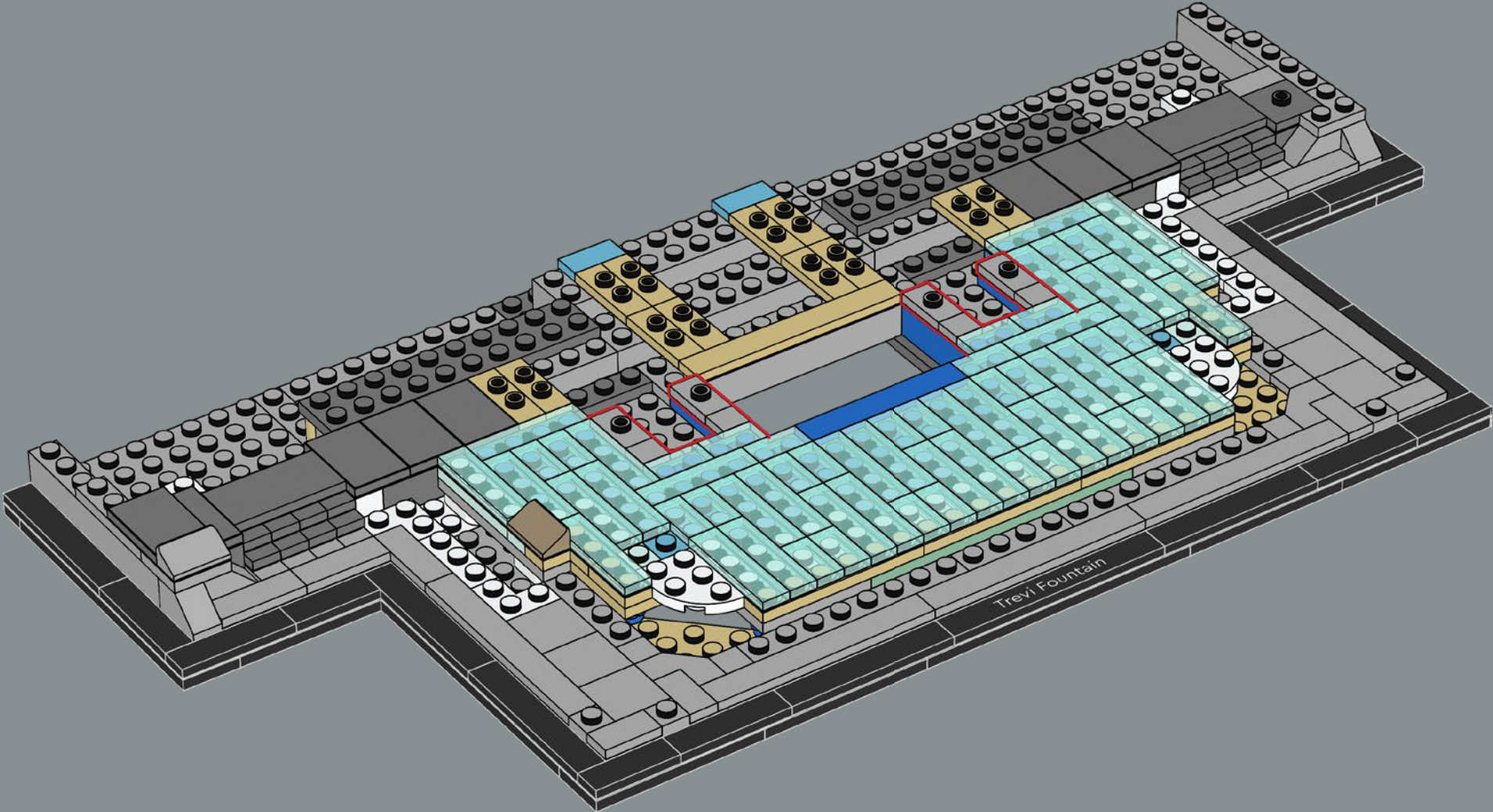

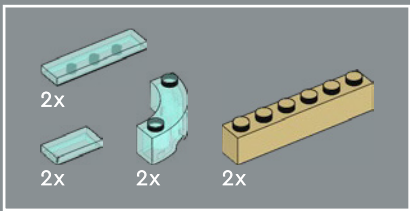

47

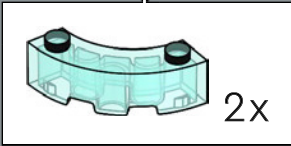
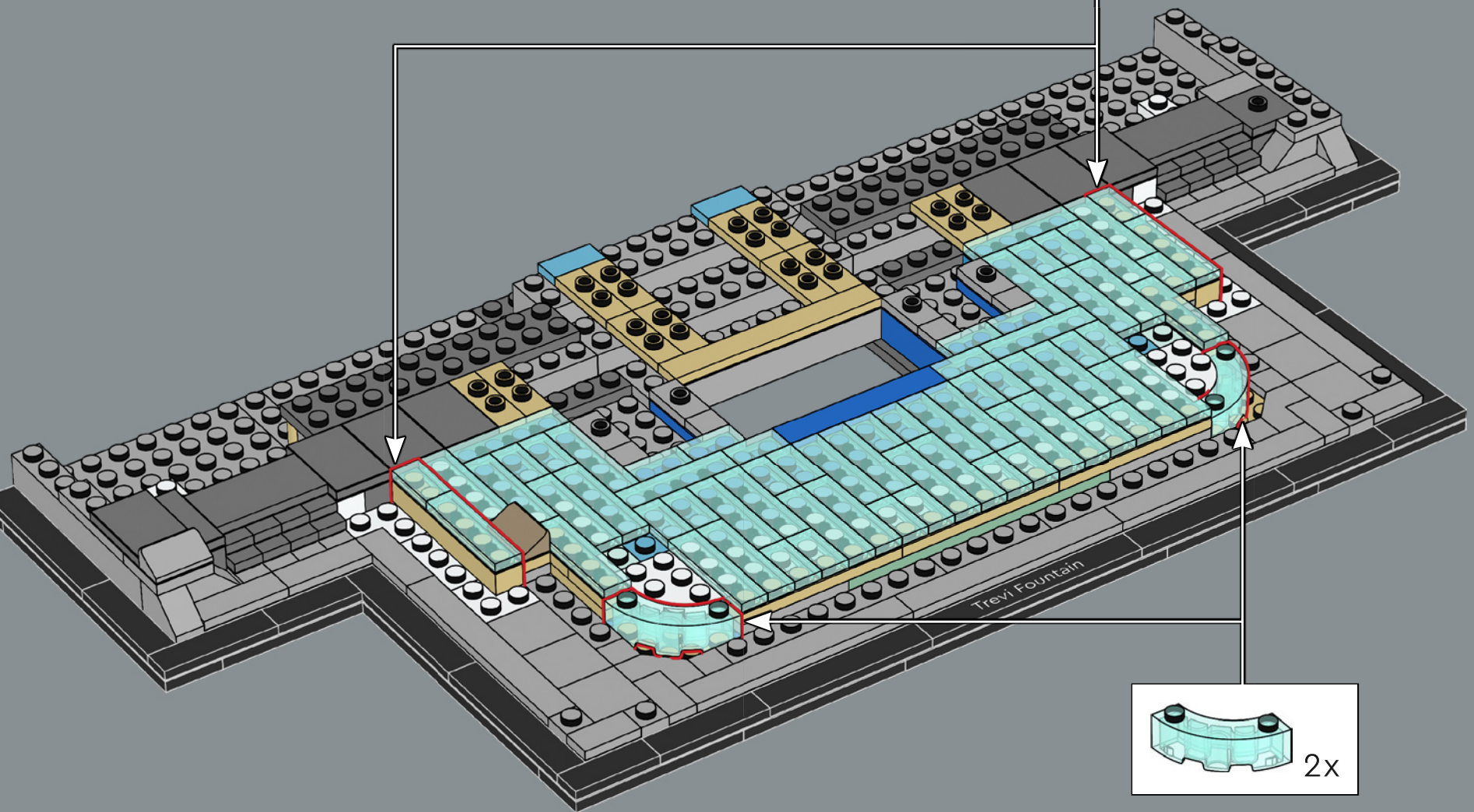
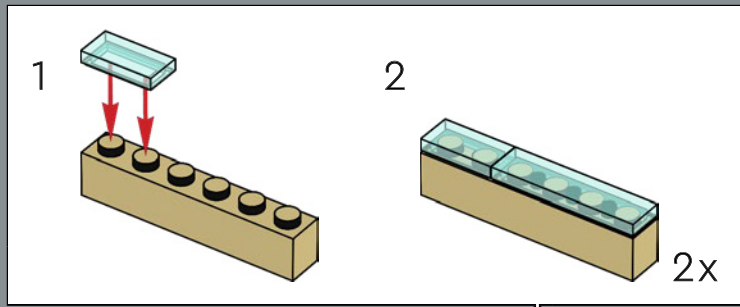

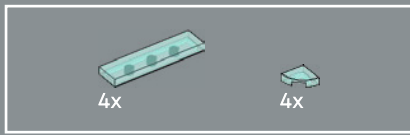

48

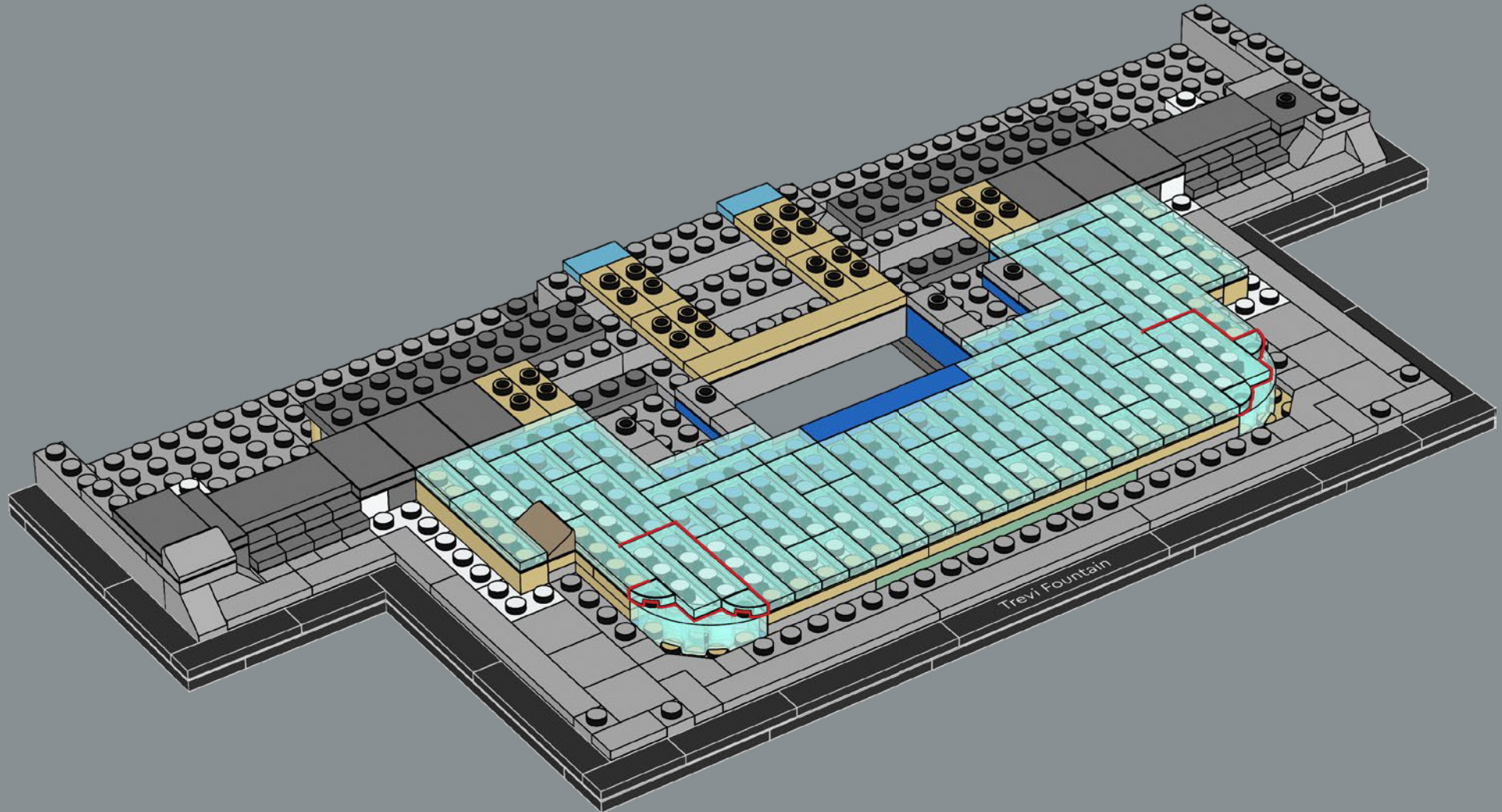

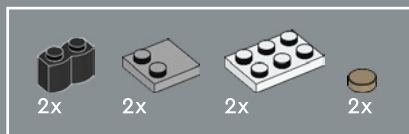

49

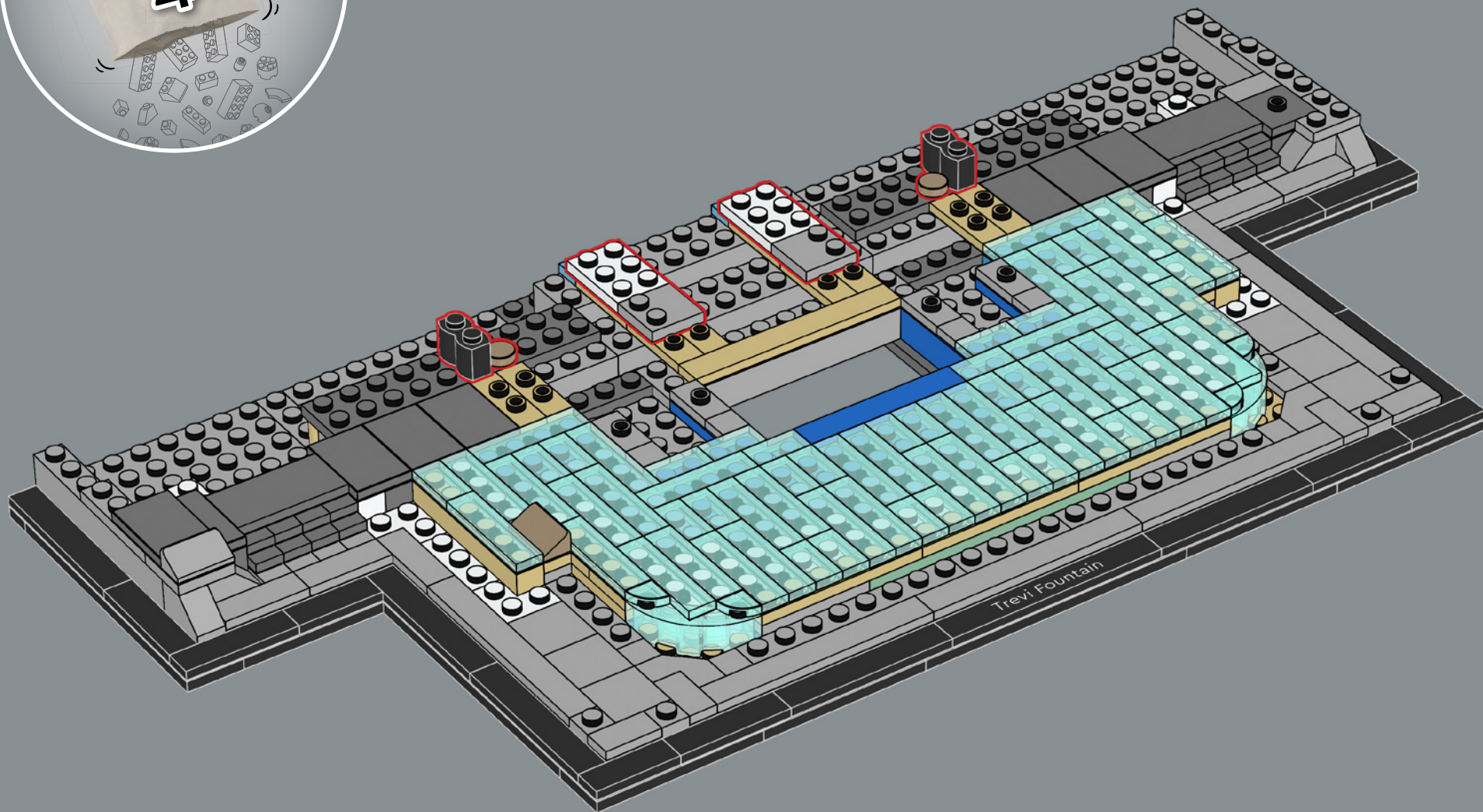

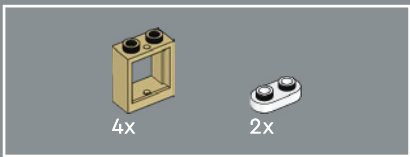

50

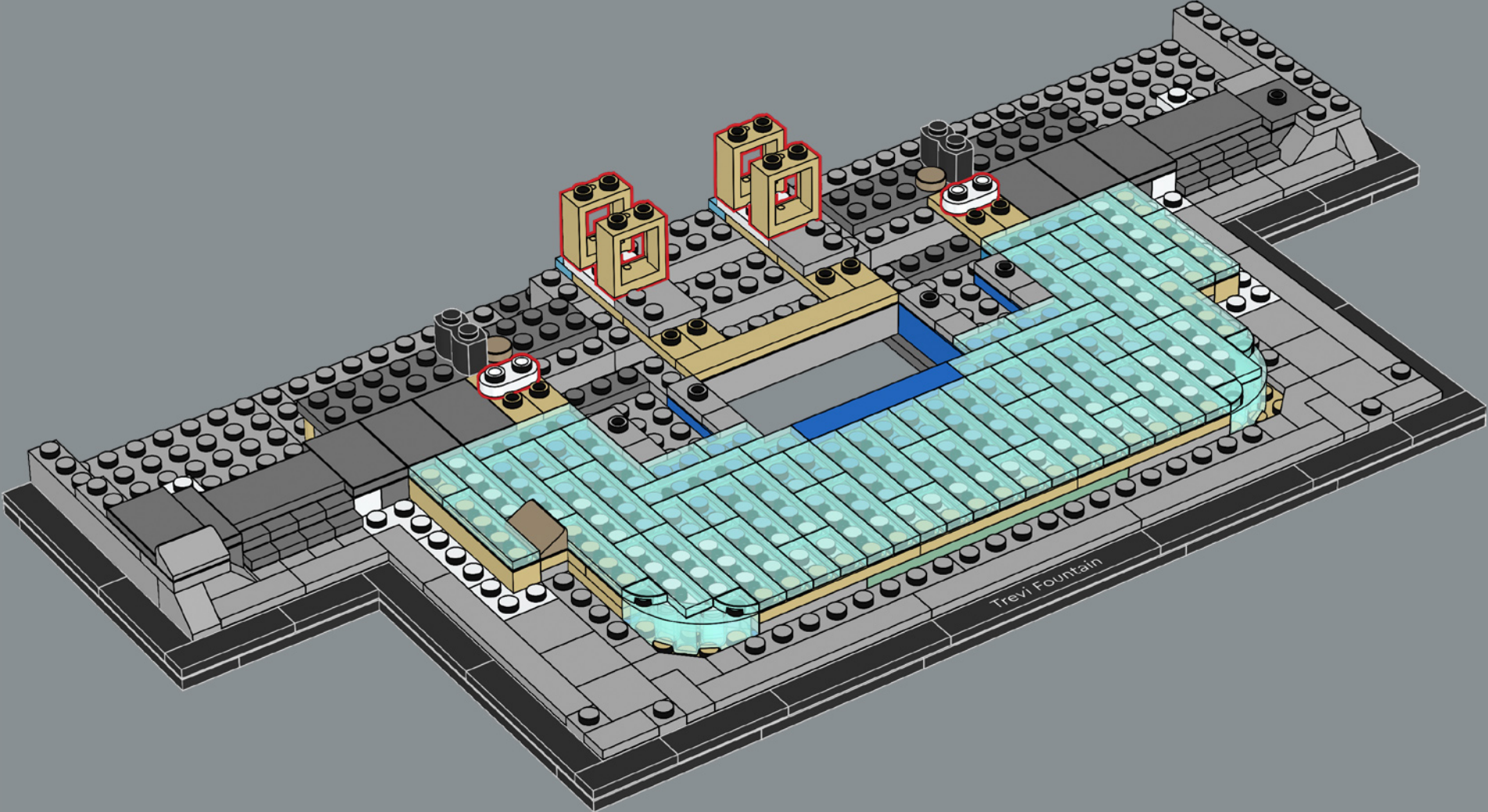

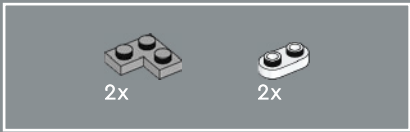

51

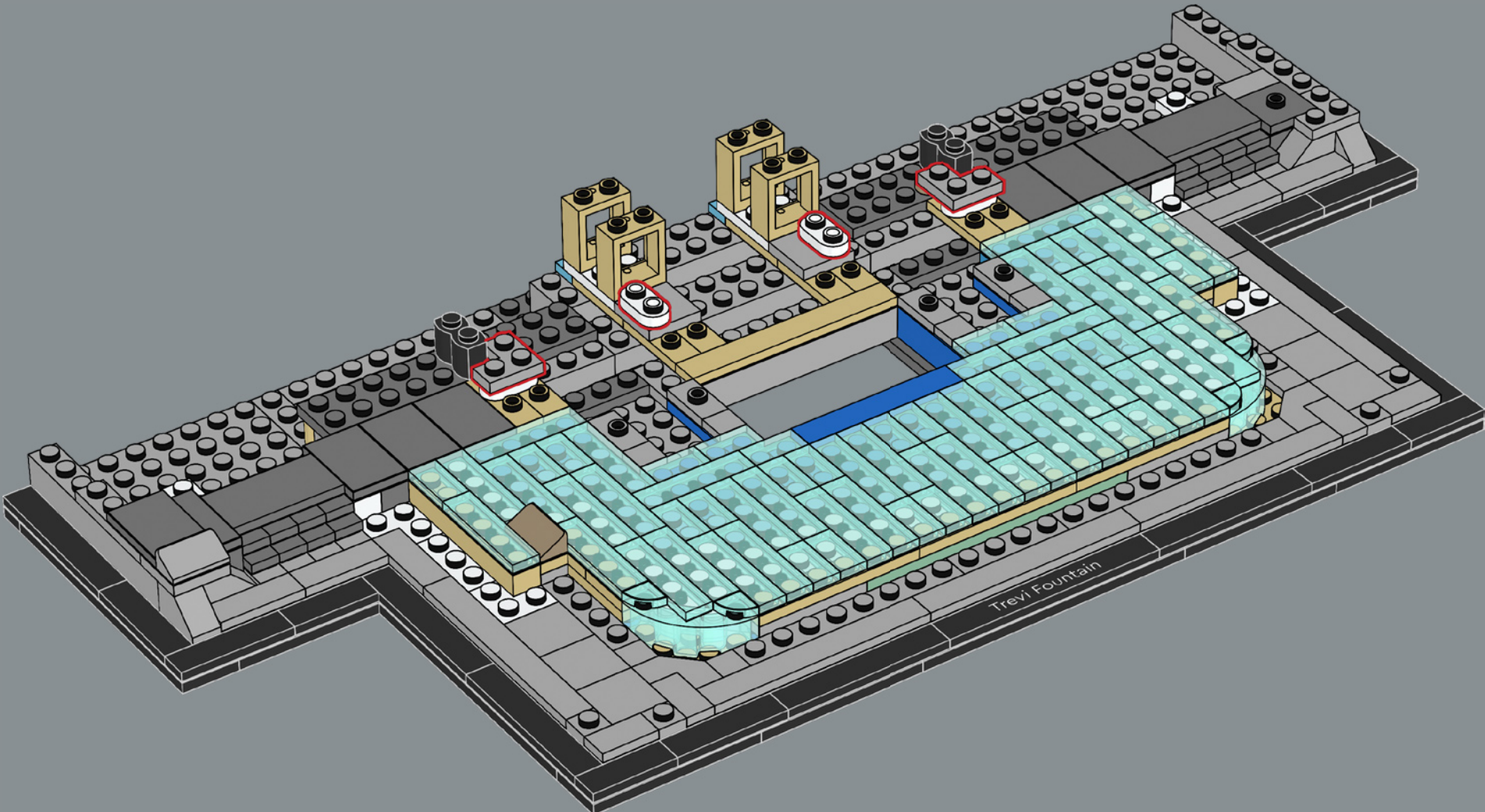



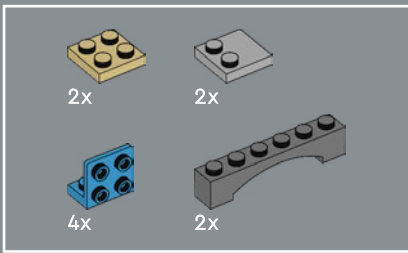

52

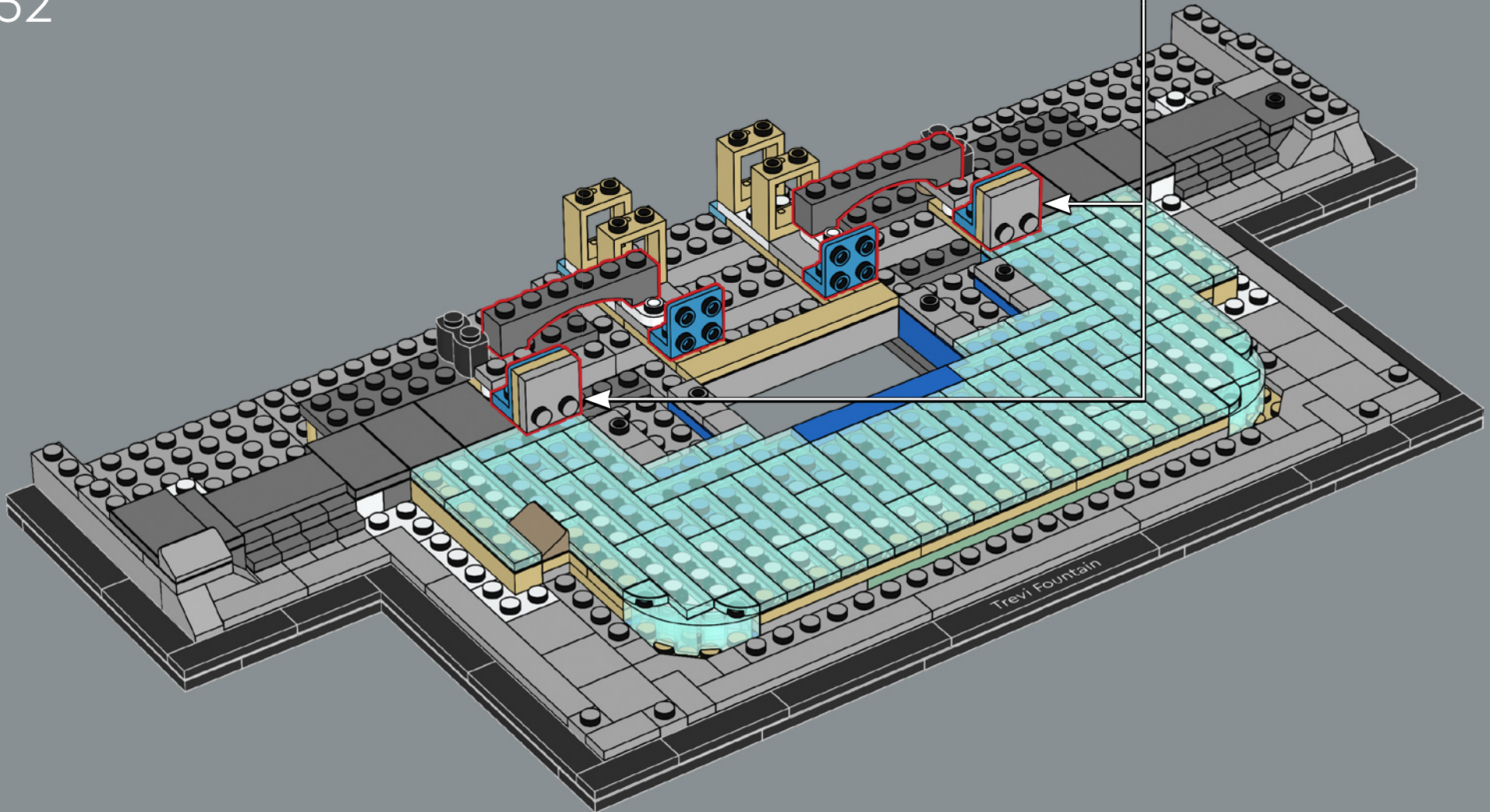
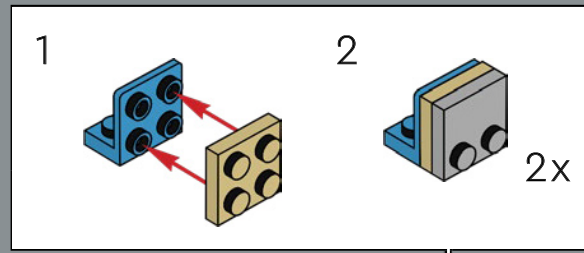

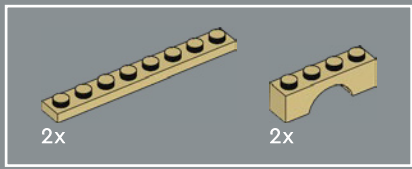

53

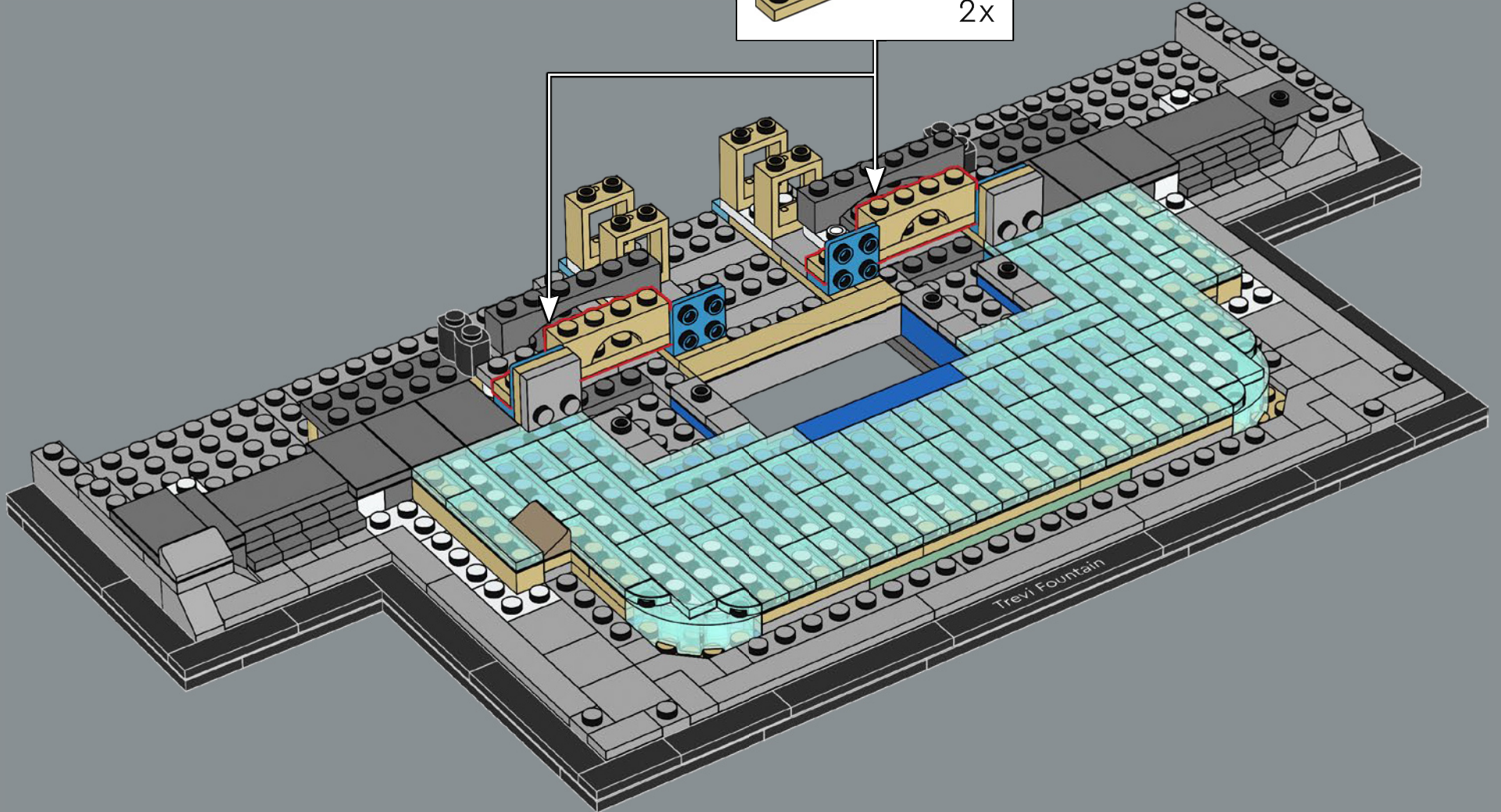
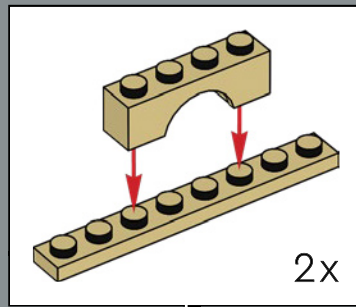

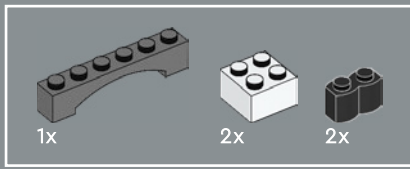

54

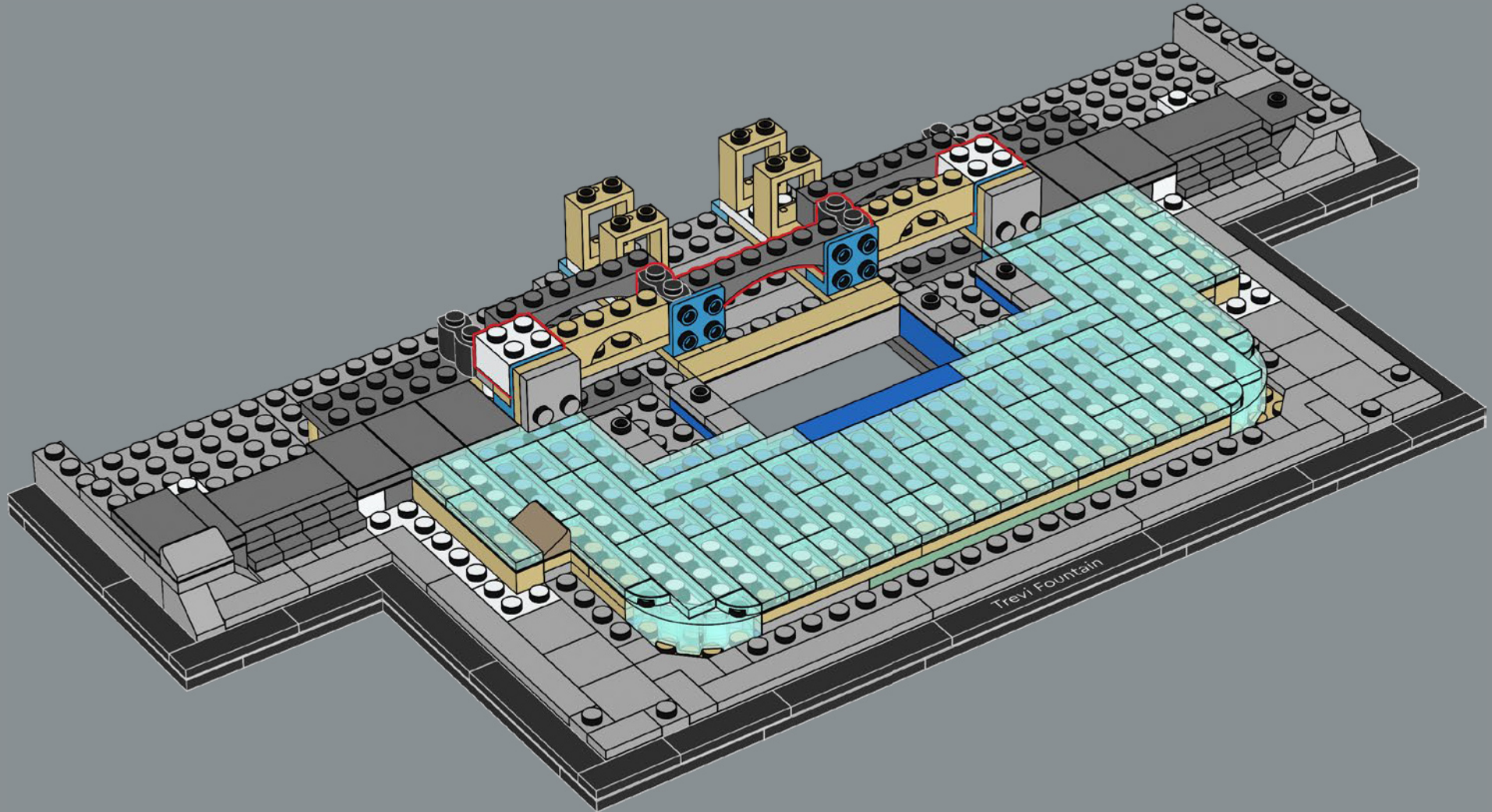

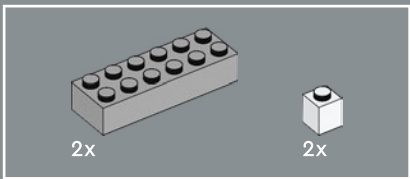

55

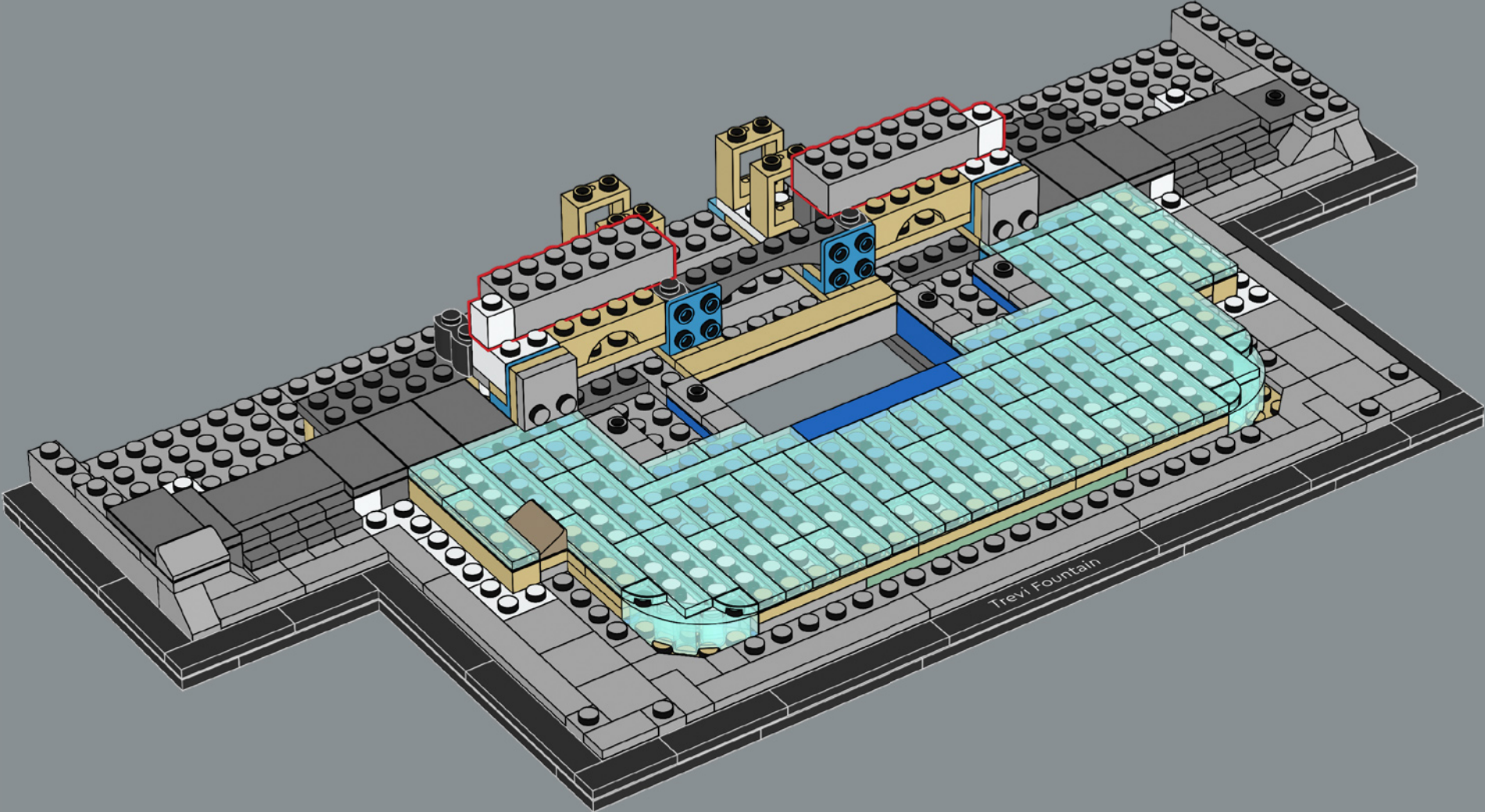

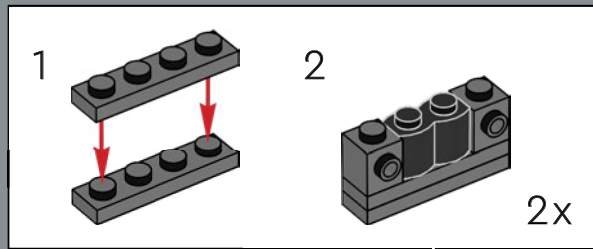
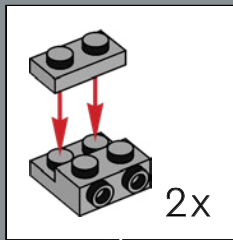
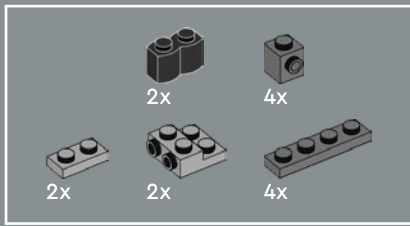

56

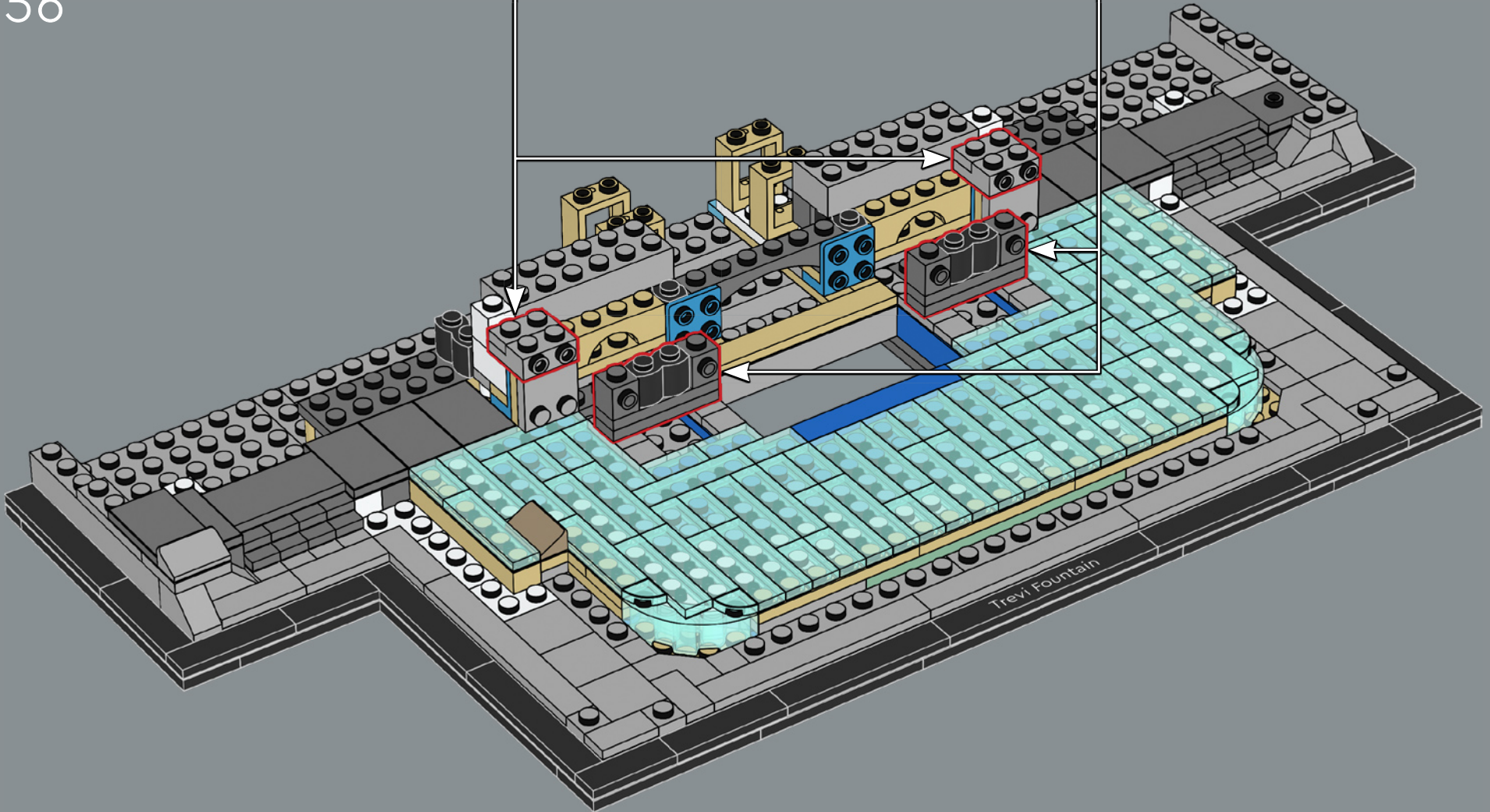

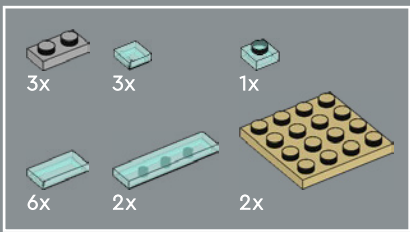

57

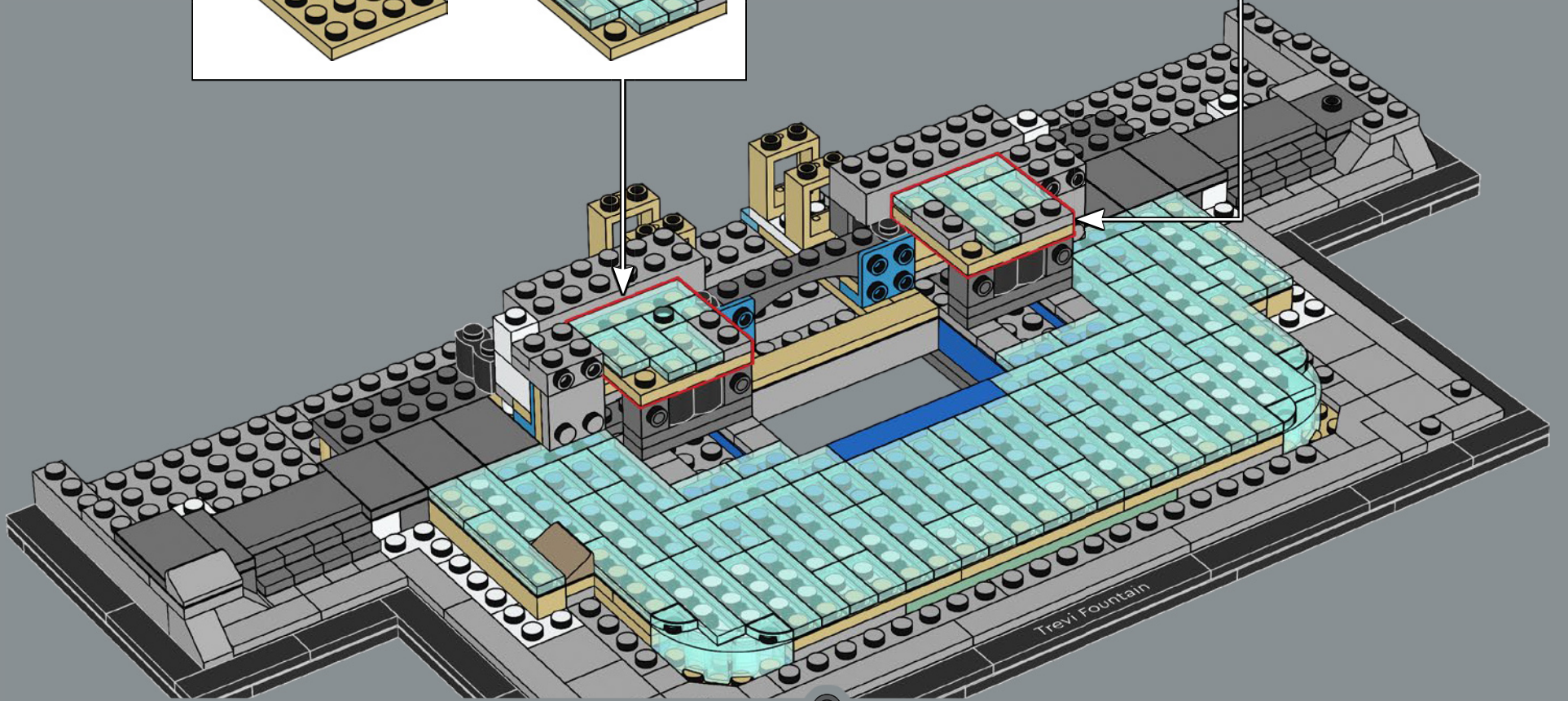
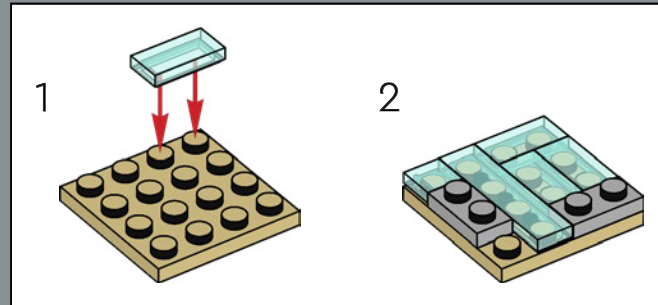
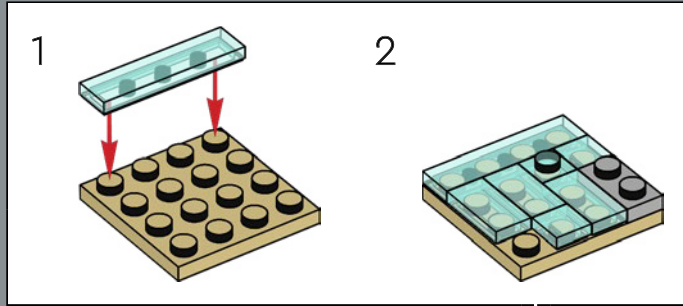

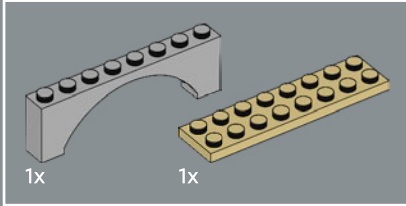
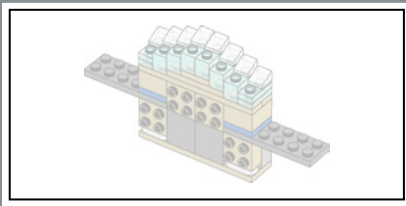

58

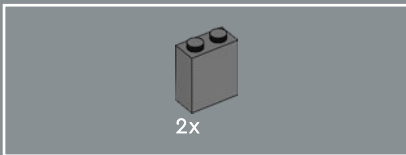
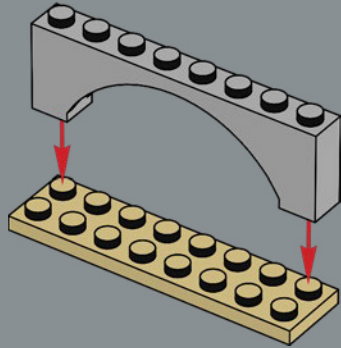

59

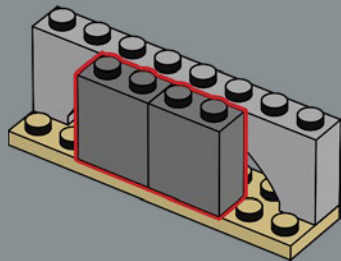

60

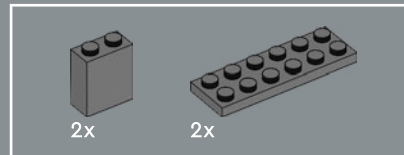
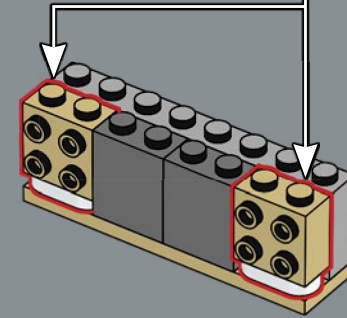
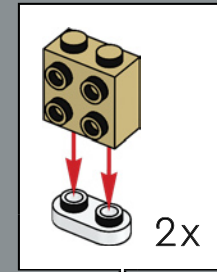

61

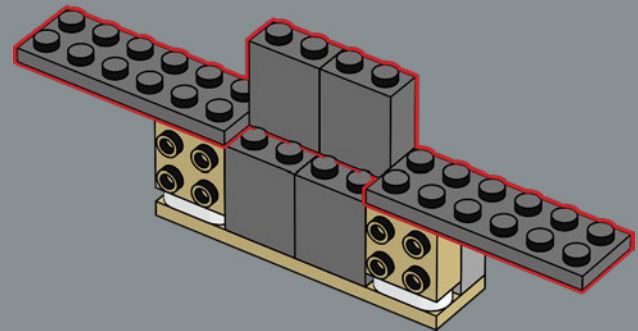

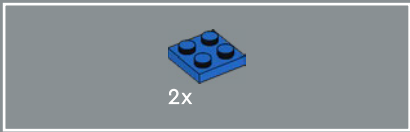

62

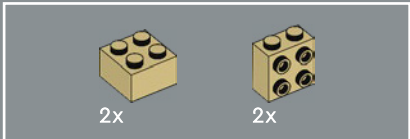
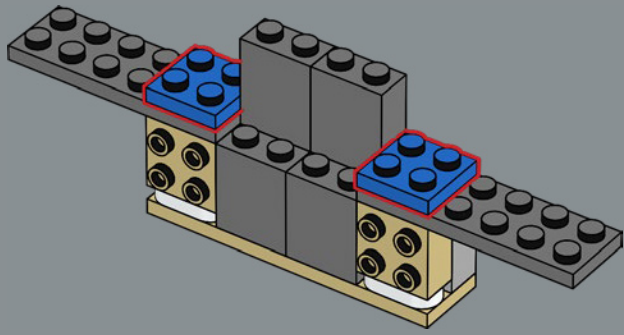

63

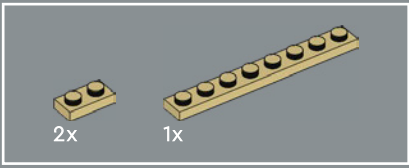
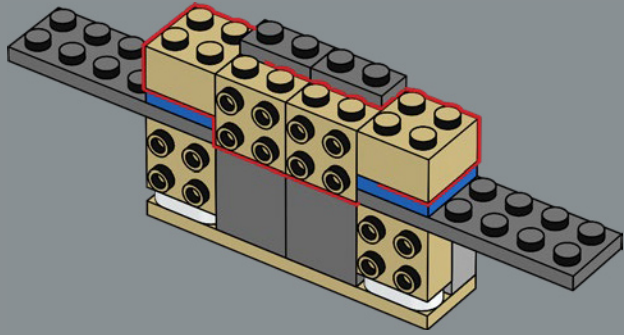

64

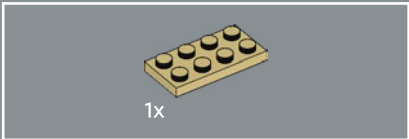
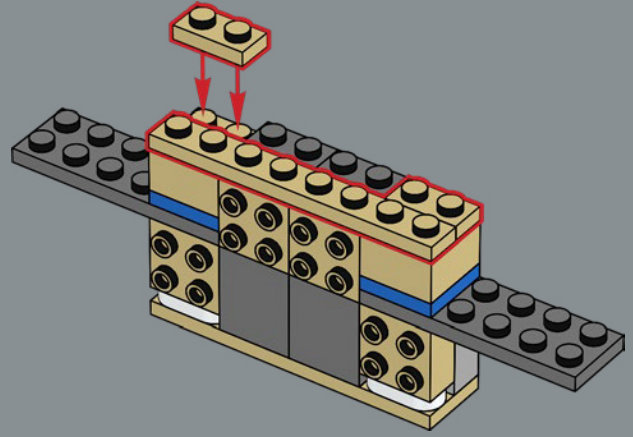

65

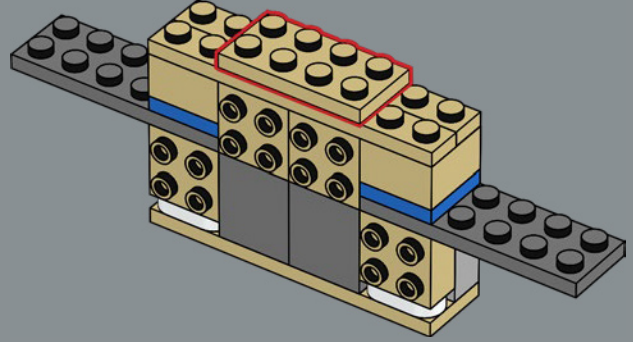



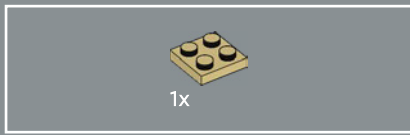

66

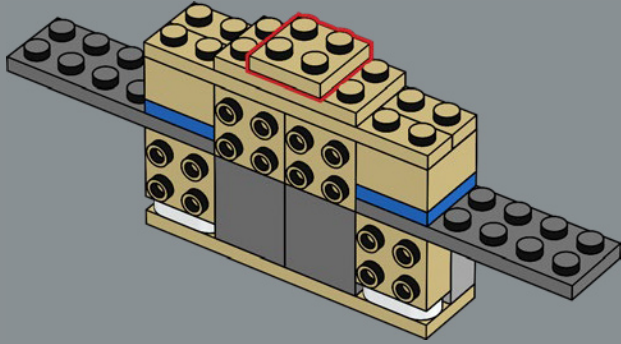

67

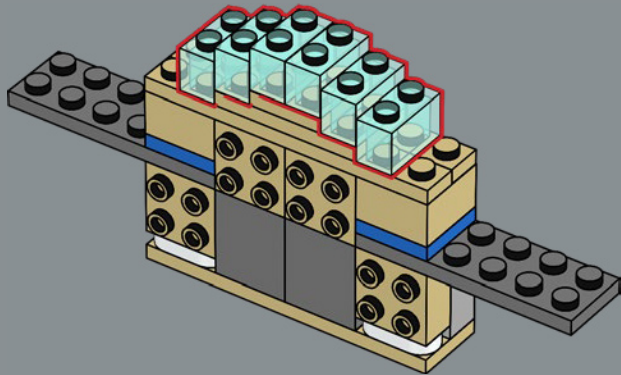

68

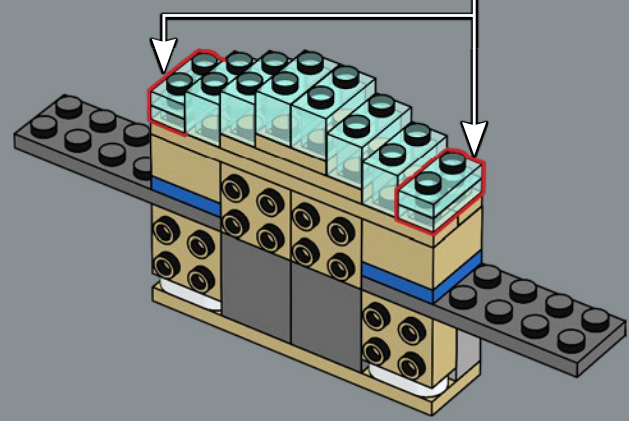
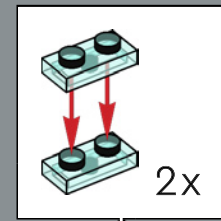

69

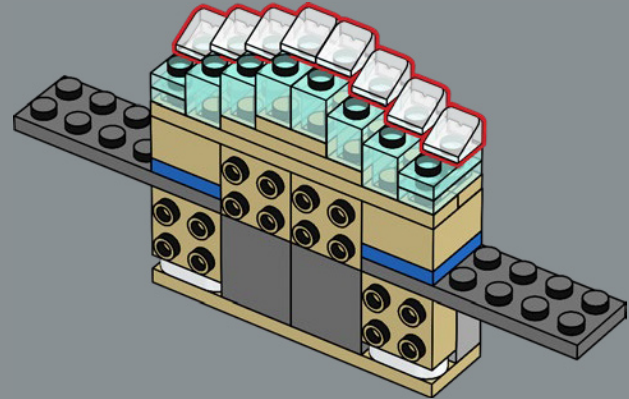

罗马许愿池建在古老的少女水道 (Acqua Vergine) 的尽头, 今天继续由渡槽为喷泉供水。

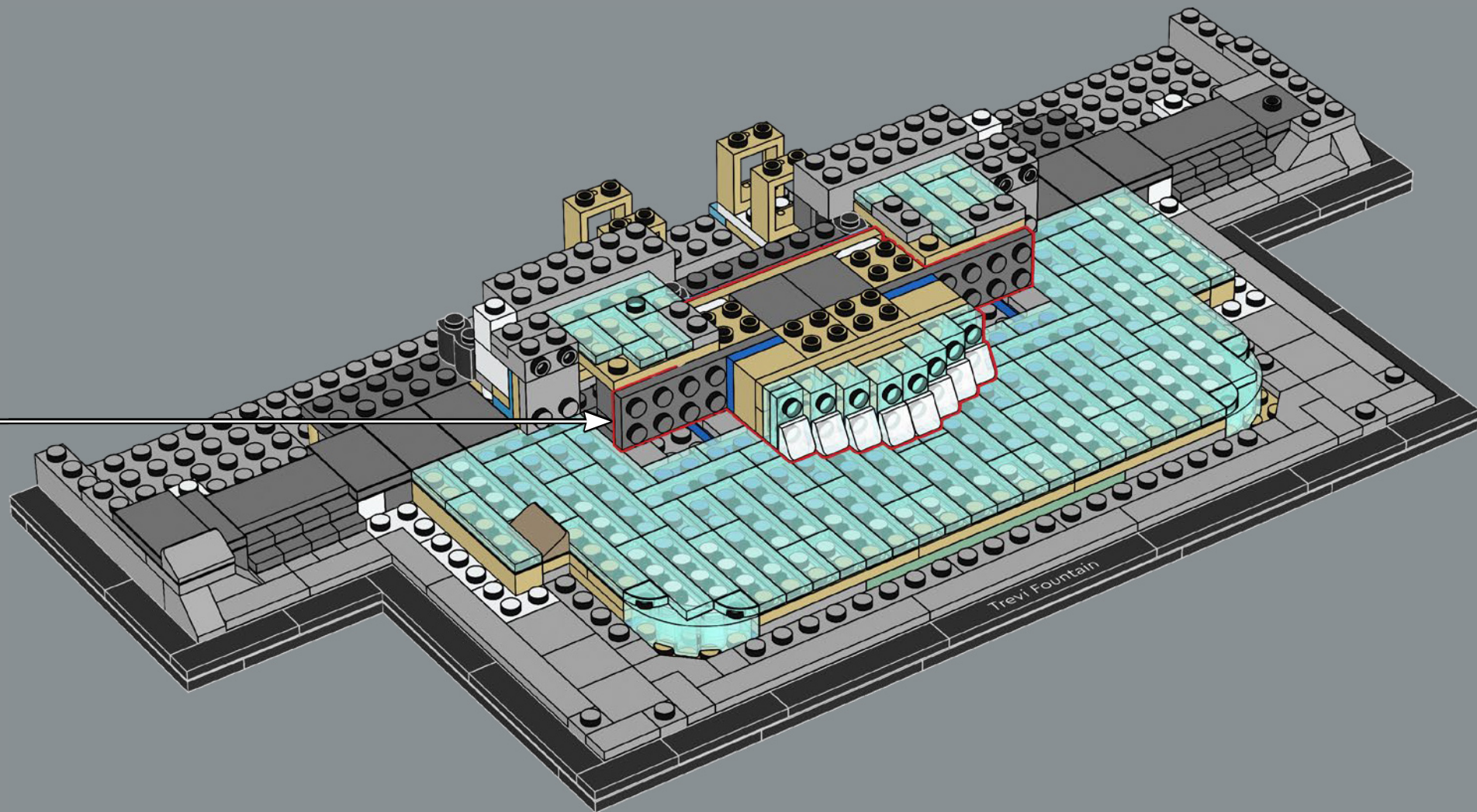



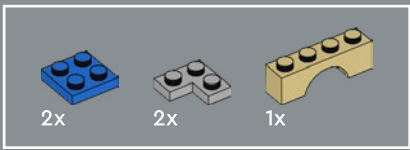

72

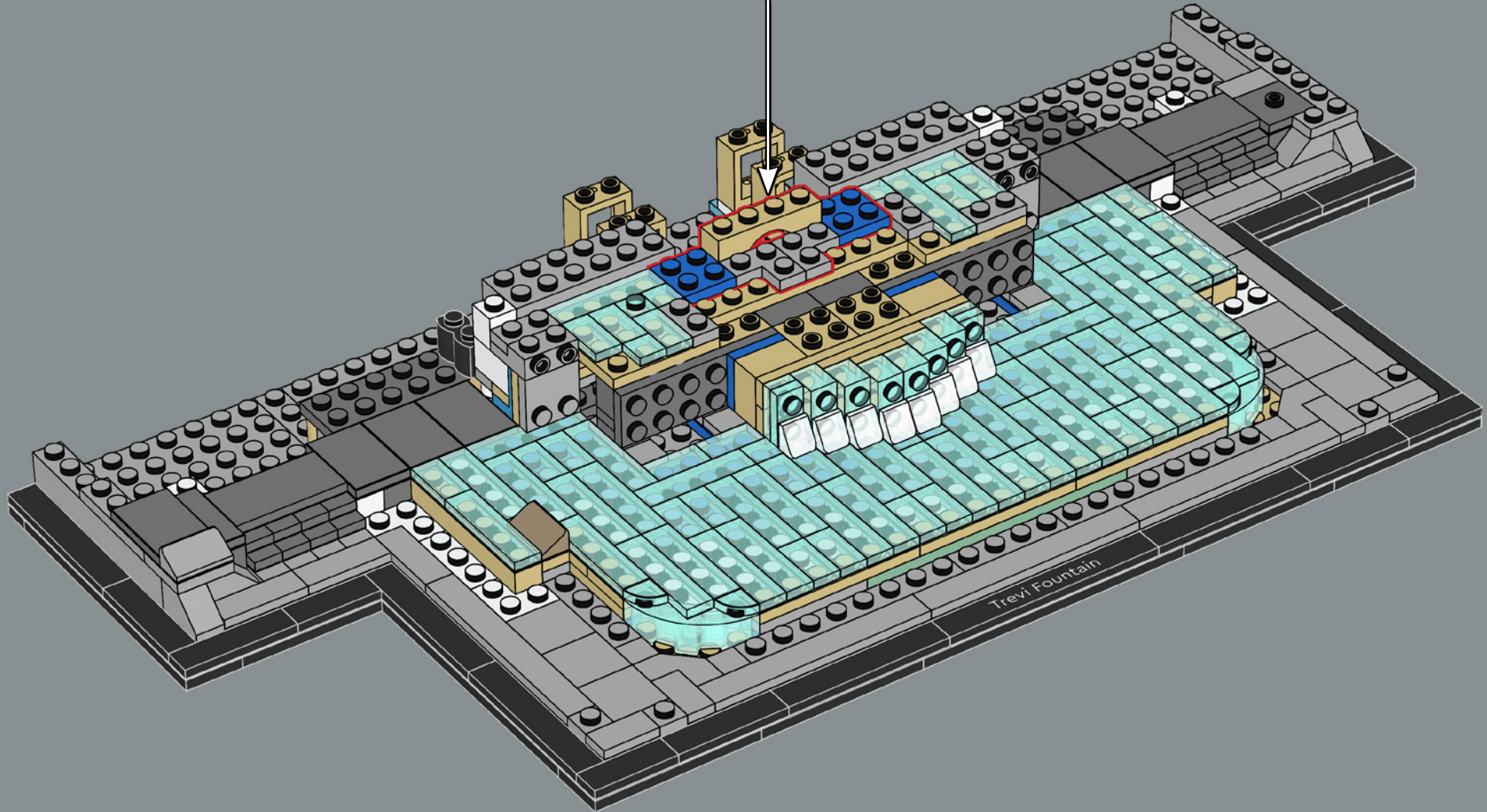
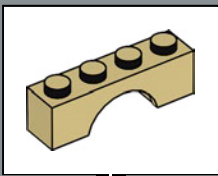

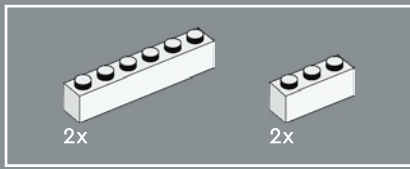

73

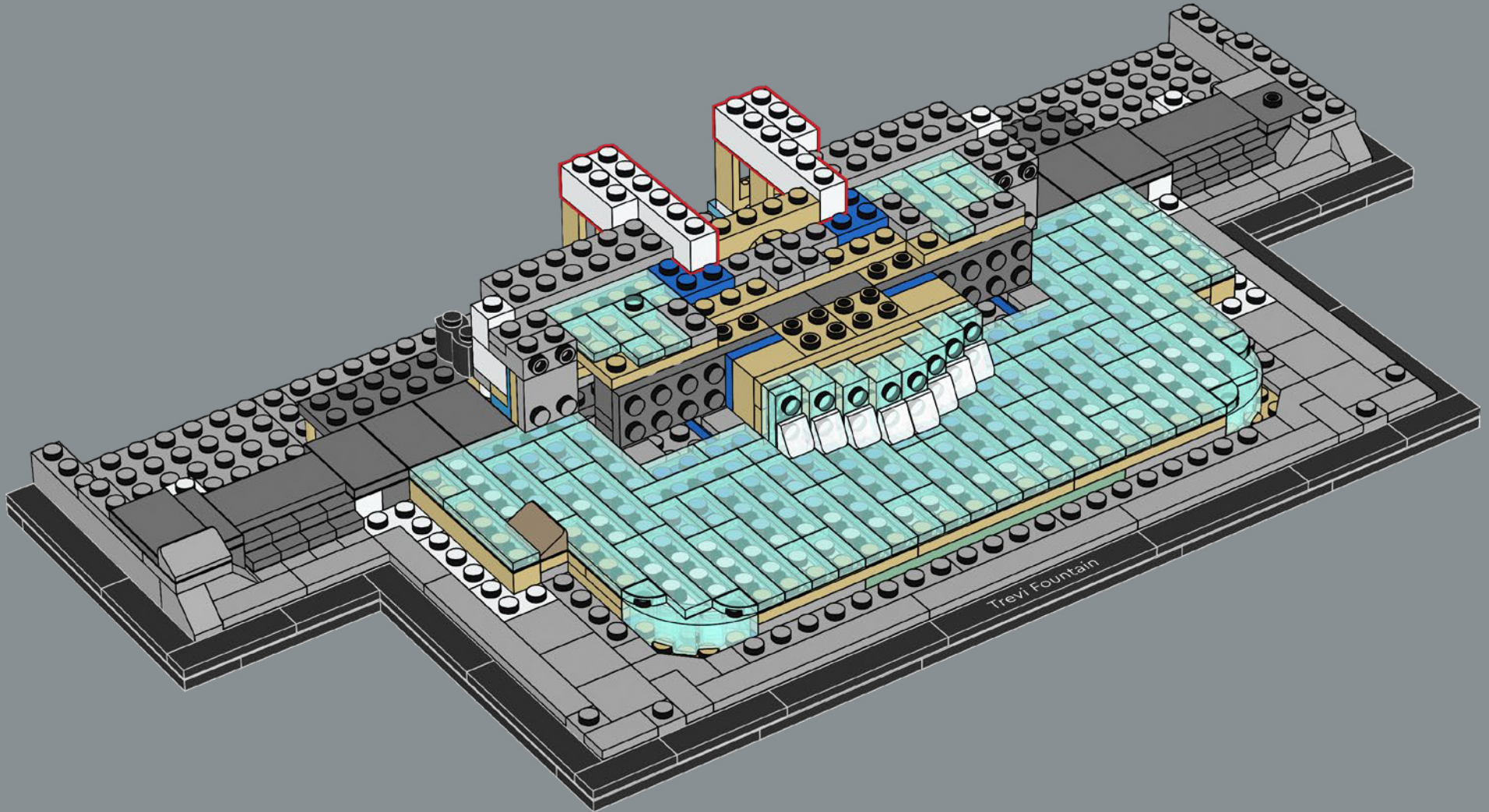

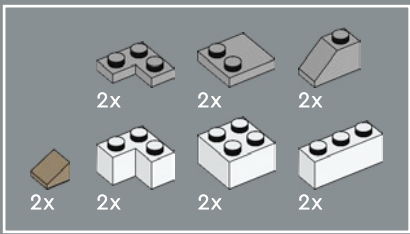

74

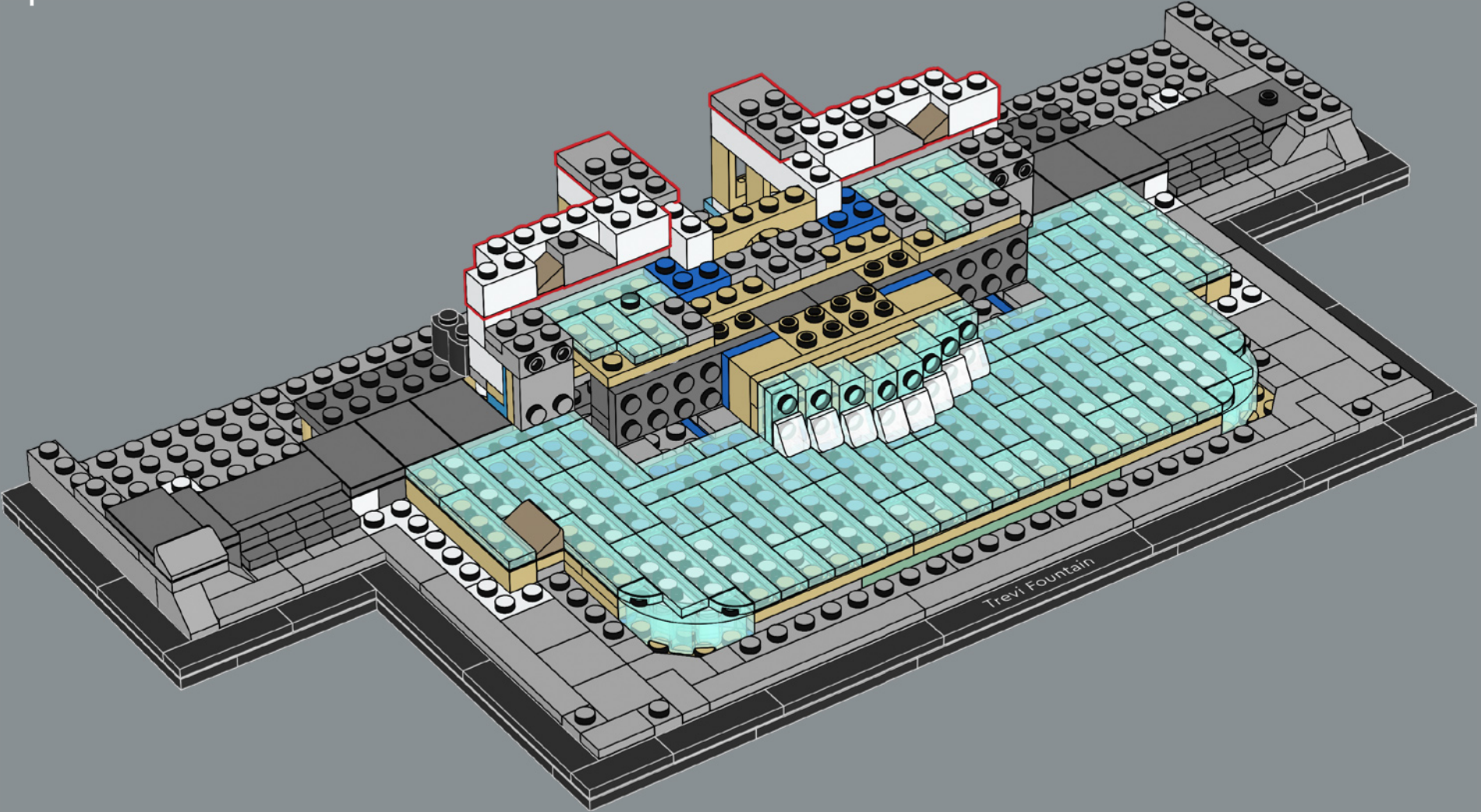

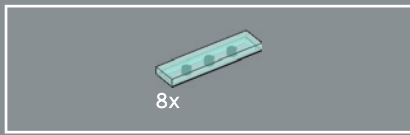

75

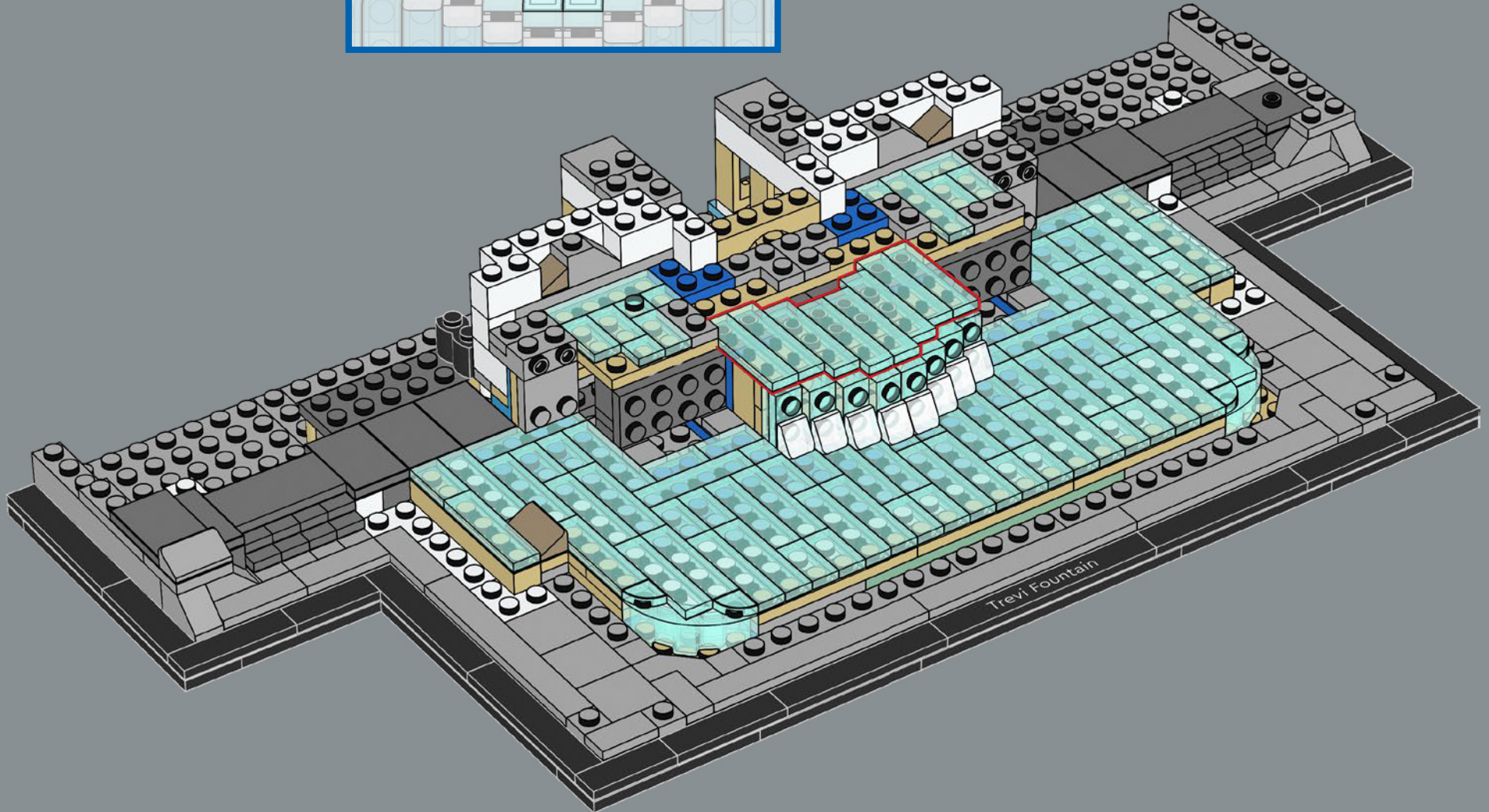
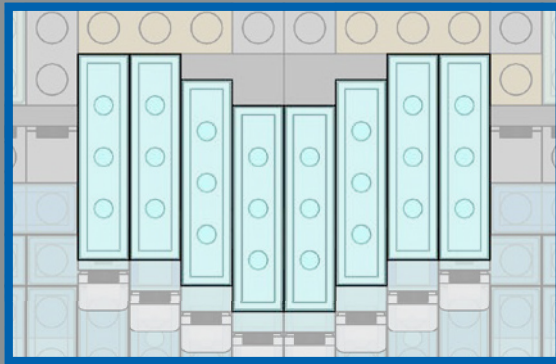

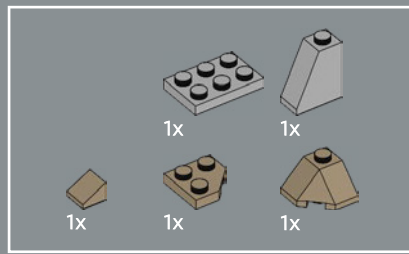

76

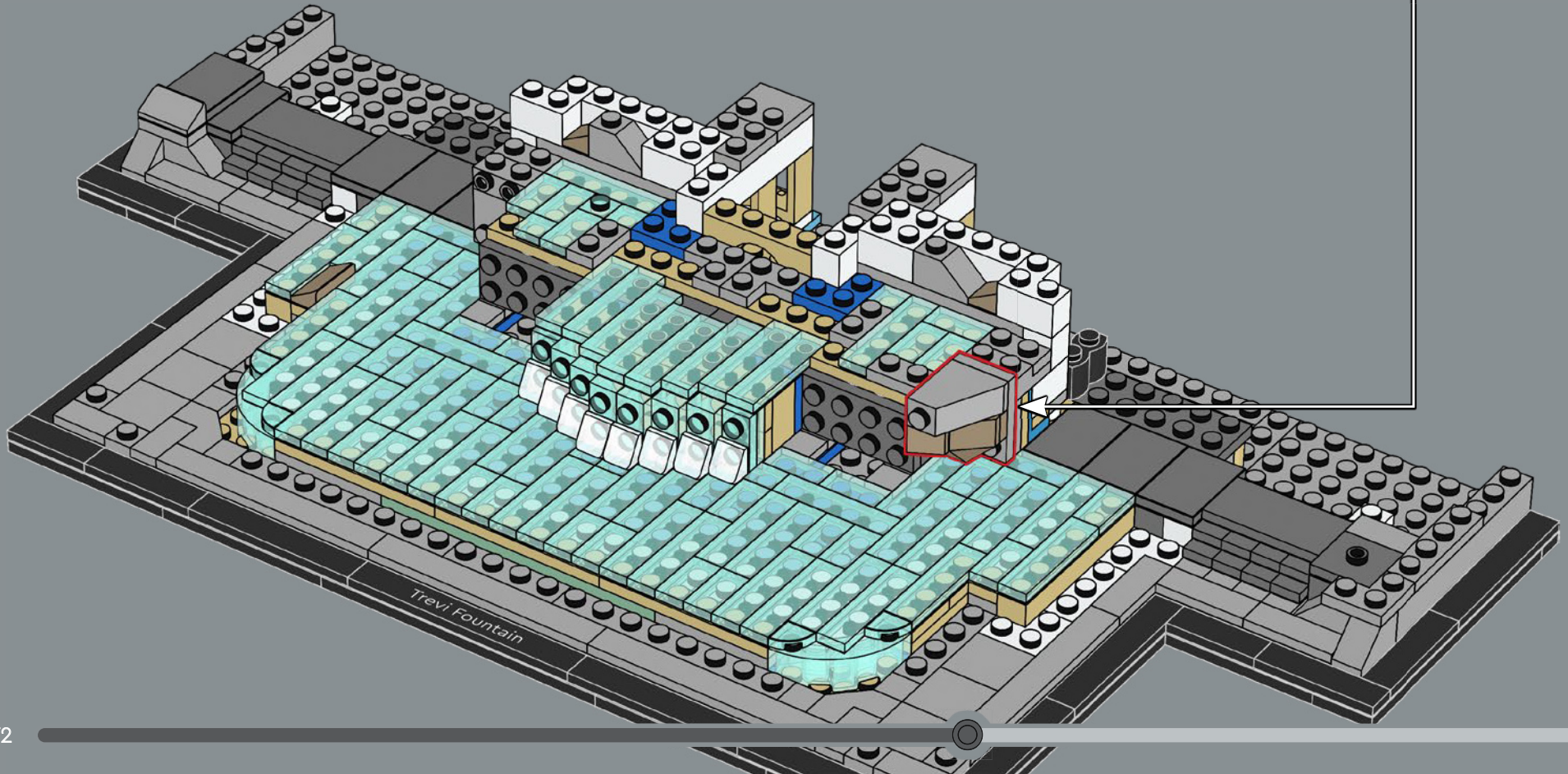
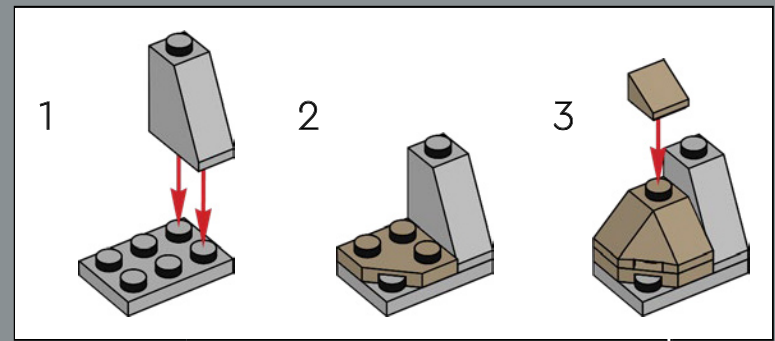



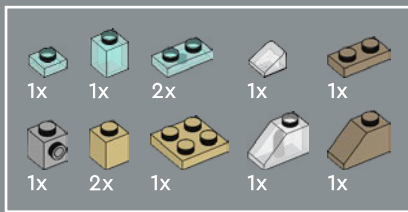

77

1

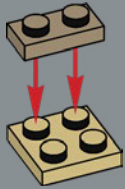

2

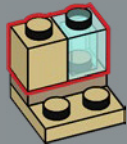

3

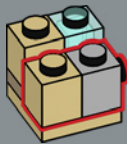

4



5



6

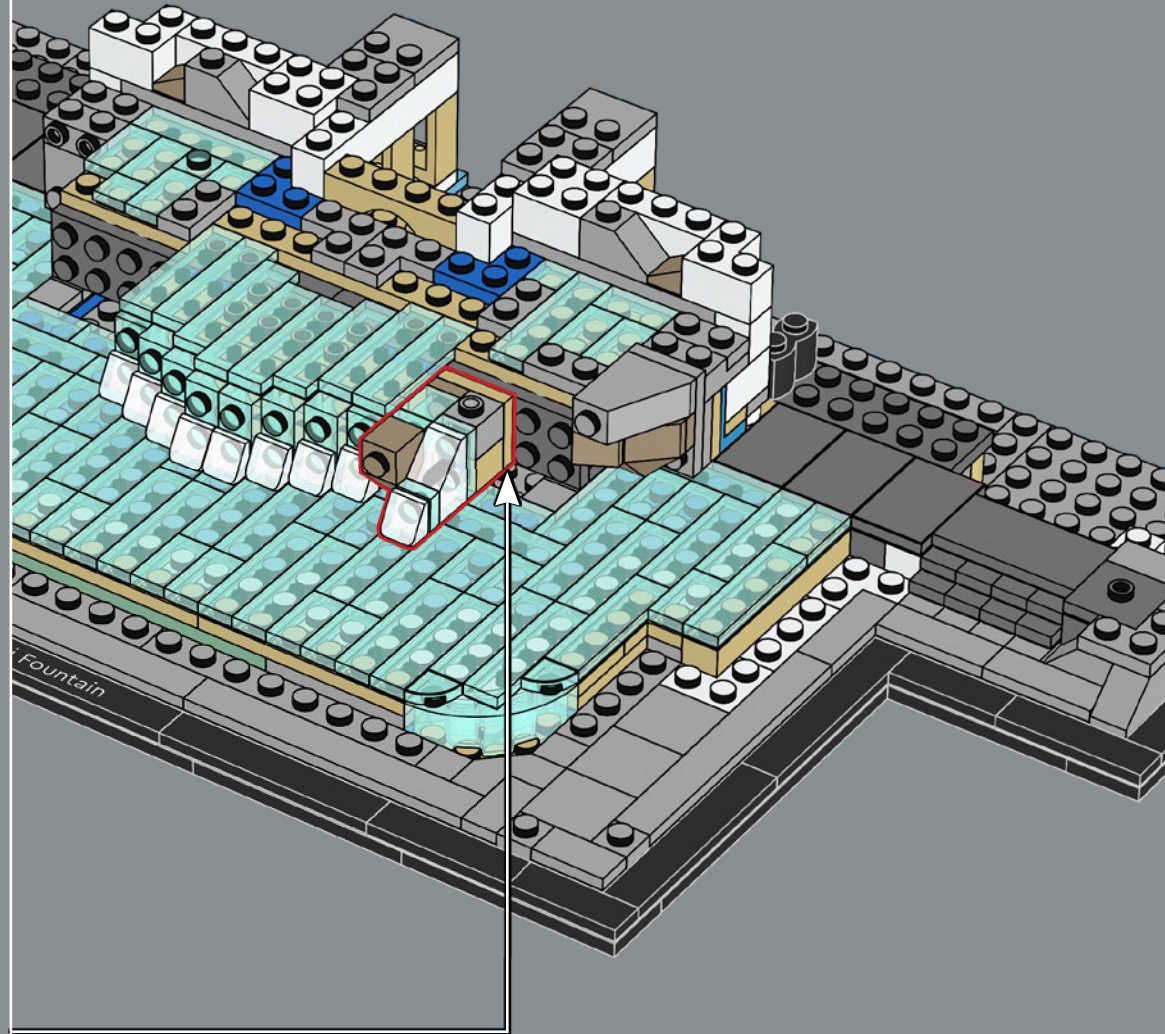

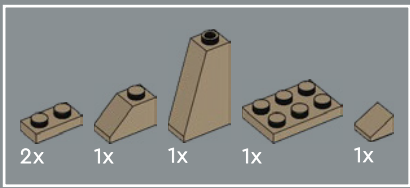

78

1

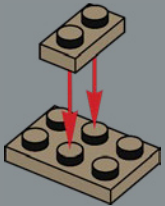

2

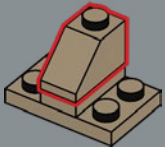

3

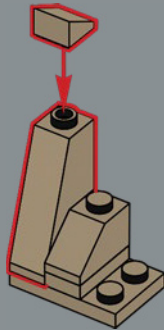

4

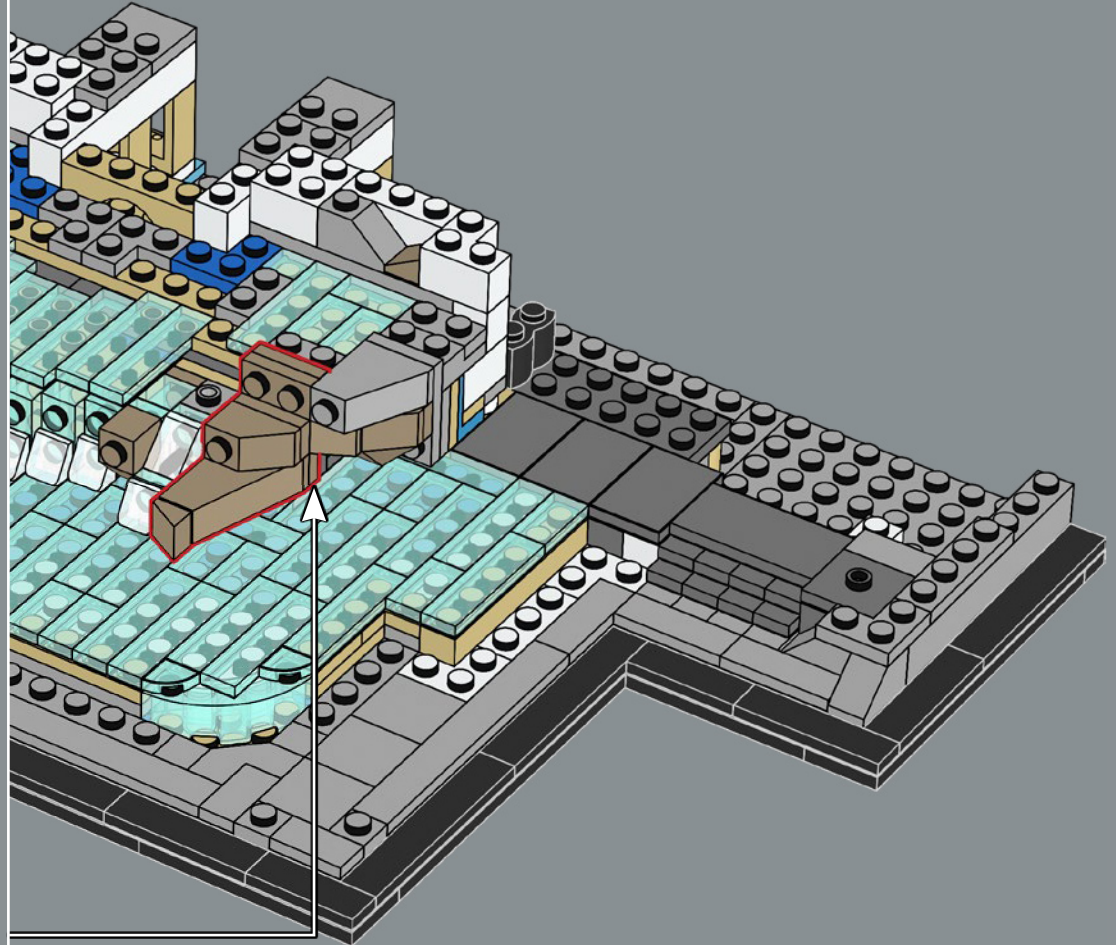
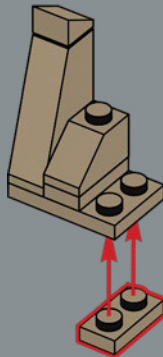

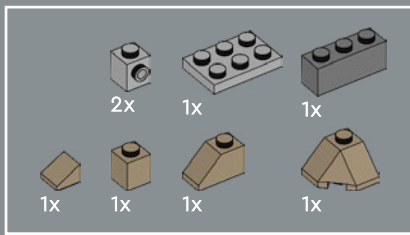

79

1

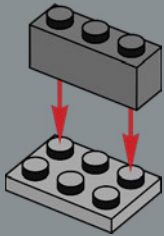

2

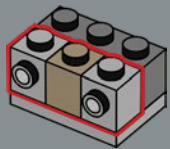

3

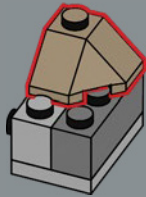

4

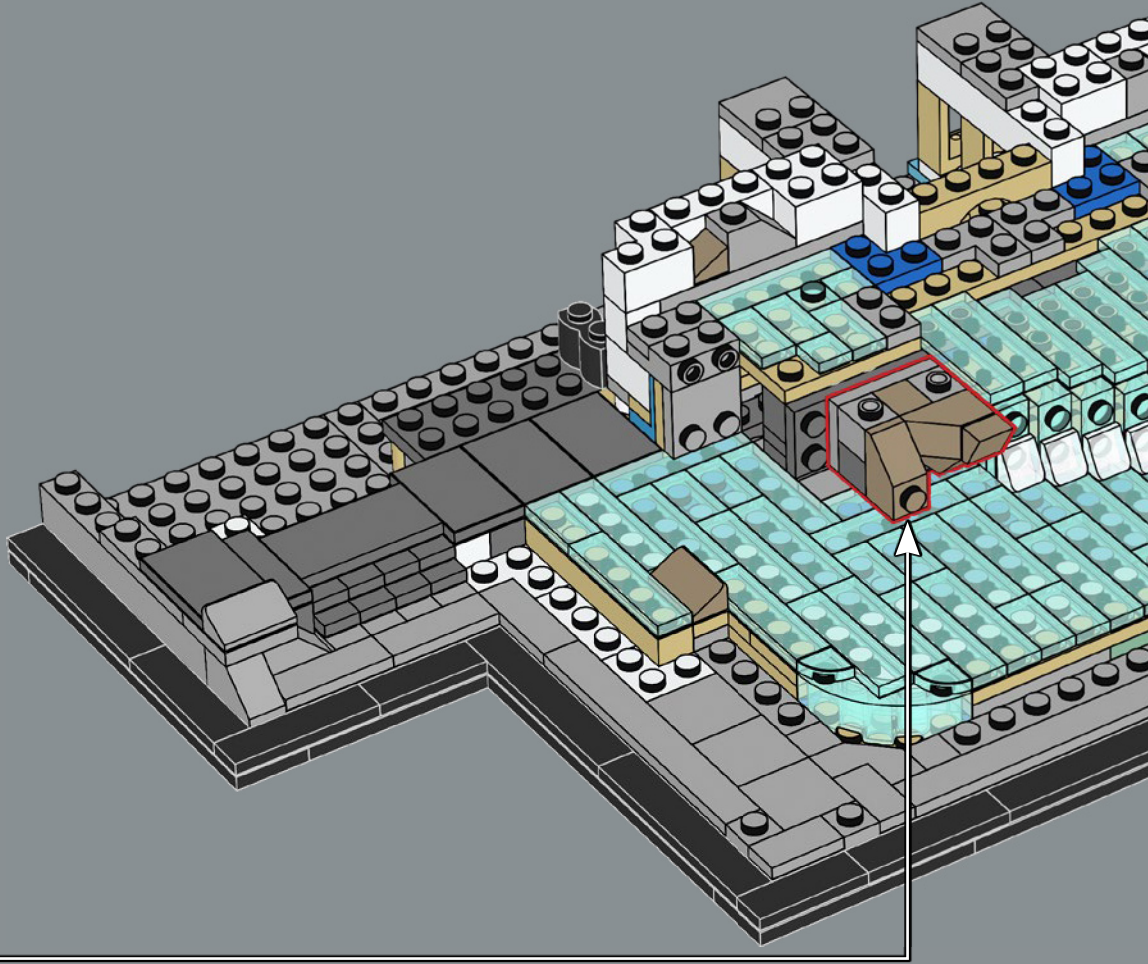
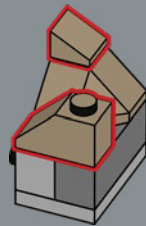

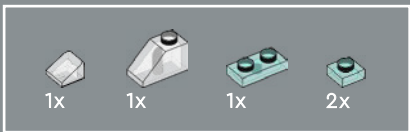

80

1

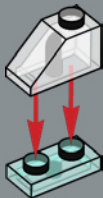

2

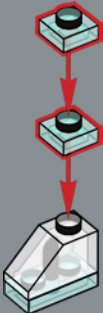

3

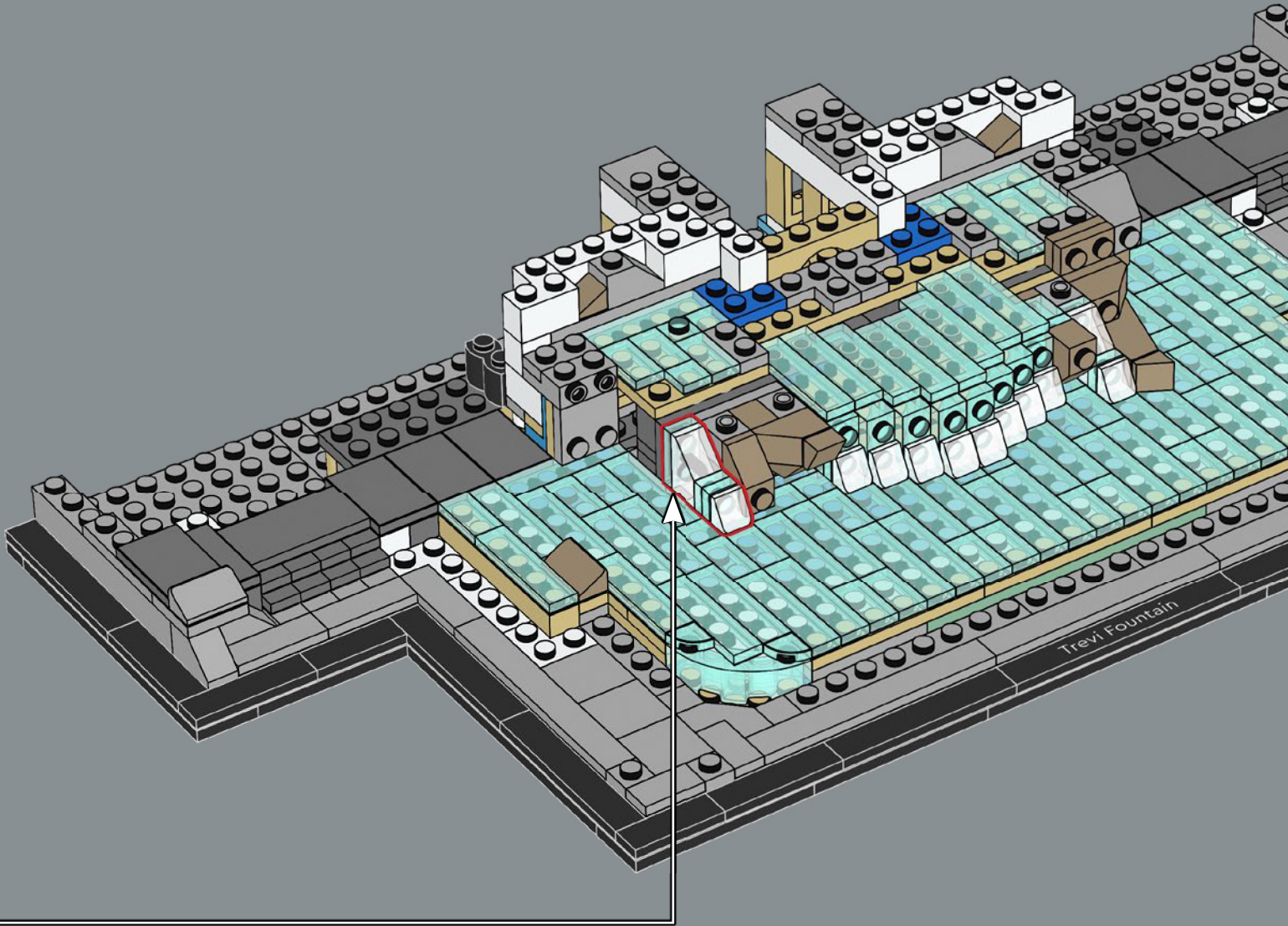

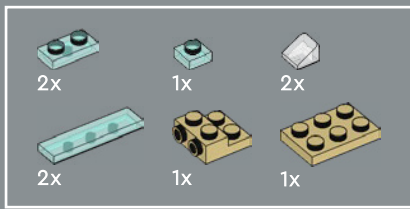

81

1

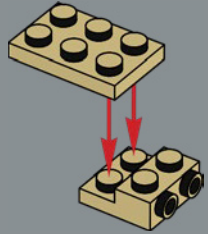

2

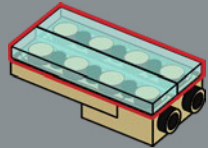

3

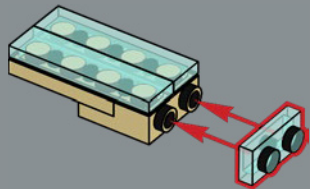

4

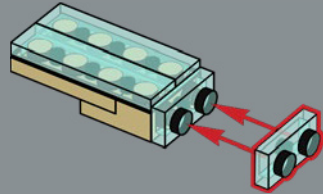

5

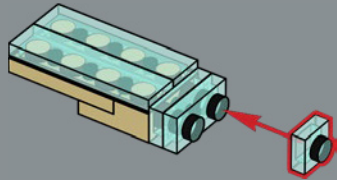

6

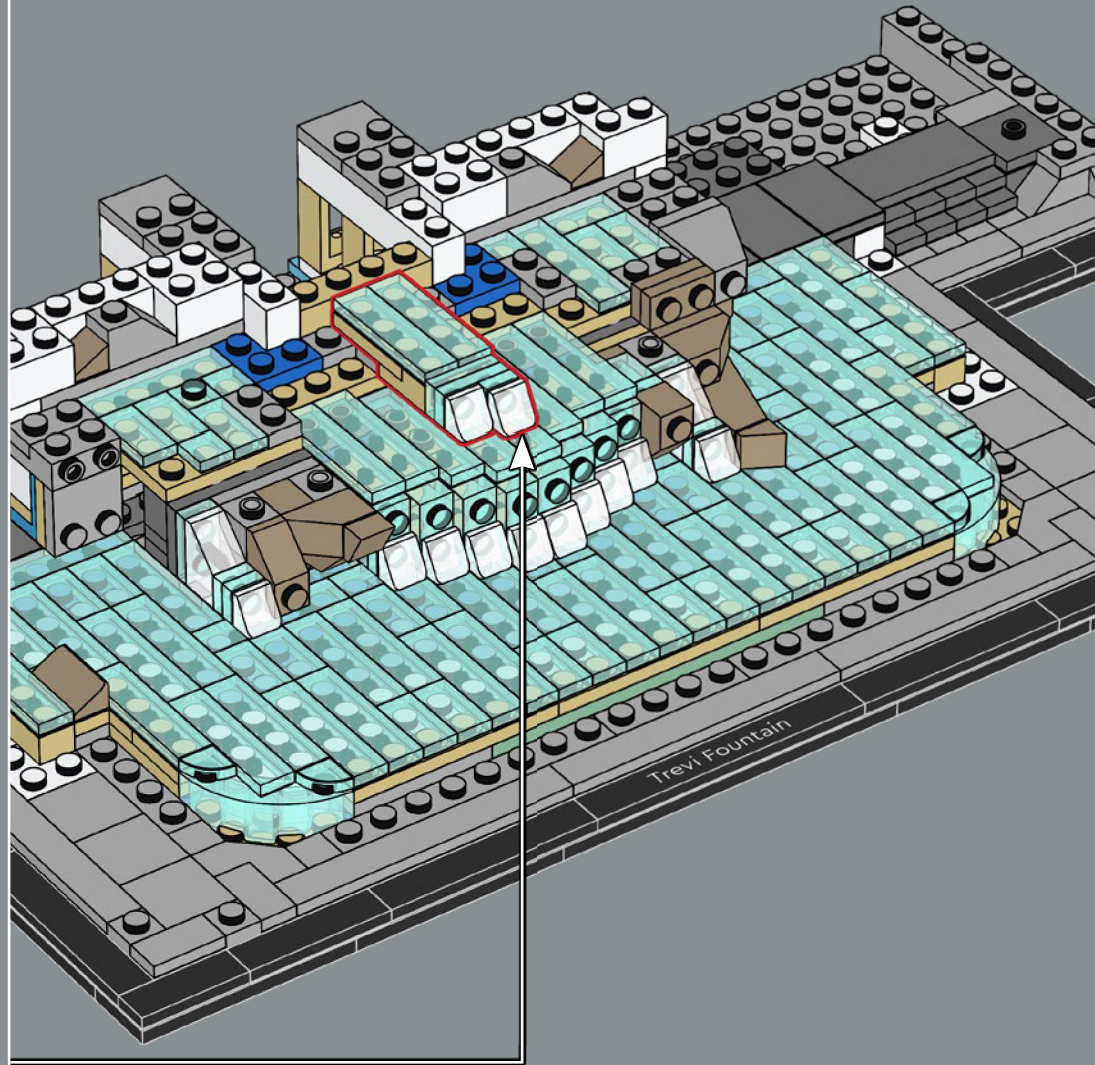
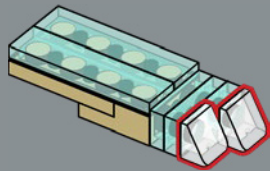

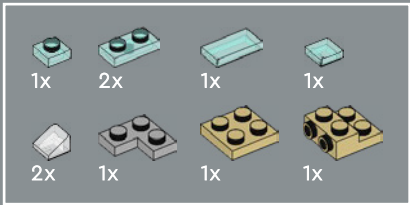

82

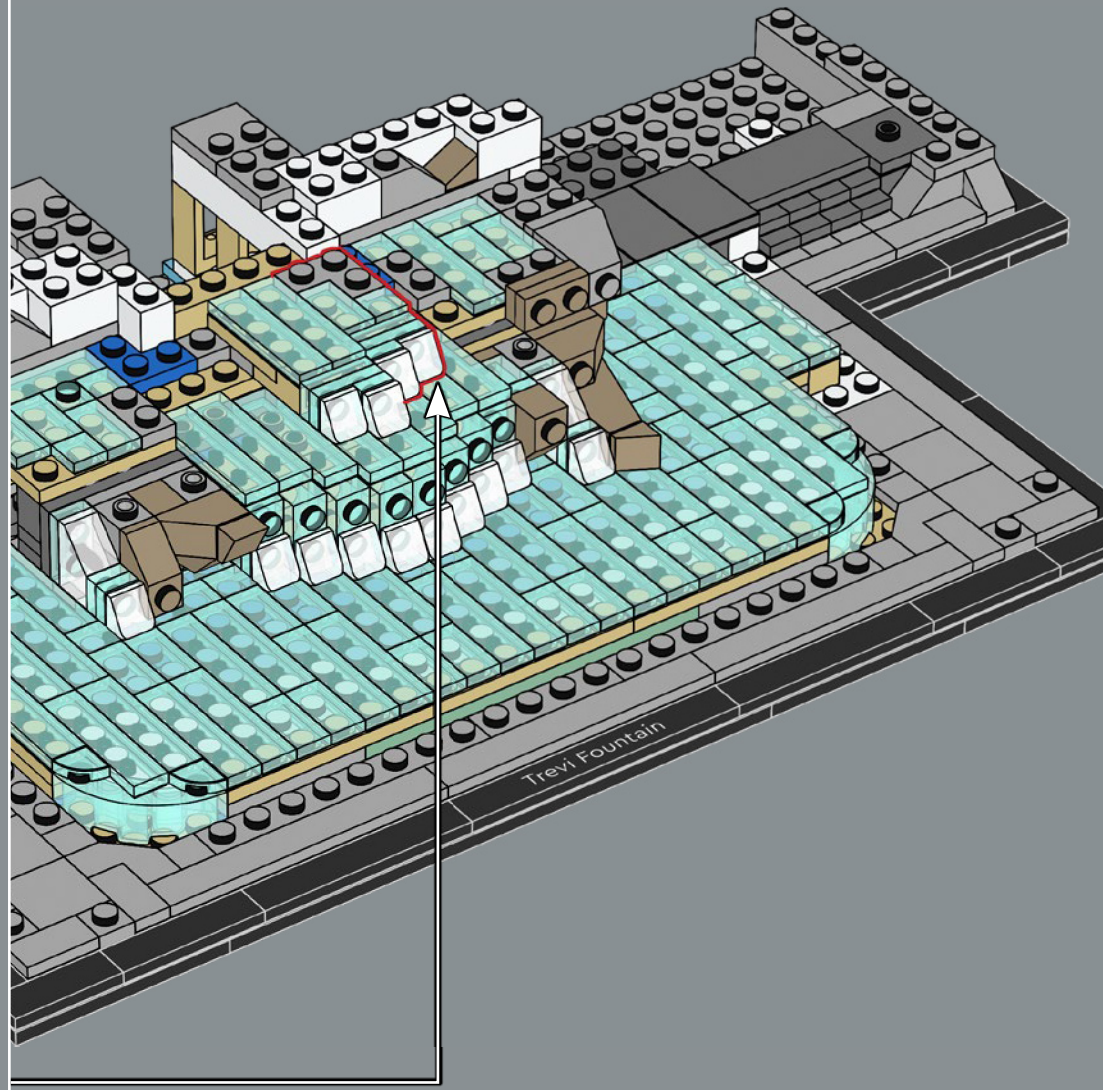
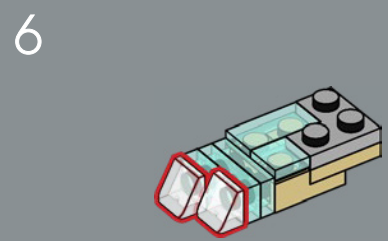
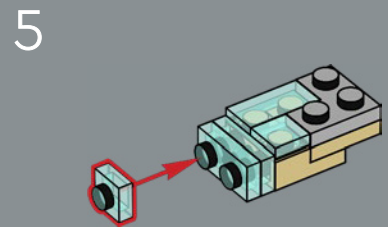
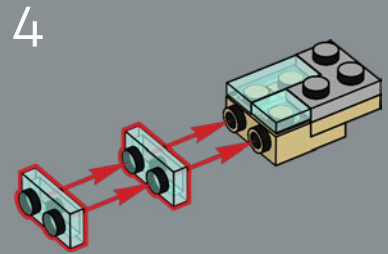
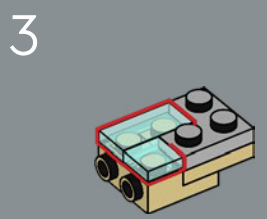
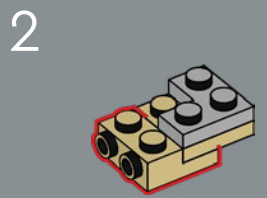
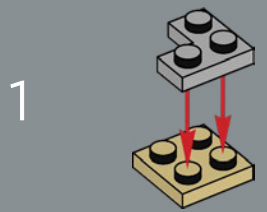

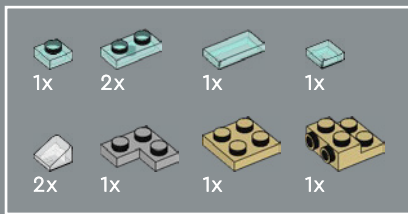

83

1

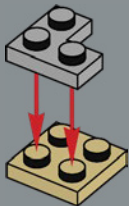

2

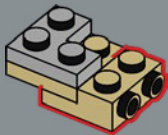

3

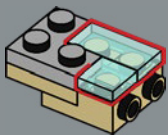

4

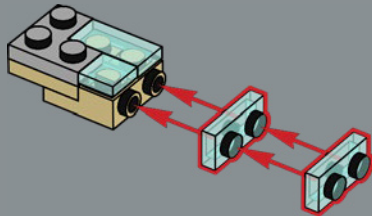

5

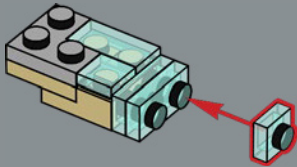

6

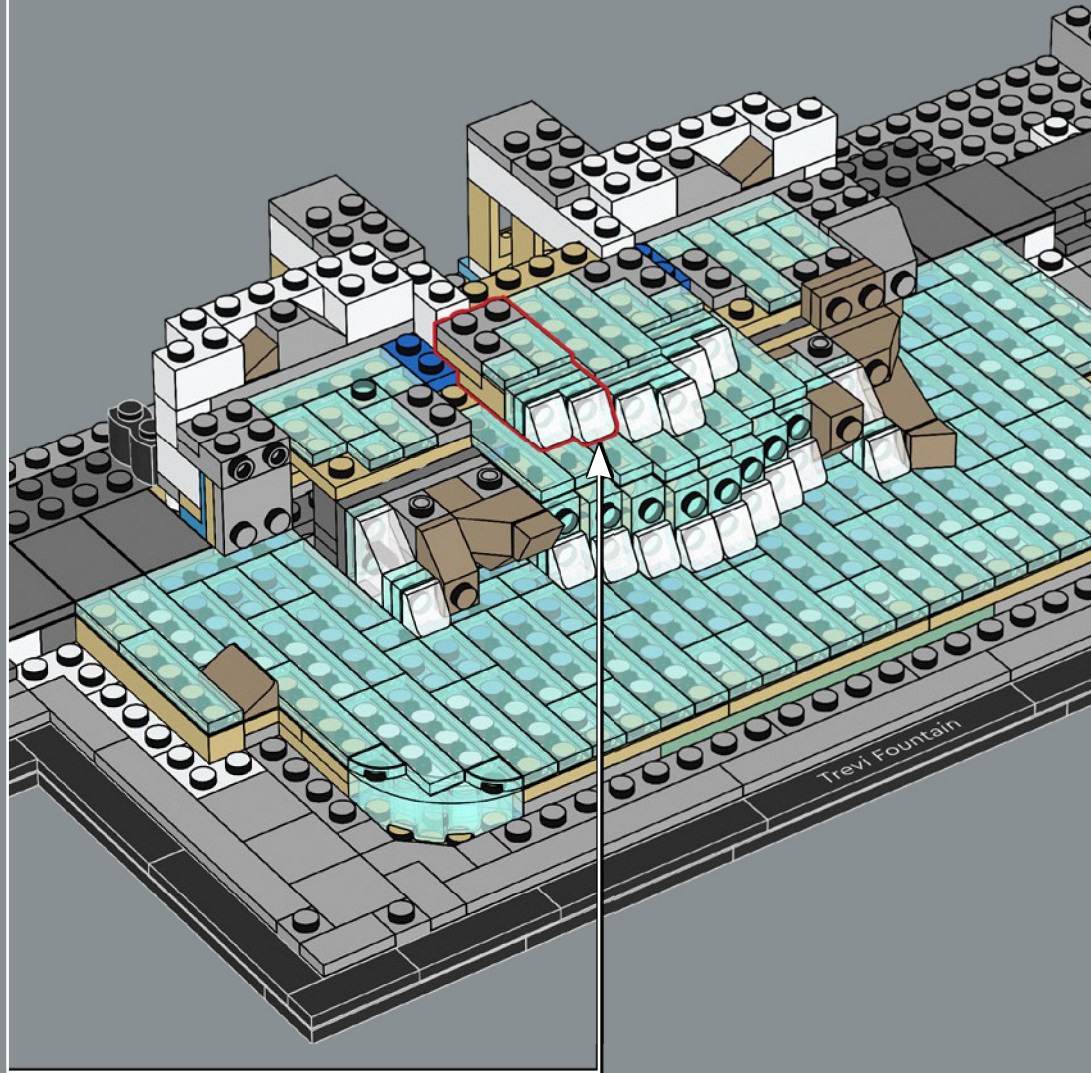
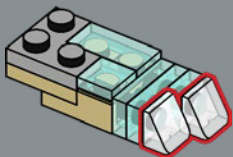

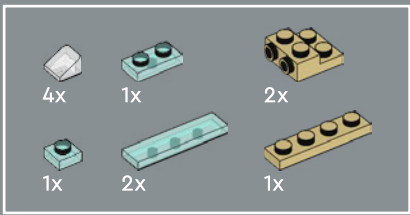

# 84

1

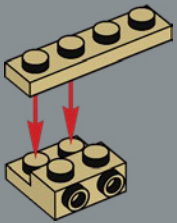

2

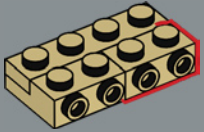

3

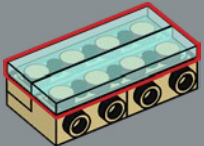

4

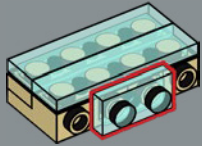

5

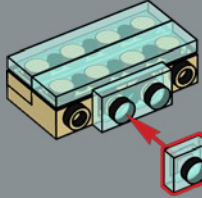

6

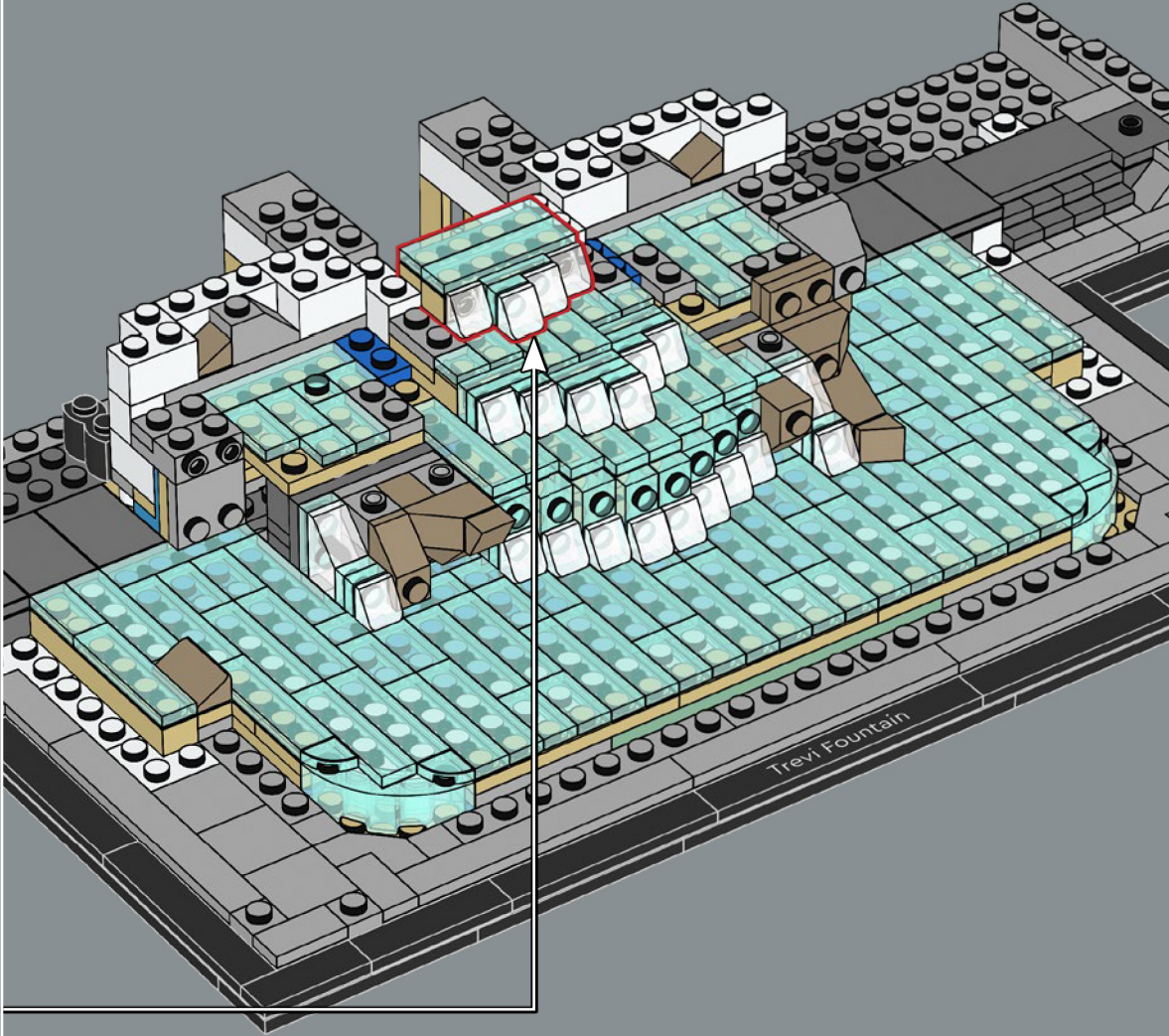





透明蓝色下面的颜色展现了真实喷泉的颜色。  
在上部, 泉水浅浅地流过岩石, 露出下面石头的  
颜色, 但在水池的下部, 深度通过较深的蓝色色  
调展示。

85

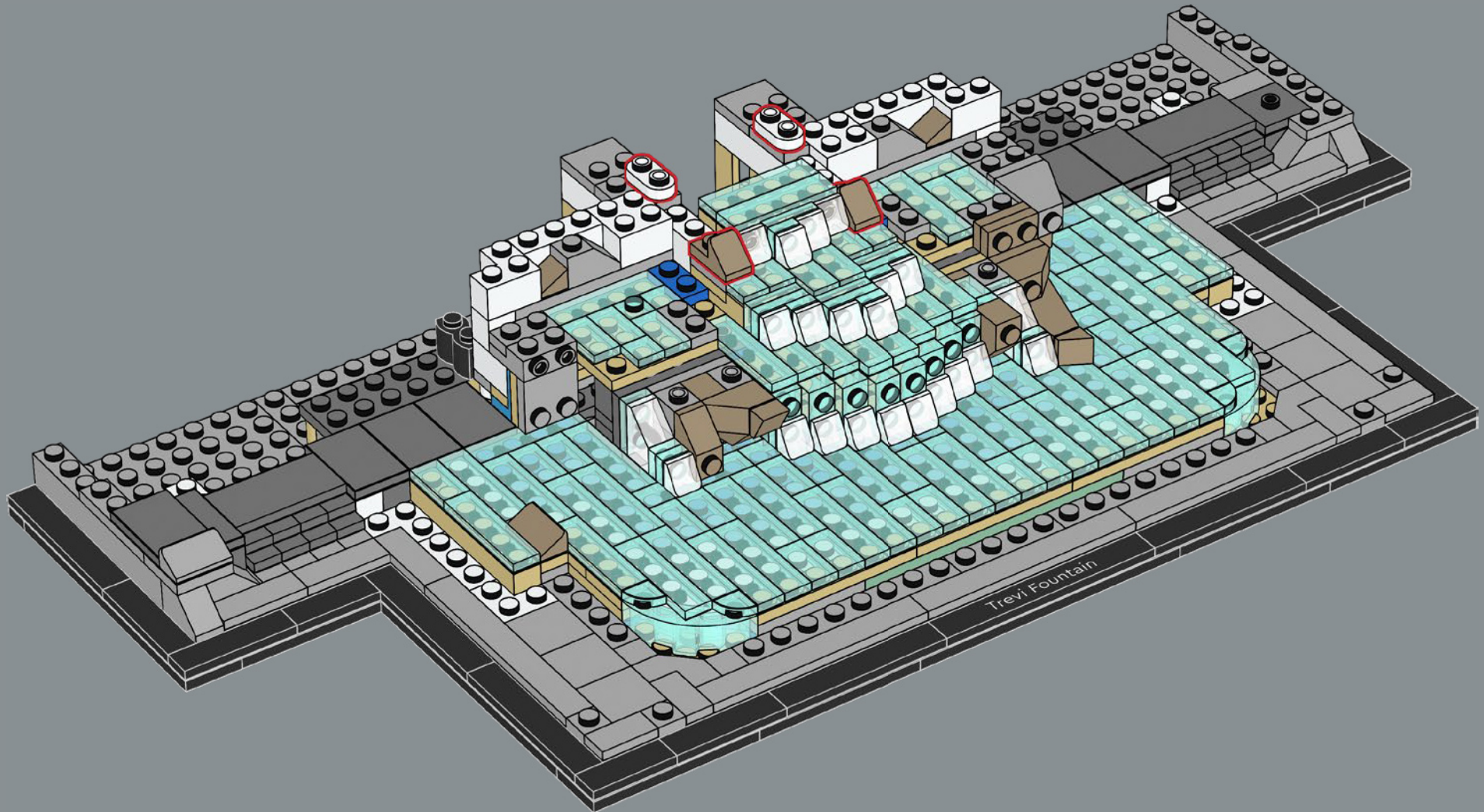

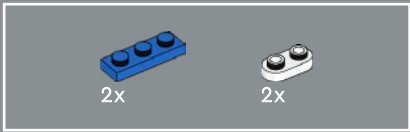

86

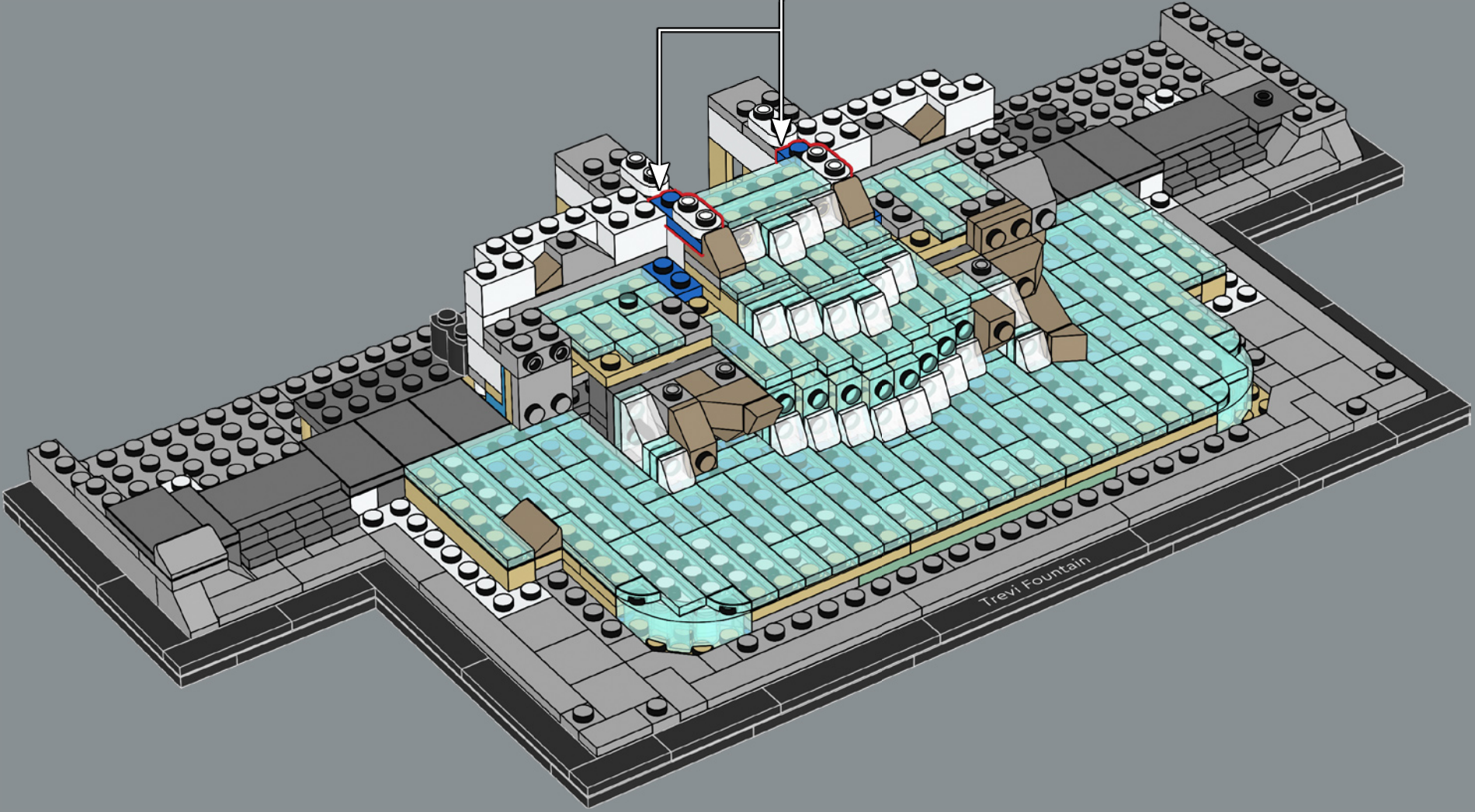
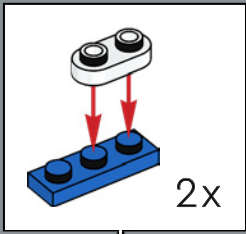

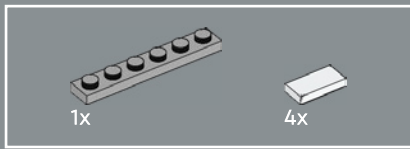

87

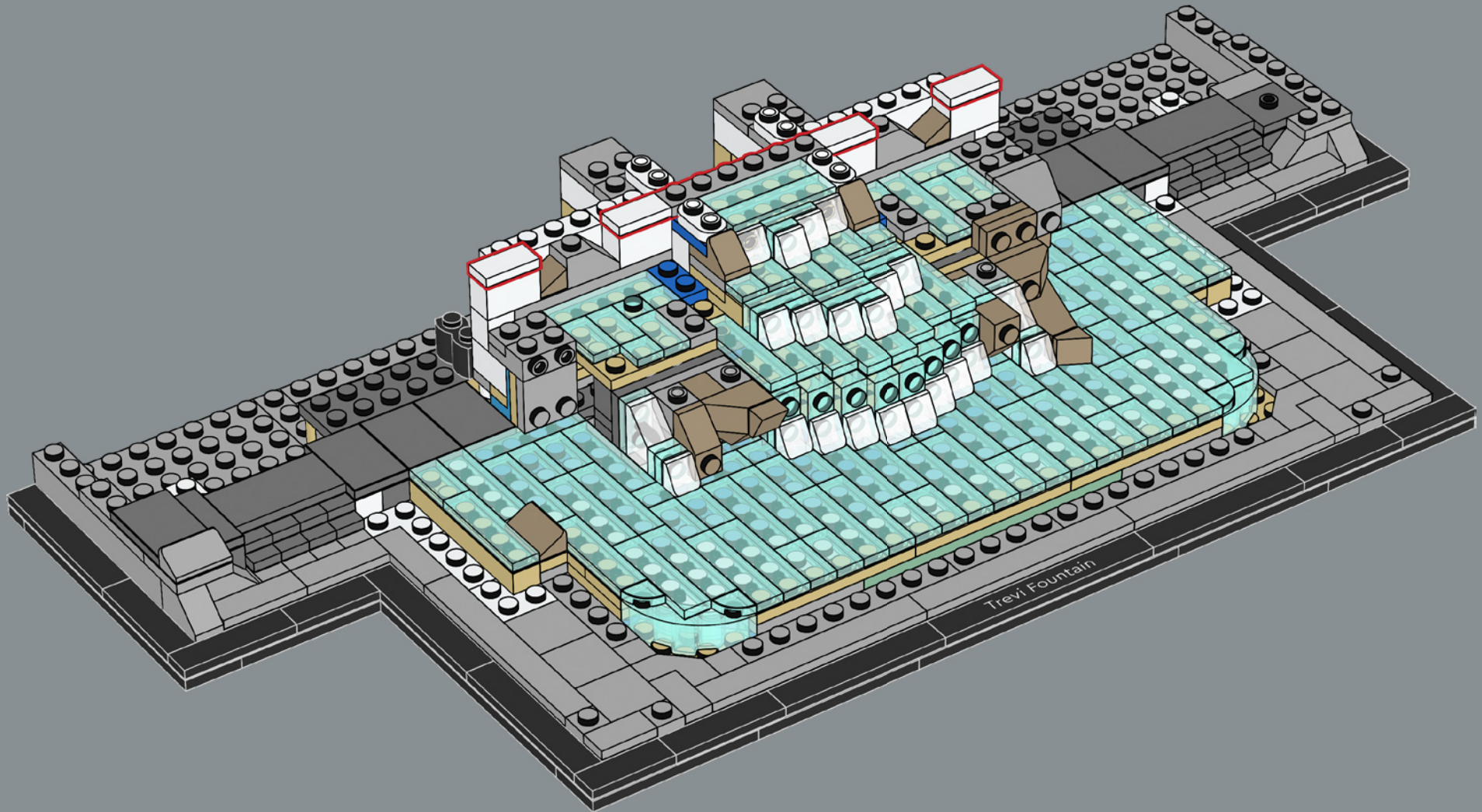

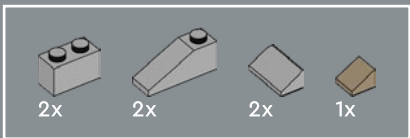

88

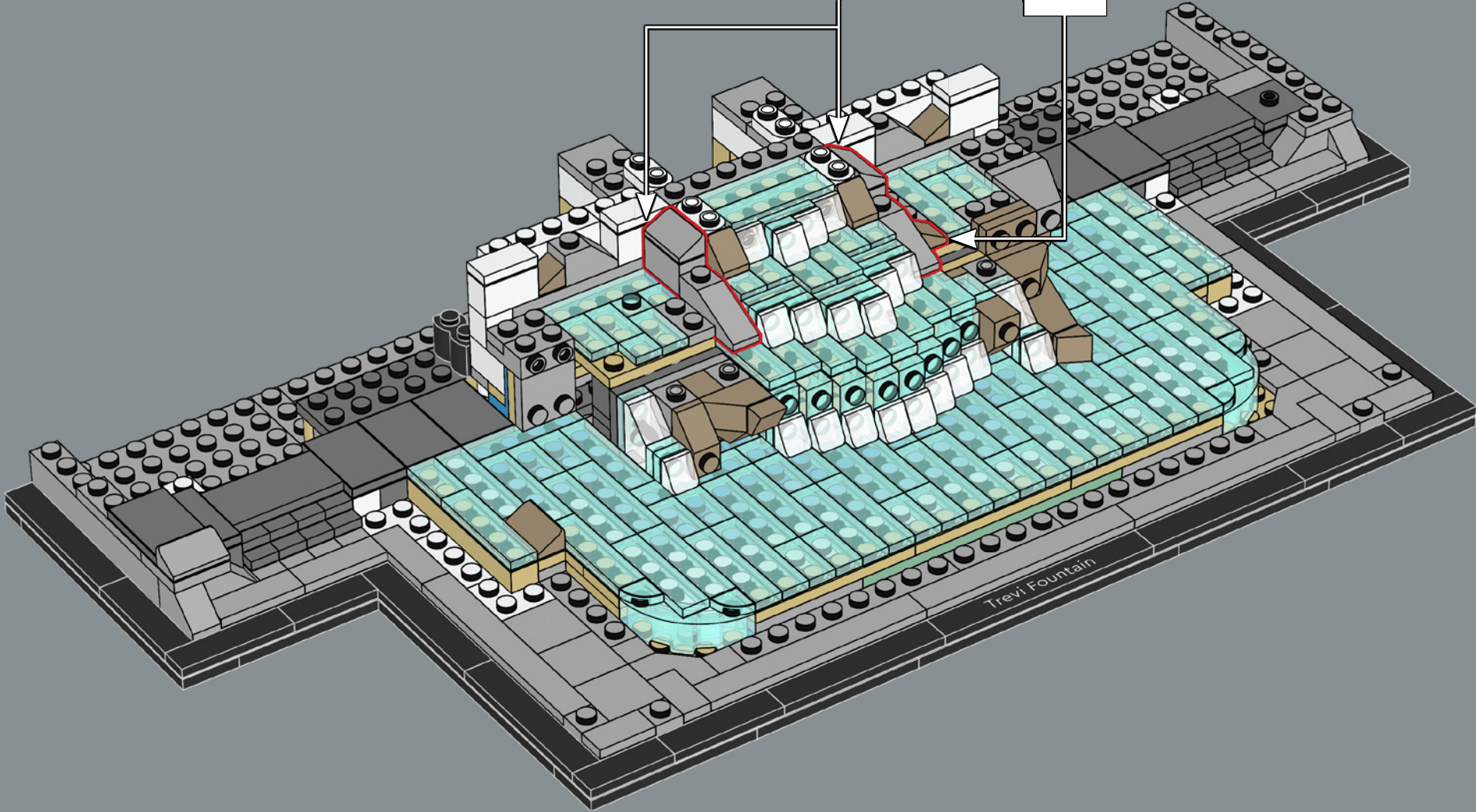
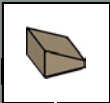
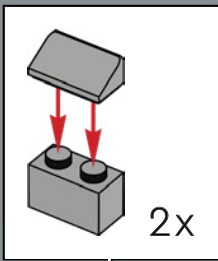

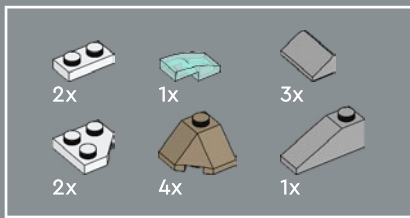

89

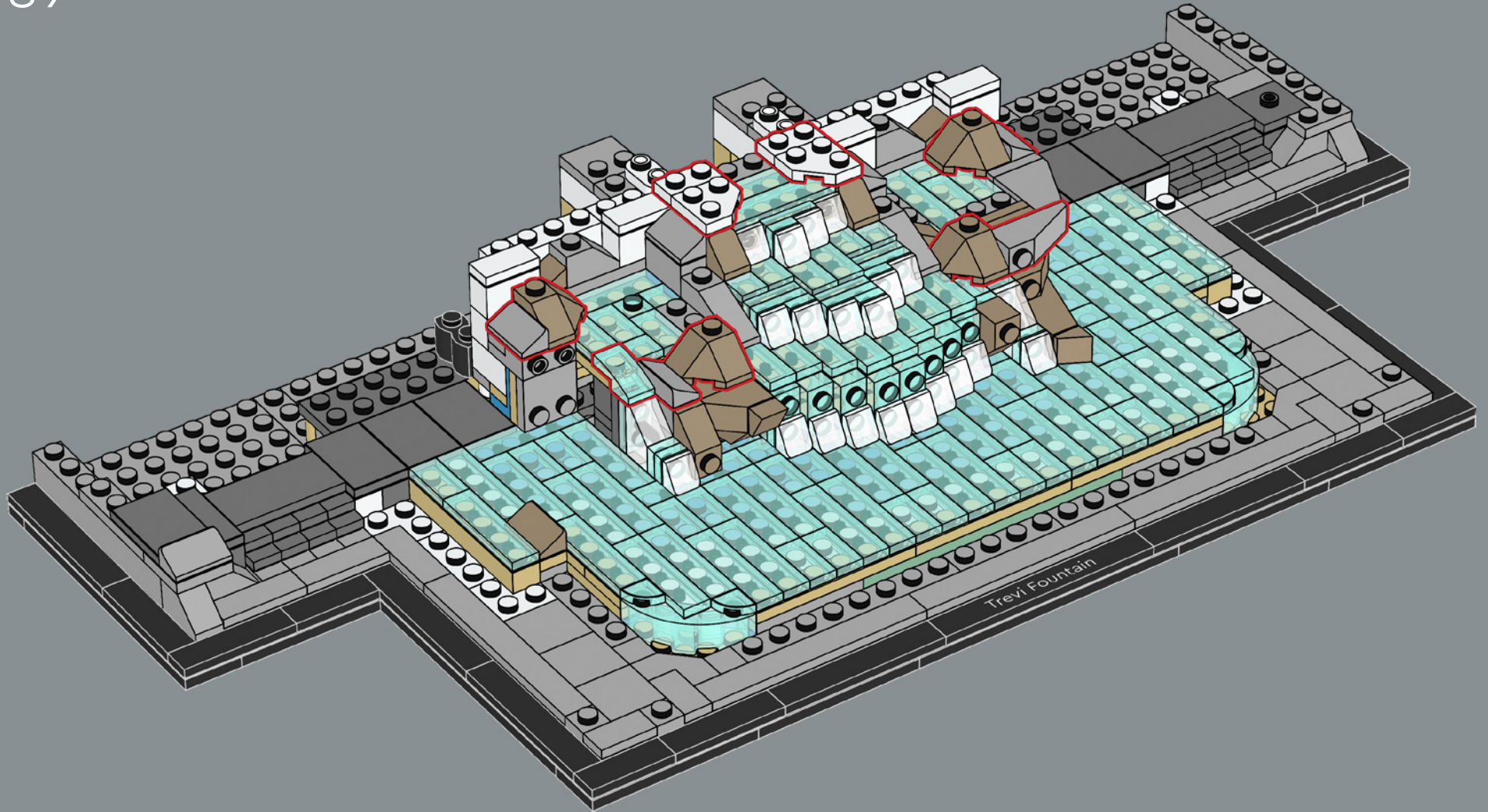

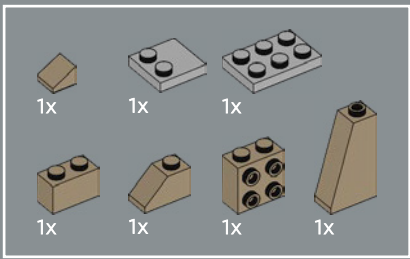

90

1

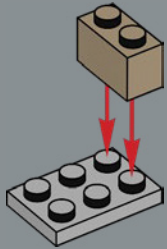

2

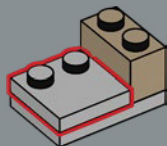

3

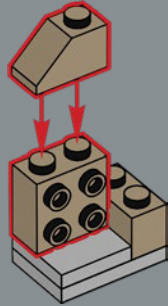

4

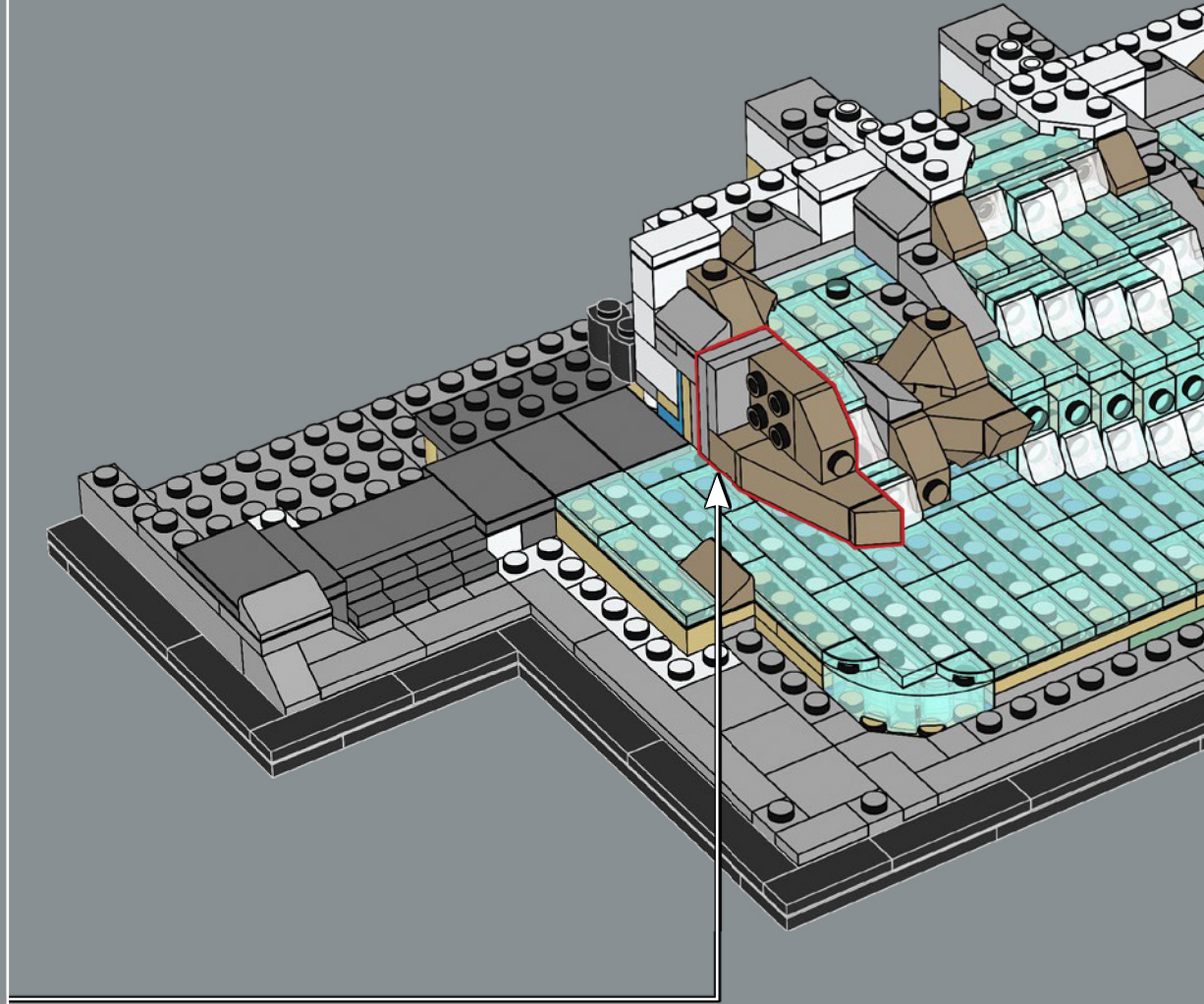
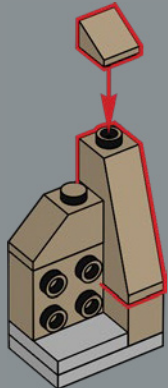

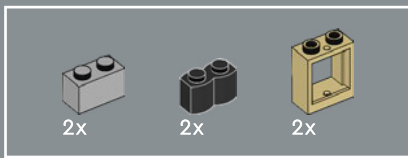

91

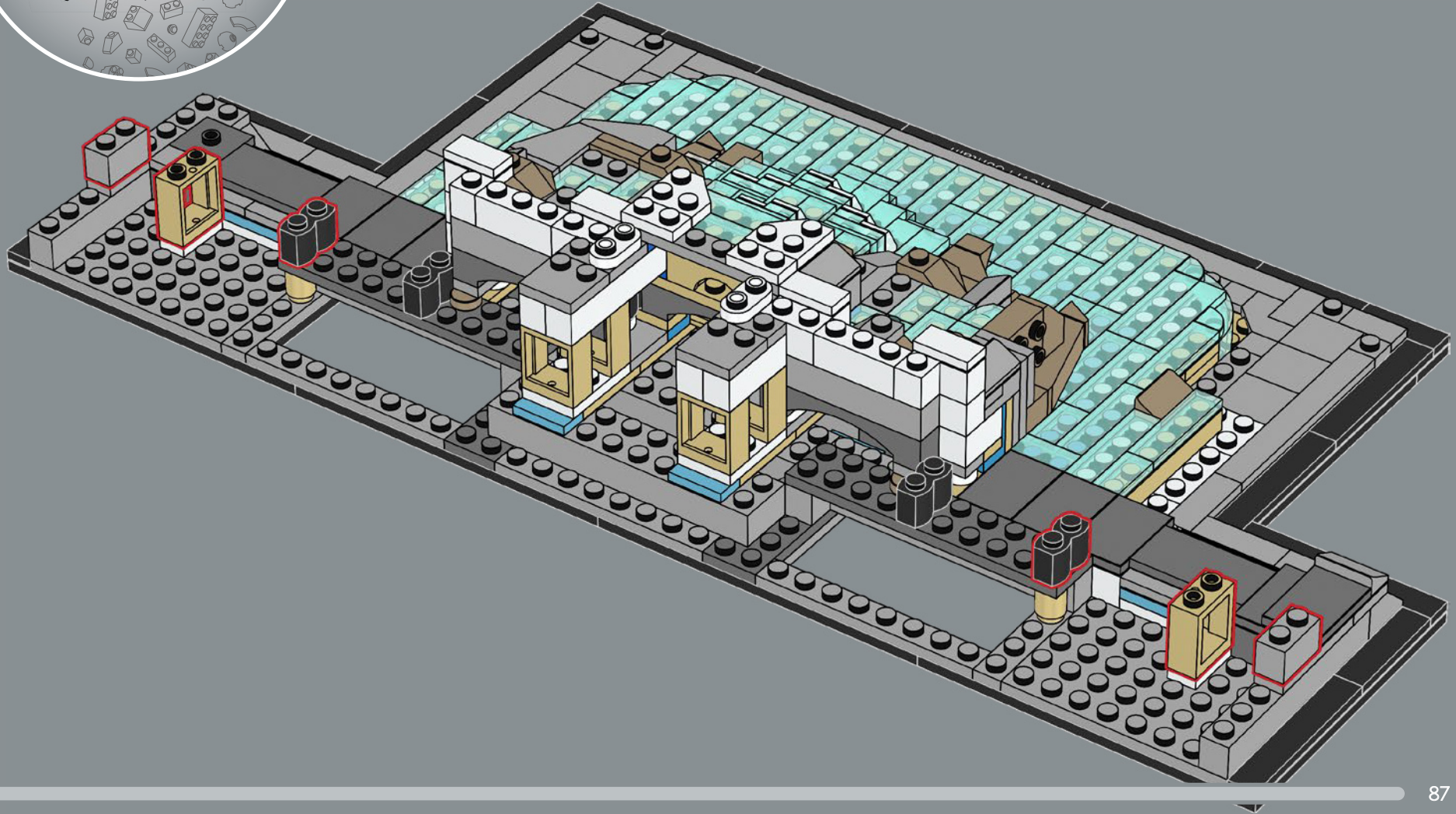

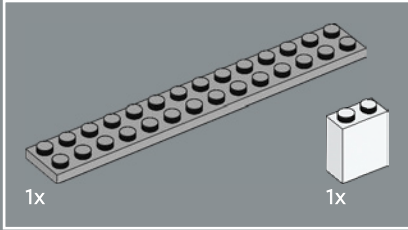
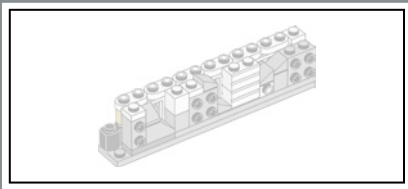

92

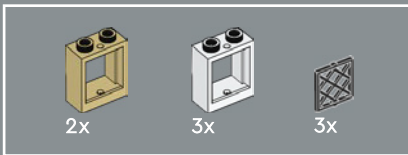
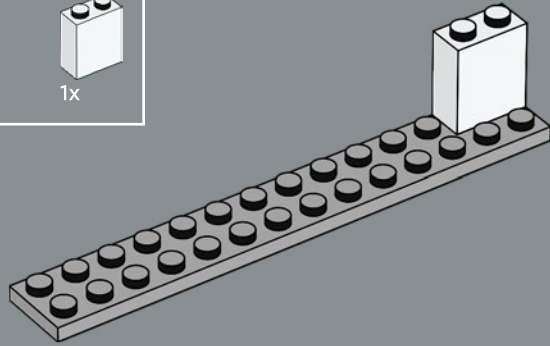

93

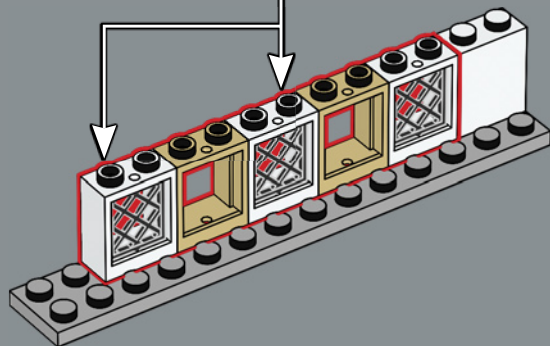
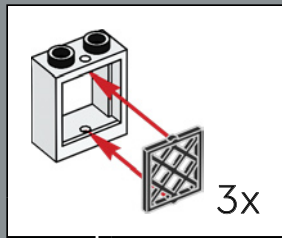

94

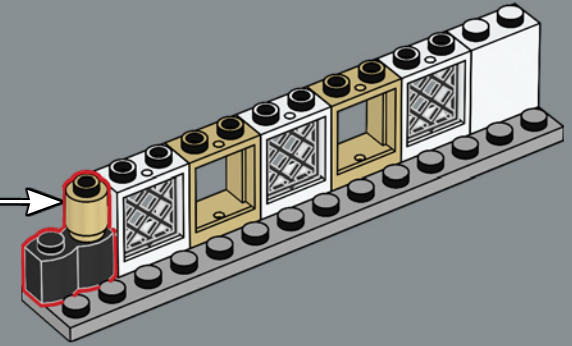
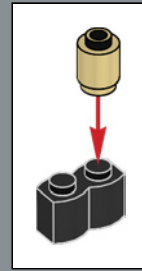

95

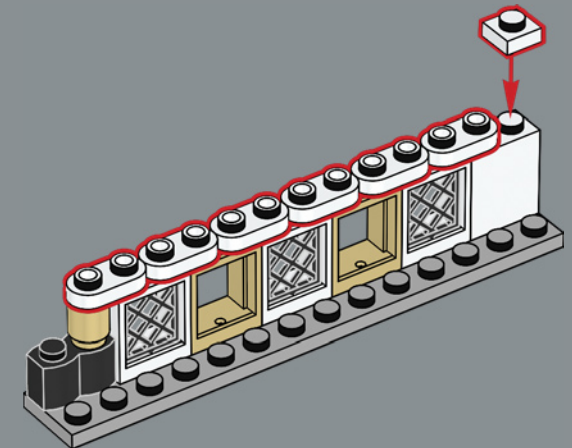



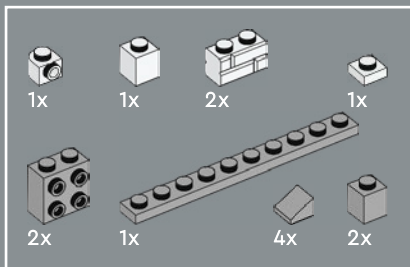

96

这些窗户后面是渡槽的水道, 水流来自瀑布。

1

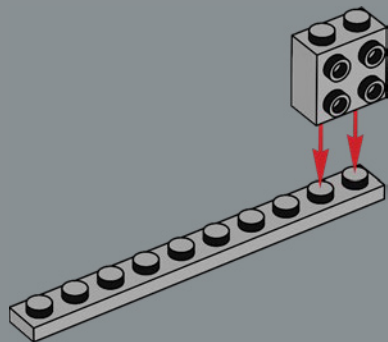

2

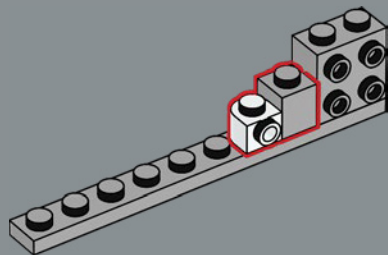

3

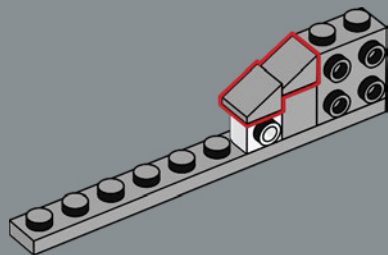

4

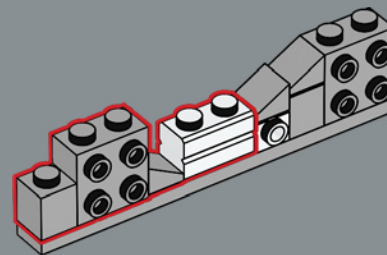

5

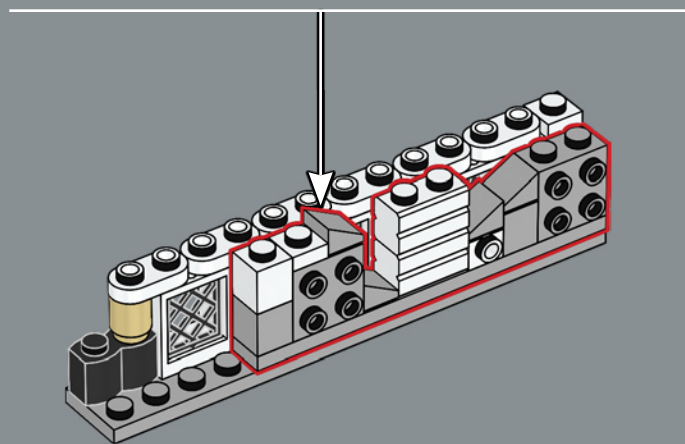
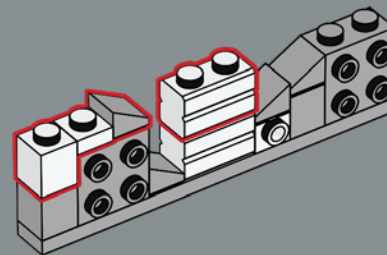

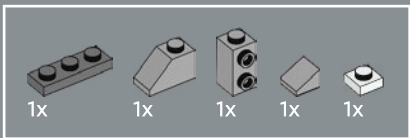

97

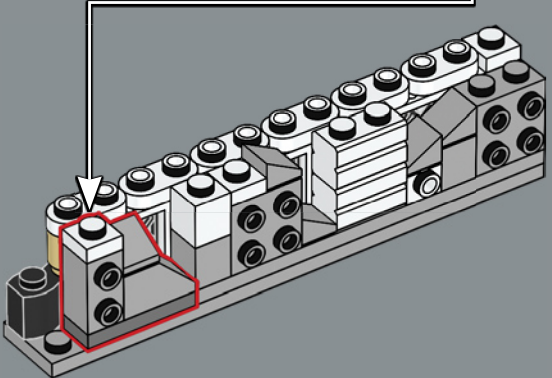
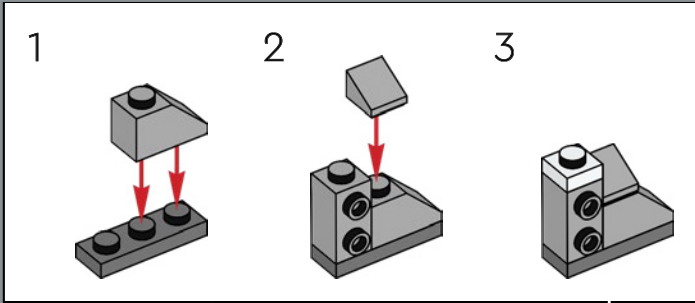

98

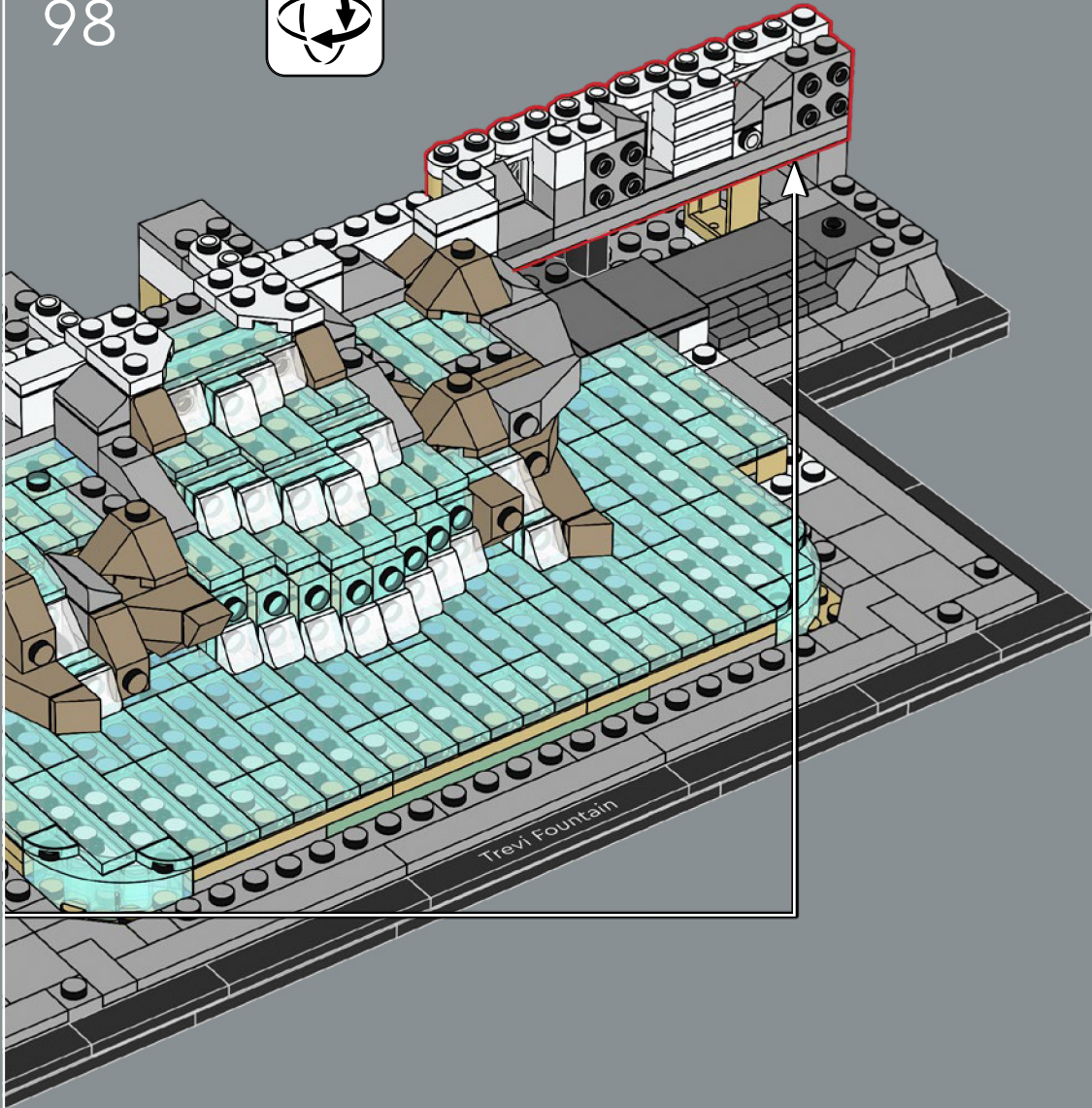

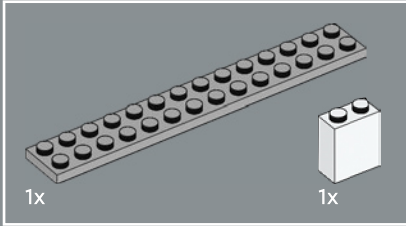
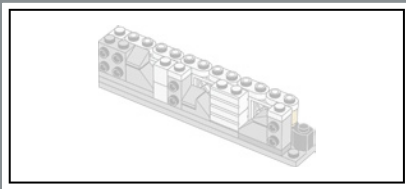

99

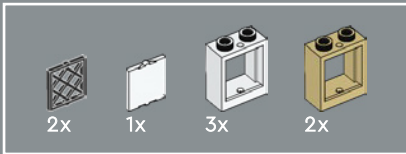
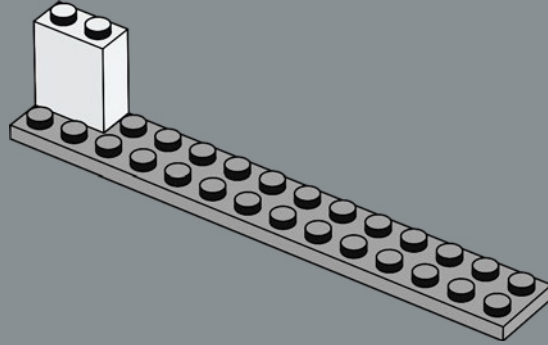

100

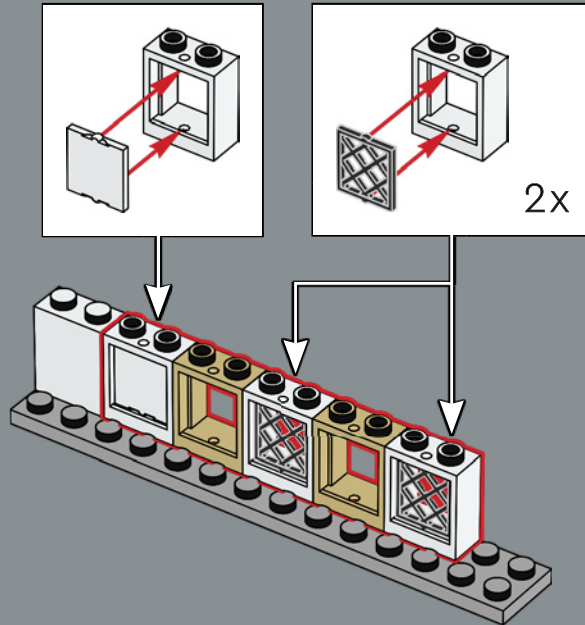

101

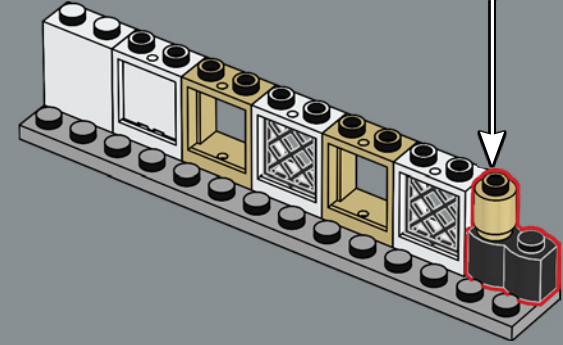
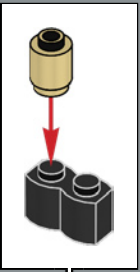

102

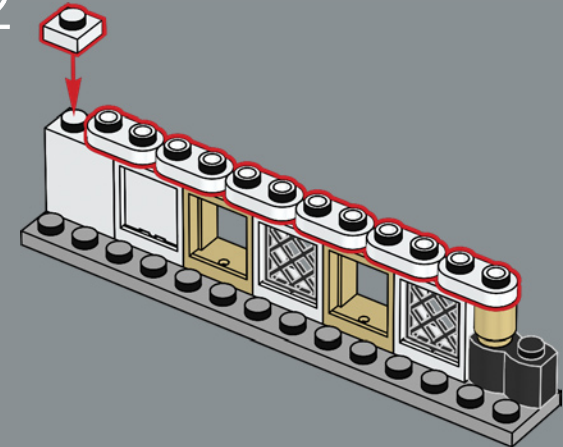

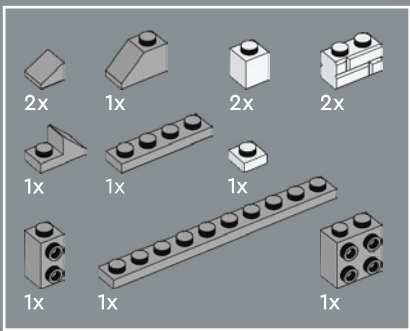

103

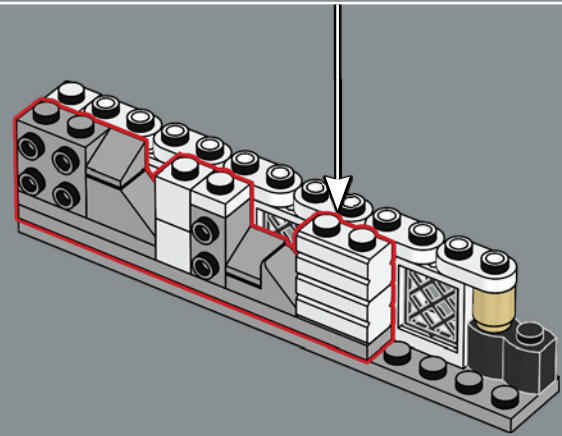
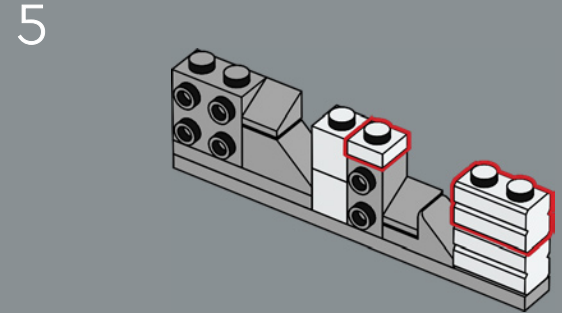
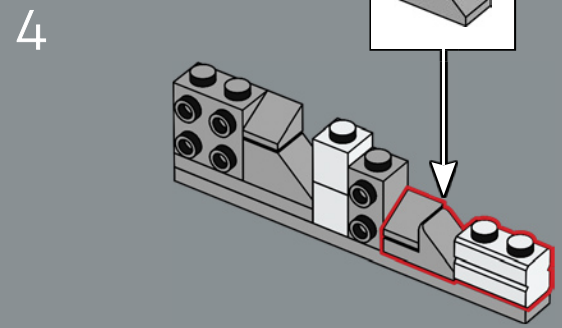
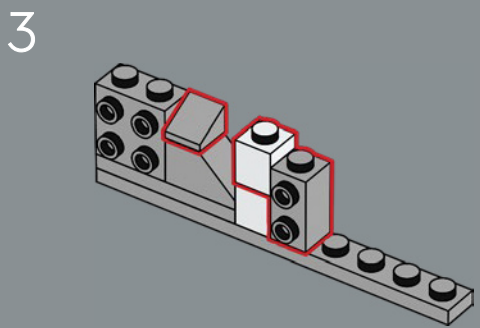
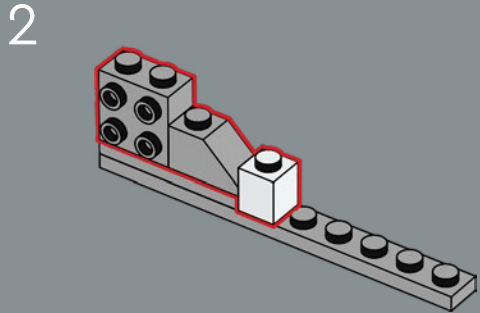
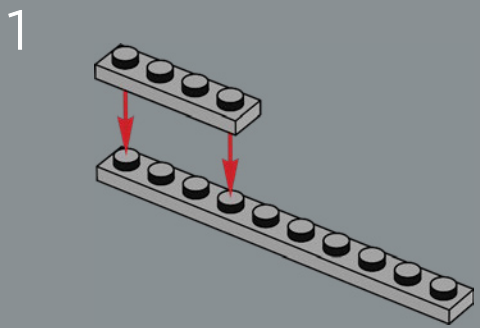

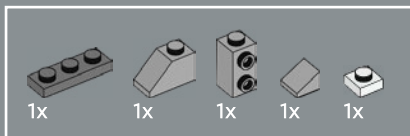

104

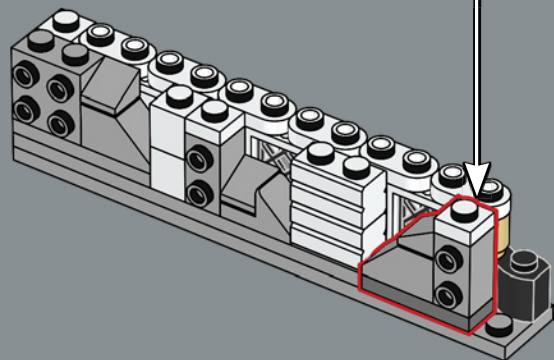
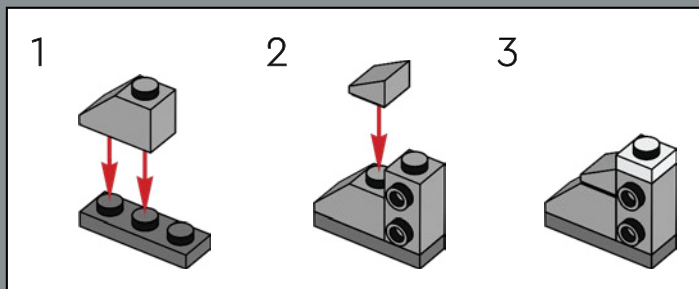

105

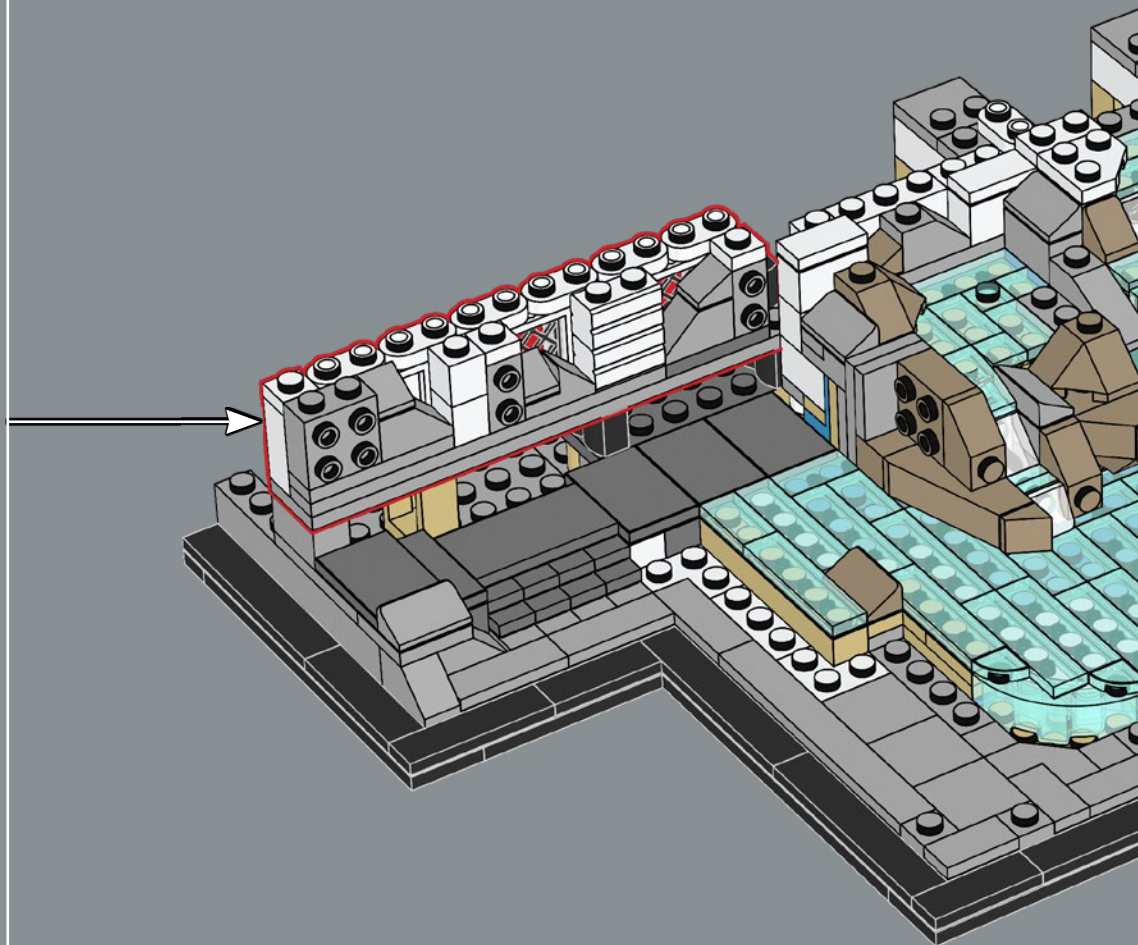

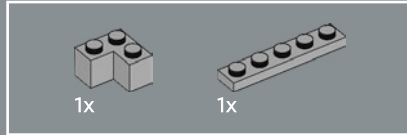
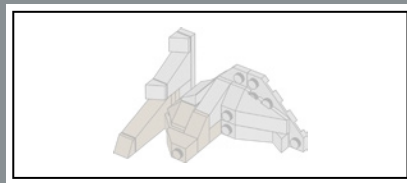

106

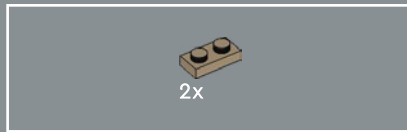
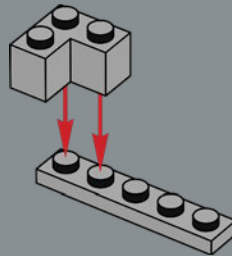

107

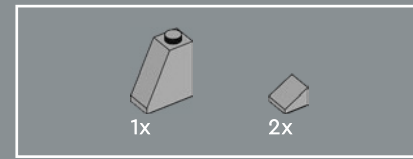
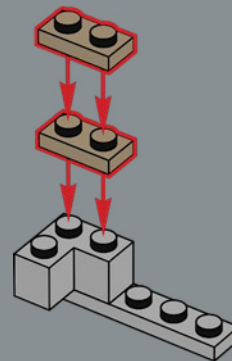

108

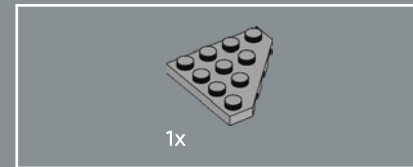
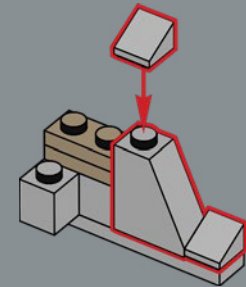

109

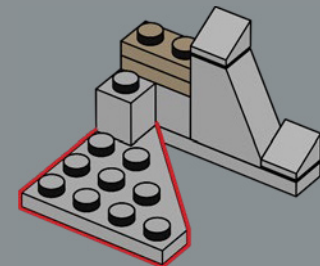

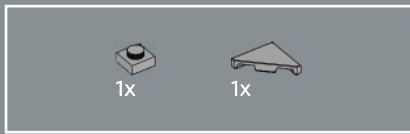

110

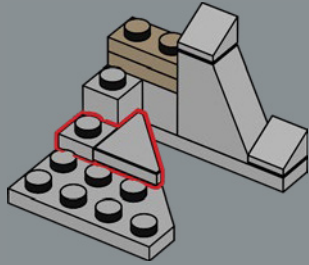

112

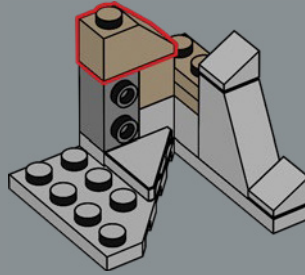

114

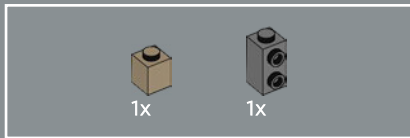
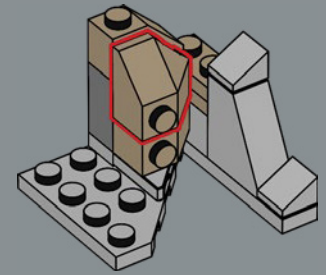

111

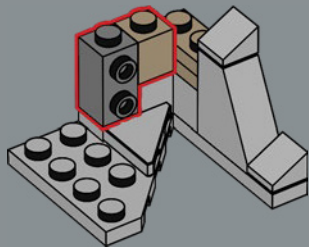

113

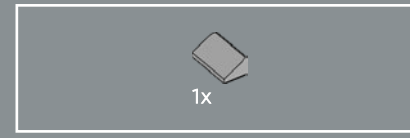
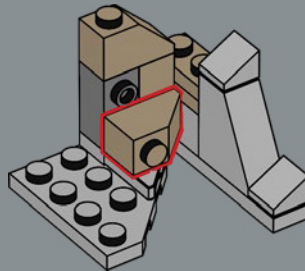

115

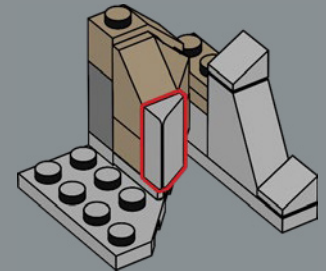

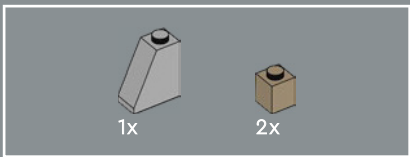

116

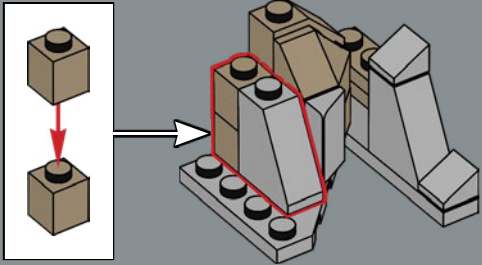

117

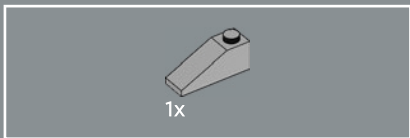
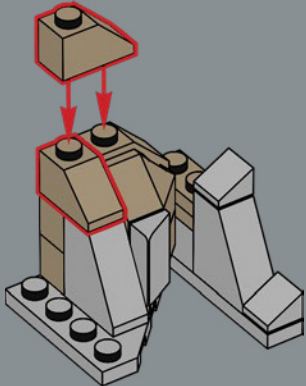

118

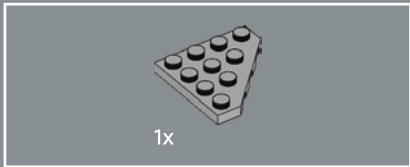
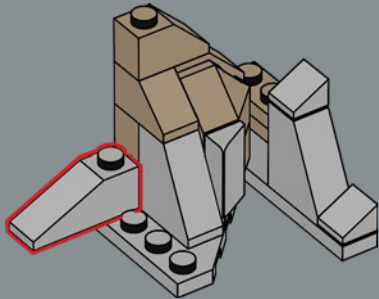

119

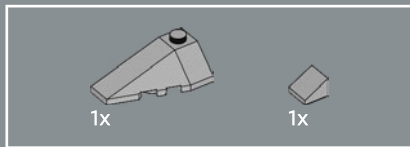
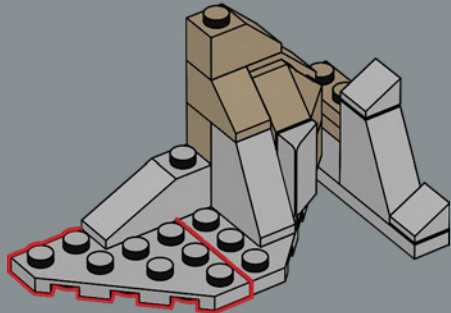

120

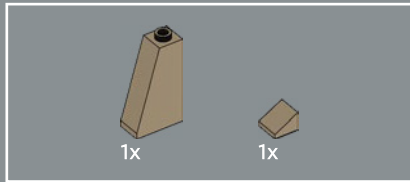
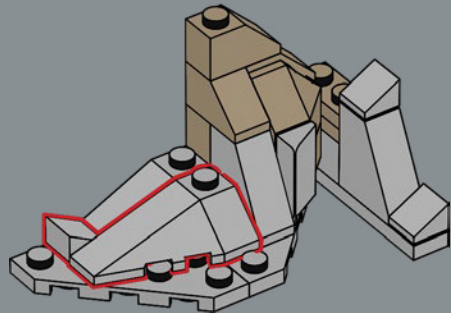

121

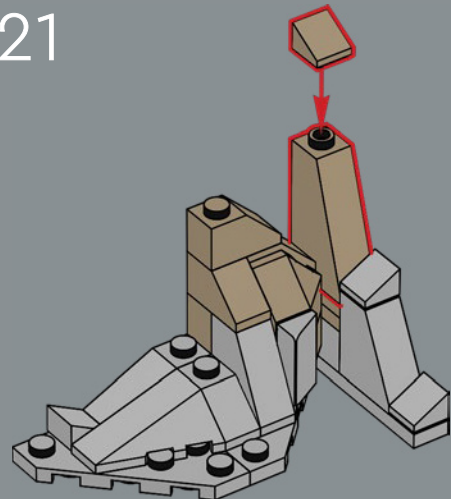



岩石是少数几个打破这座巴洛克式建筑整体对称性的细节之一，同时以其有机的形状与立面的其余部分形成鲜明对比。

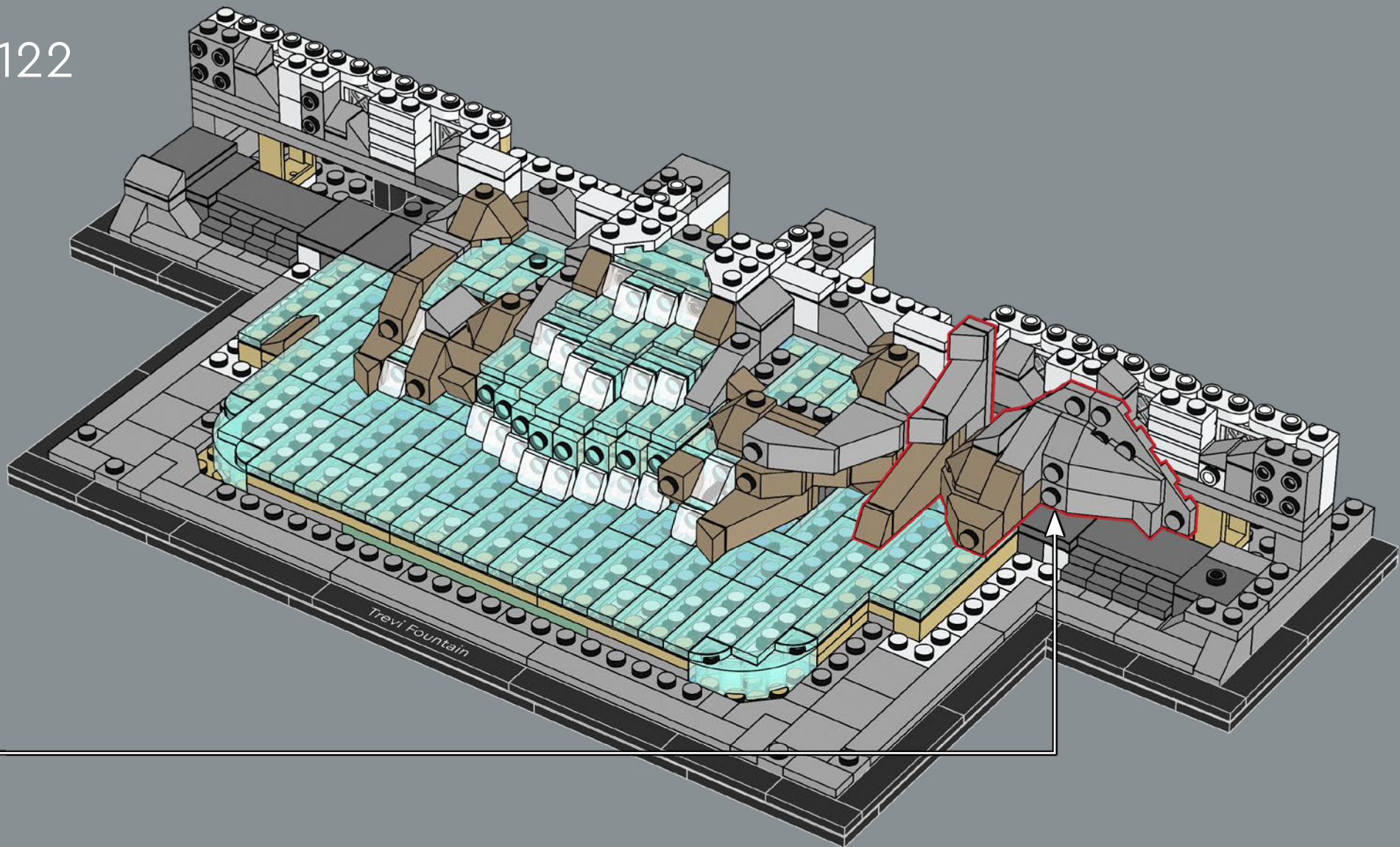

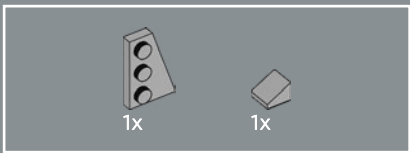

123

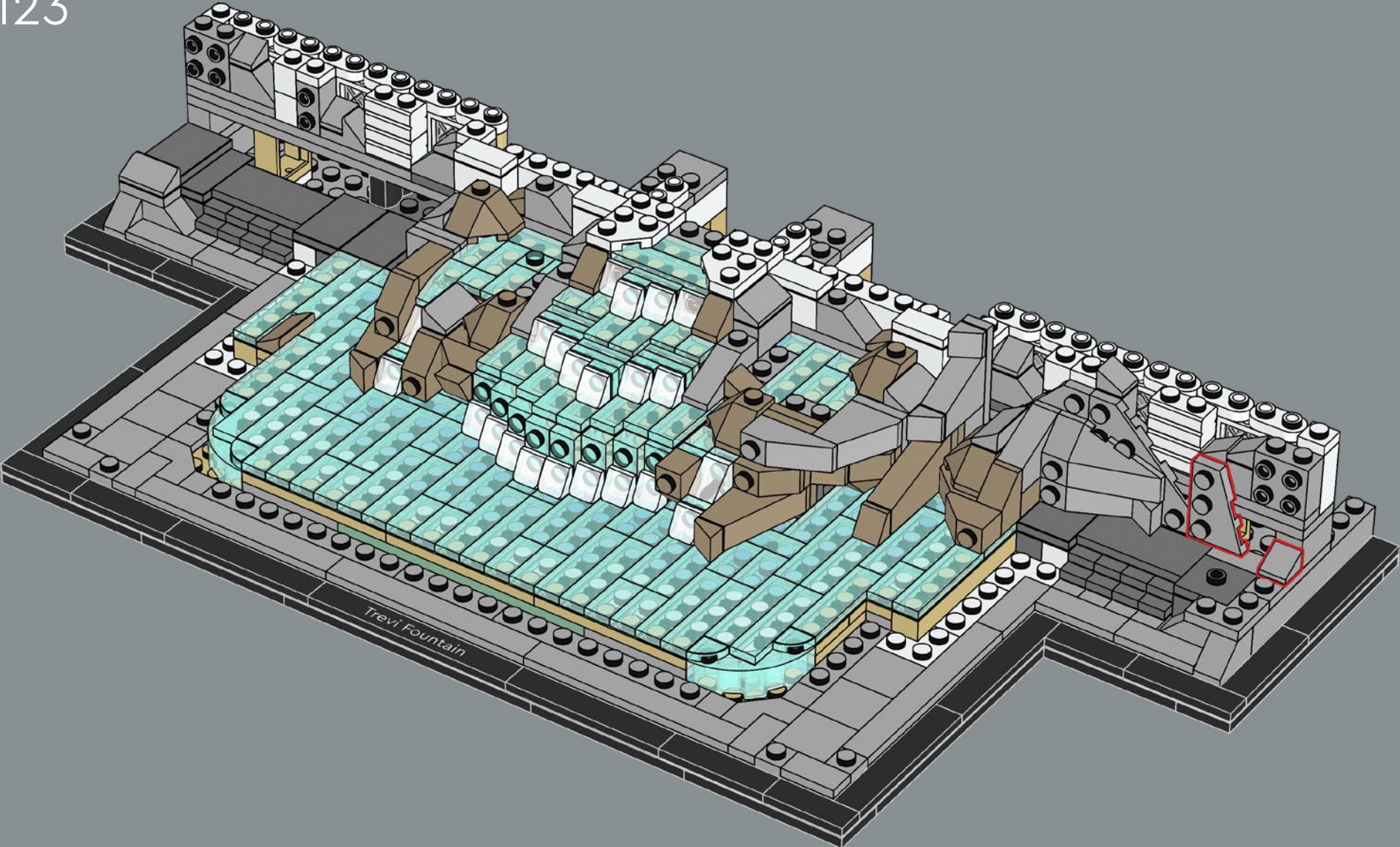

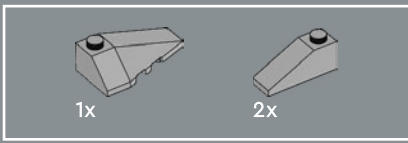

124

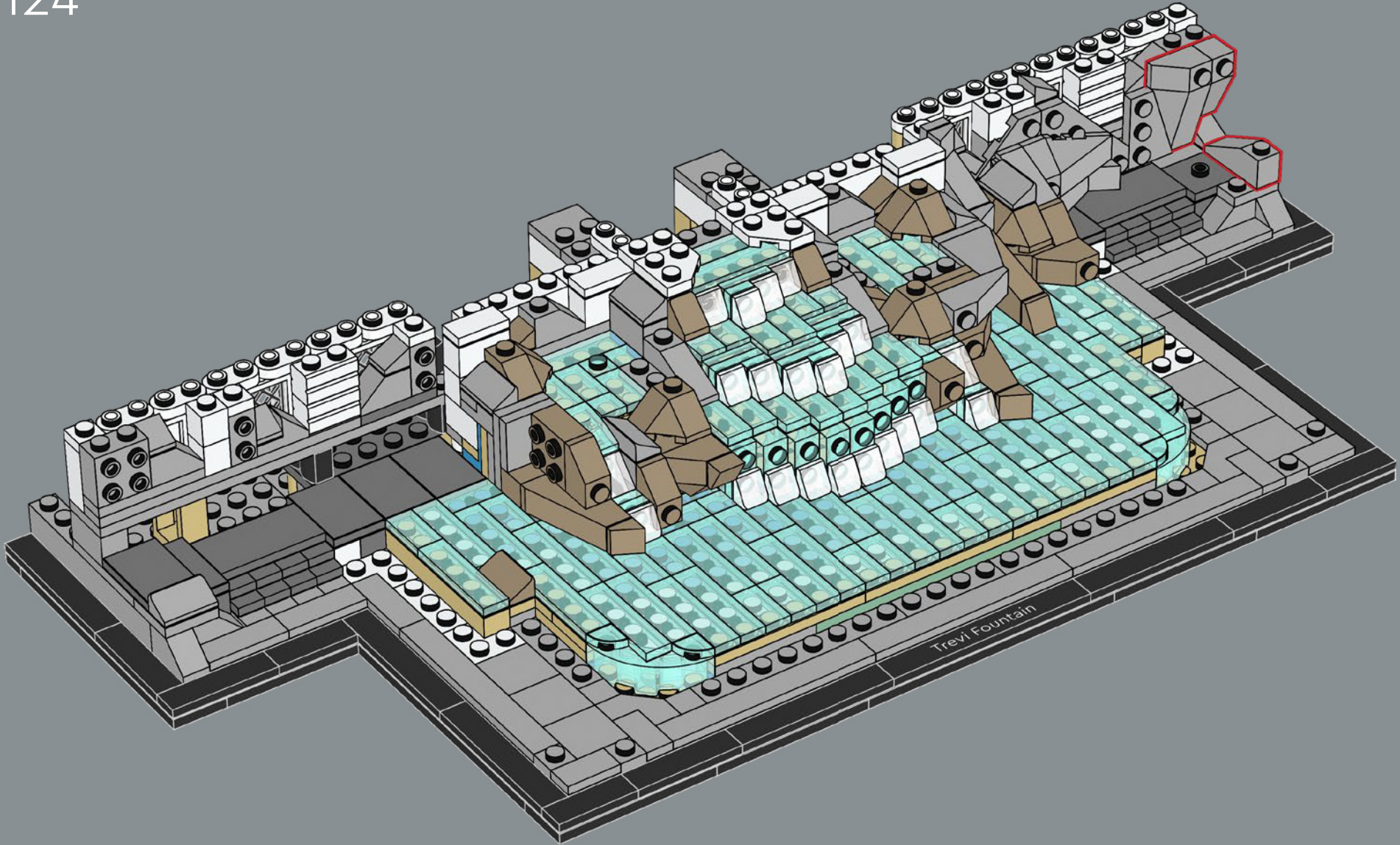

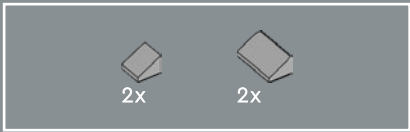

125

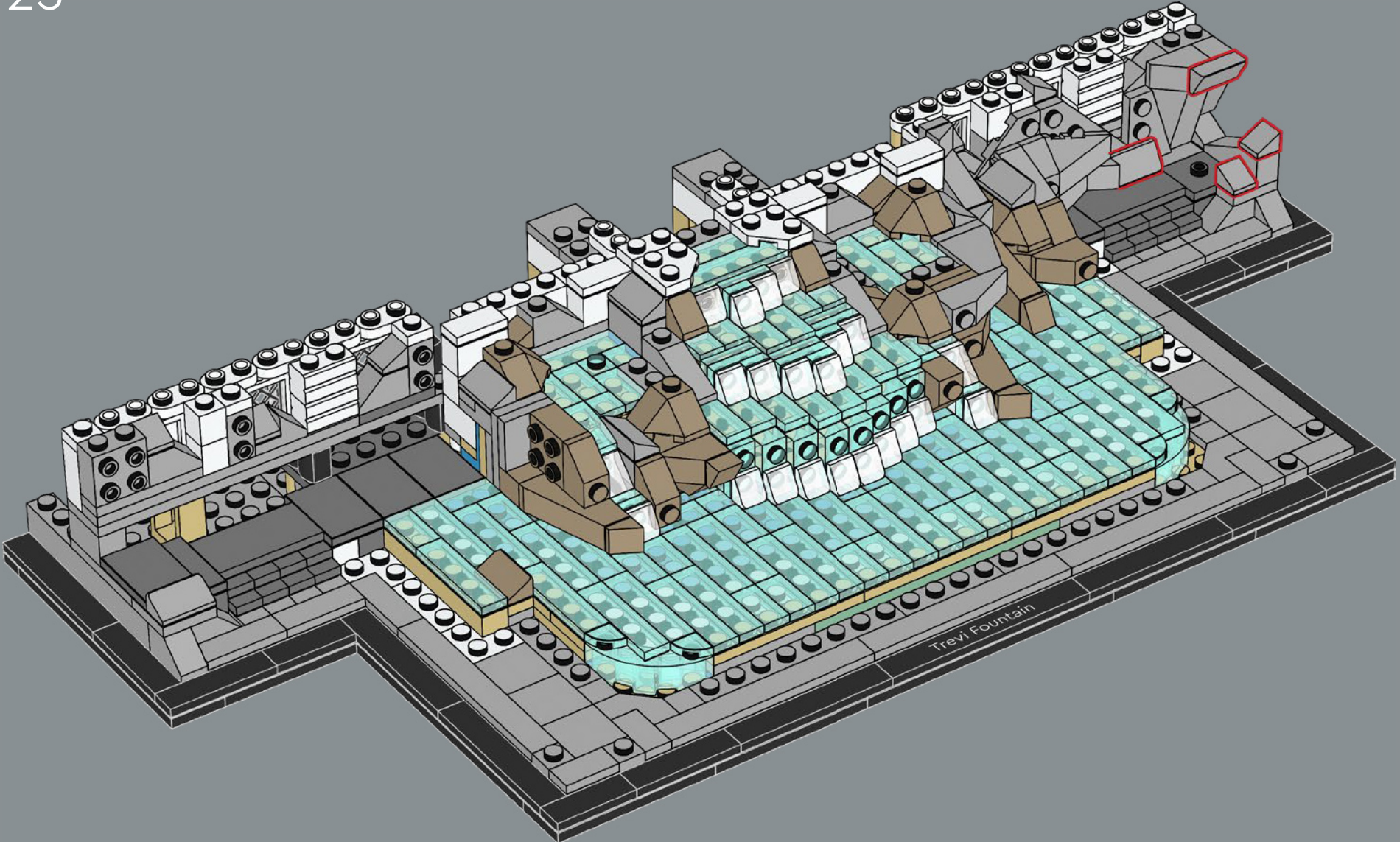

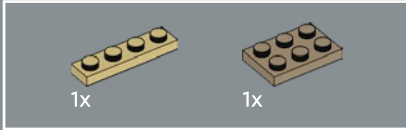
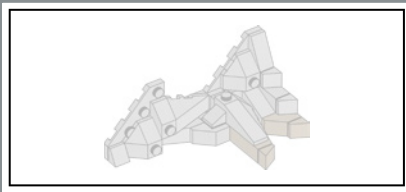

126

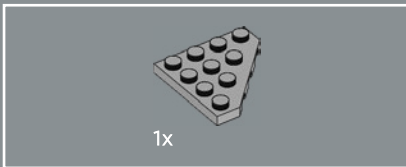
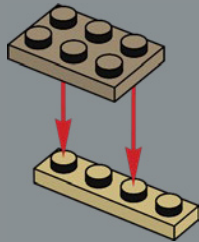

127

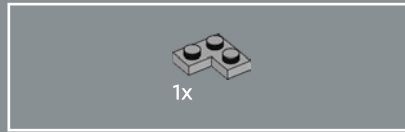
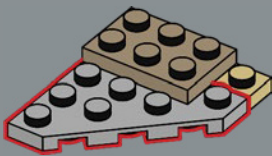

128

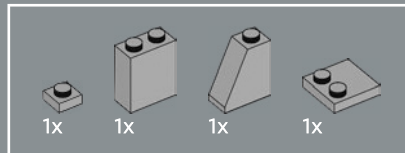
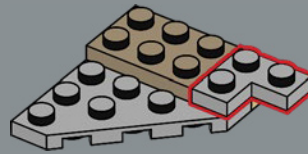

129

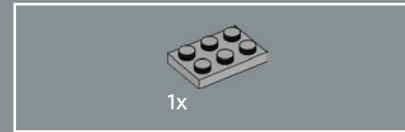
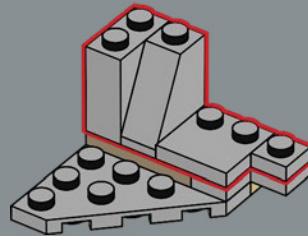

130

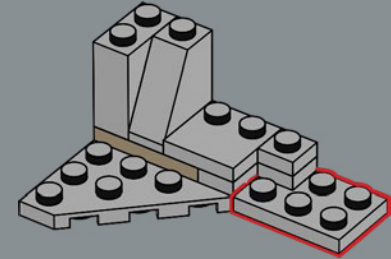

131

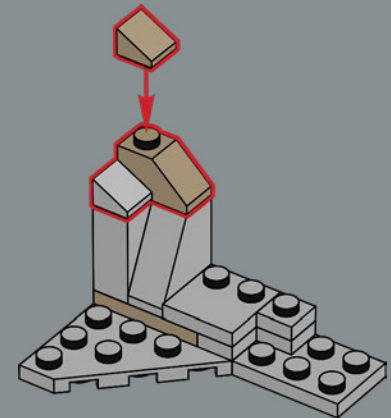



132

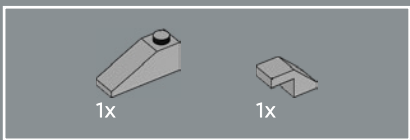
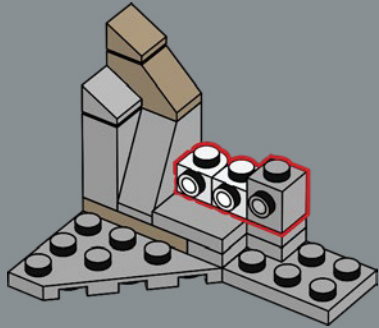

133

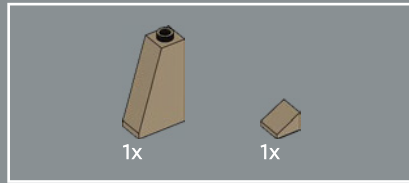
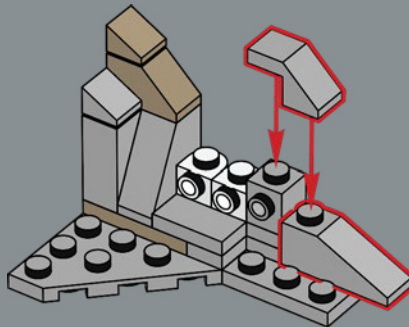

134

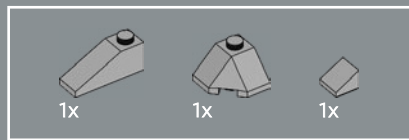
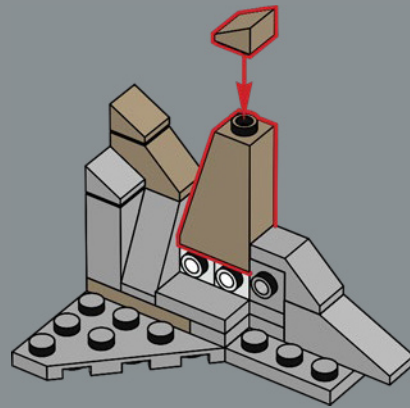

135

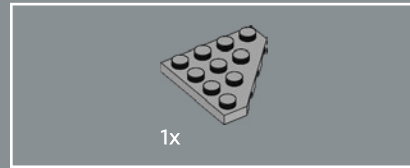
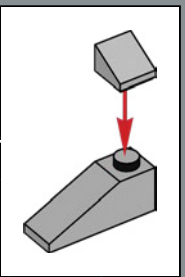
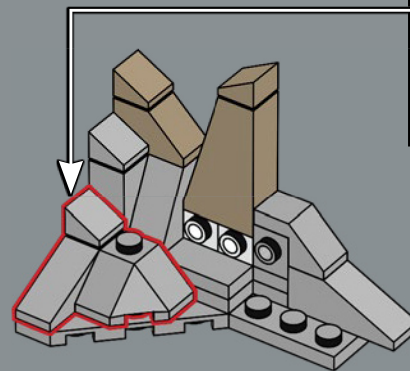

136

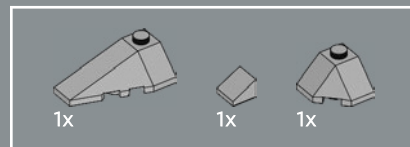
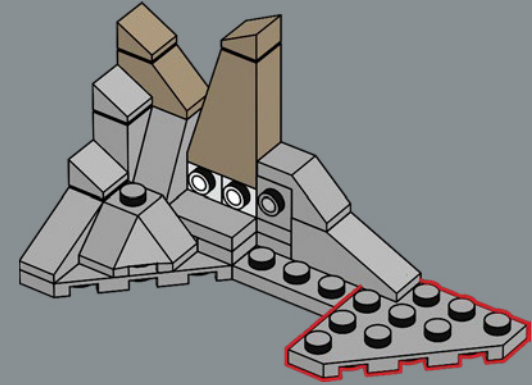

137

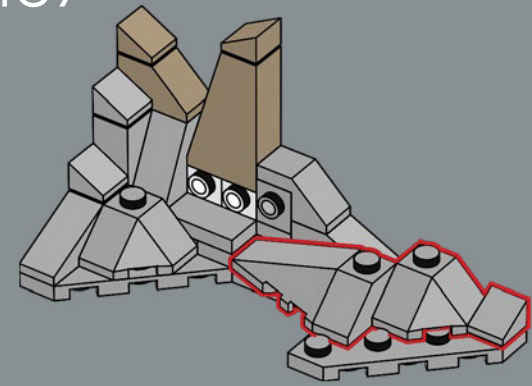

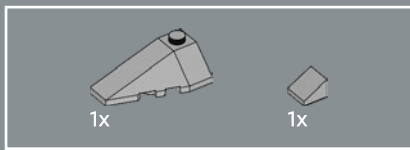

138

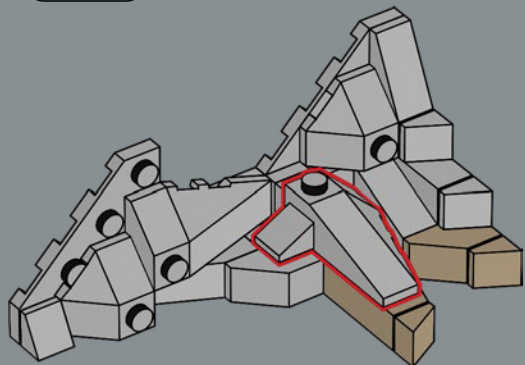

甚至喷泉的磨损也会影响它的观赏方式。环境破坏在雕刻立面的角落和缝隙中蔓延，即使是浅浅的雕刻也比周围的岩石颜色更深。

139

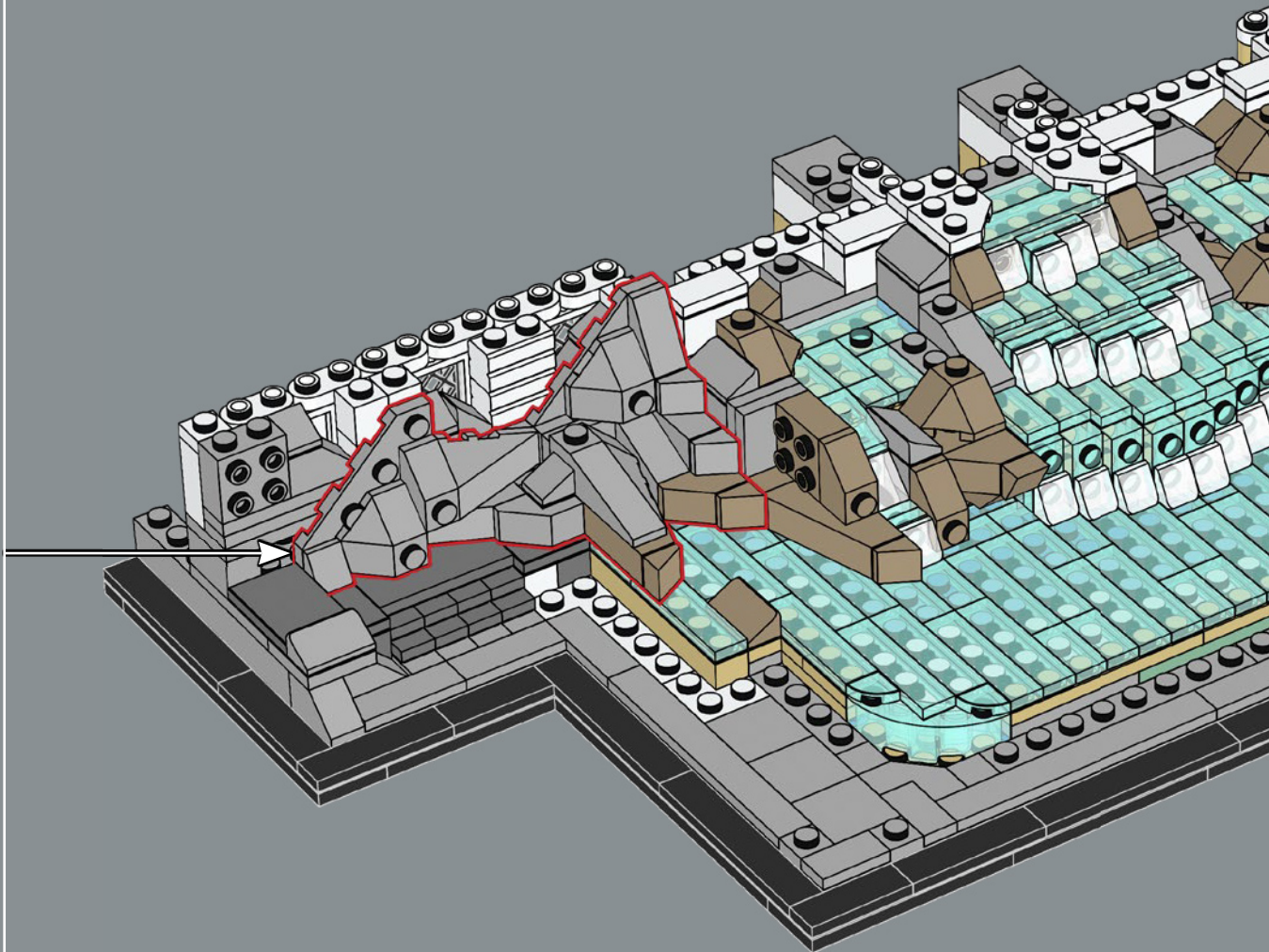

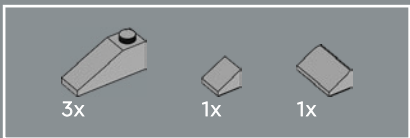

140

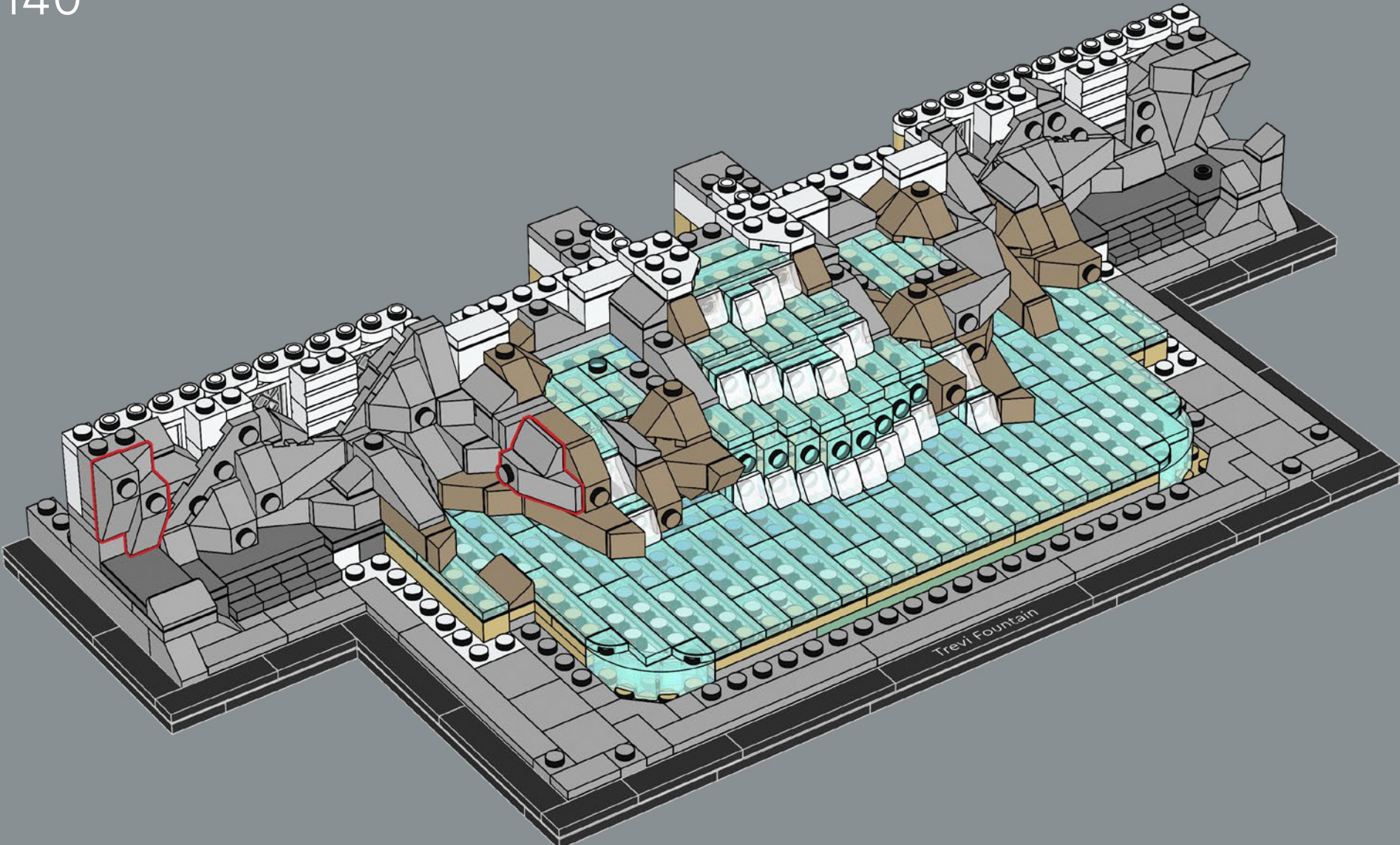



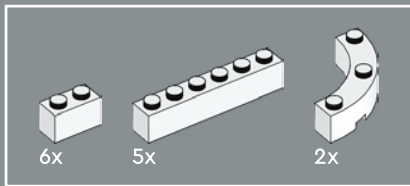

141

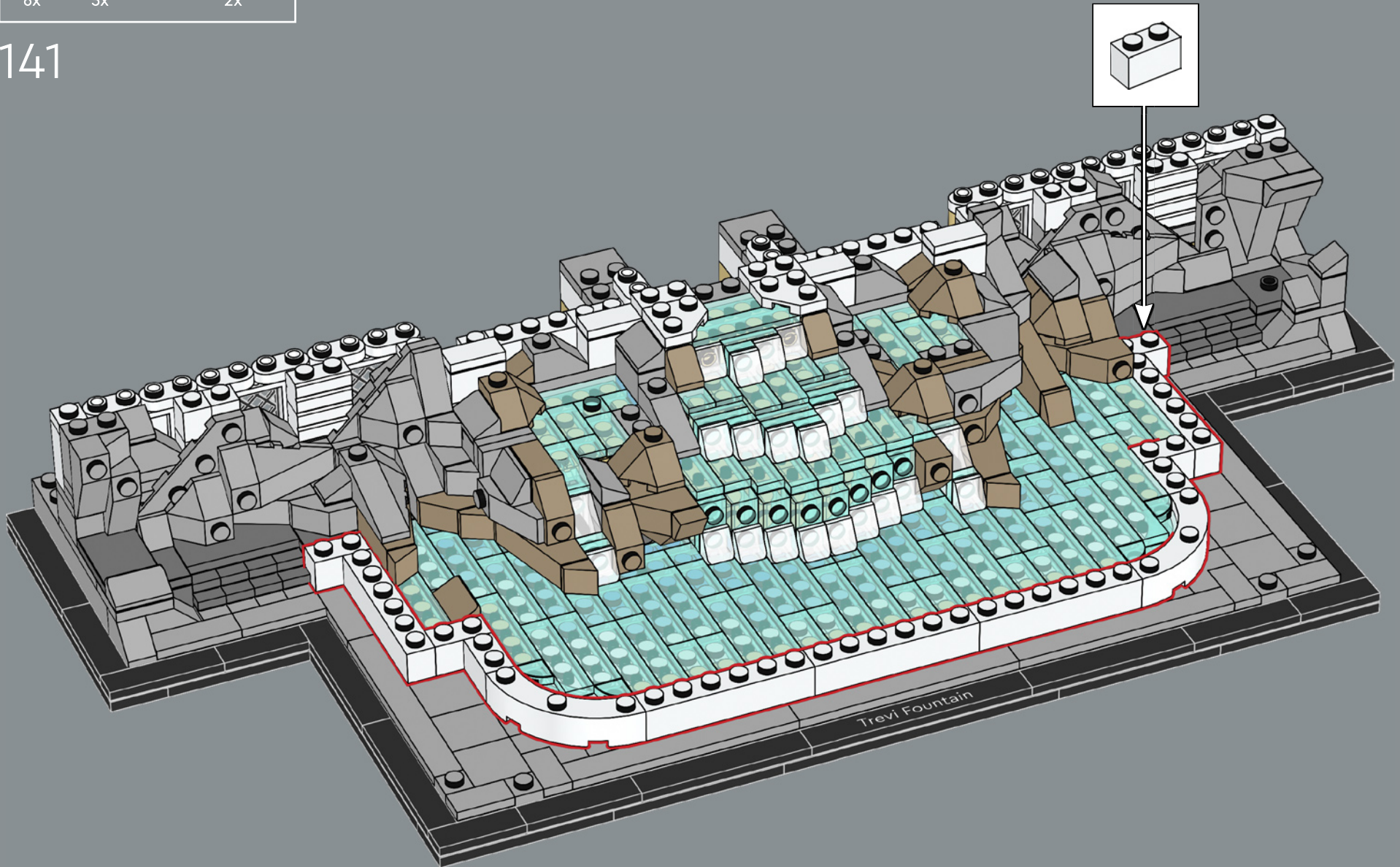

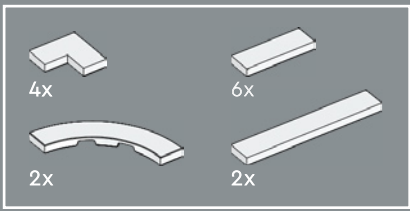

142

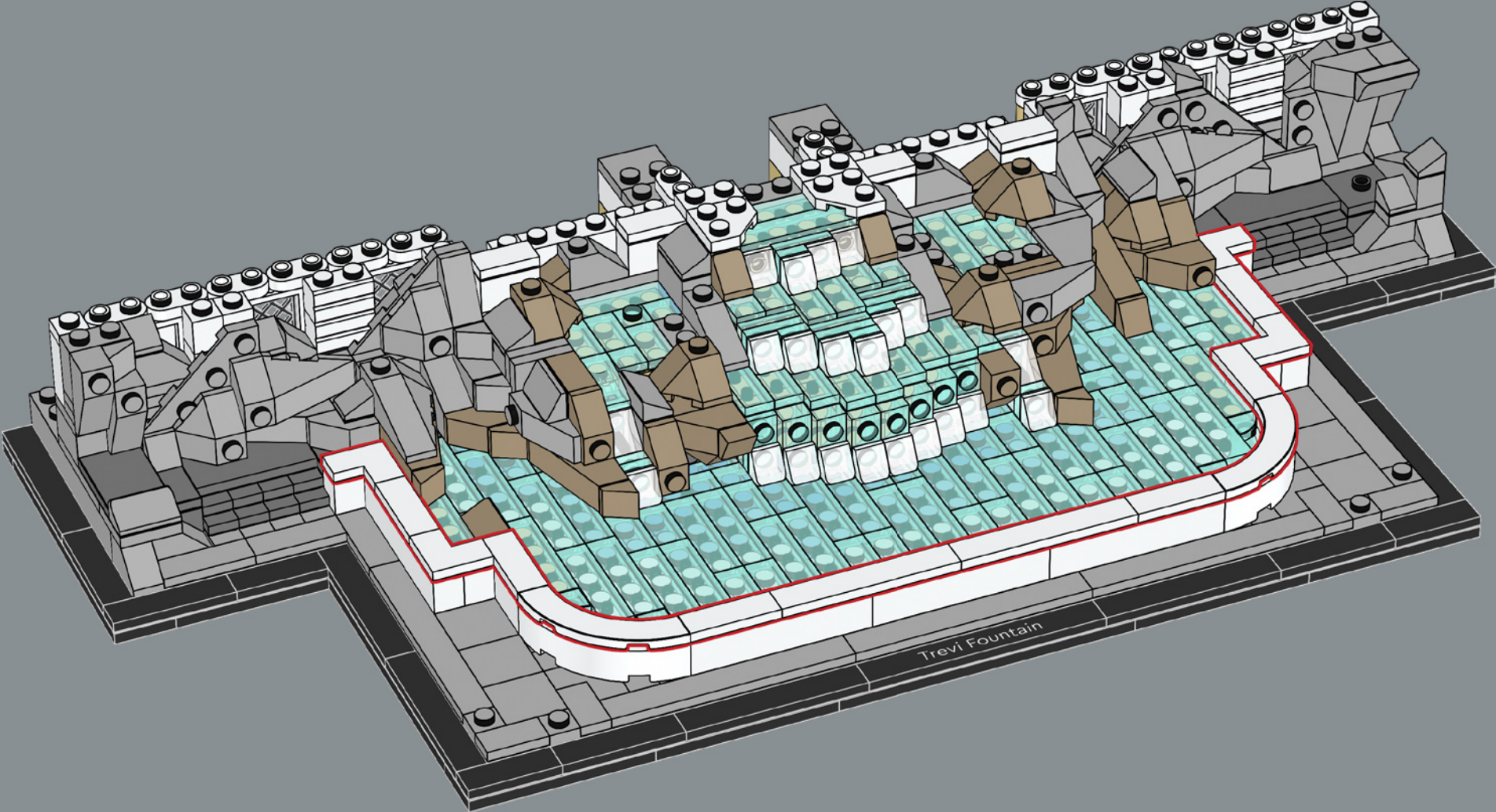

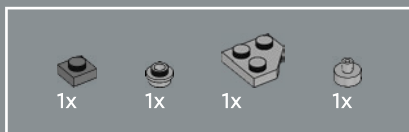

143

这个小喷泉因其穿过的水柱而被命名为 Fontanella degli Innamorati (爱之泉)。传说如果两个恋人饮用这个喷泉中的水，那么他们的爱情将天长地久。

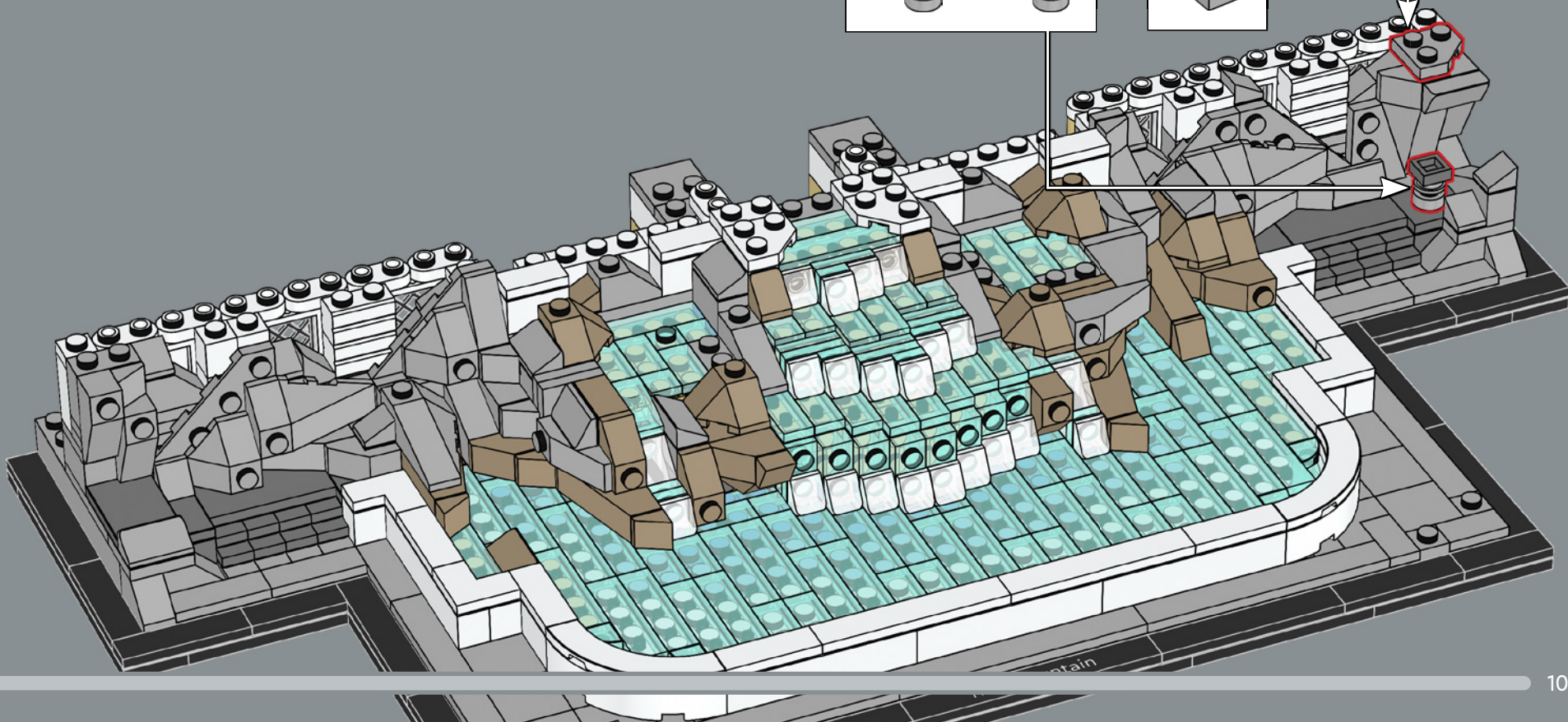
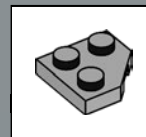
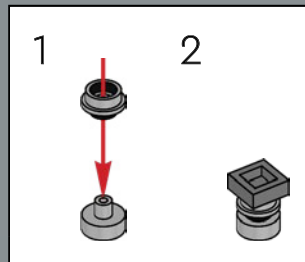

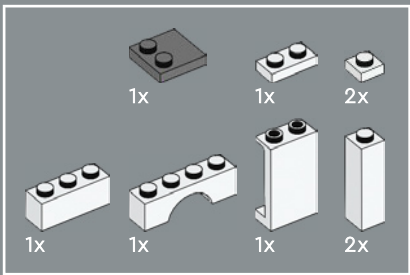

144

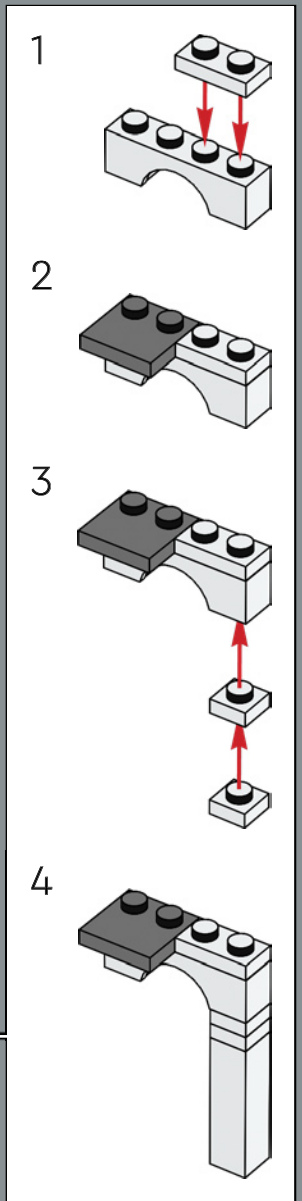
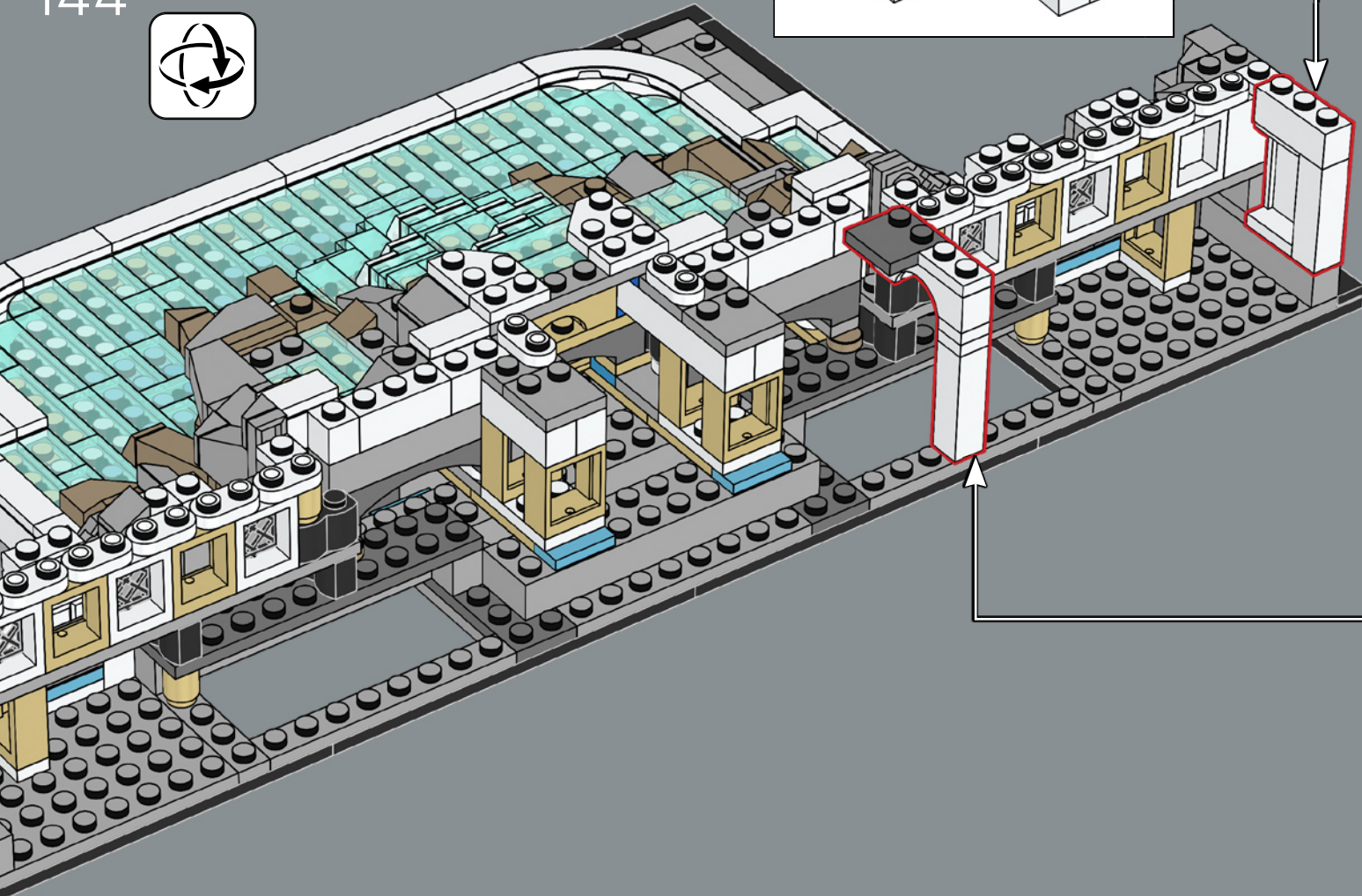
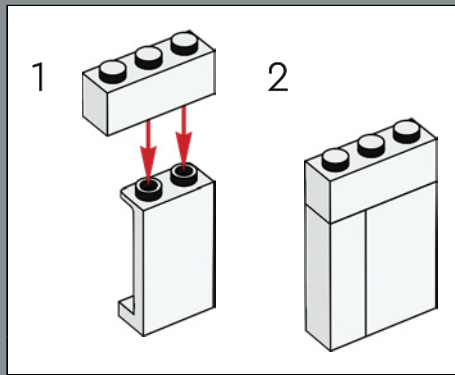

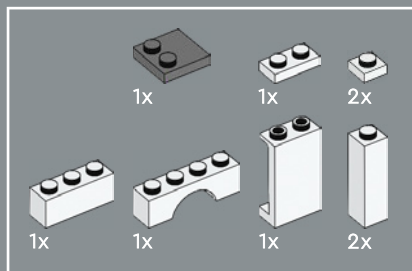

145

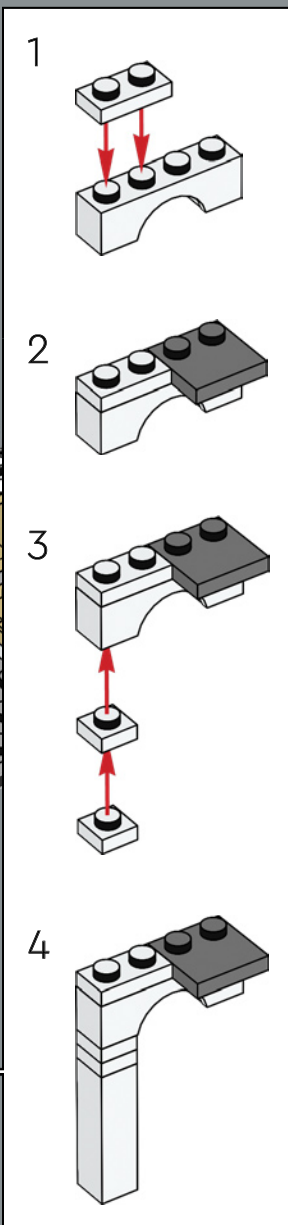
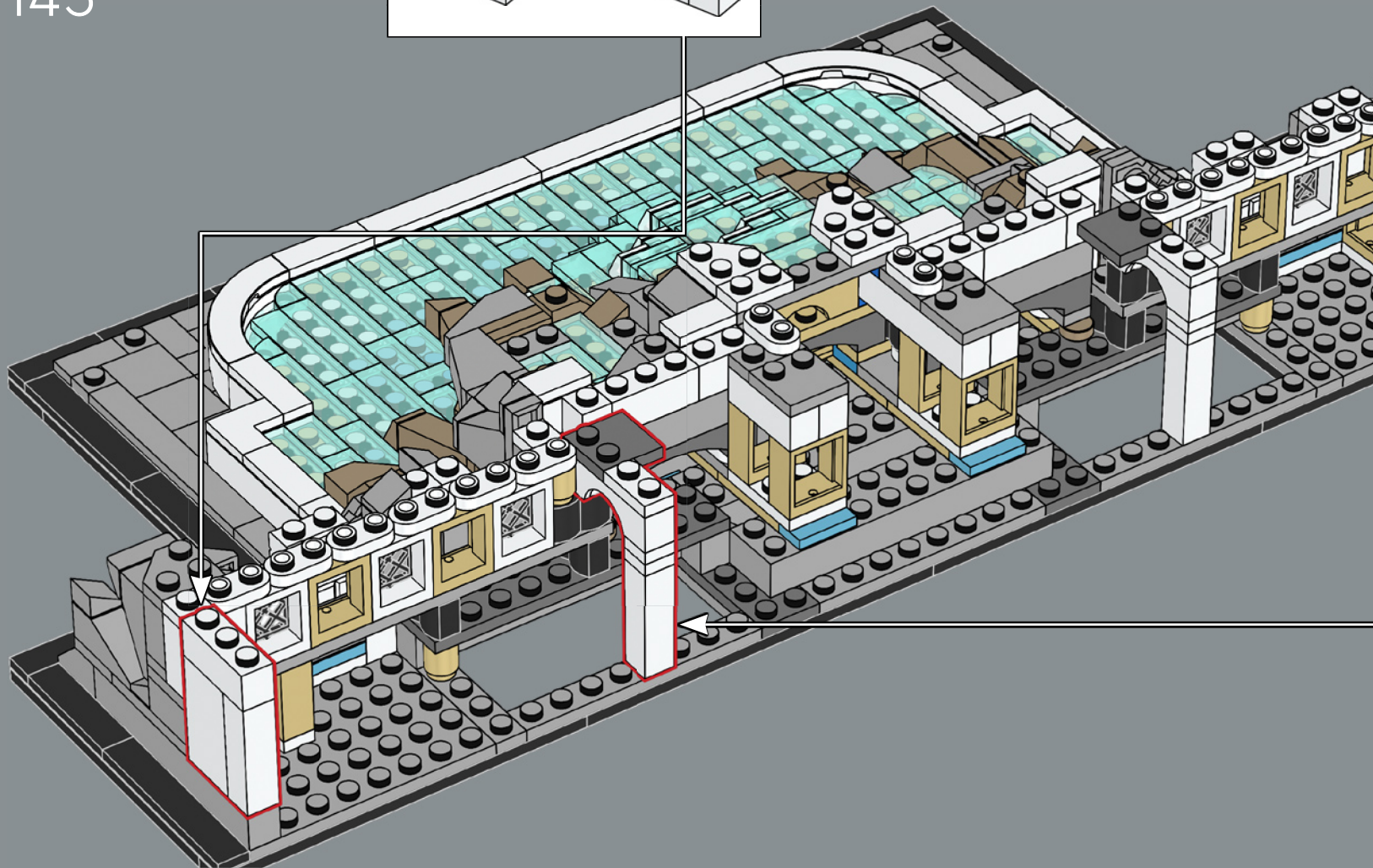
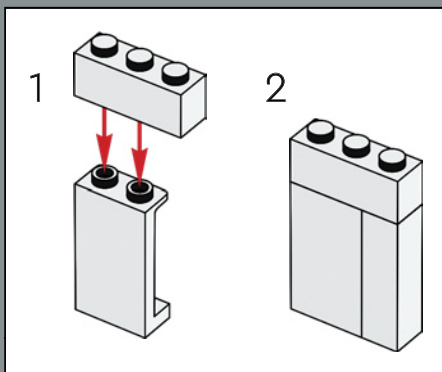

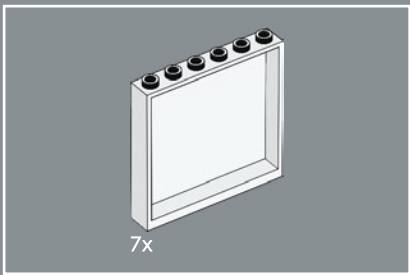

146

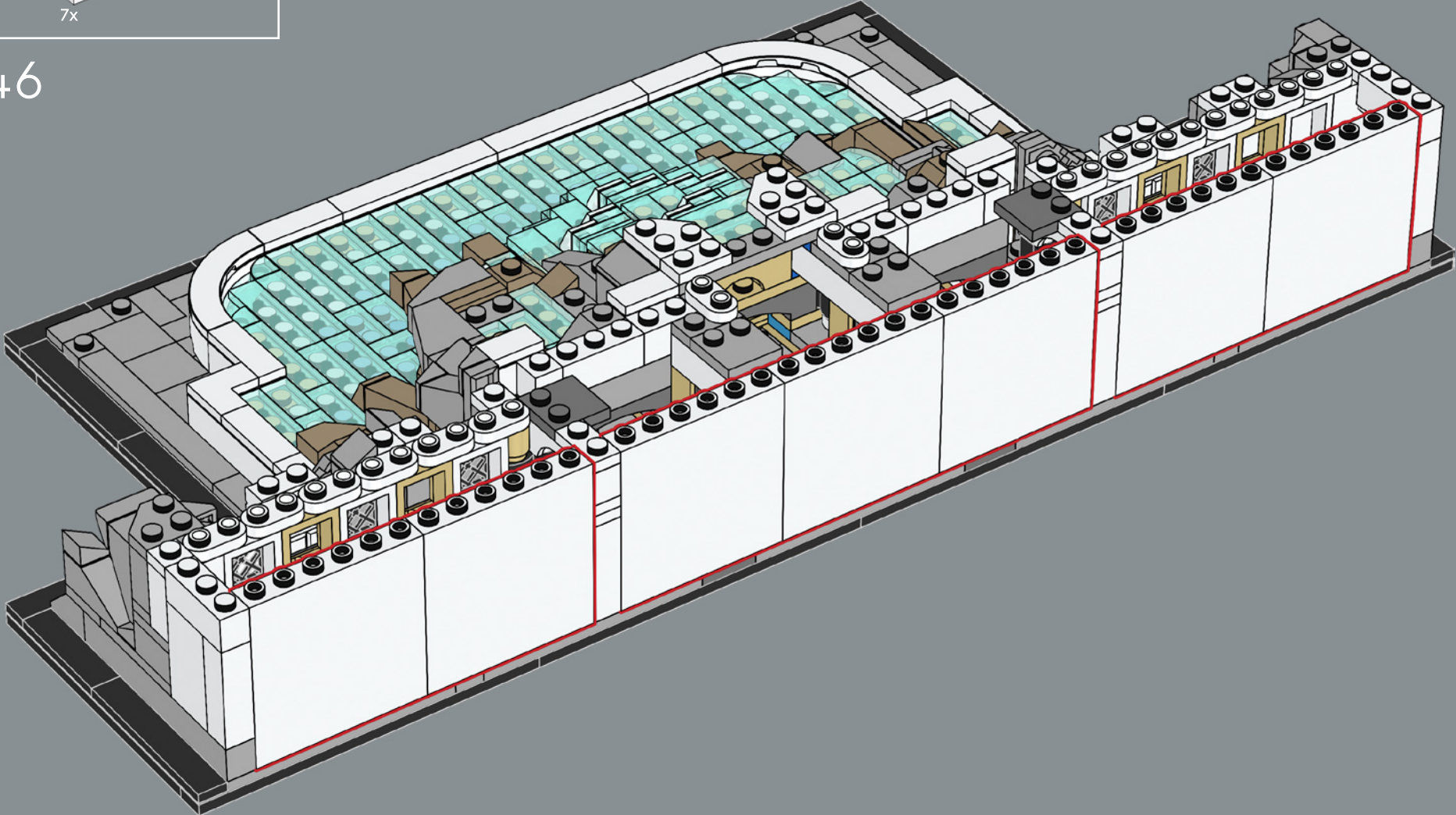

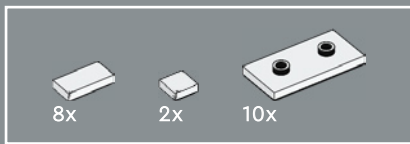

147

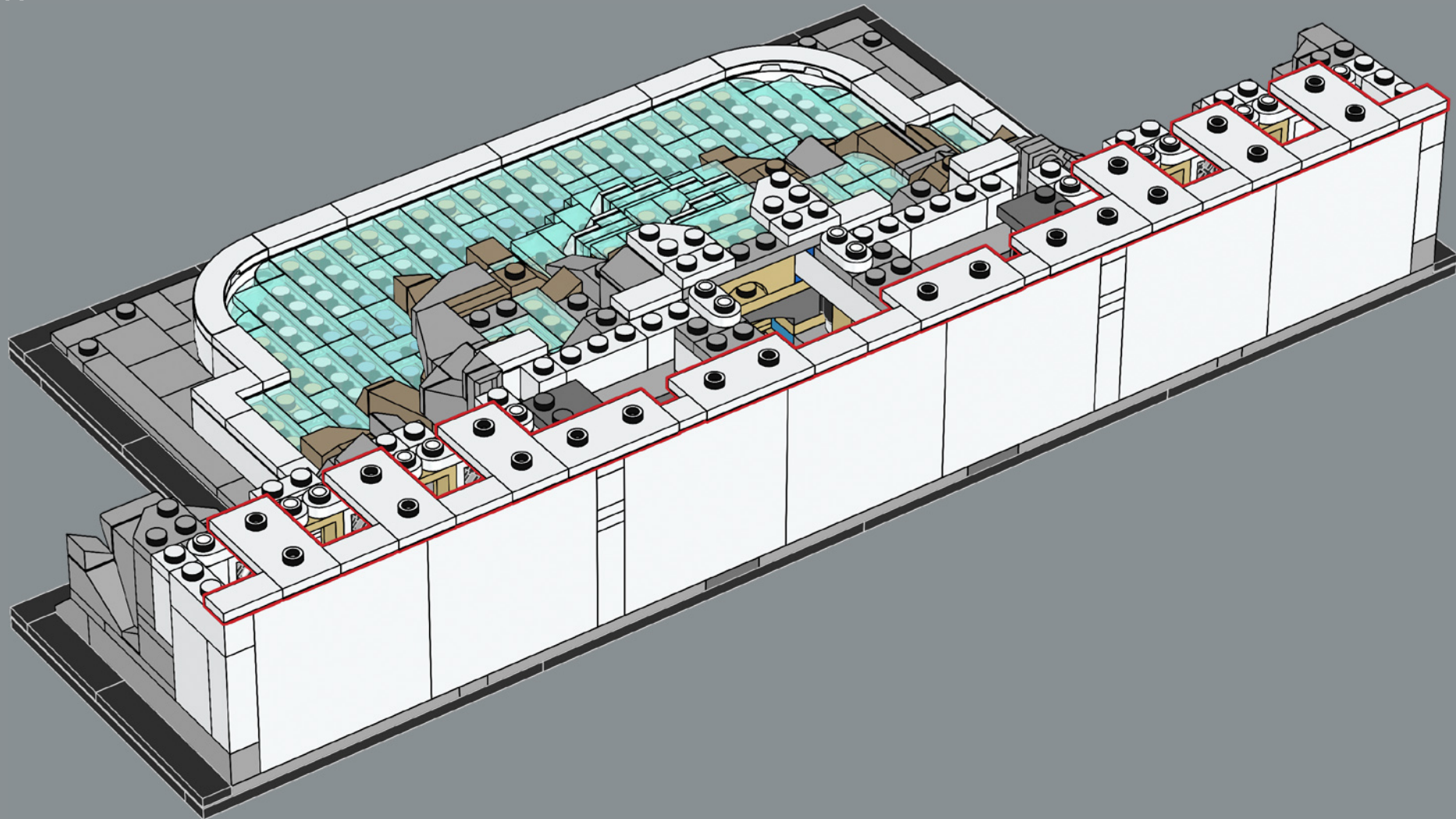

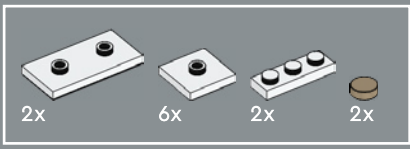

148

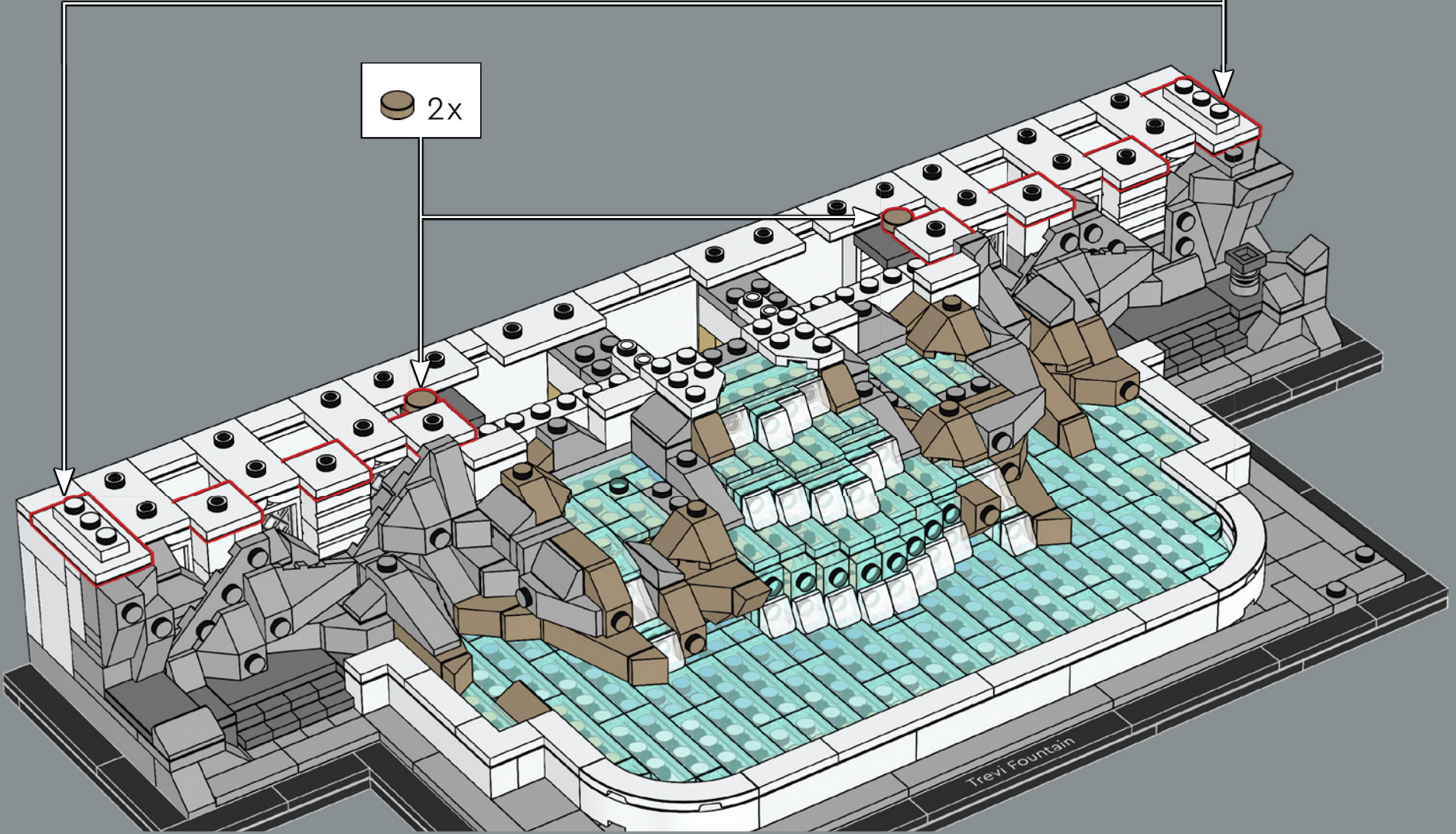
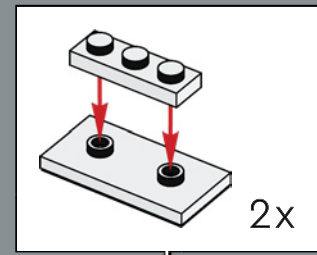

Trevi Fountain



为恰到好处的捕捉立面悬垂和偏移部分的细节和间距，我们在标准乐高®网格和 1/2 板之间来回跳跃。这有助于我们创建顺畅的拼搭流程和坚固的结构。

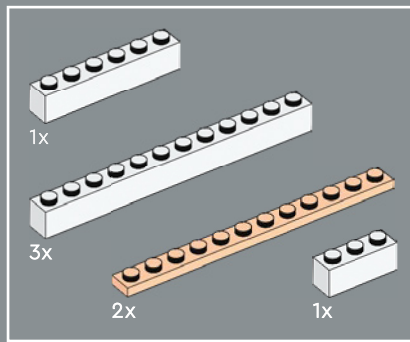

149

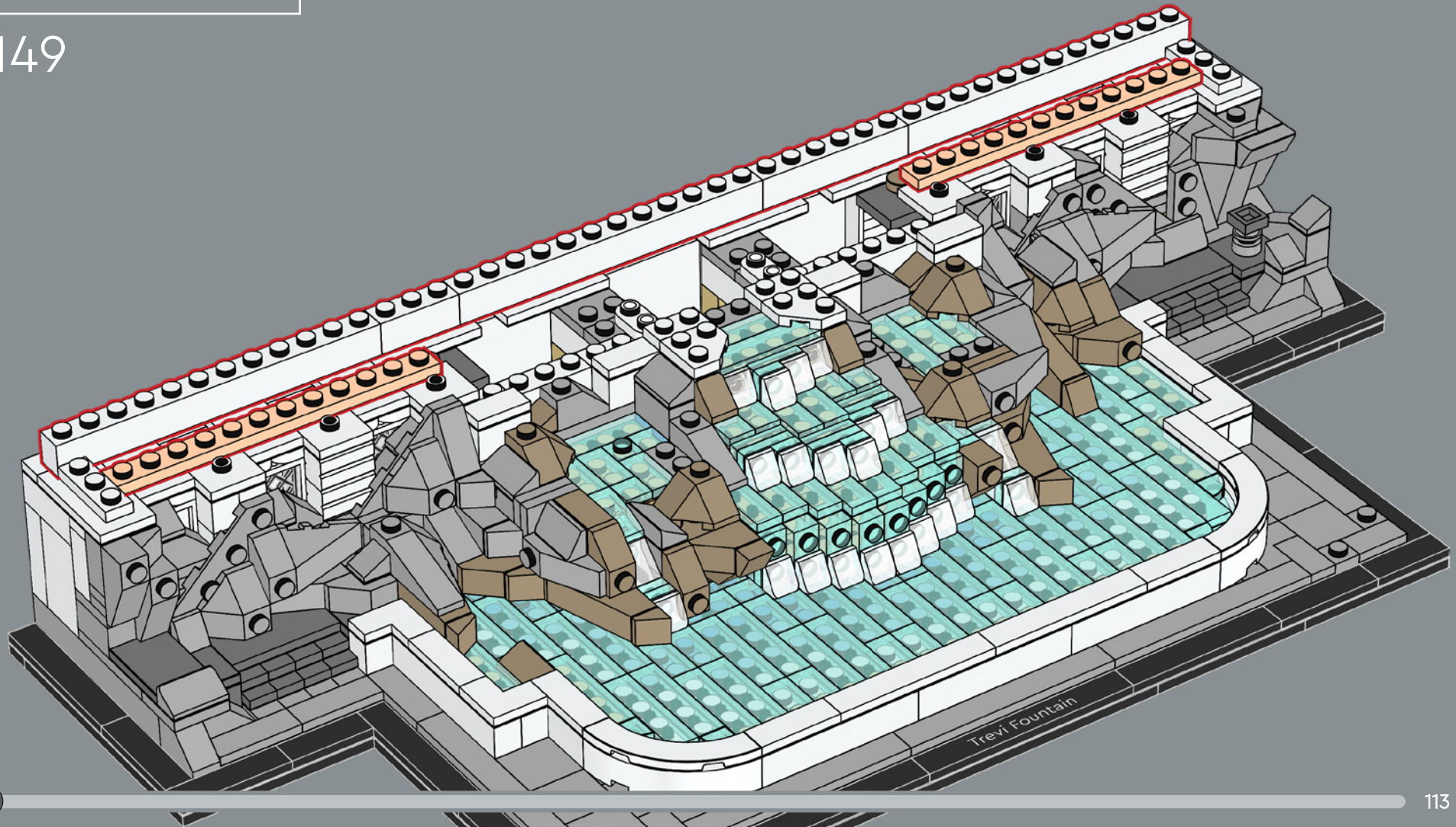



6x

150



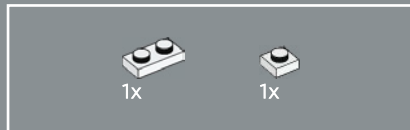
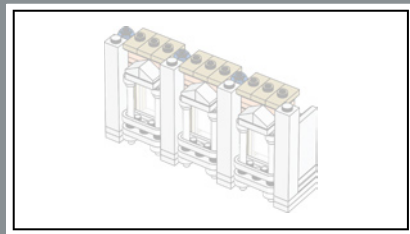

151

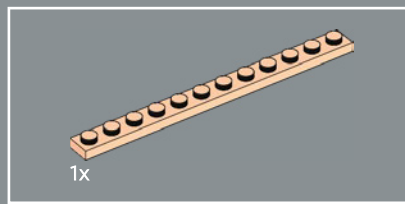
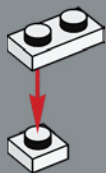

152

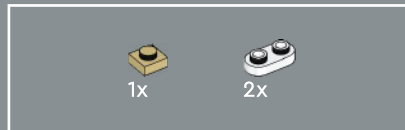
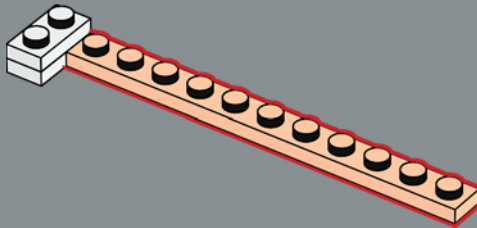

153

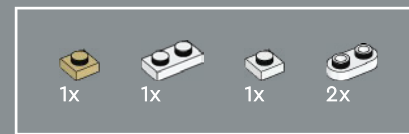
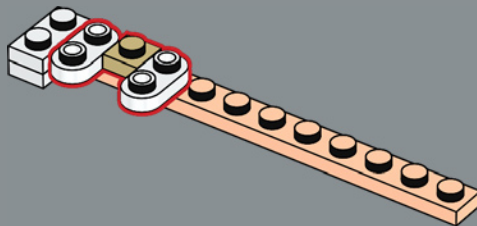

154

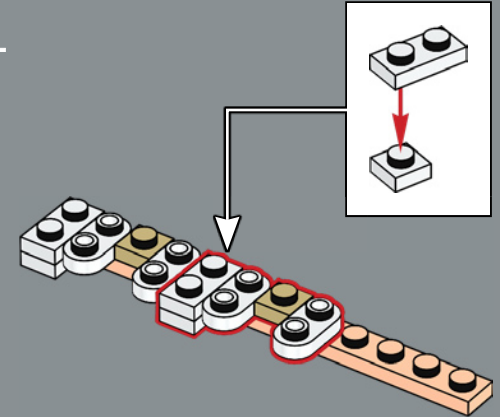

155

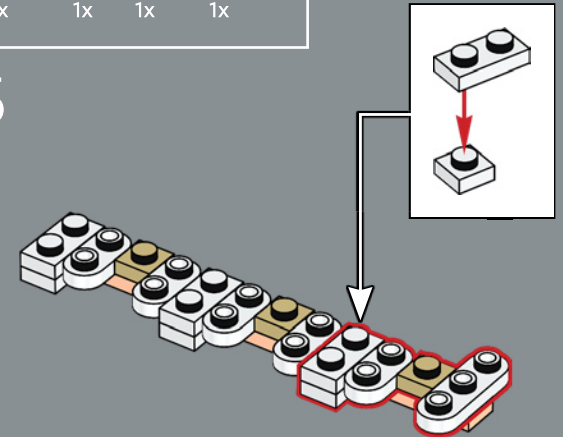

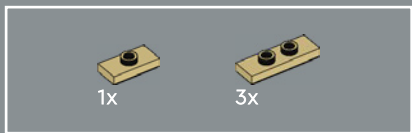

156

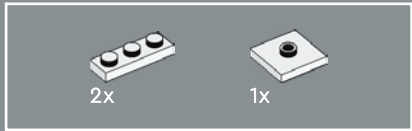
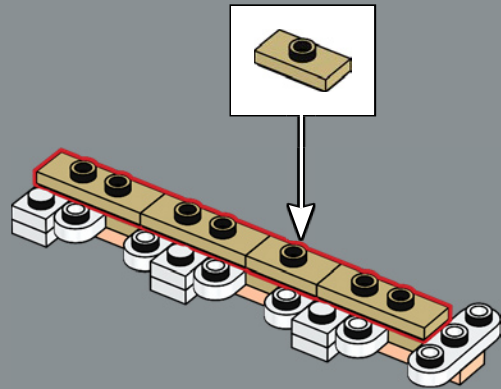

157

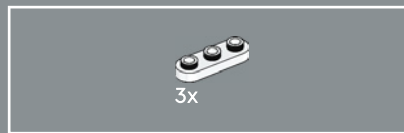
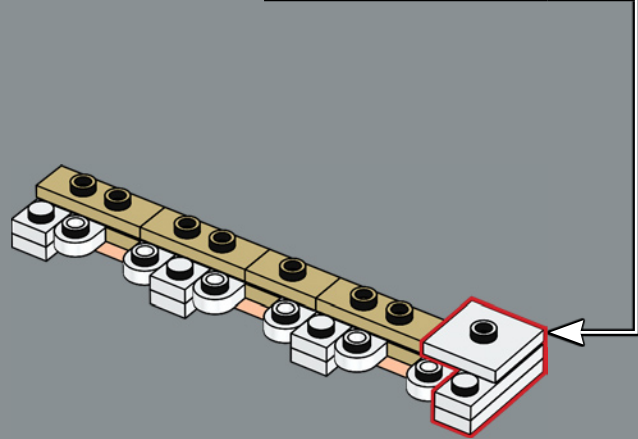
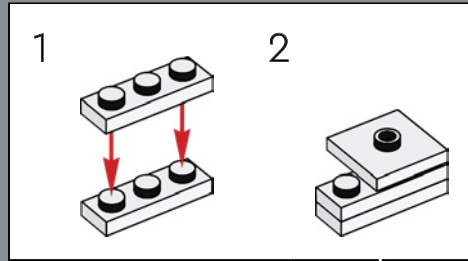

158

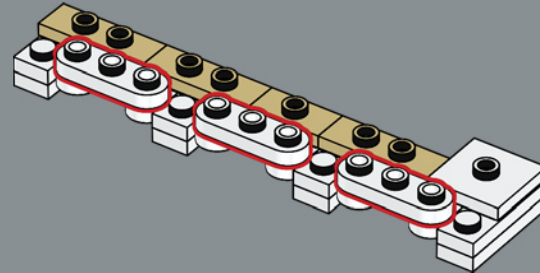

159

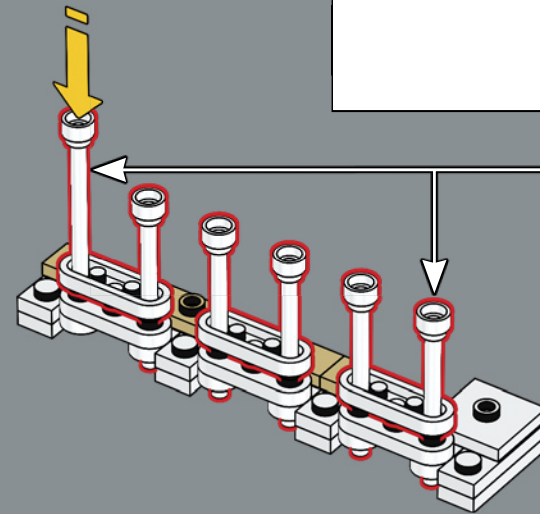
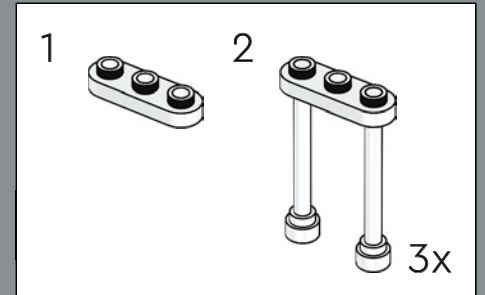

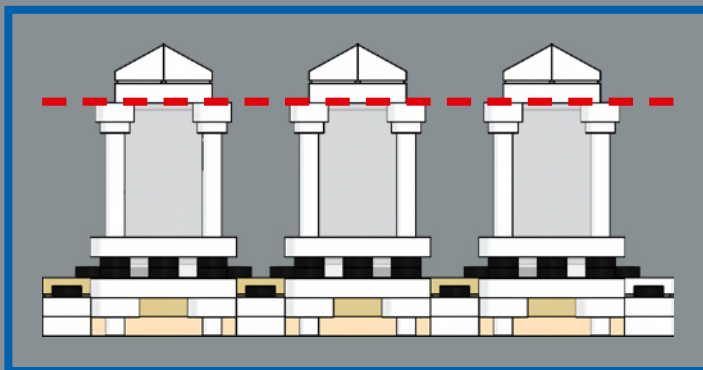
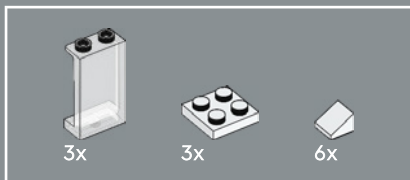

160

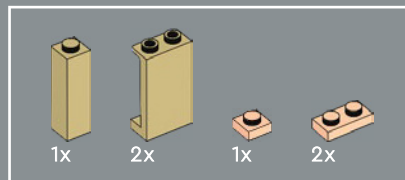
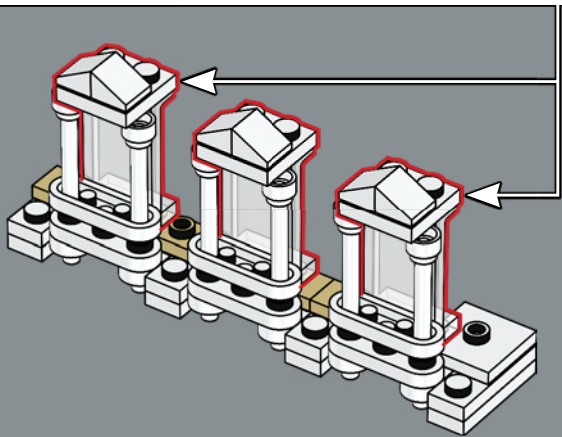
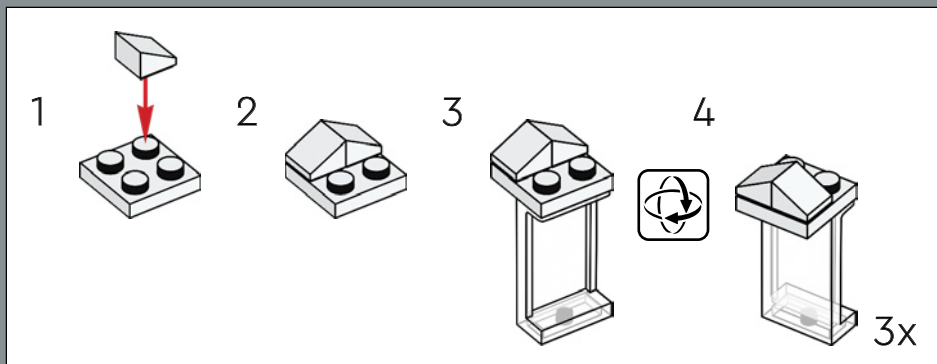

161

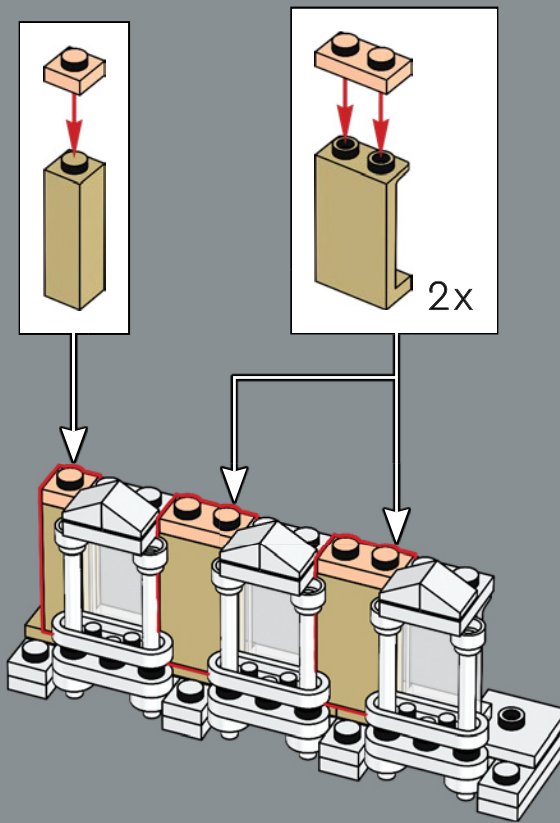

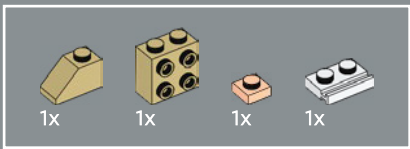

162

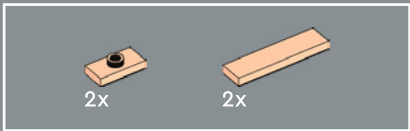
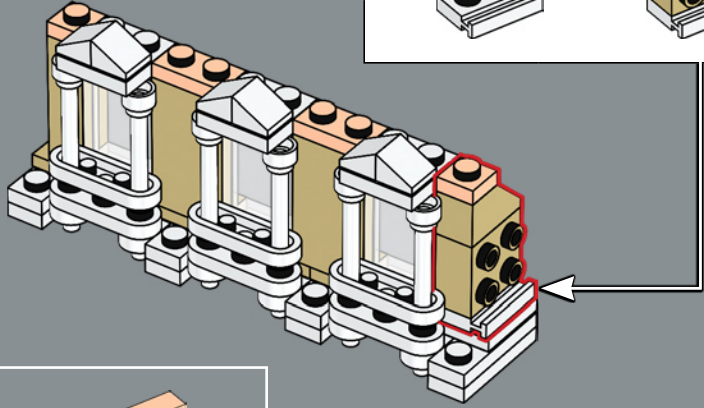
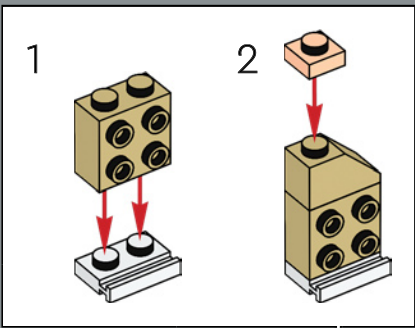

163

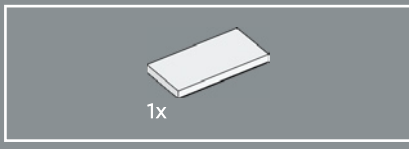
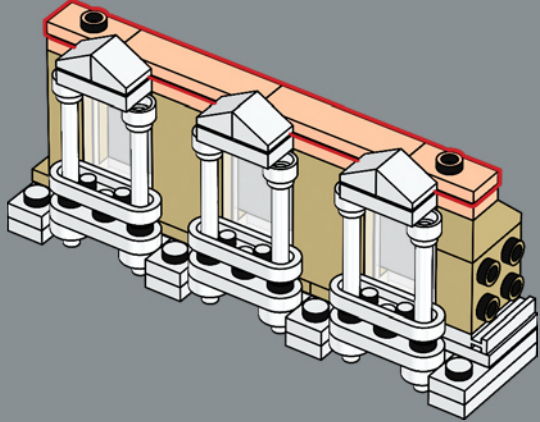

164

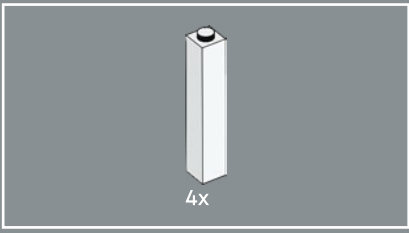
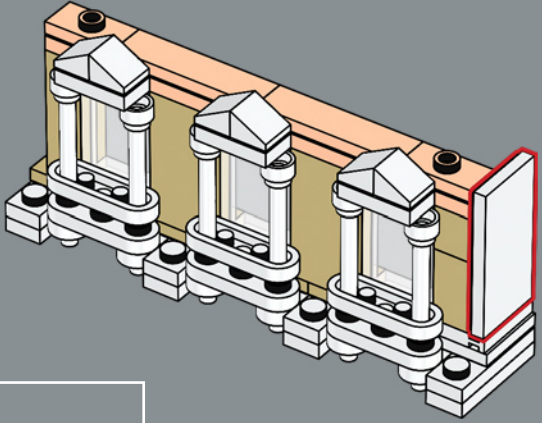

165

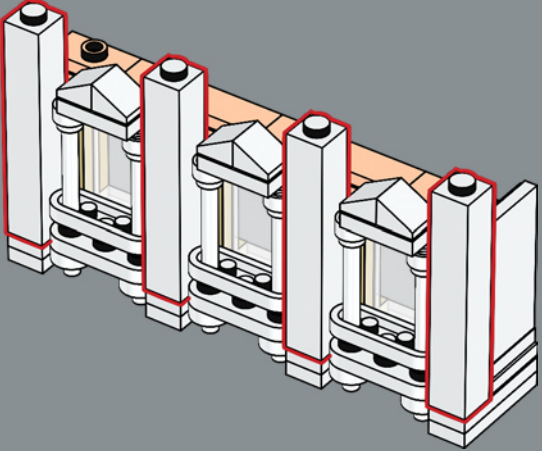

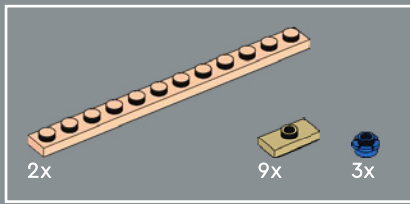

166

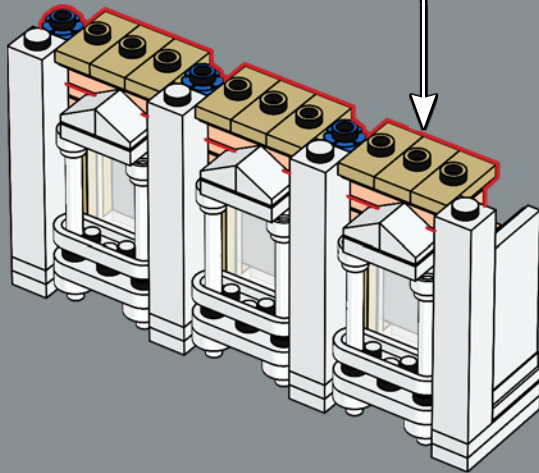
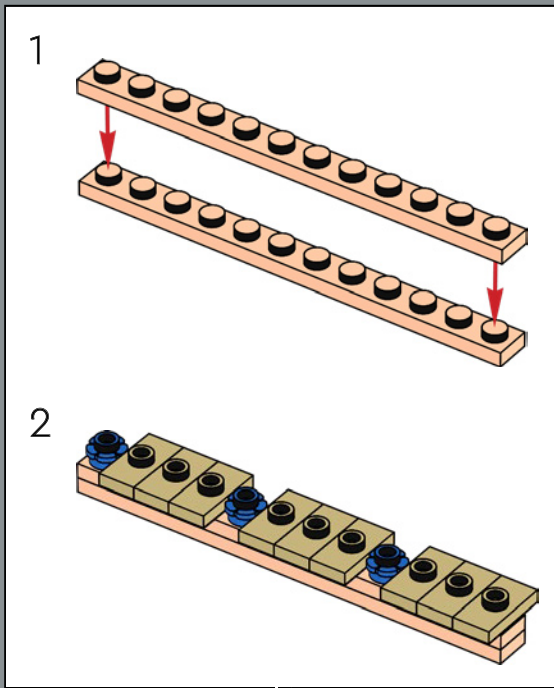

167

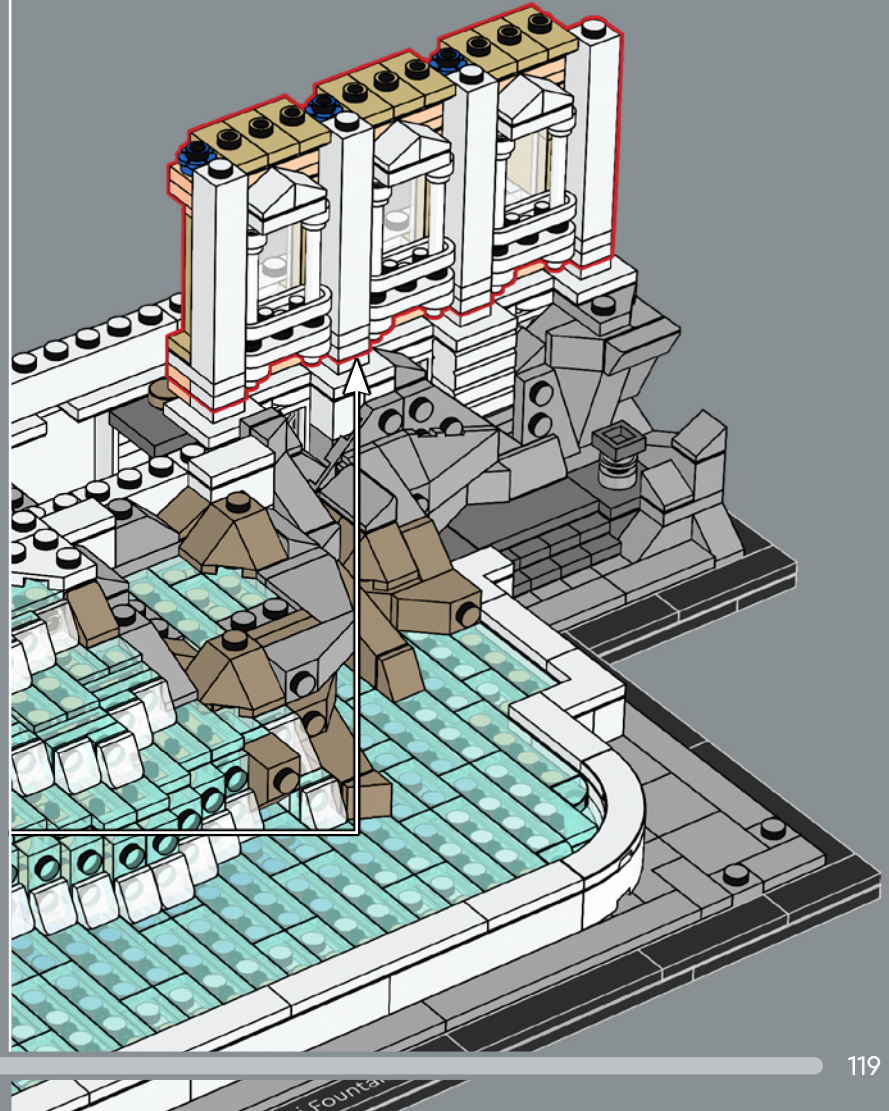

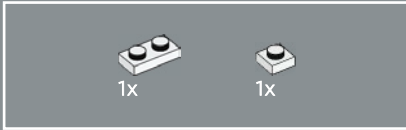
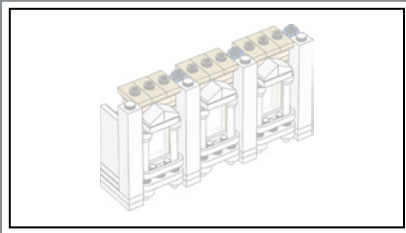

168

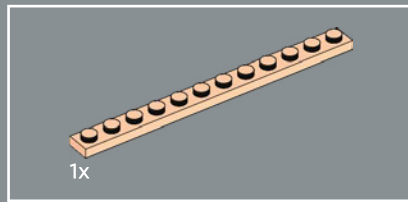
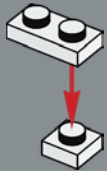

169

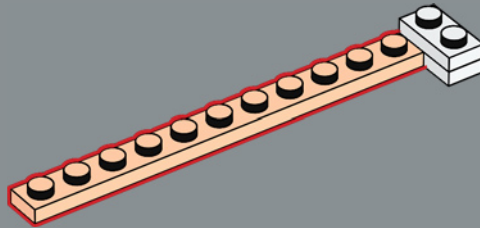

170

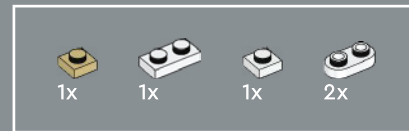
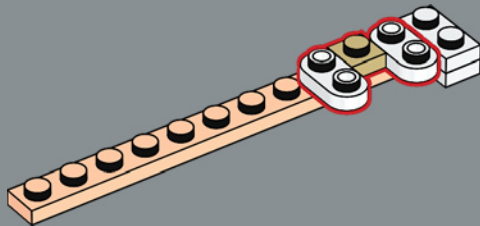

171

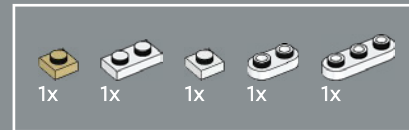
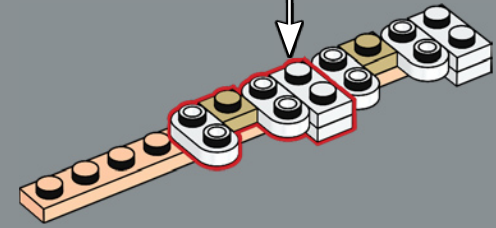
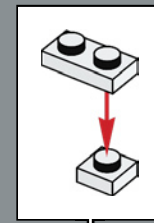

172

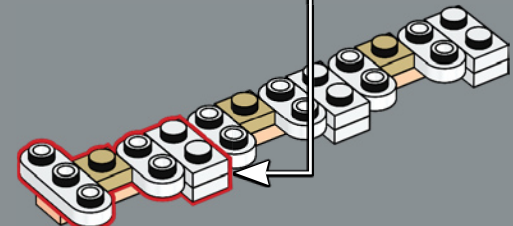
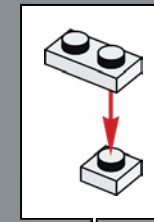



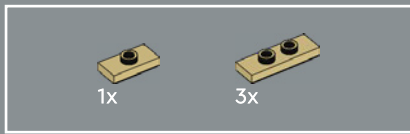

173

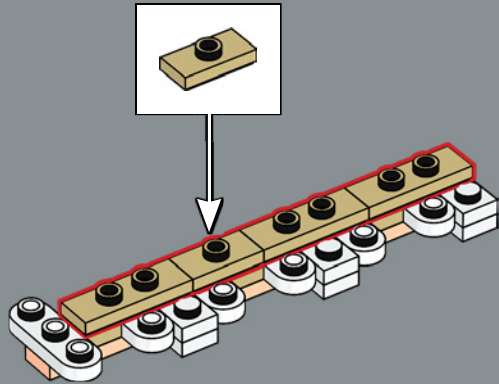

174

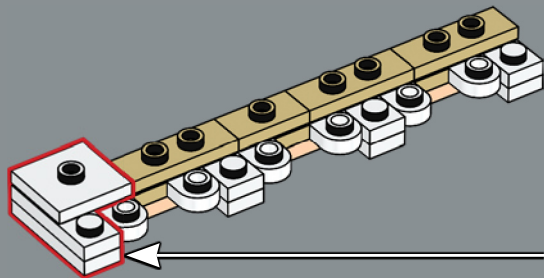
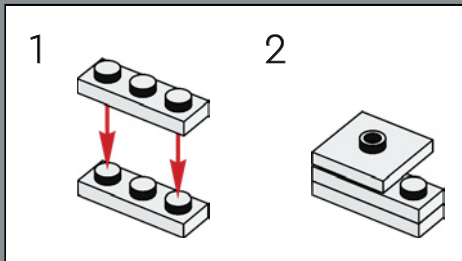

175

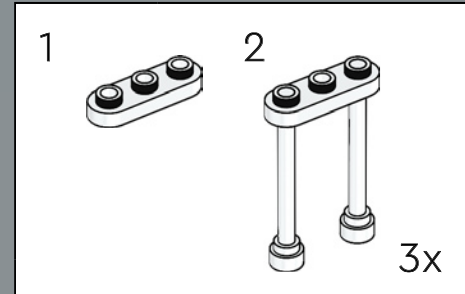
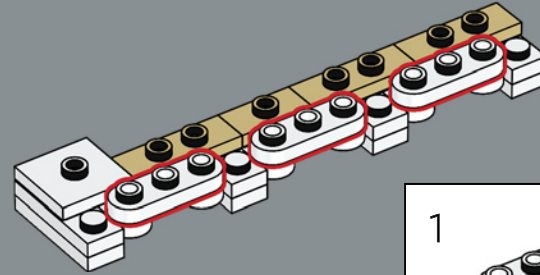

176

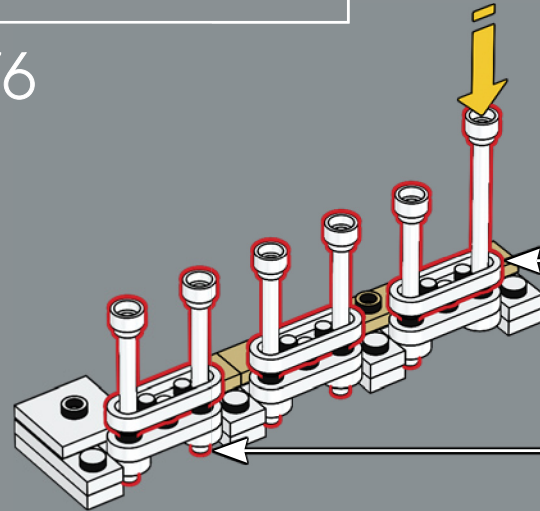

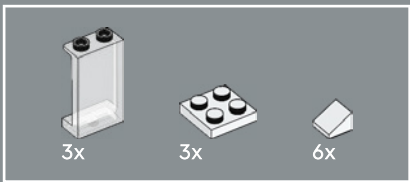

177

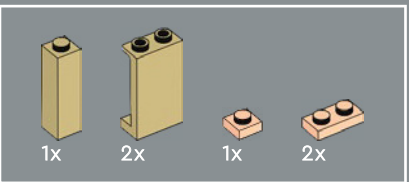
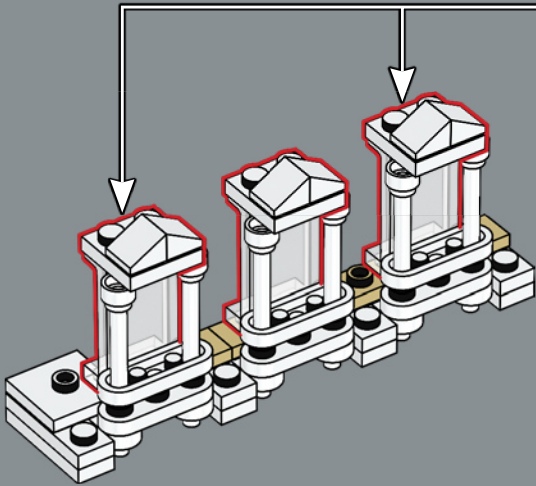
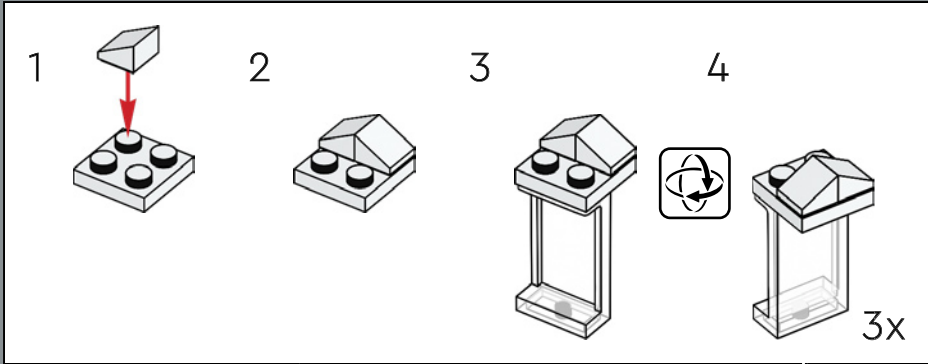
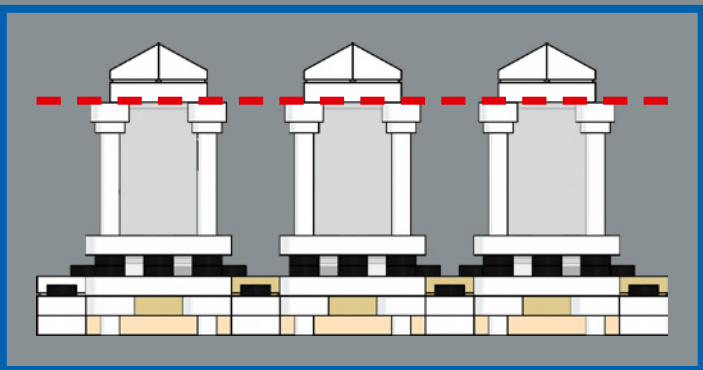

178

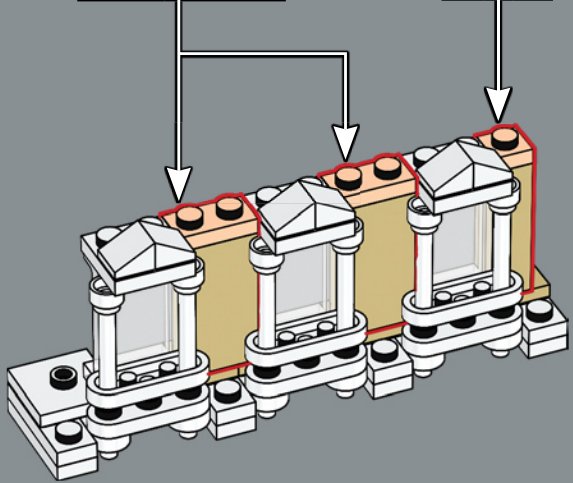
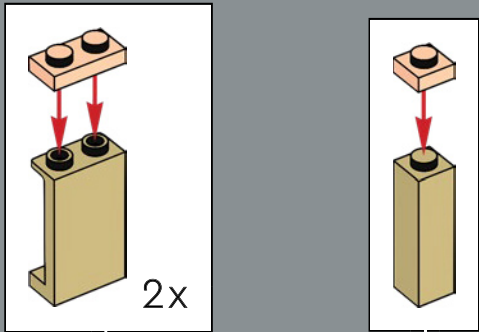

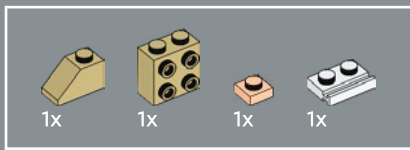

179

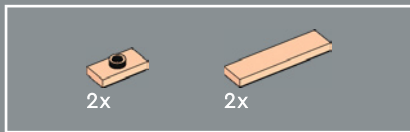
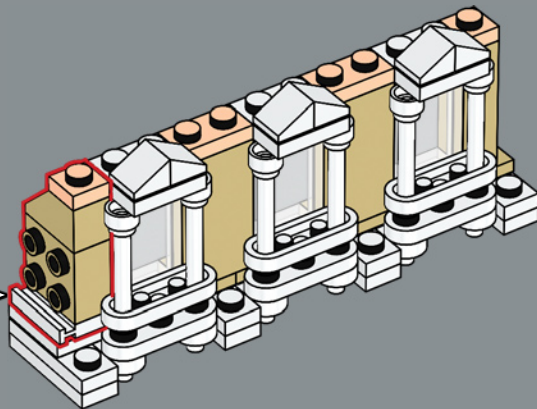
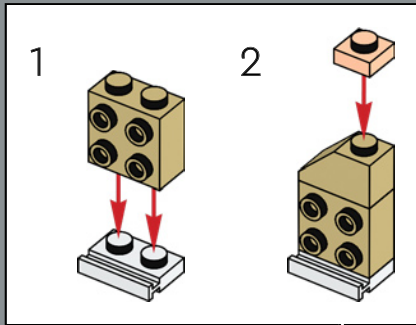

180

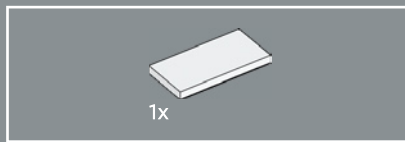
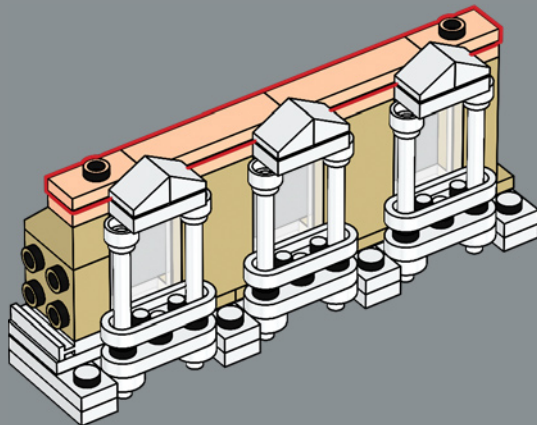

181

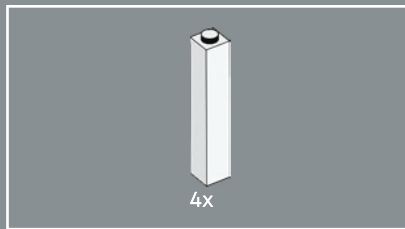
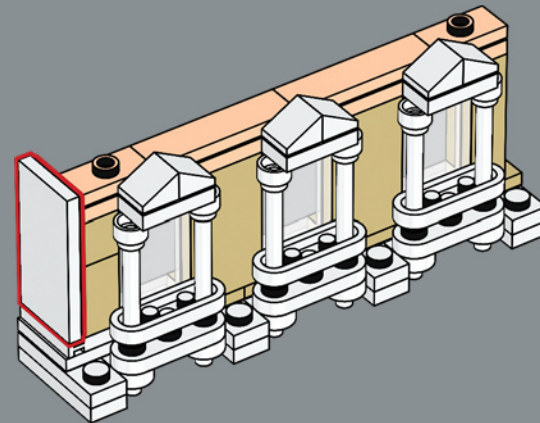

182

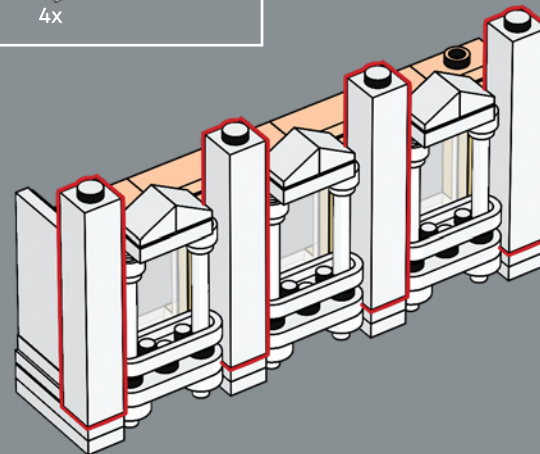

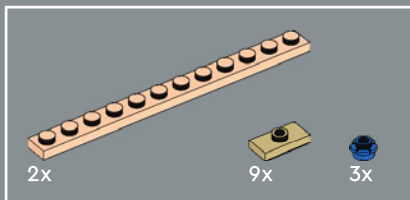

183

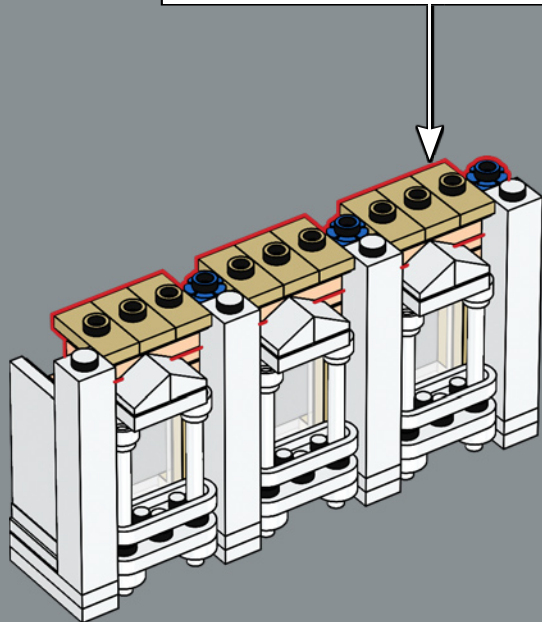
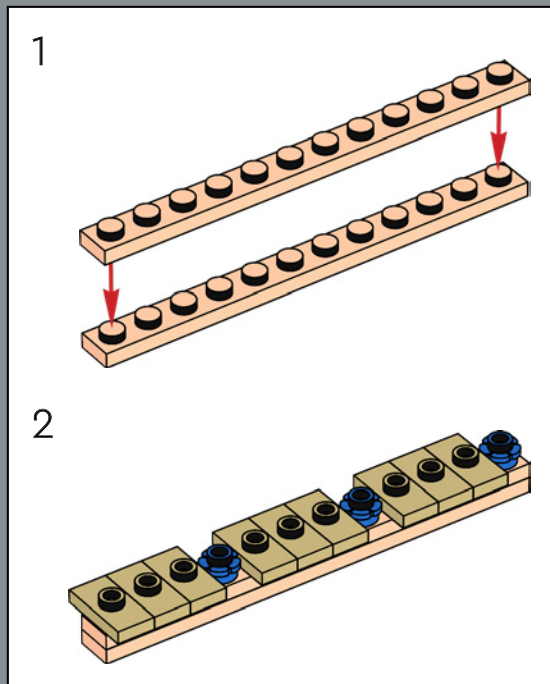

沙色是为喷泉阴影最深的区域保留的,其位于悬垂部分下方和窗户装饰的后面。

184

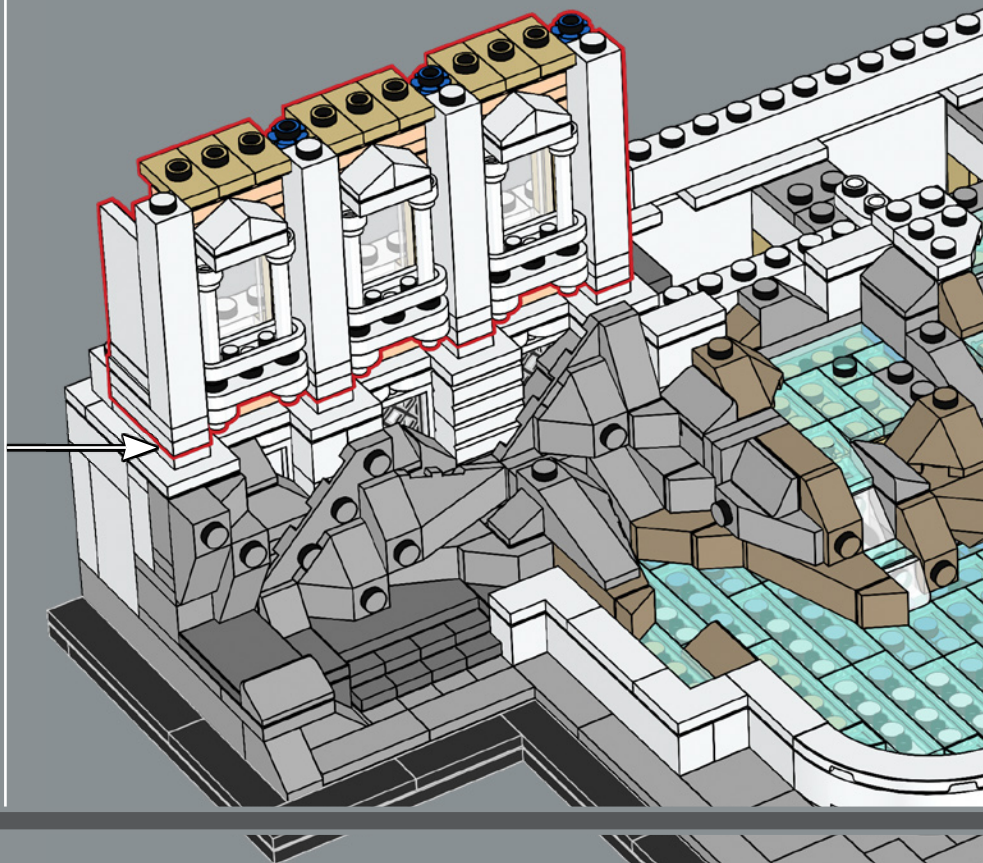

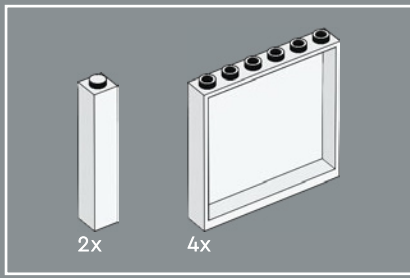

185

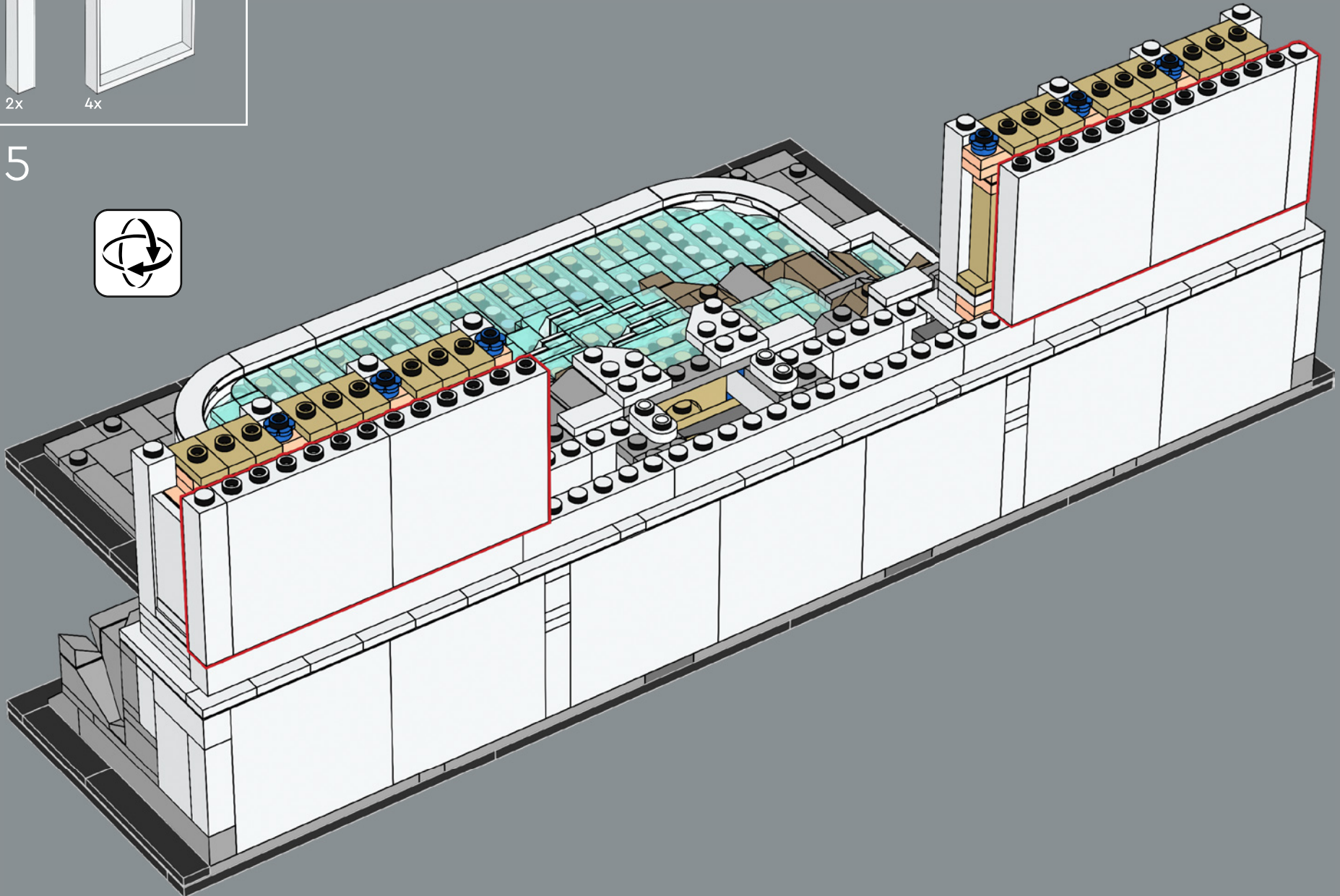

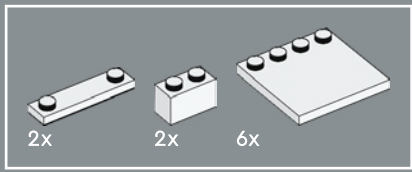

186

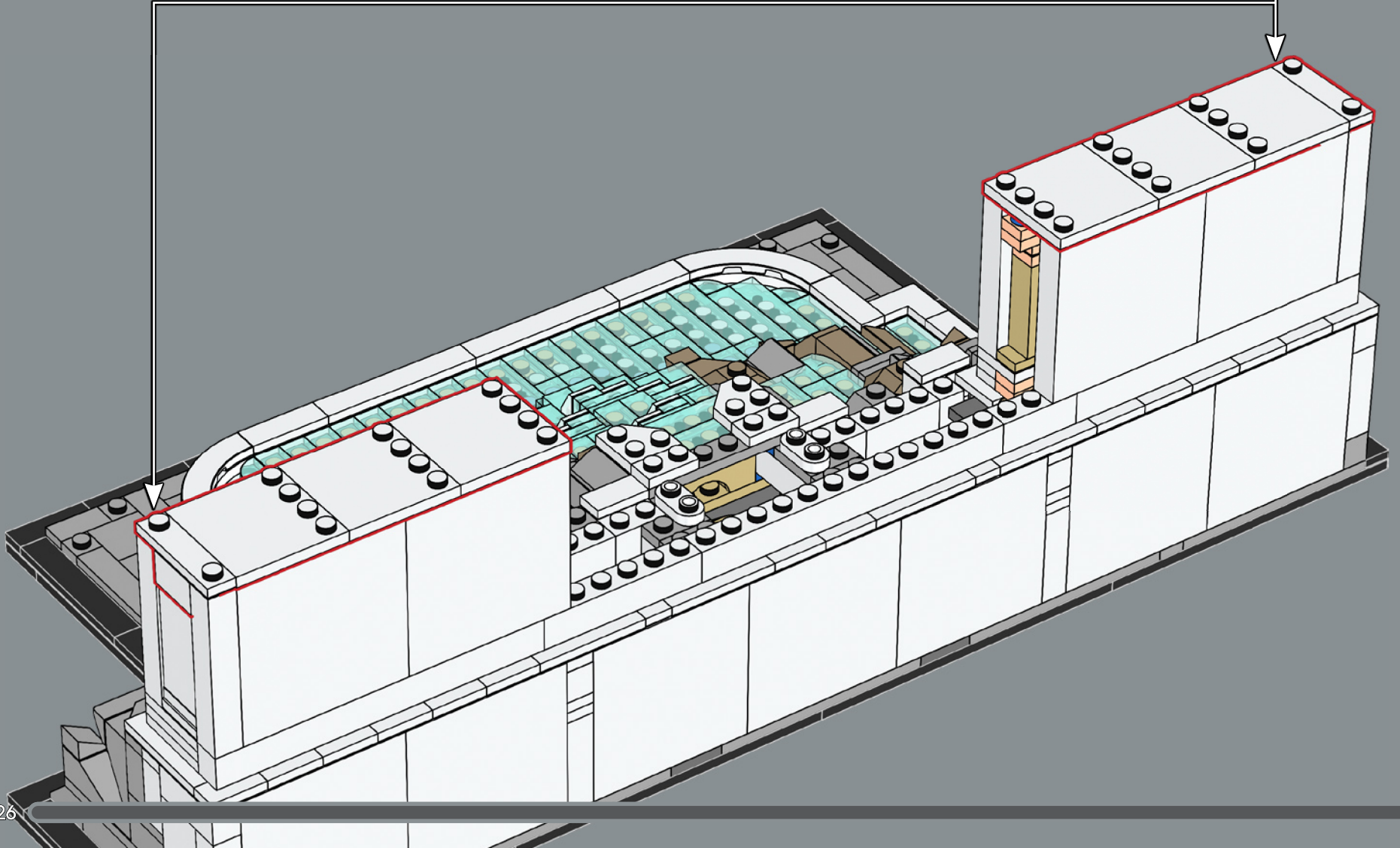
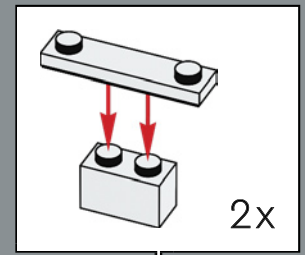

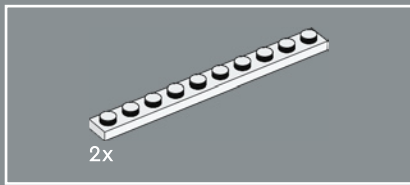

187

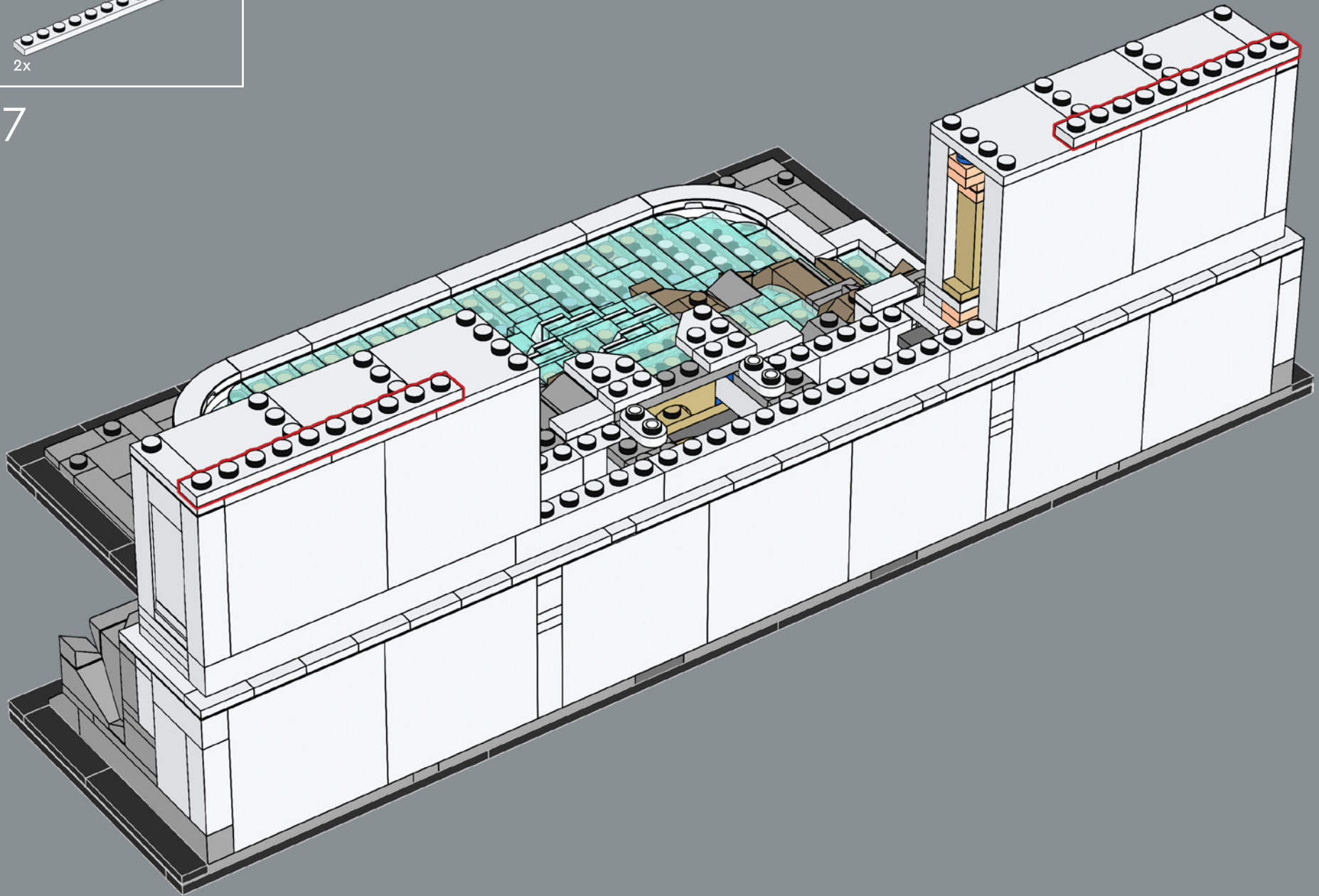

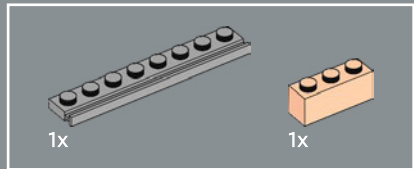
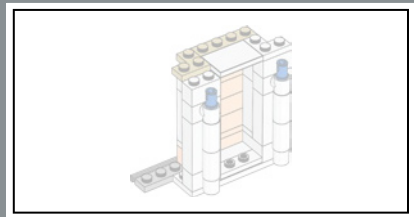

188

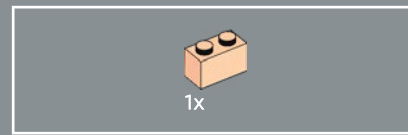
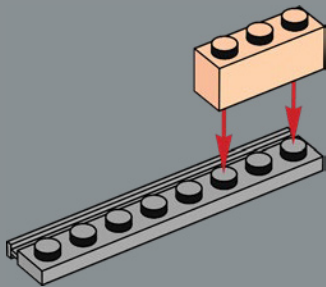

189

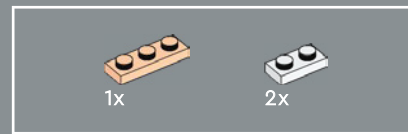
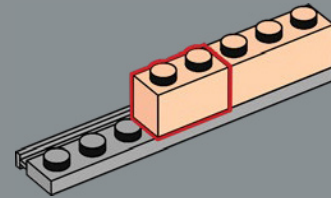

190

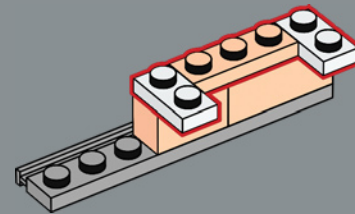



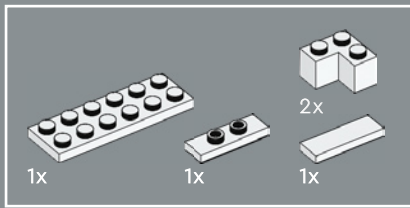

191

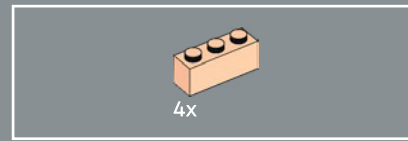
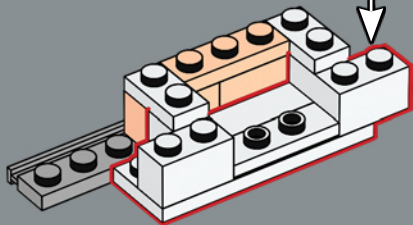
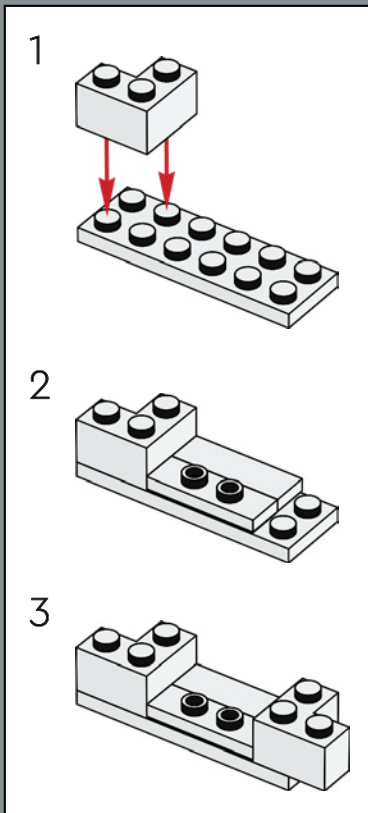

192

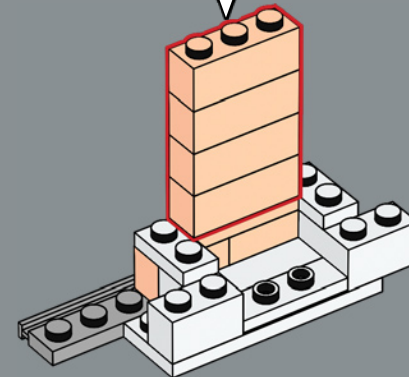
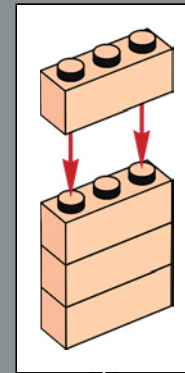

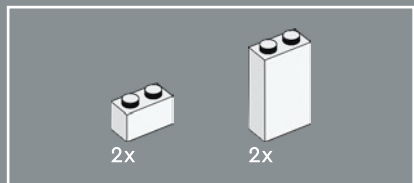

193

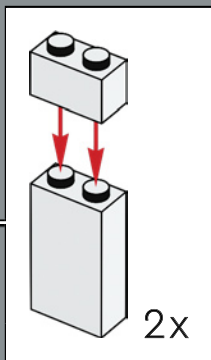
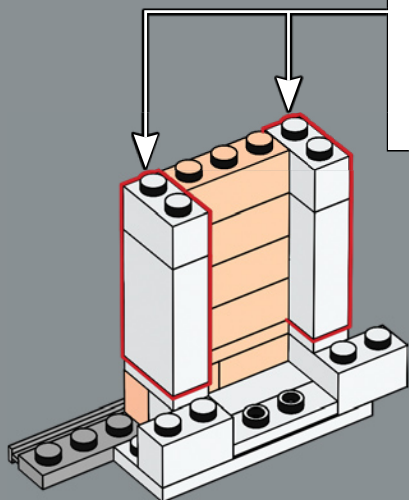

2x

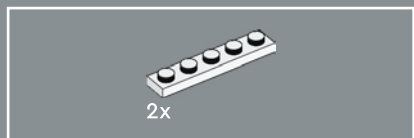

194

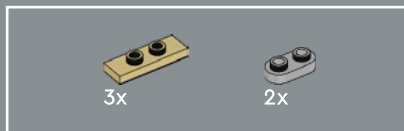
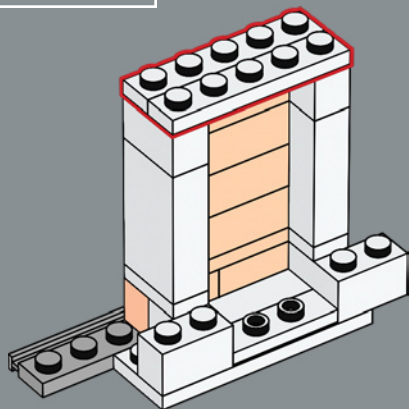

195

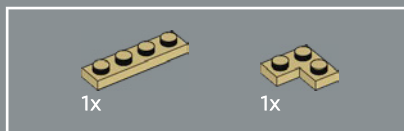
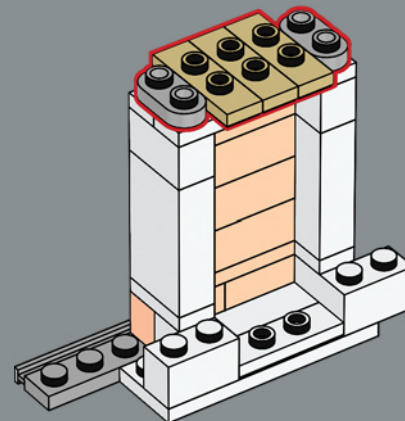

196

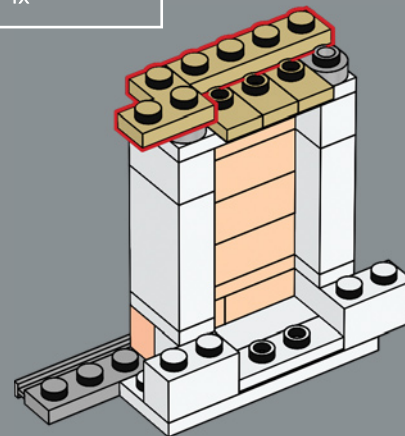

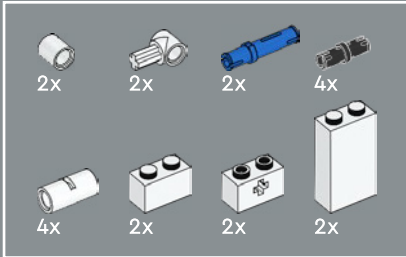
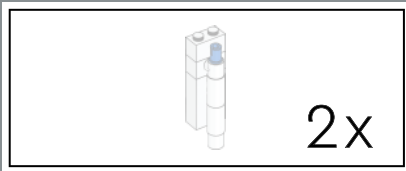

197

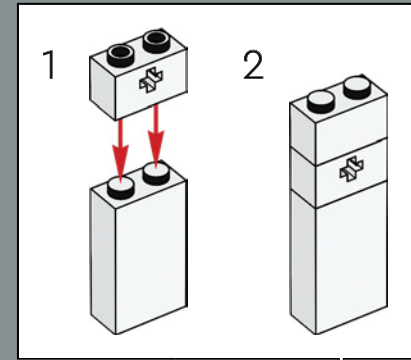
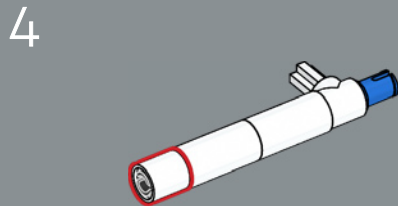
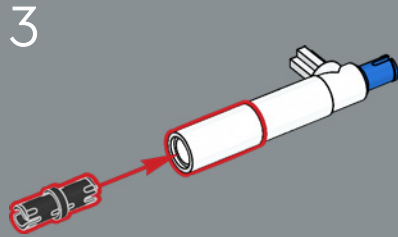
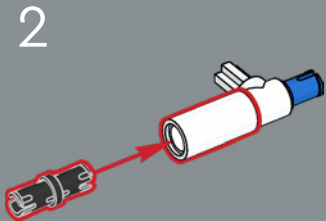
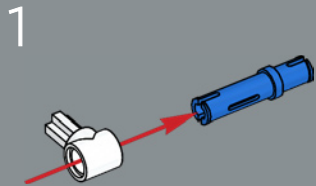

5

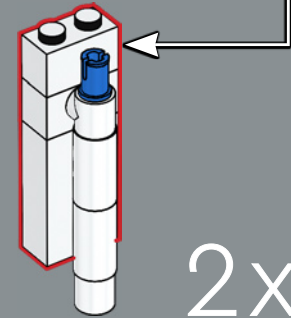
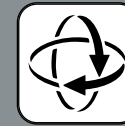

2x

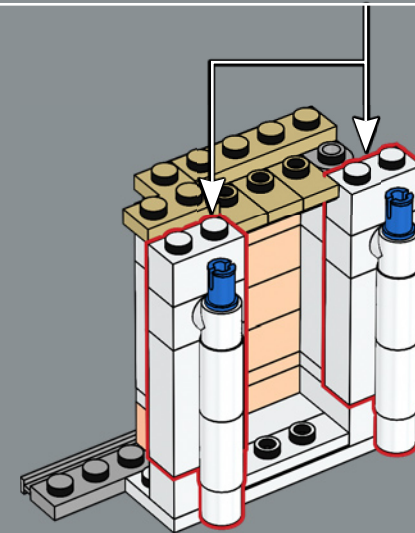

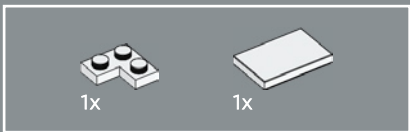

198

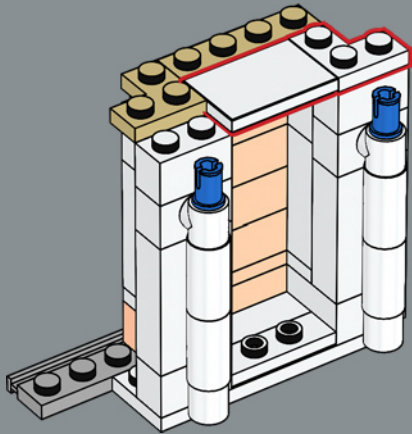

199

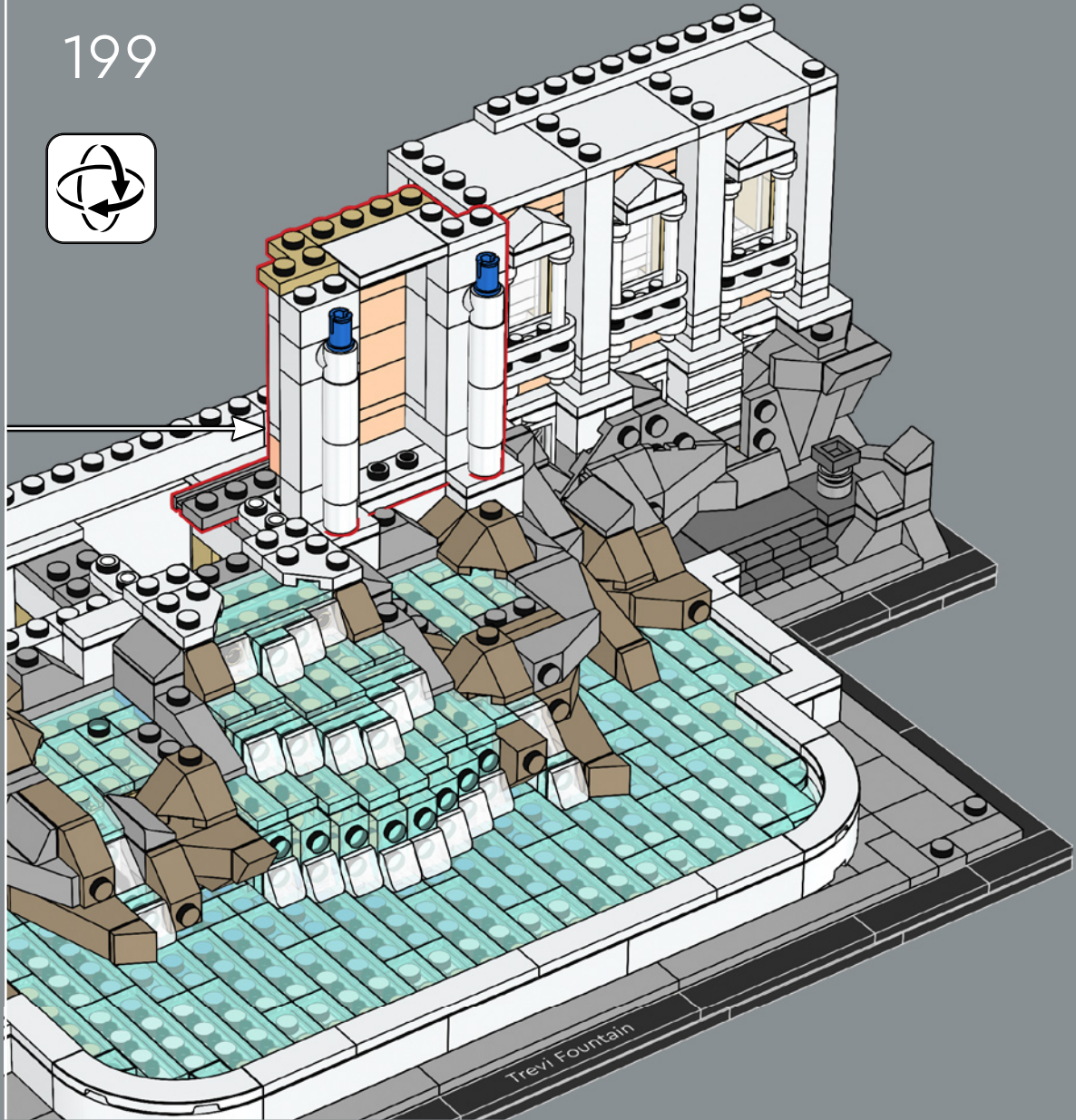

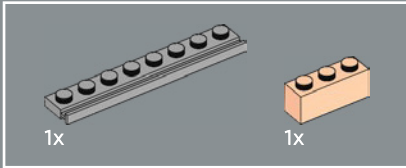
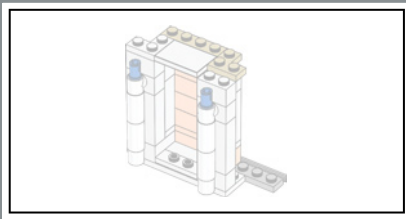

200

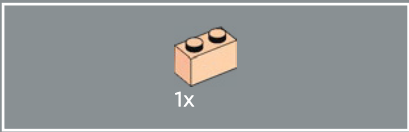
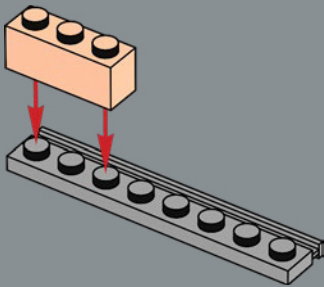

201

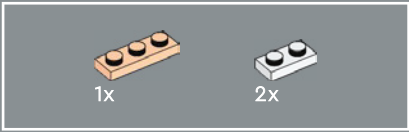
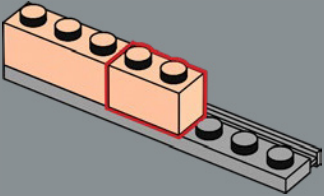

202

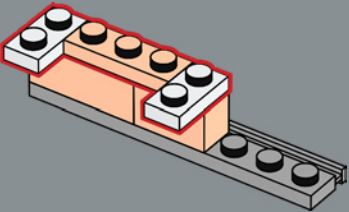

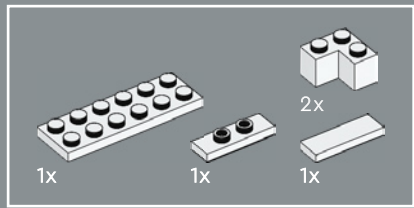

203

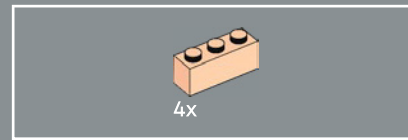
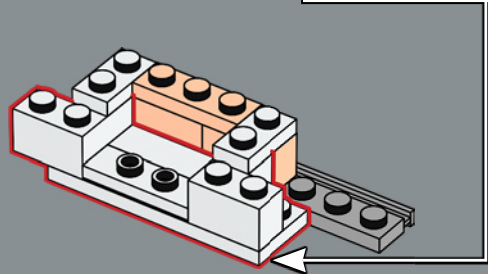
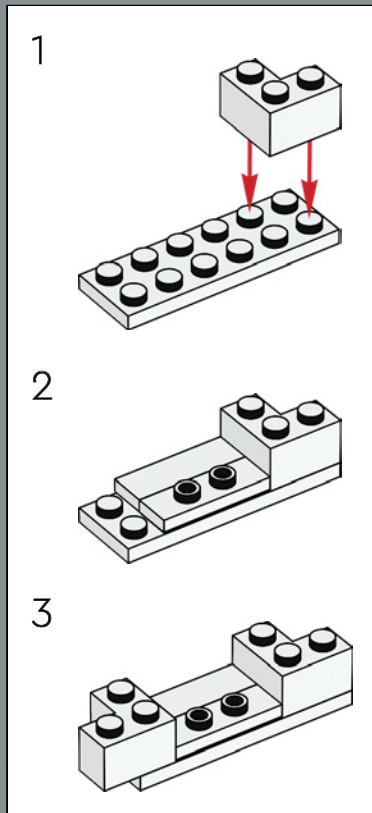

204

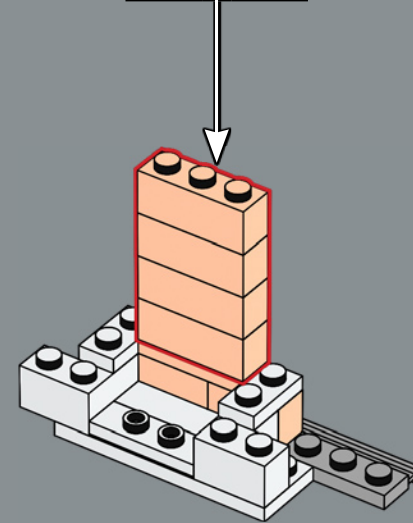
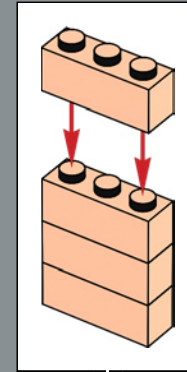

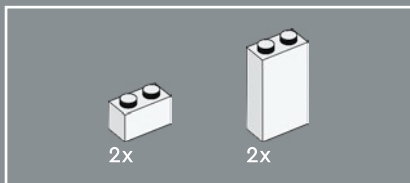

205

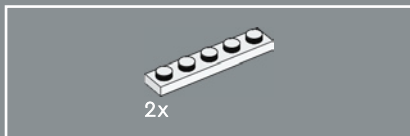
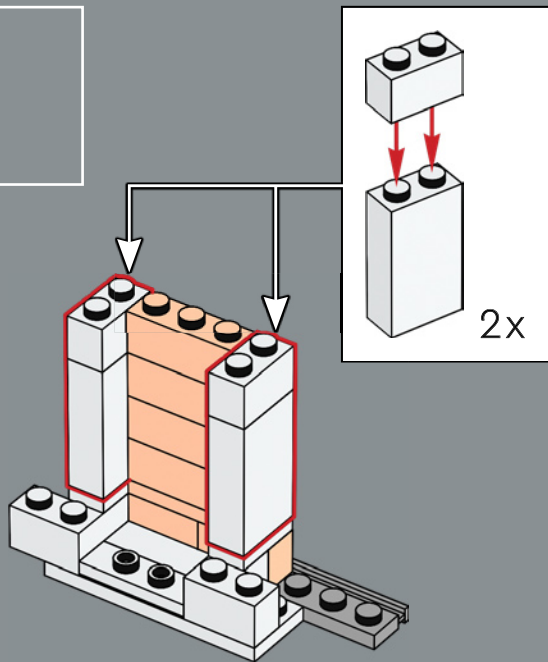

206

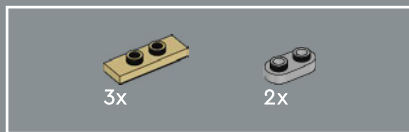
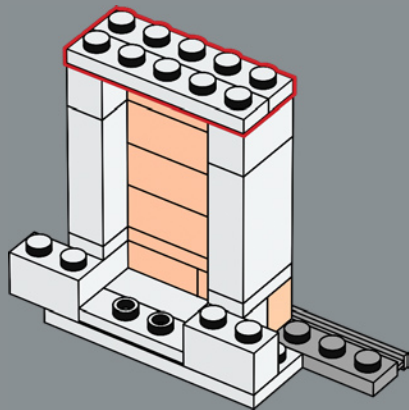

207

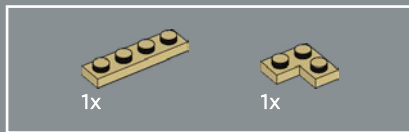
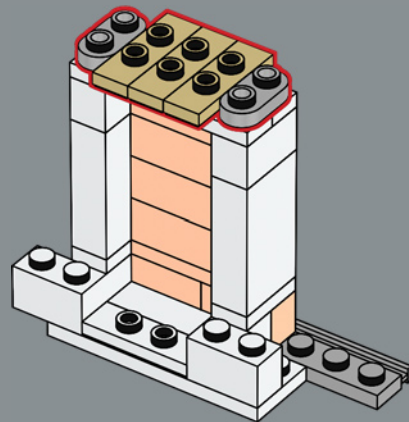

208

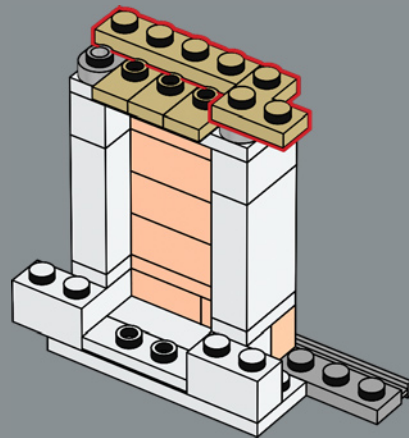

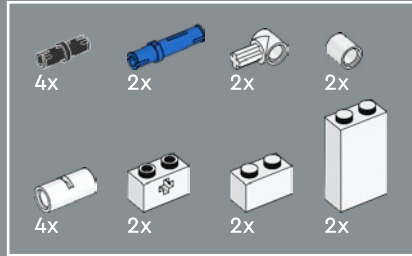
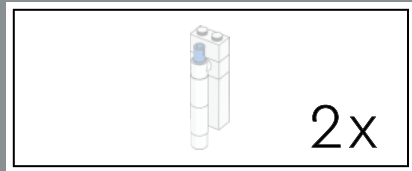

209

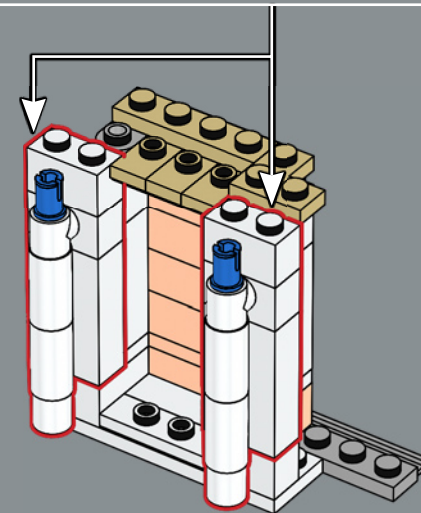
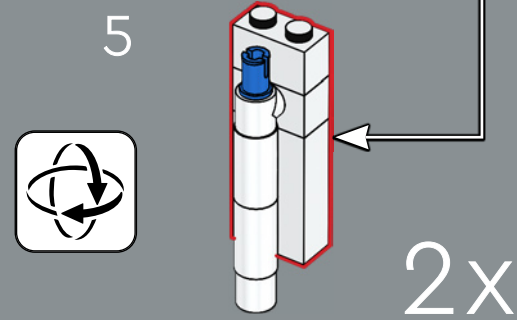
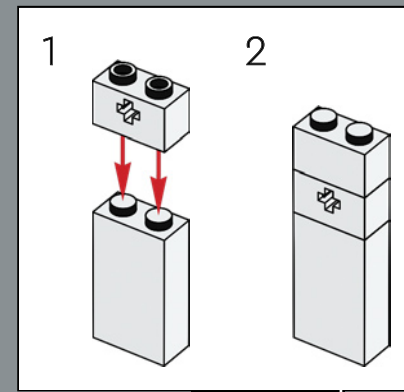
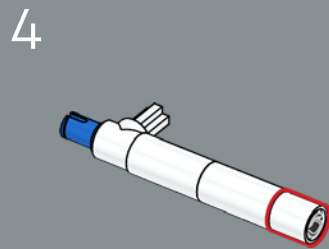
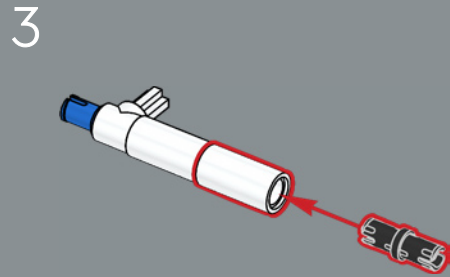
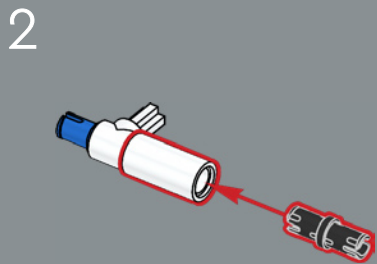
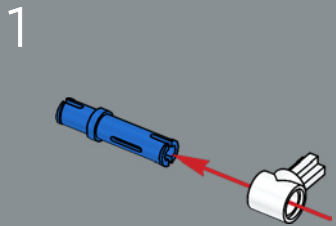



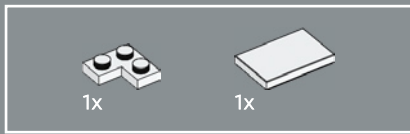

210

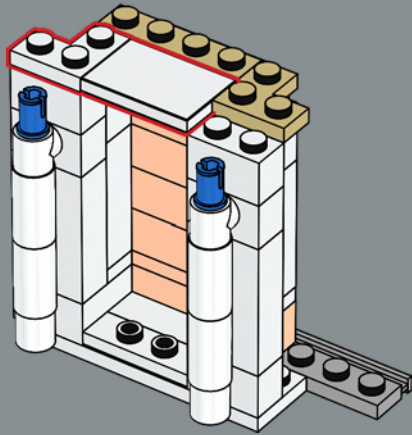

211

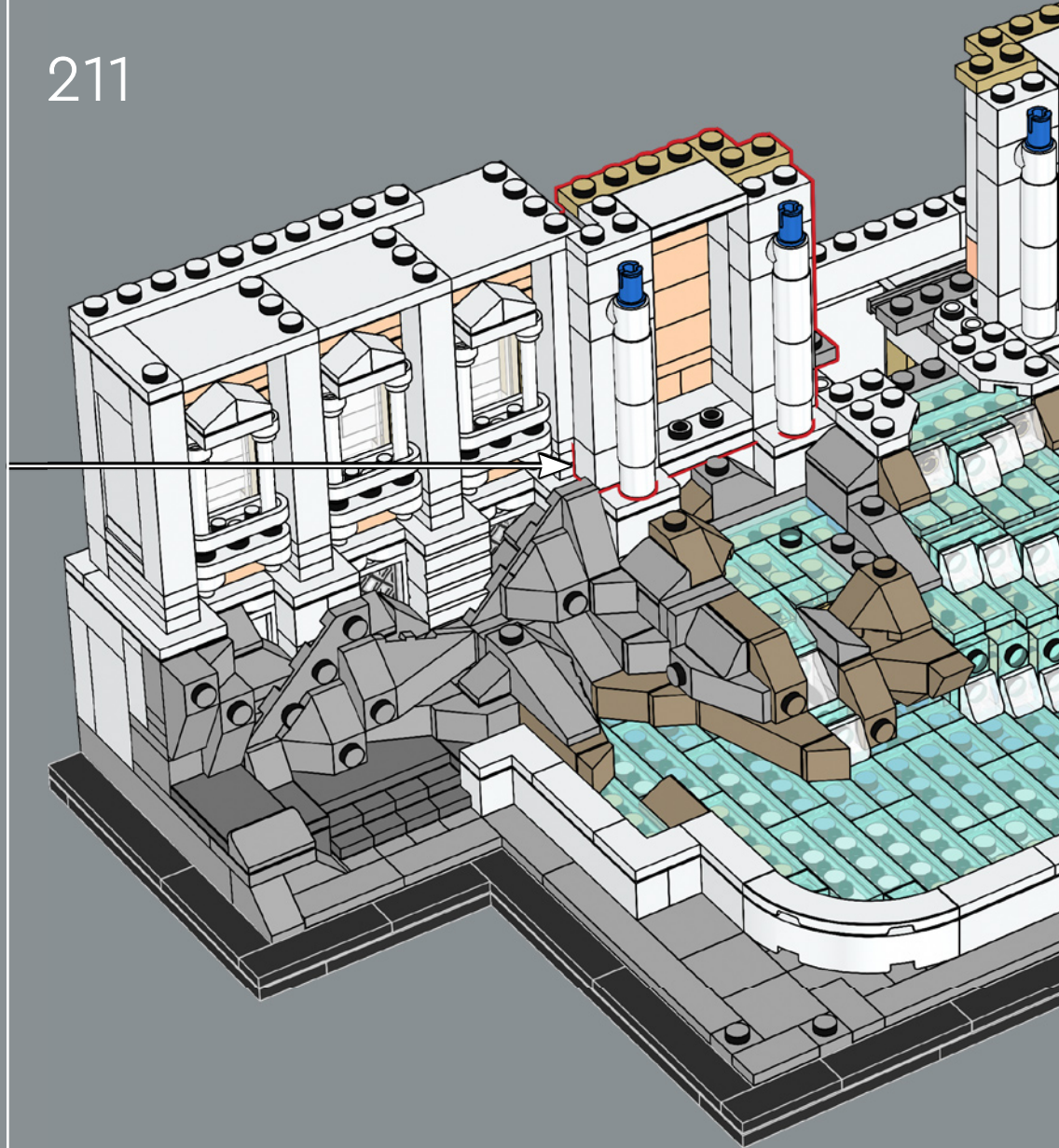

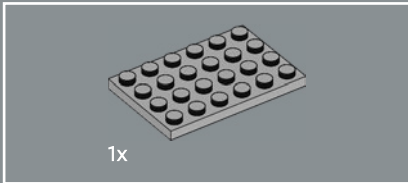
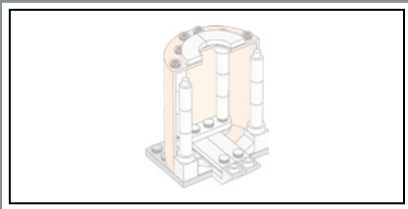

1x

212

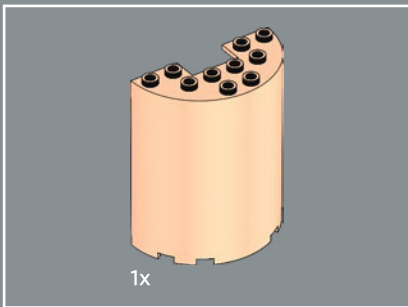
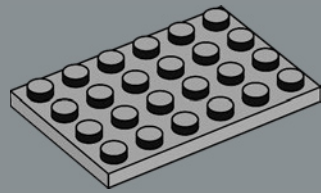

1x

213

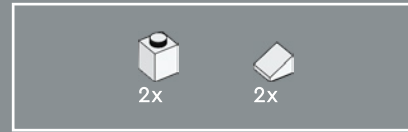
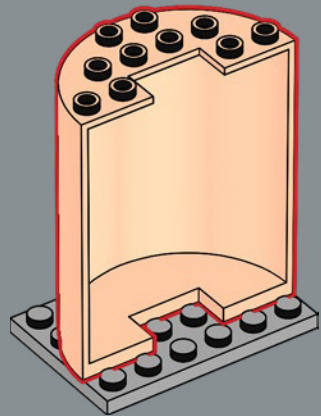

2x

2x

214

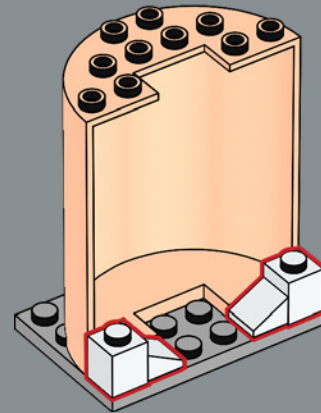

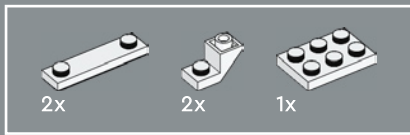

215

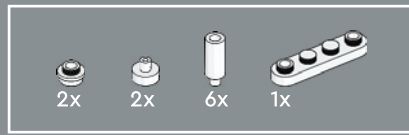
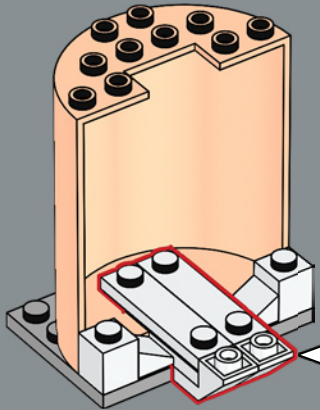
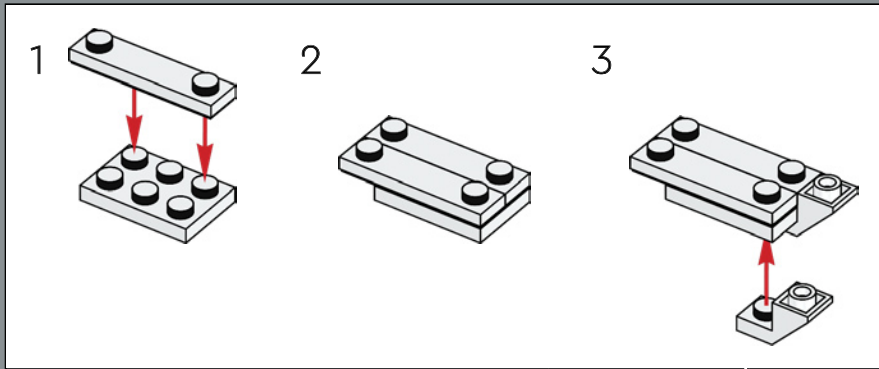

216

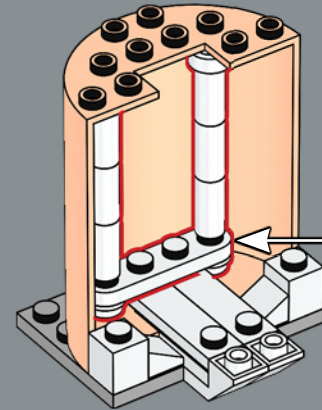
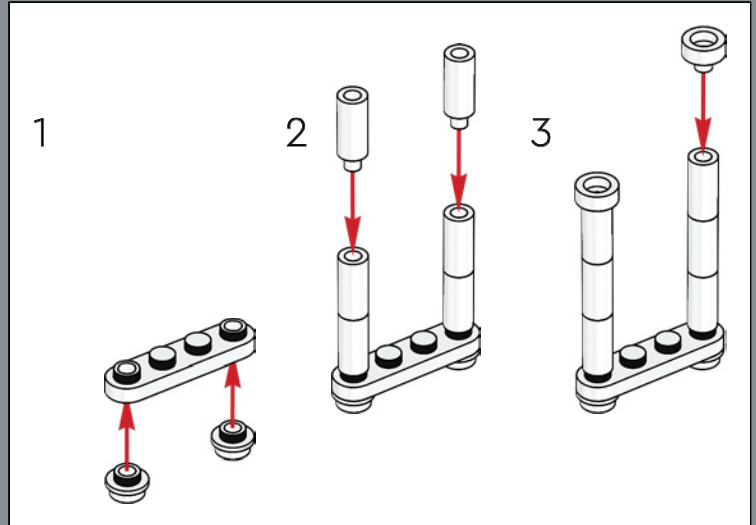



217

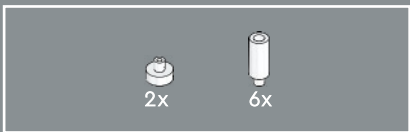
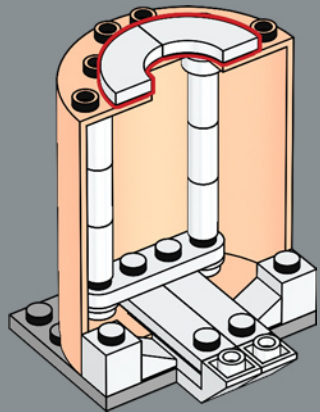

218

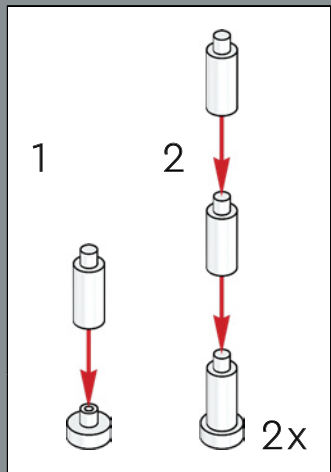
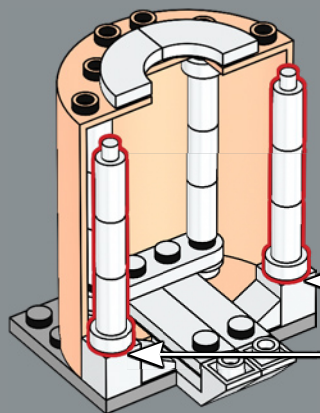

219

整个立面被分成九个垂直部分，以留出中心点。  
 乐高® 积木复刻这一点需要奇数数量的模块和  
 跨越板，从而使主拱门居中。

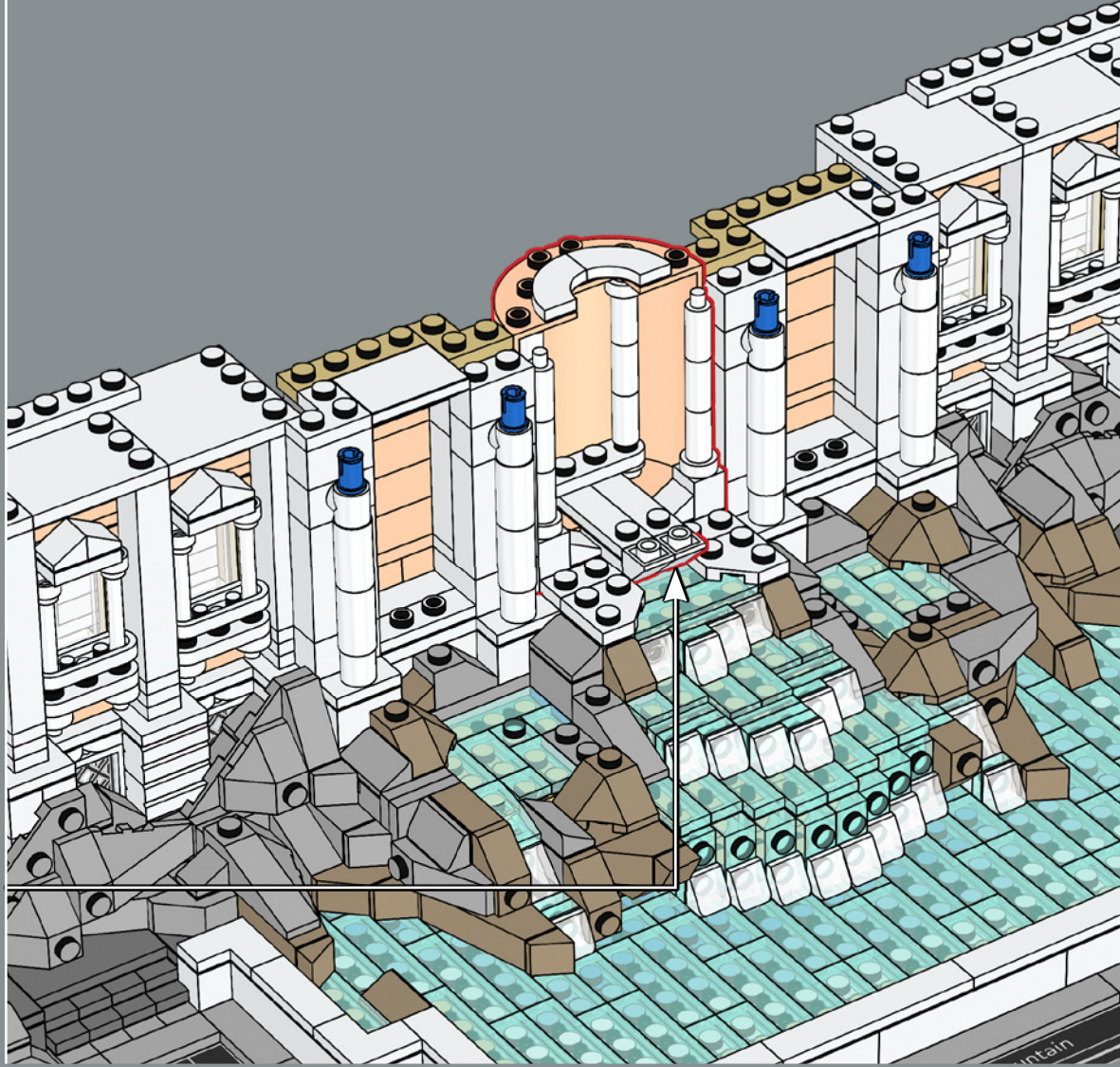

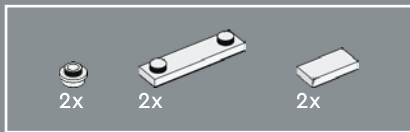

220

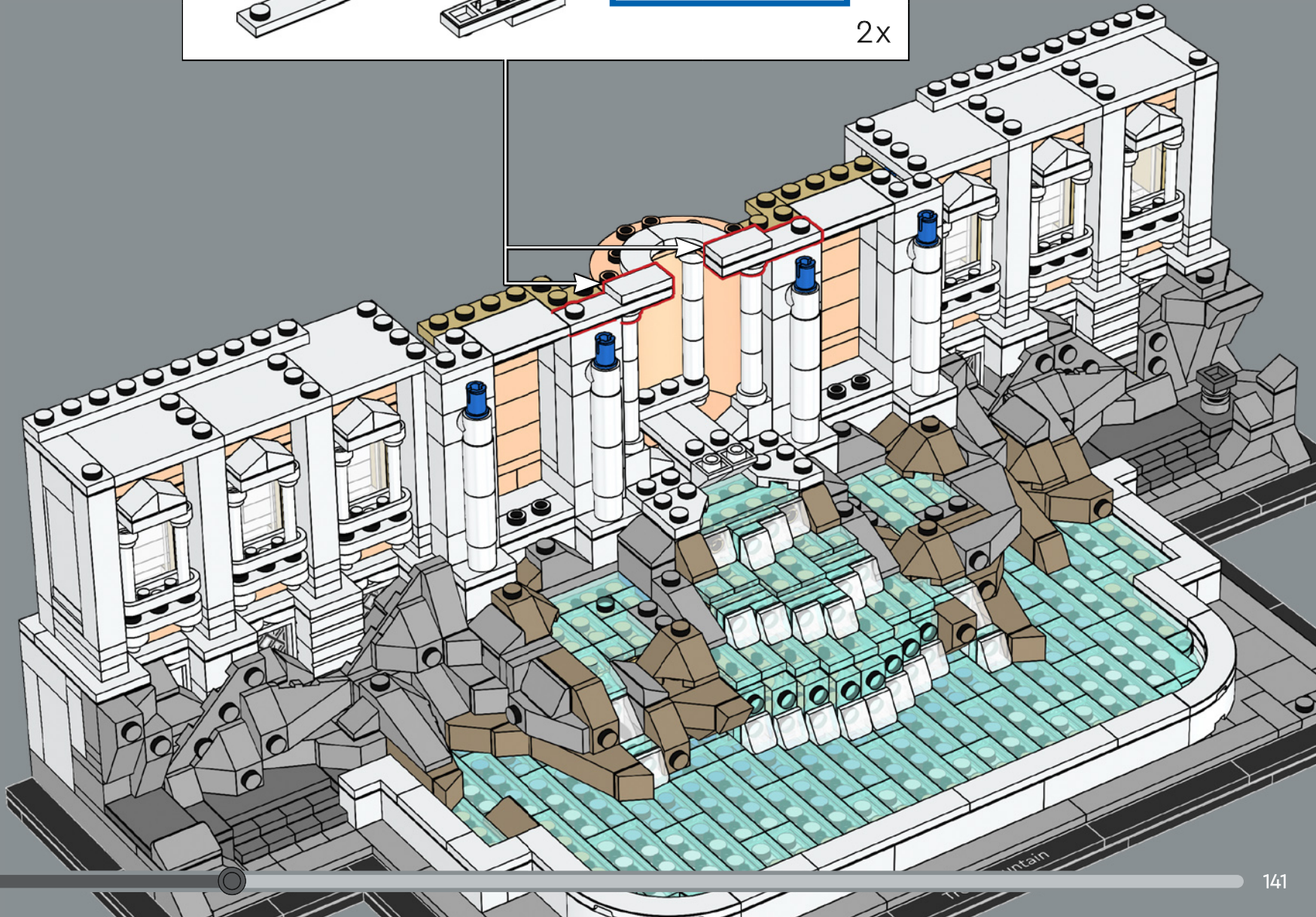
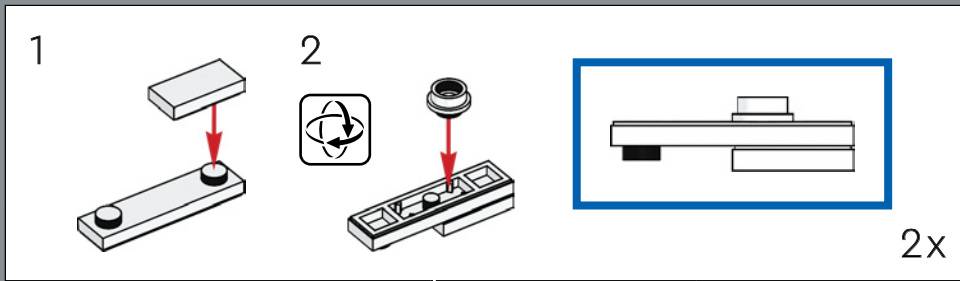

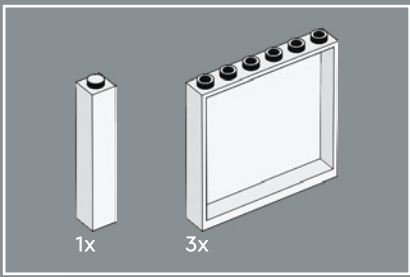

221

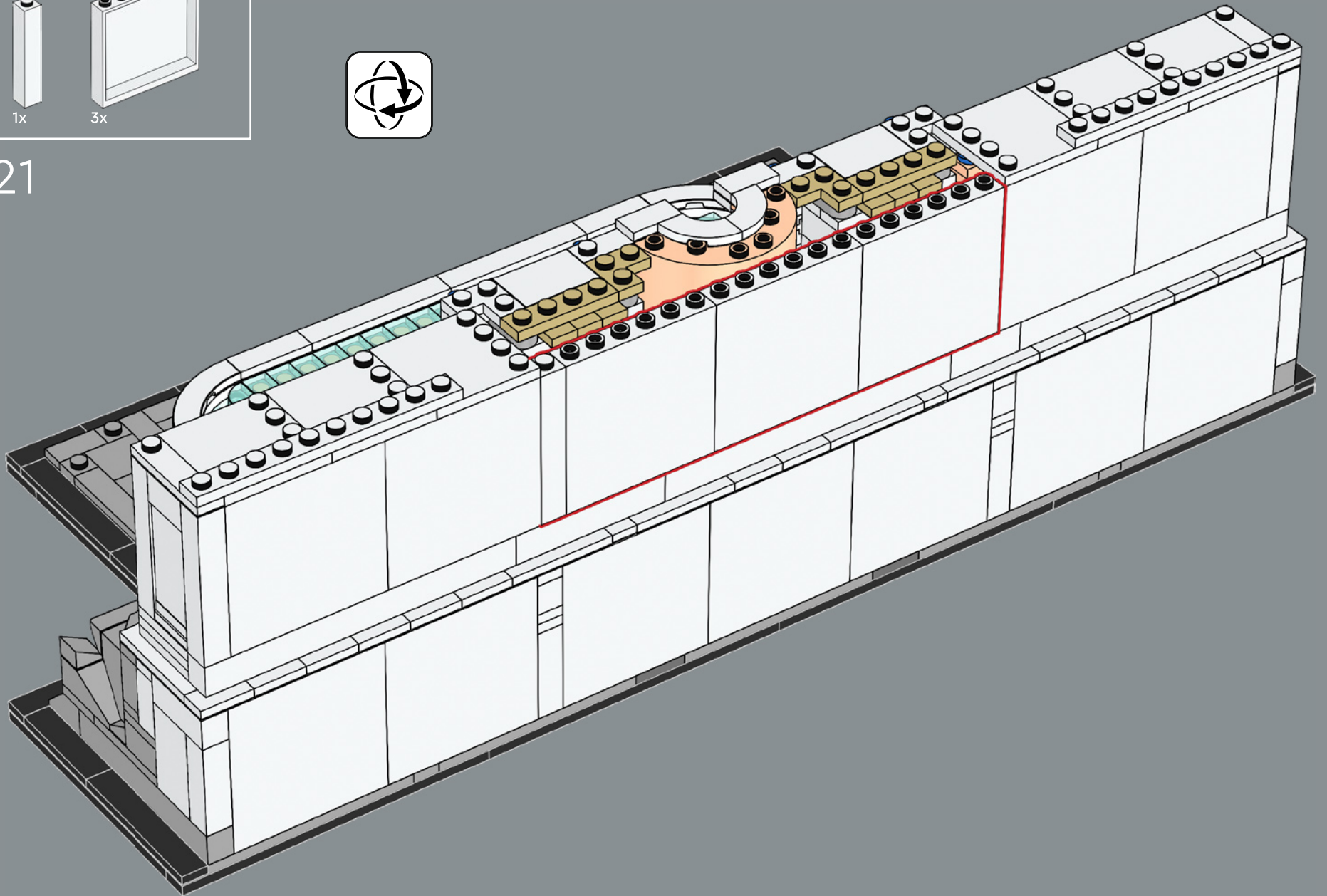

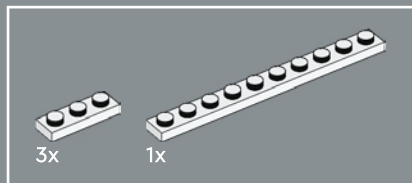

222

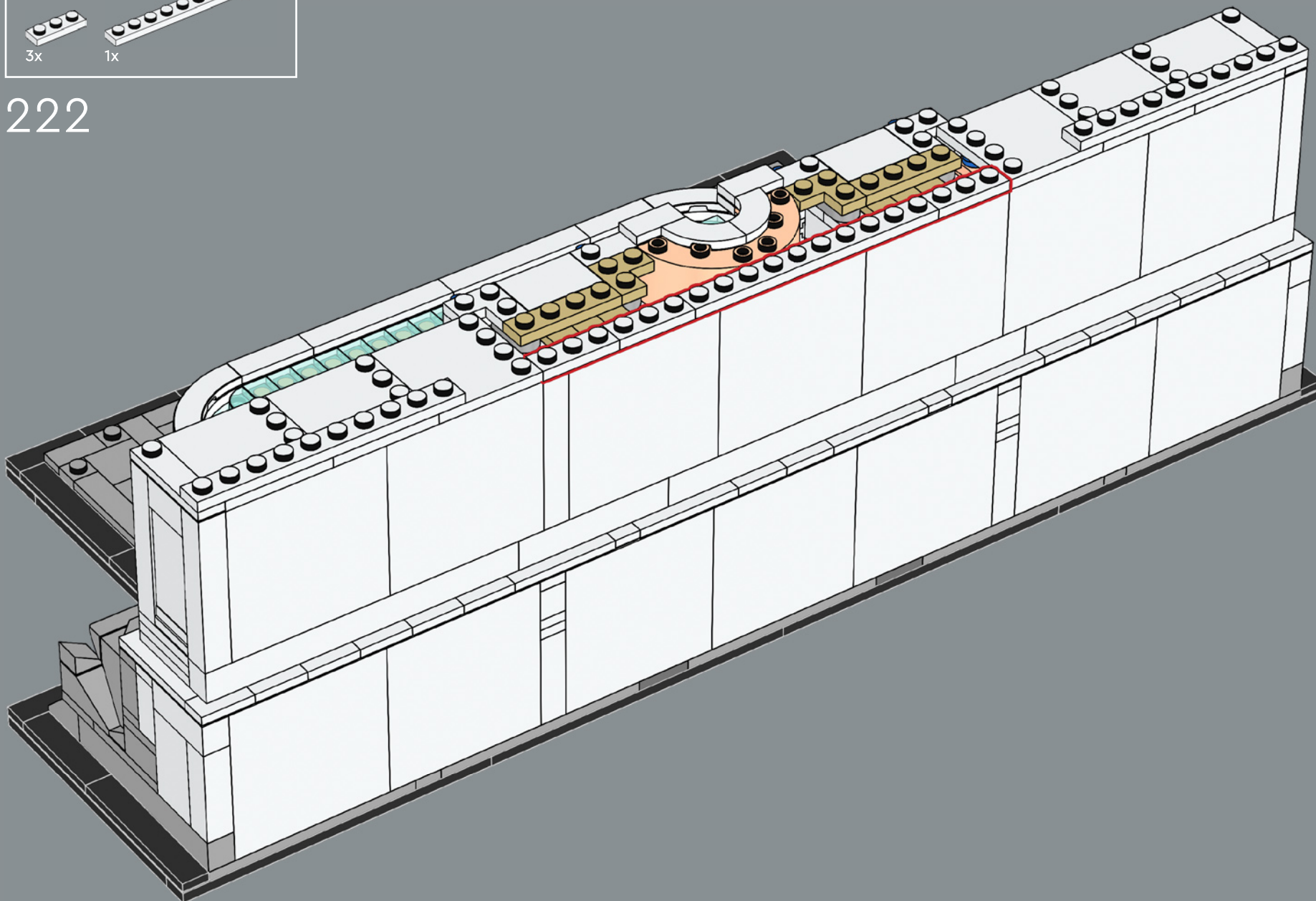

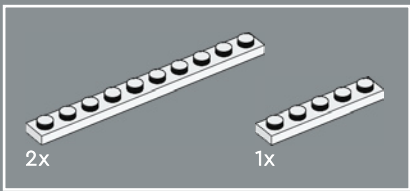

223

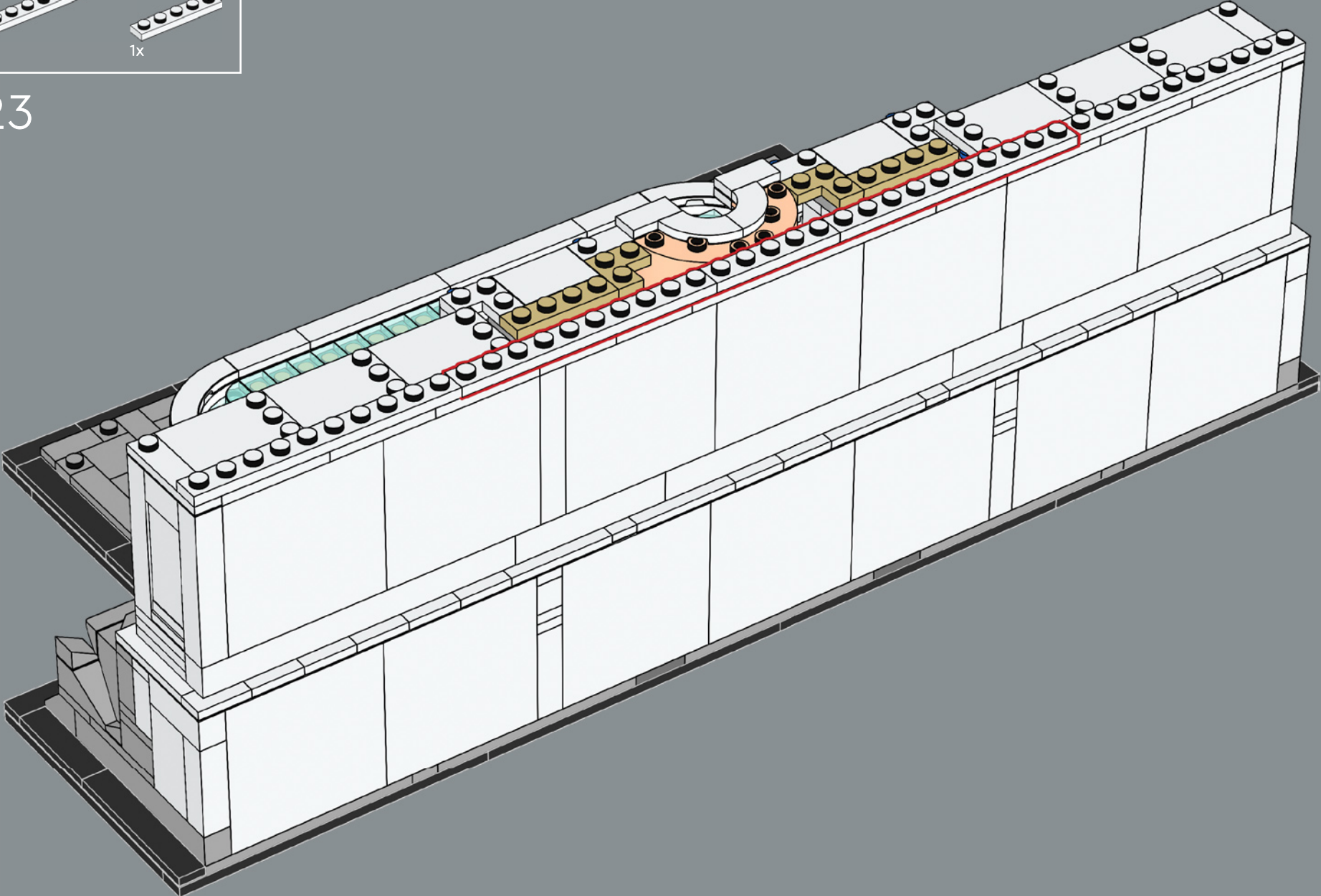



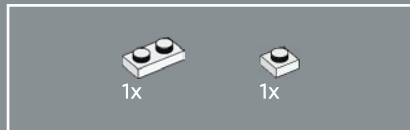
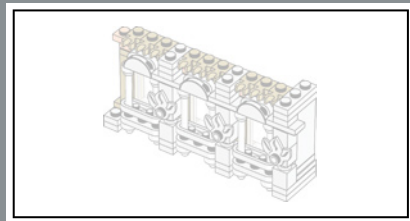

224

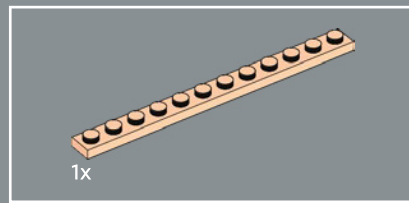
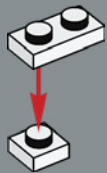

225

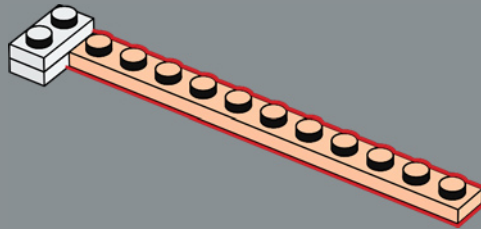

226

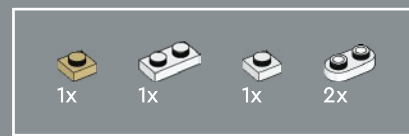
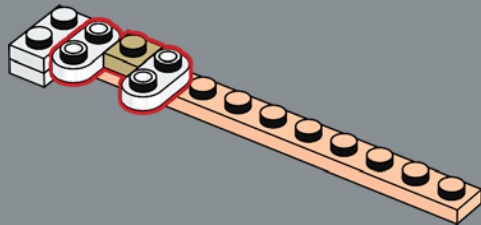

227

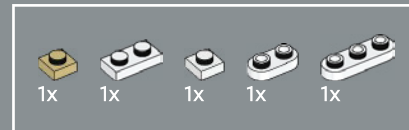
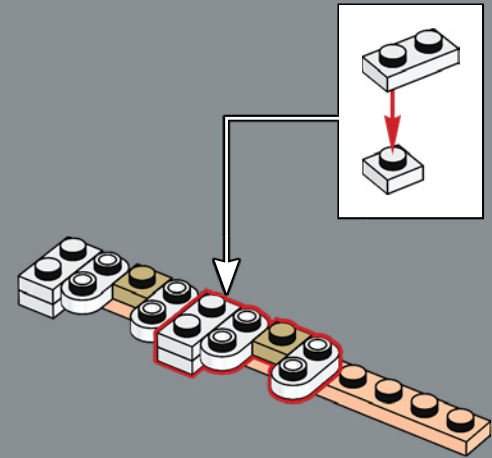

228

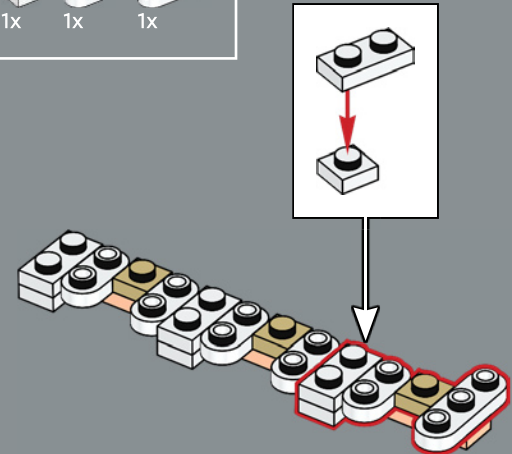

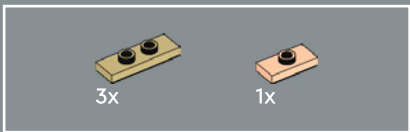

229

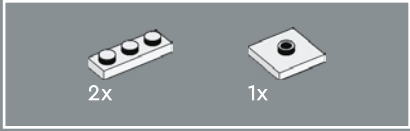
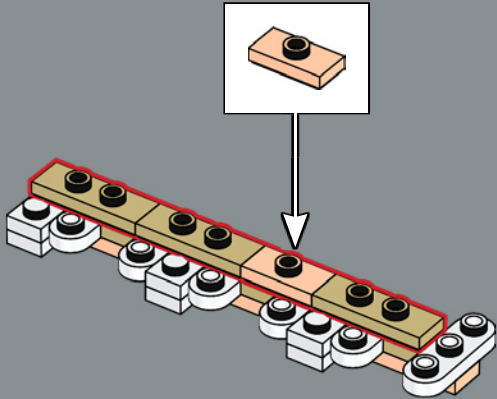

230

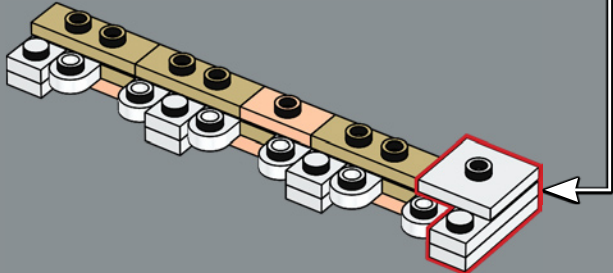
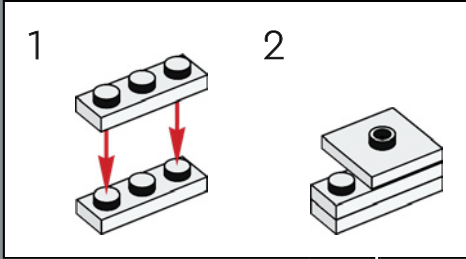

231

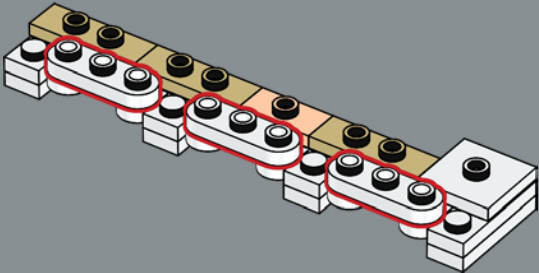

232

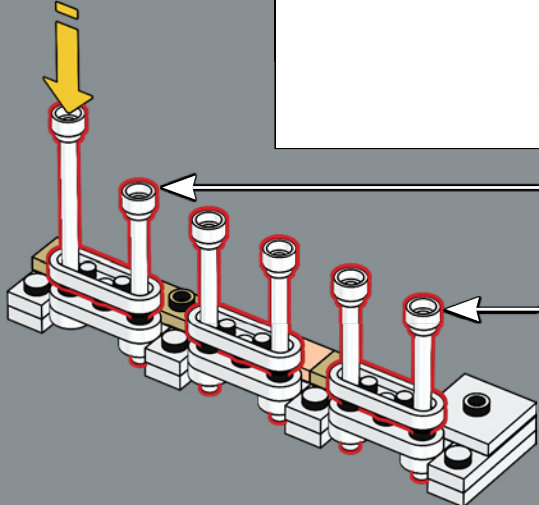
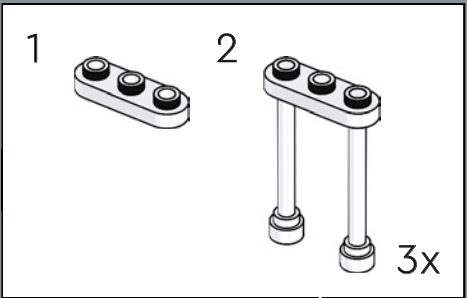

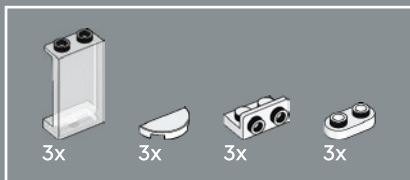

233

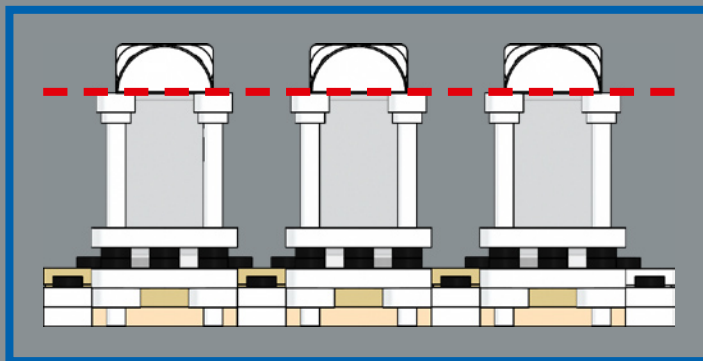

最右边的“窗户”实际上只是一堵墙，  
被粉刷得与其他 11 扇窗户相似。

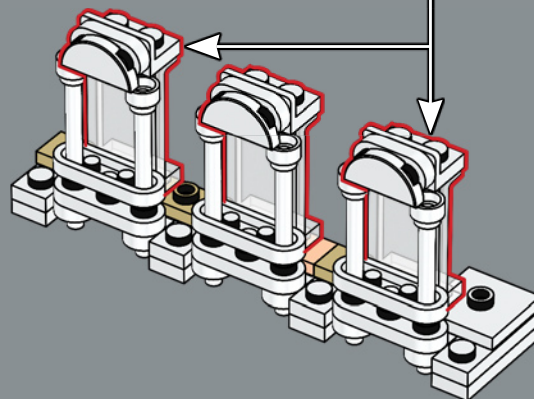
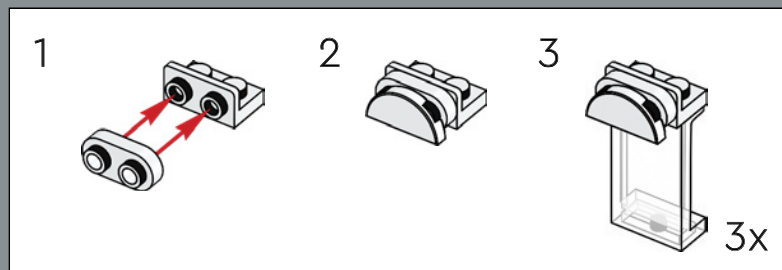

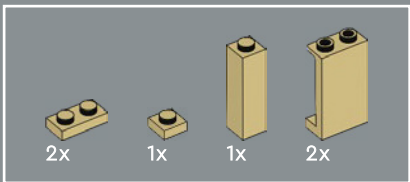

234

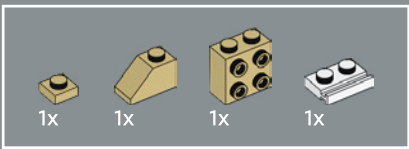
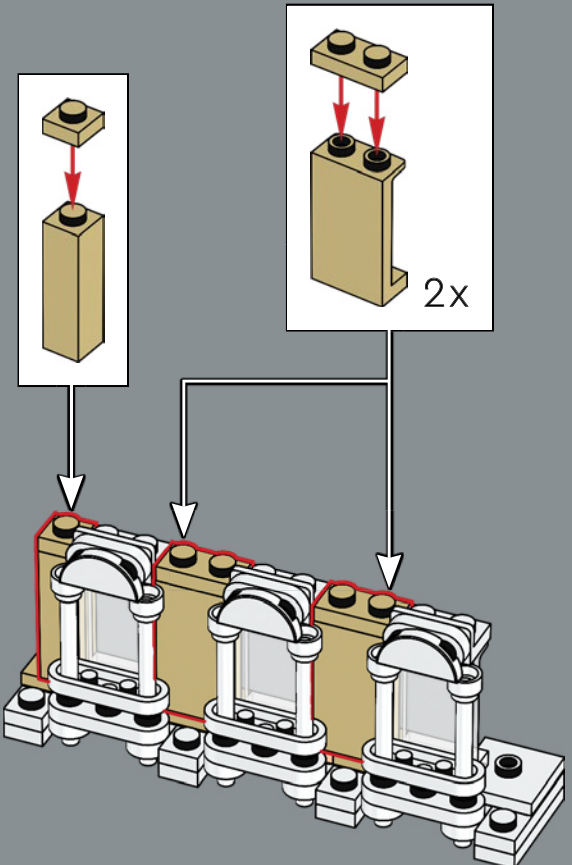

235

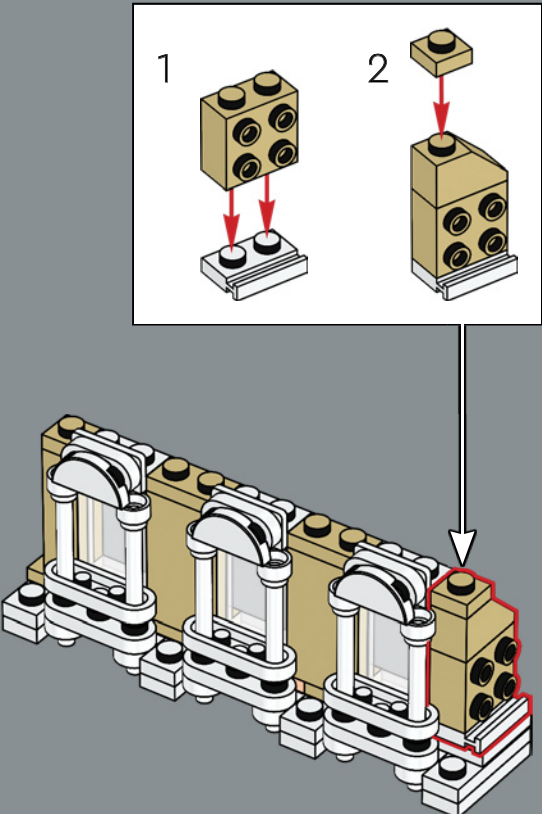

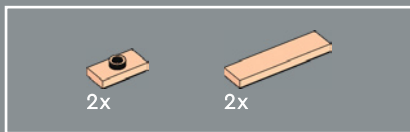

236

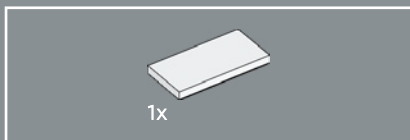
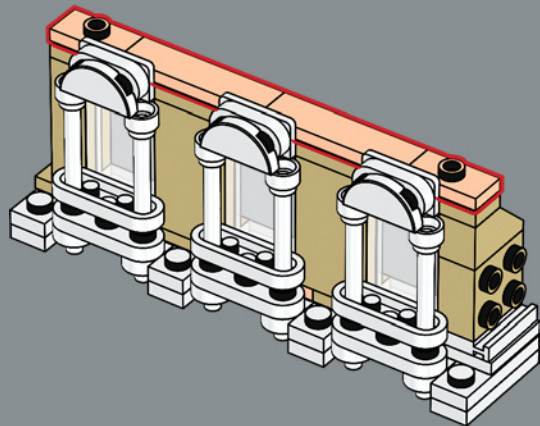

237

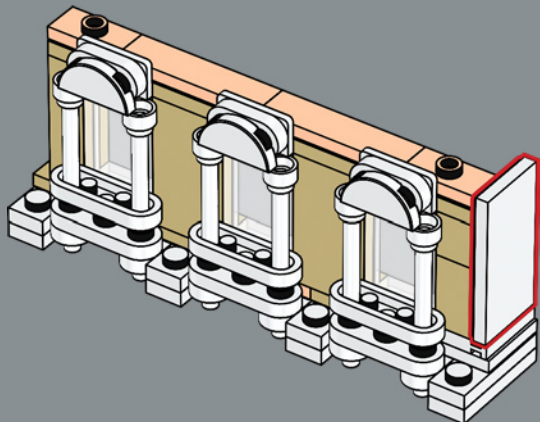

238

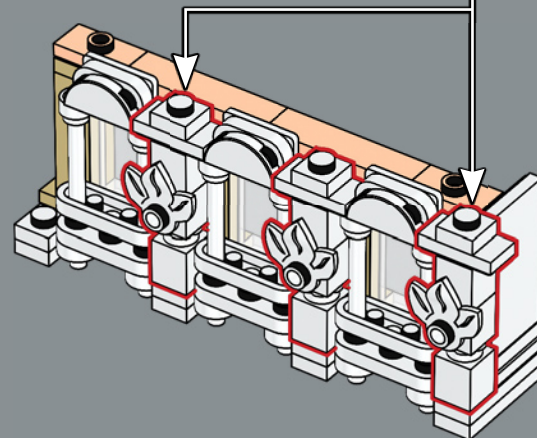
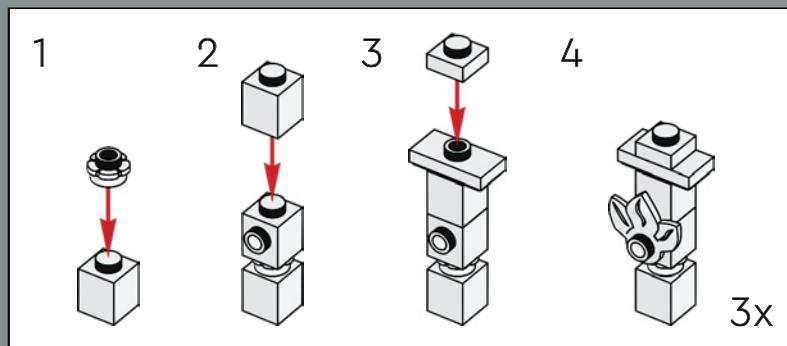

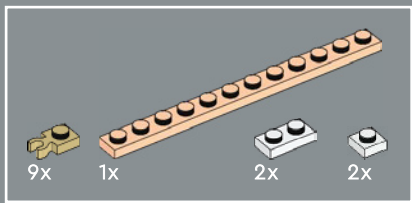

239

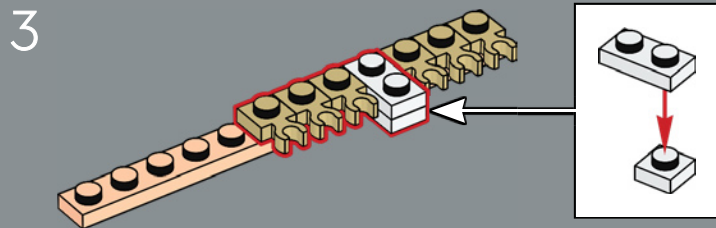
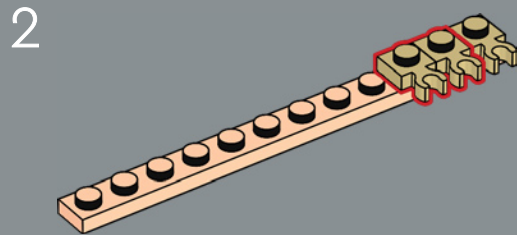
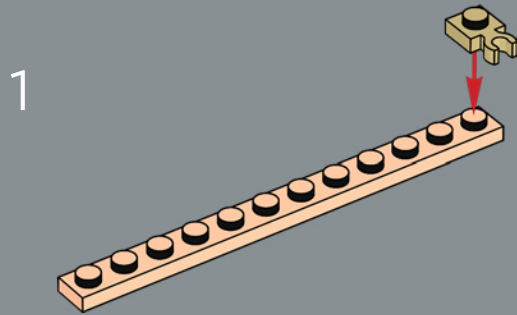

4

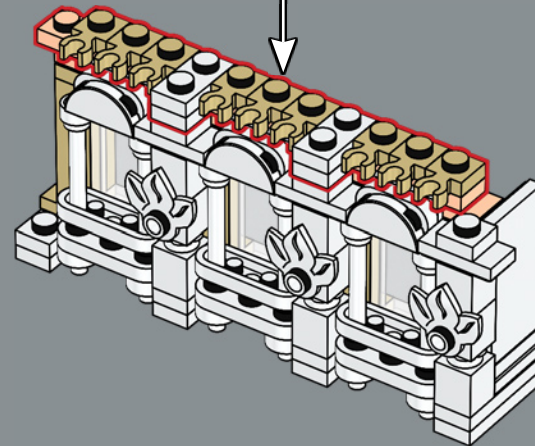
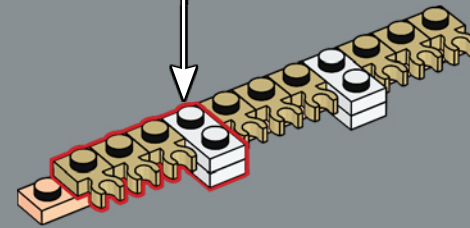
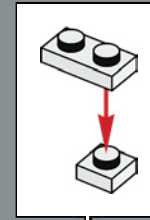

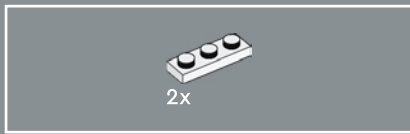

240

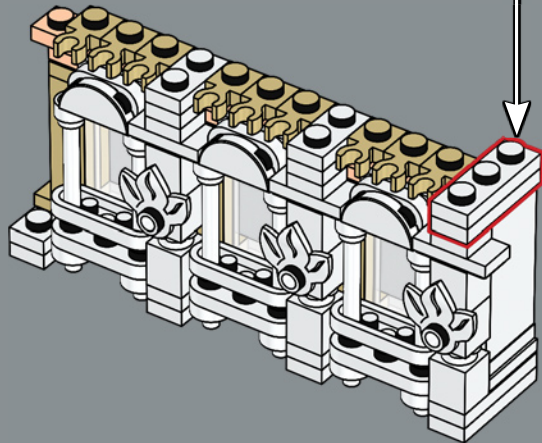
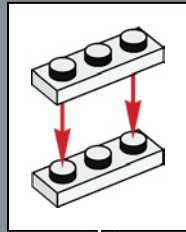

241

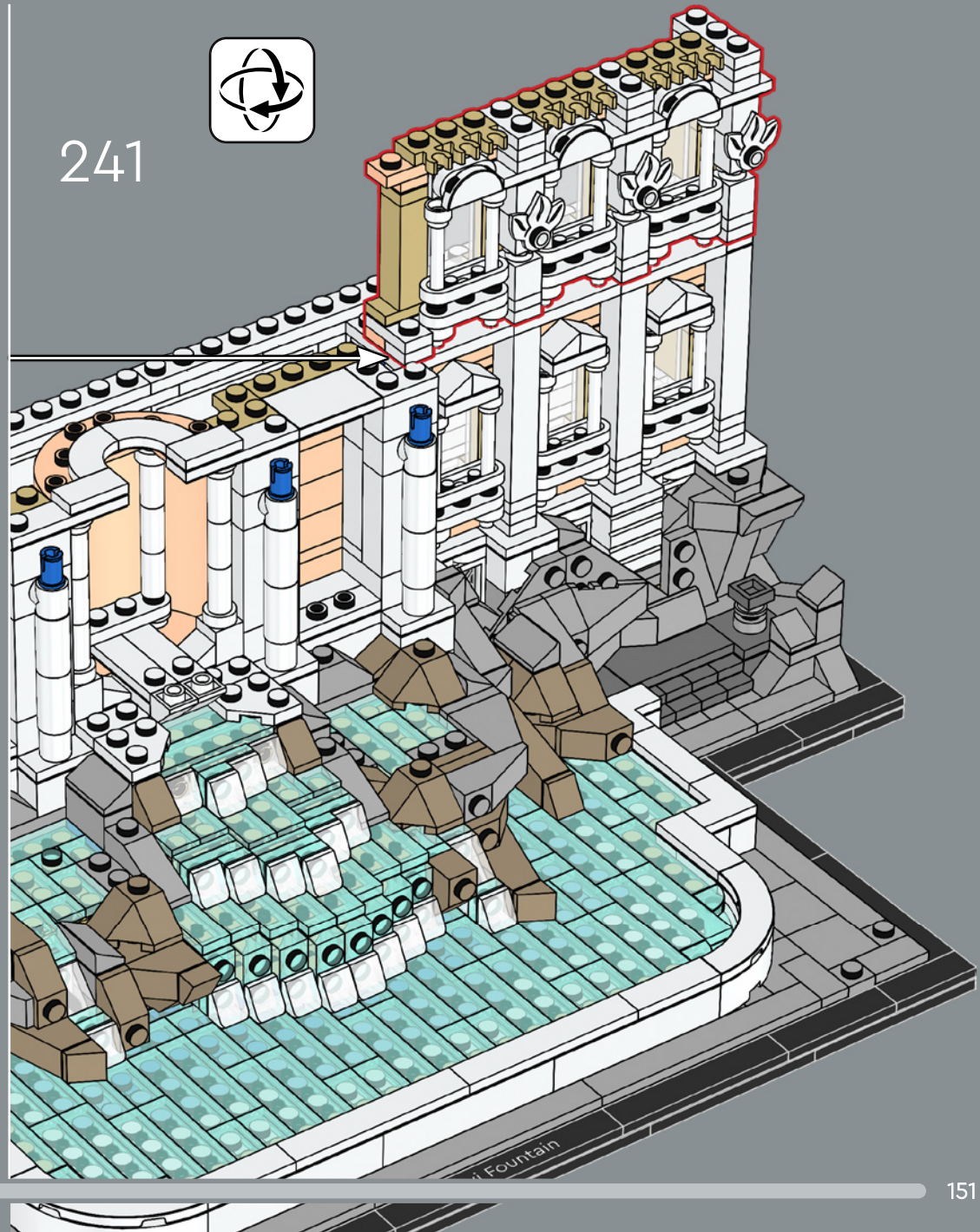

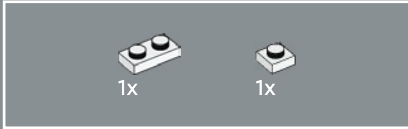
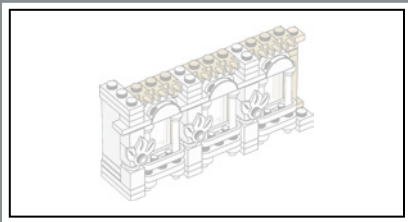

242

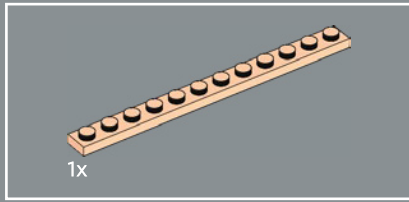
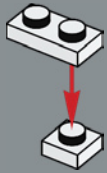

243

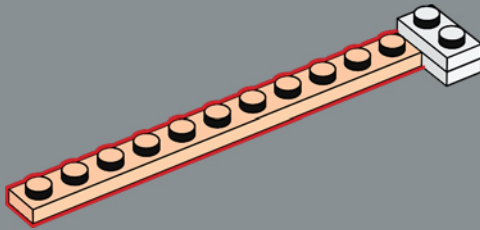

244

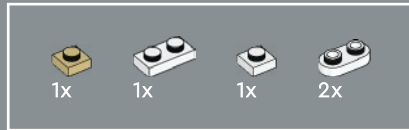
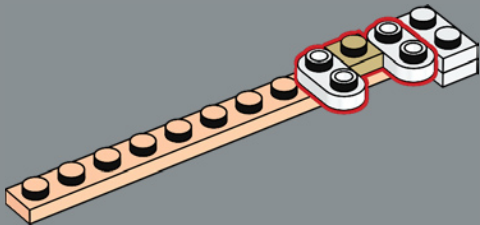

245

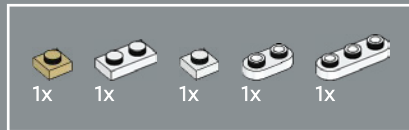
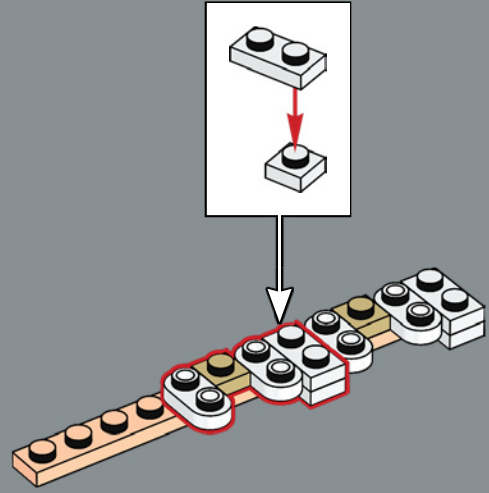

246

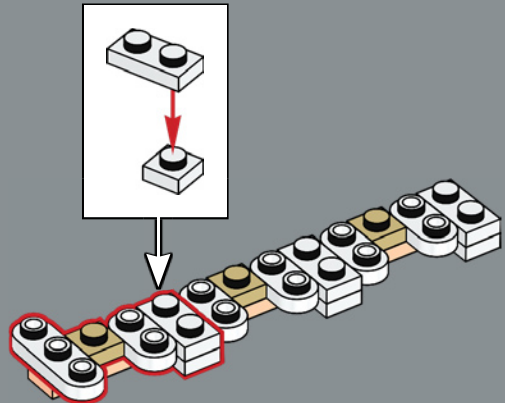



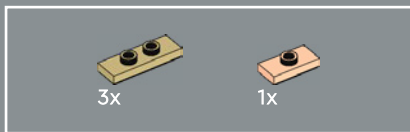

247

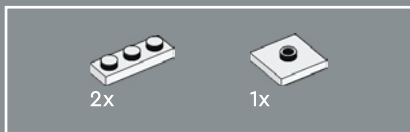
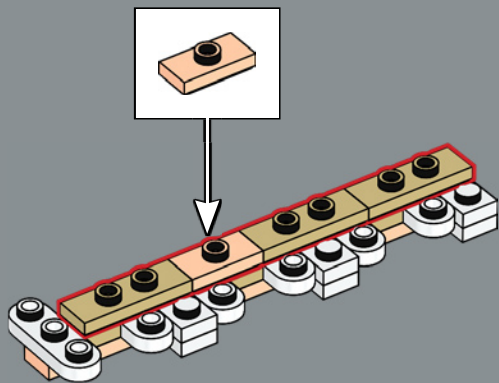

248

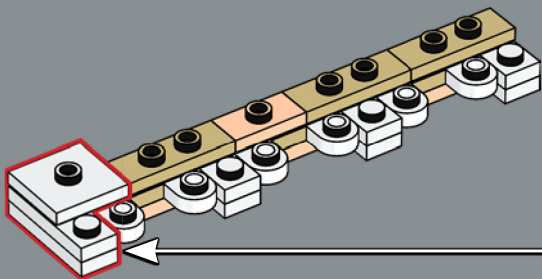
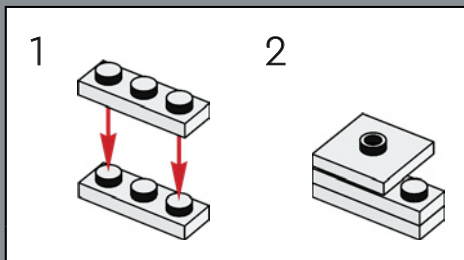

249

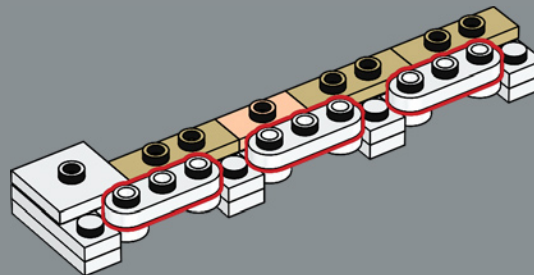

250

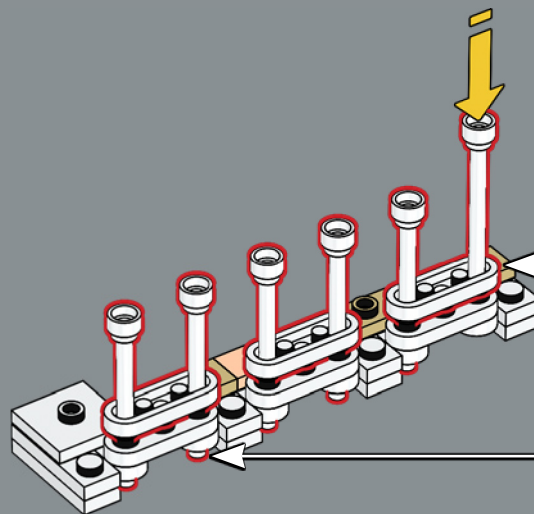
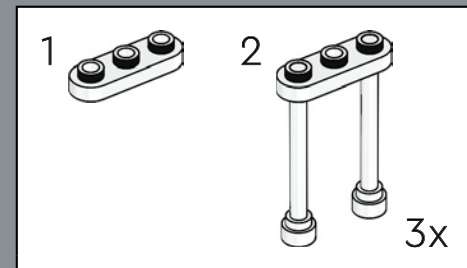

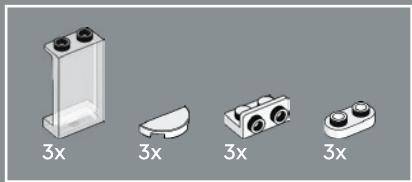

251

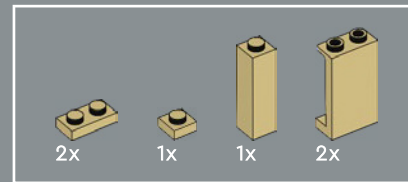
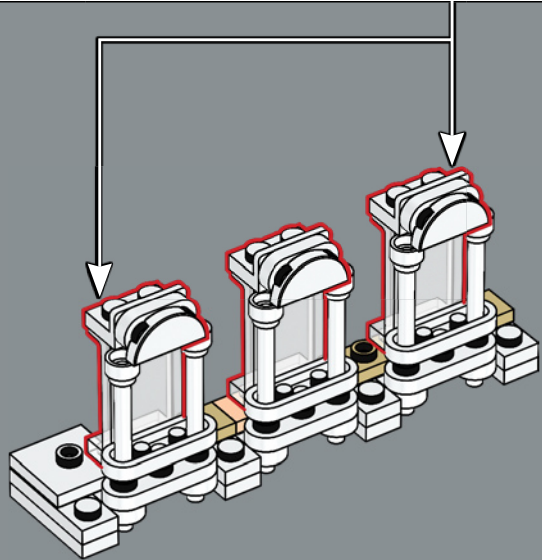
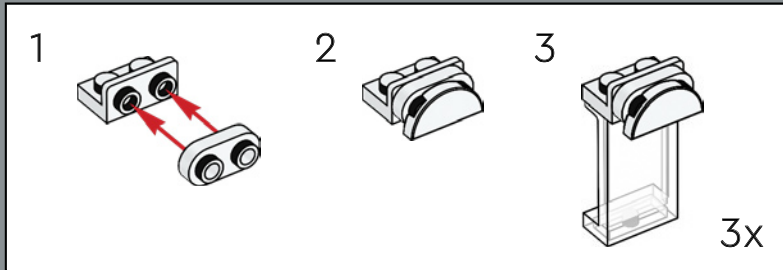
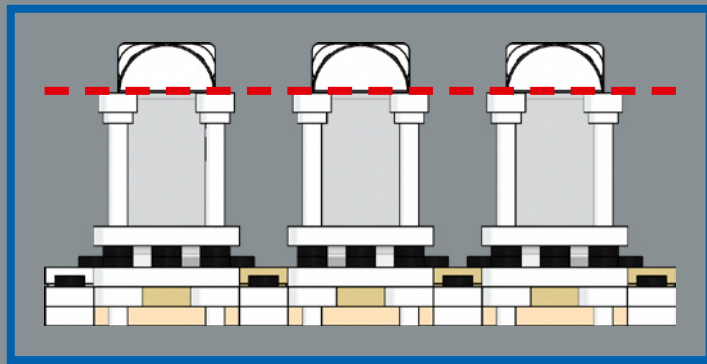

252

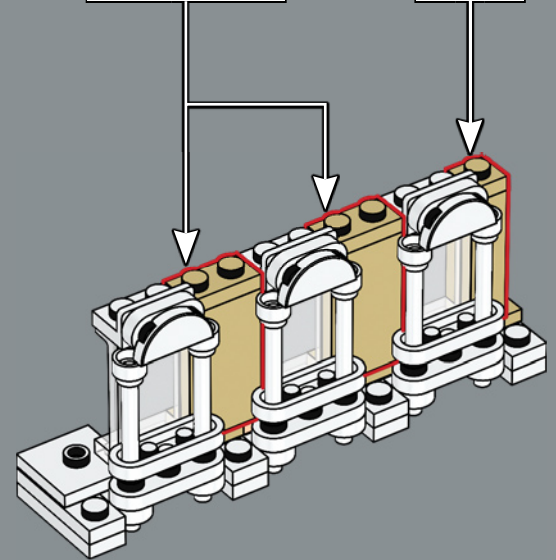
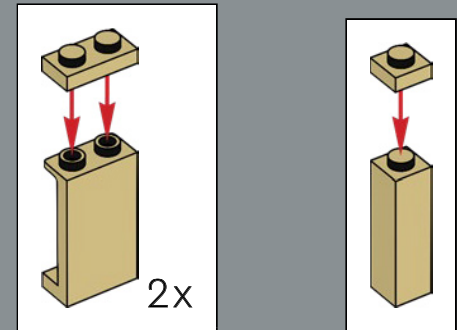

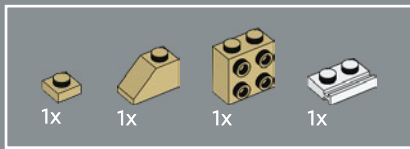

253

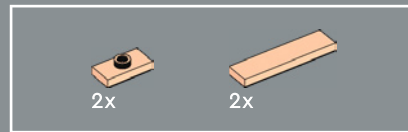
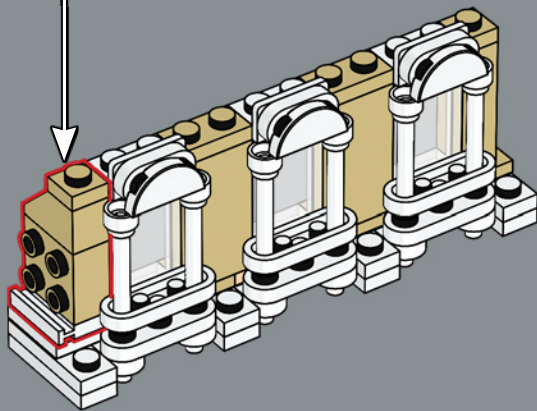
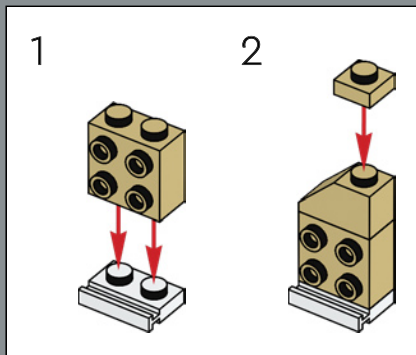

254

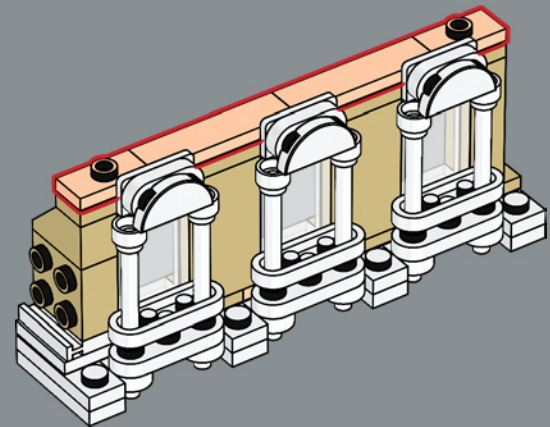

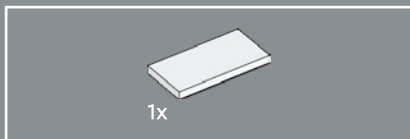

255

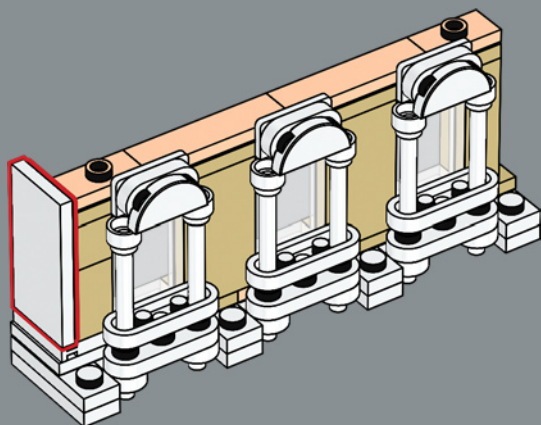

256

这里使用的乐高“叶子”组件有助于搭建科林斯柱的柱头。

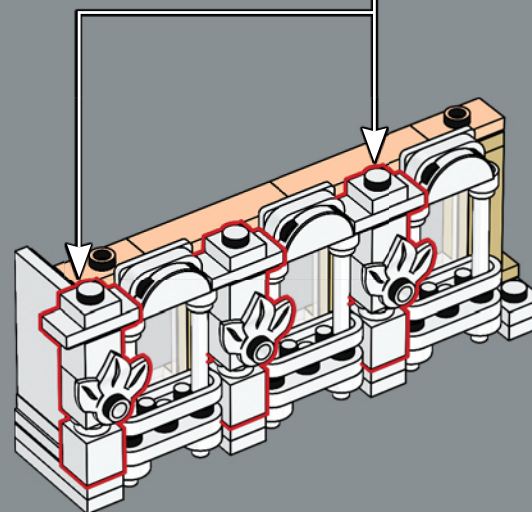
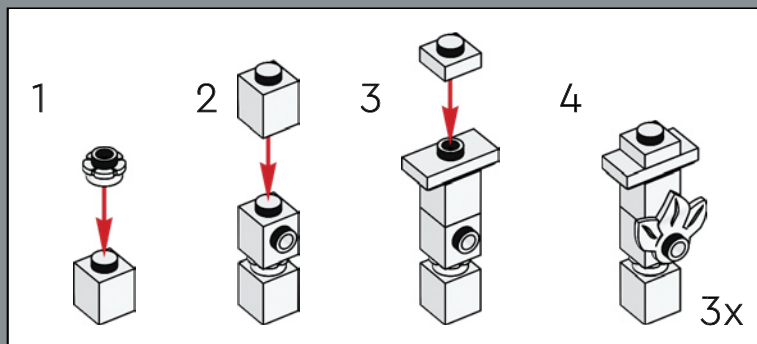

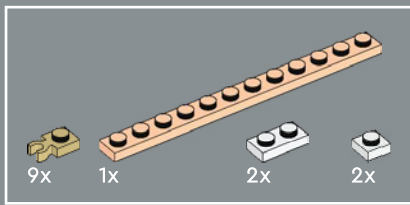

257

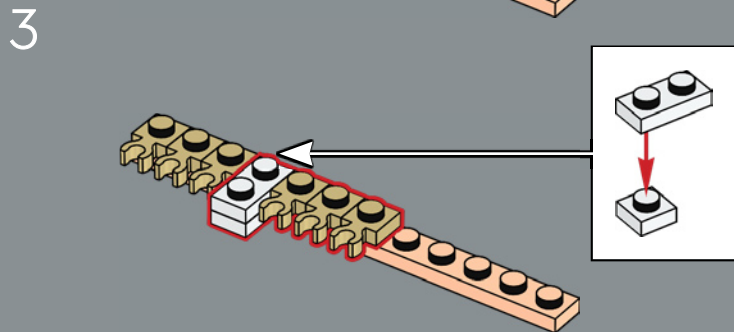
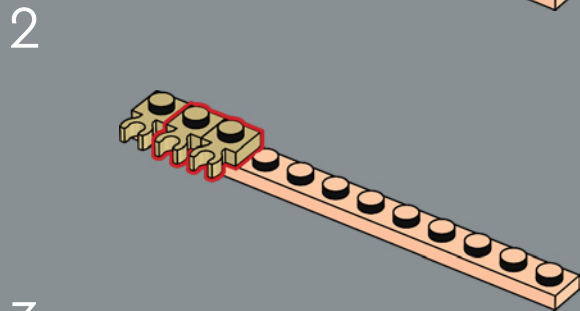
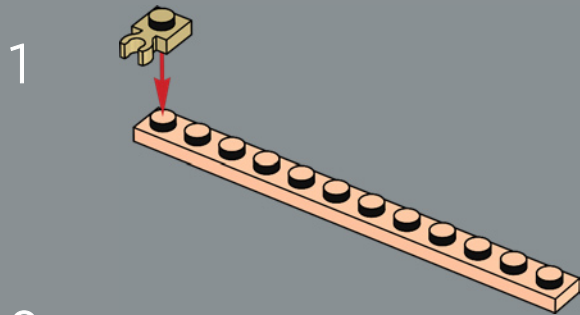

4

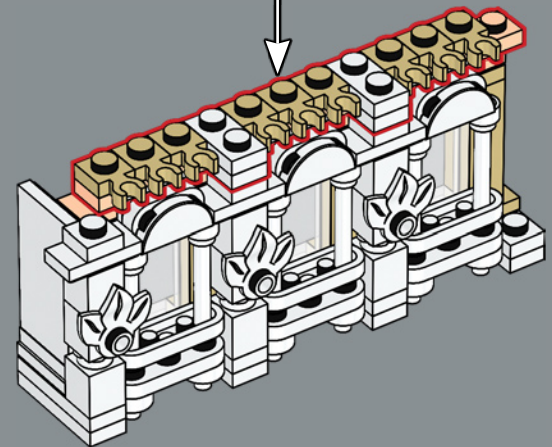
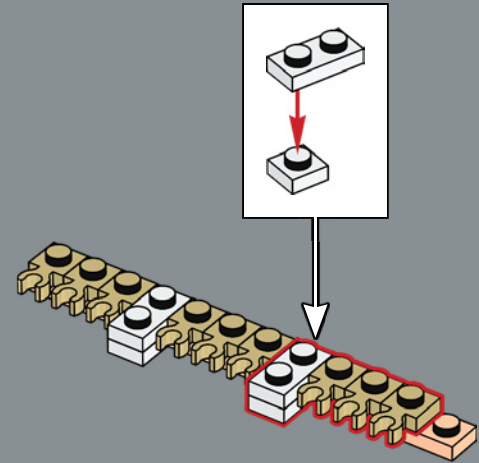

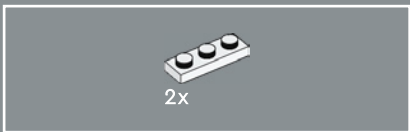

258

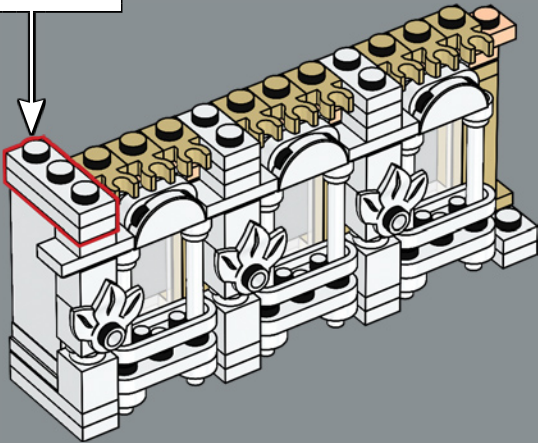
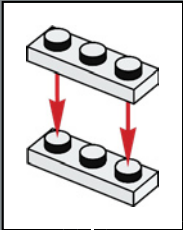

259

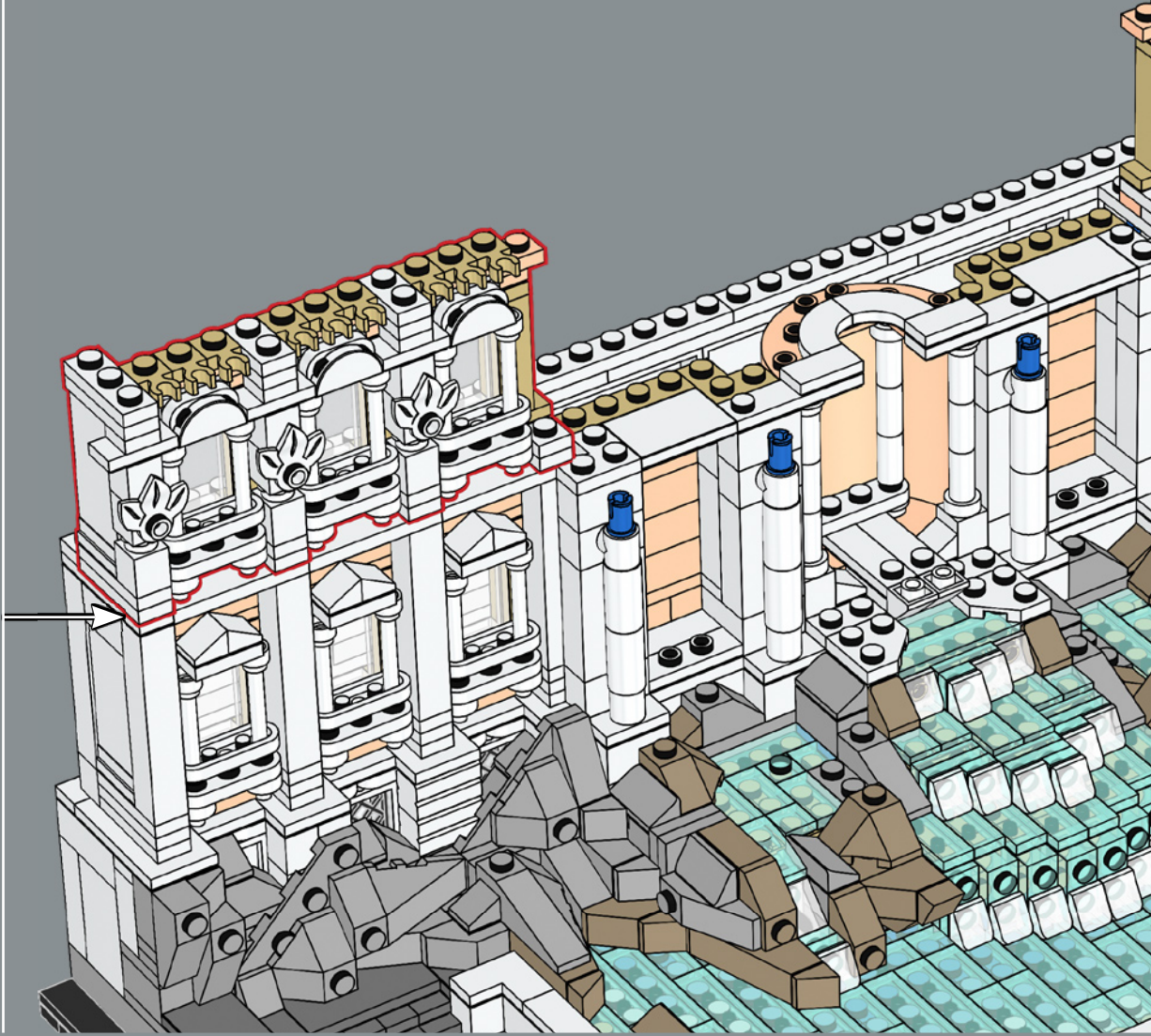

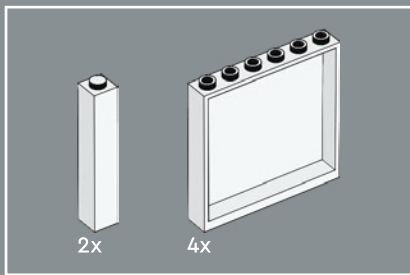

260

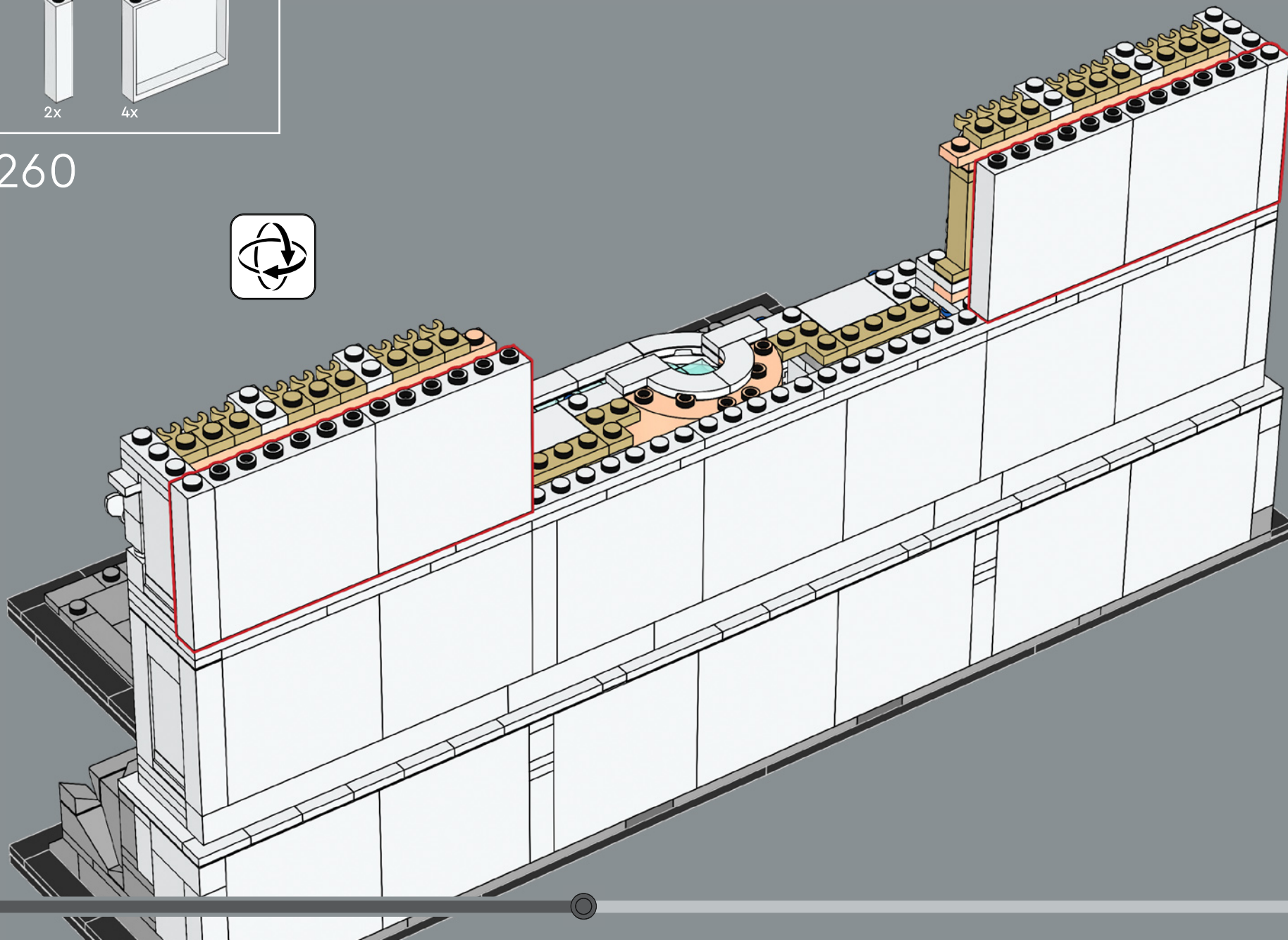



261

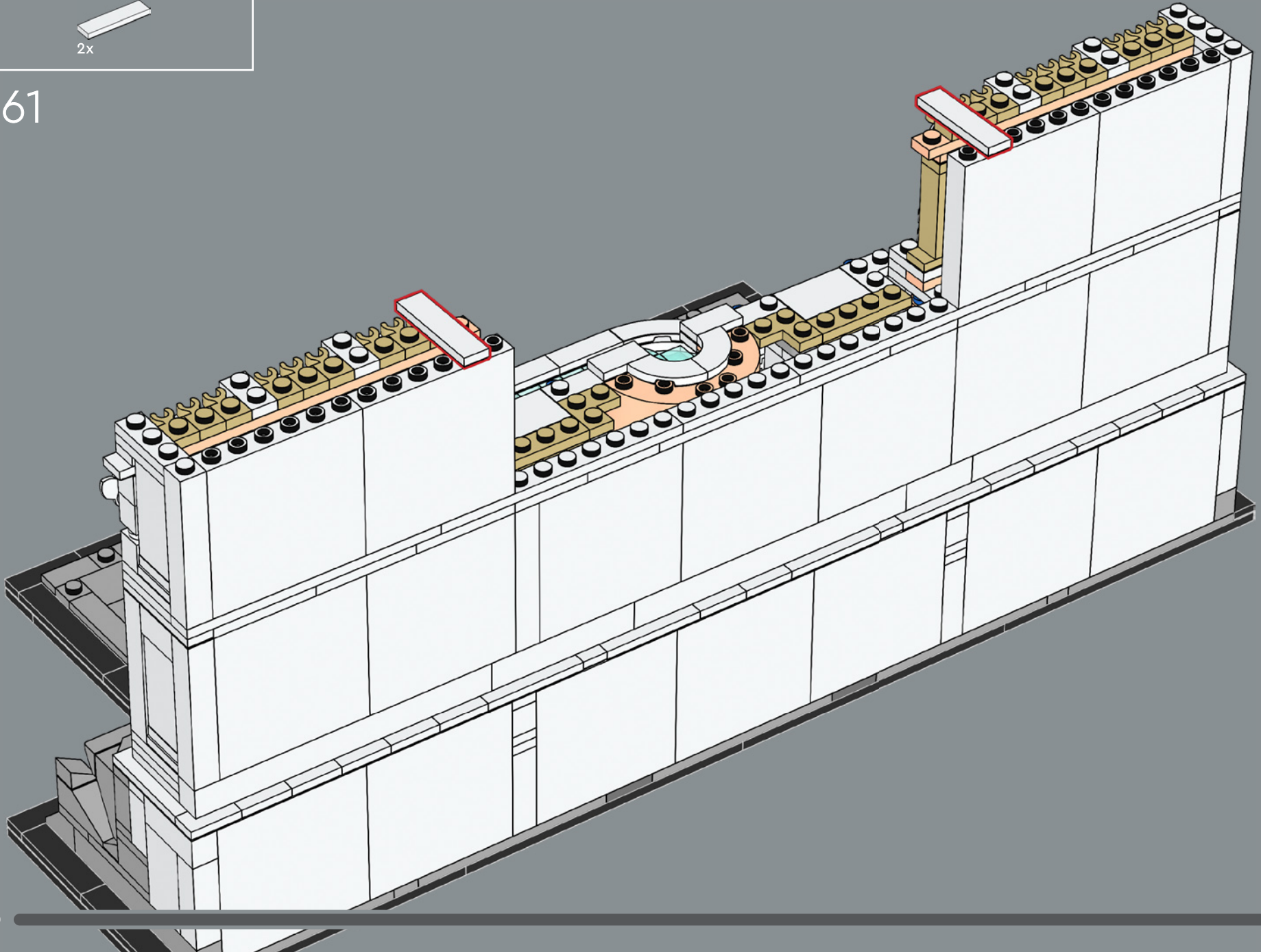



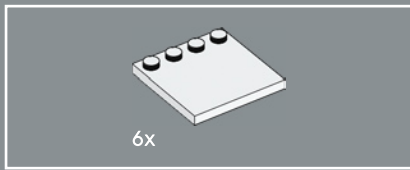

262

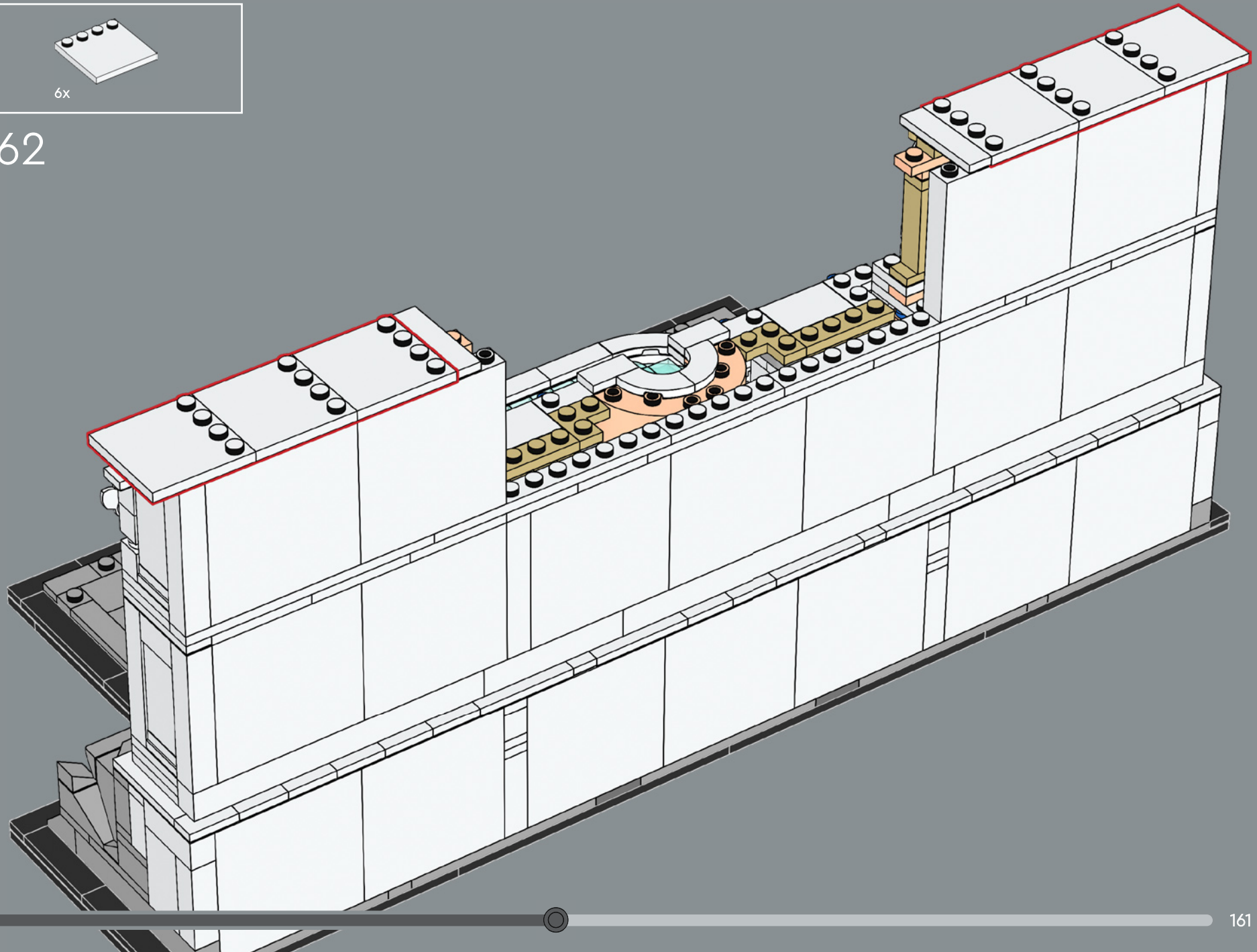

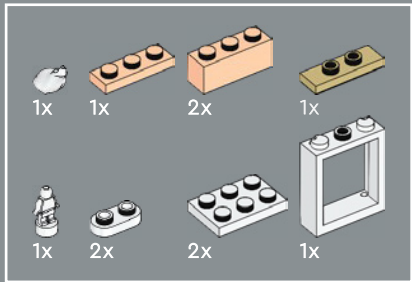

263

1

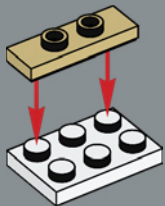

2

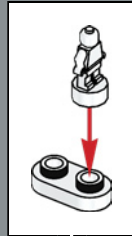
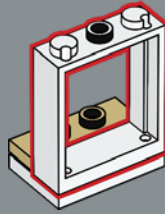

3

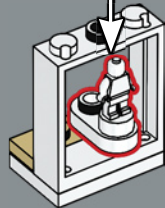

4

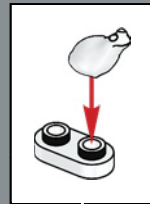

1

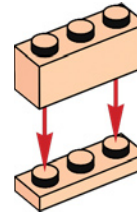

2

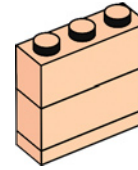

5



6



左右浮雕都包含一个站立和一个跪着的人偶，  
此处由乐高®小人仔奖杯和青蛙代表。

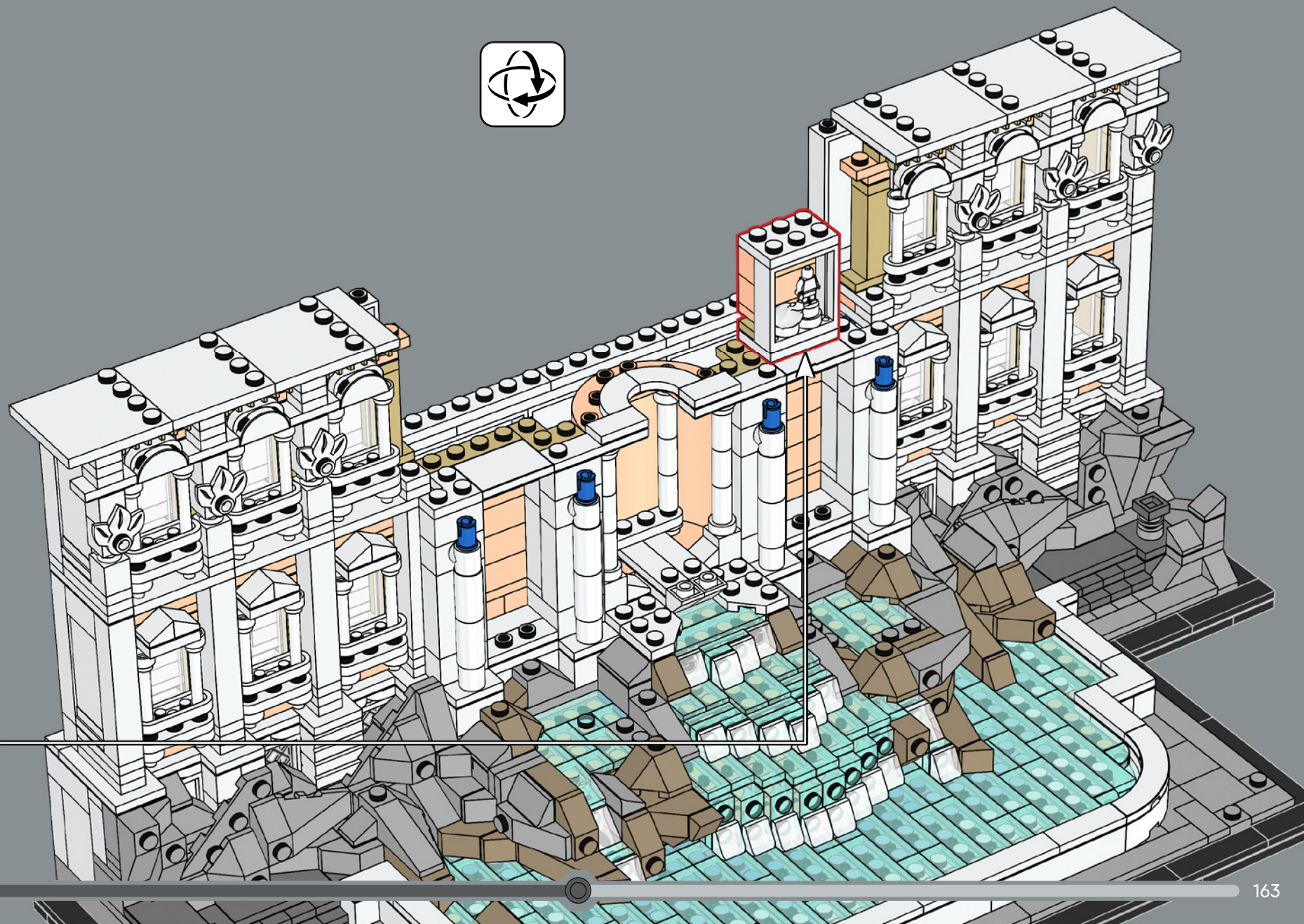

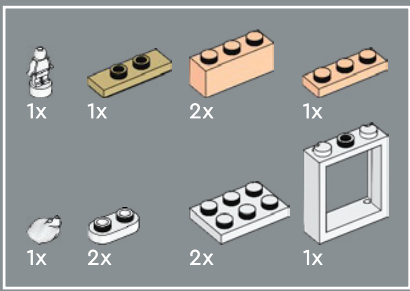

264

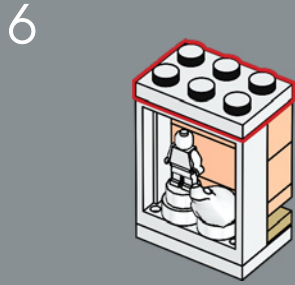
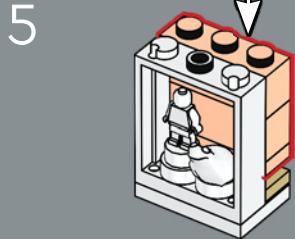
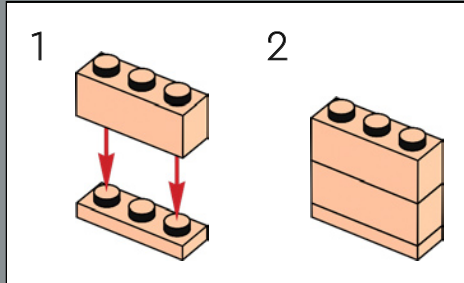
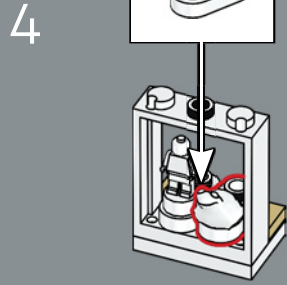
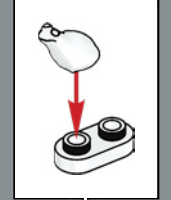
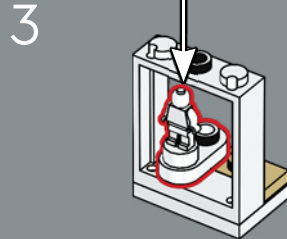
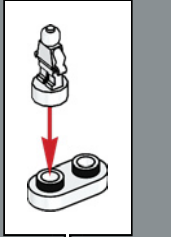
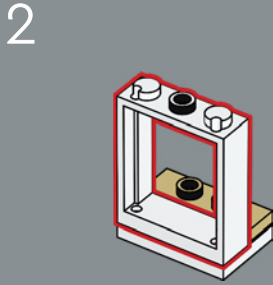
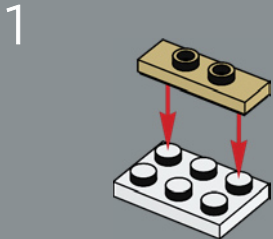

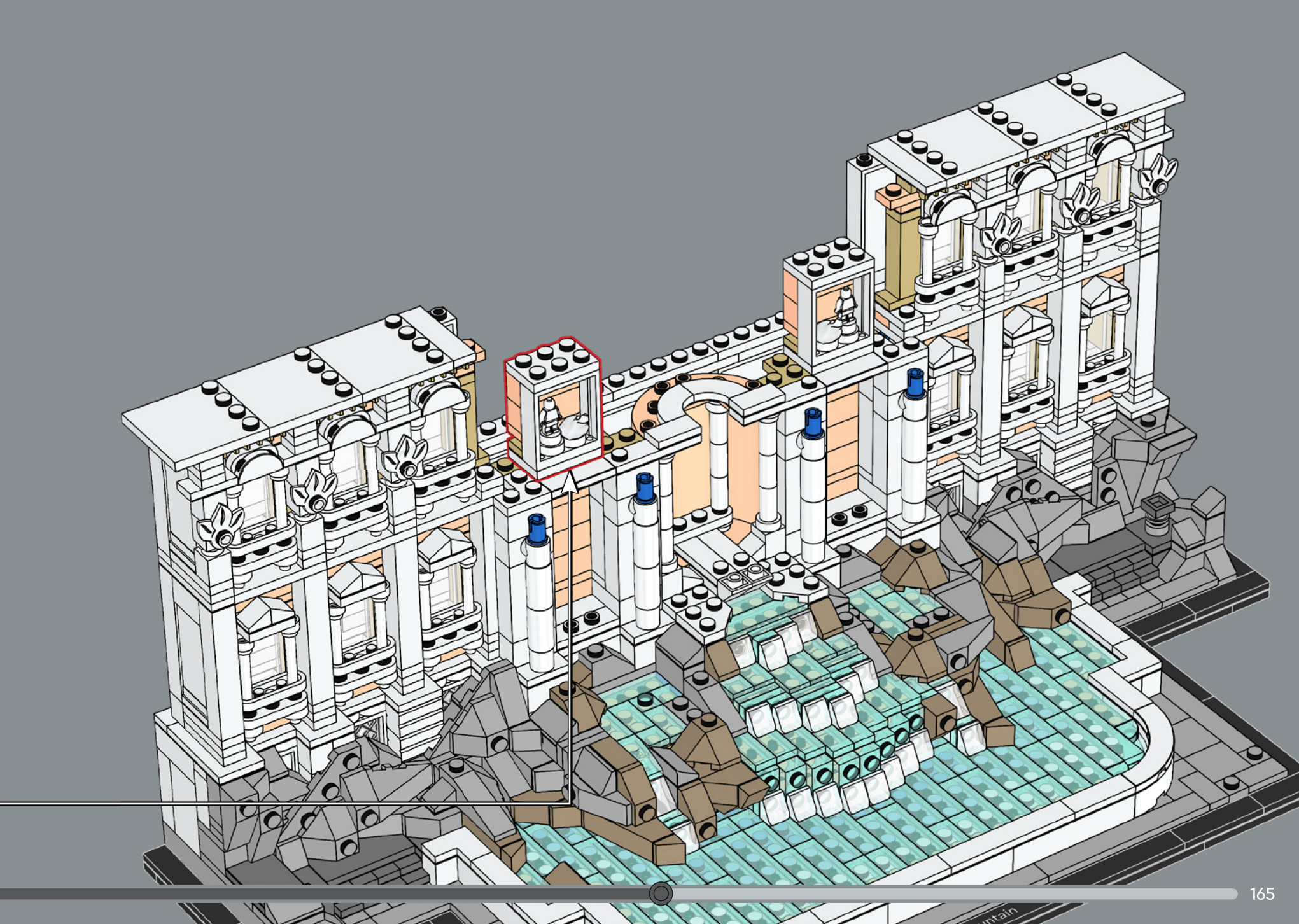

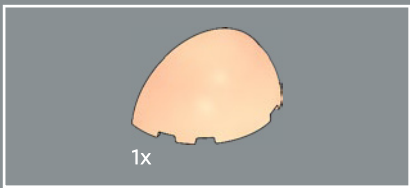

265

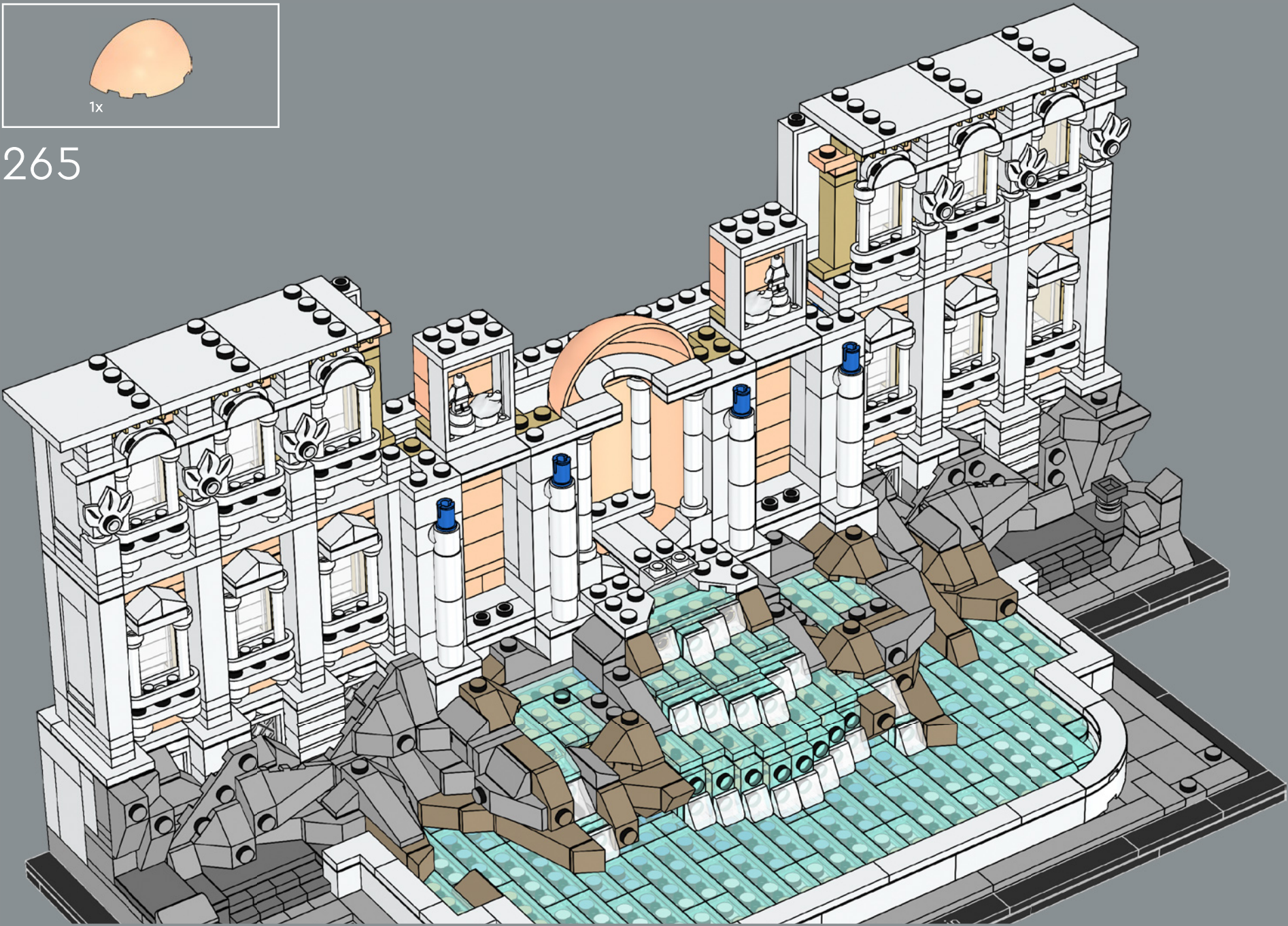

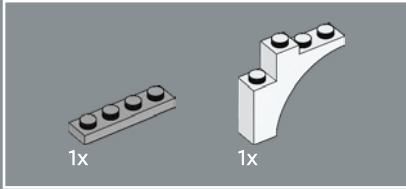
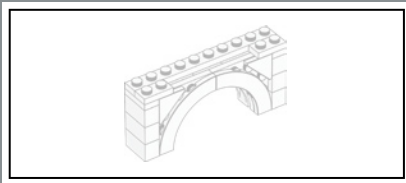

266

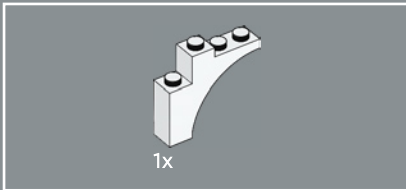
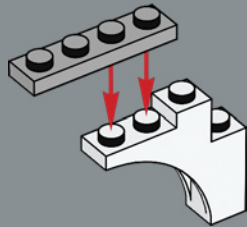

267

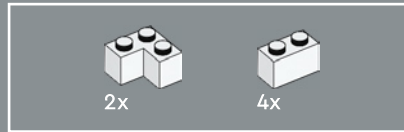
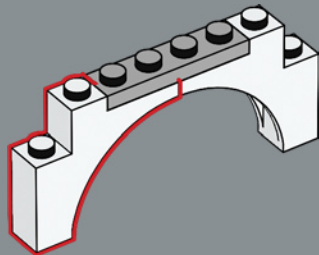

268

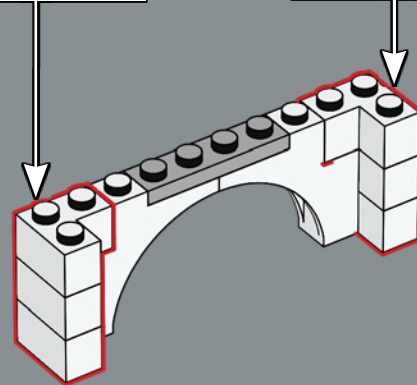
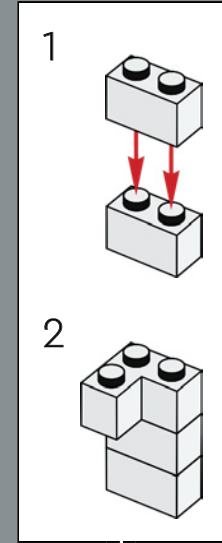
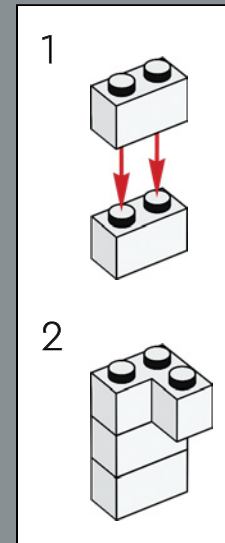

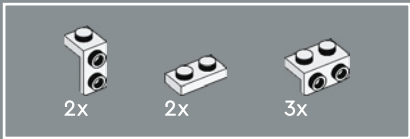

269

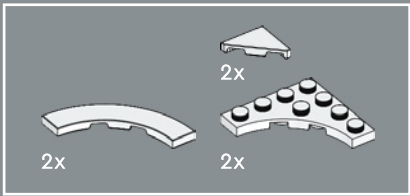
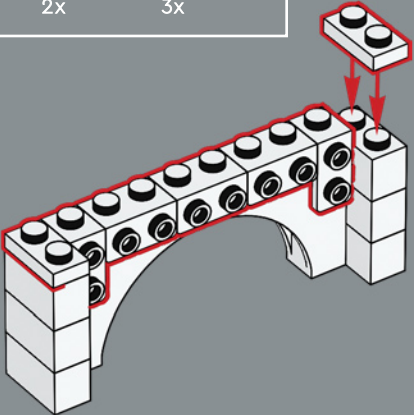

270

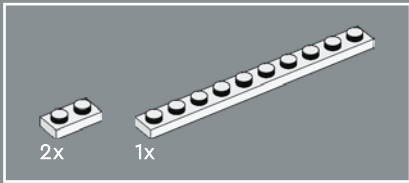
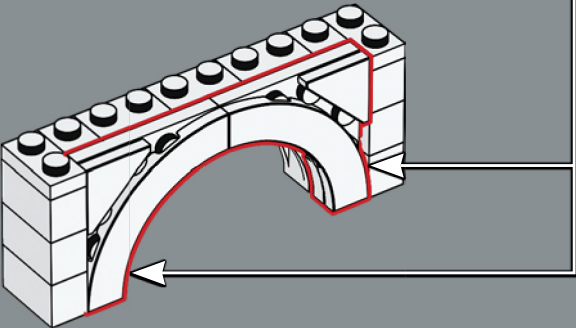
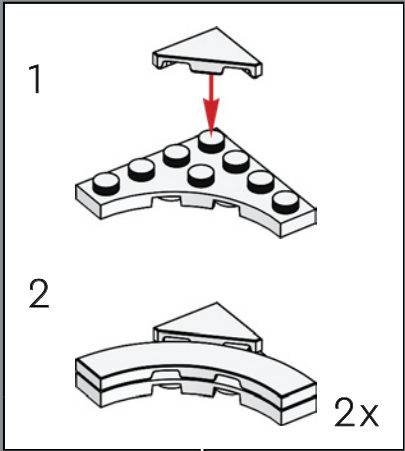

271

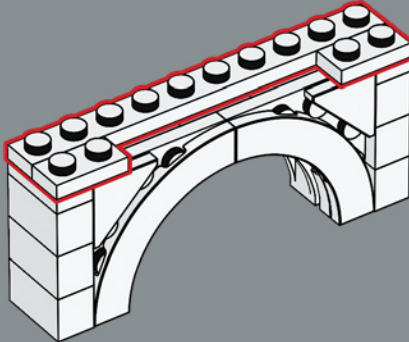



272

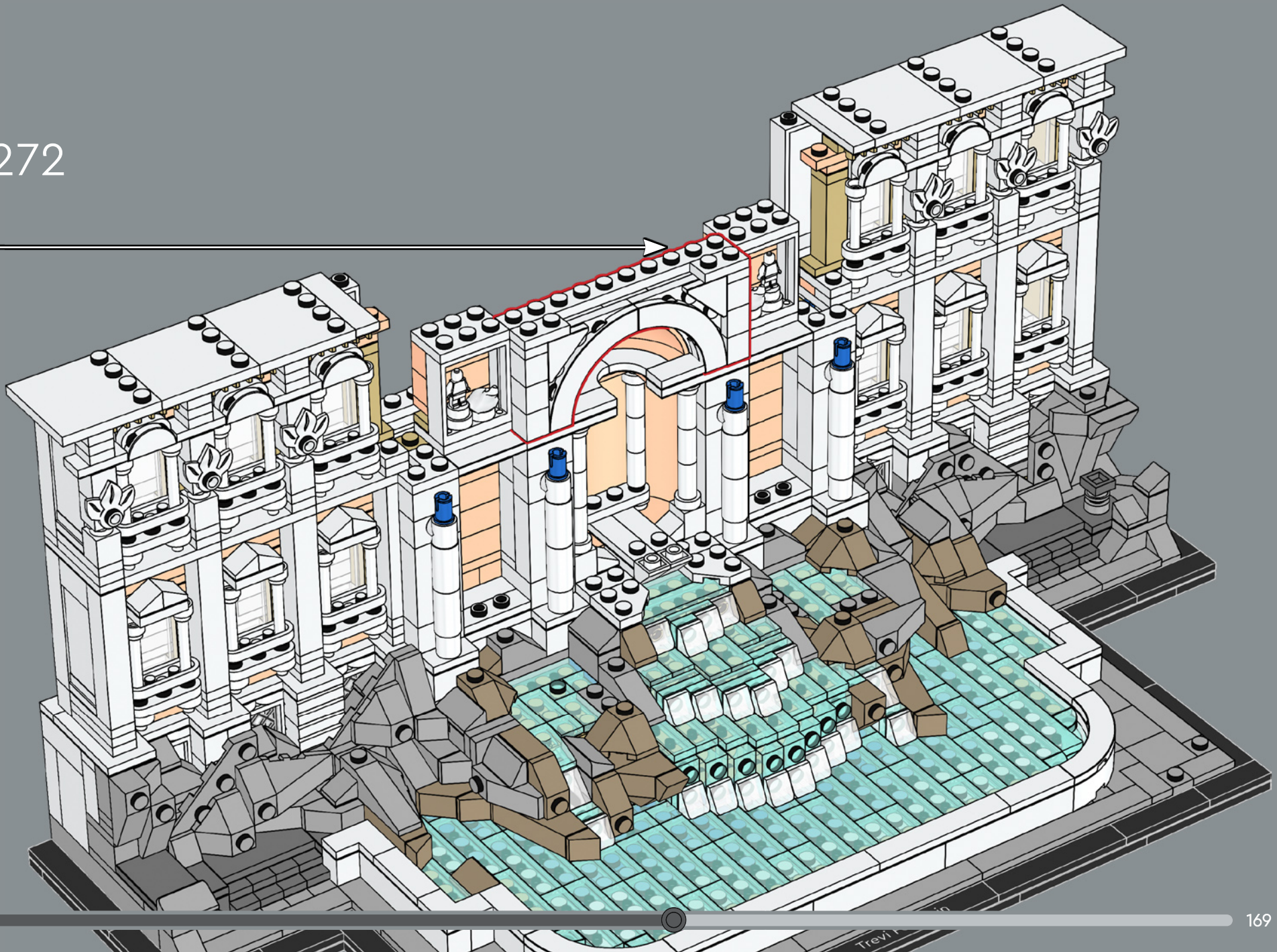

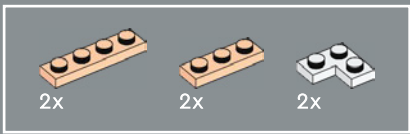

273

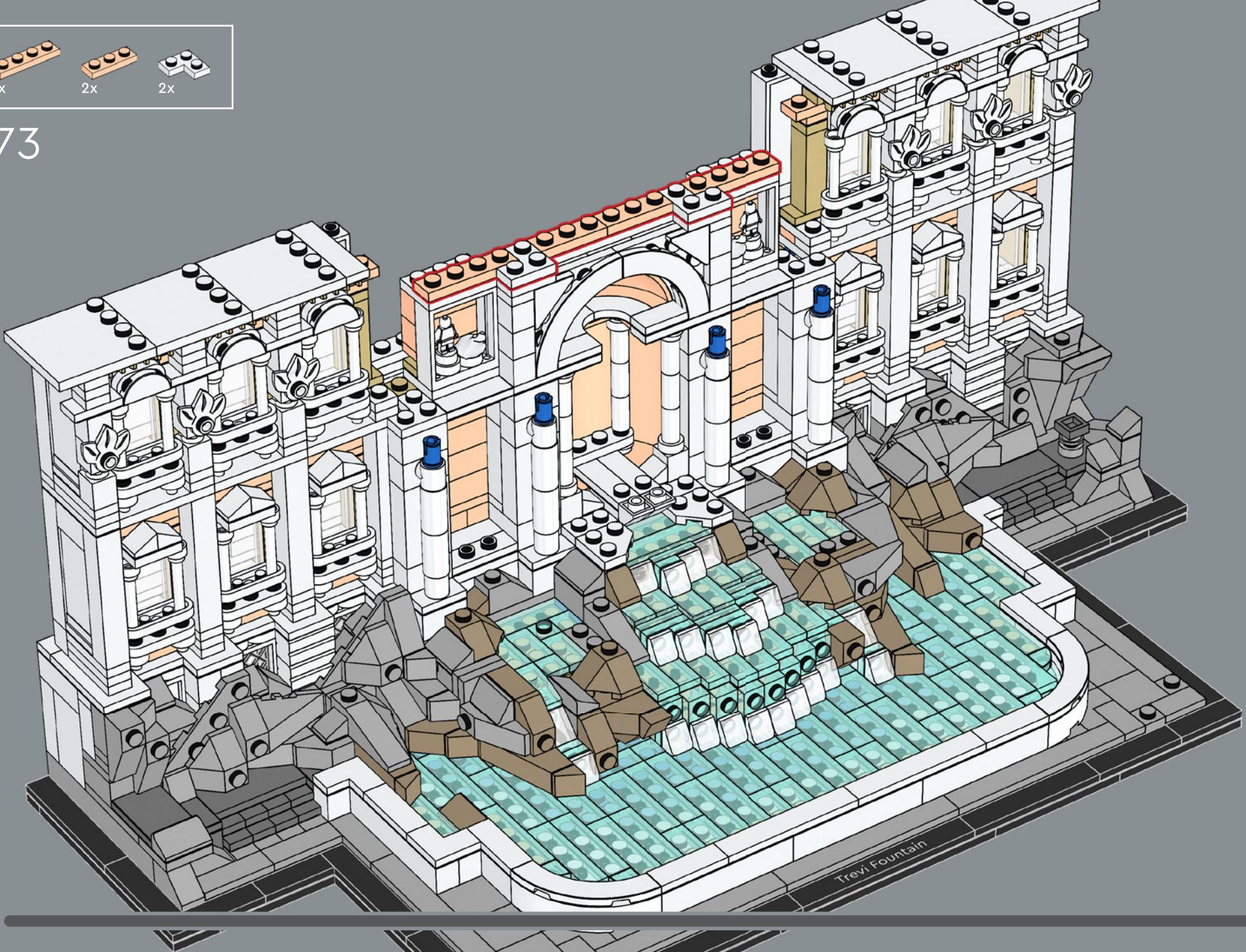

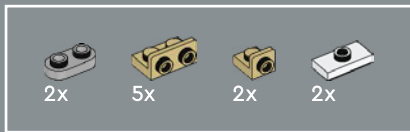

274

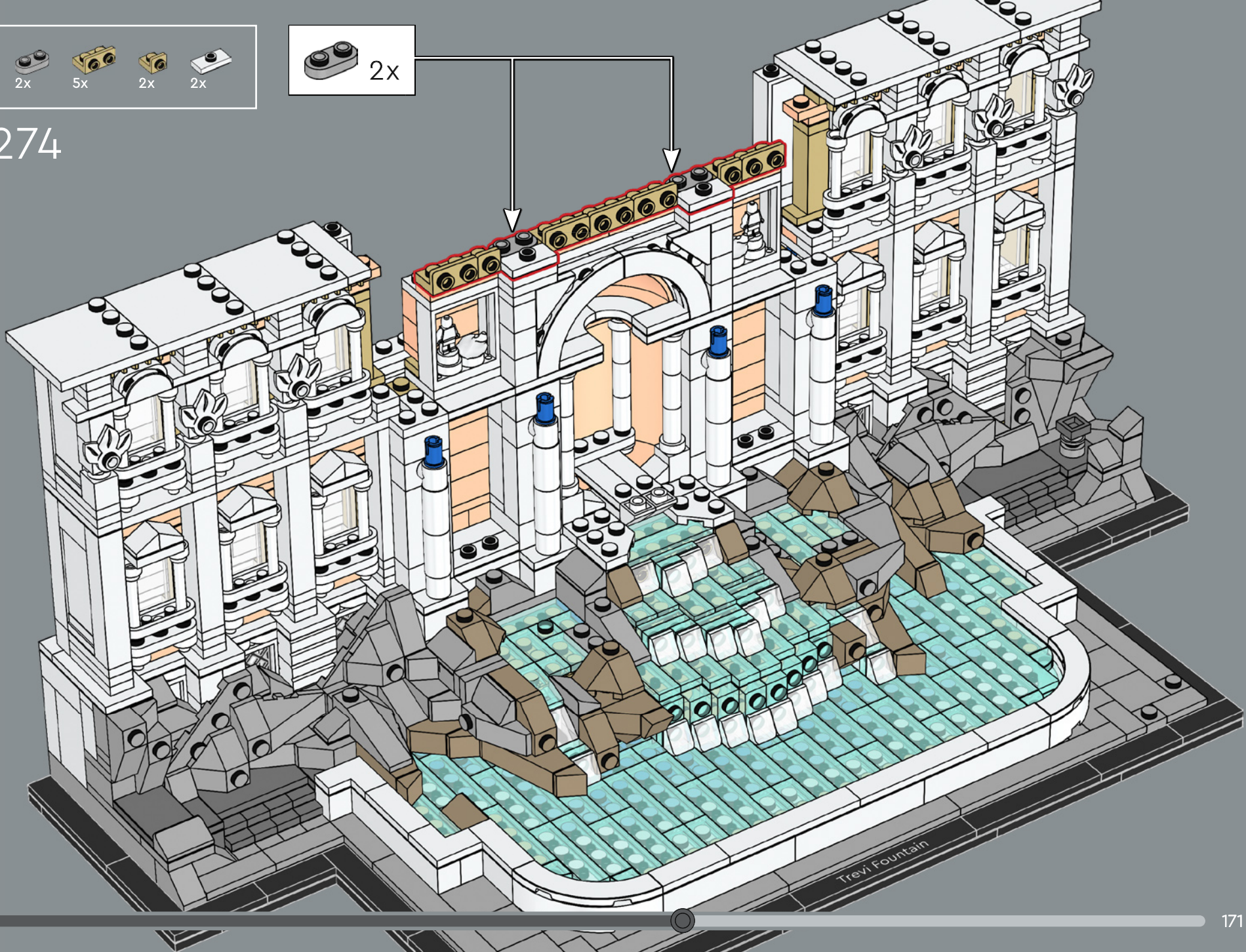

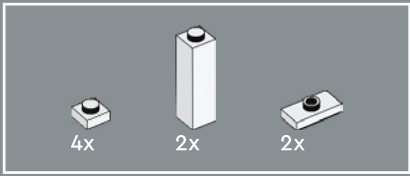

275

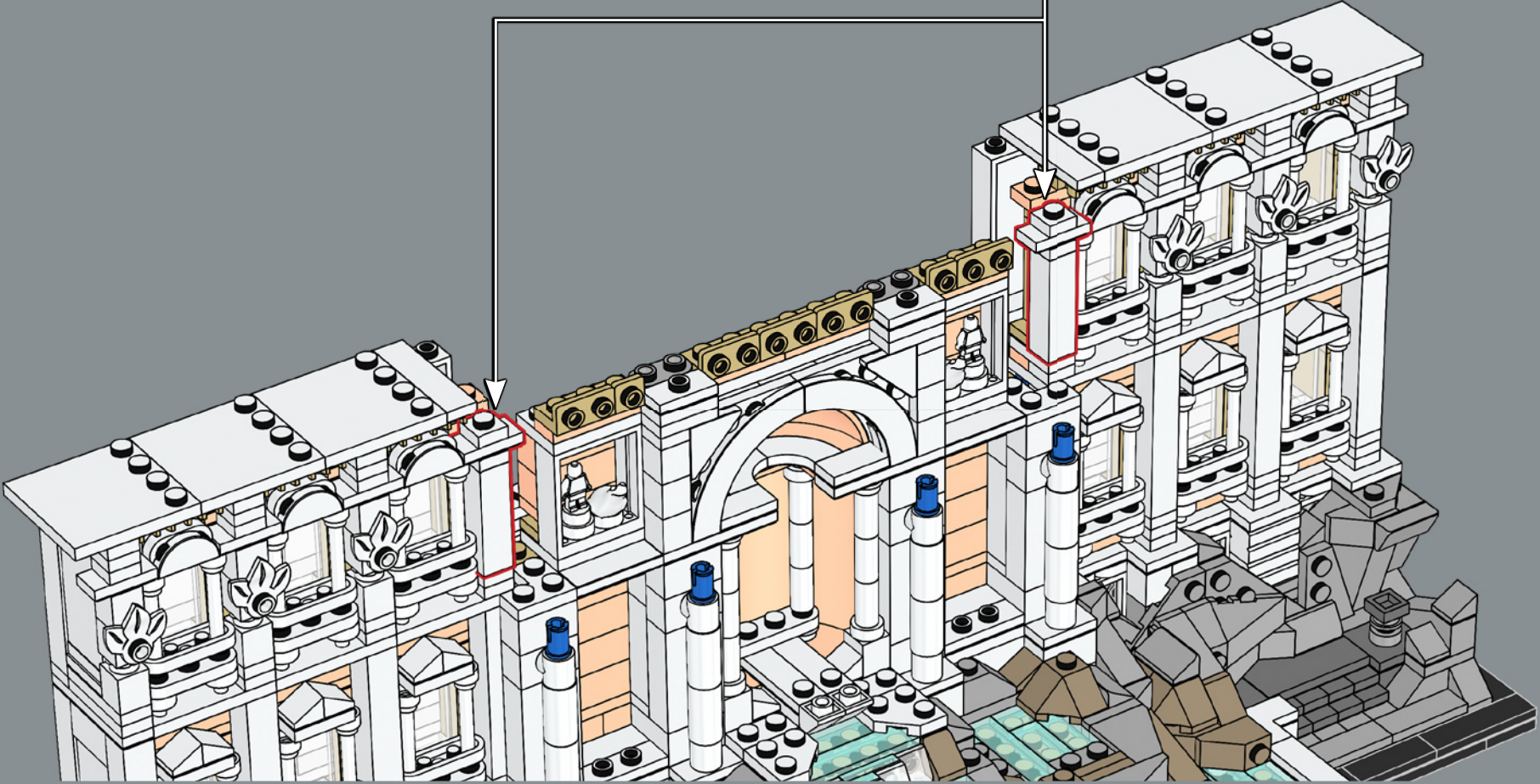
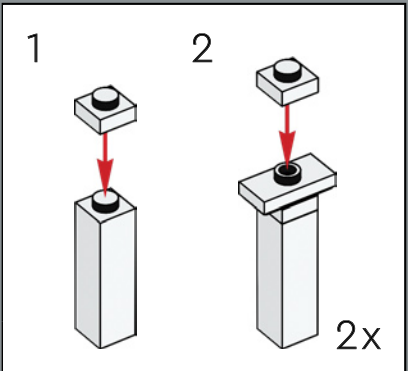

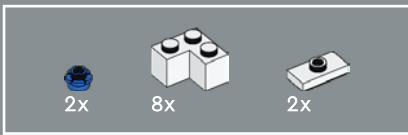

276

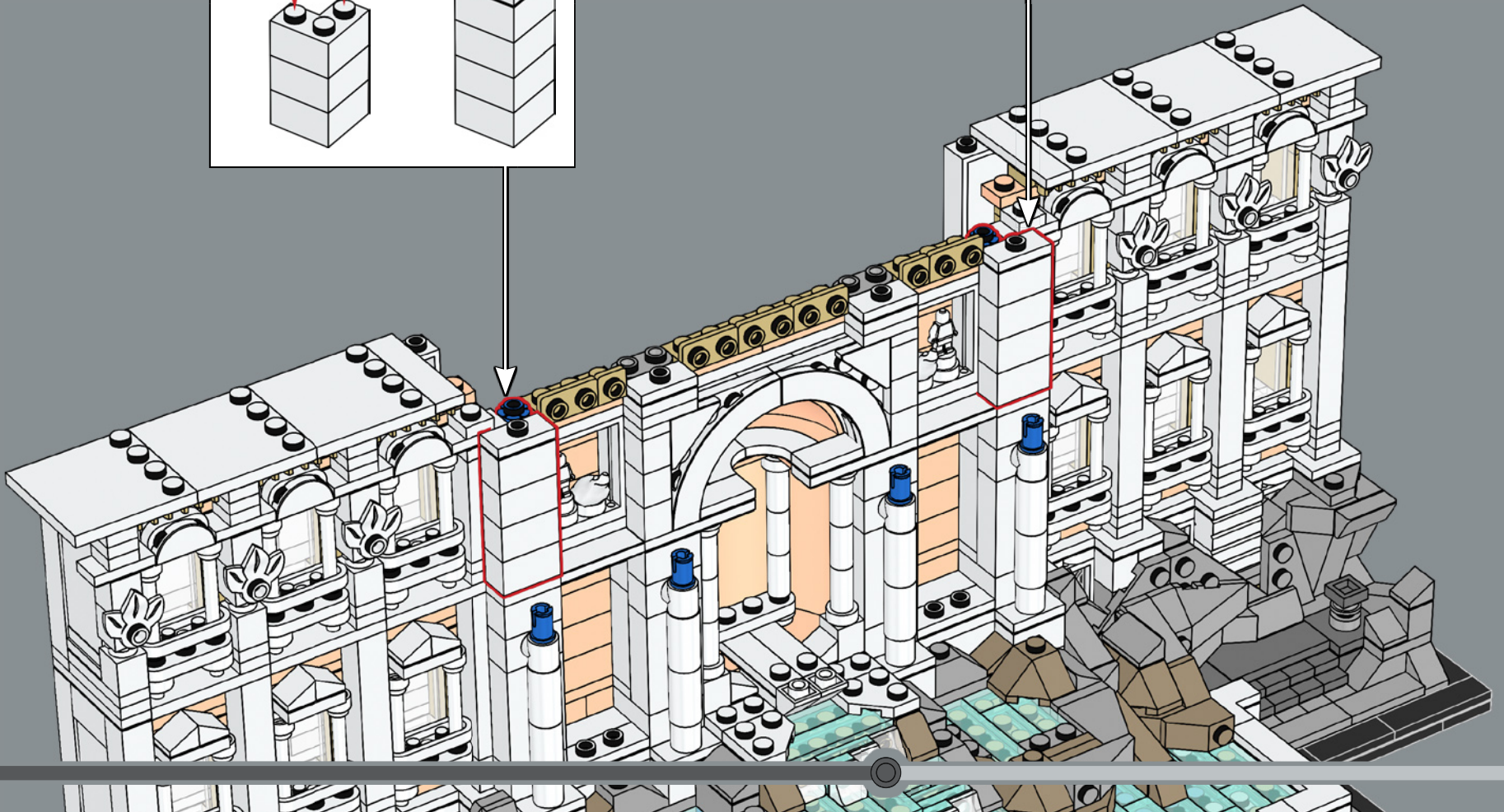
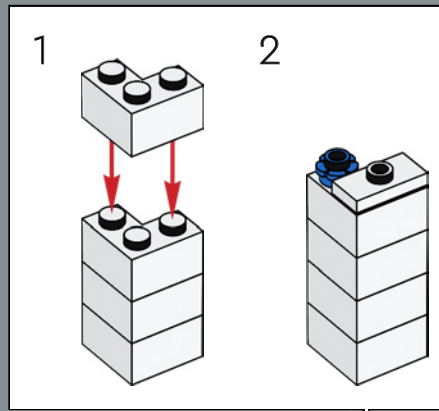
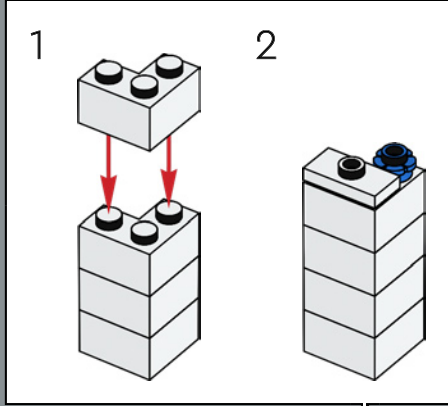



2x



277

1



3



2



4



5

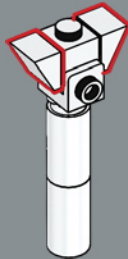

6

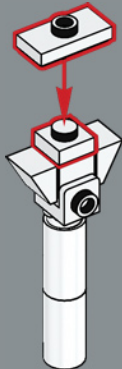

7

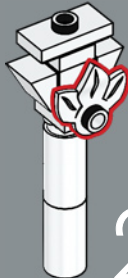

2x

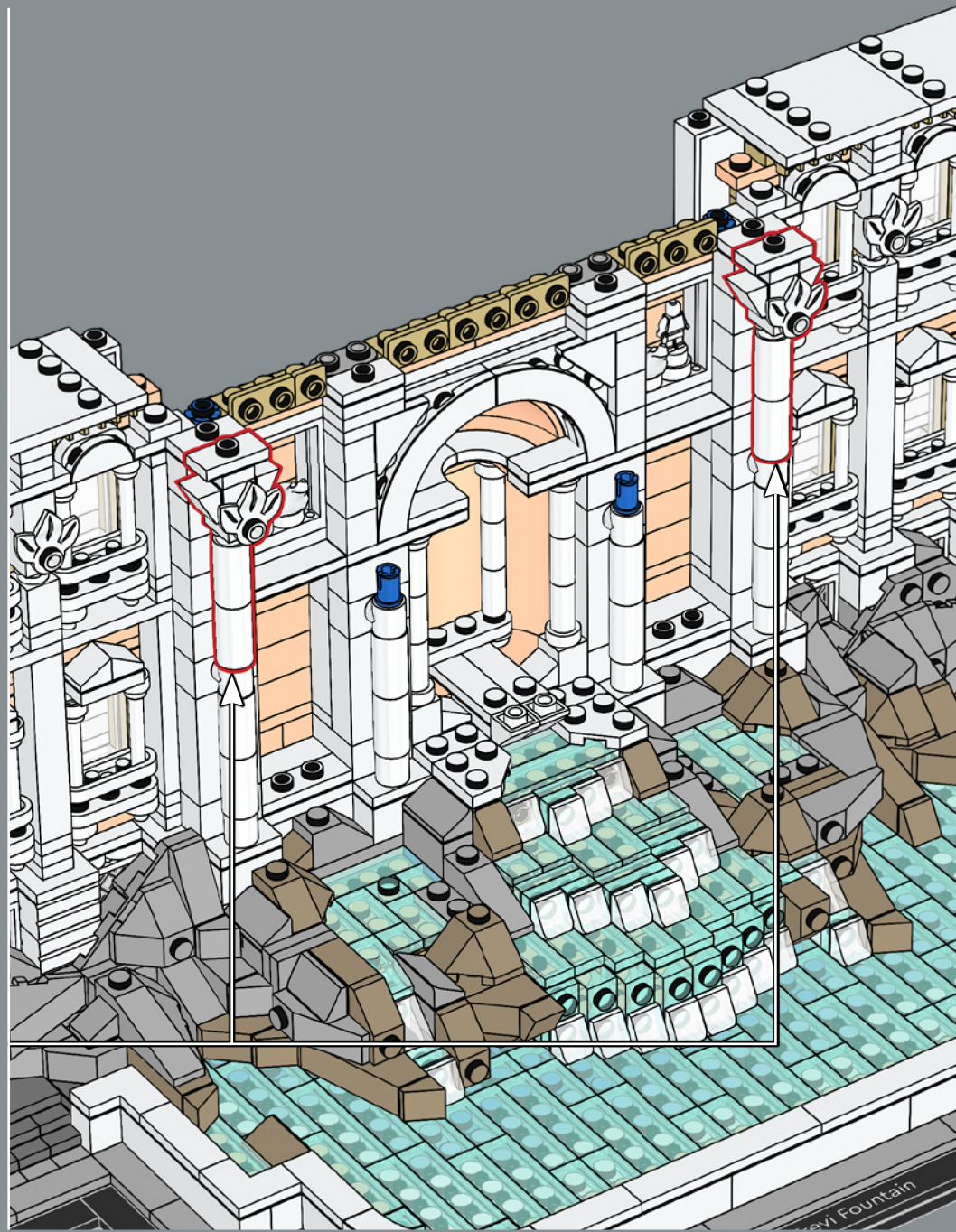

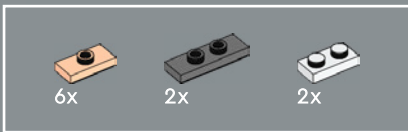

278

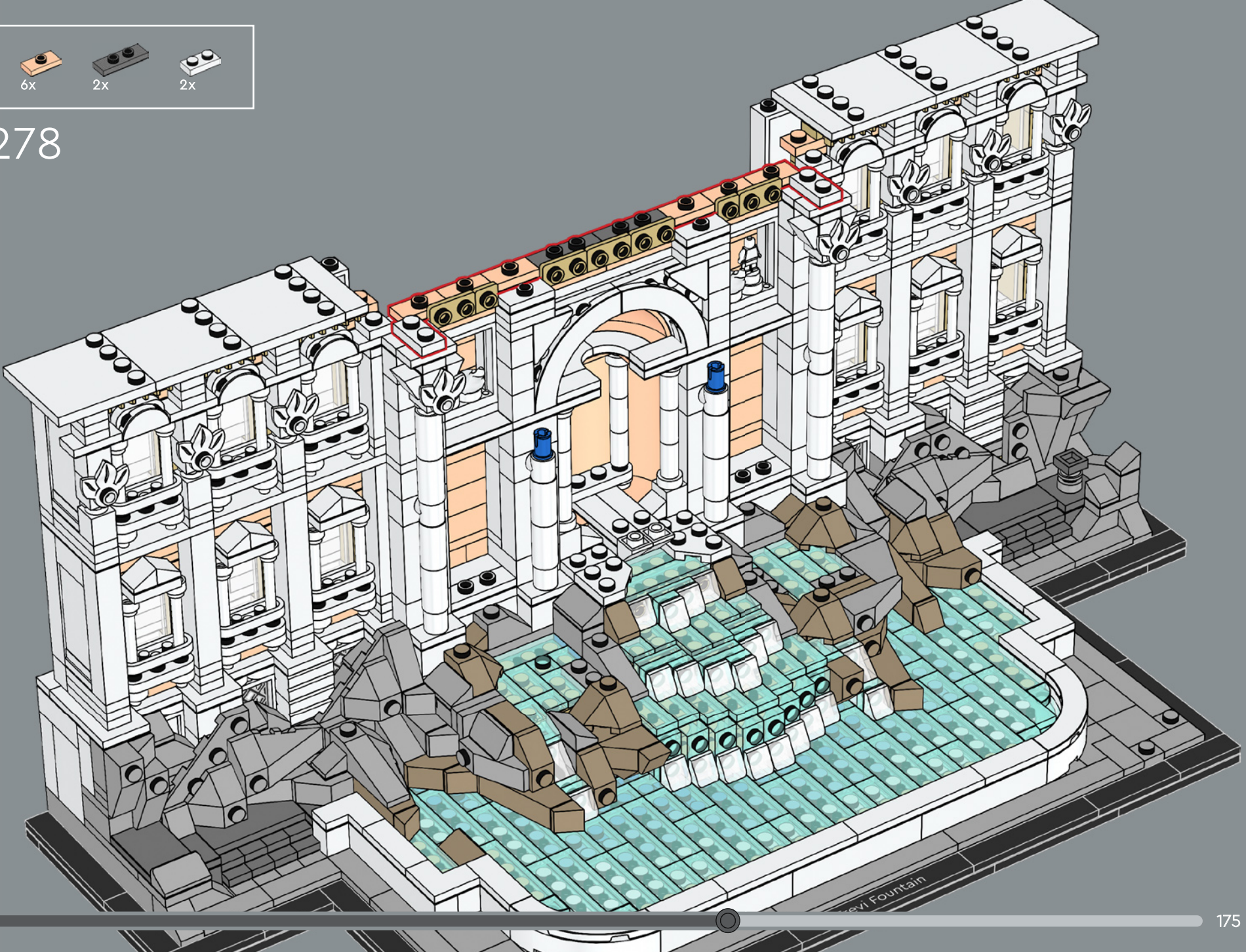

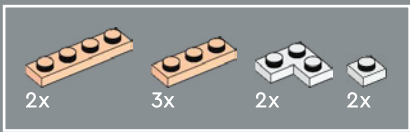

279

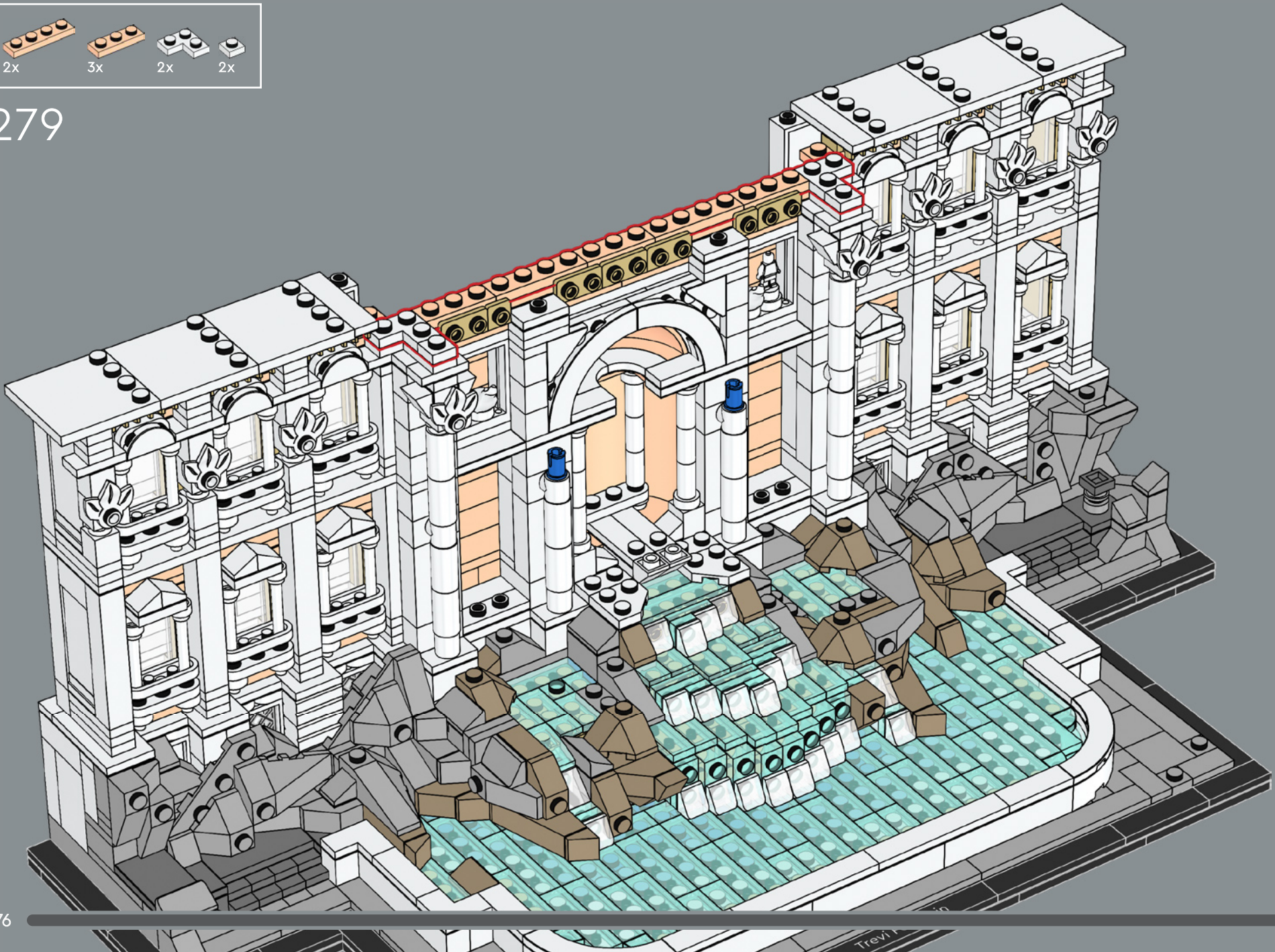



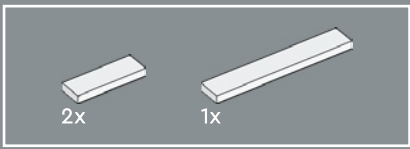

280

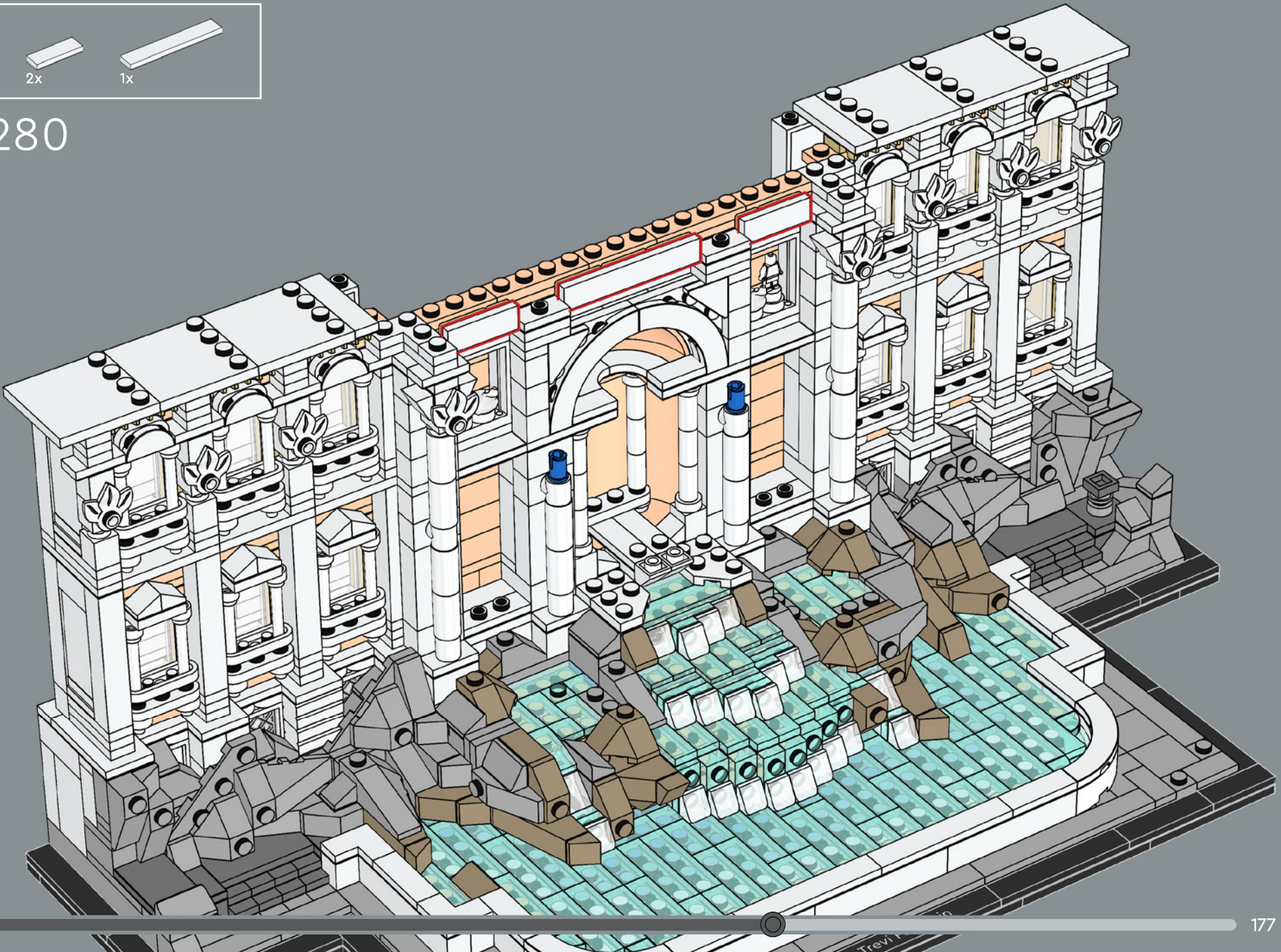



2x



281

1



3



2



4



5

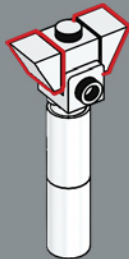

6

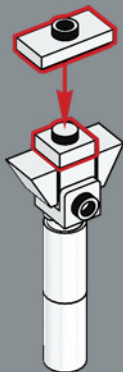

7

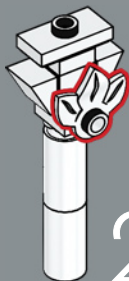

2x

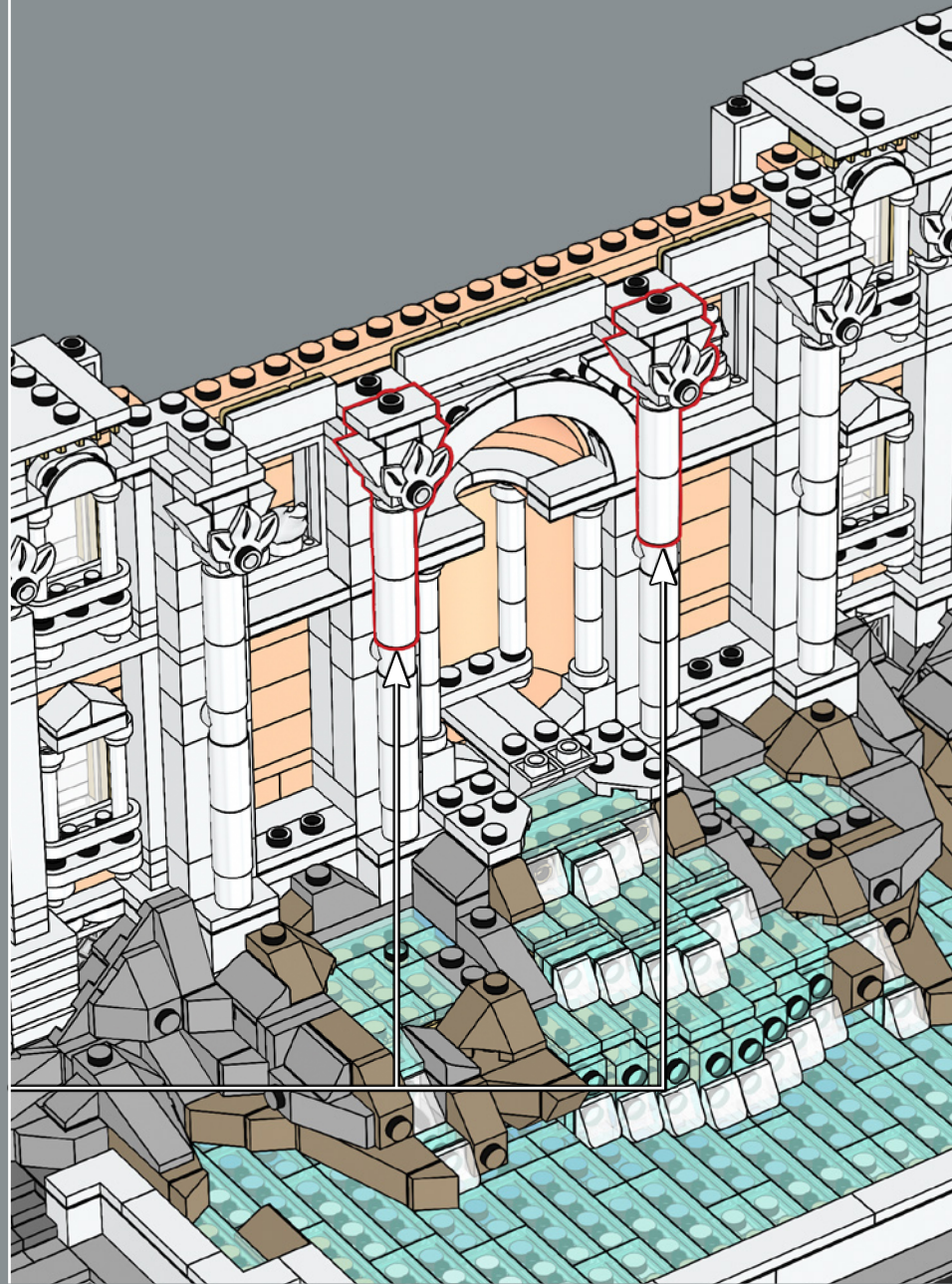

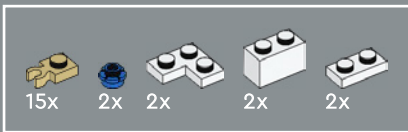

282

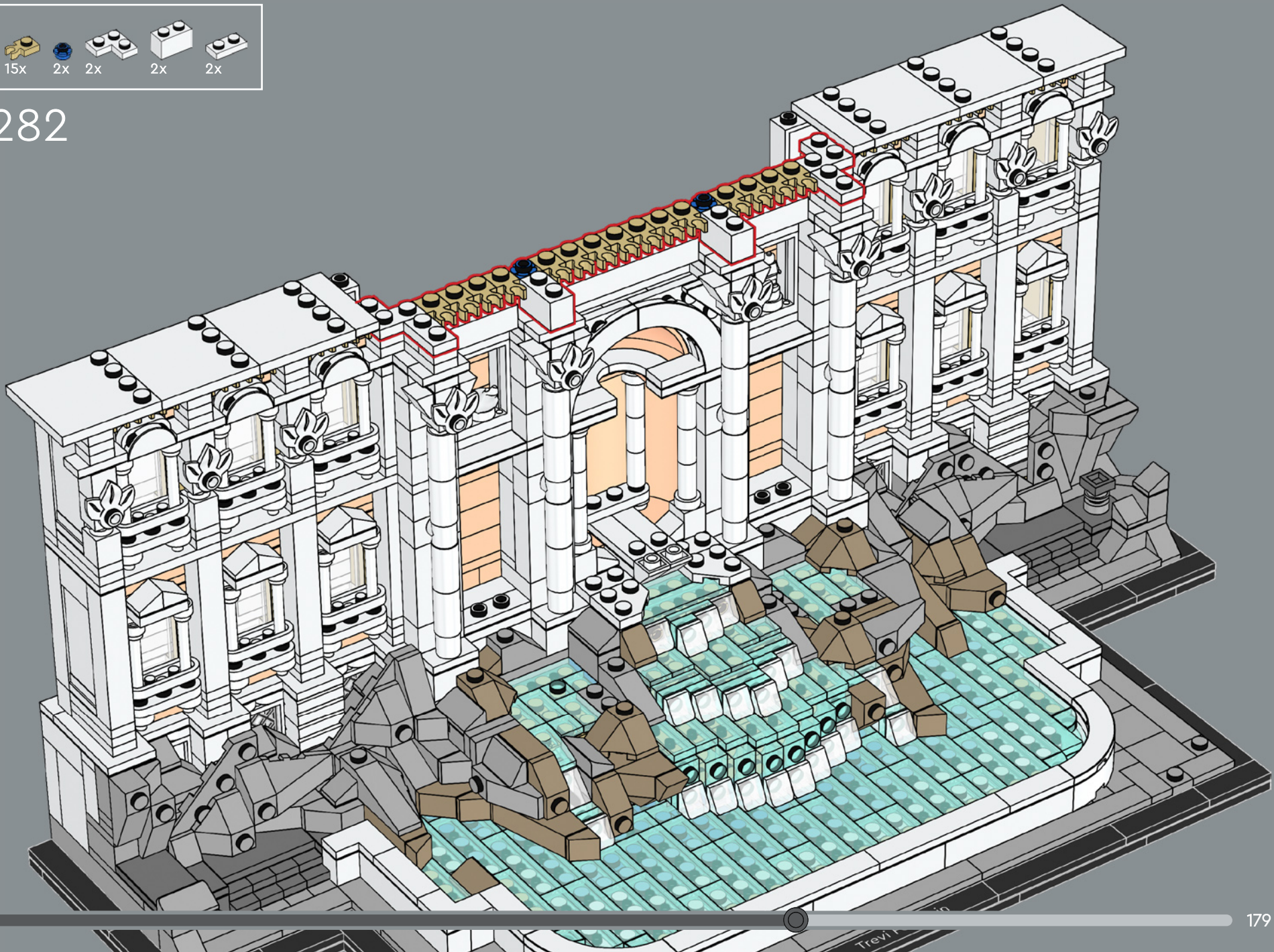

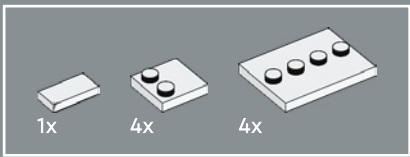

283

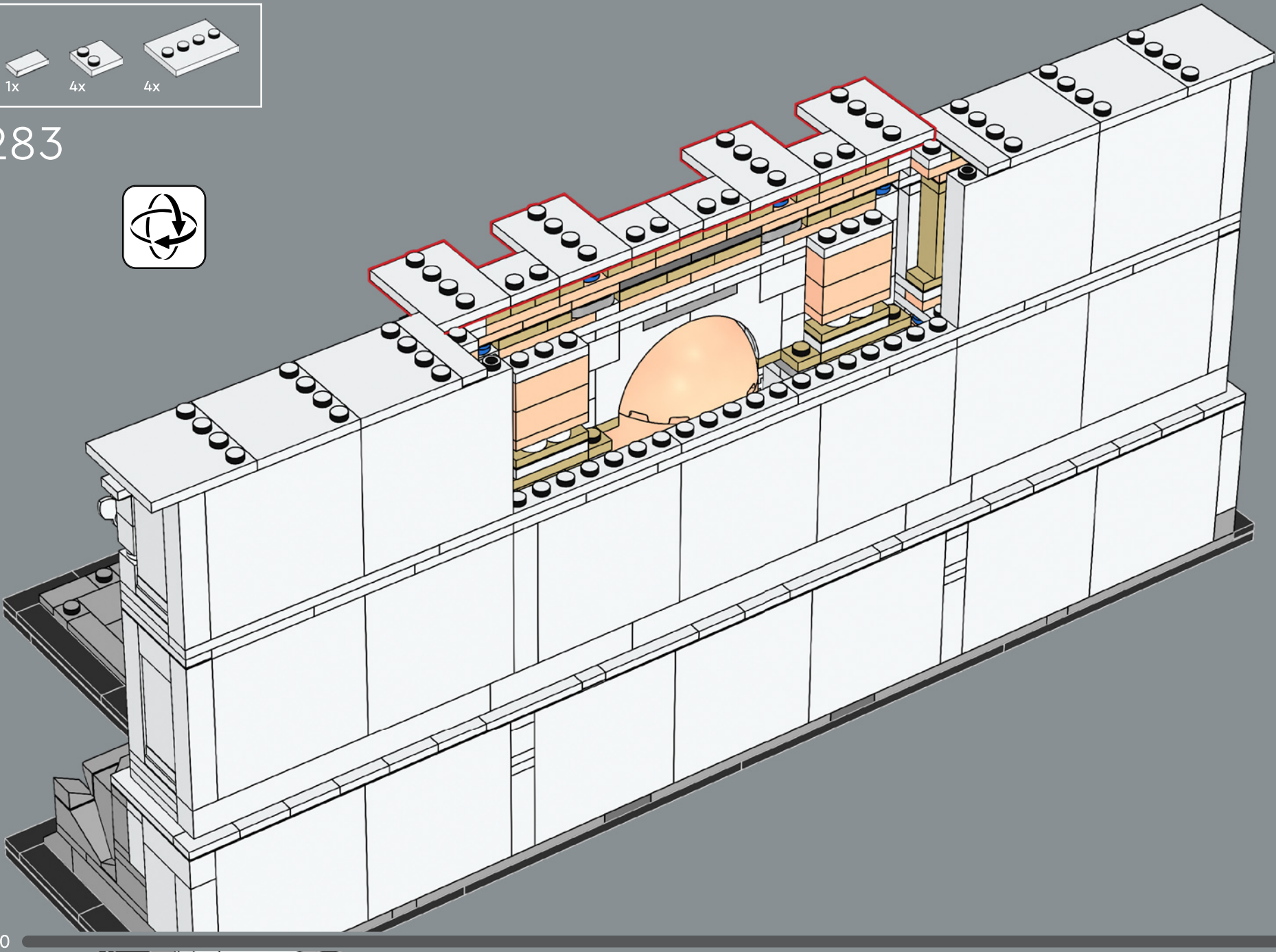

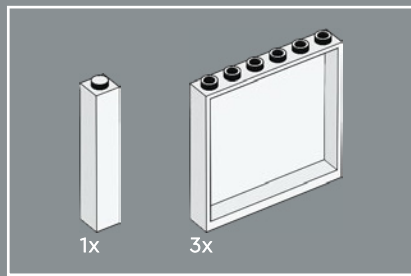

284

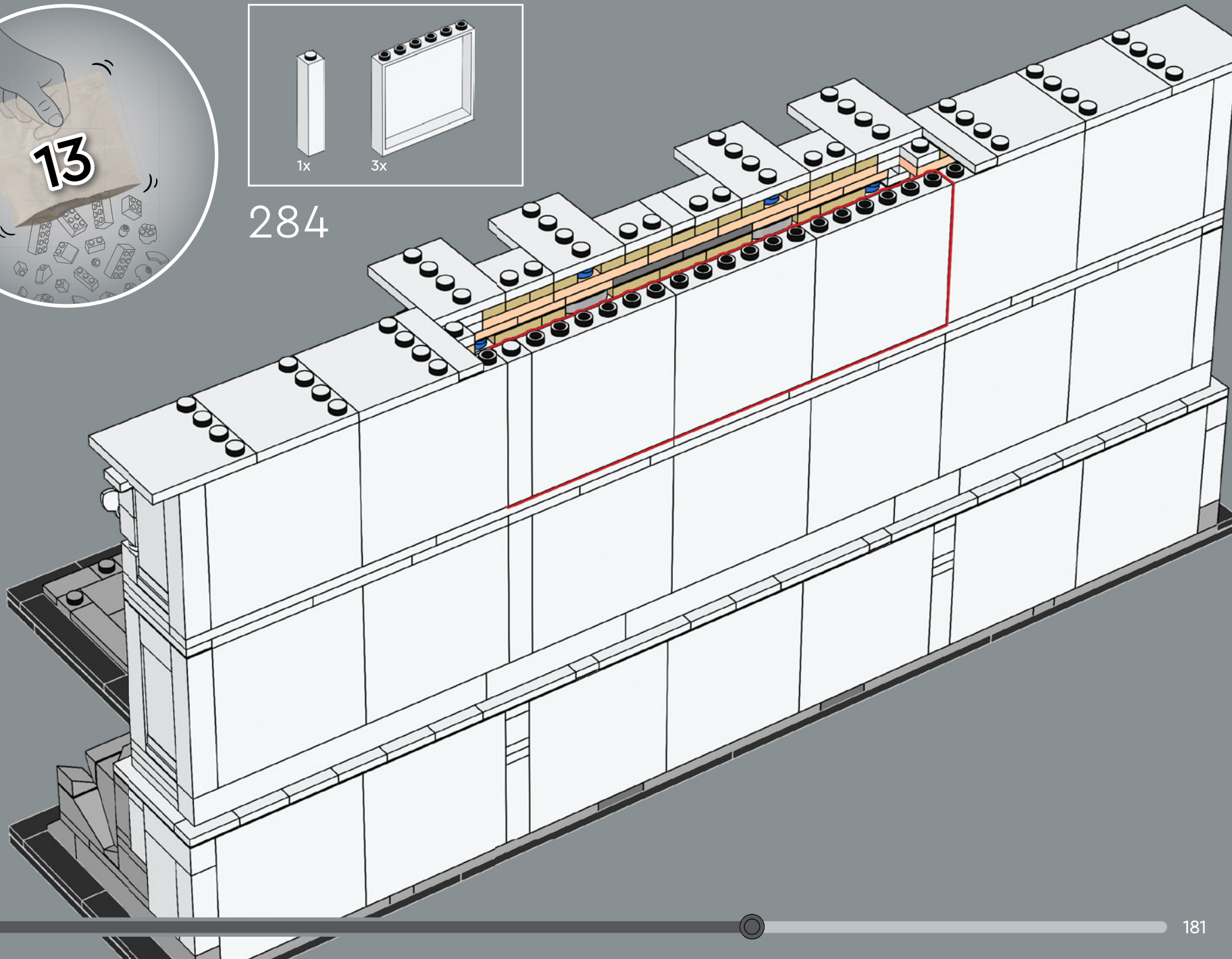

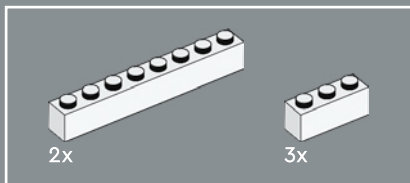

在现实生活中，罗马许愿池是海神宫的立面，海神宫曾是教皇的住所，现在是博物馆的所在地。该建筑不是喷泉的巴洛克风格，而是继续向后延伸，与周围的建筑相匹配。

285

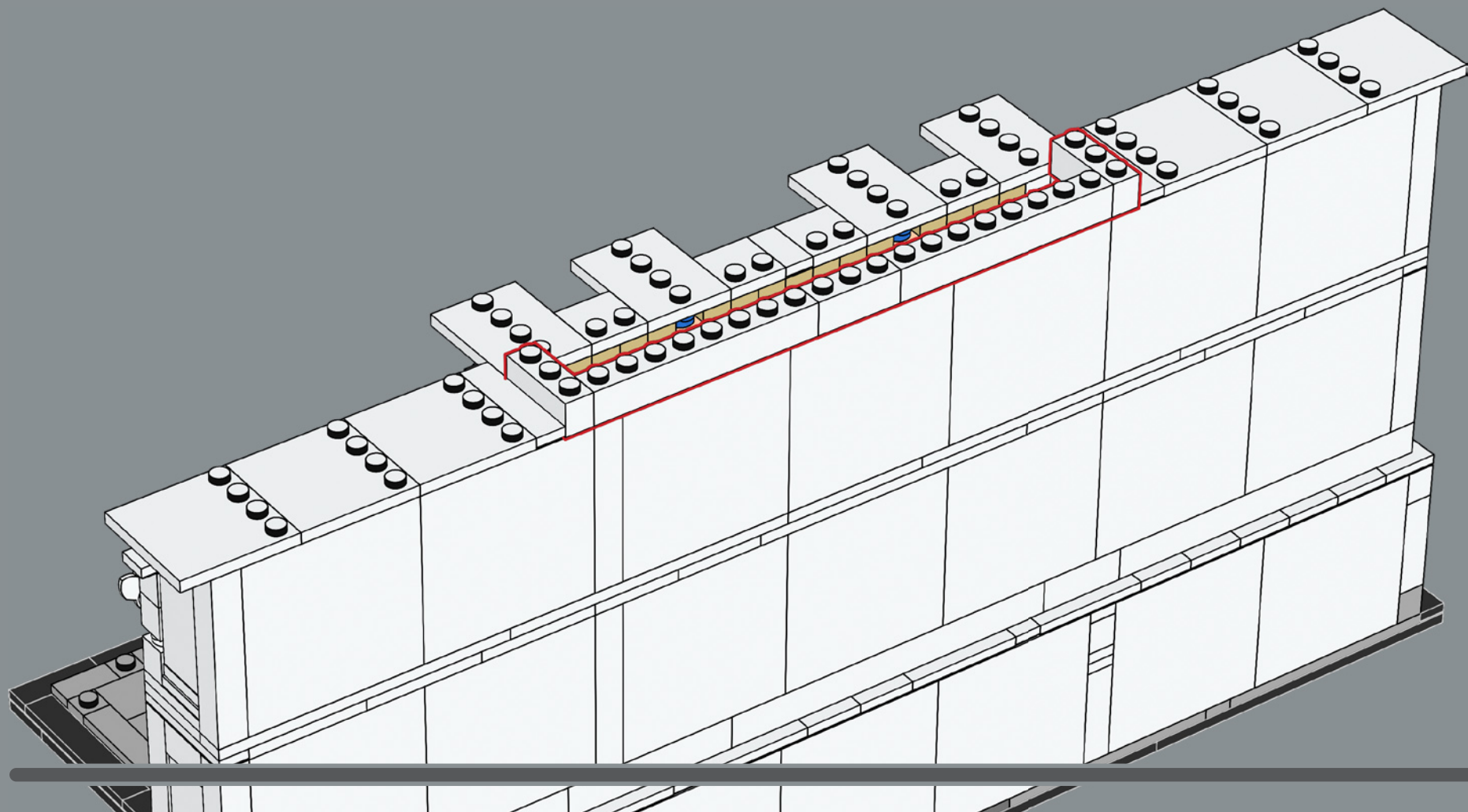

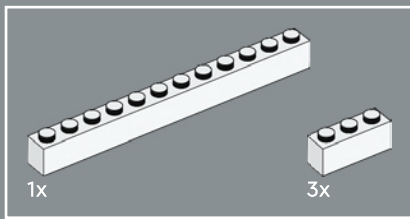

286

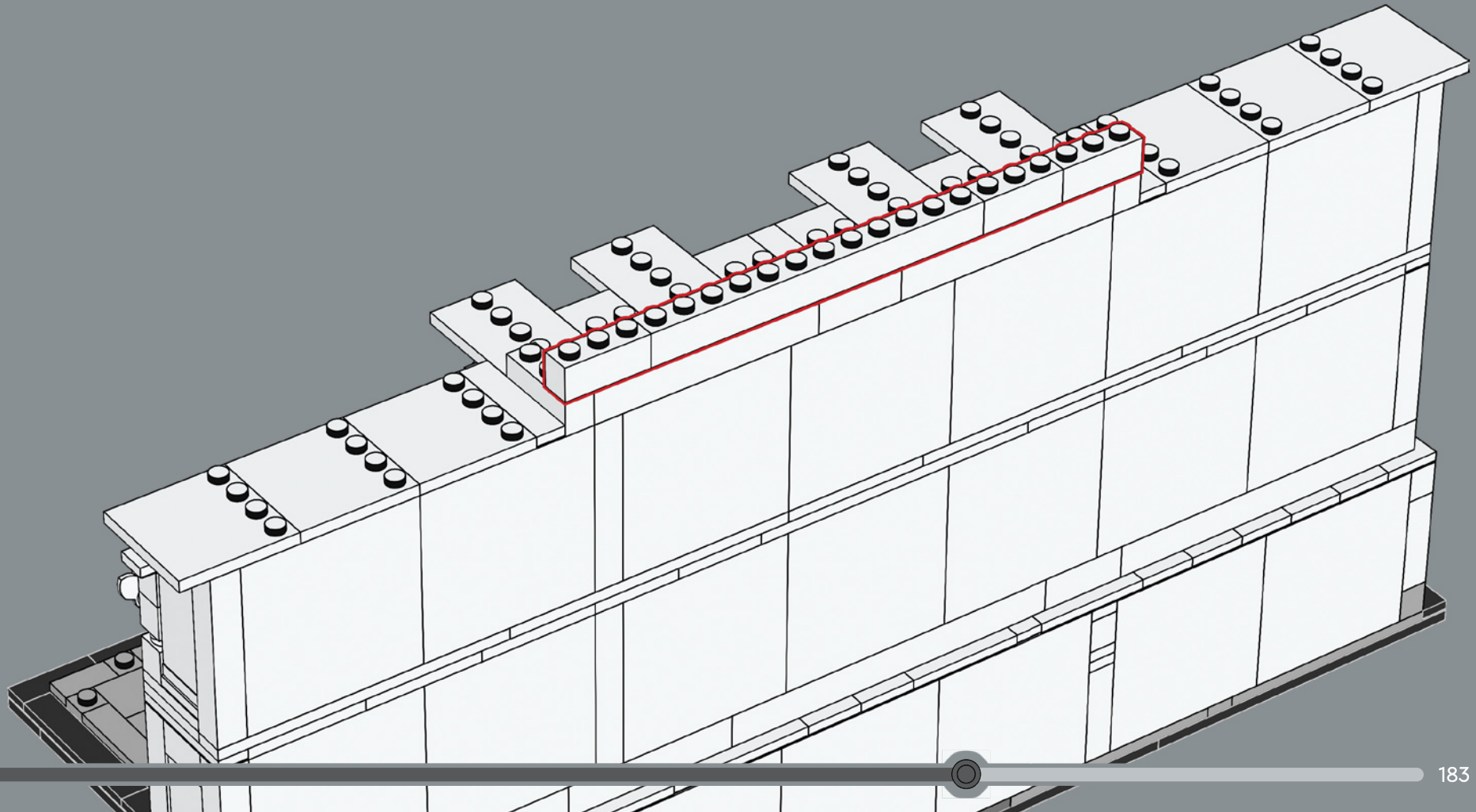

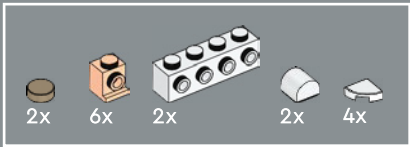

287

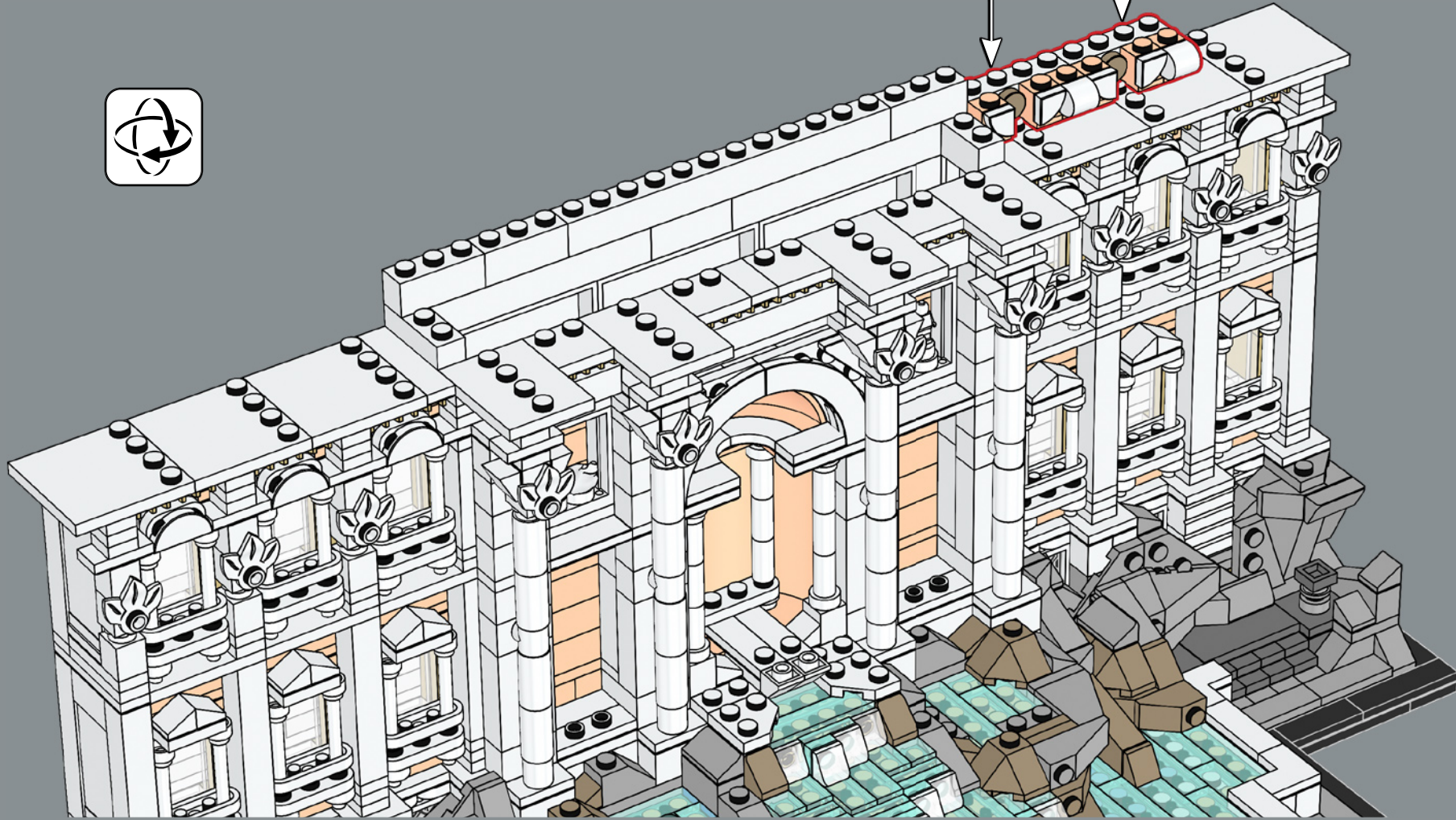
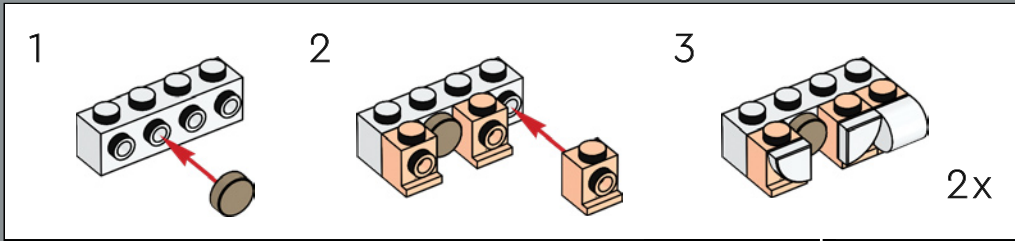



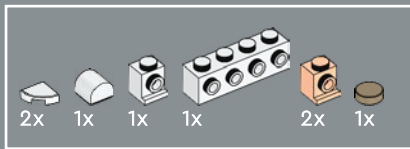

288

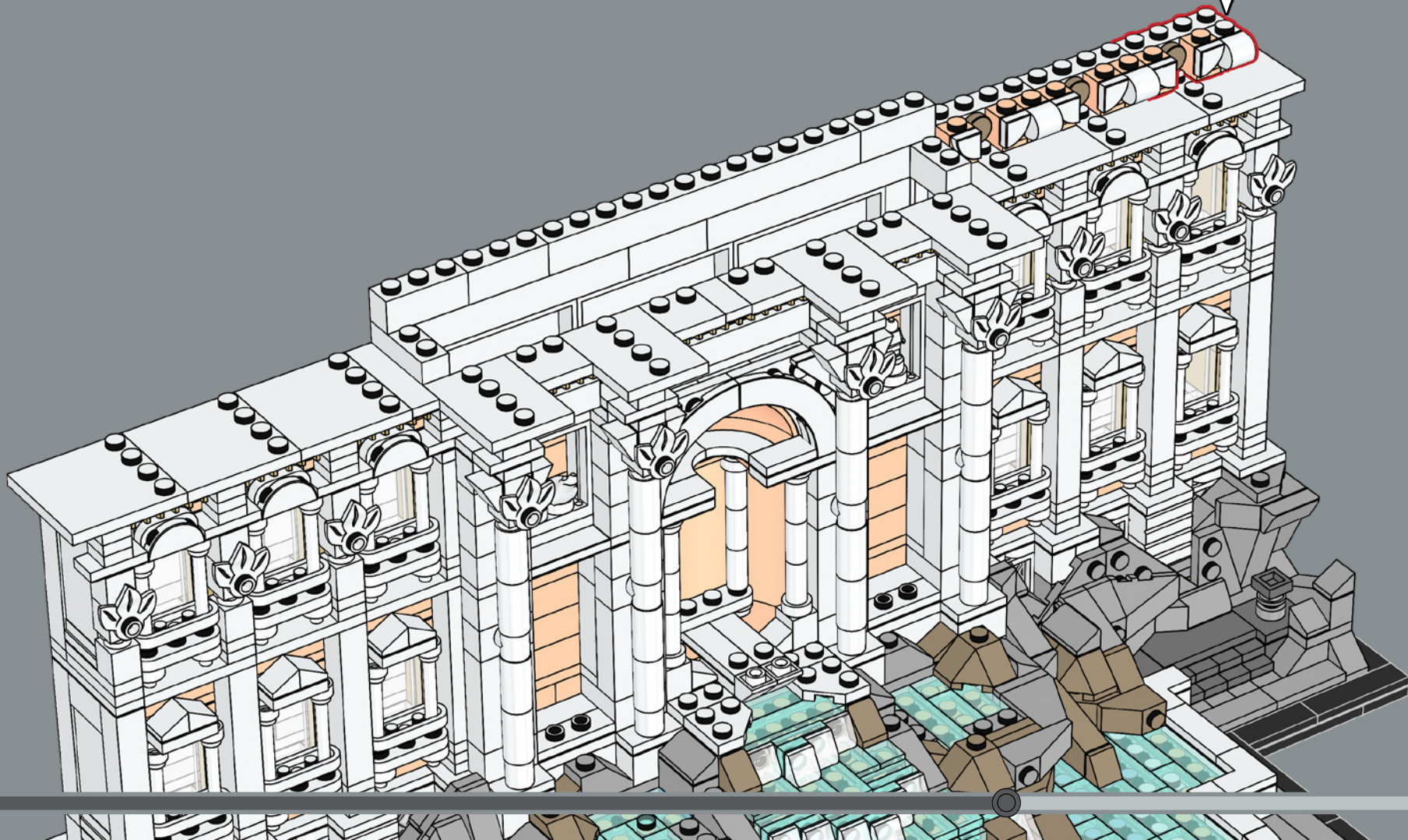
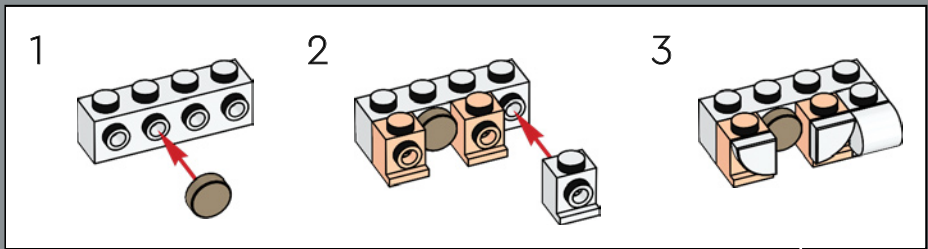

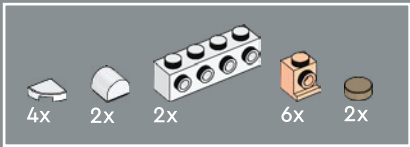

289

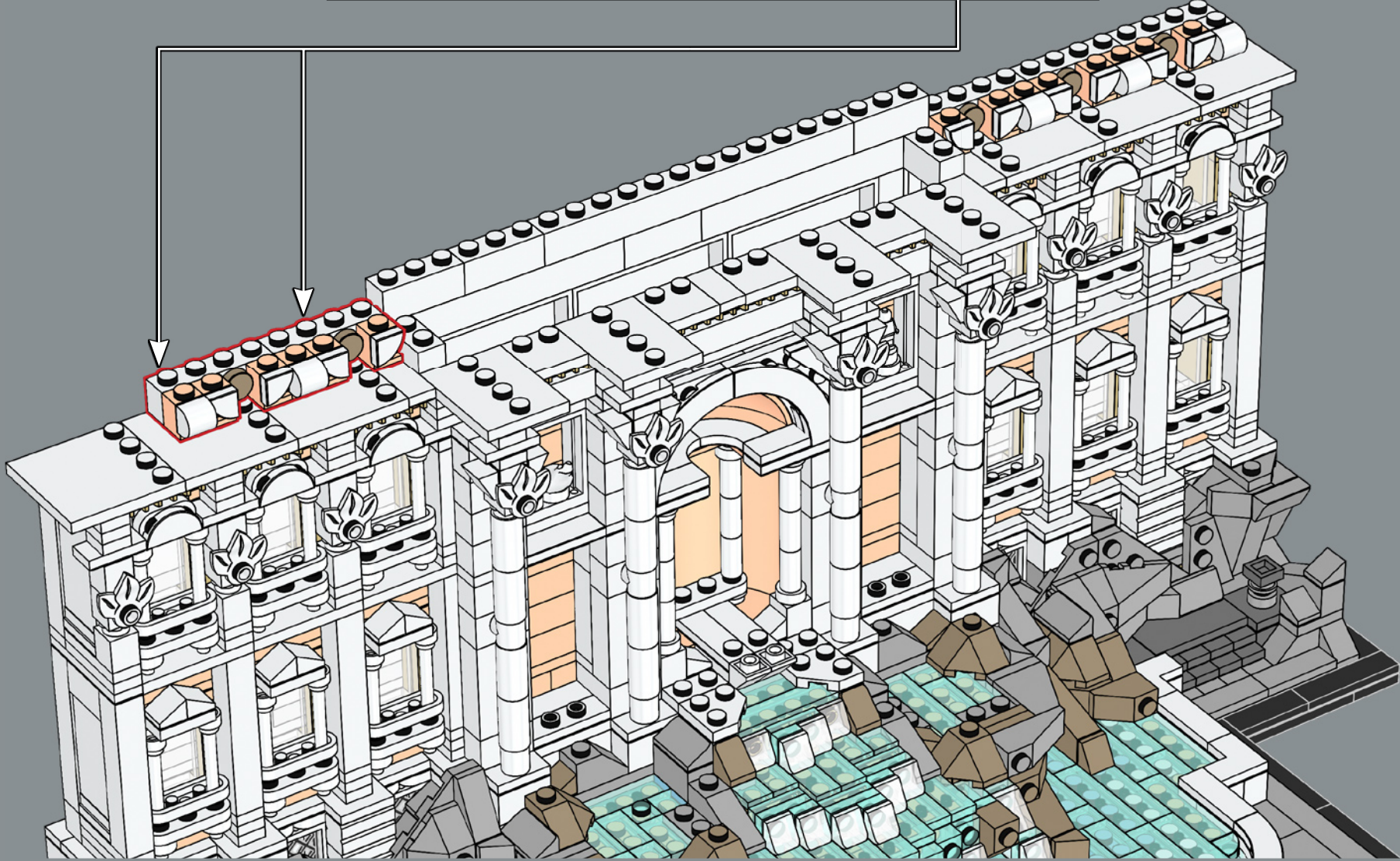
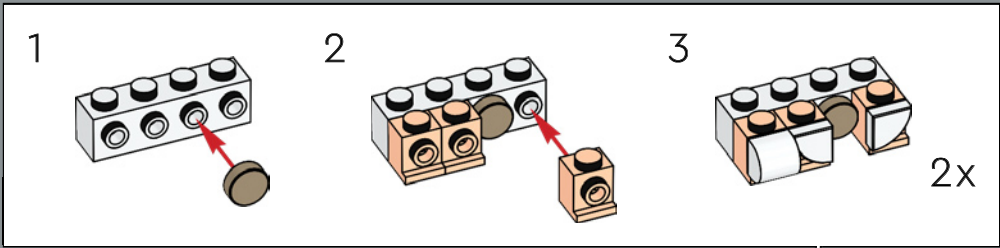

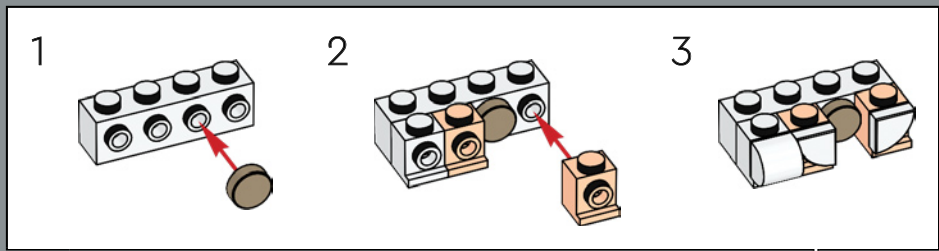
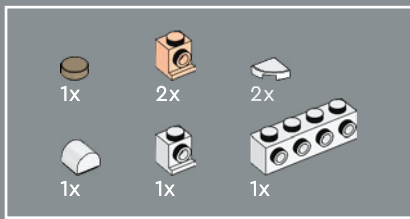

290

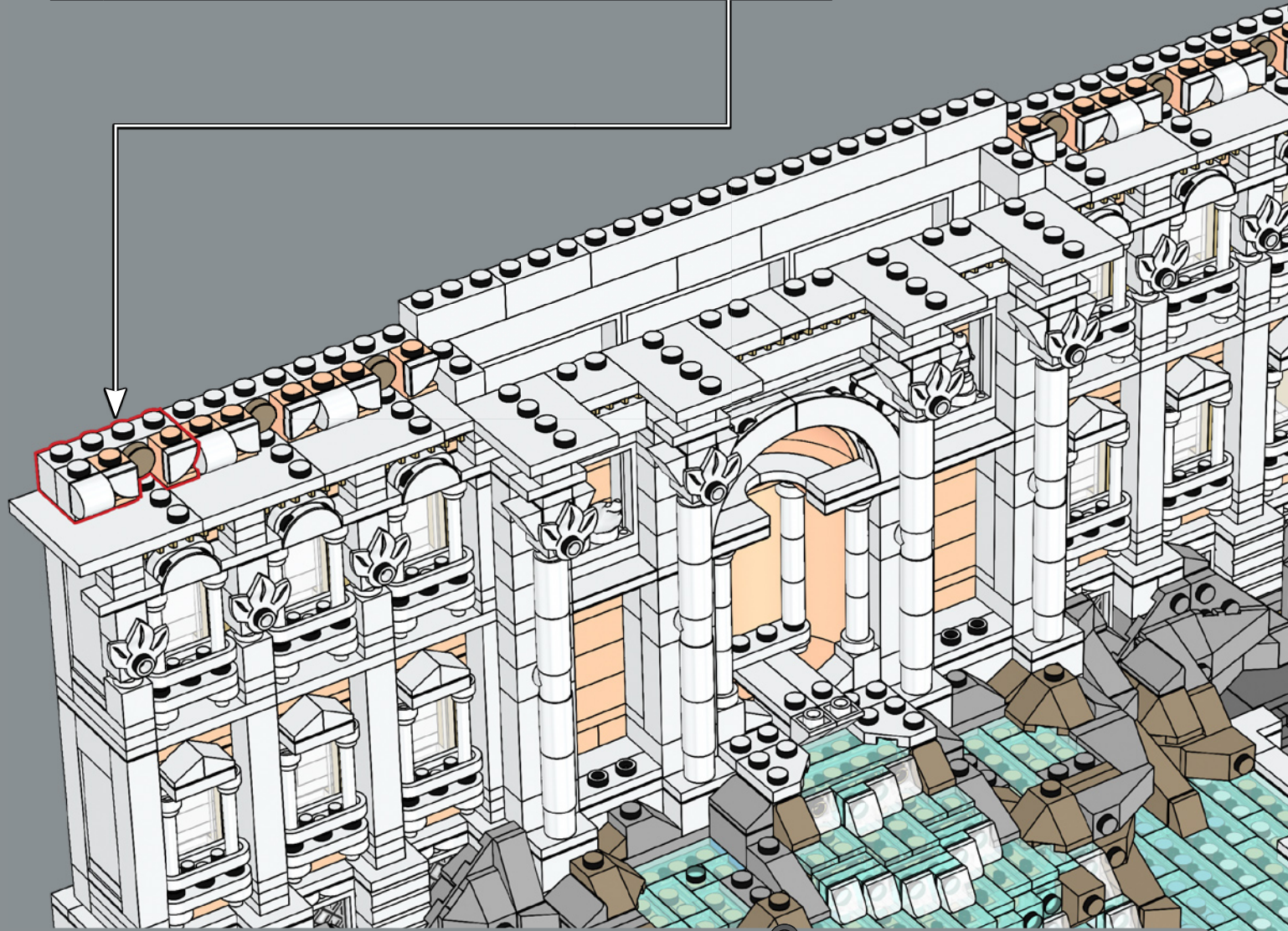



6x

291

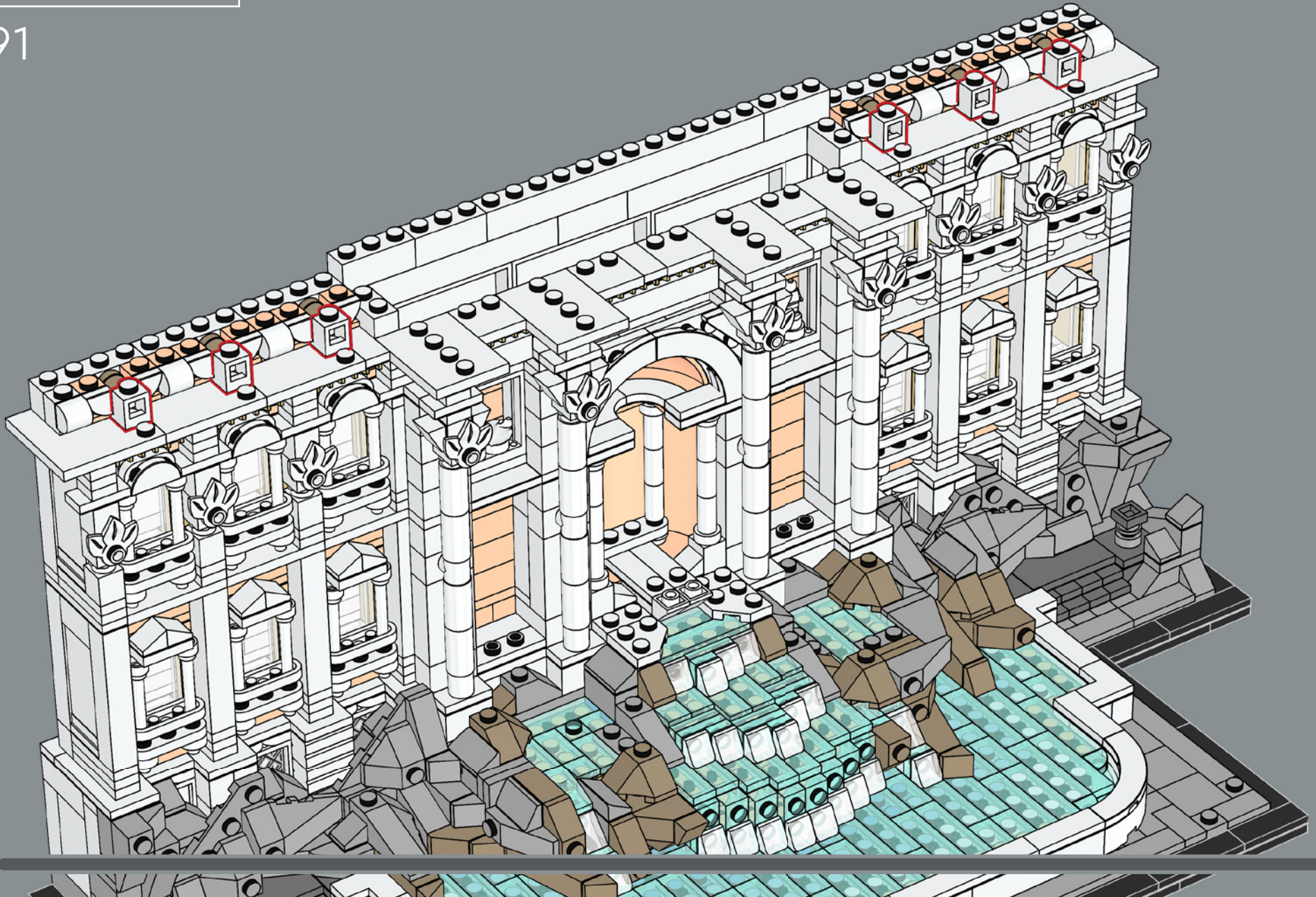

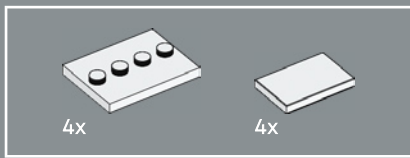

292

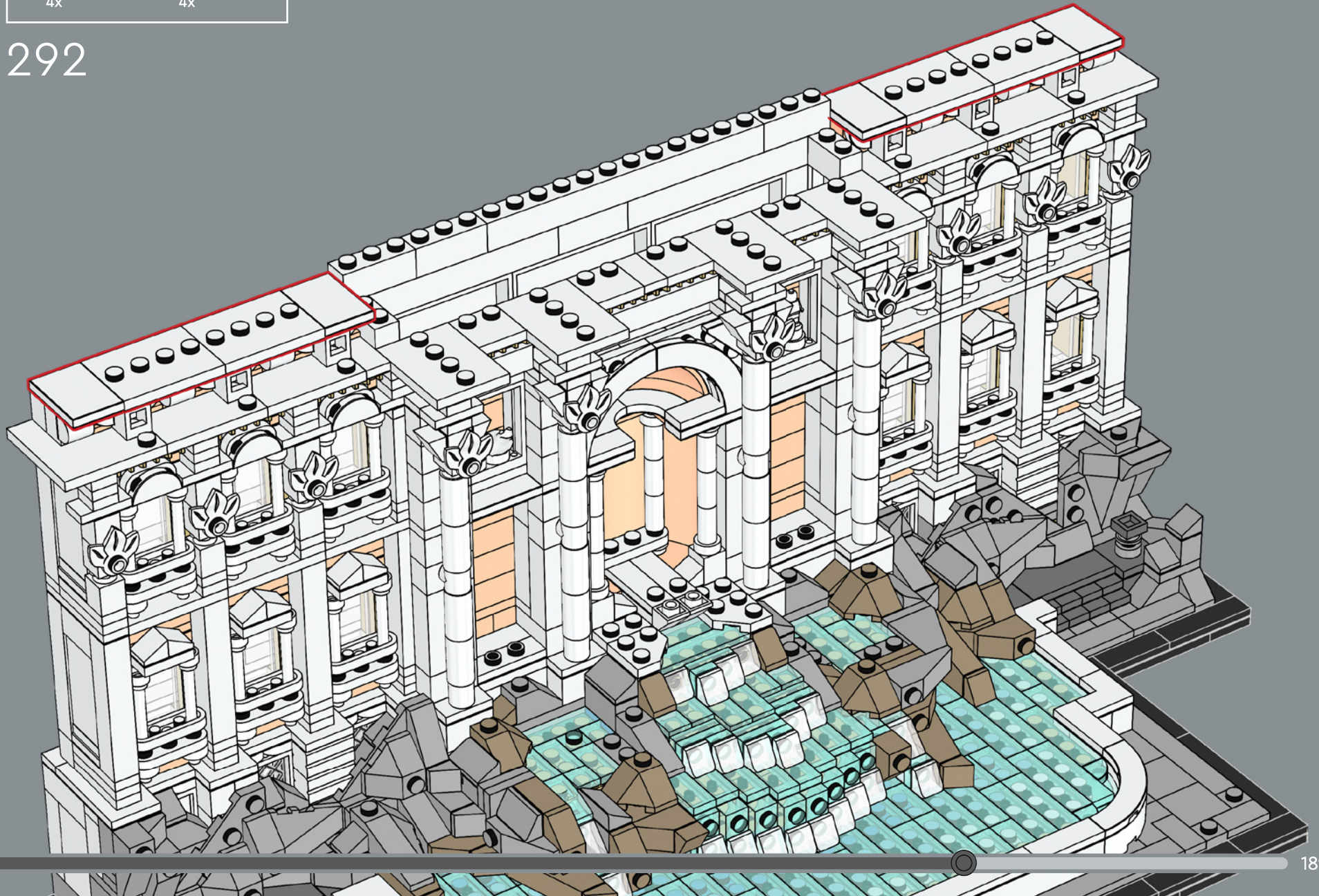

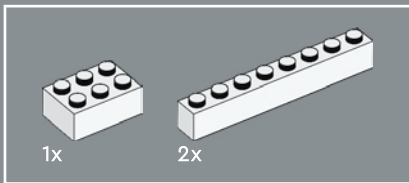

293

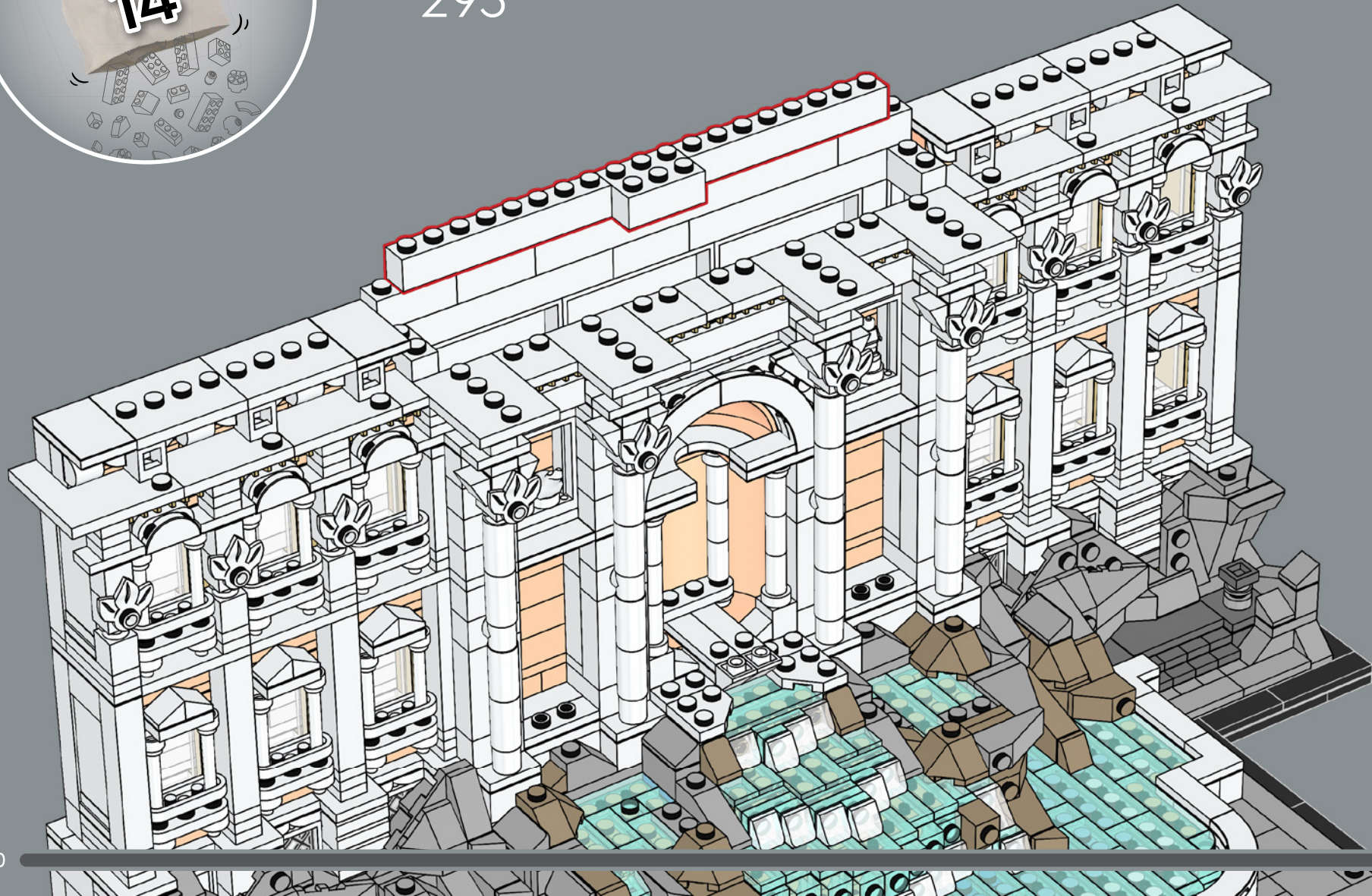

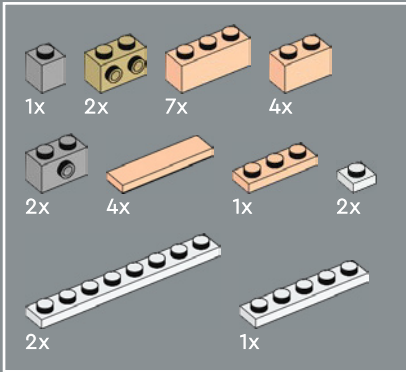
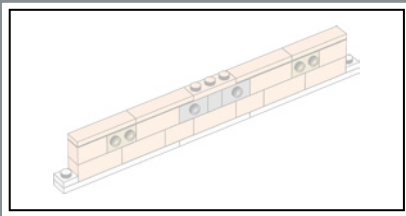

294

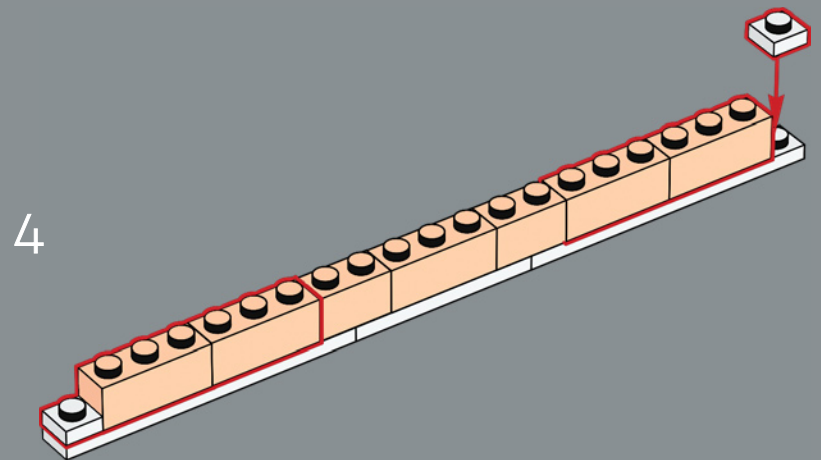
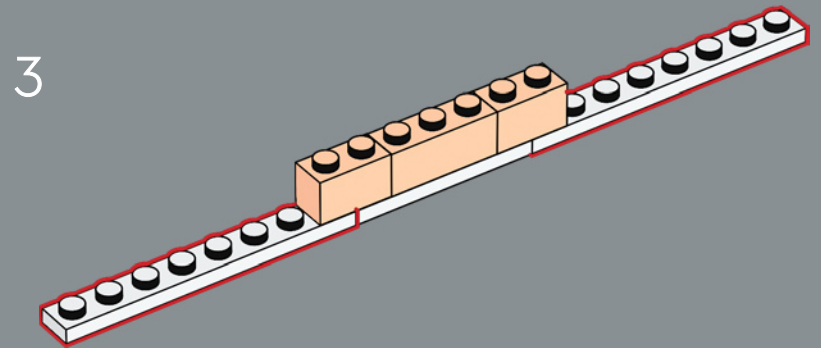
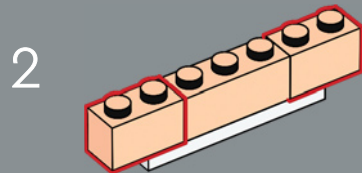
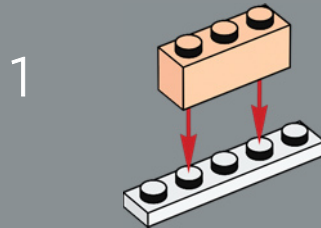

5

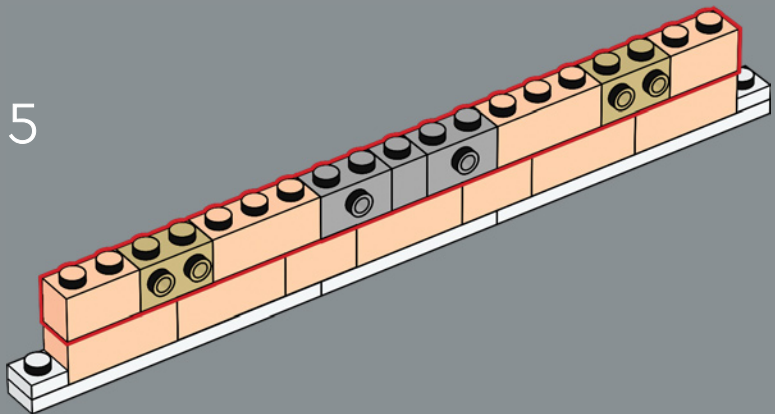

6

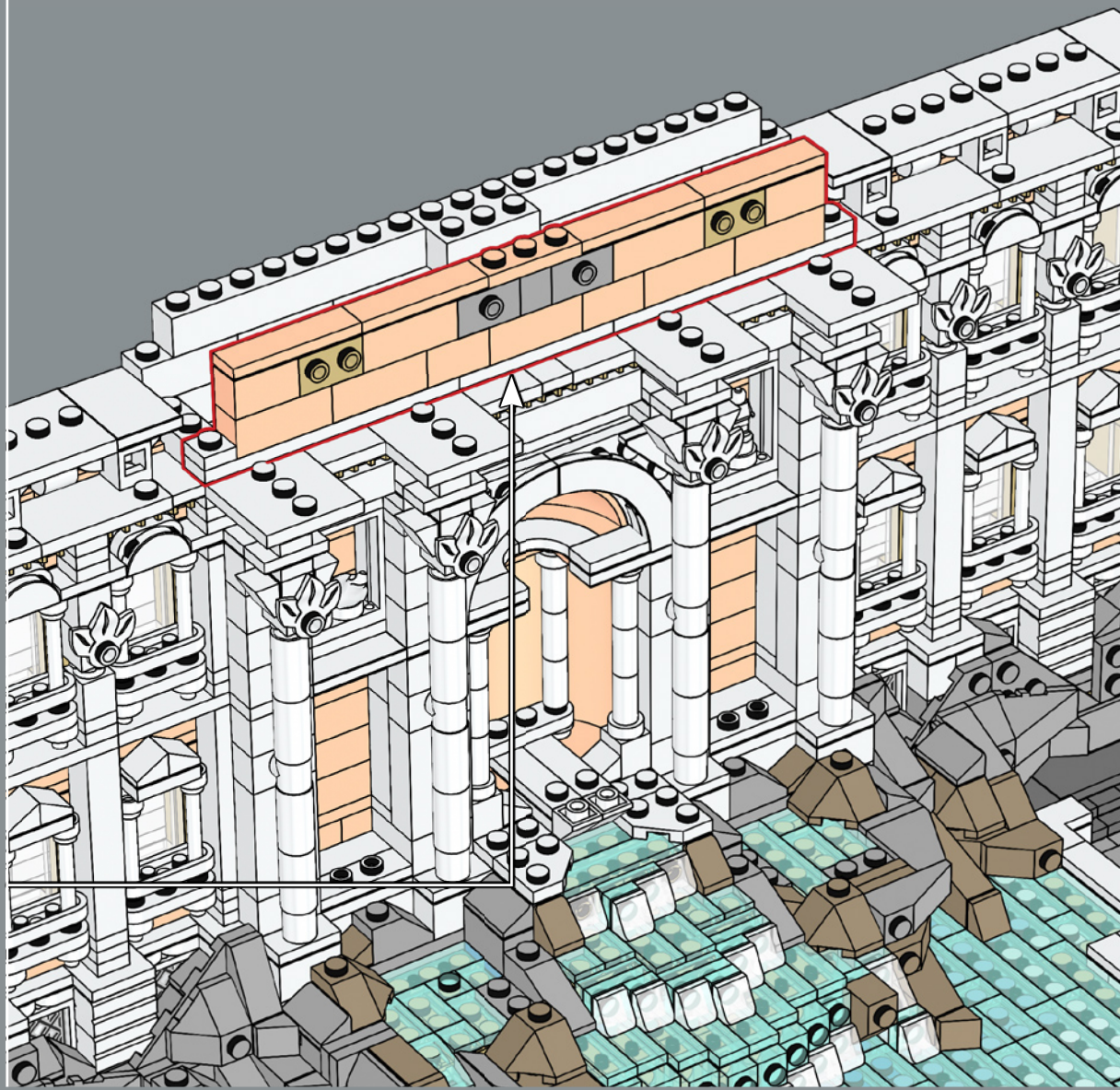
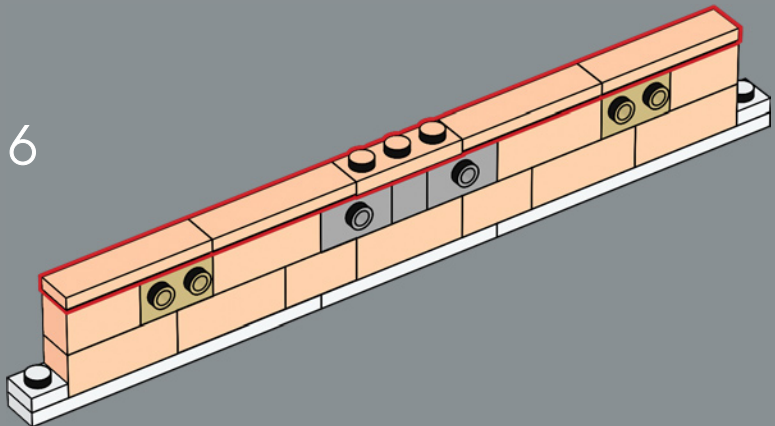



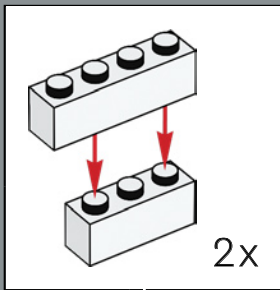
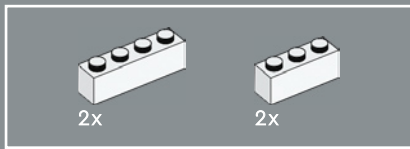

295

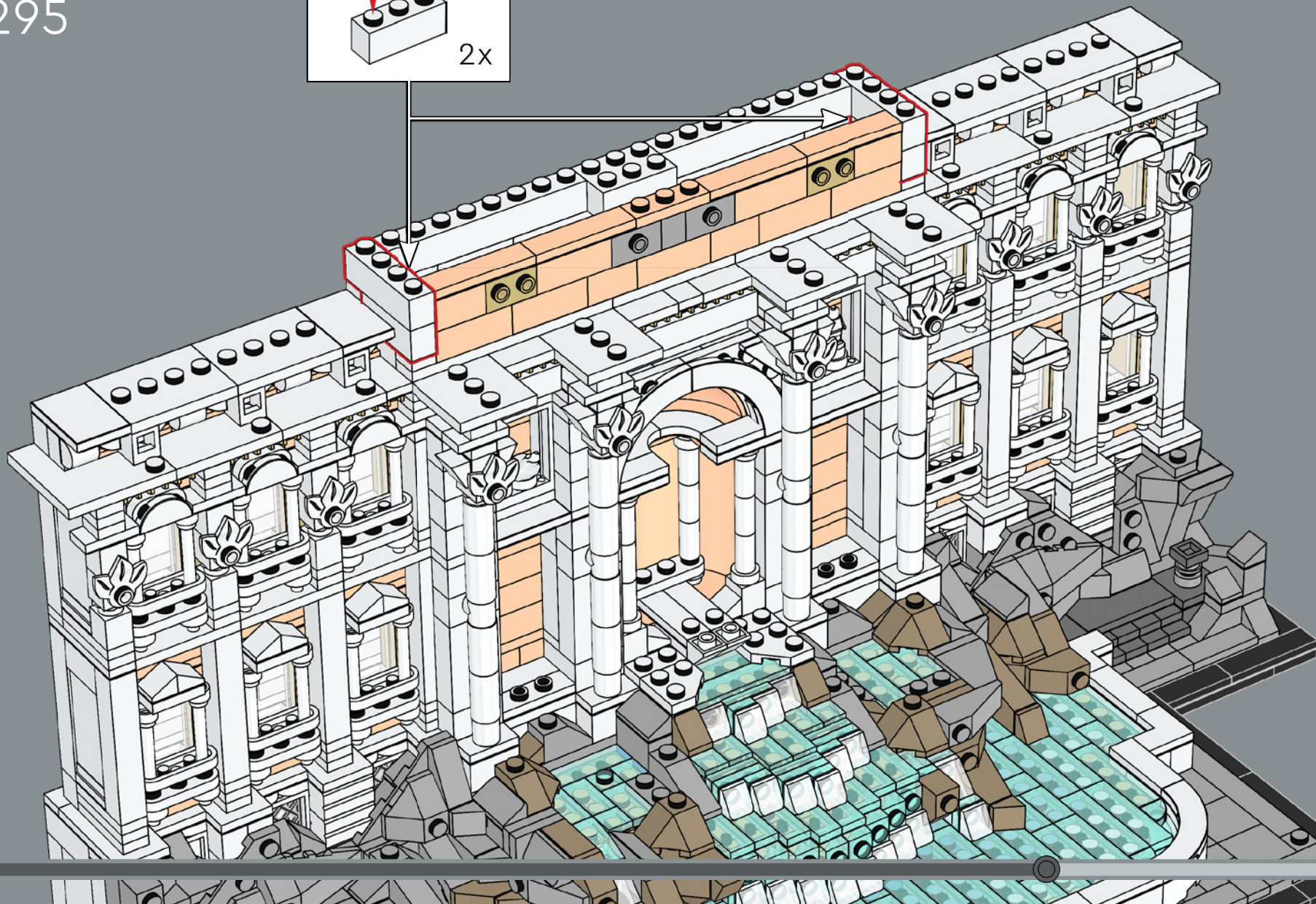

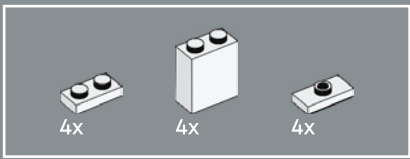

296

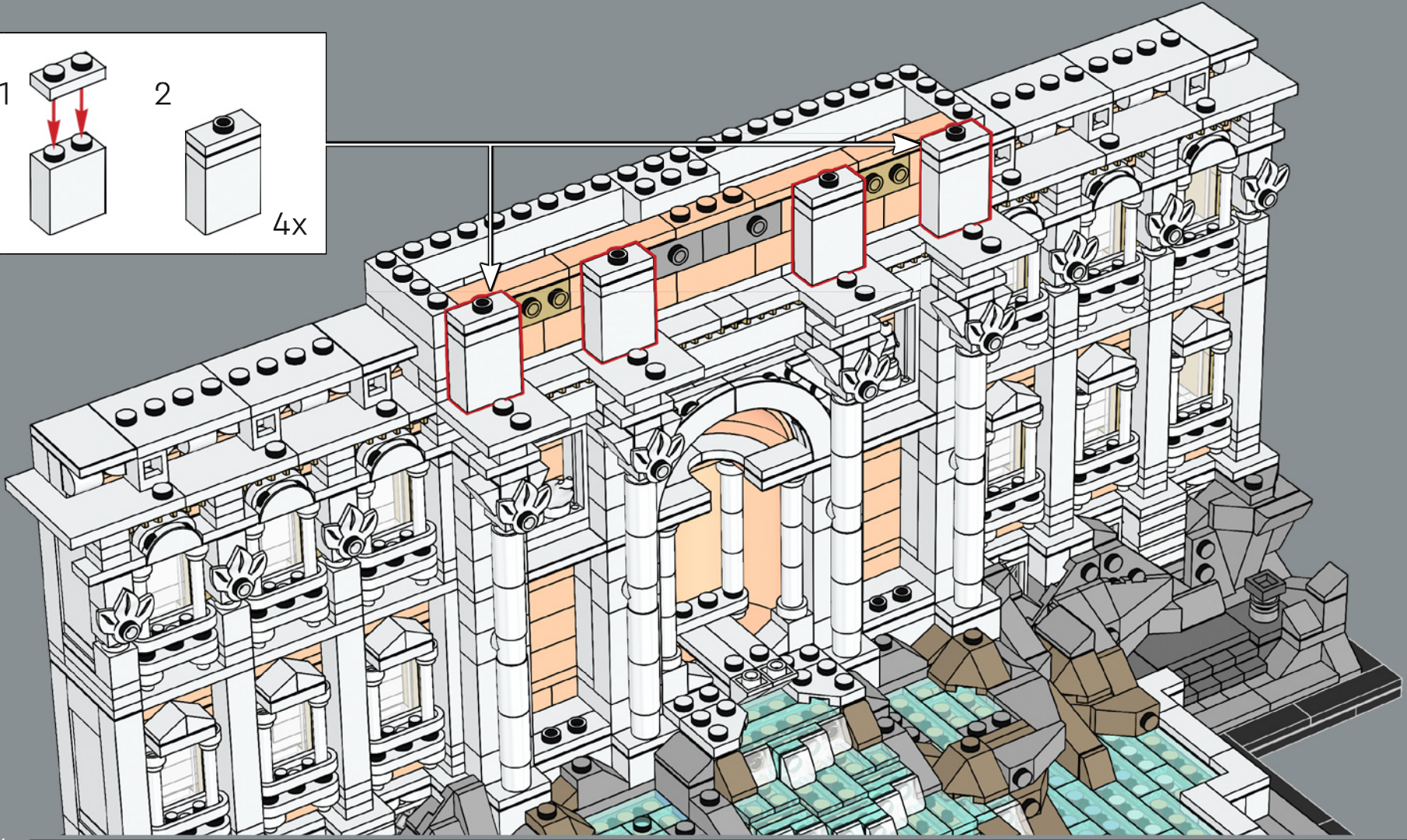
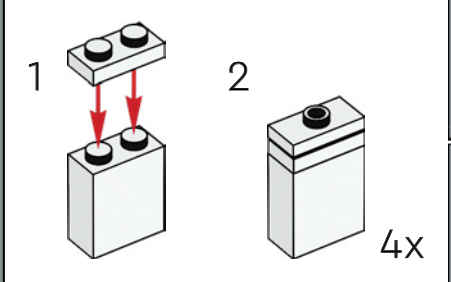

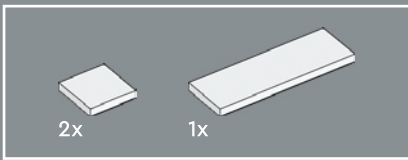

297

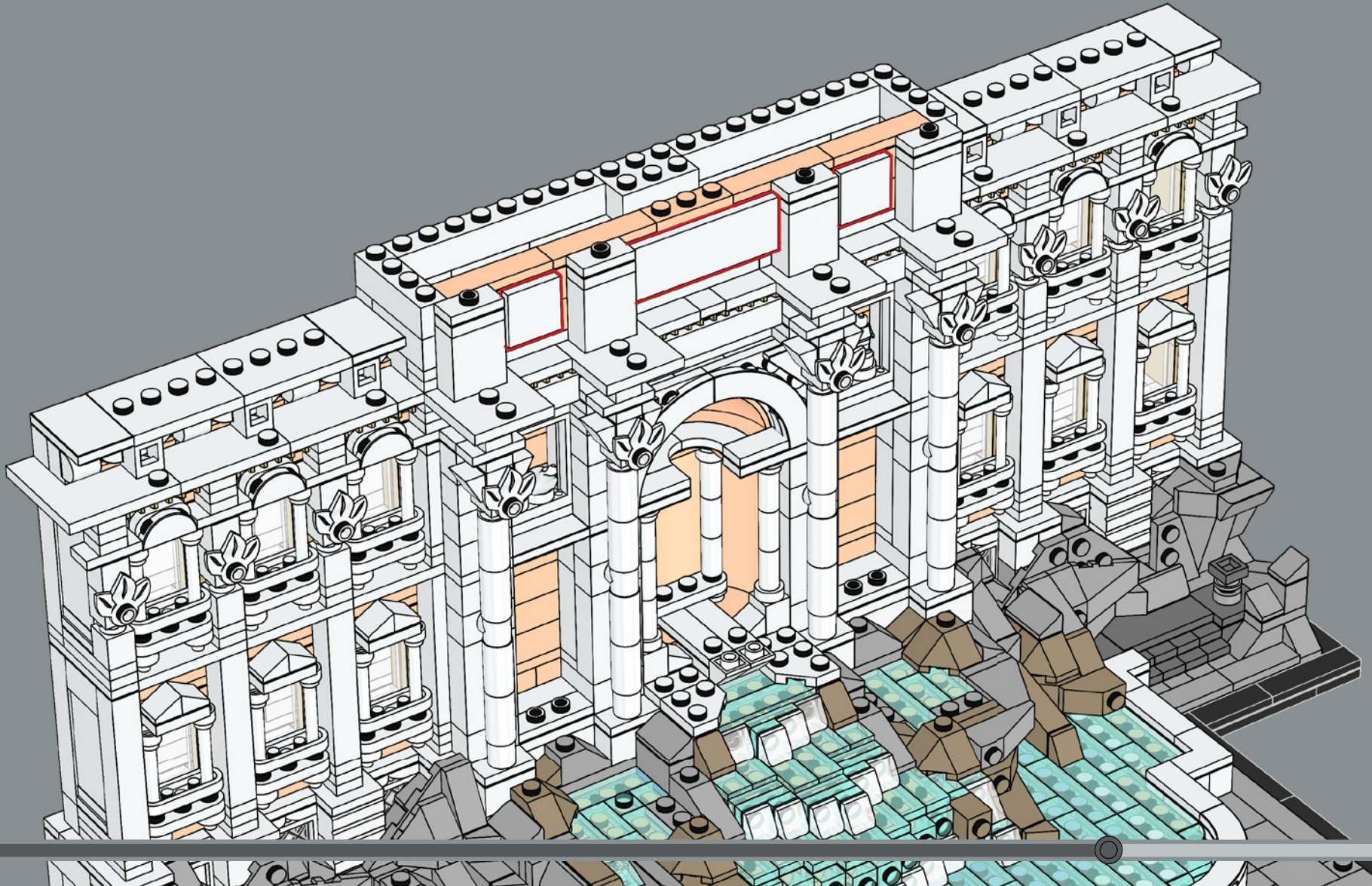

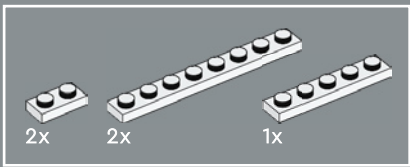

298

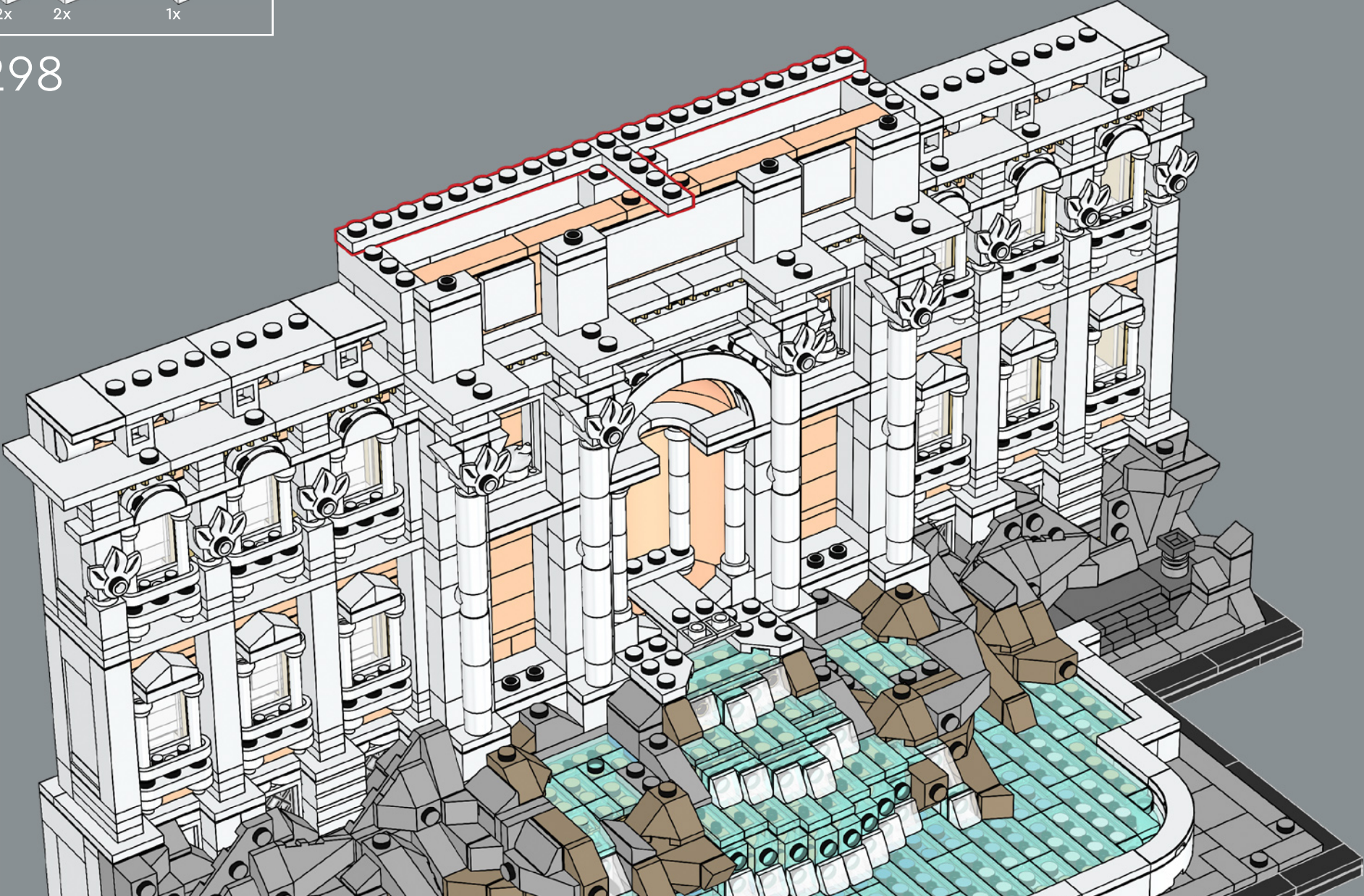

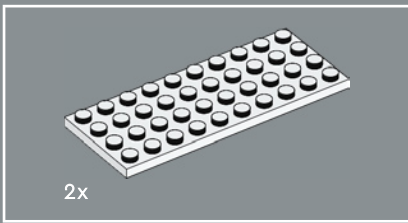

299

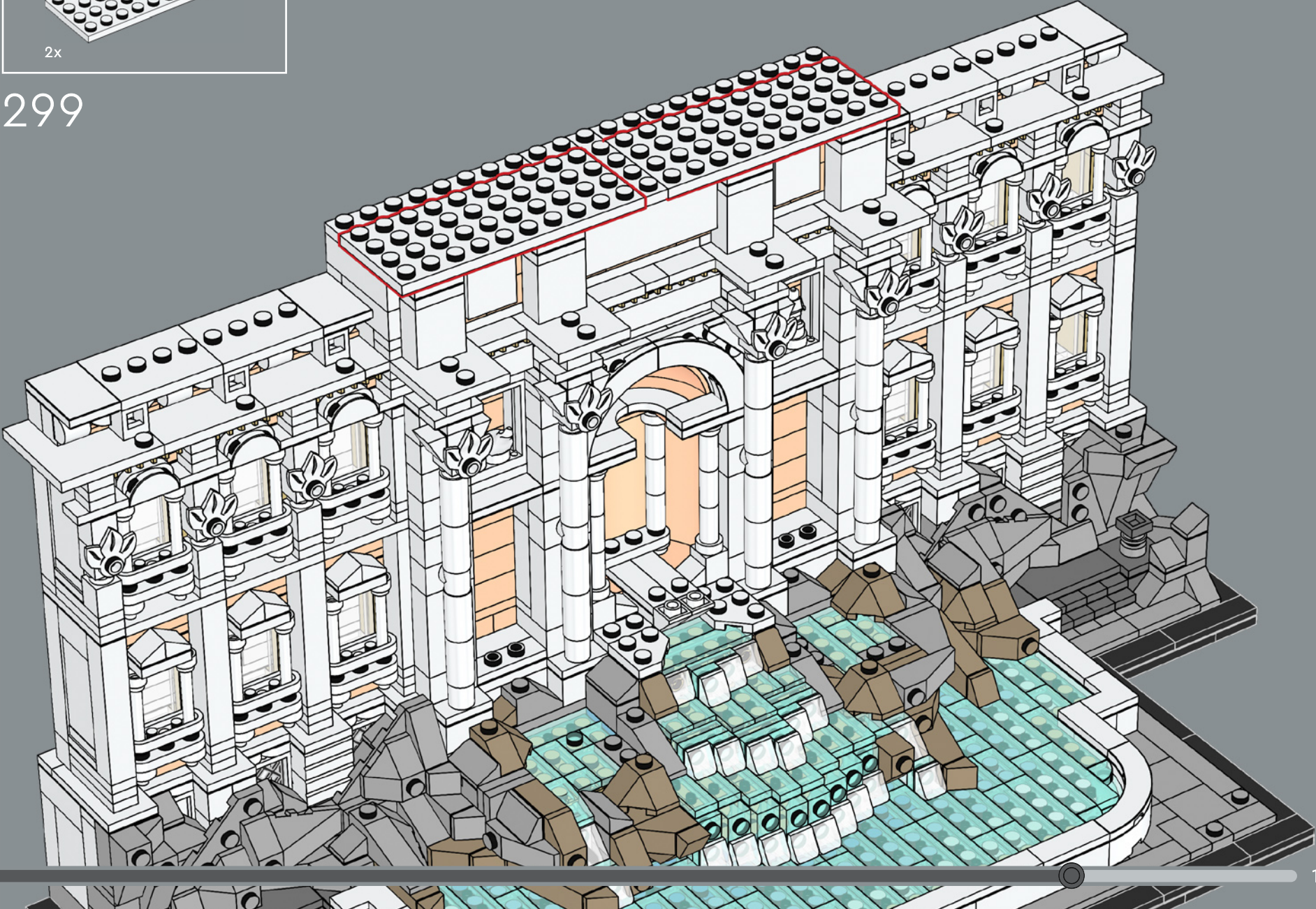

这些雕像代表四个季节：丰收的水果、肥沃的土地、  
秋天的礼物以及草地和花园的便利设施。

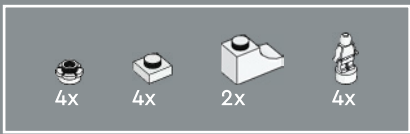

300

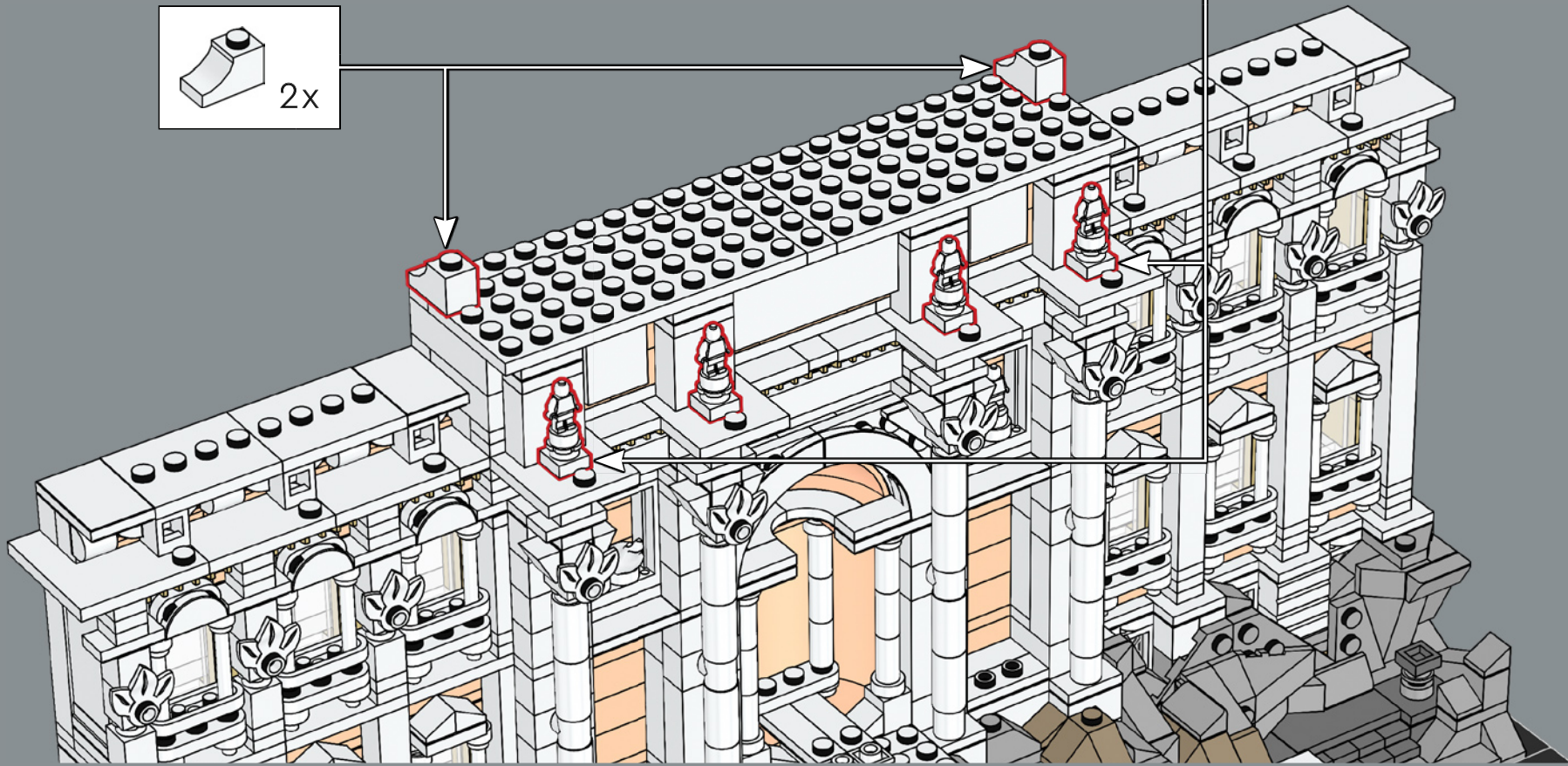
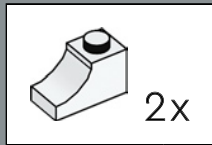
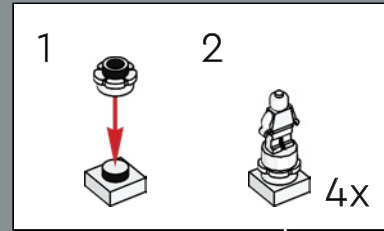

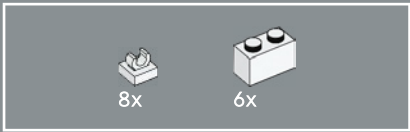

301

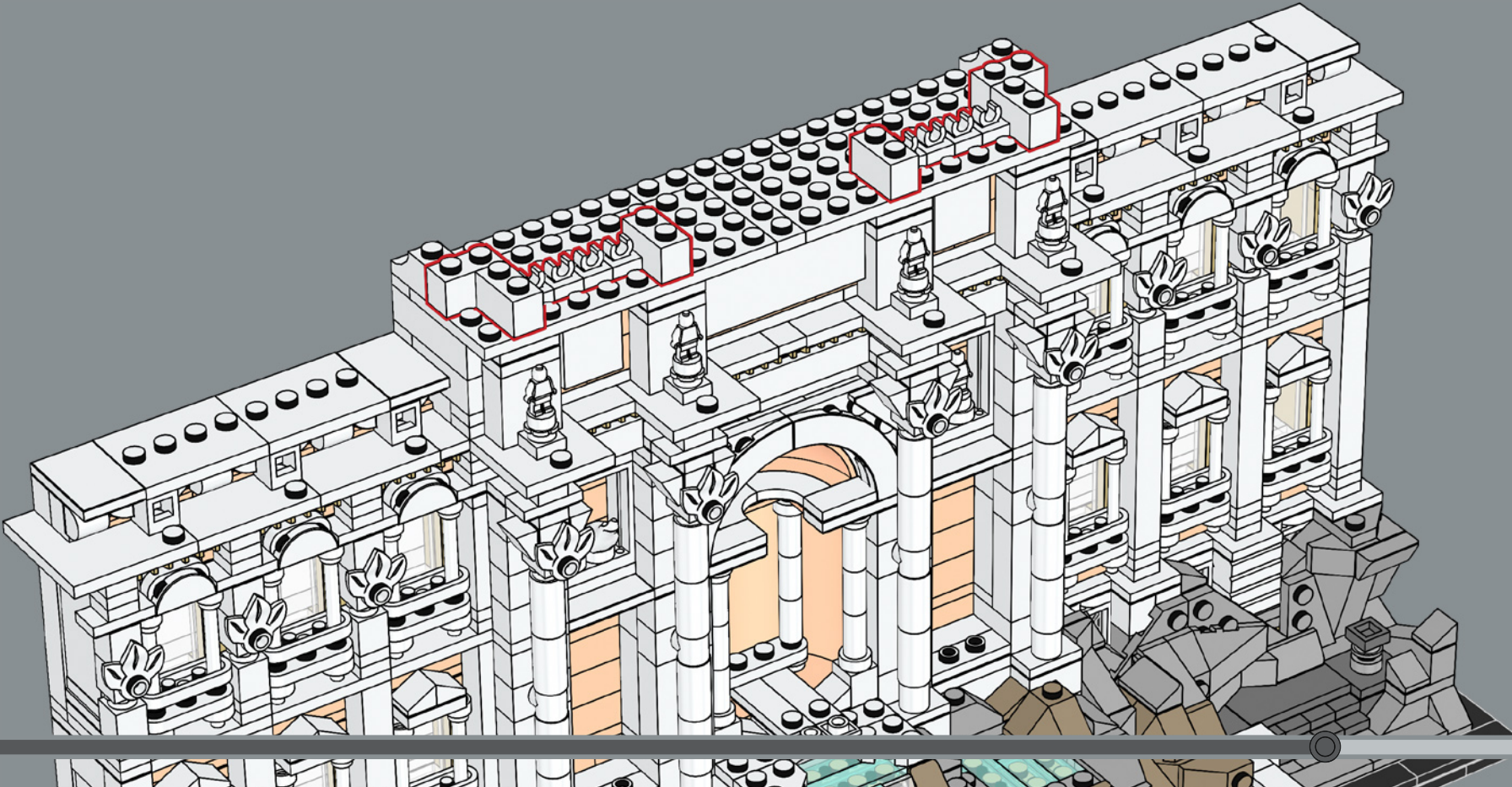

2x 1x 2x

302

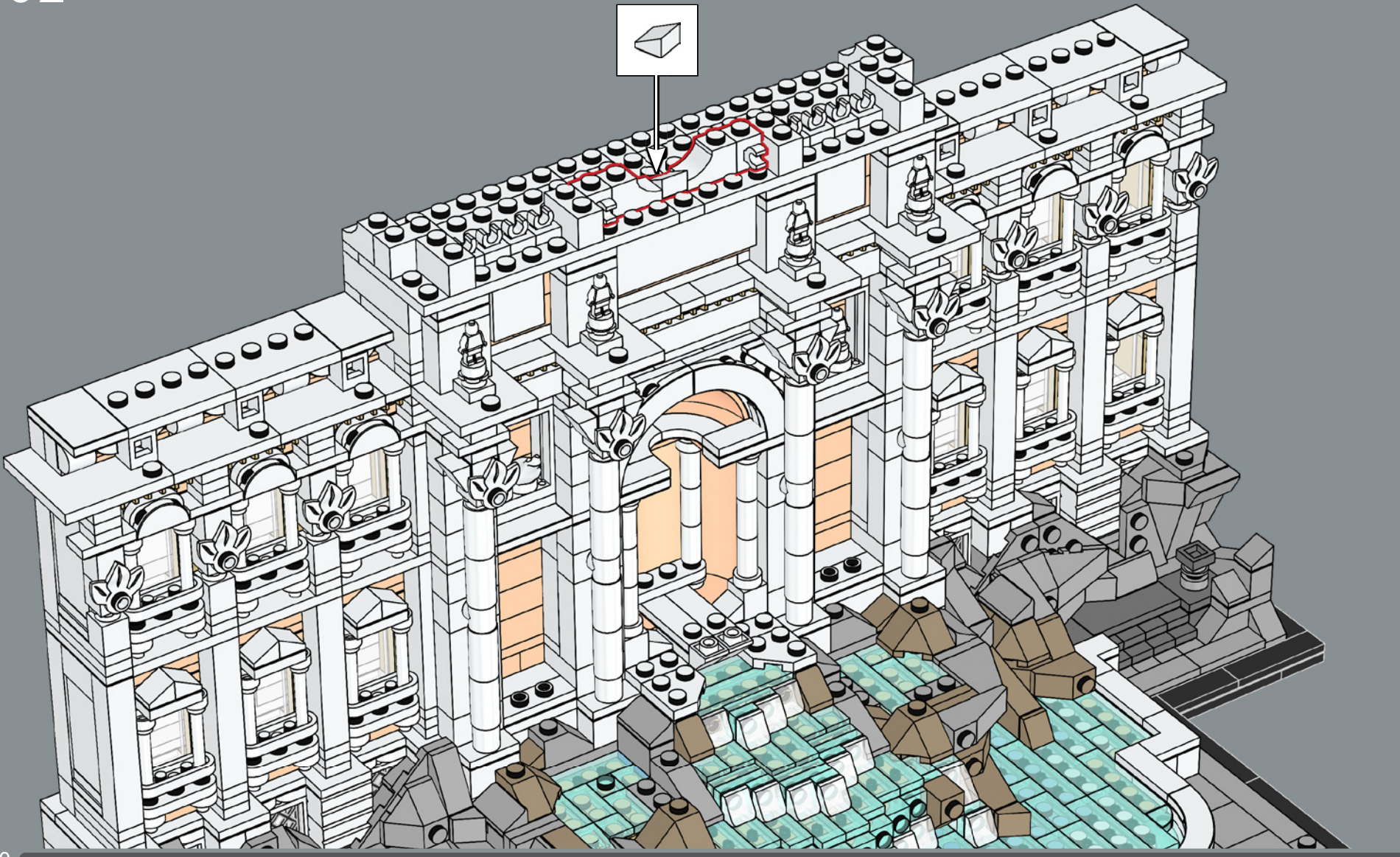



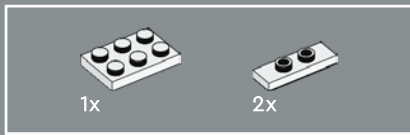

303

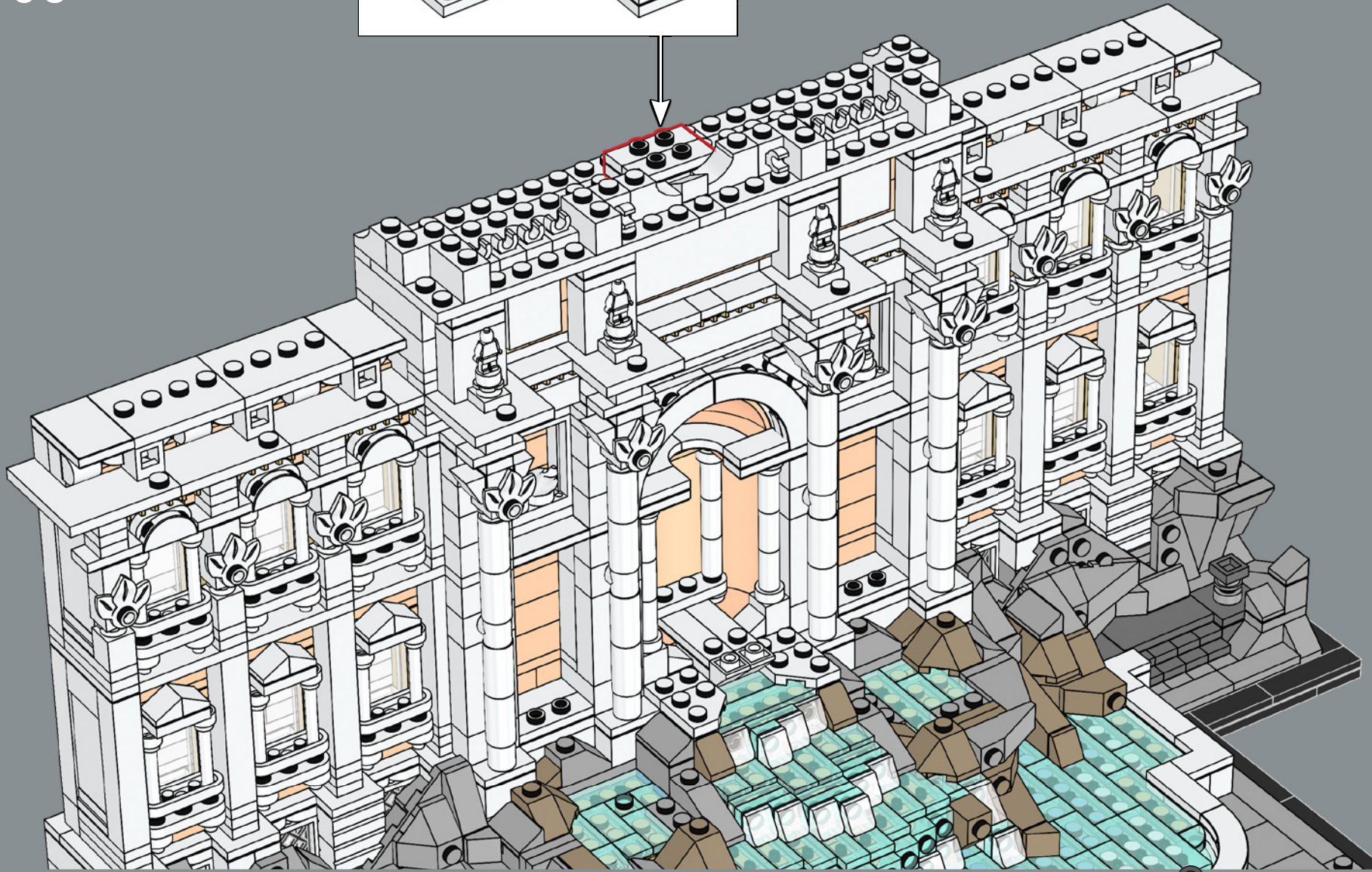
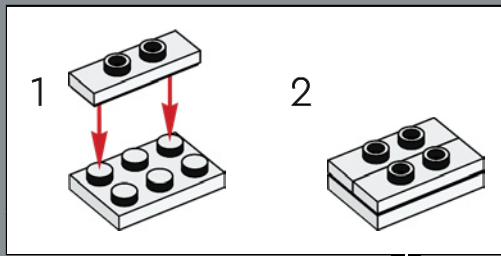

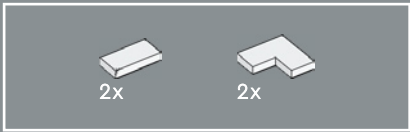

304

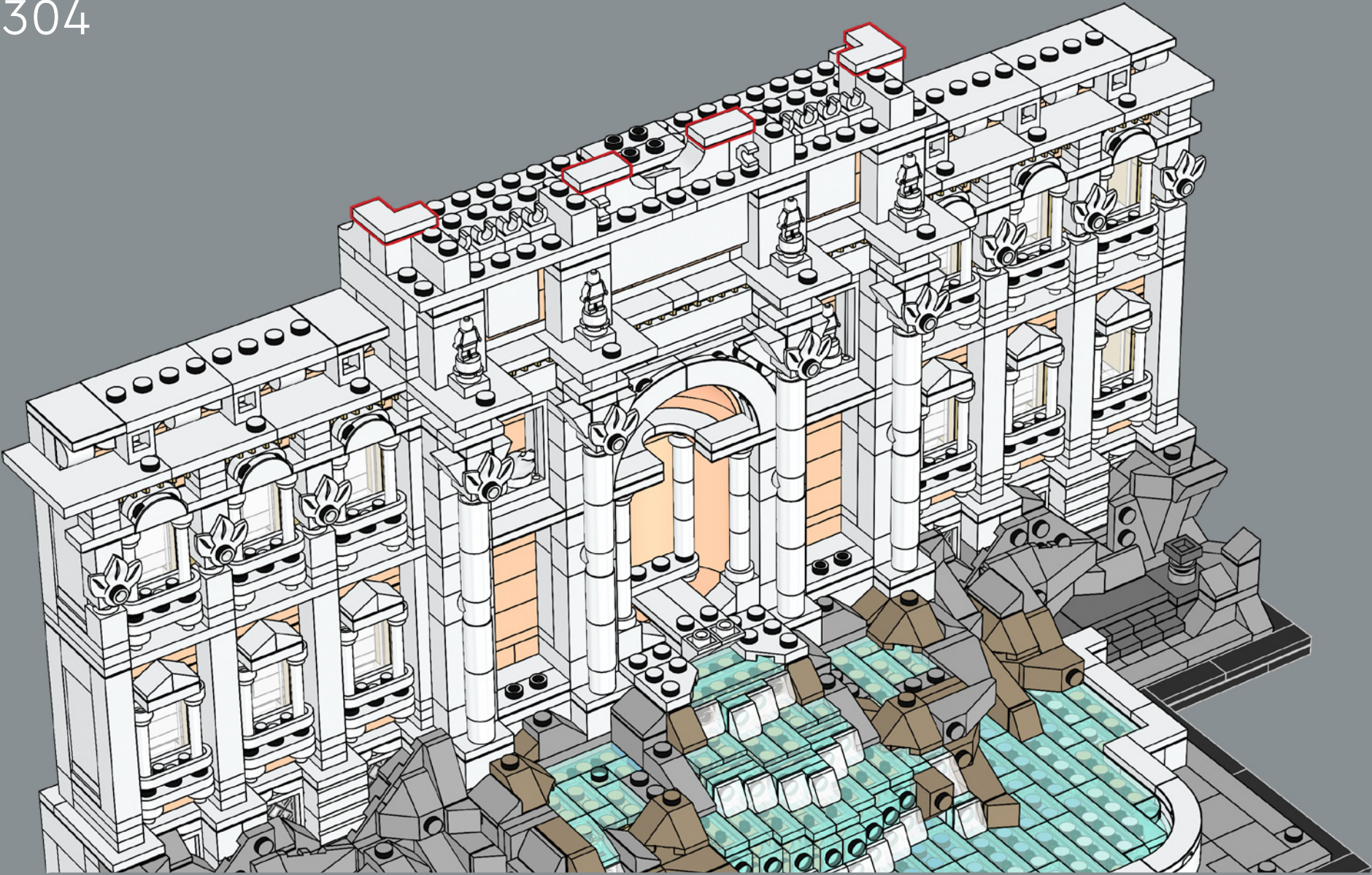

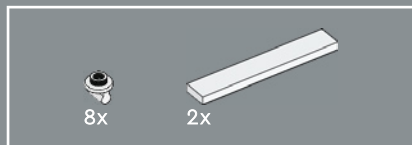

305

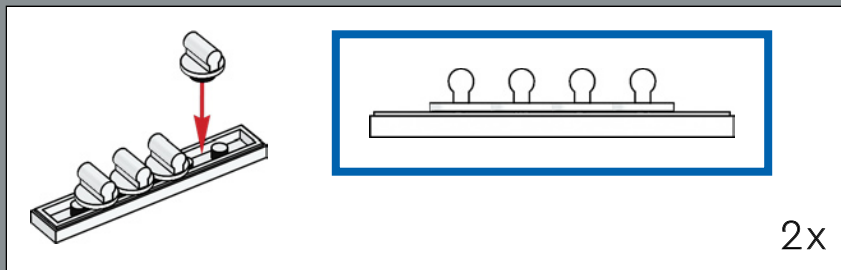

乐高®夹子和杆子组合在一起，  
在最高的栏杆上构成装饰柱。

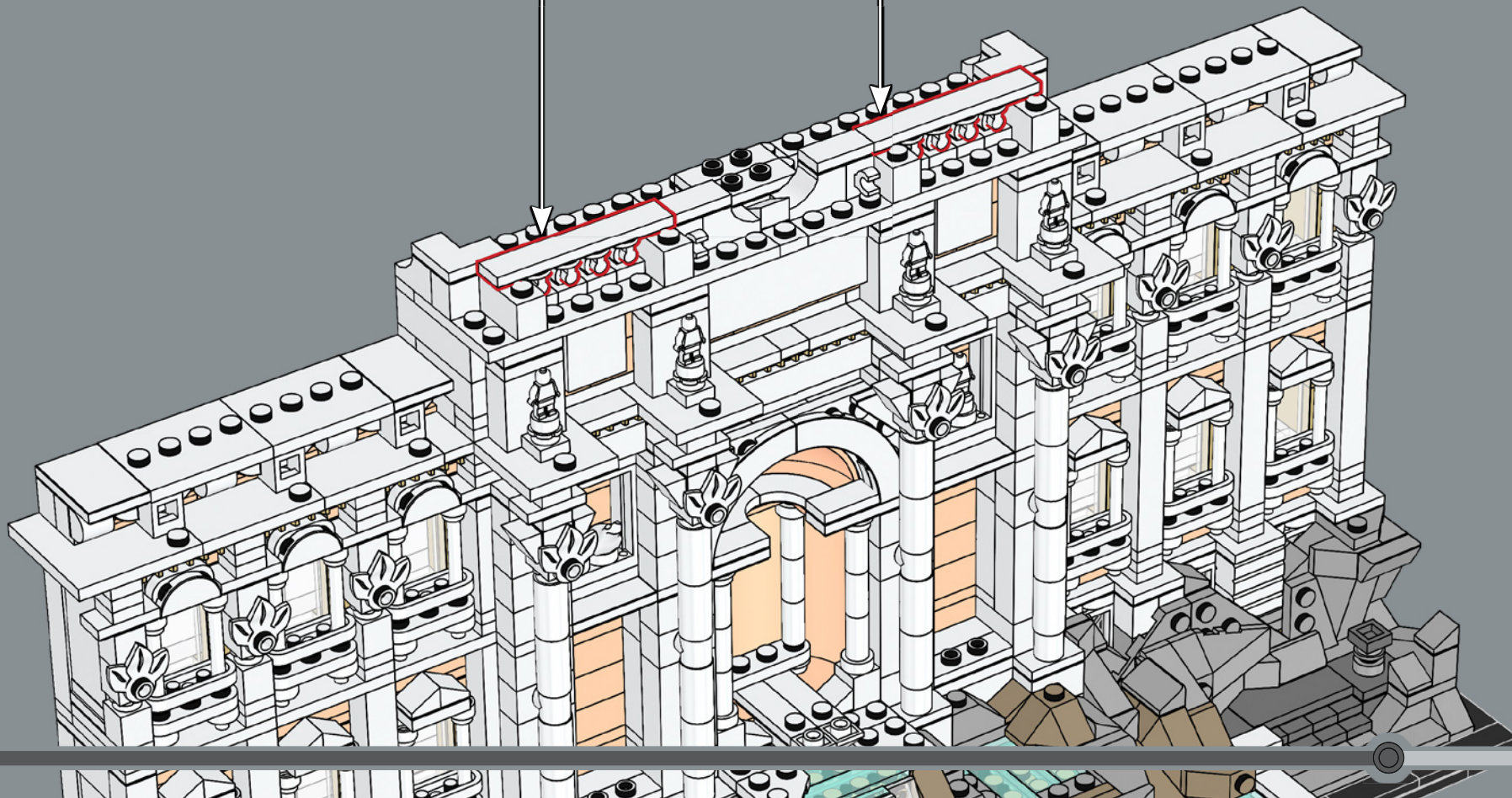

4x  2x 

306

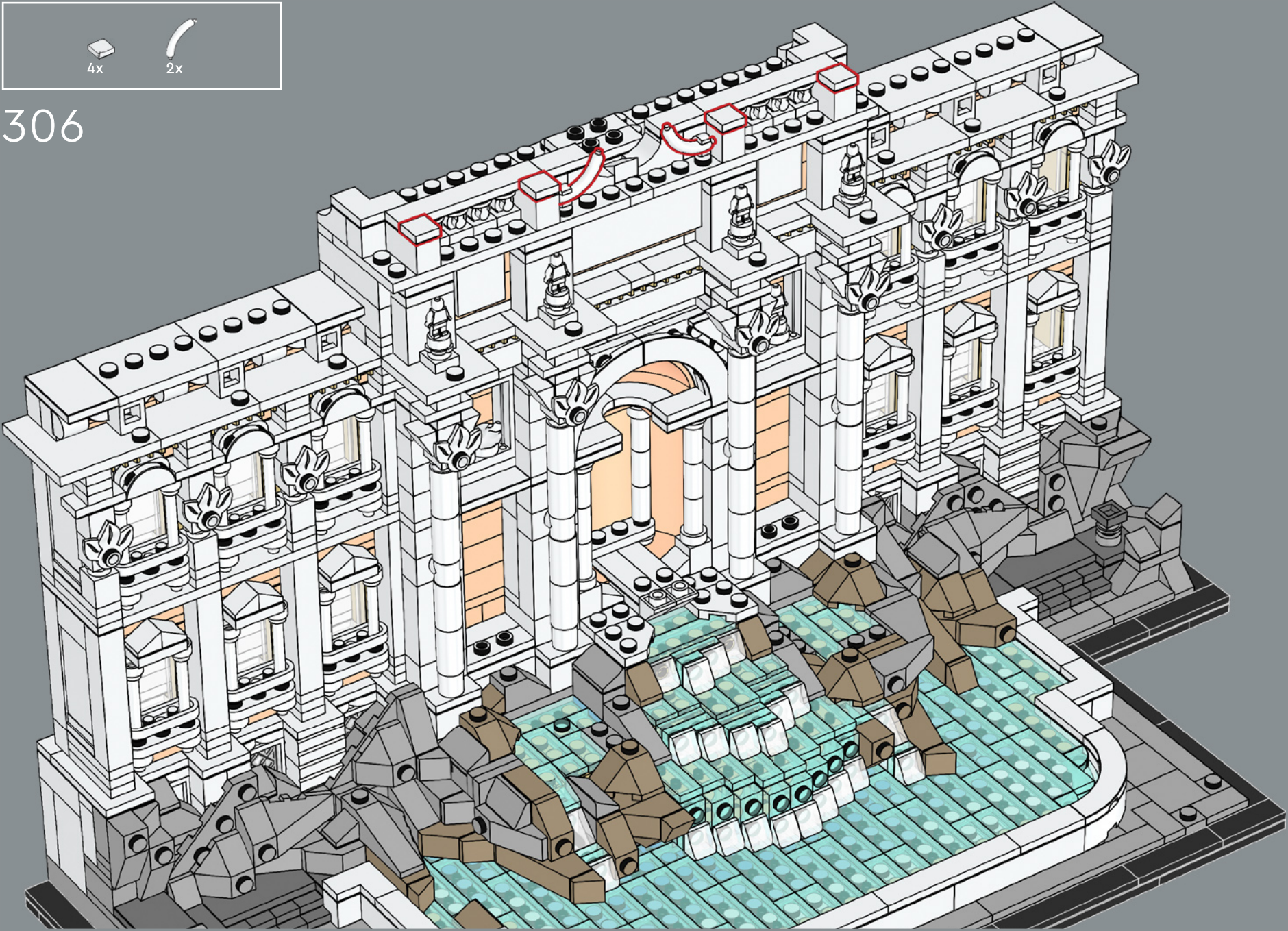

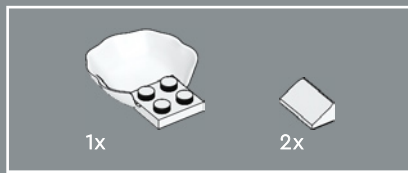

307



这是小人仔首次出现在乐高®建筑系列套装中。

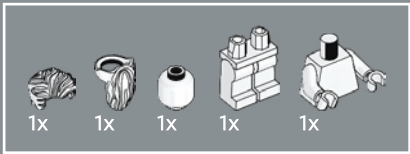

308

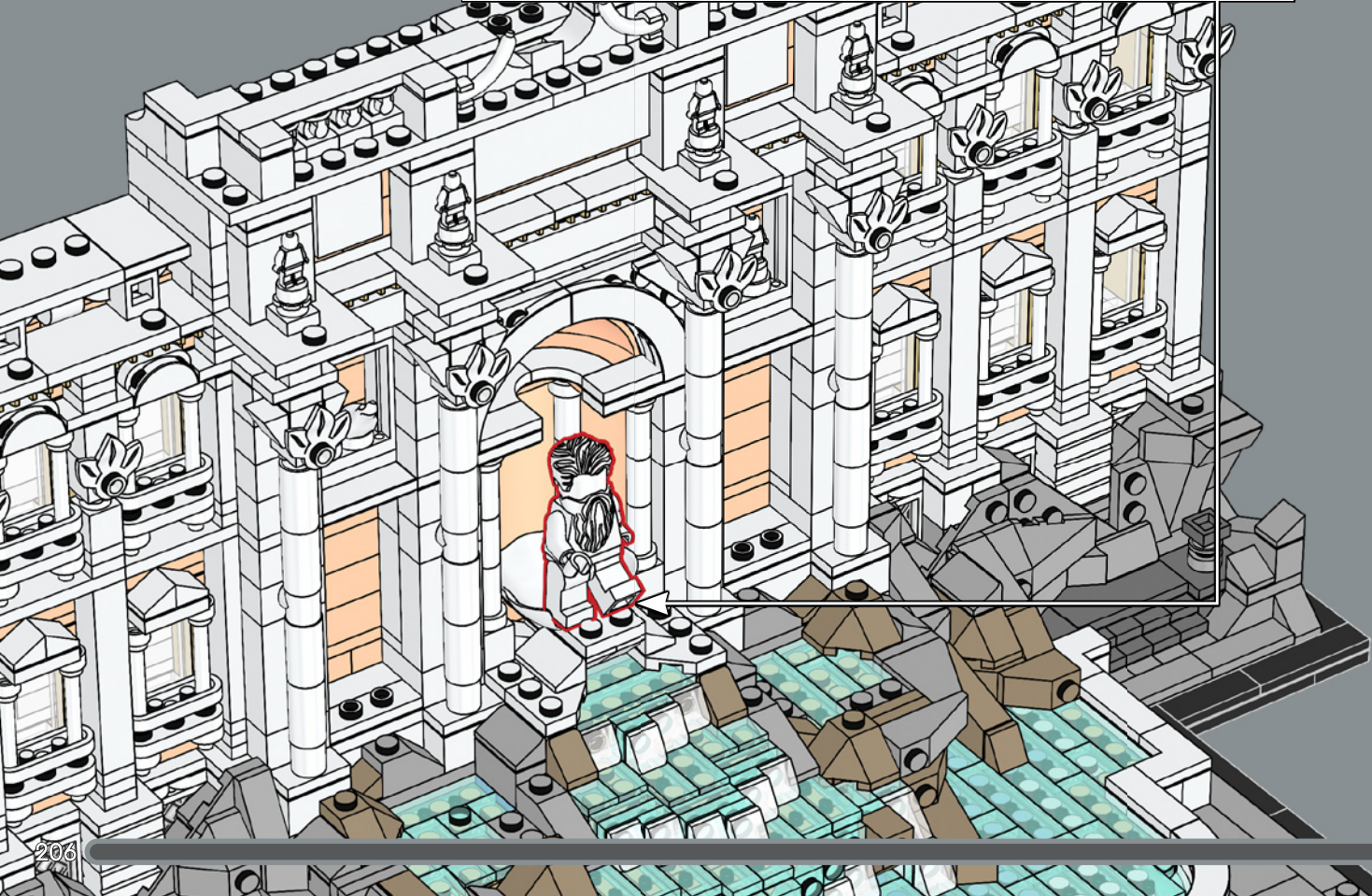
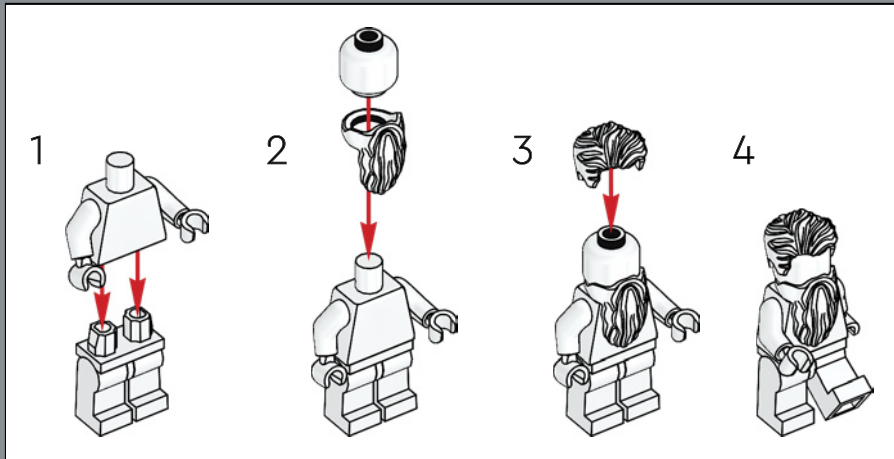

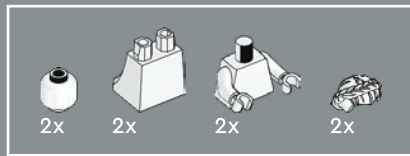

309

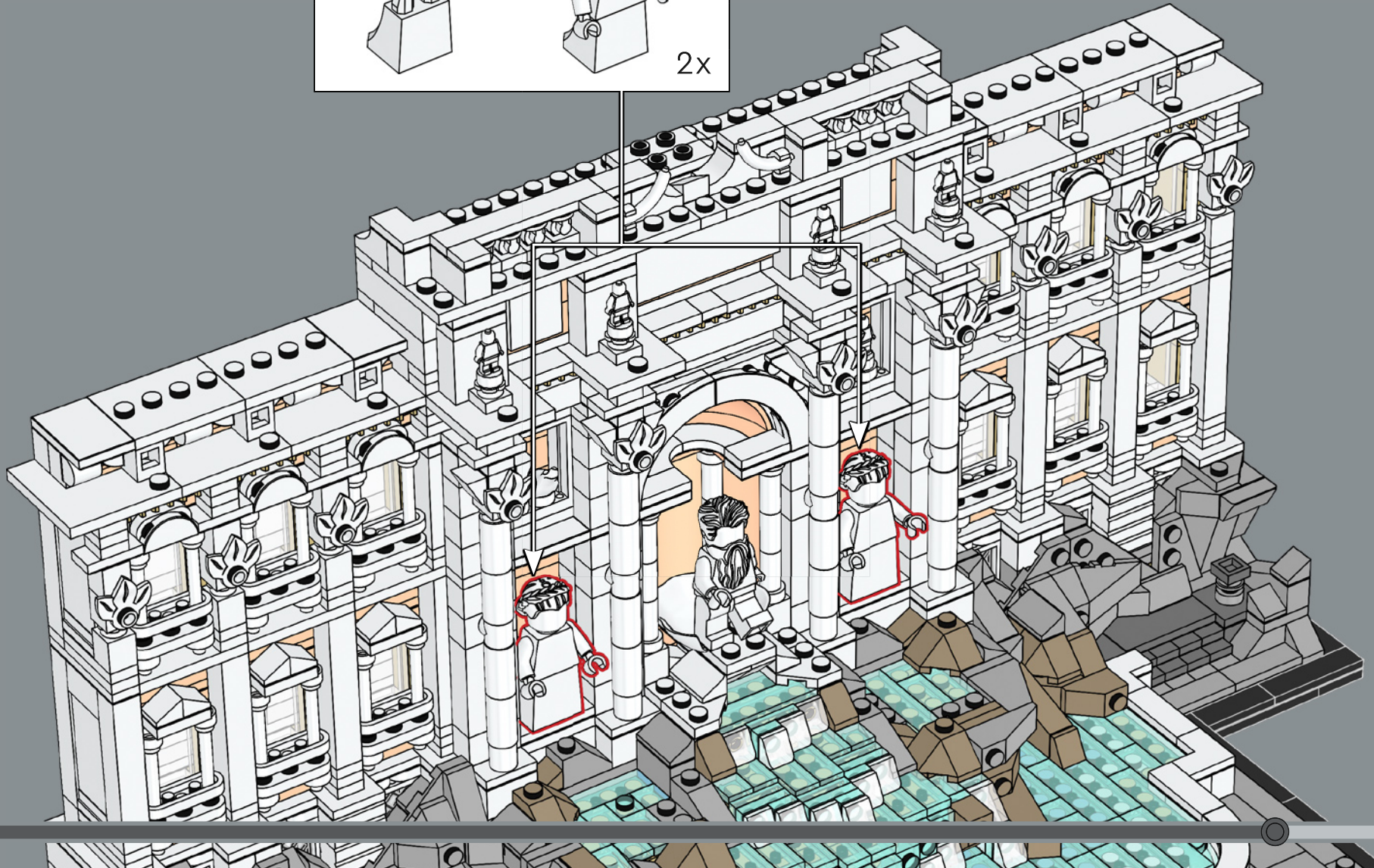
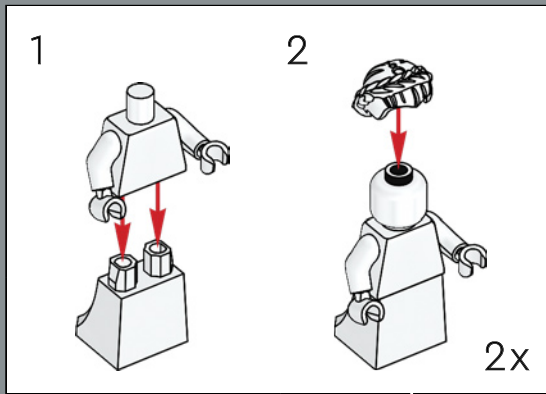

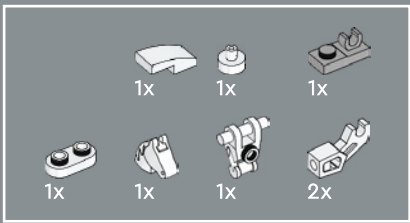

# 310

乐高®马头从乐高小人仔收藏系列中回归，为神话中的海马带来更多细节。

1



2

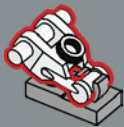

3

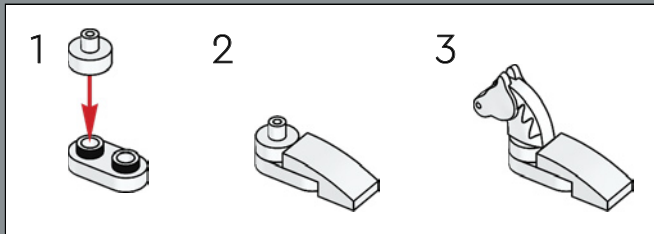
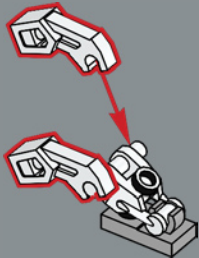

4

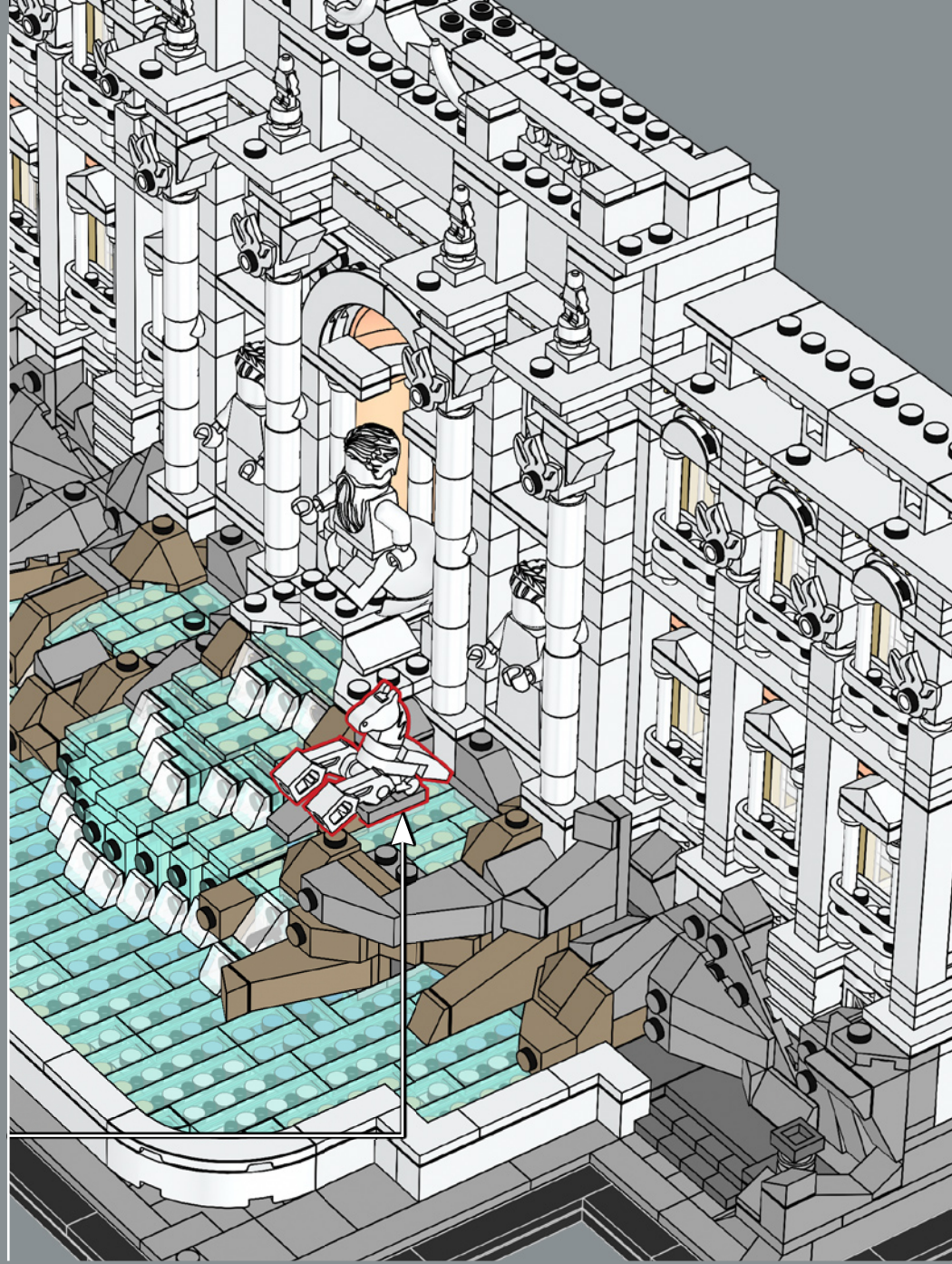
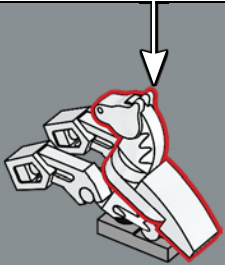





311

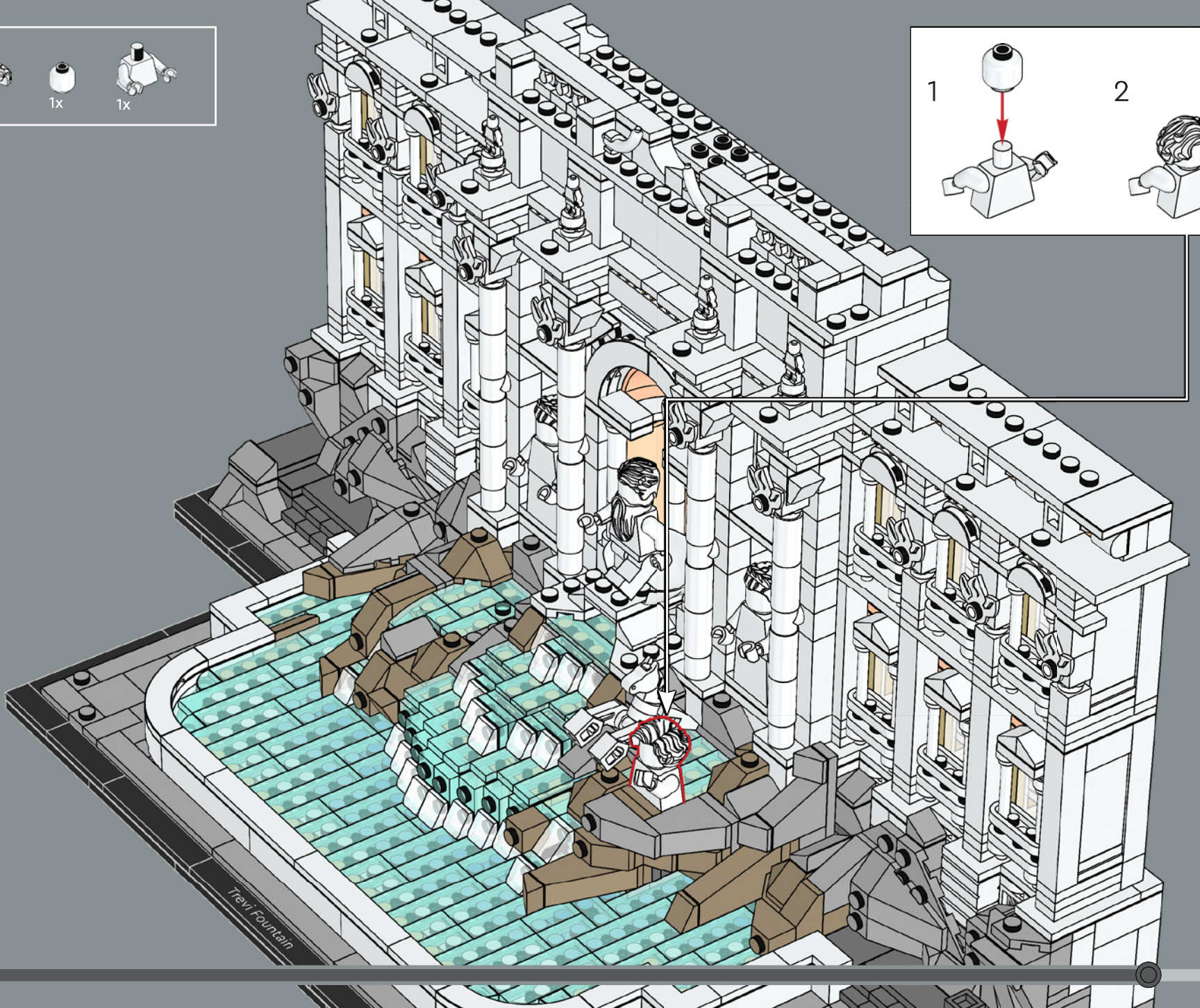
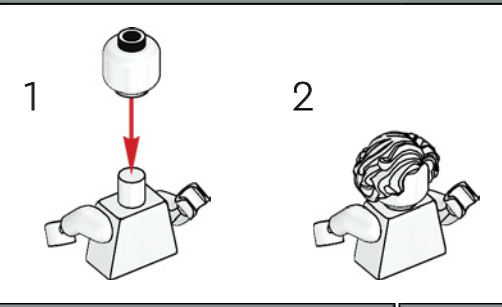



312

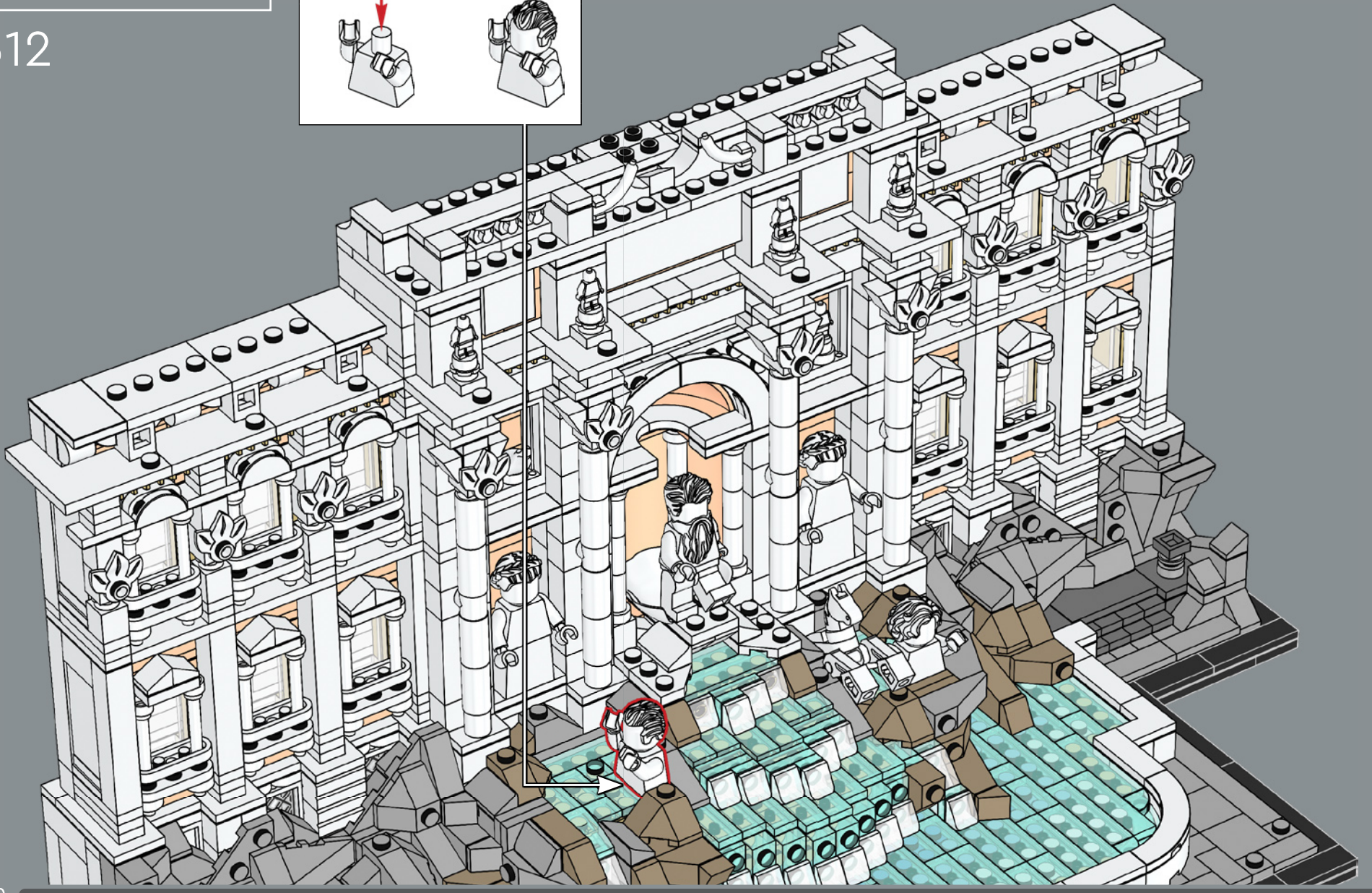
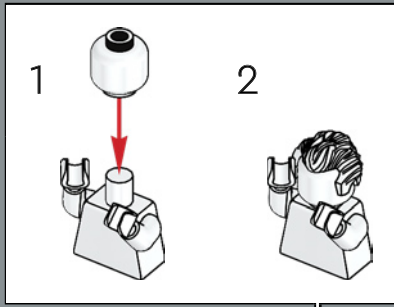

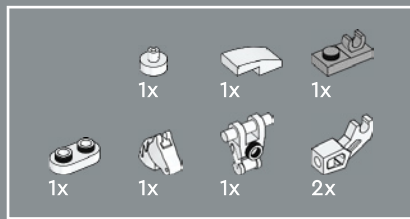

313

1



2

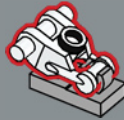

3

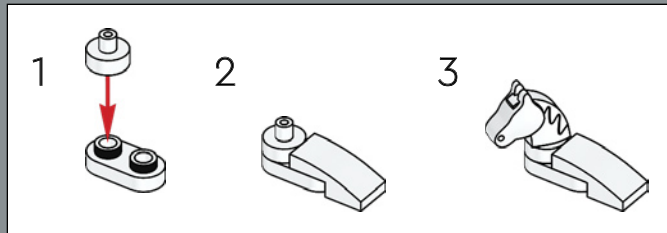
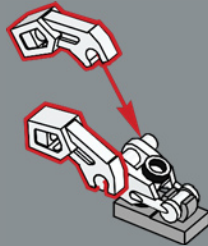

4

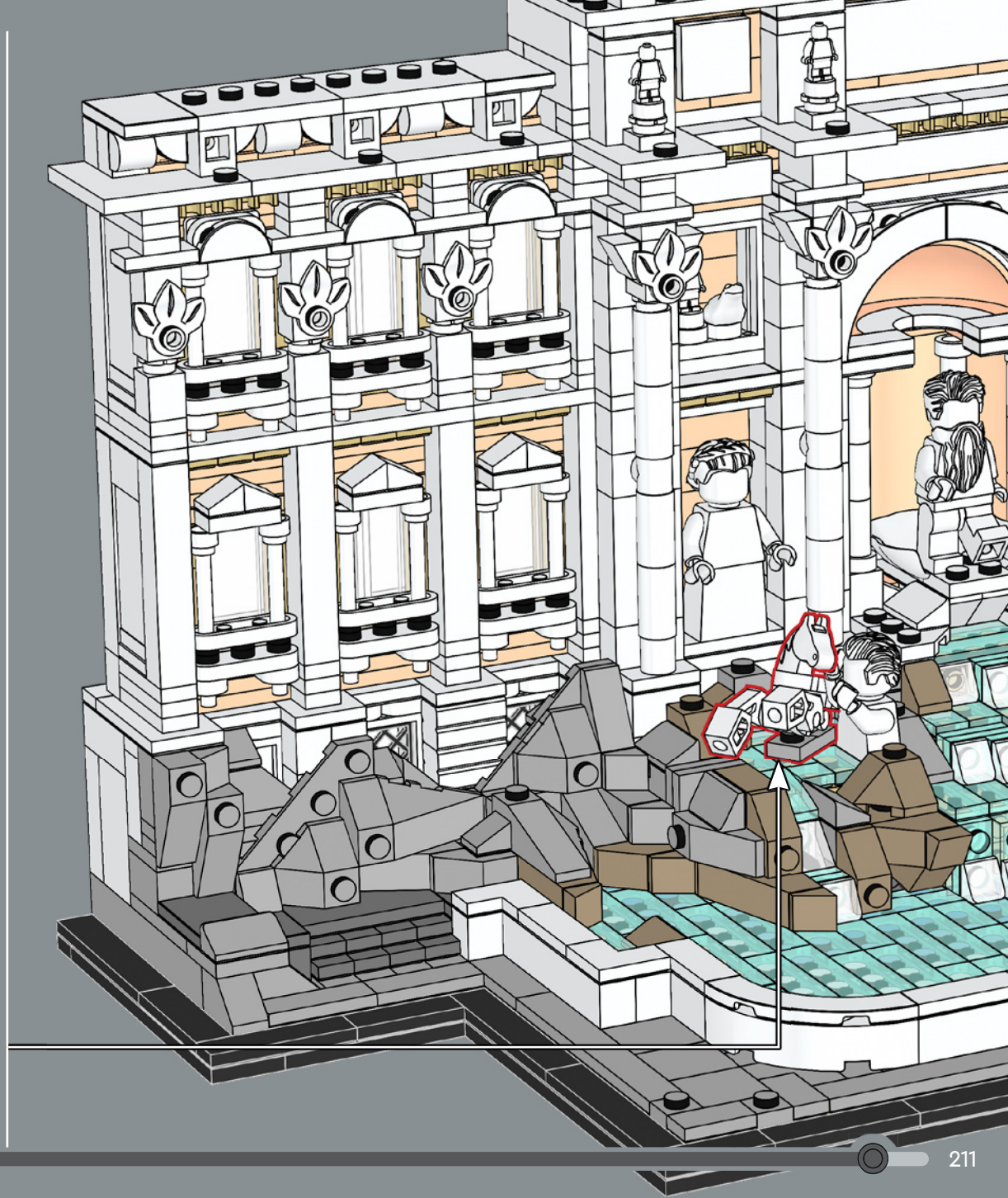
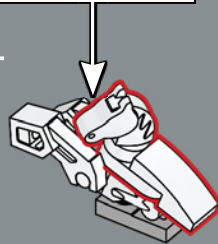

2x 2x

314

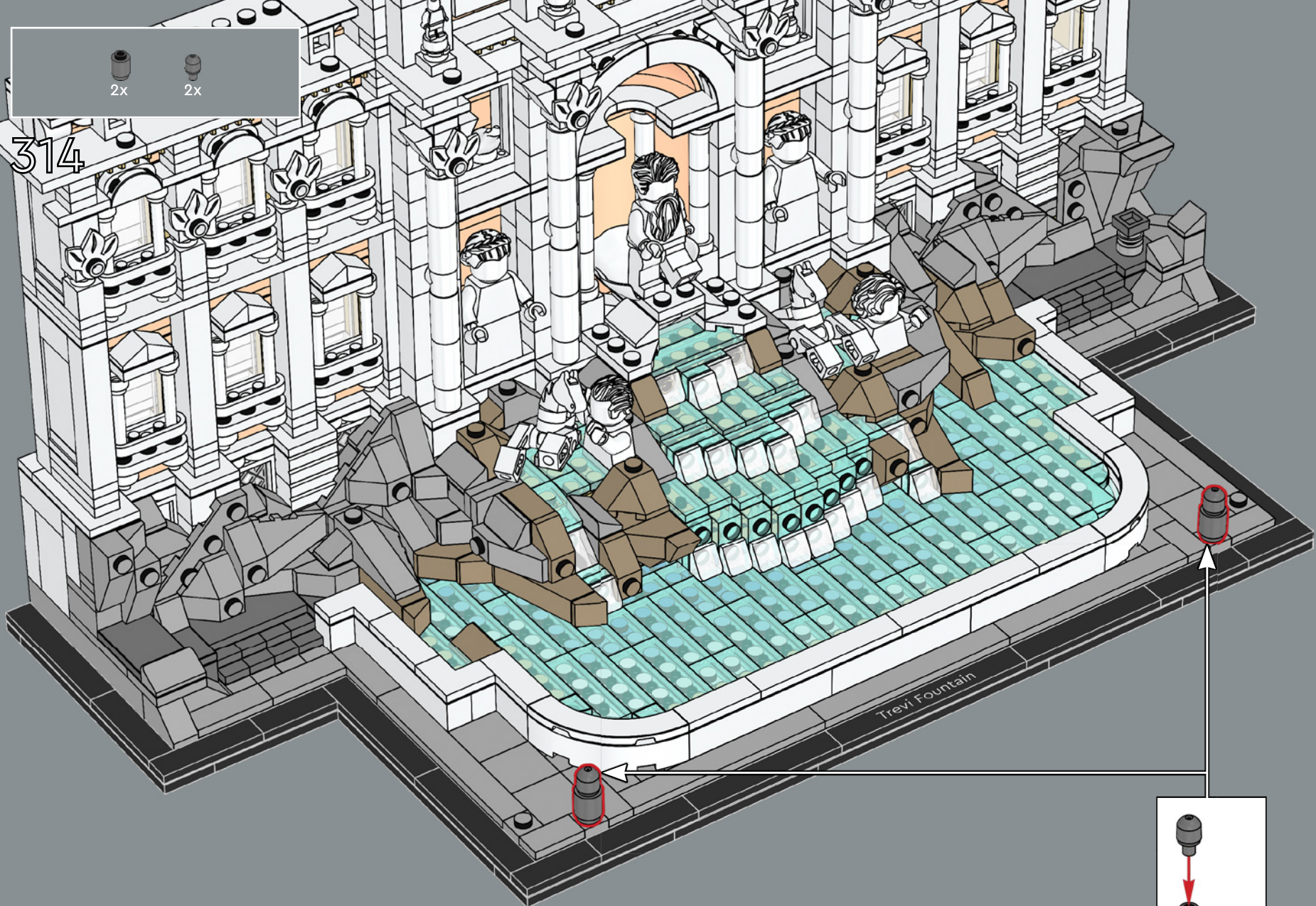

2x

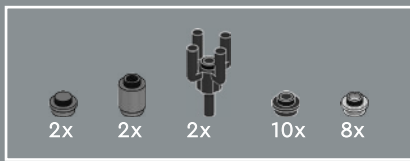

315

1

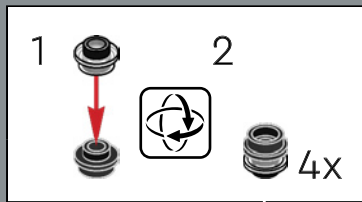

2

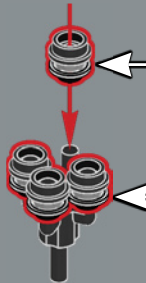

3

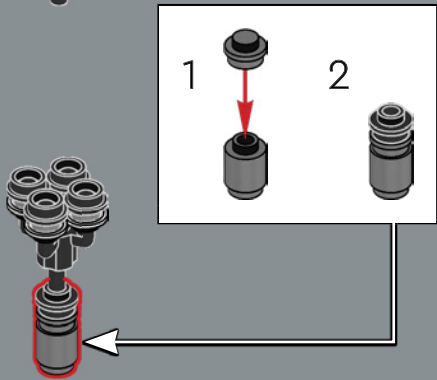

2x

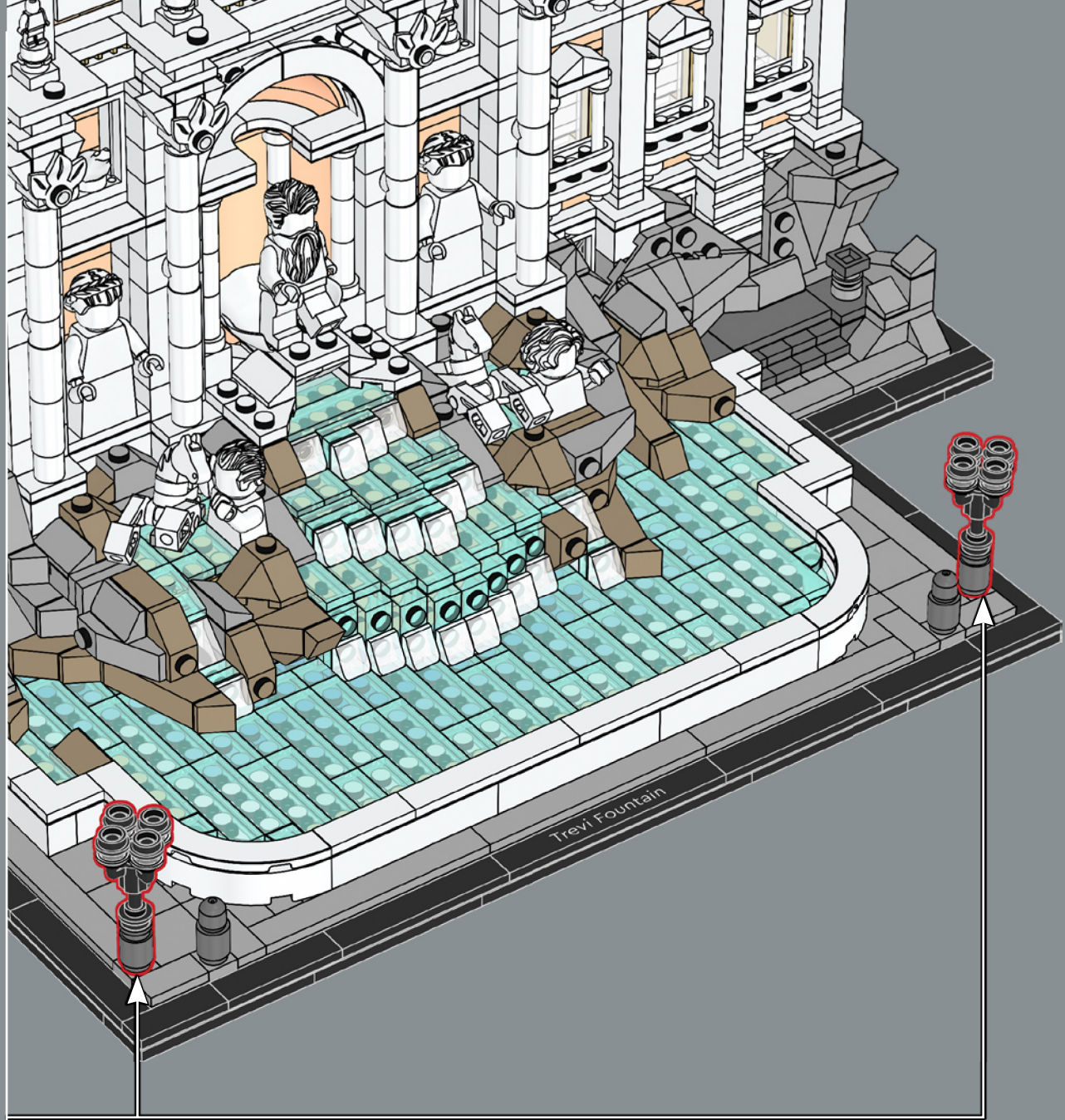

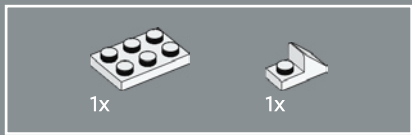

316

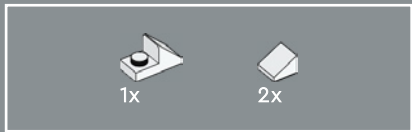
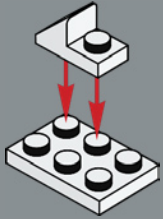

317

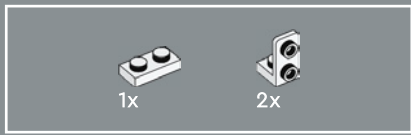
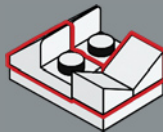

318

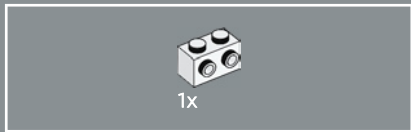
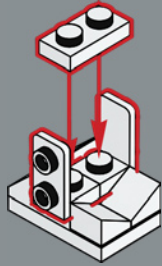

319

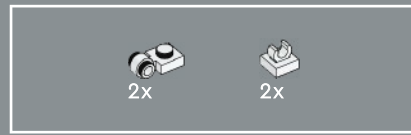
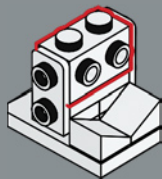

320

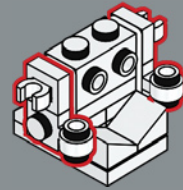

321

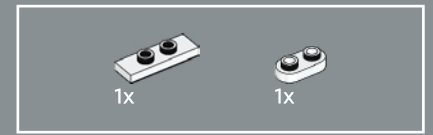
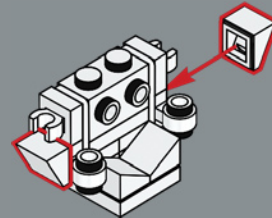

322

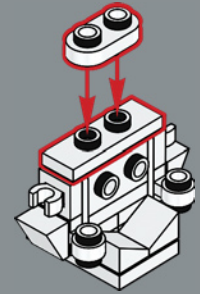

323

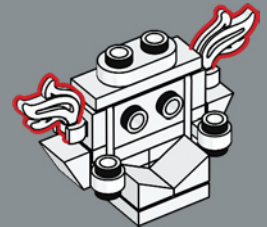



2x

324

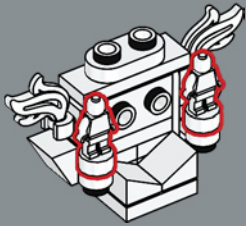

1x

325

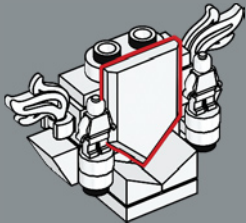

2x

326

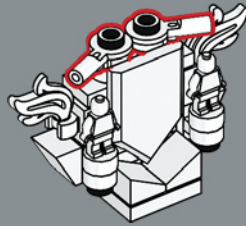

1x



1x

327

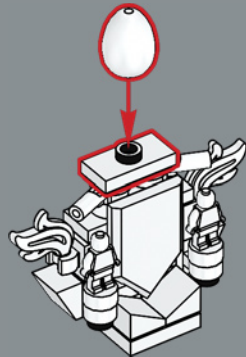

328

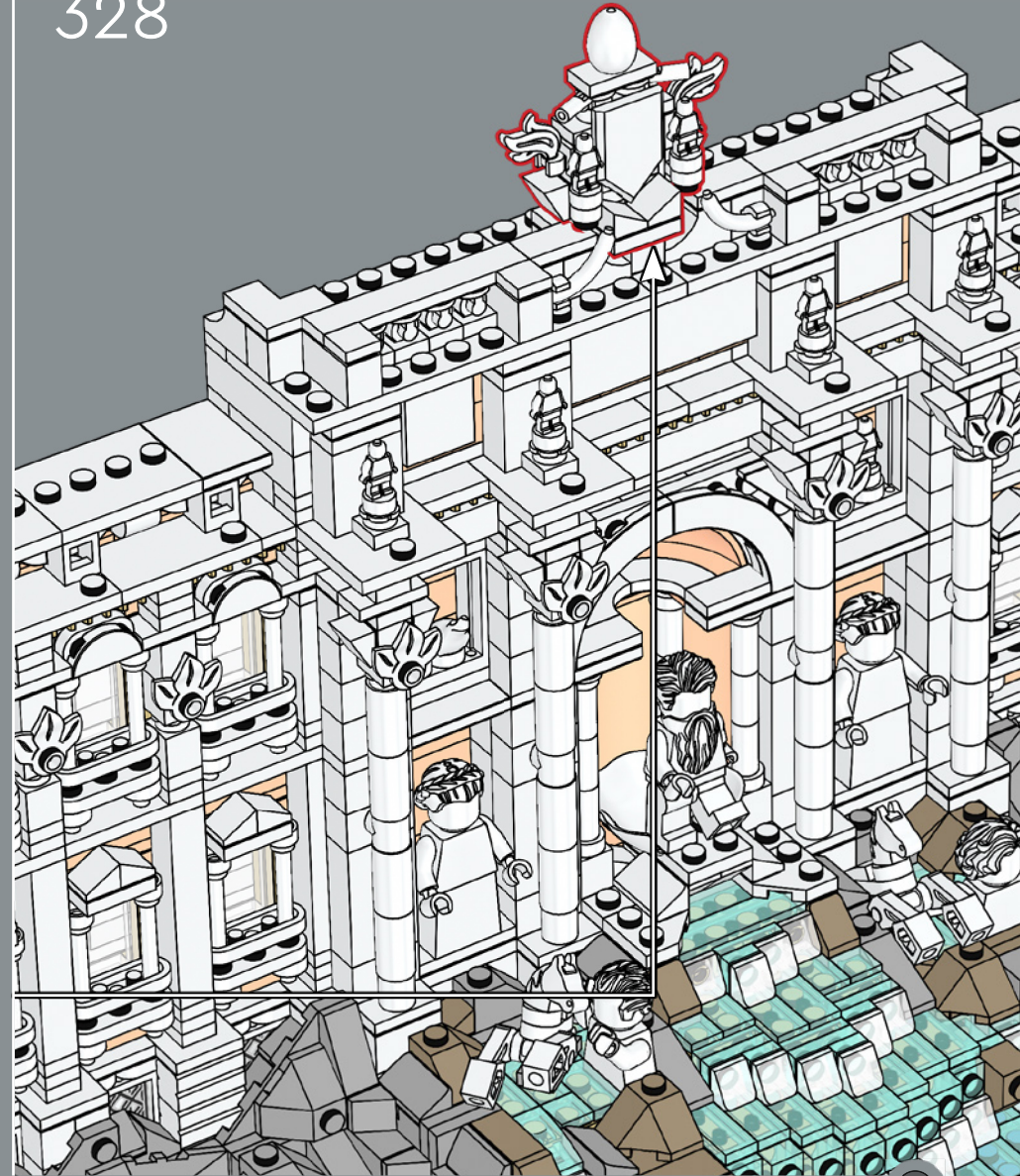

罗马许愿池由石灰华石砌成，许多经典电影都在此处取景，其中包括 Federico Fellini 执导的《甜蜜的生活 (La Dolce Vita)》(1960 年)。

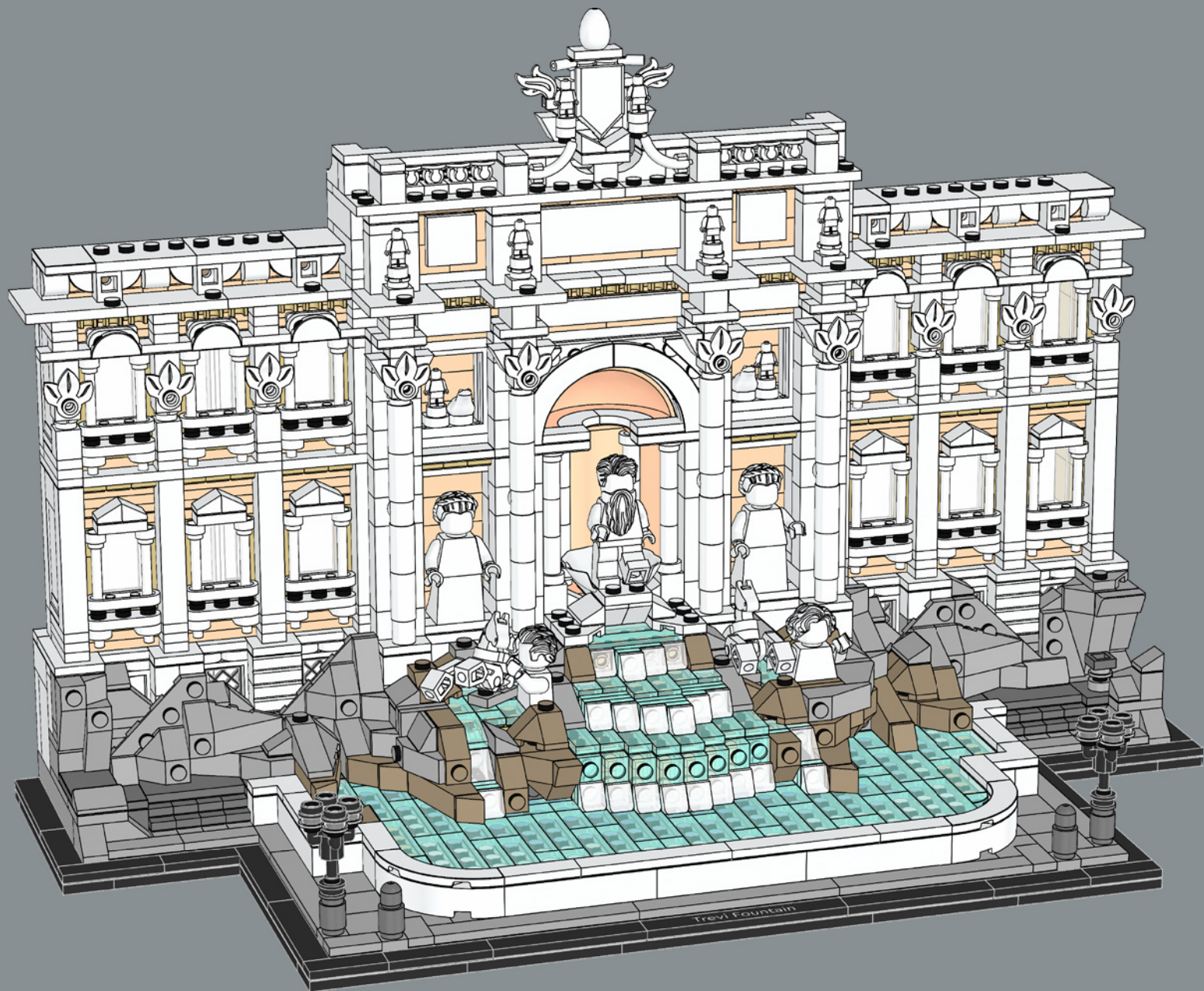



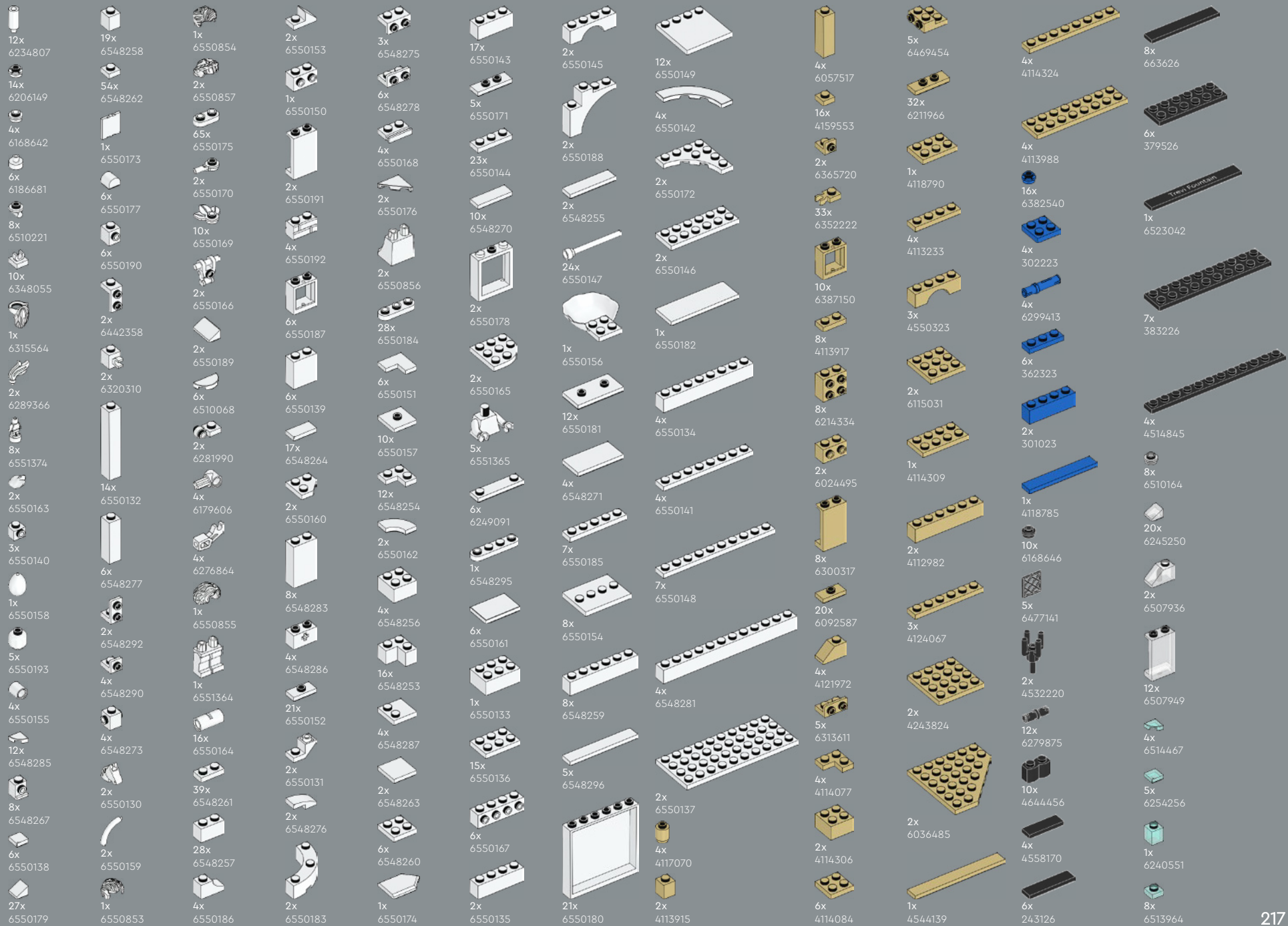

- 2x 6537848
- 14x 6514007
- 39x 6514224
- 6x 6514268
- 1x 6508249
- 54x 6510178
- 1x 6240515
- 10x 6322841
- 4x 6001824
- 9x 4530678
- 5x 4528604
- 4x 4653509
- 1x 6449563
- 1x 4521914
- 2x 6093064
- 1x 6228921
- 7x 6331865
- 2x 6035540
- 10x 6040126
- 1x 6015449
- 1x 6168647
- 1x 6258831
- 3x 4211389
- 19x 4521921
- 3x 6225242
- 6x 4211399
- 8x 4211415
- 4x 4558953
- 6x 6248890
- 1x 4211791
- 10x 4568637
- 1x 6213378
- 1x 6186657
- 3x 6123809
- 4x 4515374
- 11x 4211614
- 4x 6066097
- 9x 4211414
- 4x 4211388
- 1x 6093859
- 1x 4211564
- 5x 4211398
- 2x 6326078
- 2x 6383177
- 1x 6217876
- 1x 4211349
- 2x 6177078
- 6x 4211413
- 2x 6034676
- 8x 6212077
- 11x 4211353
- 2x 6469440
- 11x 4211488
- 6x 4558169
- 8x 6211969
- 4x 4211396
- 4x 4160560
- 7x 4211445
- 1x 4180418
- 3x 4180408
- 1x 6372029
- 1x 4211438
- 6x 4211452
- 2x 4211795
- 7x 4211425
- 2x 4211392
- 5x 4211481
- 1x 6313653
- 5x 4211404
- 1x 4210719
- 16x 6092572
- 4x 4210978
- 1x 6126083
- 2x 6309059
- 2x 4211133
- 1x 4211104
- 2x 6343852
- 8x 6187008
- 2x 4211105
- 4x 4211001
- 2x 4560184
- 3x 4620760
- 2x 4211002
- 2x 4211498
- 2x 4251149
- 5x 4617862
- 4x 4211408
- 2x 4211360
- 2x 4662161
- 1x 6528242
- 2x 6344216
- 4x 4211090
- 2x 4210633
- 4x 6395635
- 1x 6228923
- 4x 4558955
- 2x 4211107
- 2x 4211061
- 2x 4210678
- 4x 6000970
- 16x 6426347
- 4x 6357797
- 6x 6369189
- 16x 6329282
- 4x 6369188
- 21x 6357794
- 10x 6501239
- 4x 6440965
- 12x 6424071
- 1x 6541427
- 1x 6537849
- 12x 6537846
- 2x 6329604
- 4x 6439745
- 8x 6206809
- 4x 6144149
- 4x 4649741
- 2x 6070757
- 8x 4655256
- 2x 6146701
- 6x 6141592
- 2x 6138662



 [LEGO.com/service](https://www.LEGO.com/service)



# YOU COULD WIN



## YOU COULD WIN

Your feedback will help shape the future development of this product series.

Visit:

## DU KÖNNTEST GEWINNEN

Dein Feedback trägt zur Weiterentwicklung dieser Produktreihe bei.

Geh auf:

## VOUS POURRIEZ GAGNER

Vos commentaires nous aideront à concevoir les futurs produits de cette gamme.

Visitez :

## POTRESTI VINCERE TU

La tua opinione ci aiuterà a migliorare la creazione futura di questa linea di prodotti.

Visita:

## PUEDES GANAR

Tu opinión contribuirá al futuro de esta serie de productos.

Visita:

## 轻松获奖

您的反馈将有助于我们在今后改进本产品系列。

请访问:

---

**[LEGO.com/productfeedback](https://www.lego.com/productfeedback)**

---

You also have the chance to win a LEGO® set.

Terms and conditions apply.\*

Außerdem hast du die Chance, ein LEGO® Set zu gewinnen.

Es gelten die Teilnahmebedingungen.\*

Vous pourriez également gagner un ensemble LEGO®.

Des conditions s'appliquent.\*

Hai anche la possibilità di vincere un set LEGO®.

Termini e condizioni sono applicabili.\*

También tienes la oportunidad de ganar un set LEGO®.

Aplican términos y condiciones.\*

您还有机会赢取乐高®套装。

条款和条件适用。\*

\*[LEGO.com/productfeedback-terms](https://www.lego.com/productfeedback-terms)

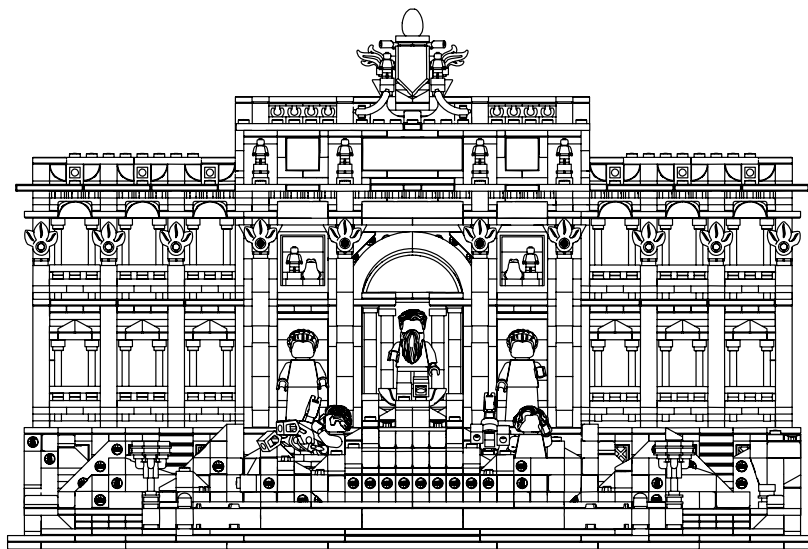

LEGO and the LEGO logo are trademarks of the LEGO Group. ©2025 The LEGO Group.  
Adam Reed Tucker is the co-developer of the LEGO® Architecture product line.