



21062





LEGO.com/sustainable-packaging



FR  
**DONNEZ**  
OU  
**RECYCLEZ**



OU



OU



ASSOCIATION    MAGASIN    DÉCHÈTERIE

Adresses sur [quefairedemesdechets.fr](http://quefairedemesdechets.fr)



# BUILDER



Apple and the Apple logo are trademarks of Apple Inc., registered in the U.S. and other countries and regions. App Store is a service mark of Apple Inc. Google Play and the Google Play logo are trademarks of Google LLC. Tencent and the Tencent logo are trademarks of Tencent Inc.

LEGO.com/devicecheck



LEGO® Builder



# QUANDO A ROMA / FONTANA DI TREVI

Dal suo completamento nel 1762, e attraverso i secoli, la Fontana di Trevi nella sua forma attuale ha generosamente offerto al pubblico di tutto il mondo il suo ricco patrimonio storico e architettonico. Il sito della fontana svolge da tempo un ruolo significativo nella crescita e nella prosperità della città di Roma. Dal 19 a.C., la sua acqua sorgiva naturale scorre attraverso uno dei più antichi acquedotti romani, l'Acqua Vergine.

Un'opera d'arte barocca mozzafiato, la fontana è il simbolo dell'intraprendenza romana con una ricchezza di sculture e tributi simbolici ad antiche divinità, leggende e visionari romani e all'abbondanza del mondo naturale. Il suo nome, che deriva da *tre vie*, sottolinea la sua posizione strategica all'incrocio di tre antiche strade, che un tempo erano percorse da pellegrini e cittadini e ora da circa 10 milioni di visitatori all'anno.

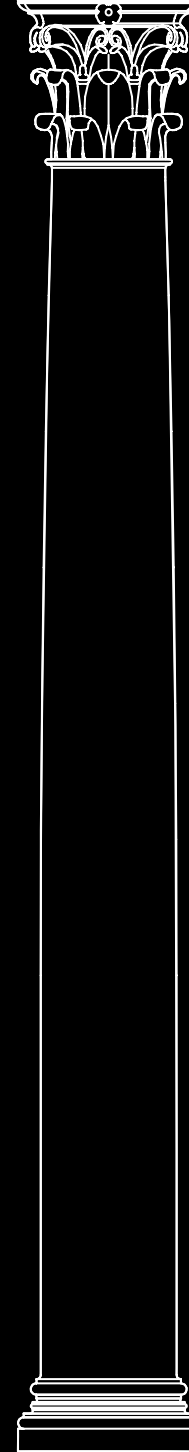

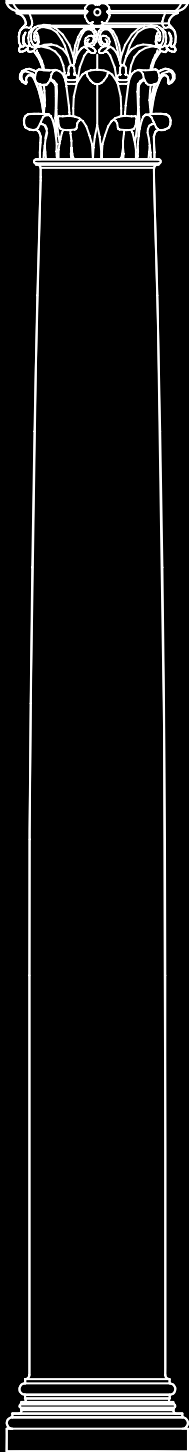

# IL LEGO<sup>®</sup> ARCHITECTURE DESIGN TEAM

Più che un gioiello visivo, come icona culturale la Fontana di Trevi ha ispirato innumerevoli opere d'arte, letteratura e persino film. Seguendo il popolare set Fontana di Trevi LEGO<sup>®</sup> Architecture (21020) del 2014, questa versione rivisita il sito su una scala più grande con una nuova interpretazione del vero monumento con alcuni dettagli astratti.

L'obiettivo principale era catturare l'ambiente e l'atmosfera barocca di Roma in una giornata estiva, con gli edifici dai colori vivaci che circondano la Fontana di Trevi che riflettono una luce calda sulla piazza. Le profondità all'interno della facciata proiettano ombre su se stesse e sulla vasca, creando sottili variazioni nei colori della superficie. Utilizzando tonalità di rosa, marrone chiaro, grigio e bianco, volevamo catturare l'essenza di queste intricate sfumature nell'edificio, nelle statue, nell'acqua e nelle rocce.



**Mary Wilson**  
LEGO® Architecture Designer



## PALAZZO POLI

Lo stemma di papa Clemente XII, committente della Fontana di Trevi, è affiancato da quattro statue rappresentanti frutti e messi fecondati dall'acqua.



## OCEANO (NETTUNO)

Il dio dei mari, a cavallo di un carro a forma di conchiglia trainato da mitici cavalli marini, simboleggia l'abilità ingegneristica romana nel controllo dell'acqua attraverso gli acquedotti.



## AGRIPPA

*Il generale e architetto romano Marco Vipsanio Agrippa (63-12 a.C.) viene ritratto mentre approva i piani per la costruzione dell'acquedotto originale.*



## LA VERGINE

*Un omaggio alla fanciulla che, secondo il mito, millenni fa indicò la sorgente ai soldati romani.*



## SALUBRITÀ (SALUS)

*La dea della salute tiene una coppa per permettere a un serpente di bere, simboleggiando la purezza e i poteri curativi dell'acqua.*



## ABBONDANZA

*La dea dell'abbondanza versa l'acqua da una grande urna, che simboleggia il flusso dell'acqua proveniente dagli acquedotti e la fertilità che apporta alla terra.*



## TRITONI

*Mitiche creature marine metà uomo metà pesce. Il primo lotta per controllare un agitatissimo cavallo marino (la natura turbolenta del mare), il secondo guida un cavallo più calmo (le acque sotto il controllo romano).*



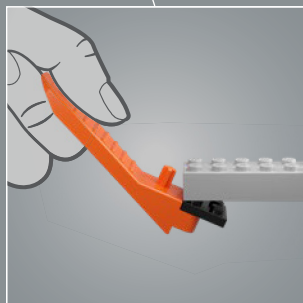
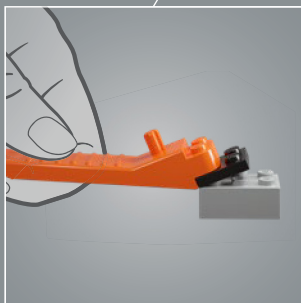
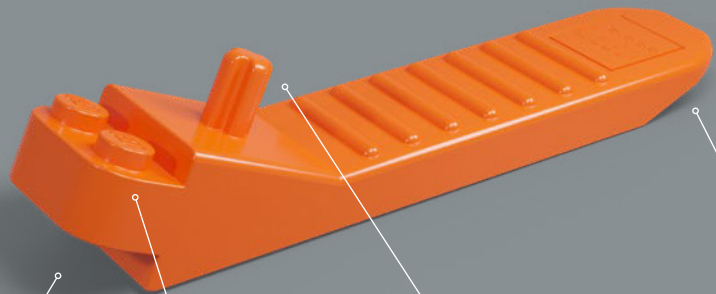



La costruzione della Fontana di Trevi, progettata da Nicola Salvi, ha richiesto 30 anni e fu completata dall'amico di Salvi, lo scultore Pietro Bracci, nel 1762, 11 anni dopo la sua morte.

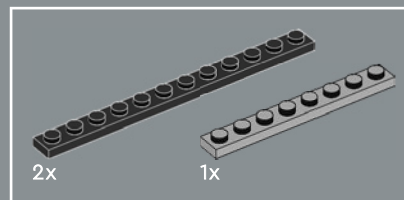

1

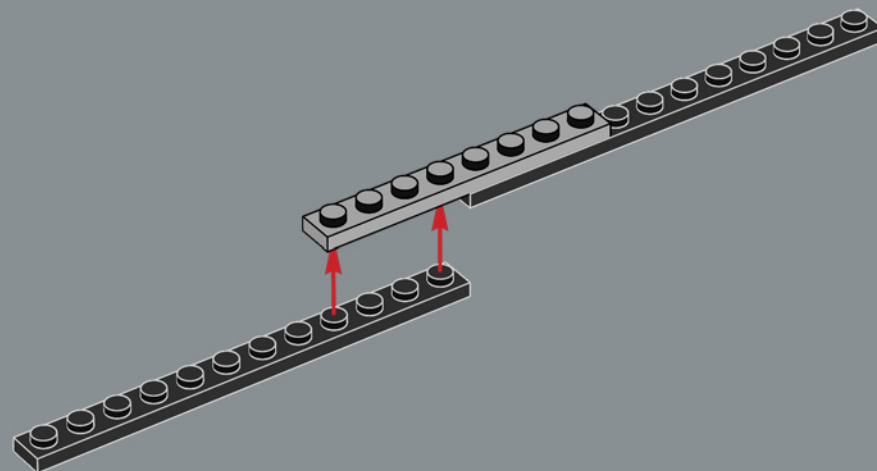

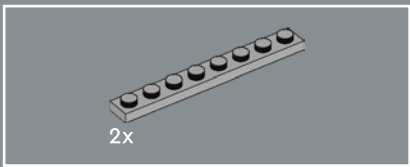

2

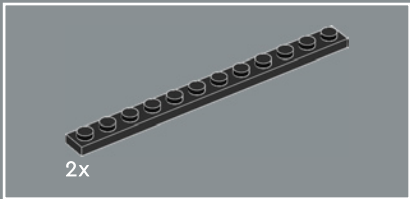
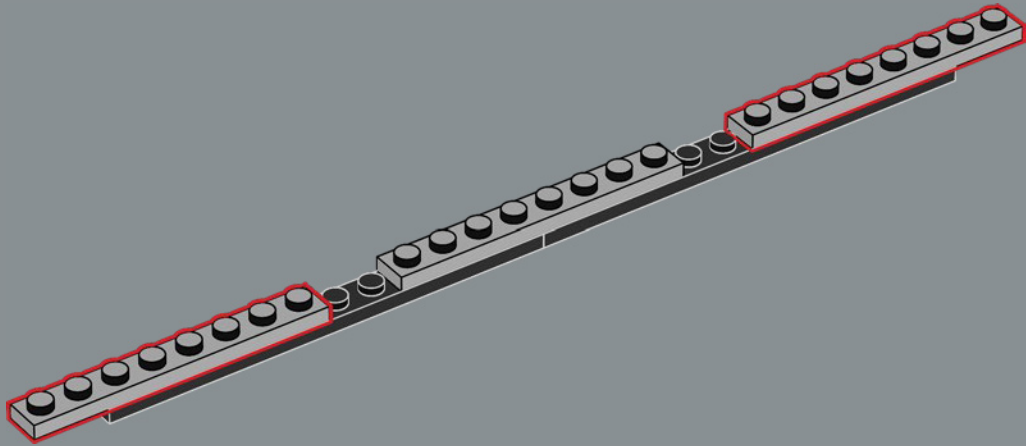

3

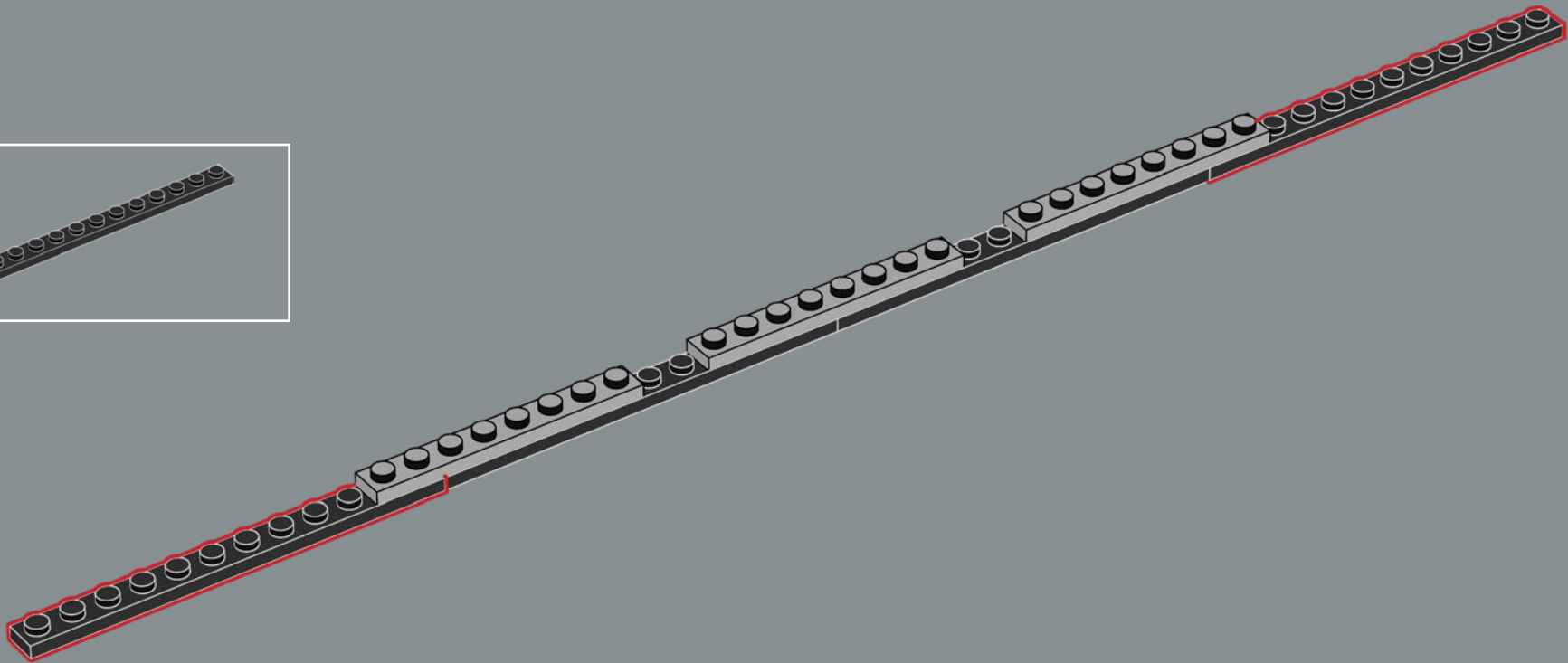

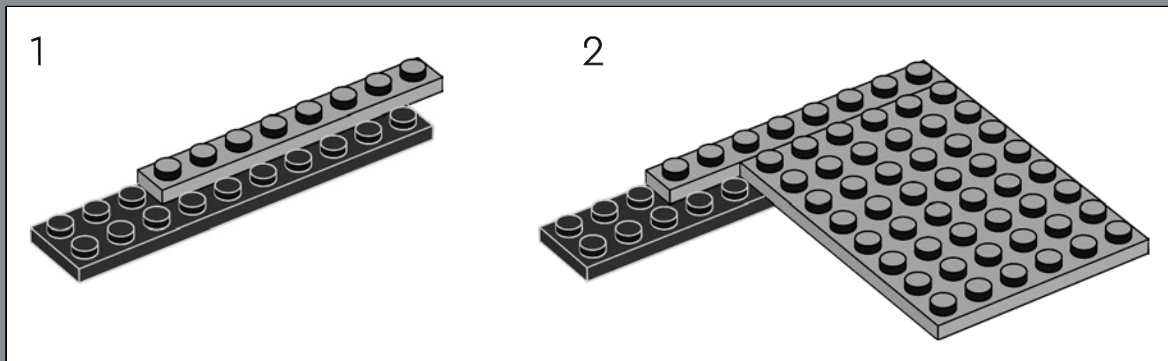
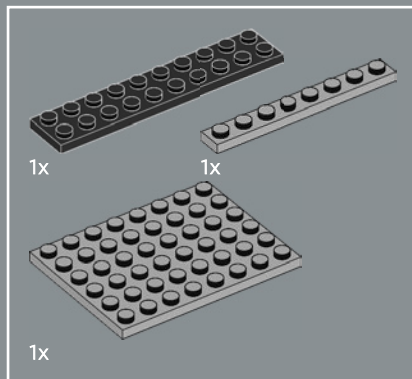

4

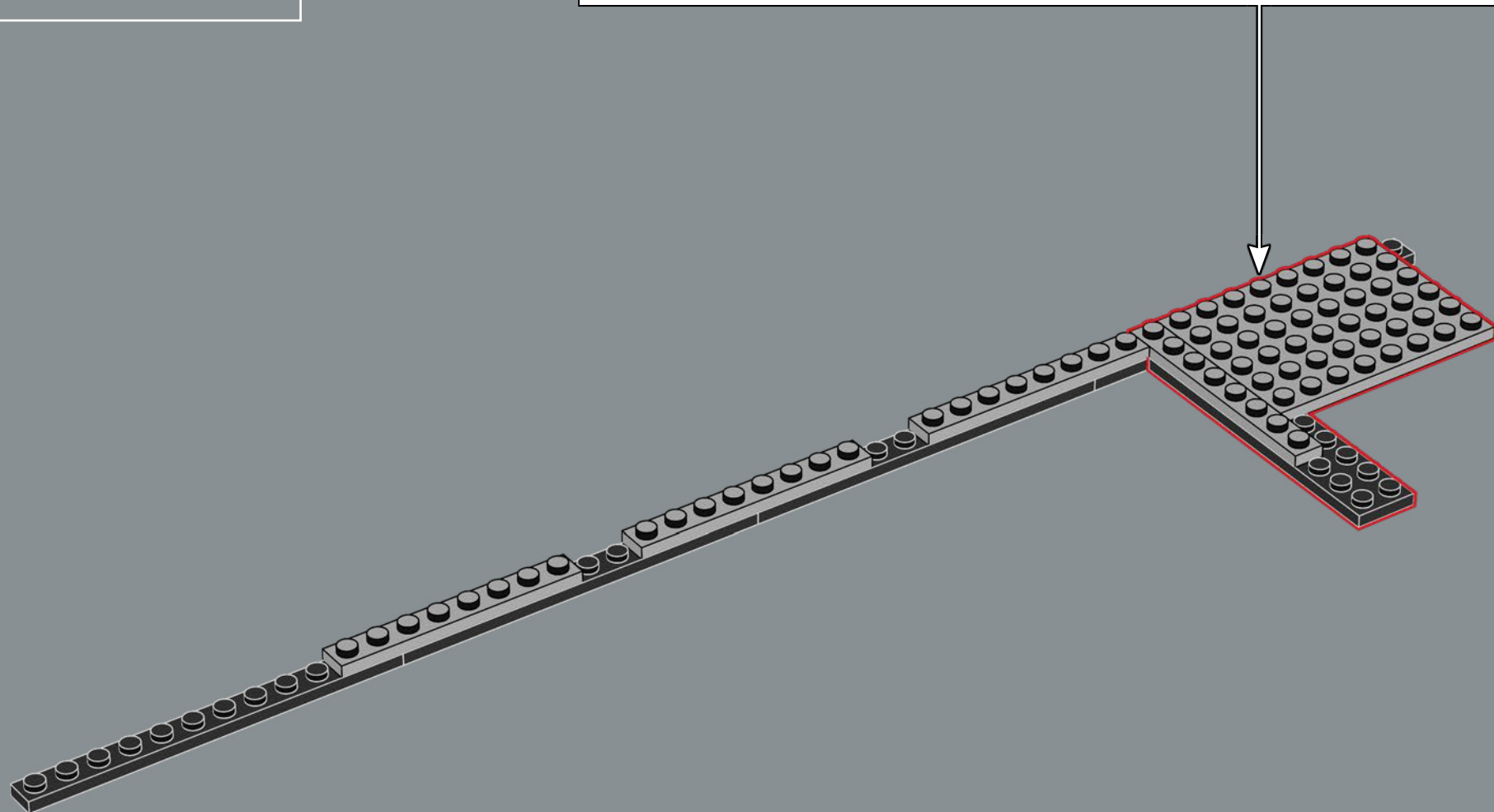

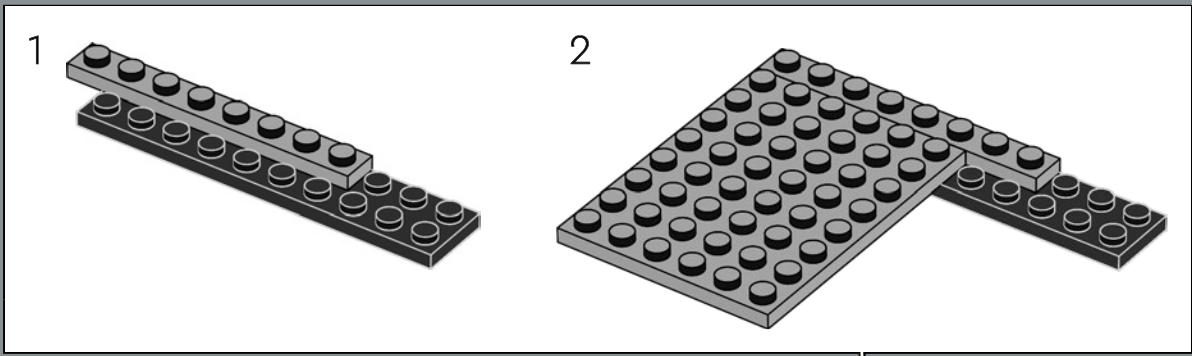
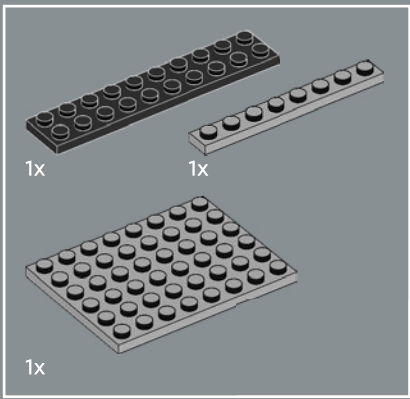

5

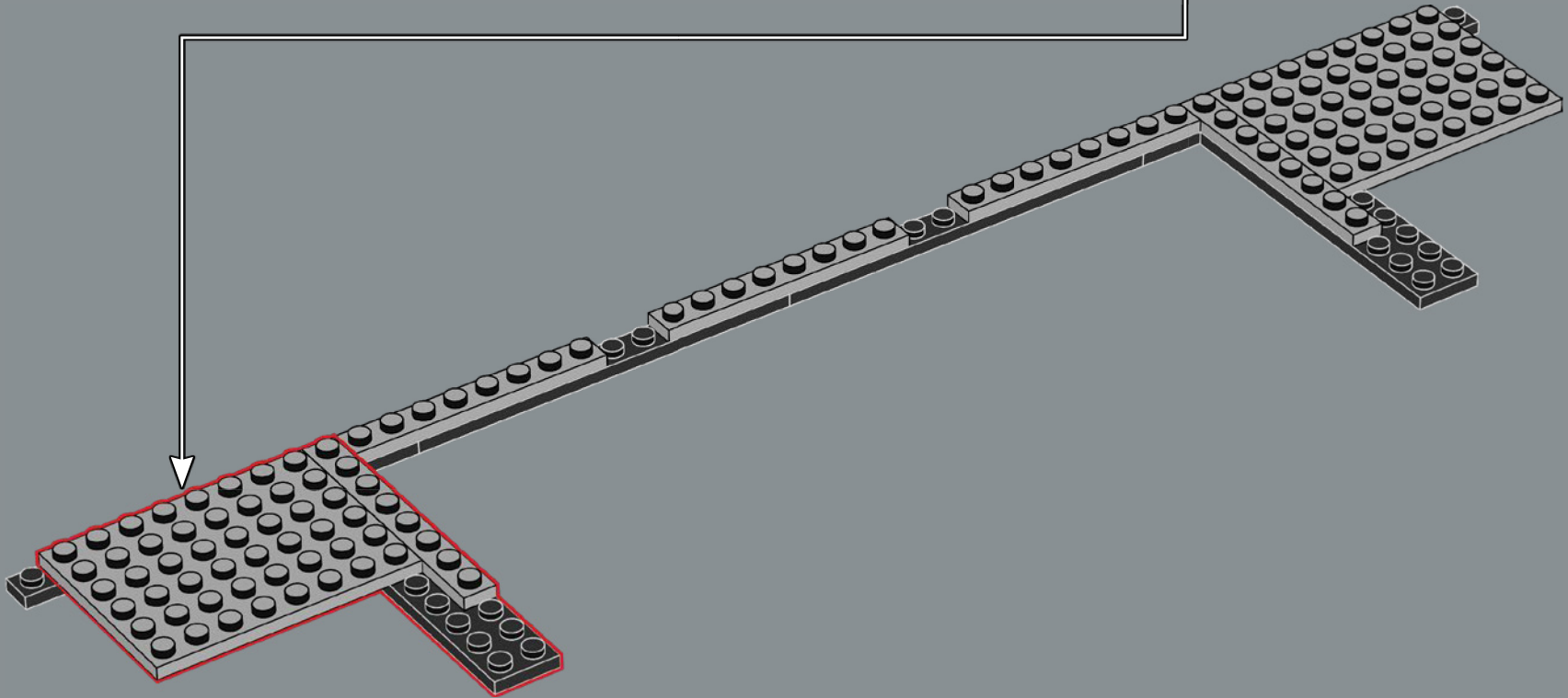

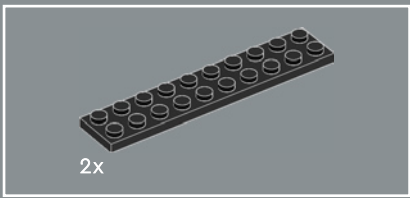

6

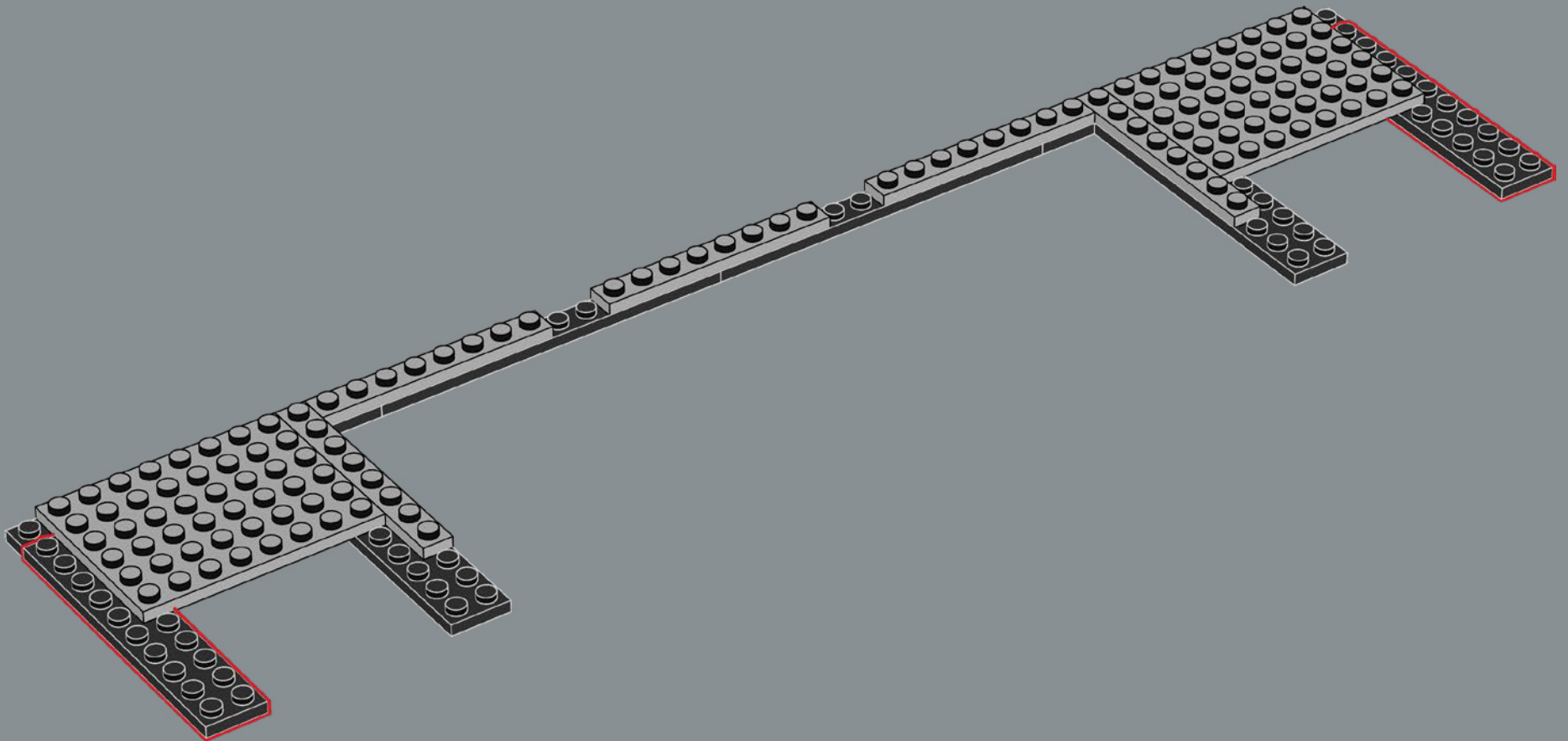

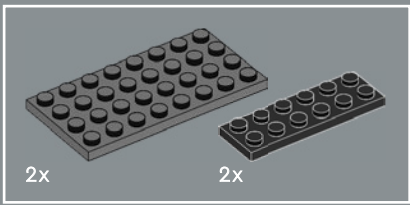

7

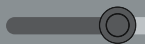
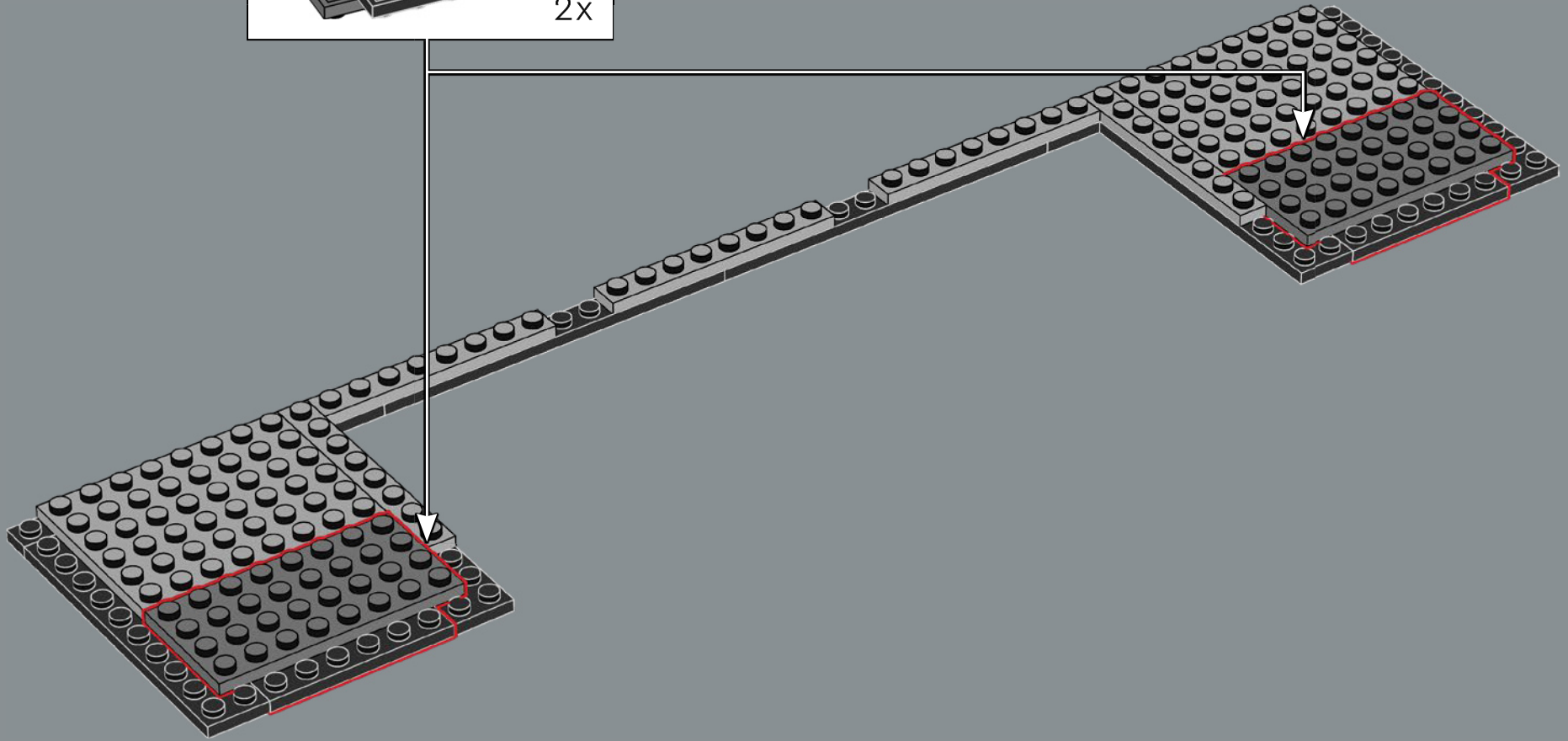
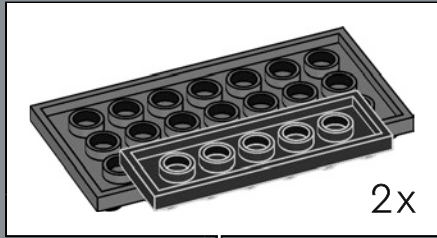





8

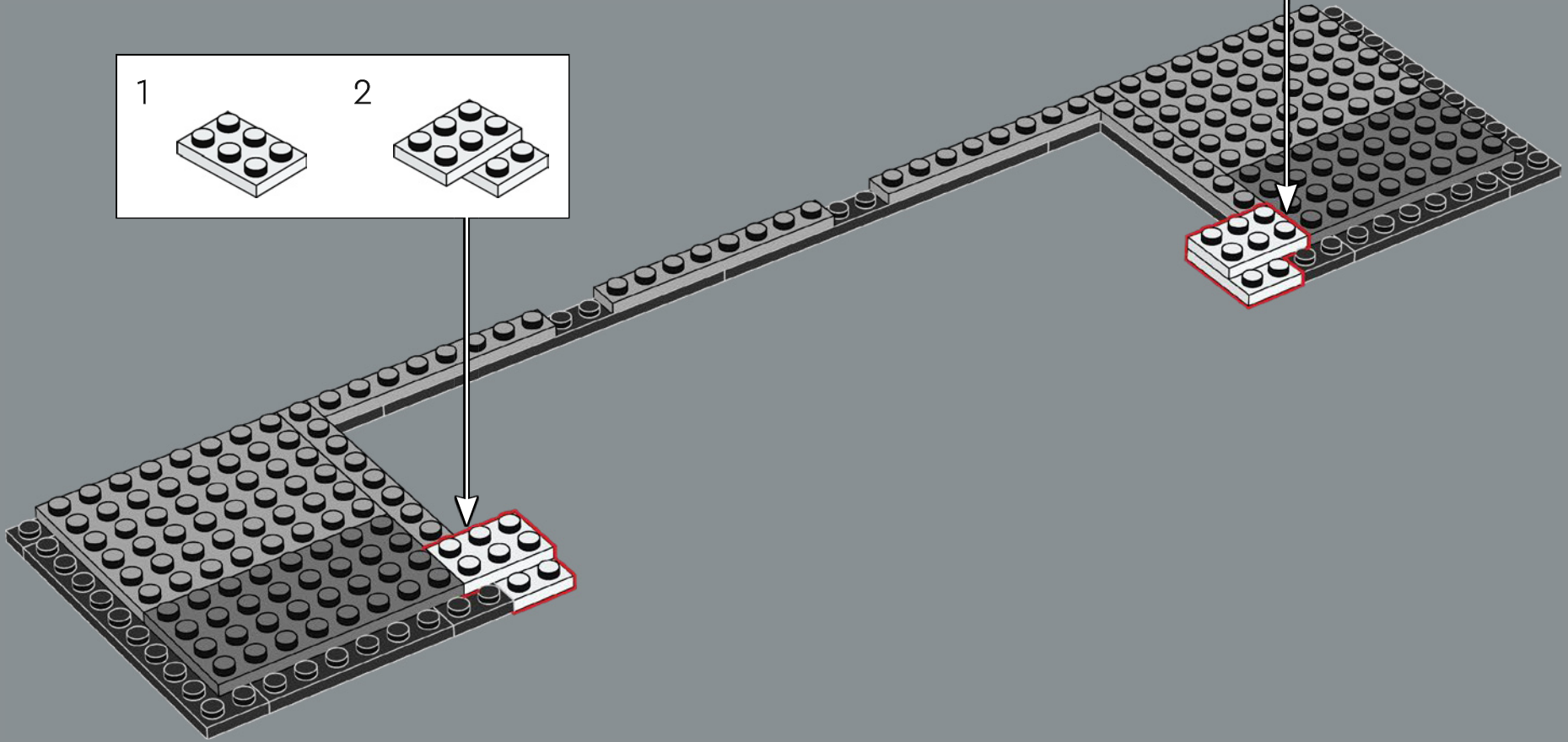
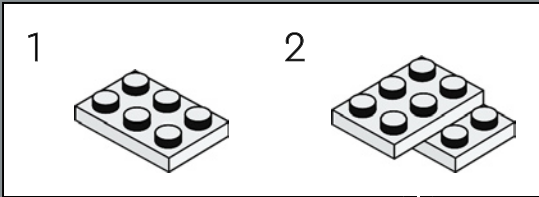
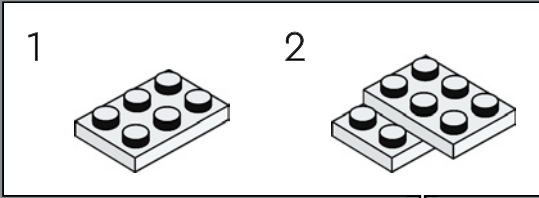

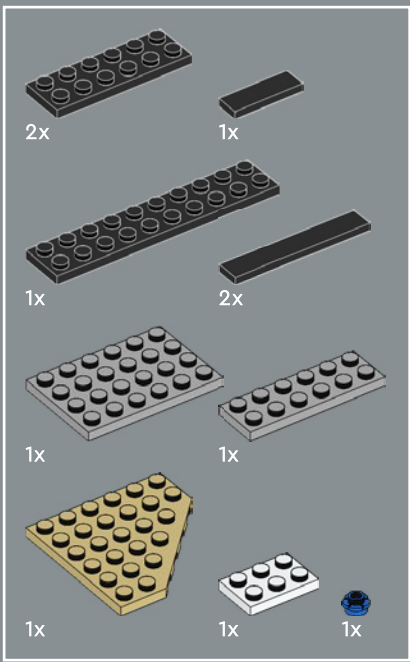

9

1

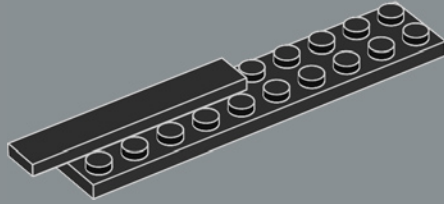

2

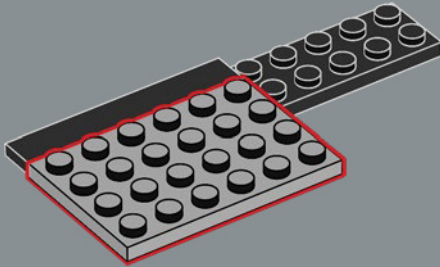

3

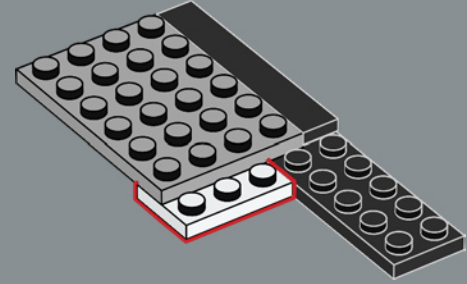

4

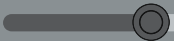
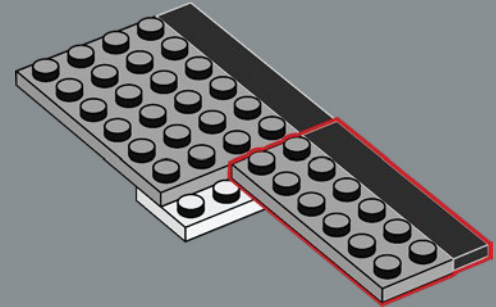

5

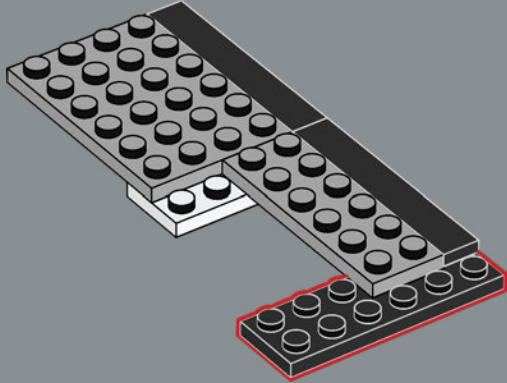

6

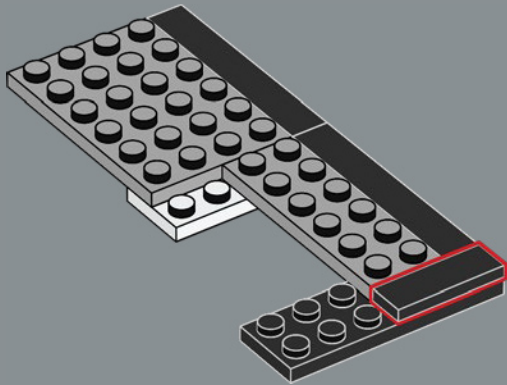

7

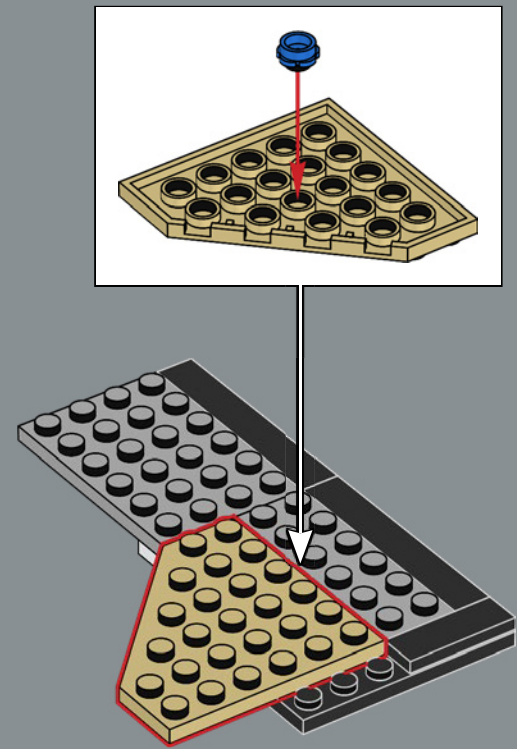

8

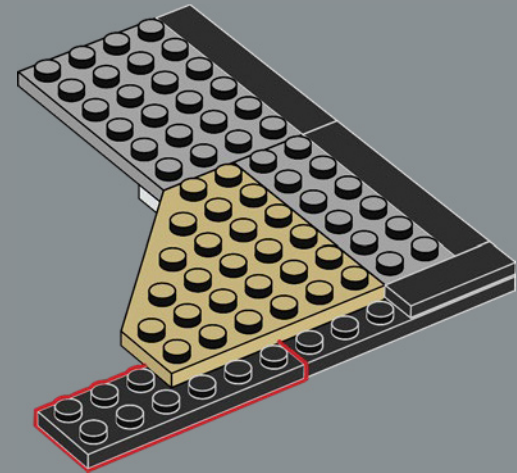

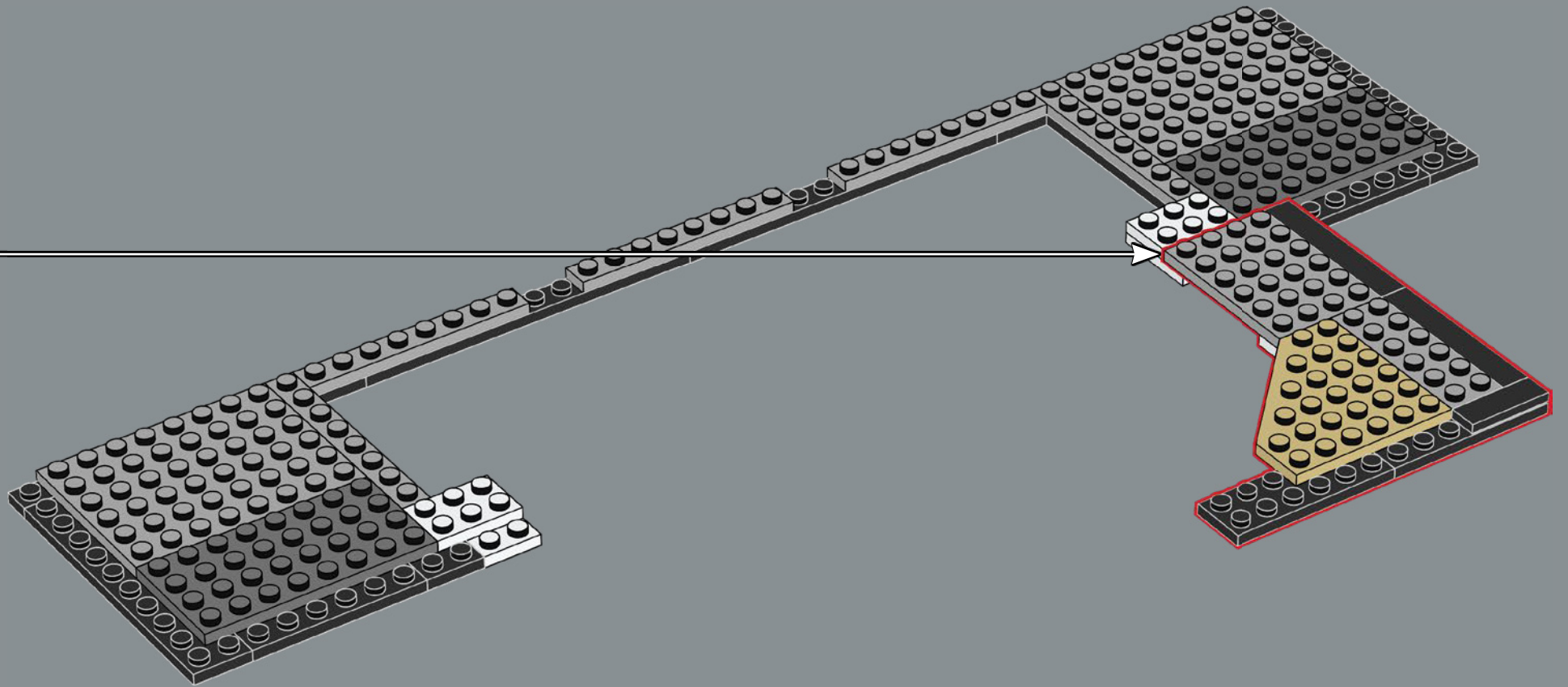

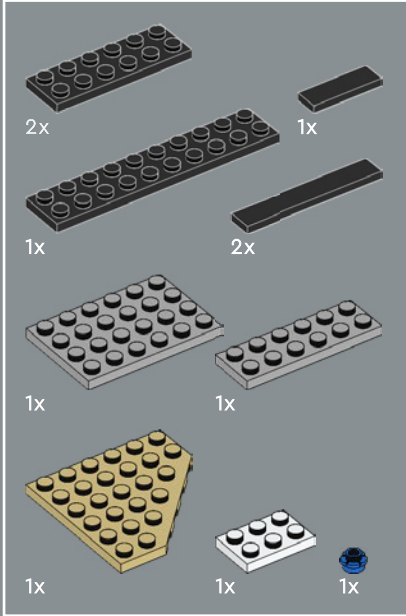
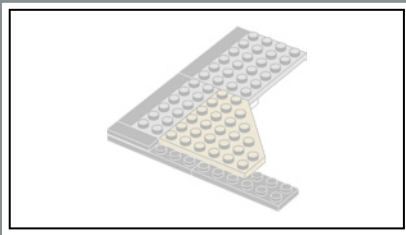

10

1

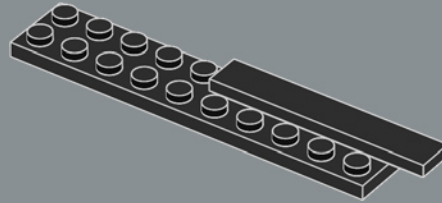

2

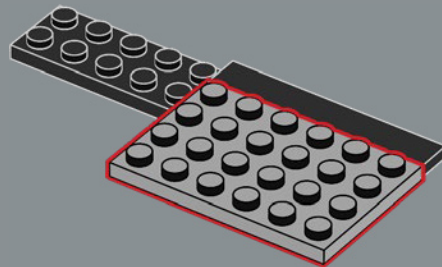

3

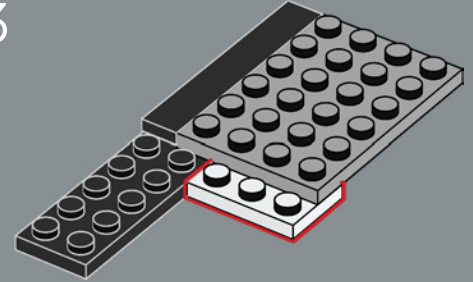

4

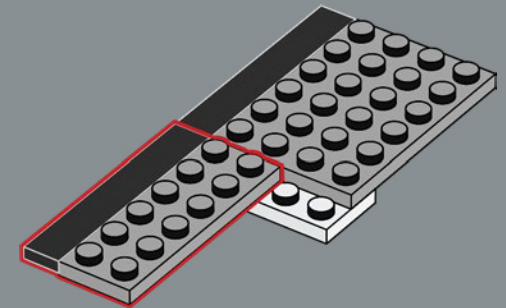

5

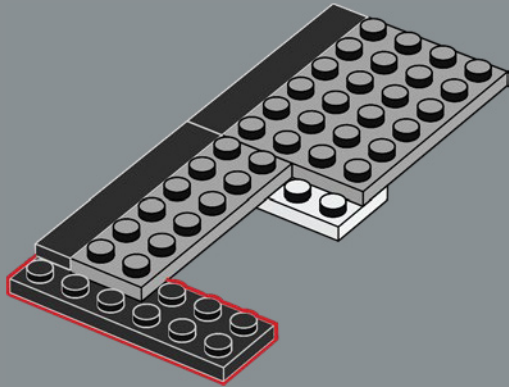

6

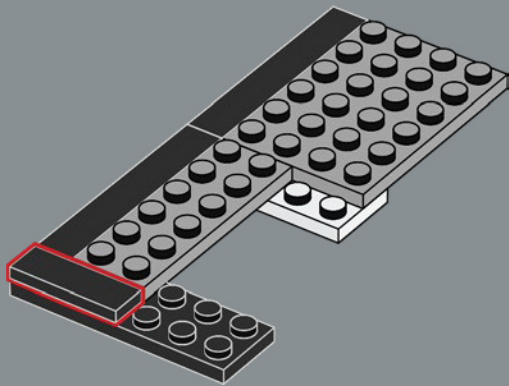

7

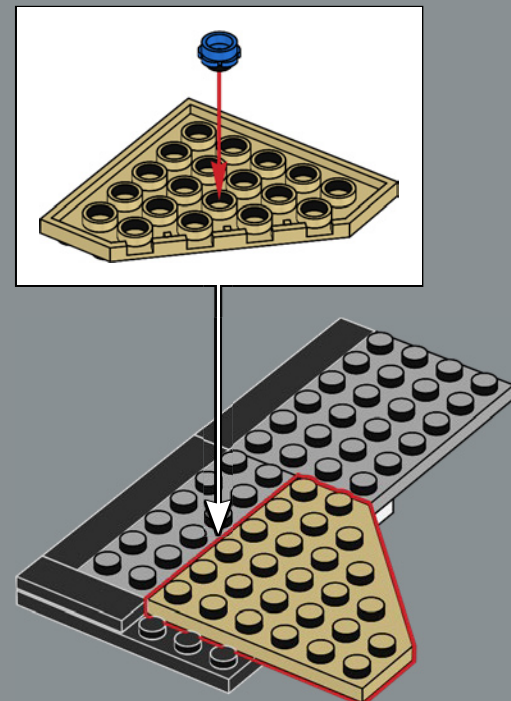

8

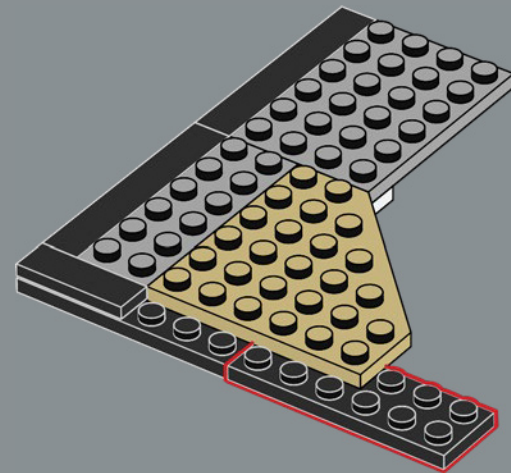

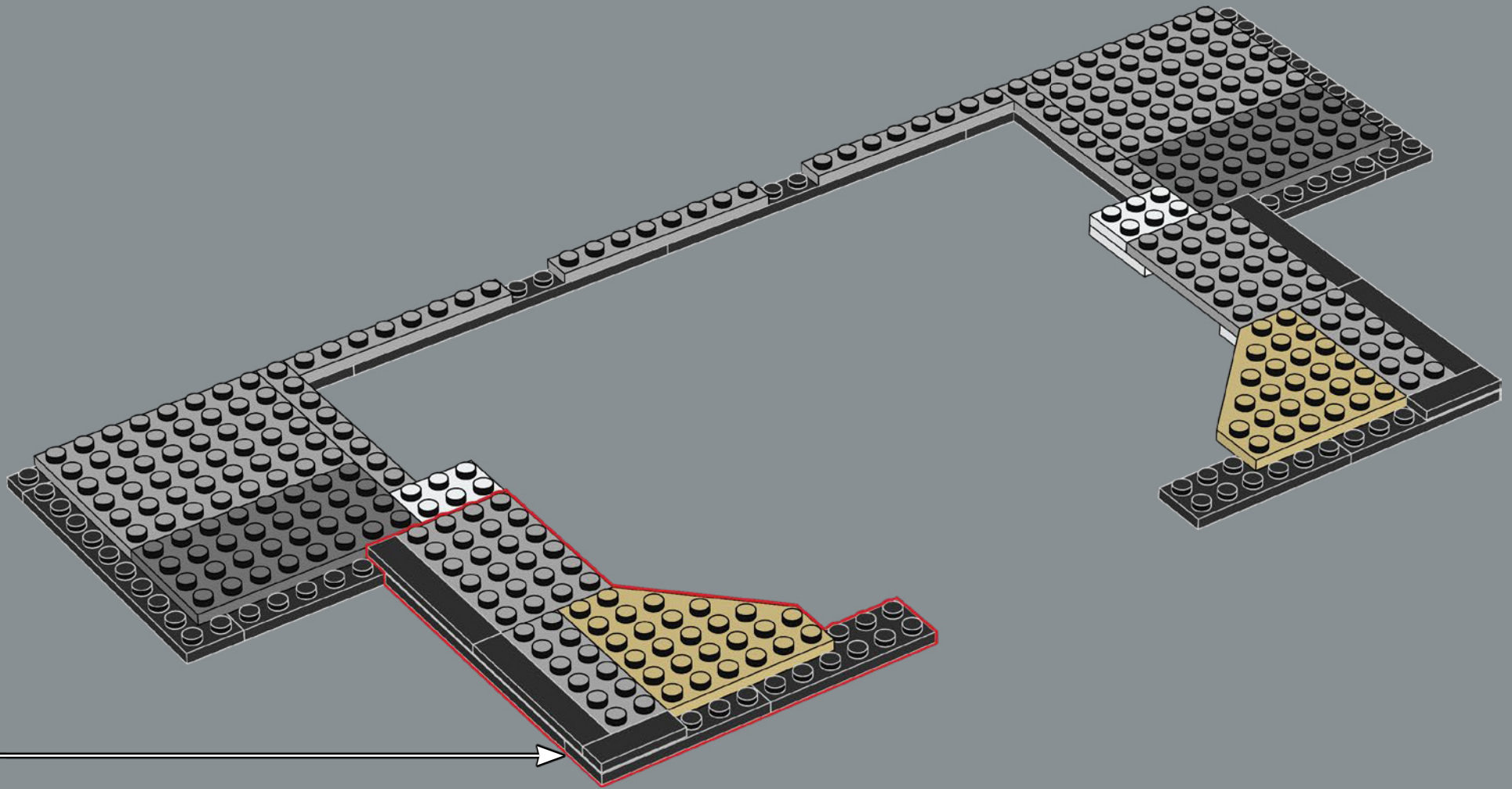

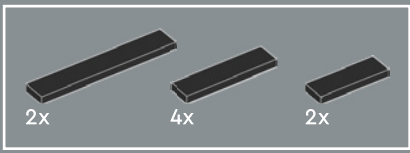

11

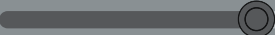
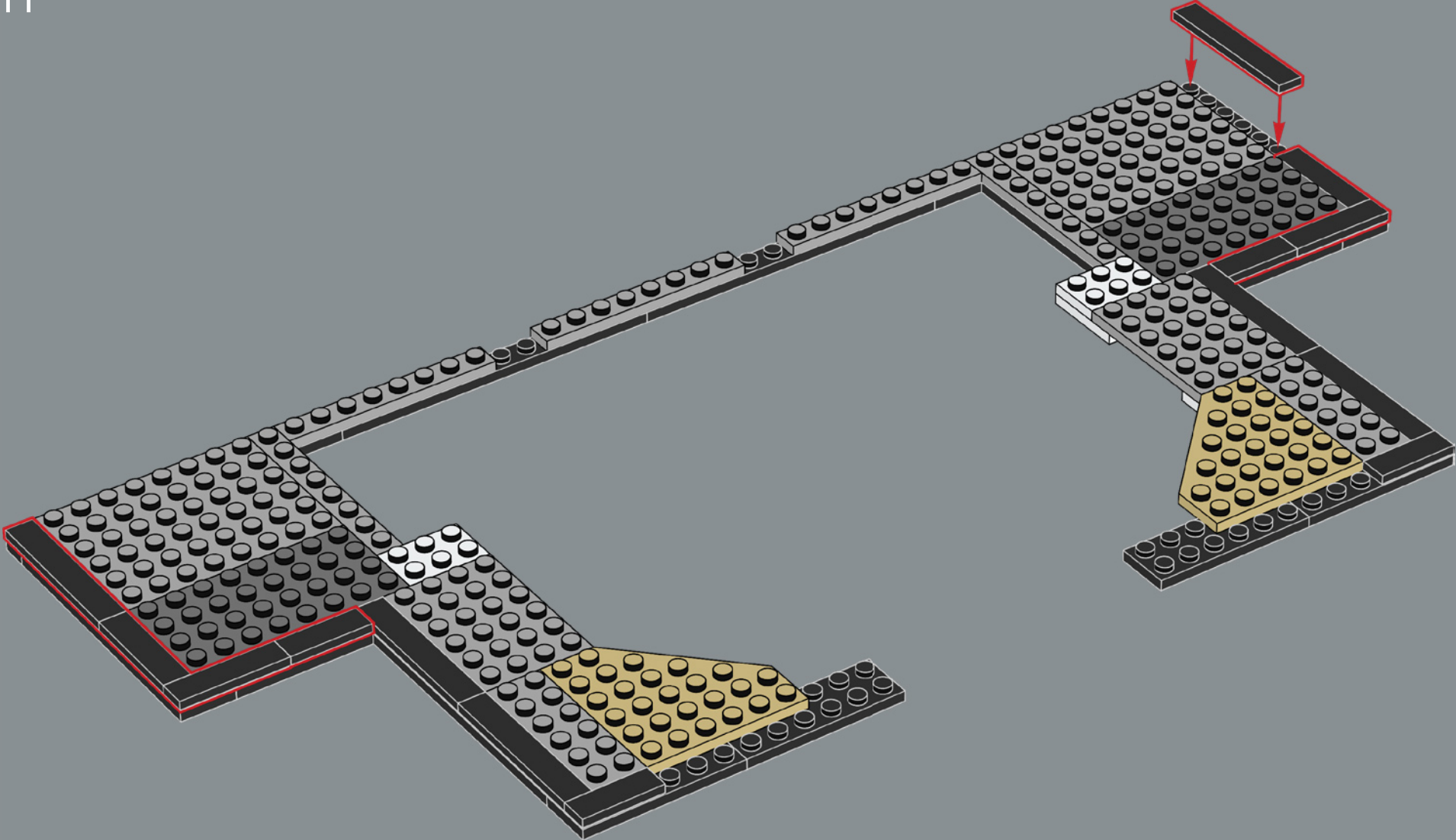



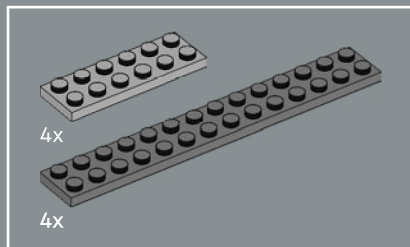

12

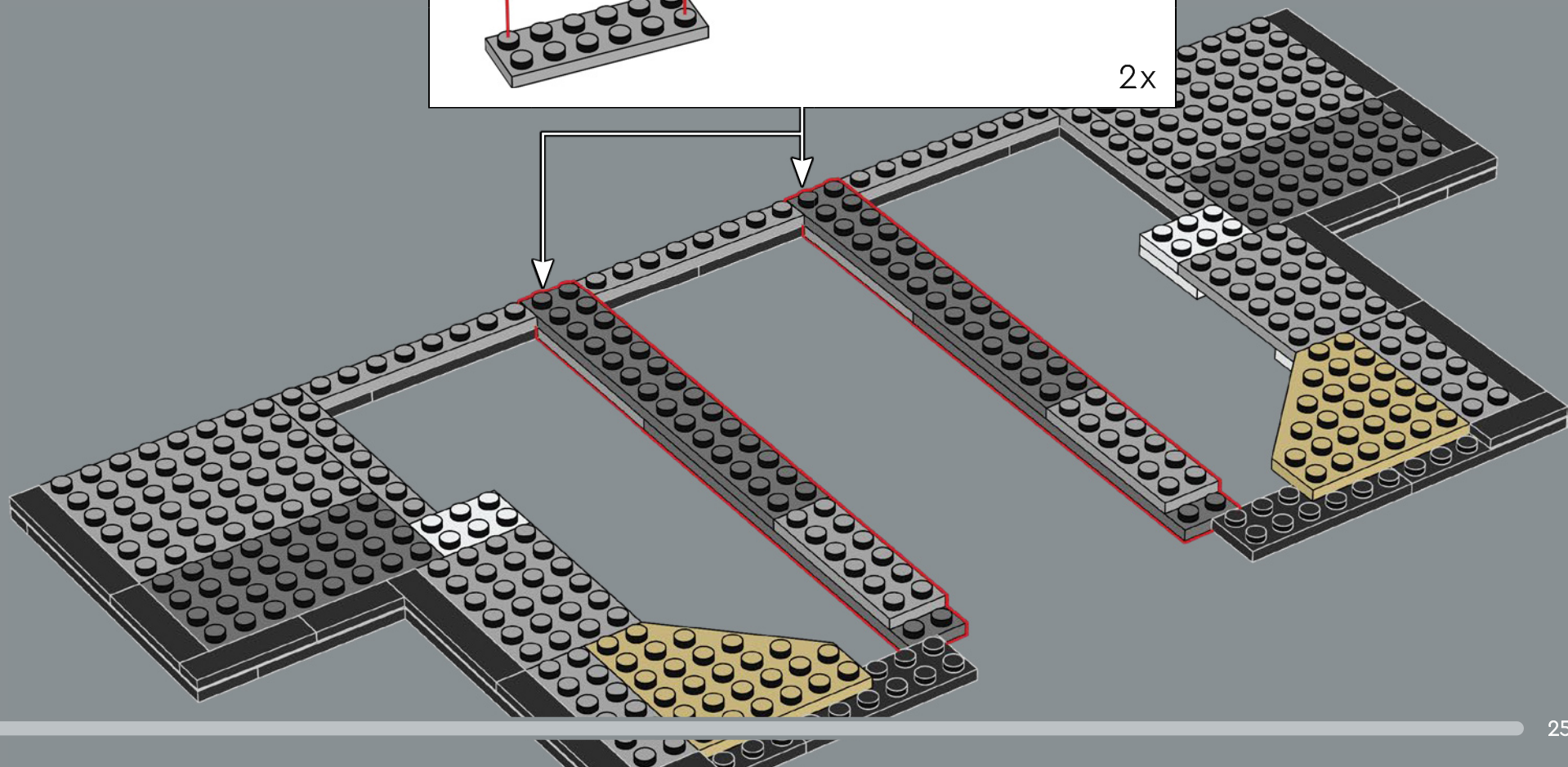
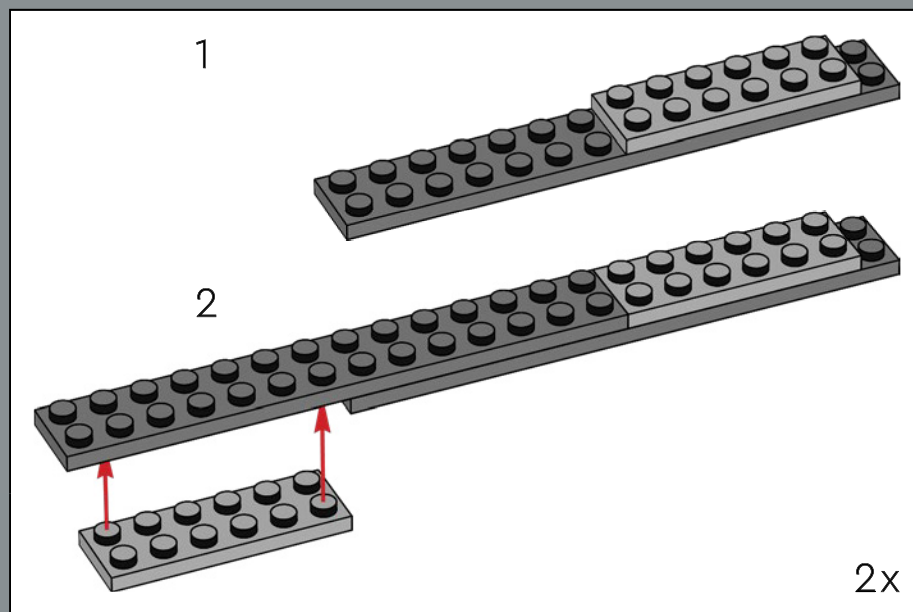

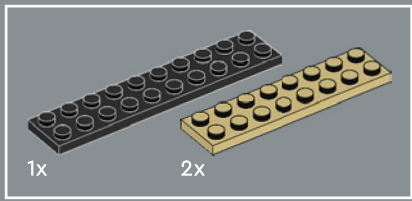

13

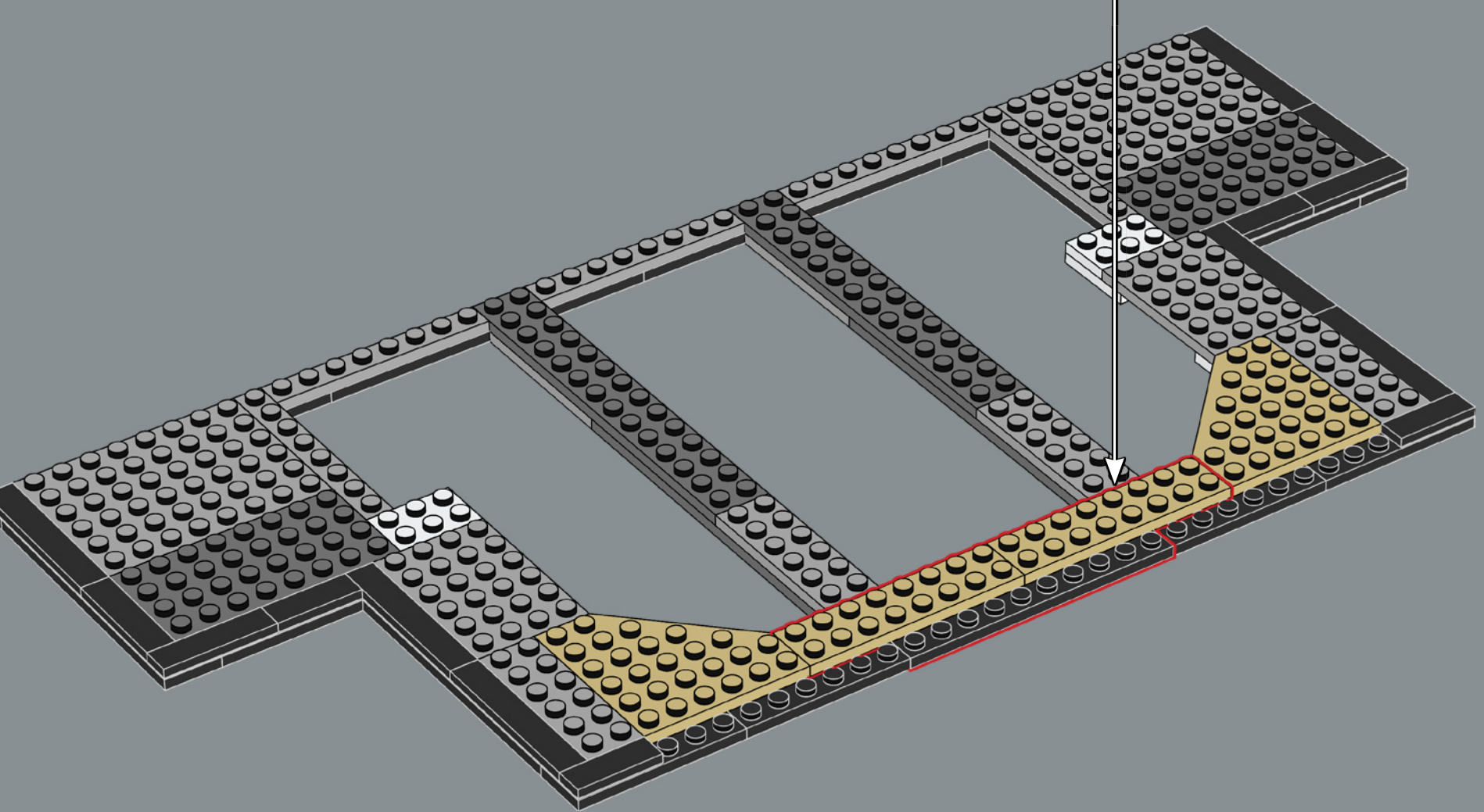
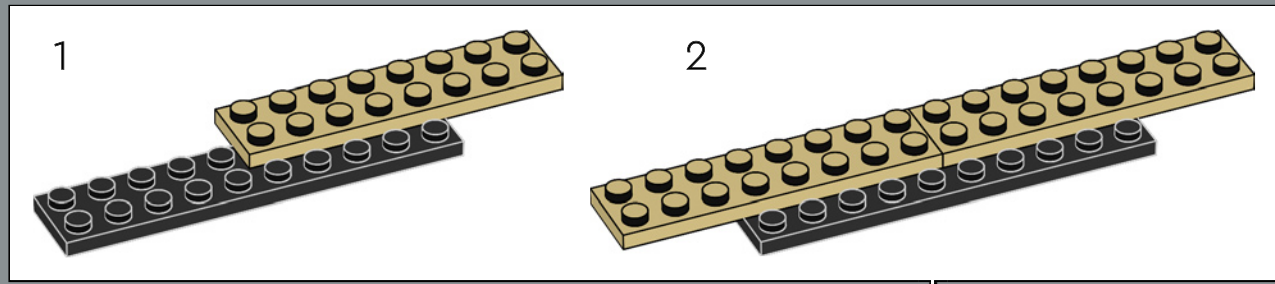

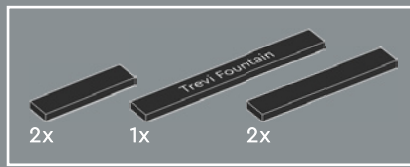

Nel corso dei secoli le "tre vie" che hanno portato e ispirato il nome della Fontana di Trevi si sono ampliate. Cinque strade conducono ora alla famosa piazza.

14

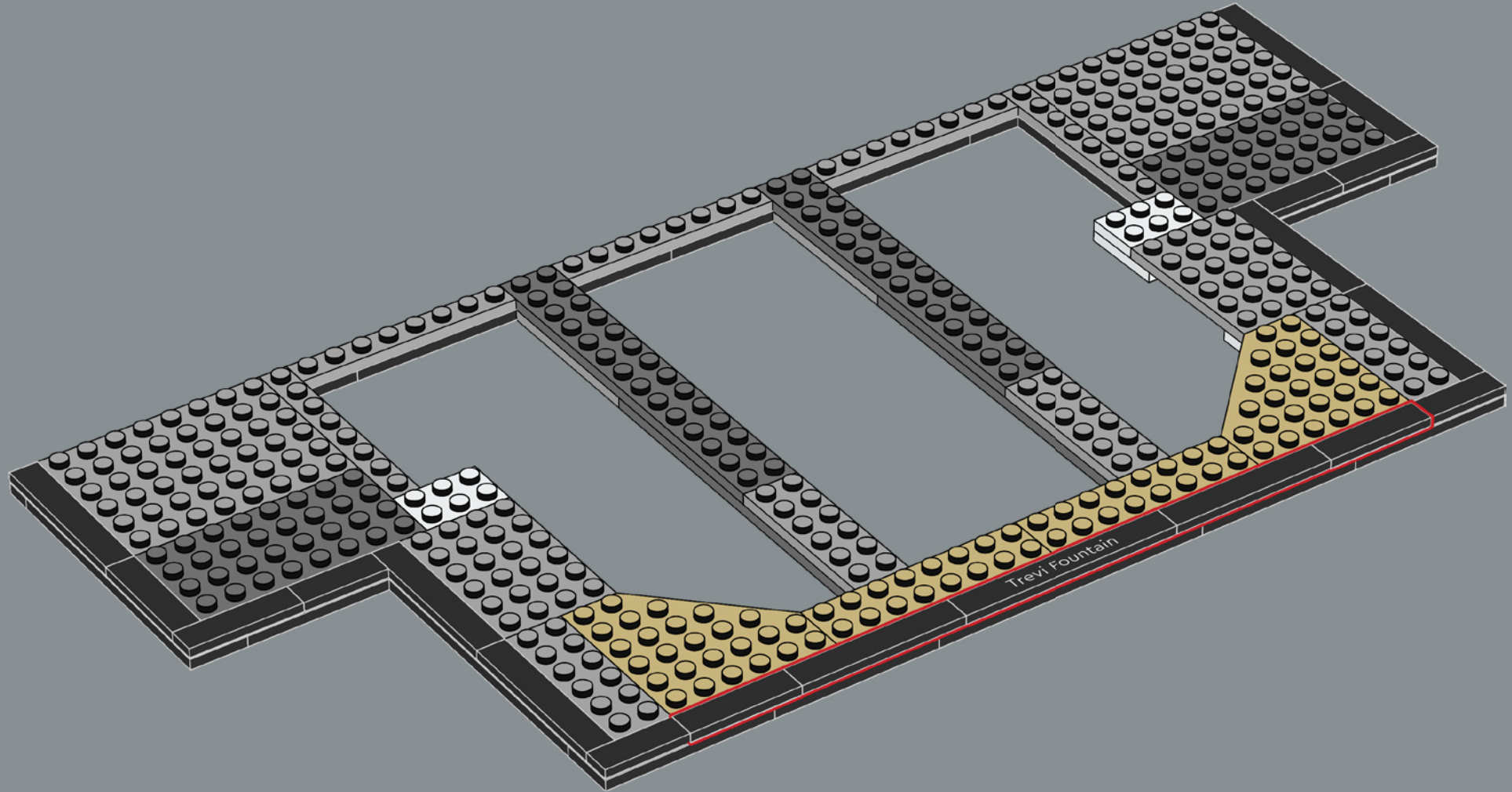

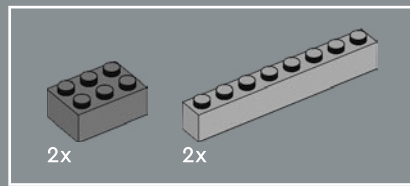

15

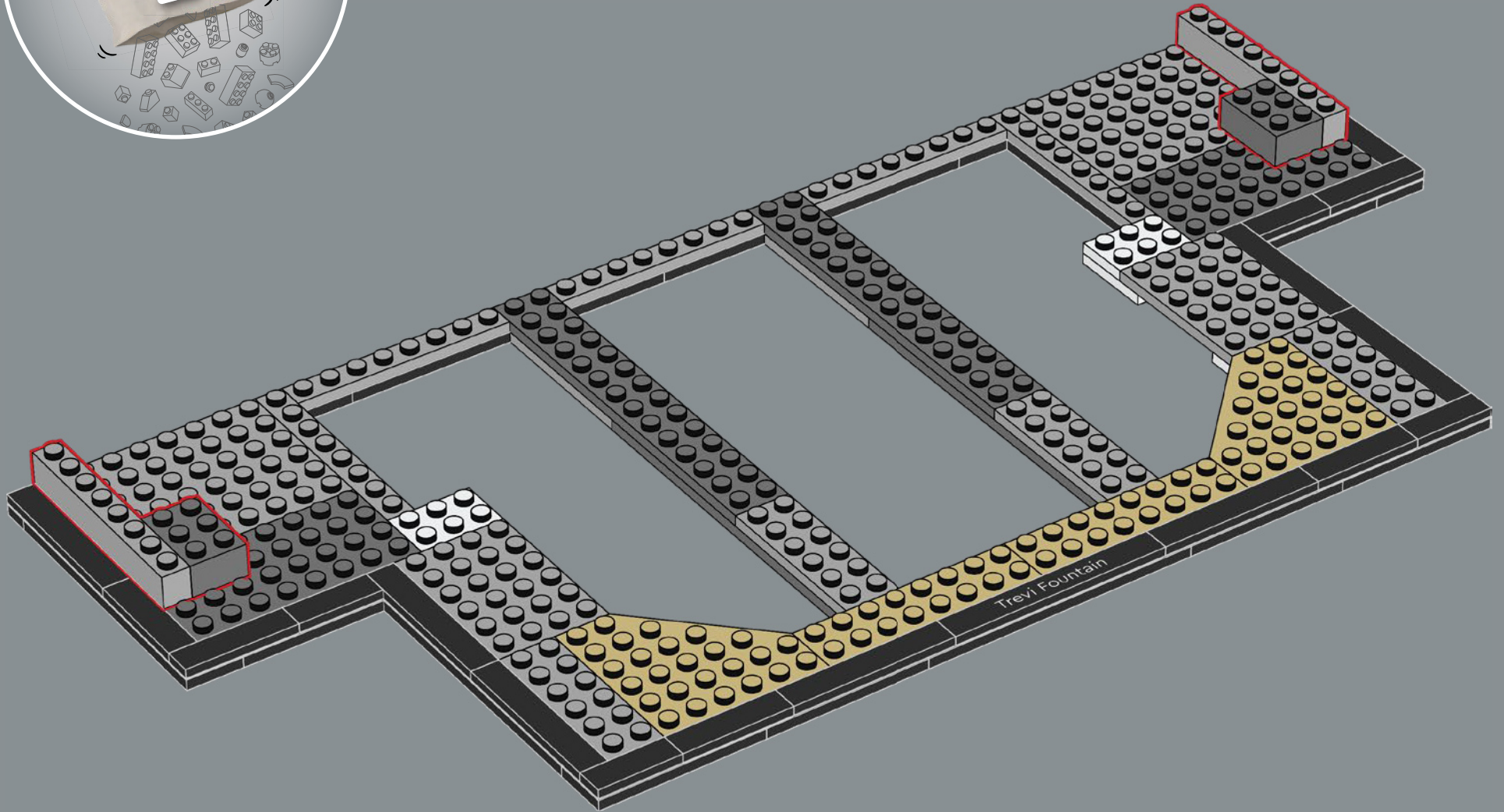

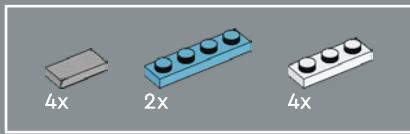

16

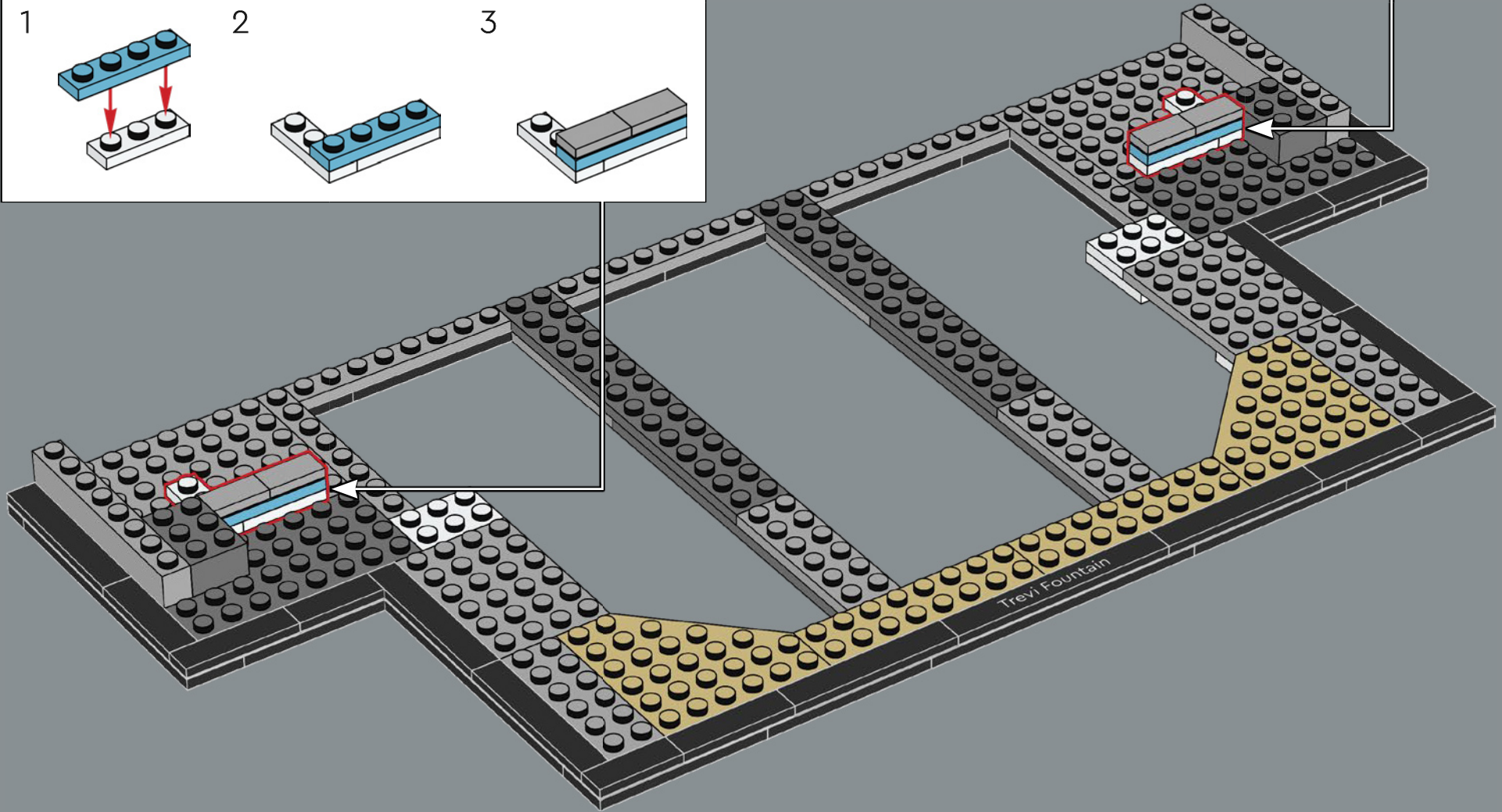
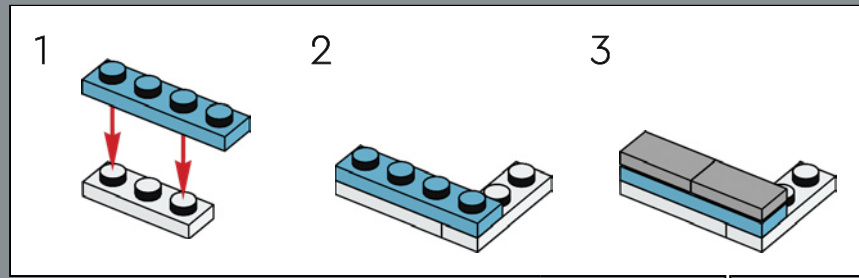
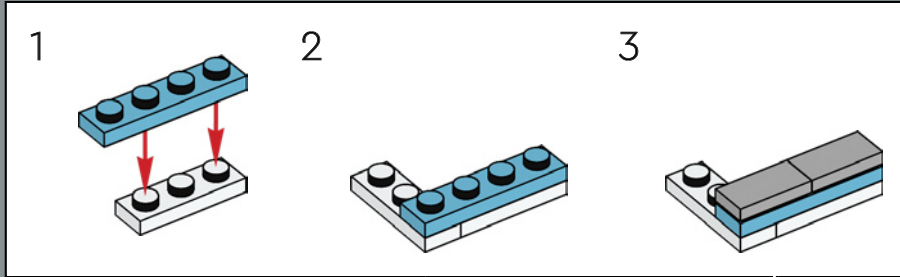

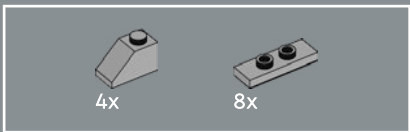

17

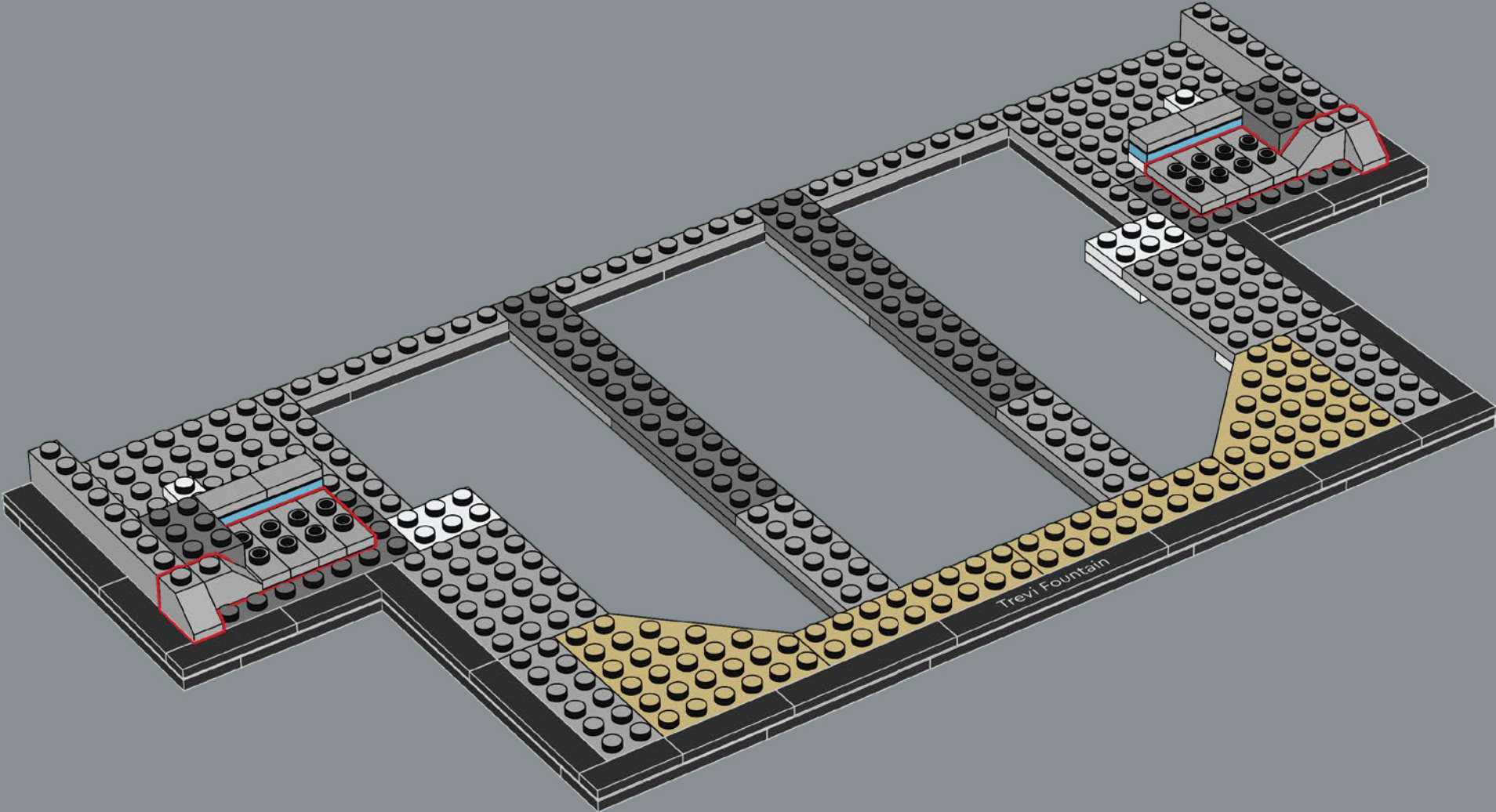

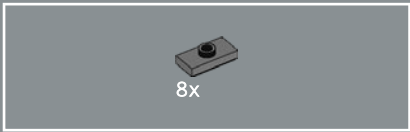

18

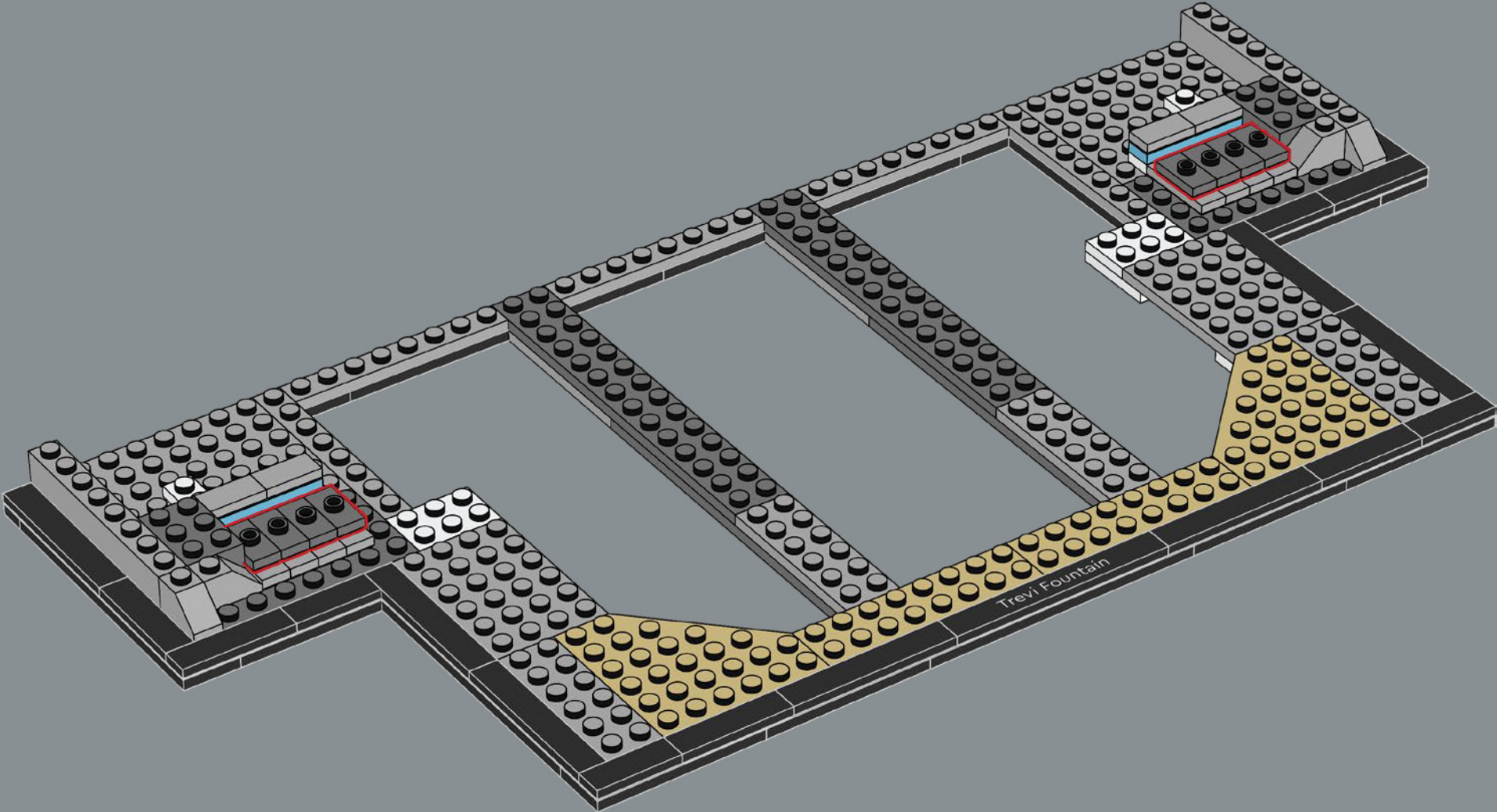



8x

19

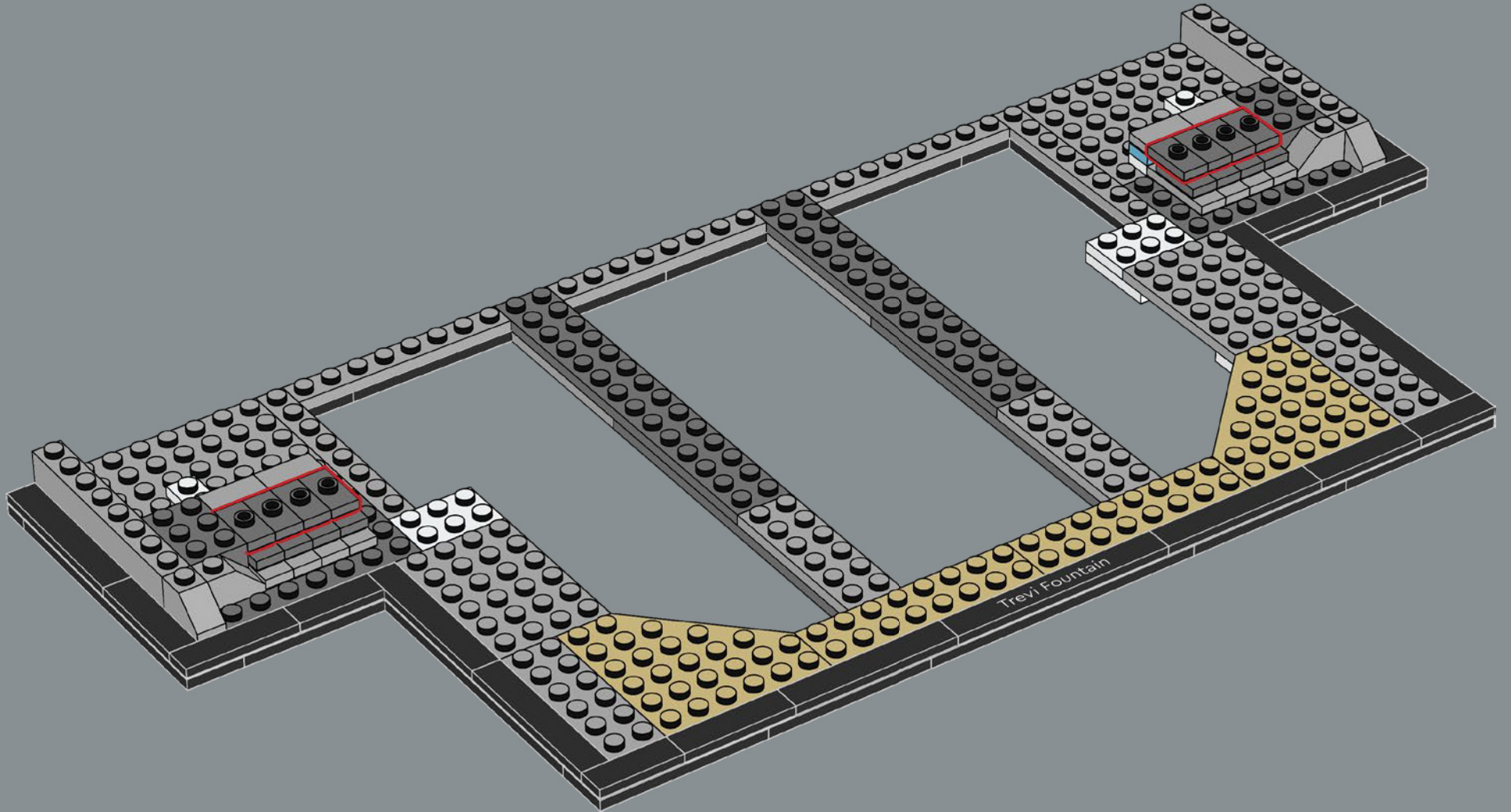



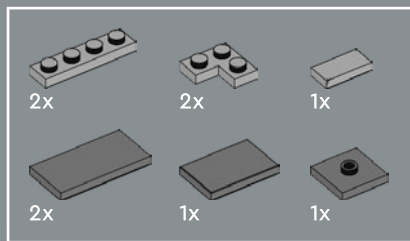

L'enorme quantità di traffico pedonale verso il monumento contribuisce anche al graduale scolorimento della pavimentazione, dei gradini e della strato in roccia inferiore.

20

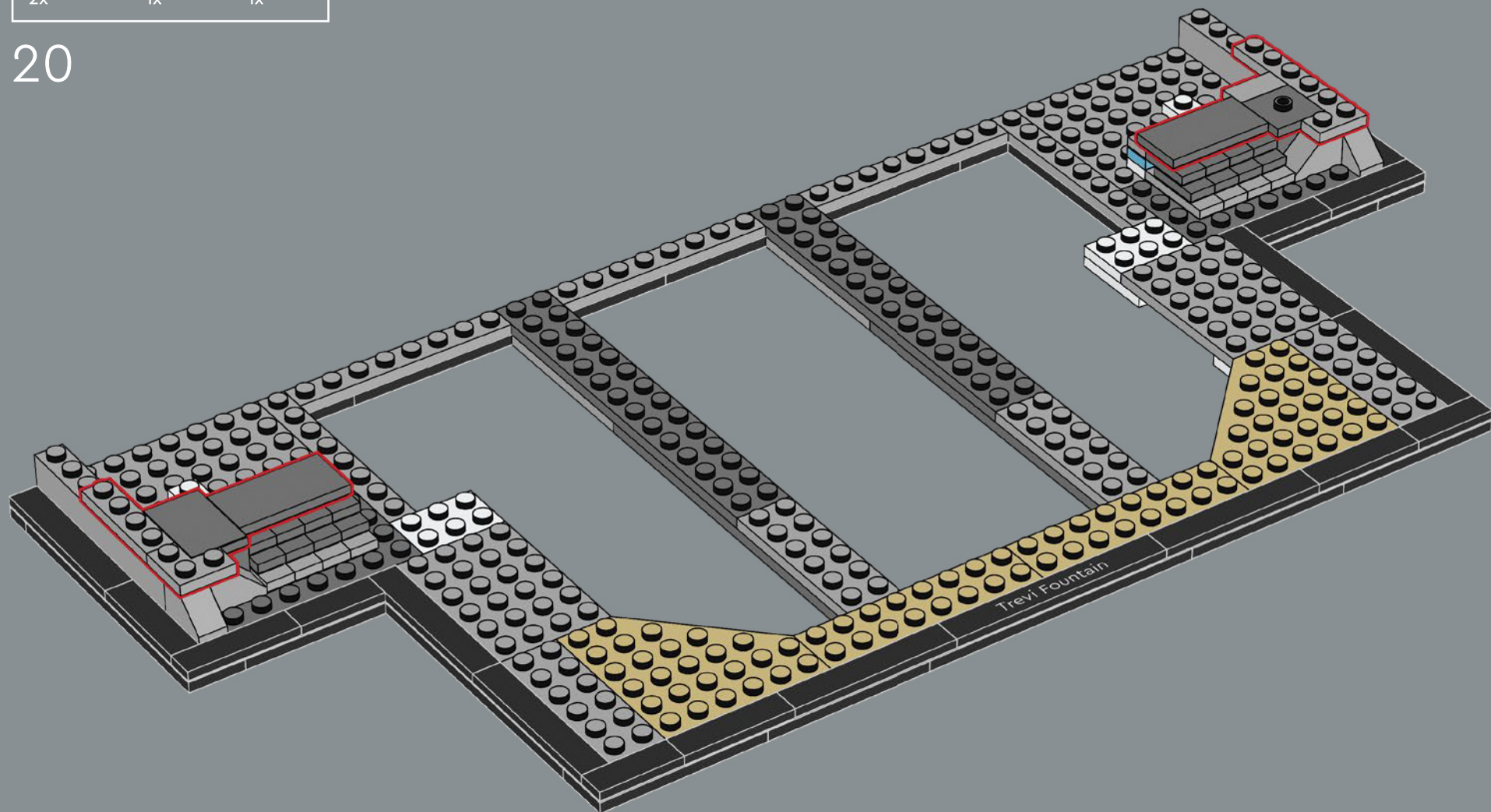

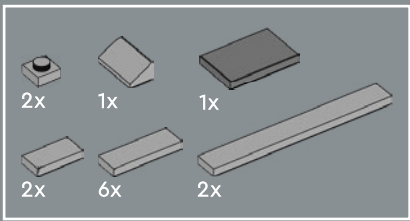

21

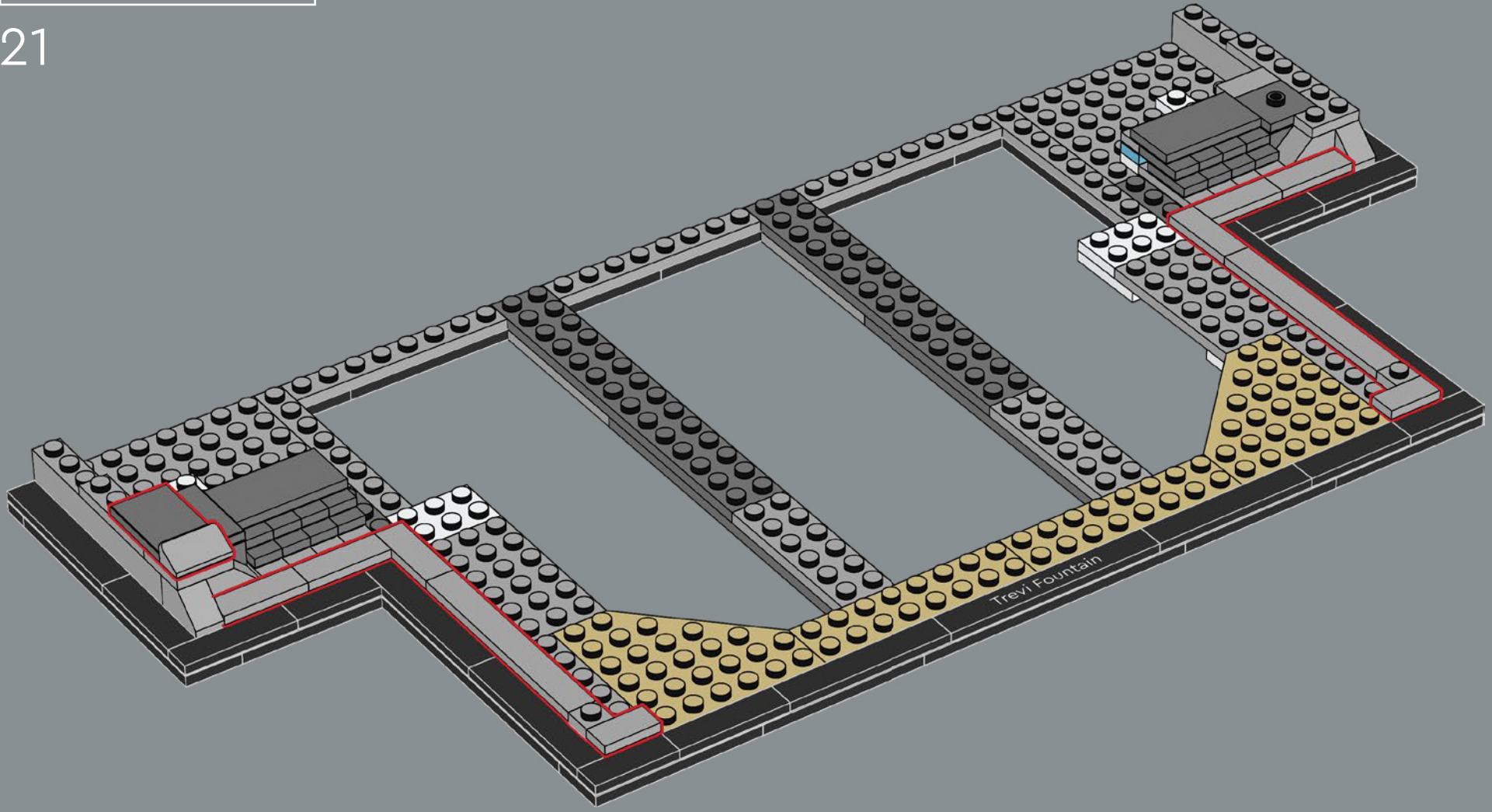

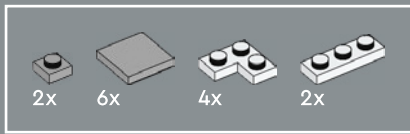

22

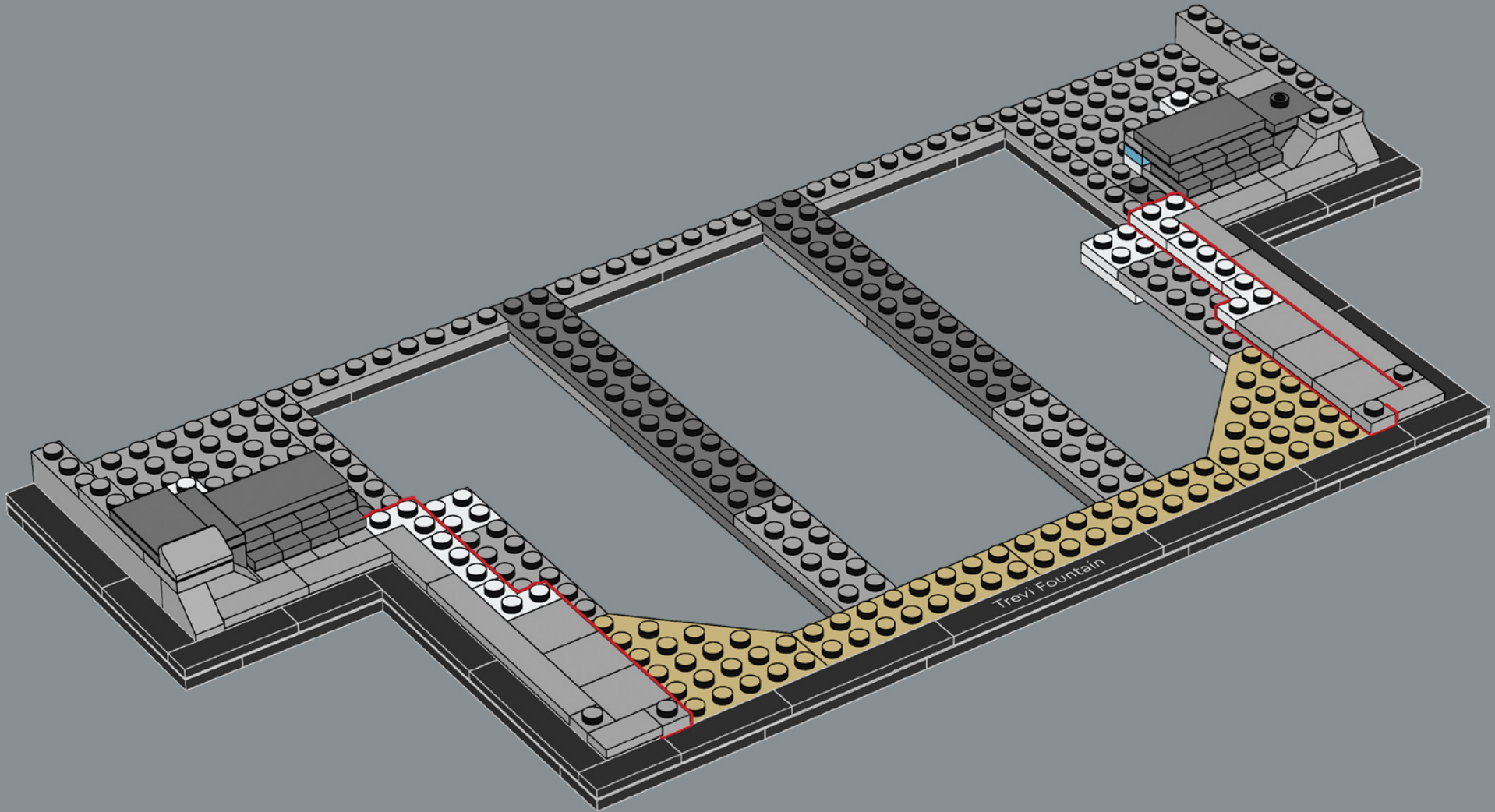

La Piazza di Trevi ospita ogni anno circa 10 milioni di visitatori, rendendola una delle mete turistiche più apprezzate in Italia.

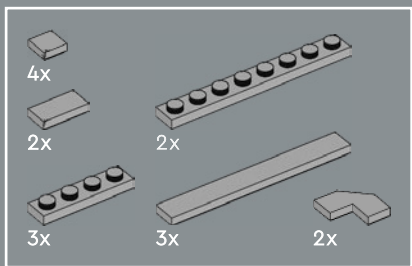

23

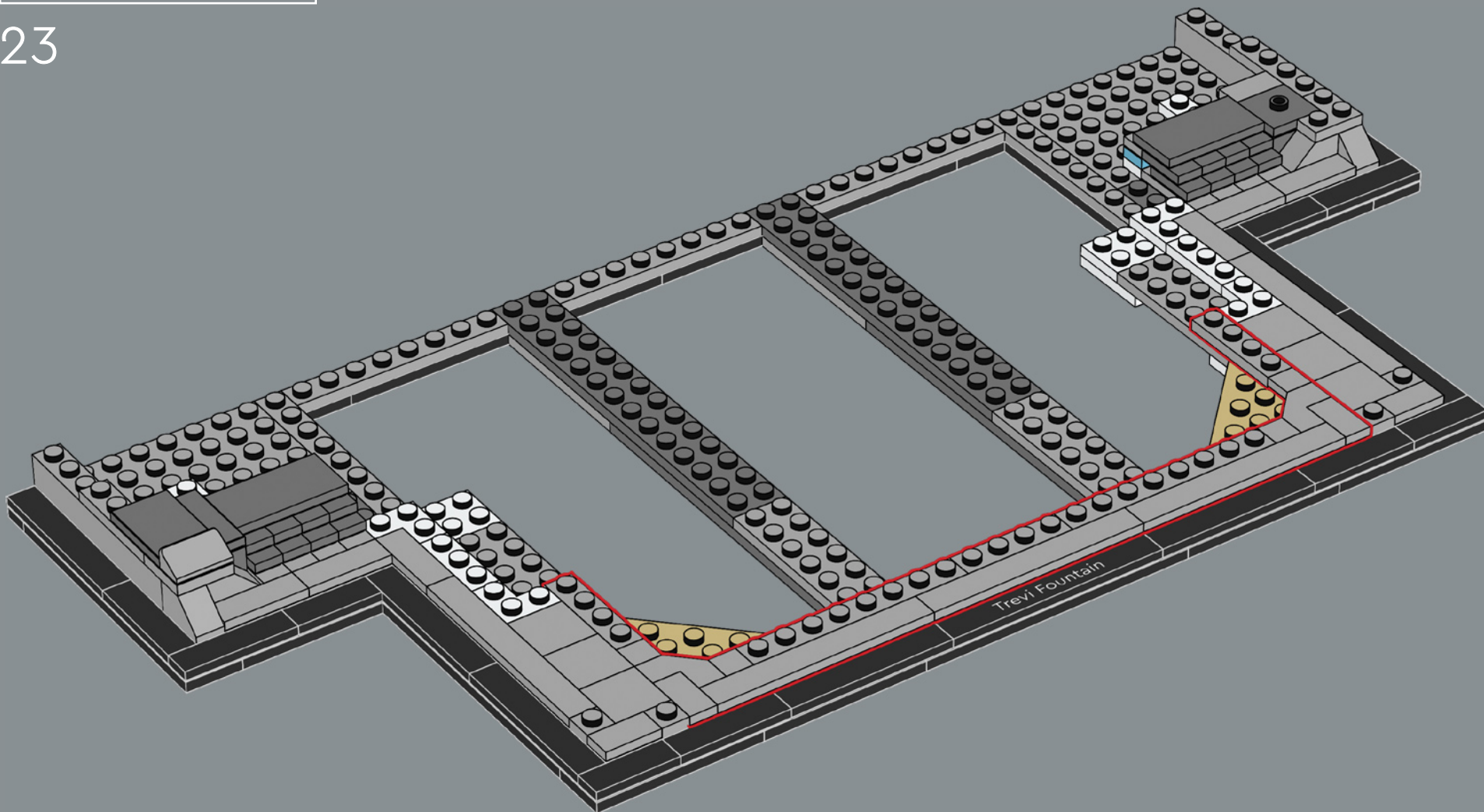

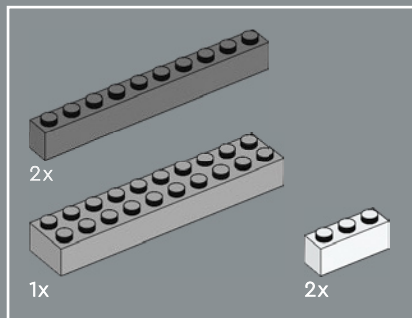

24

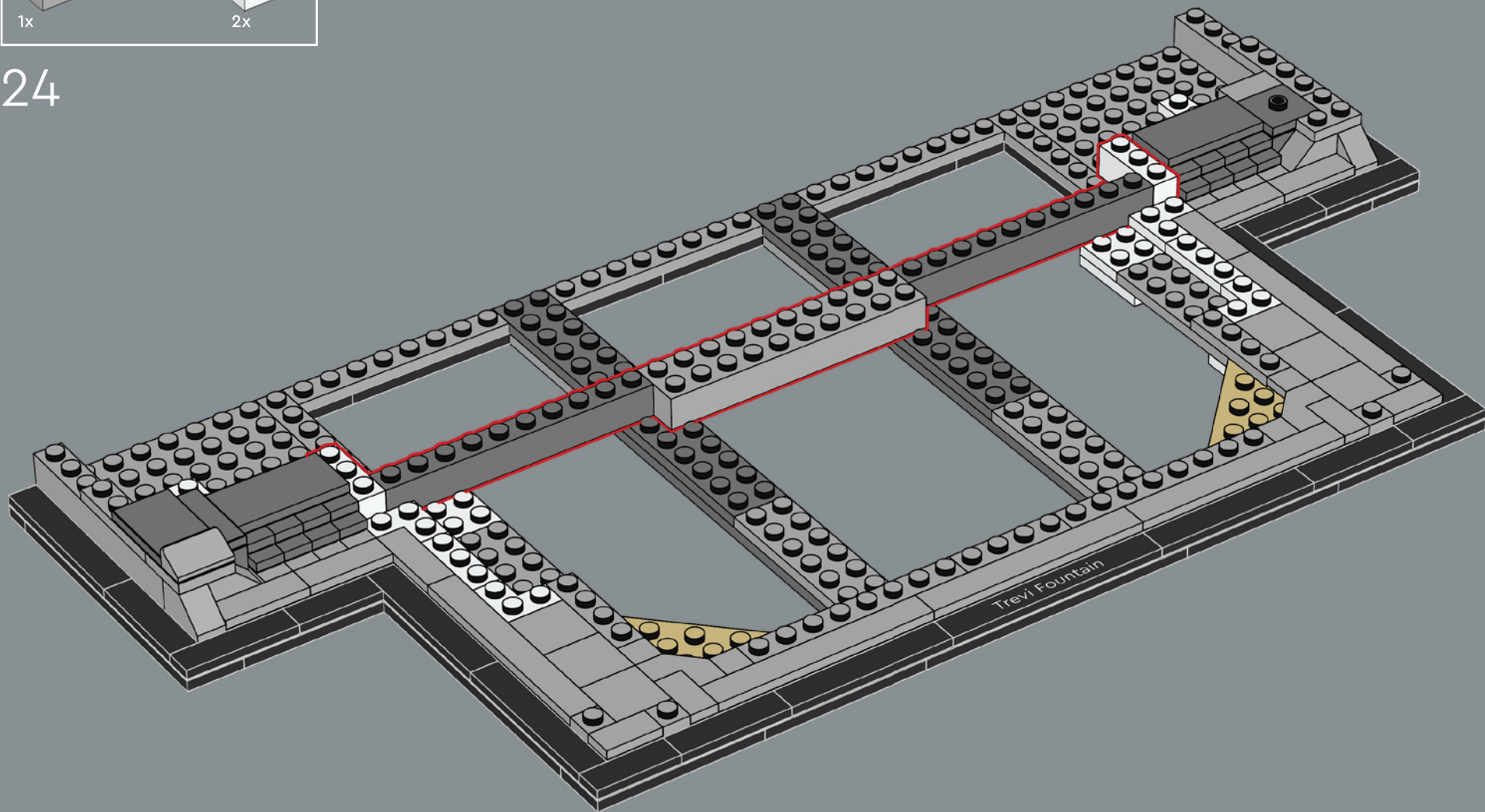

2x

25

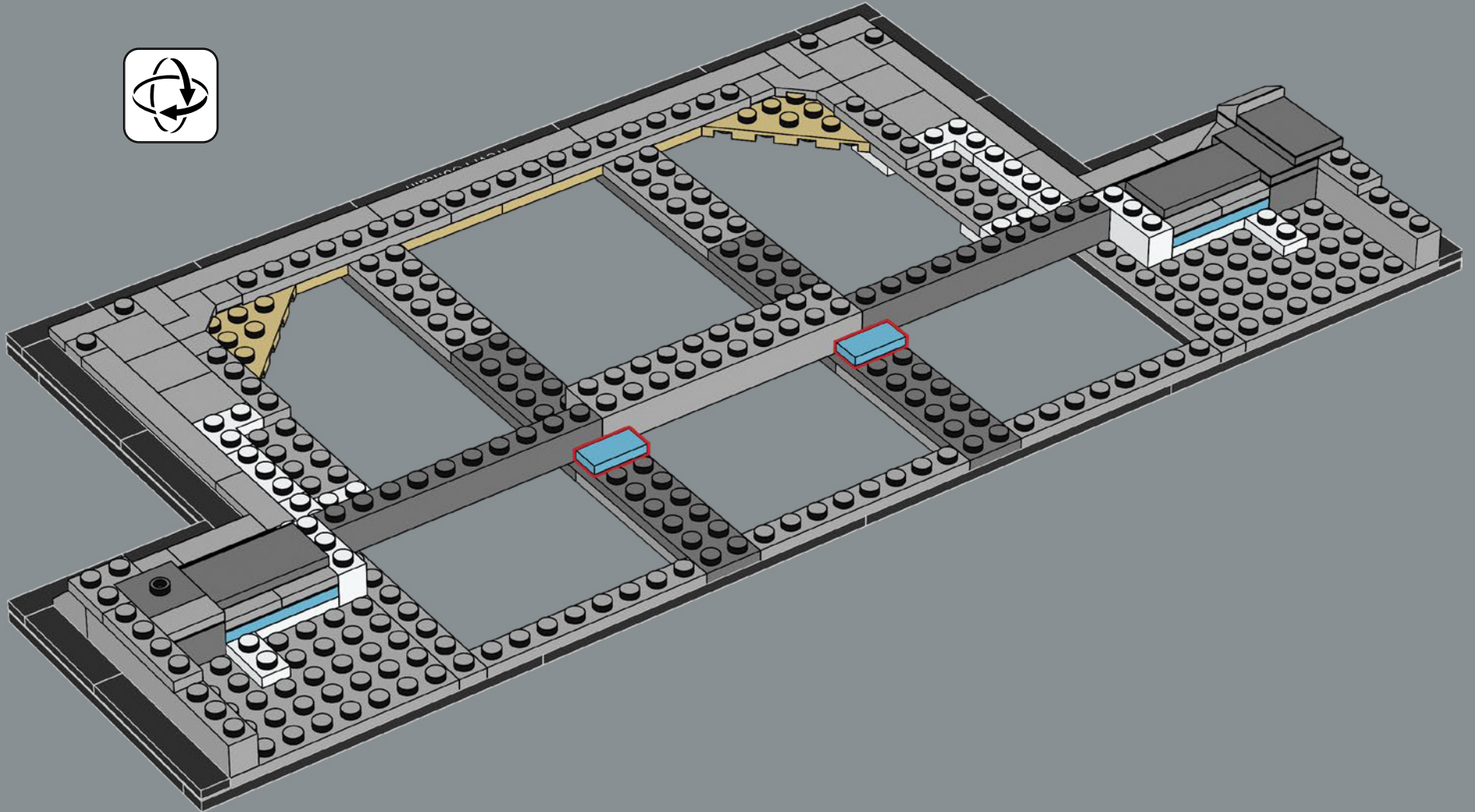

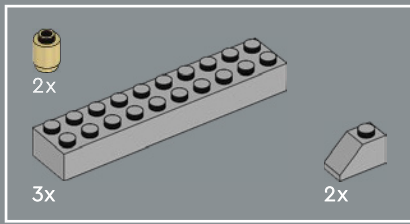

26

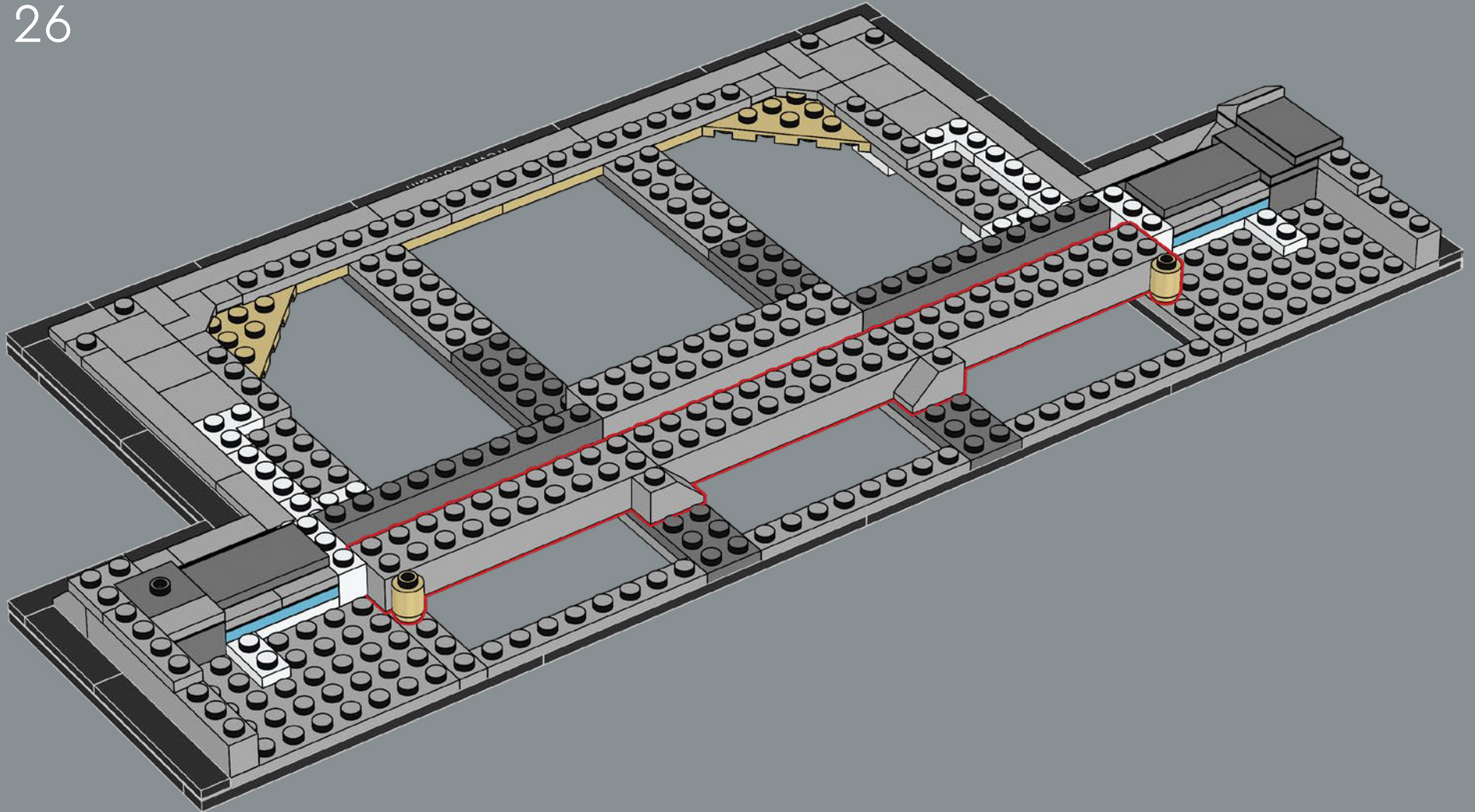

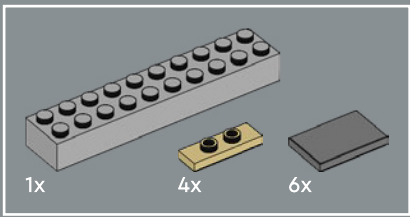

27

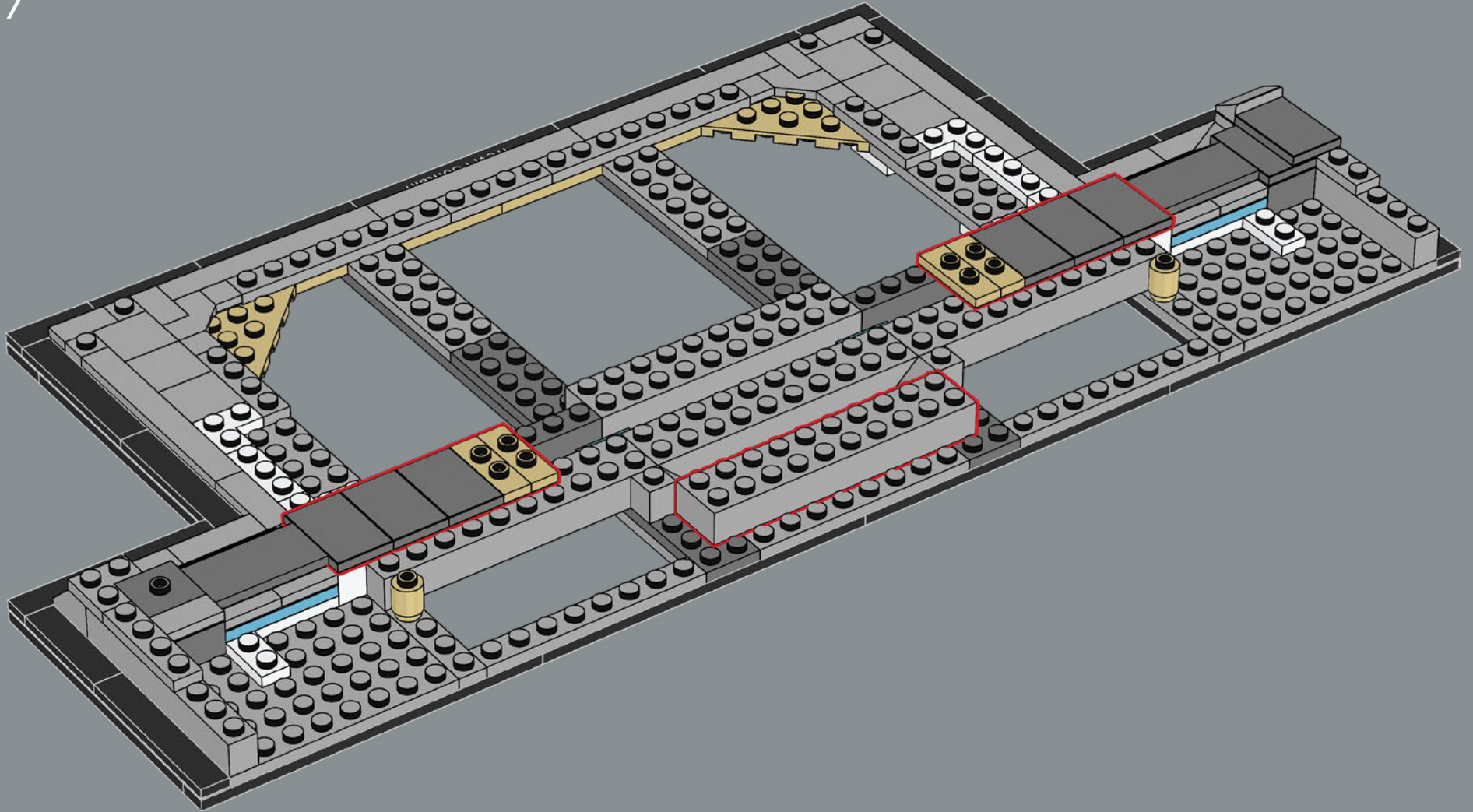



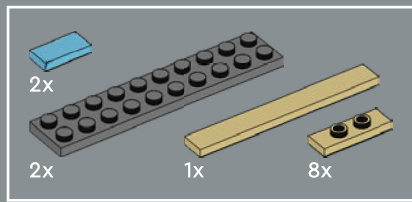

28

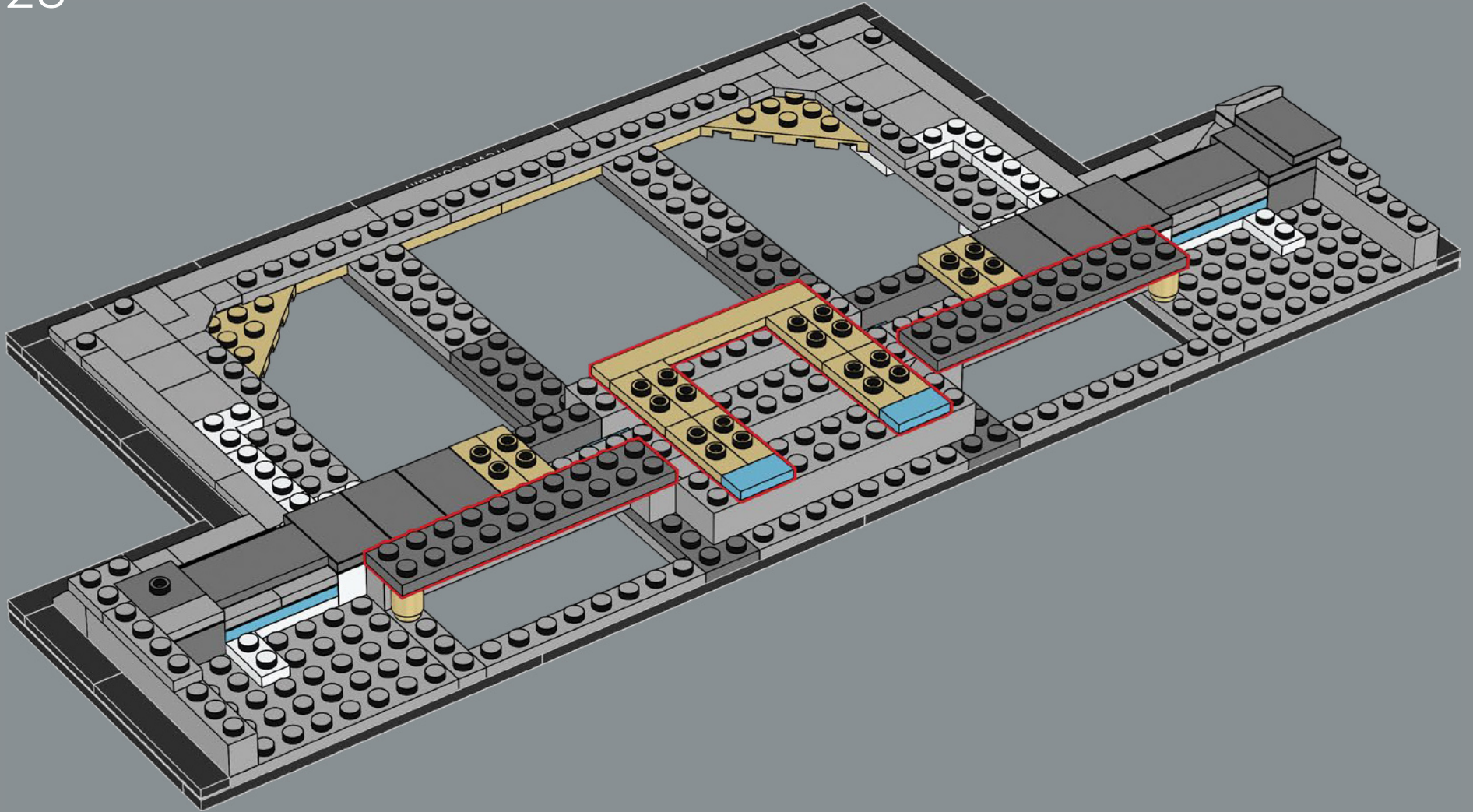

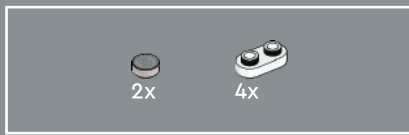

Una leggenda locale dice che chi getta una moneta nella fontana tornerà a Roma. Due monete e ti innamorerai di una persona che incontrerai alla fontana, e se offri tre monete, potreste stare insieme per sempre!

29

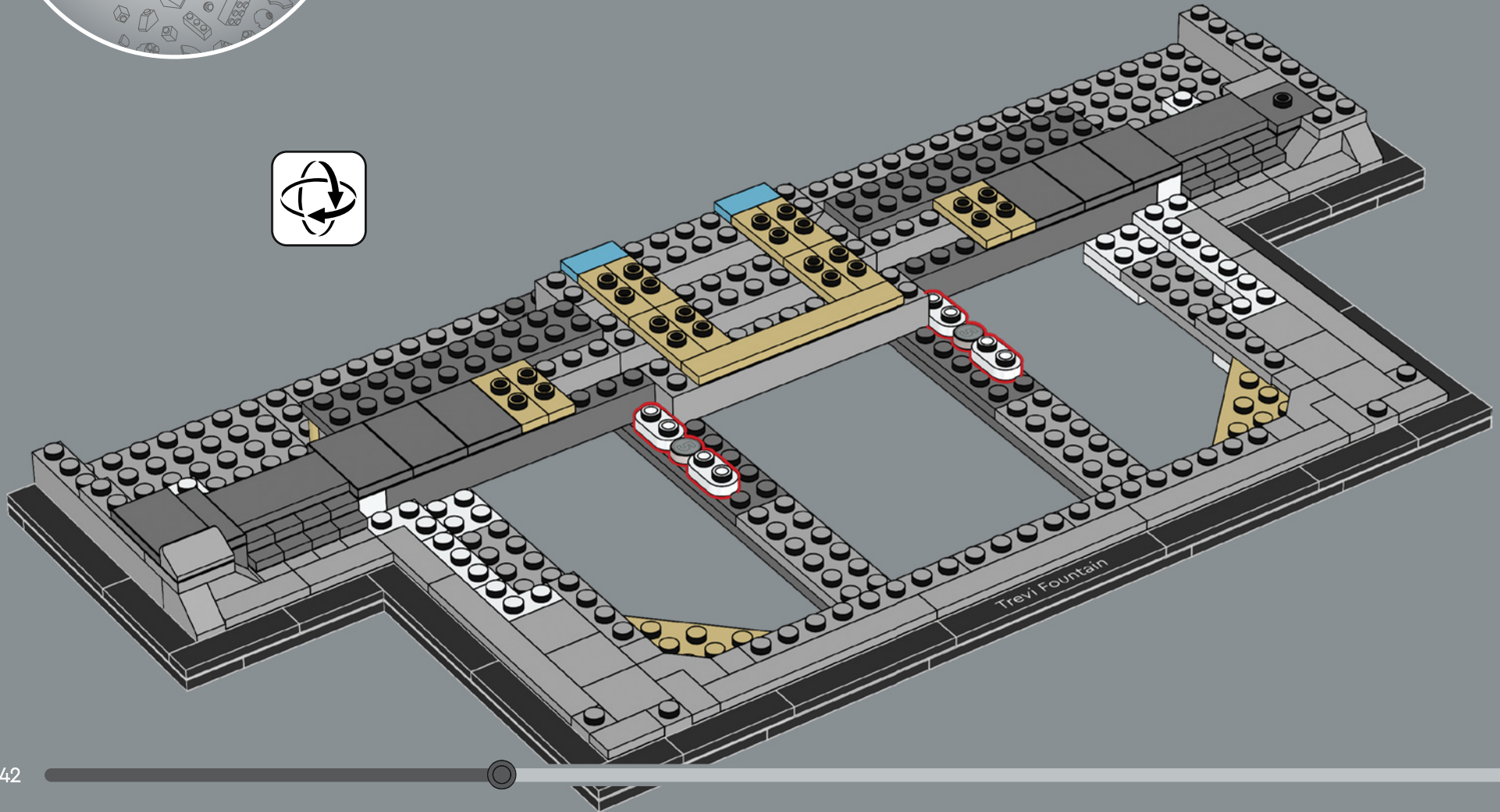

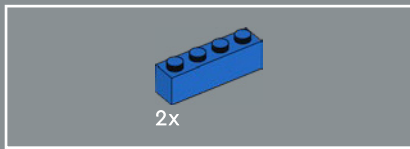

30

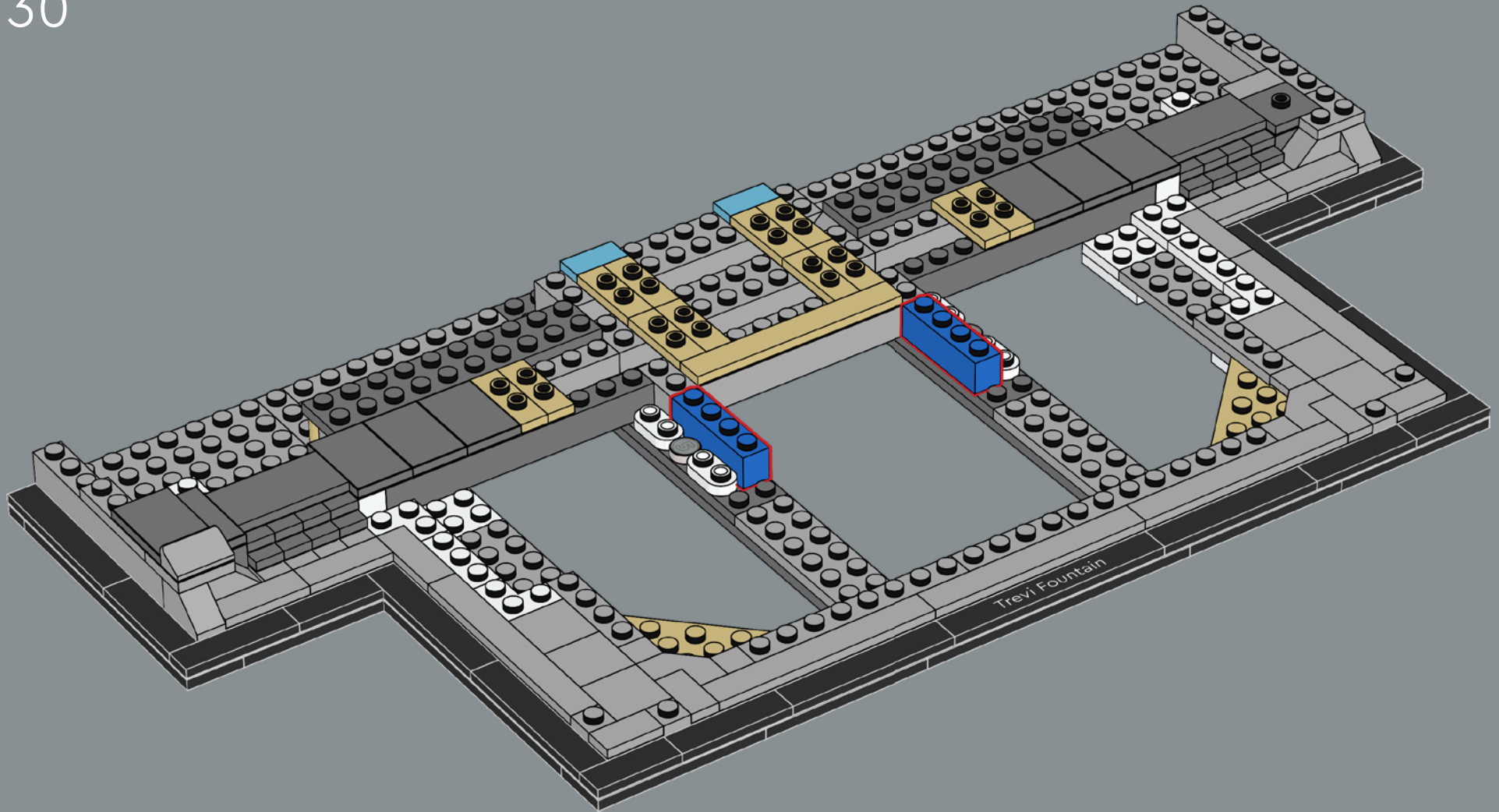

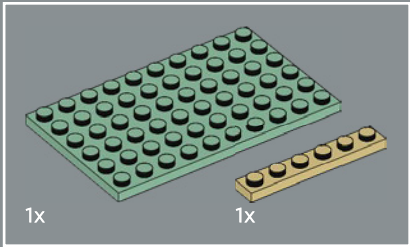
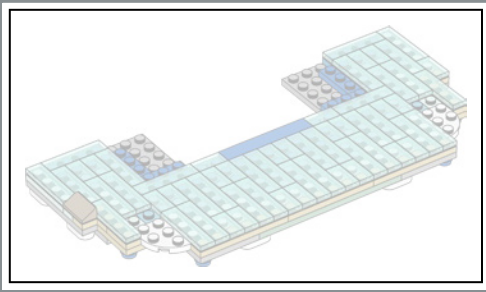

31

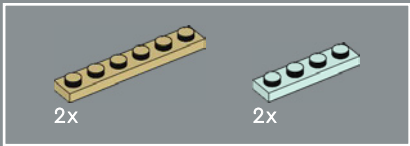
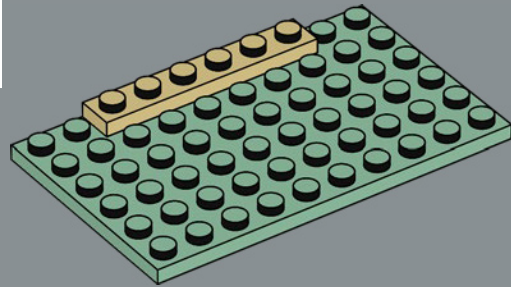

32

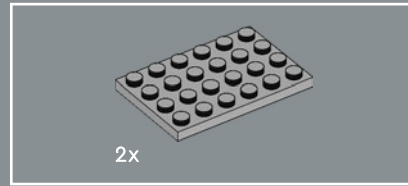
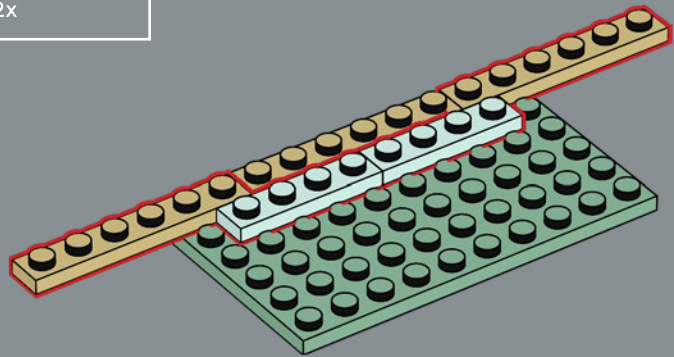

33

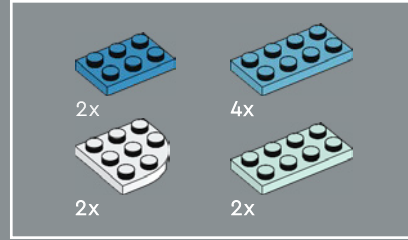
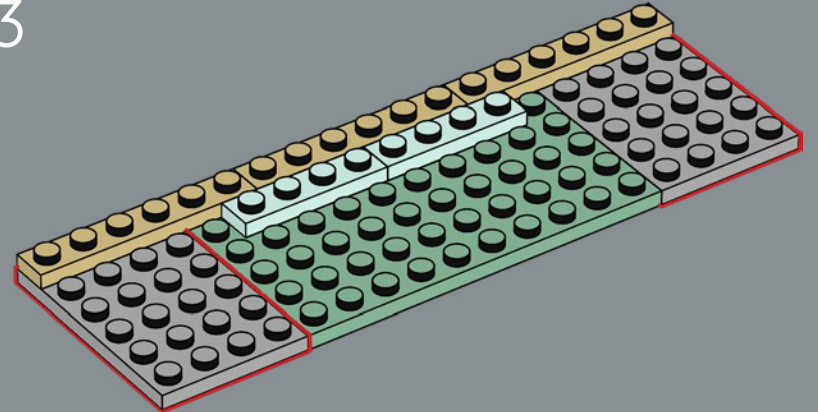

34

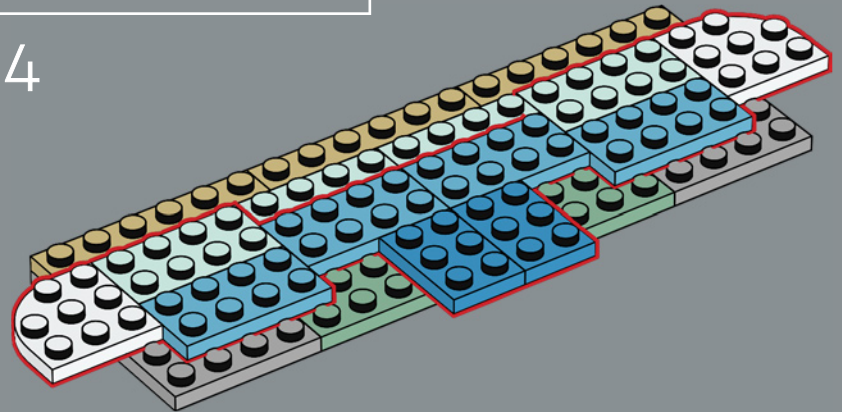

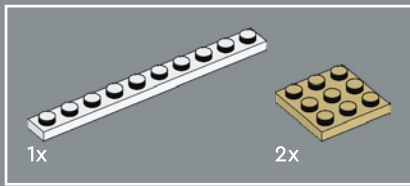

35

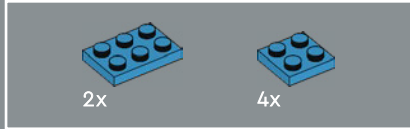
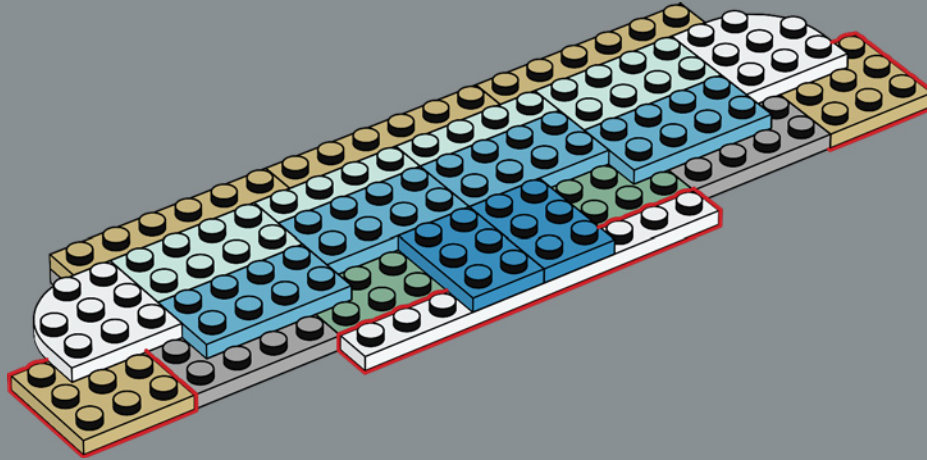

36

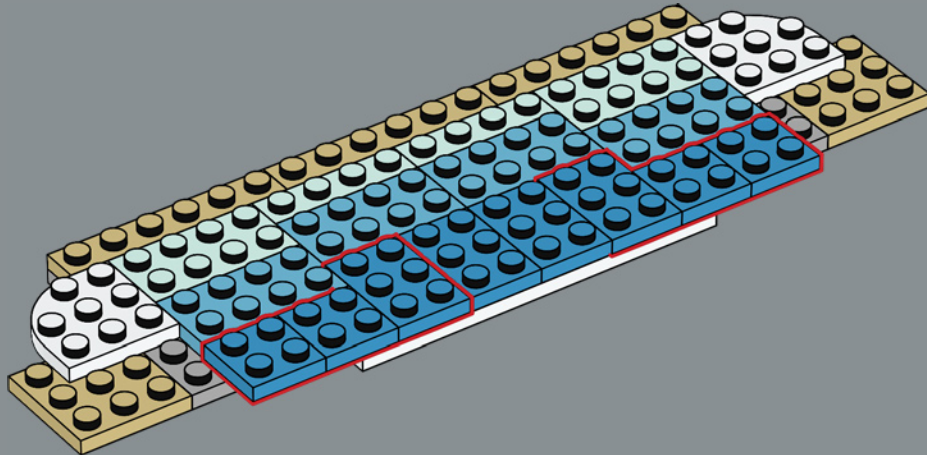

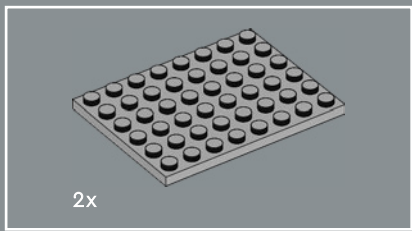

37

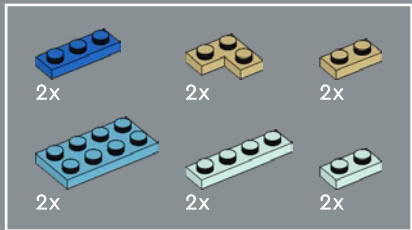
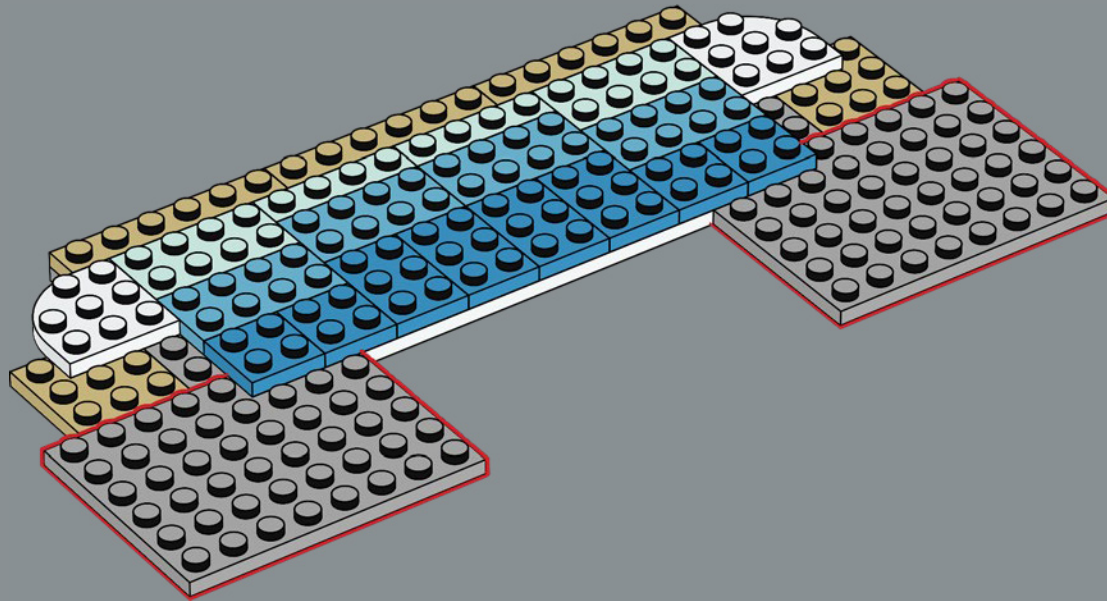

38

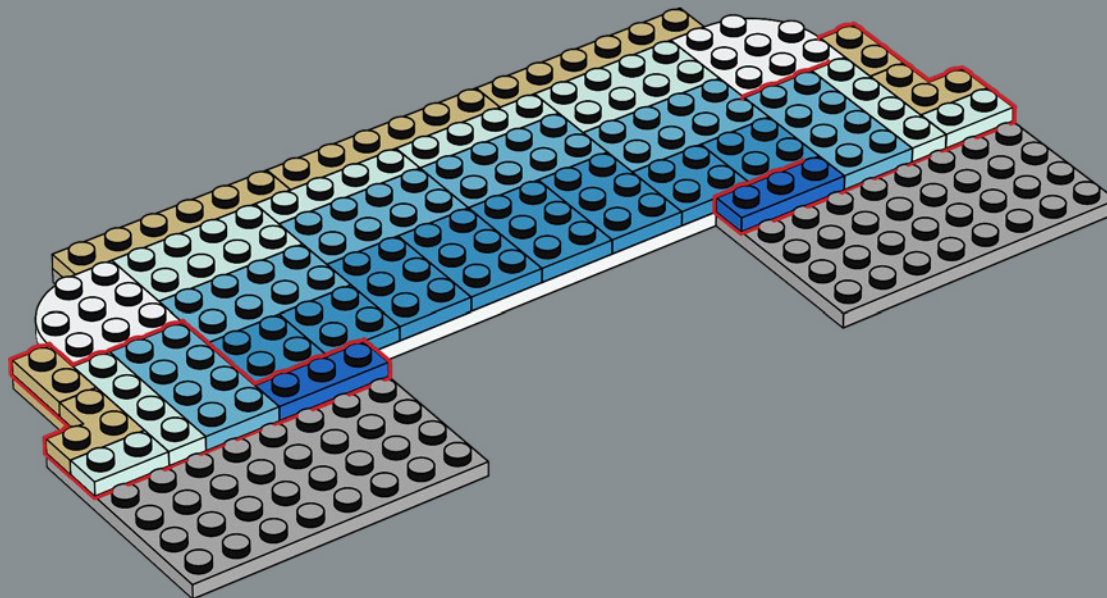

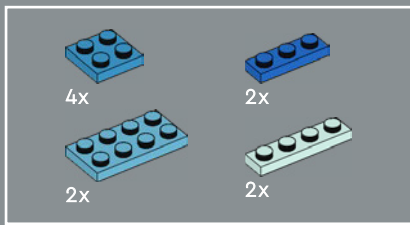

39

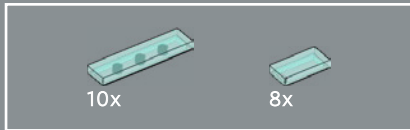
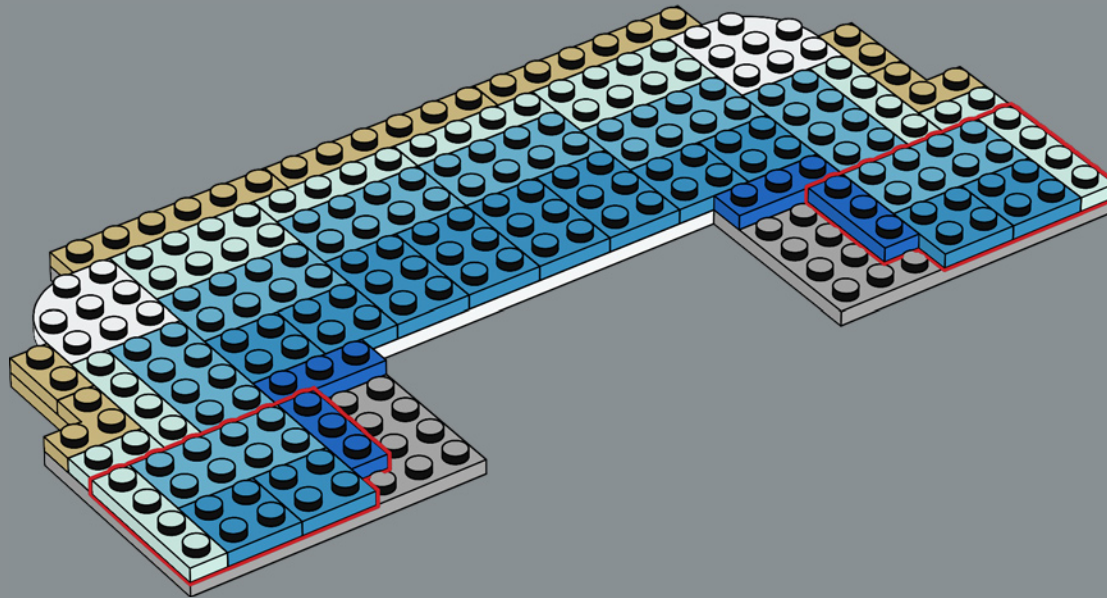

40

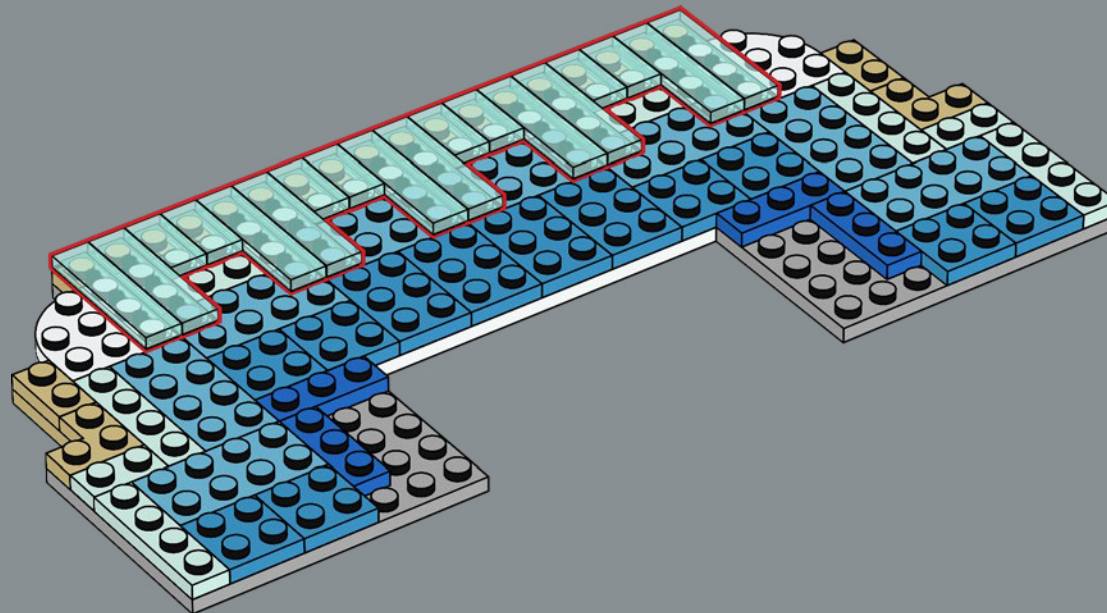

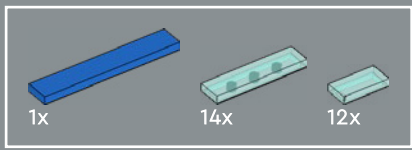

41

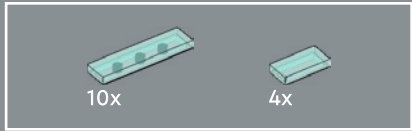
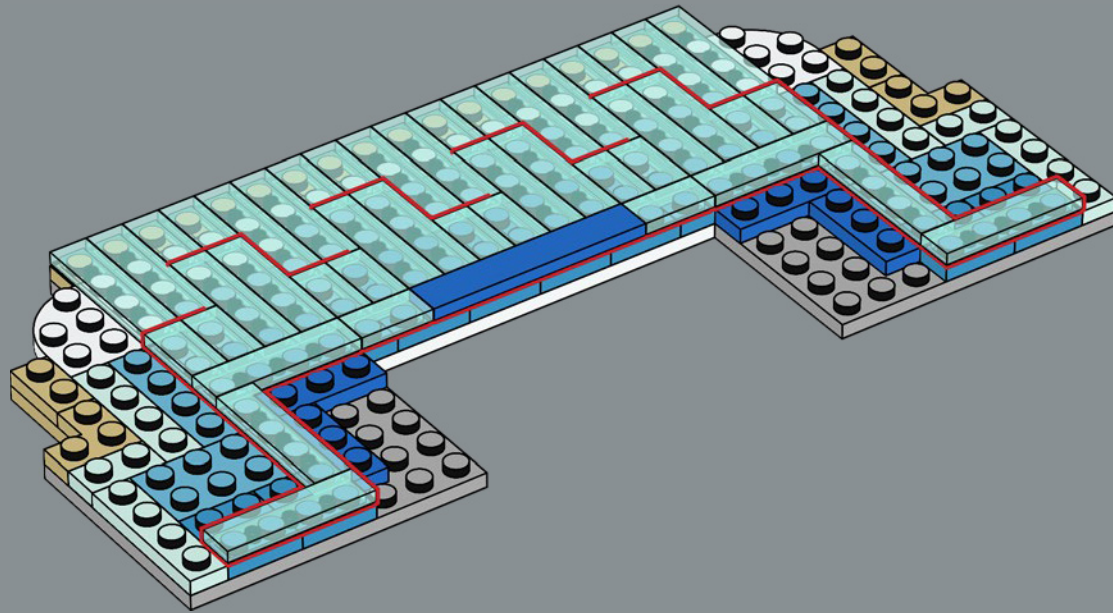

42

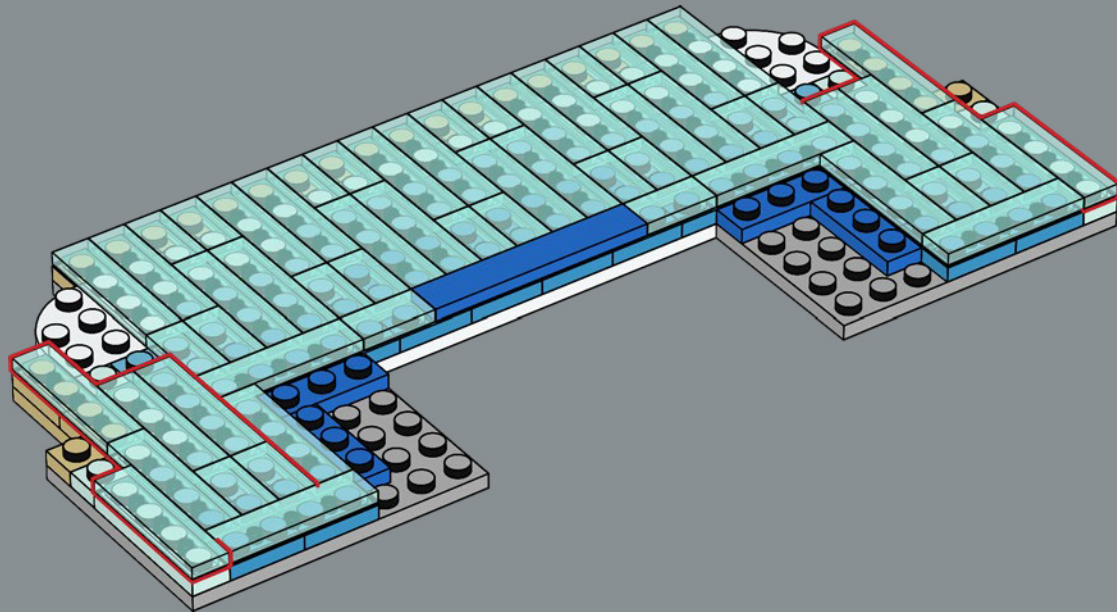



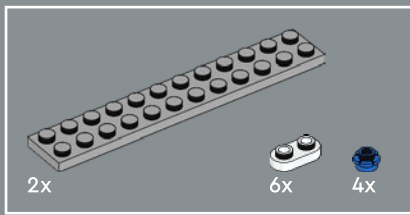

43

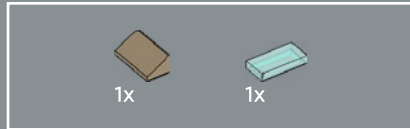
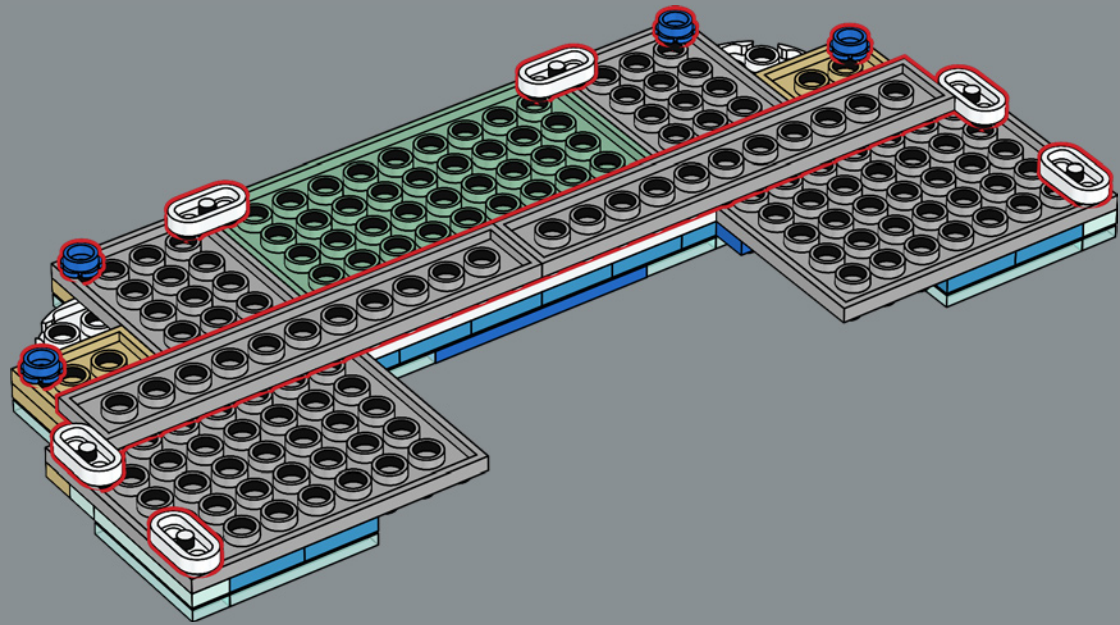

44

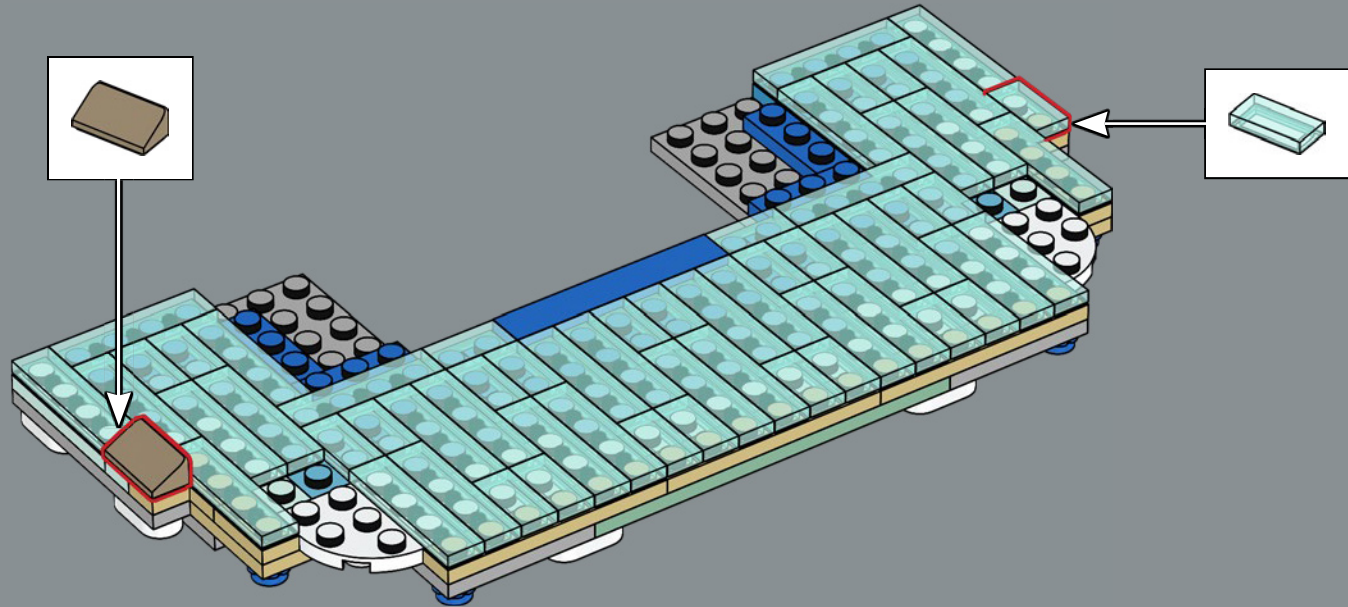

Ogni giorno nella fontana vengono gettate monete per un valore di circa 3.000€. Vengono raccolte alla fine della giornata e gran parte viene donata in beneficenza.

45

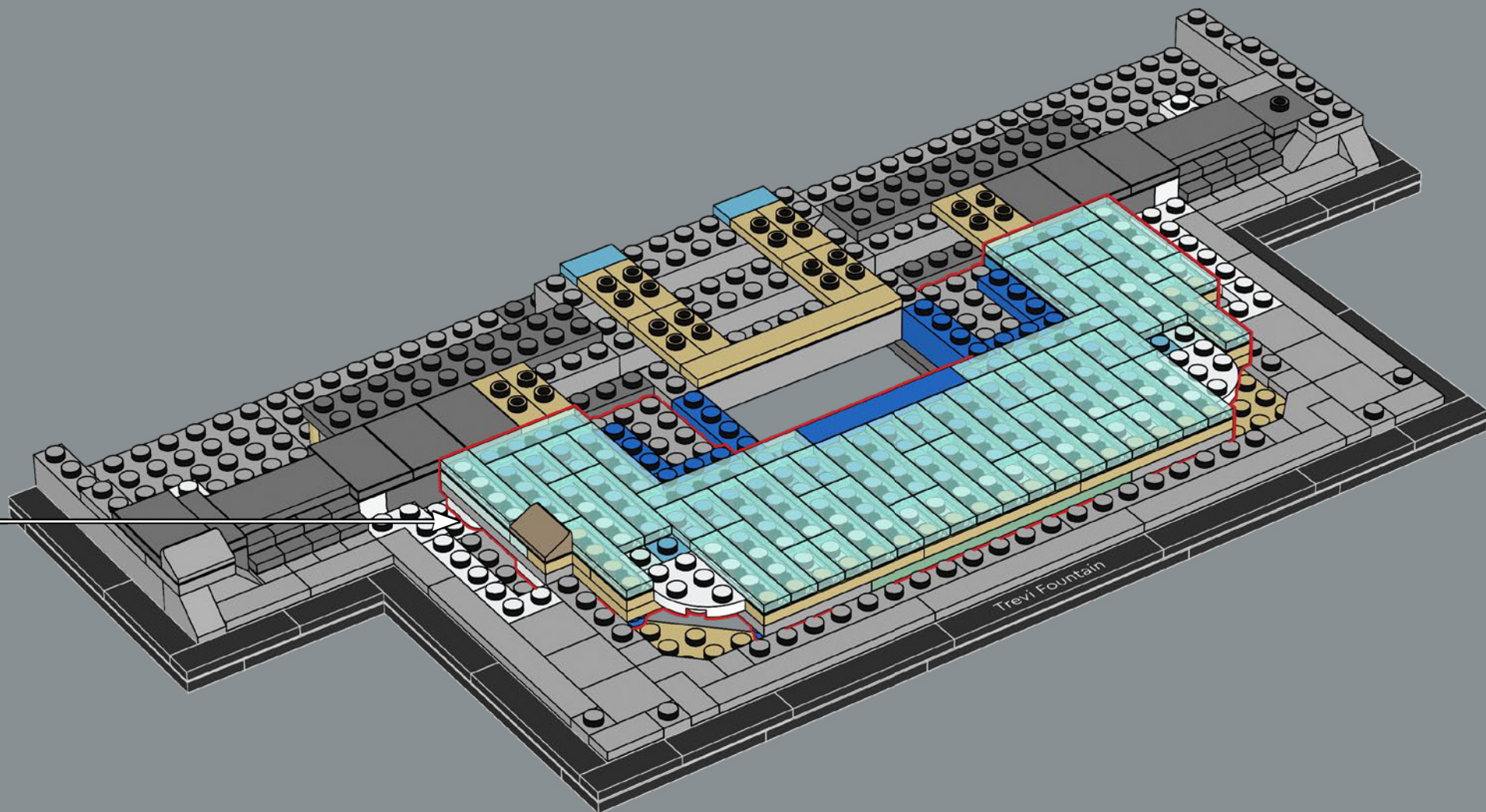



46

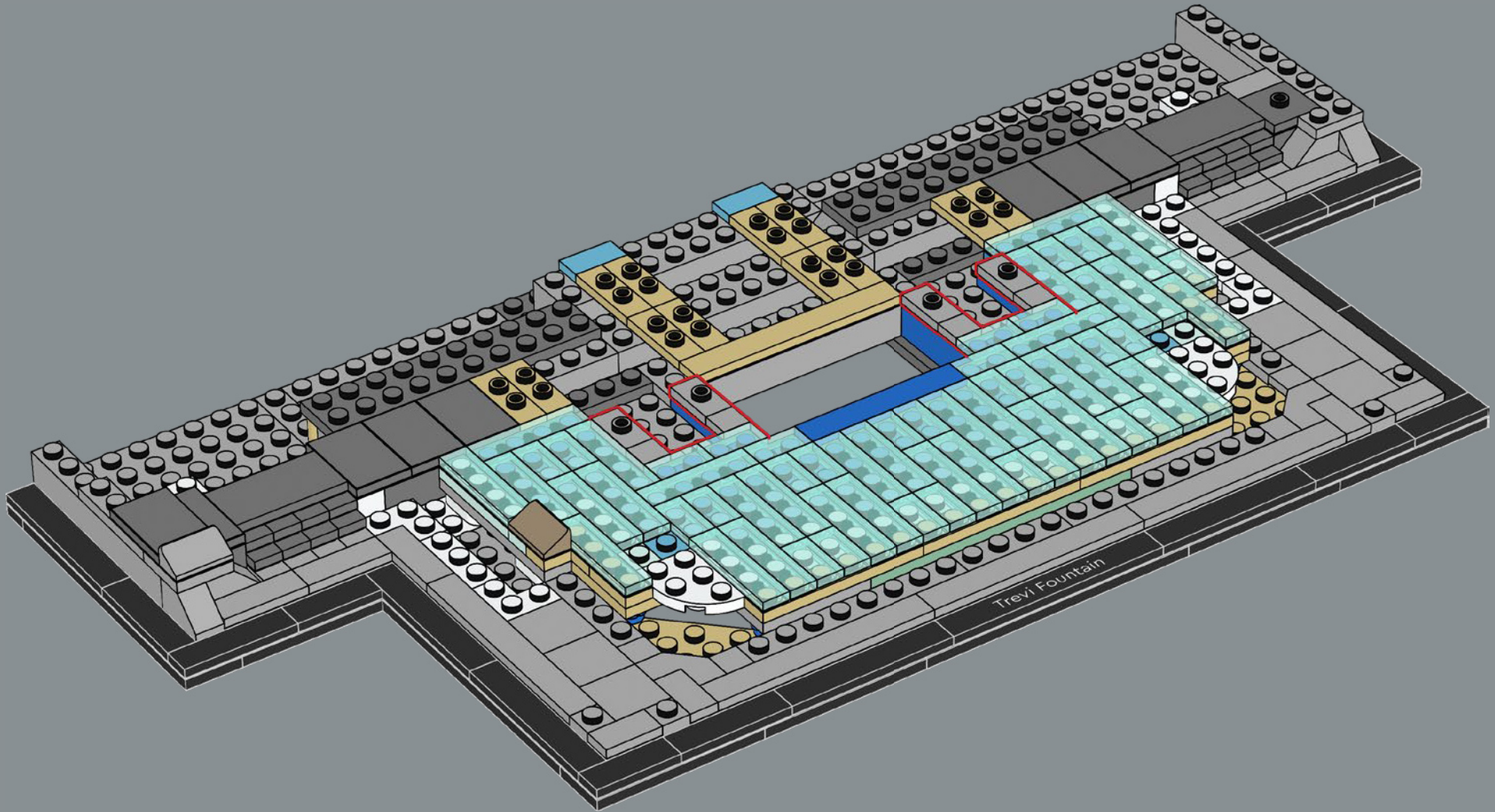

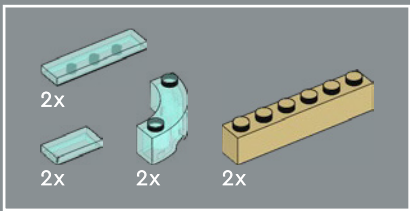

47

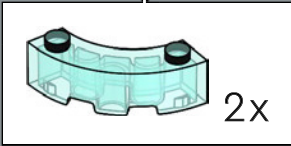
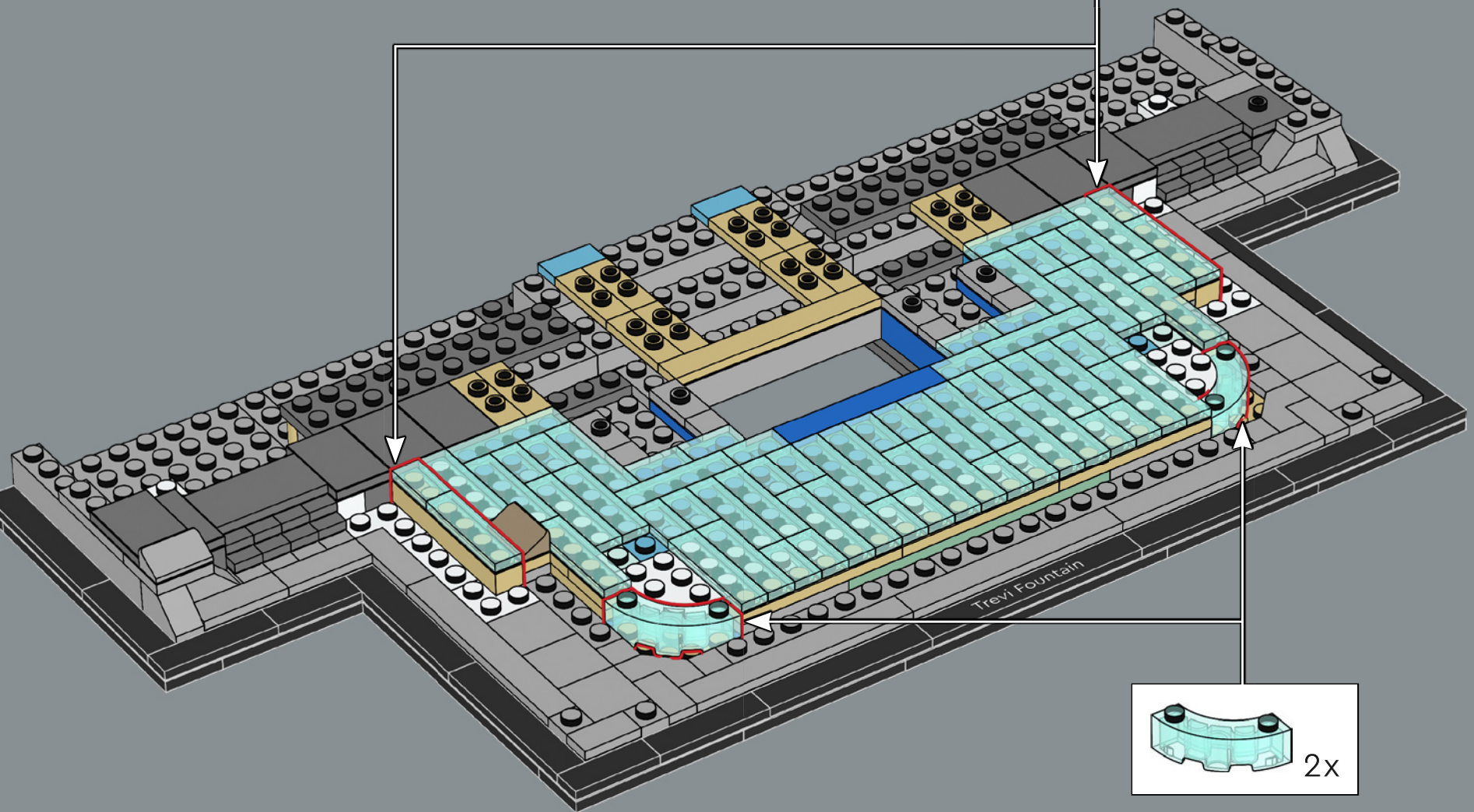
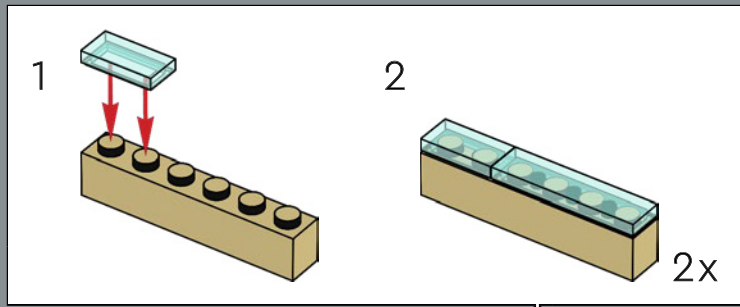

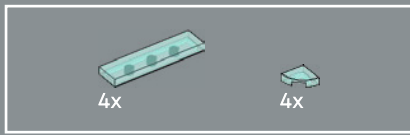

48

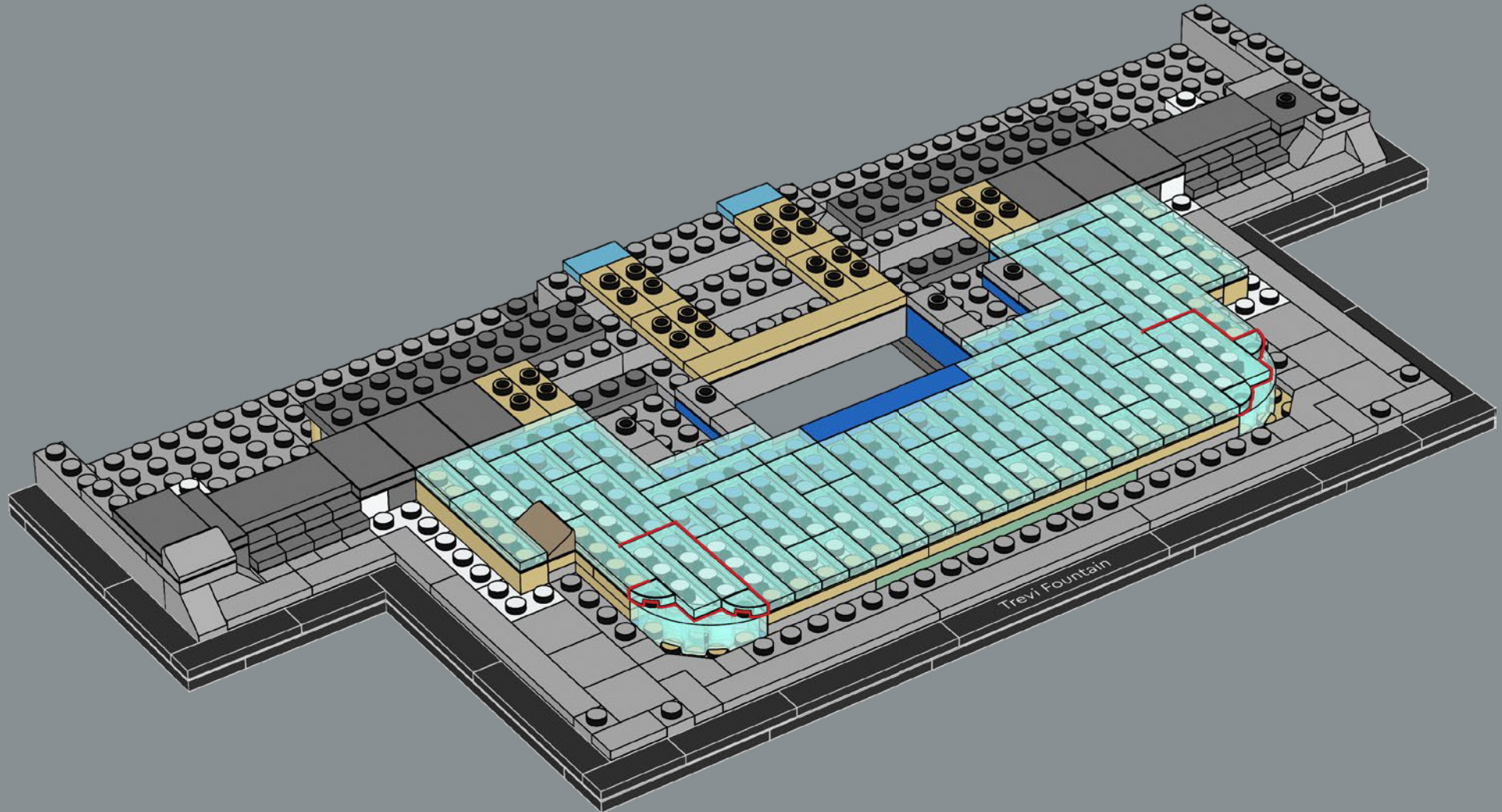

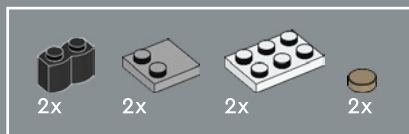

49

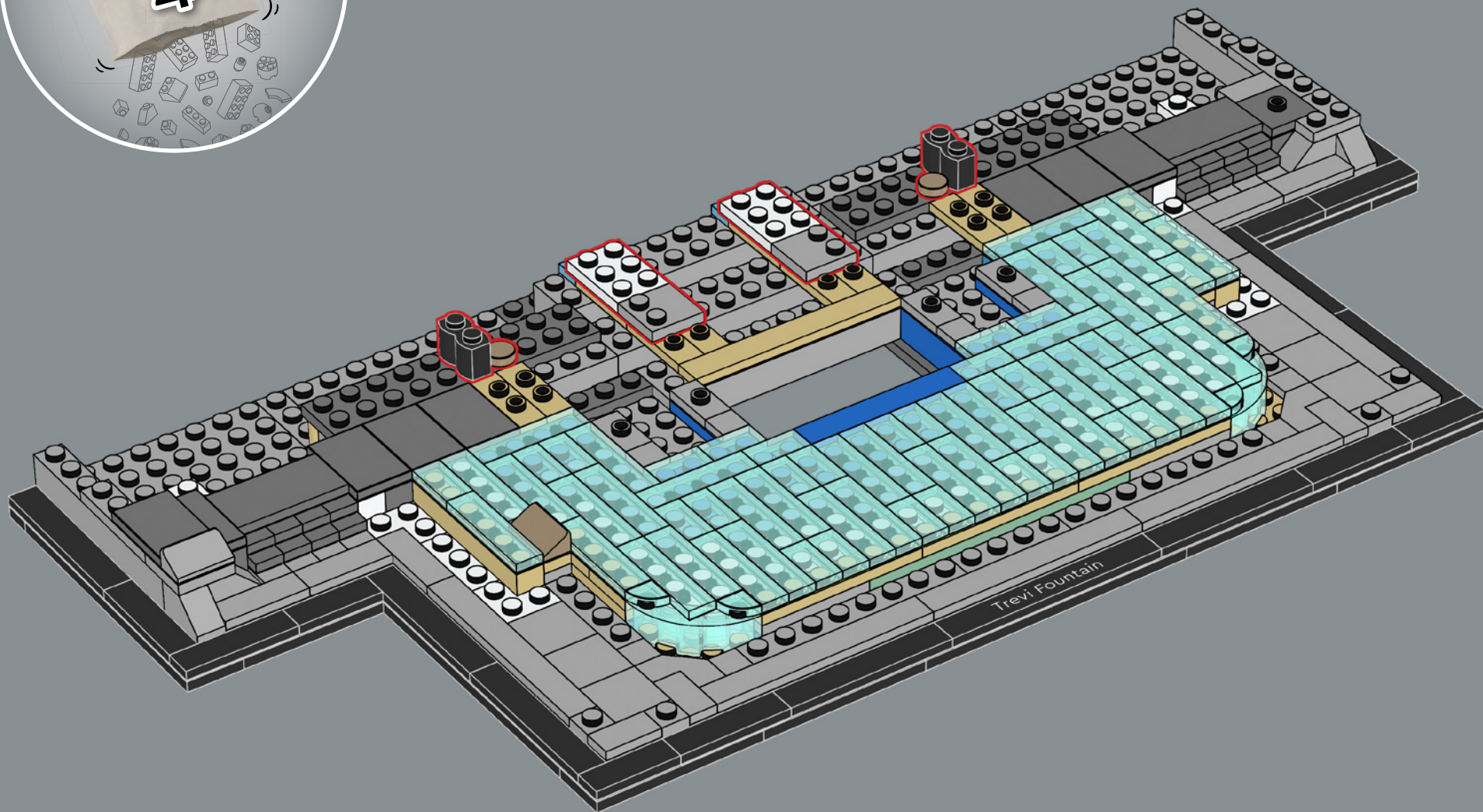

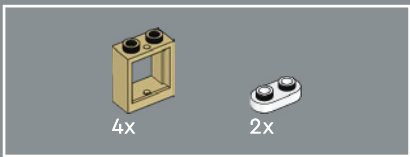

50

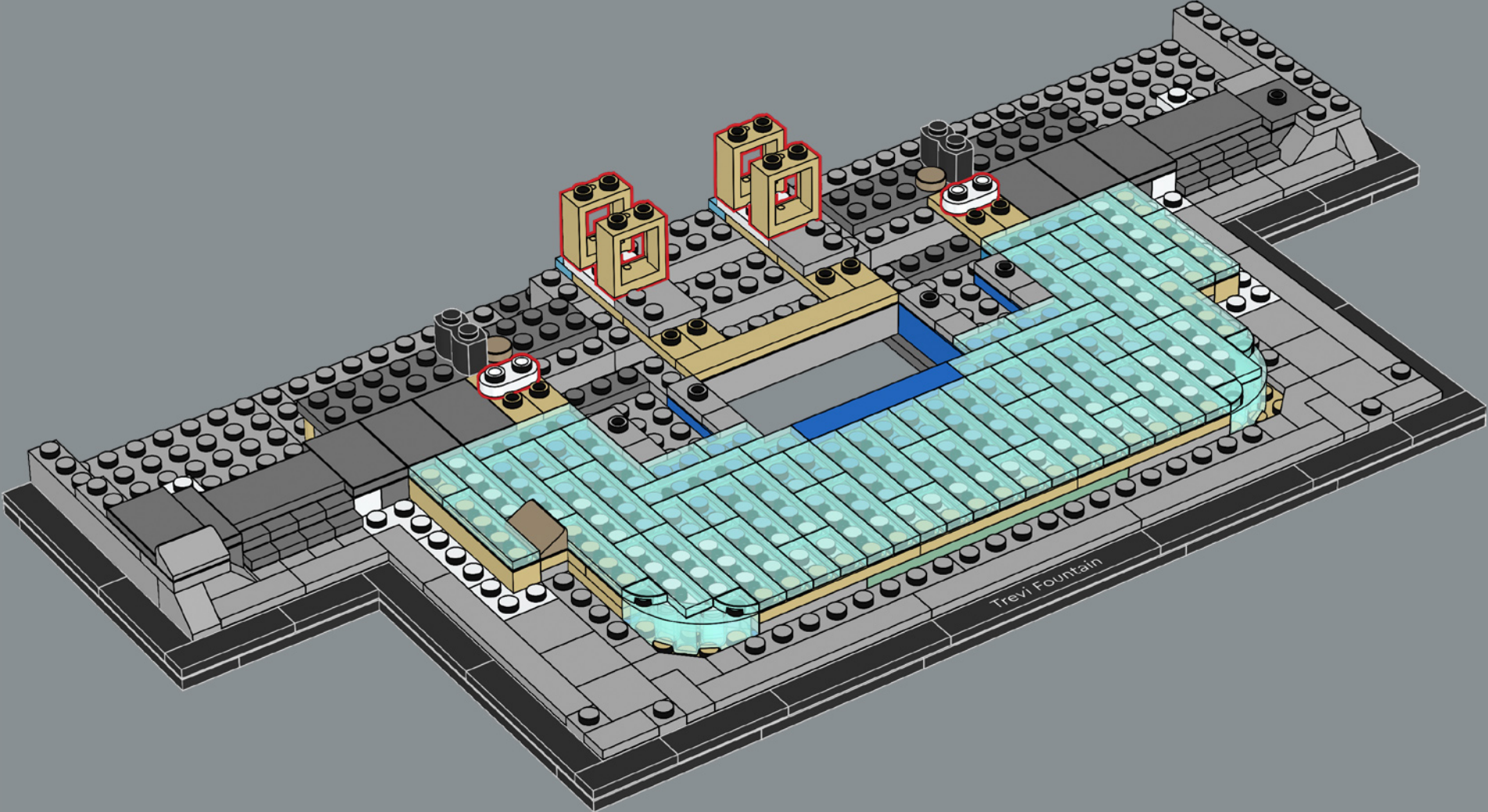

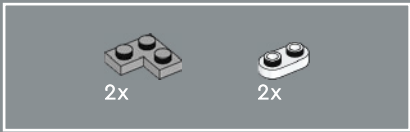

51

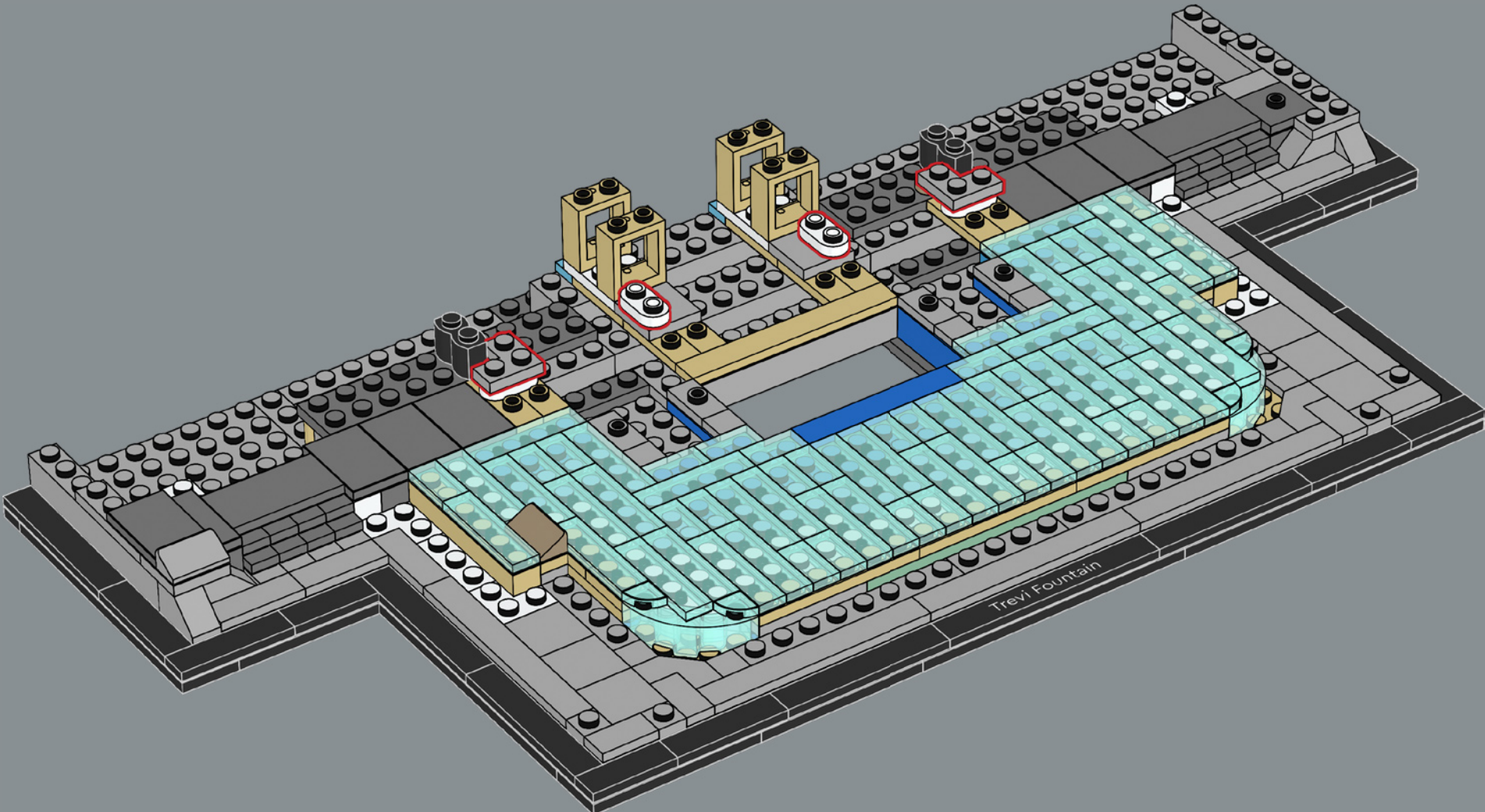



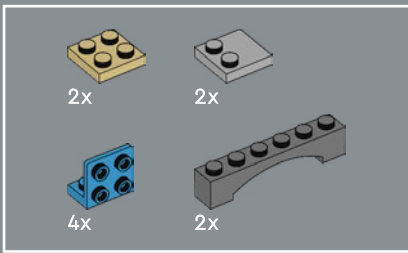

52

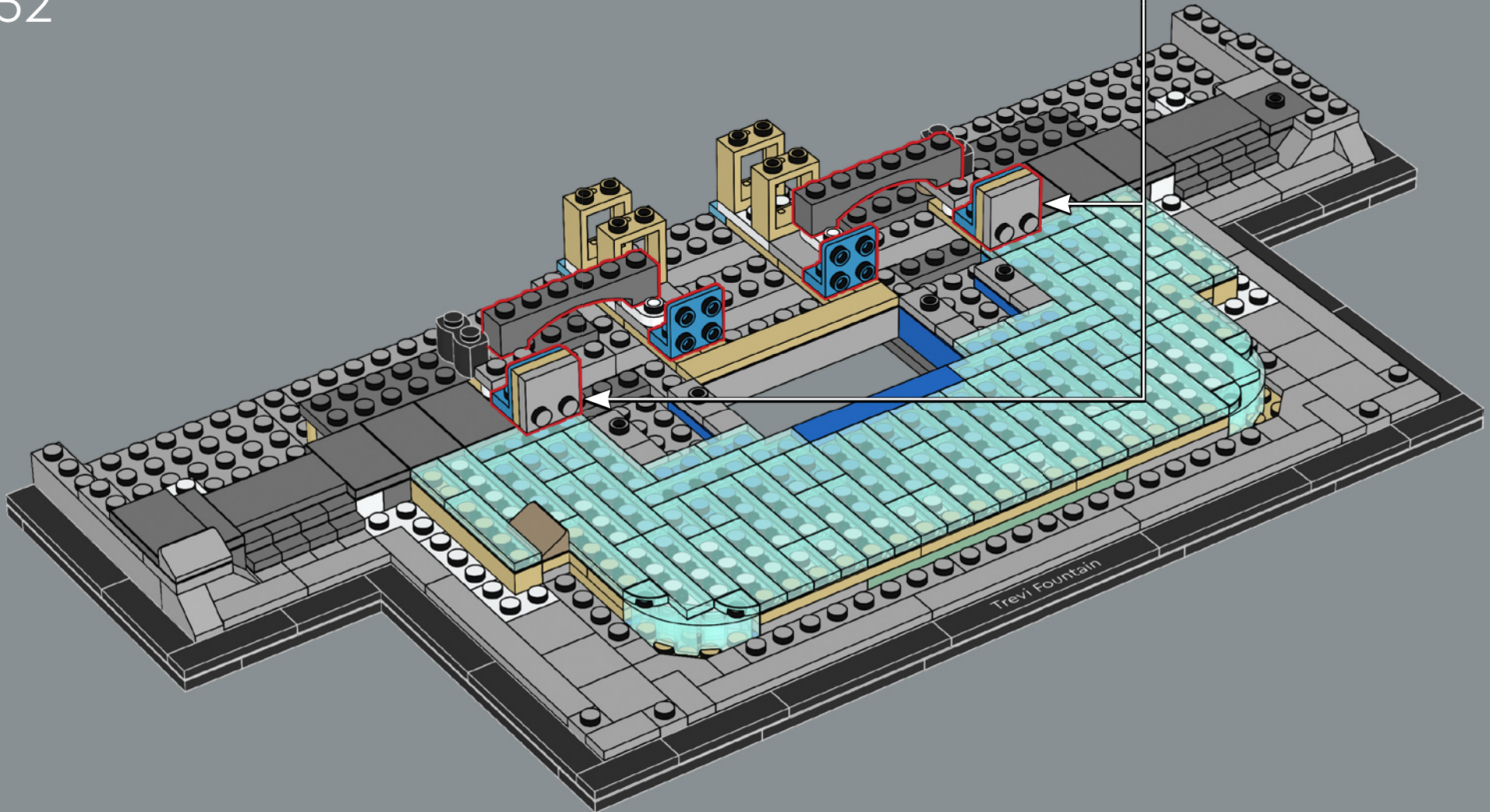
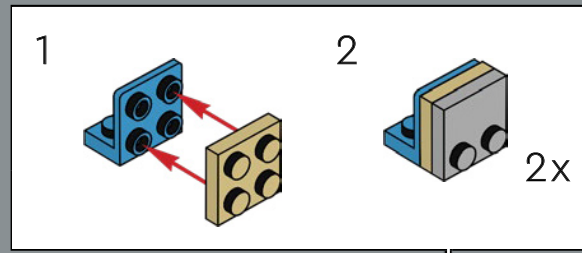

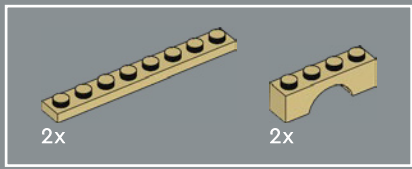

53

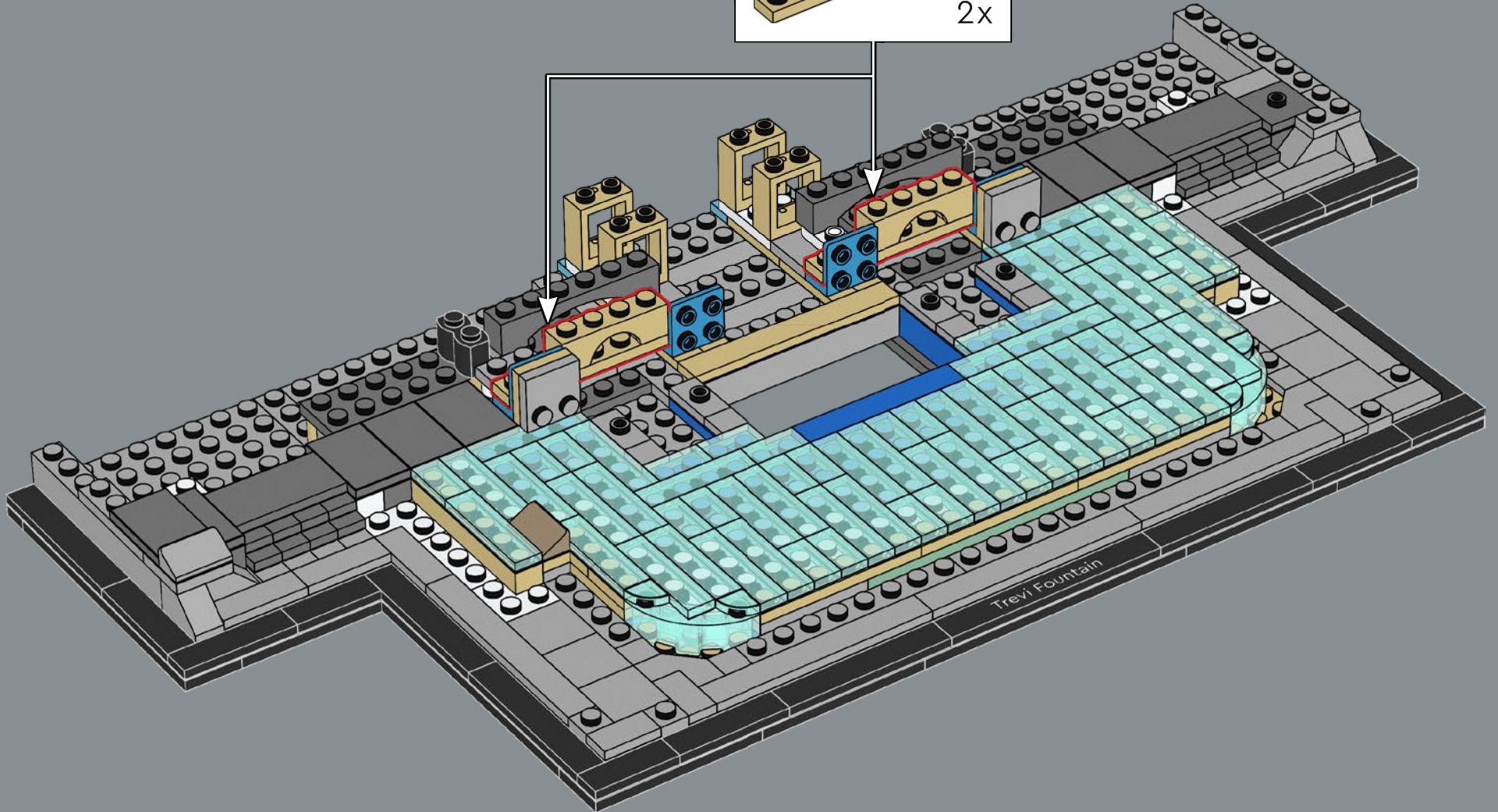
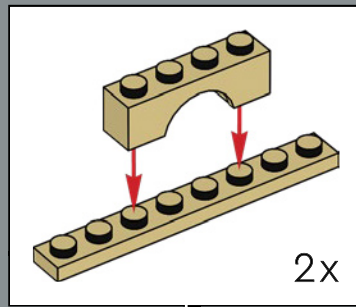

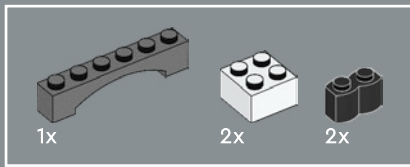

54

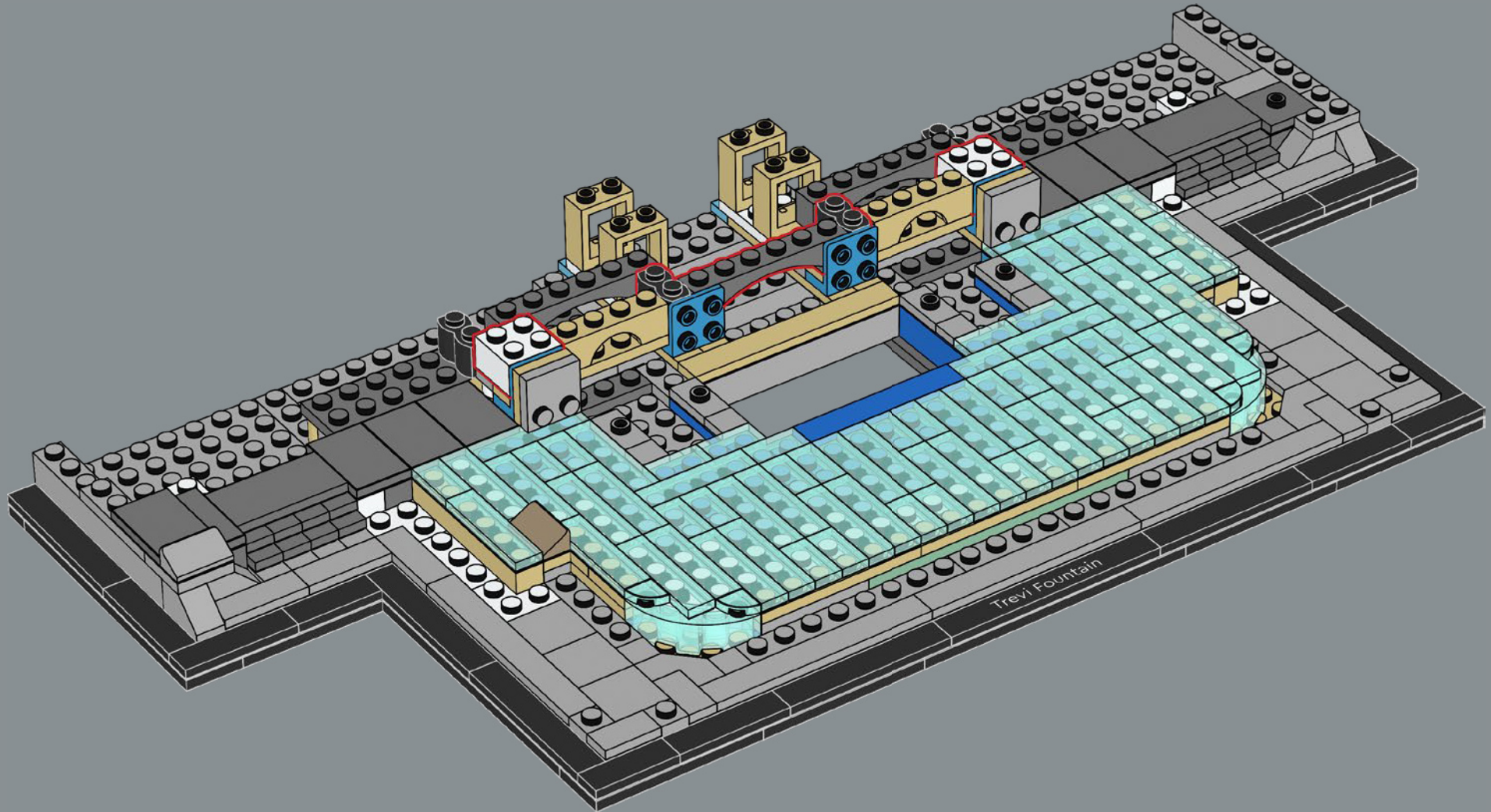

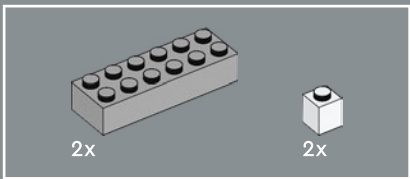

55

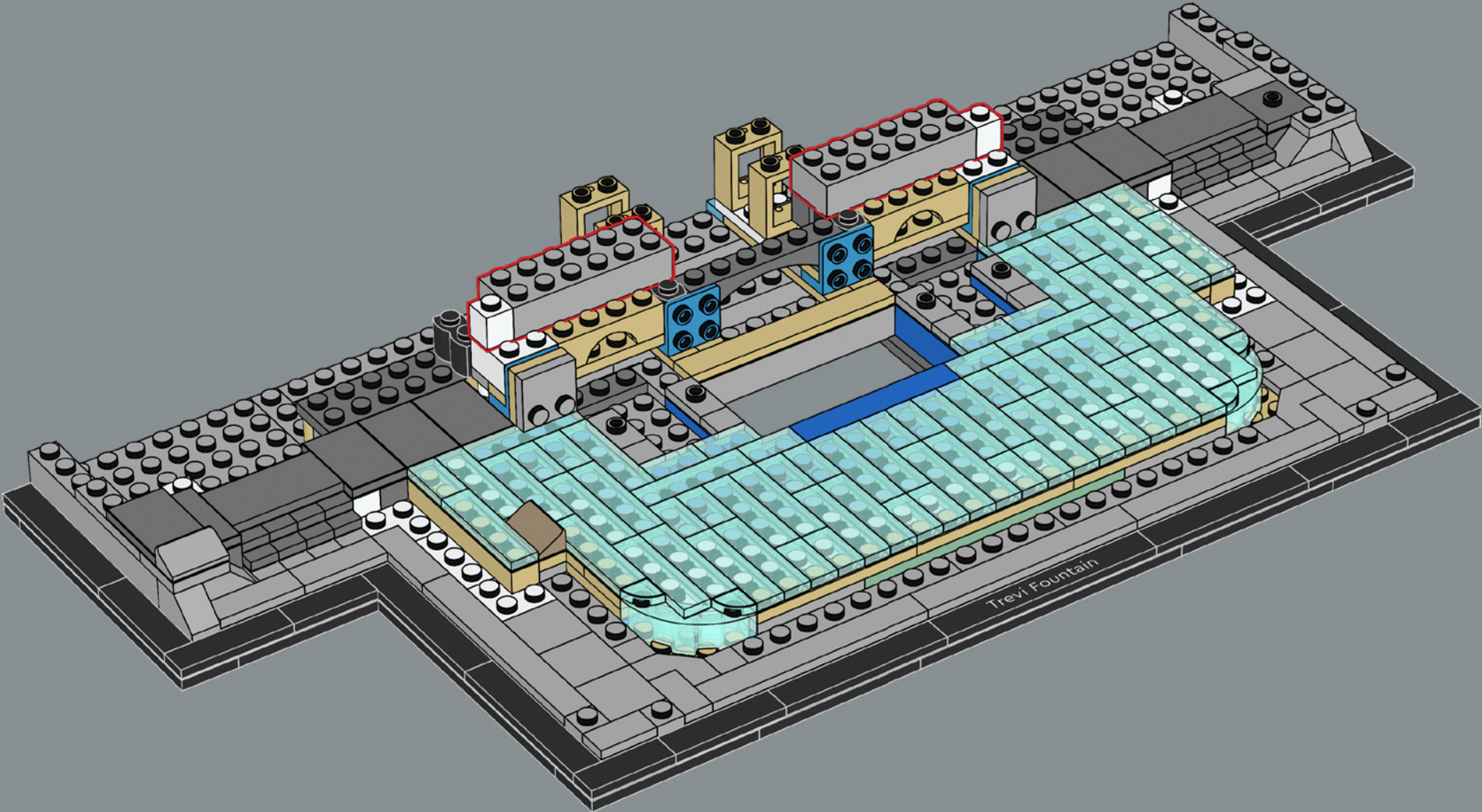

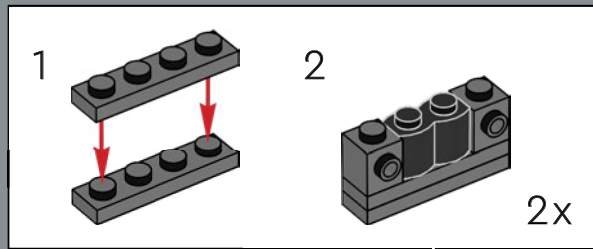
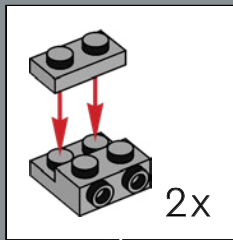
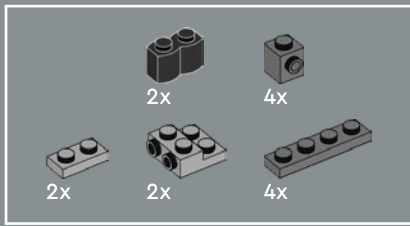

56

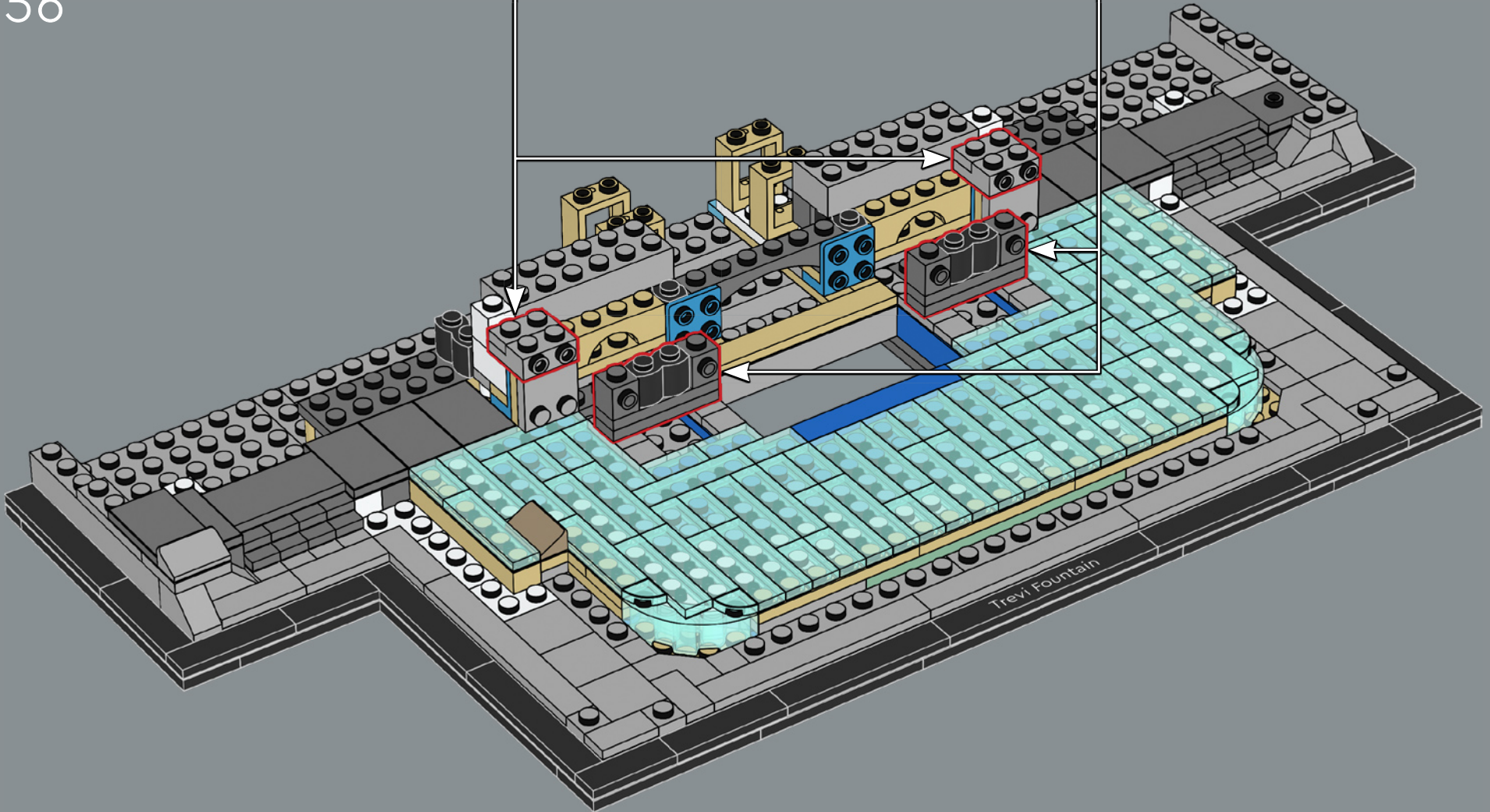

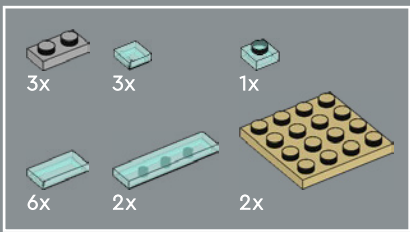

57

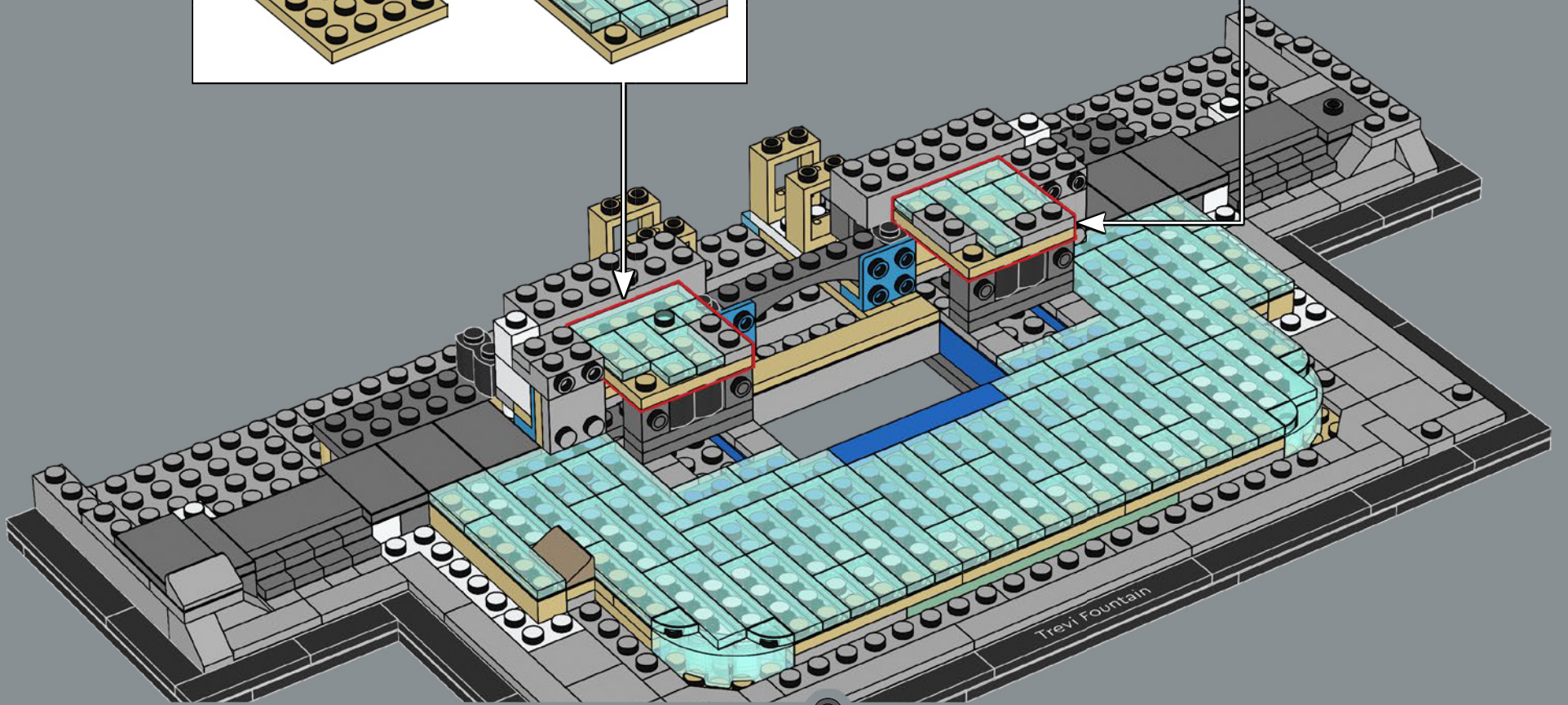
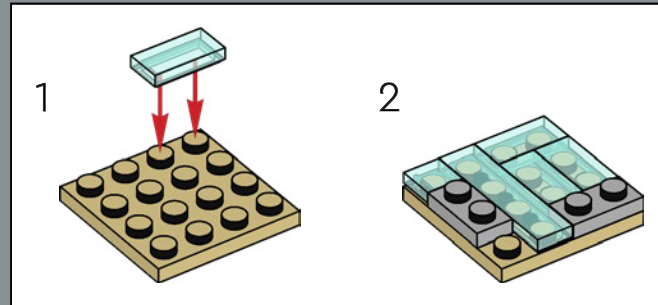
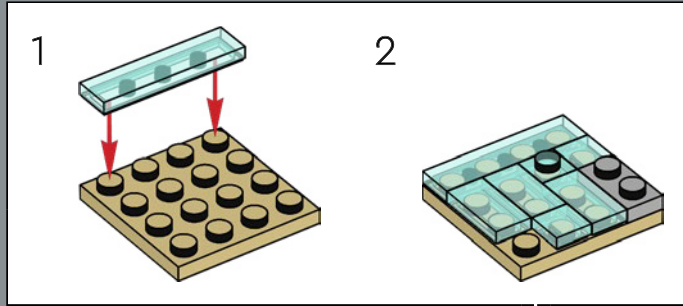

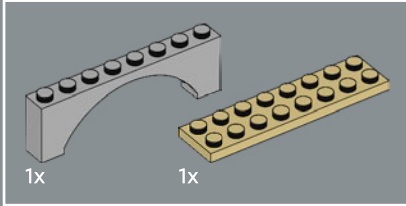
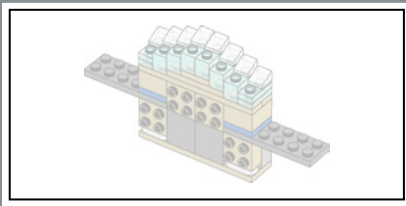

58

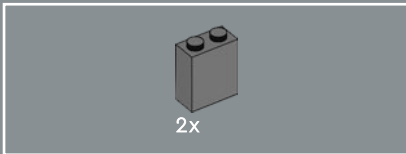
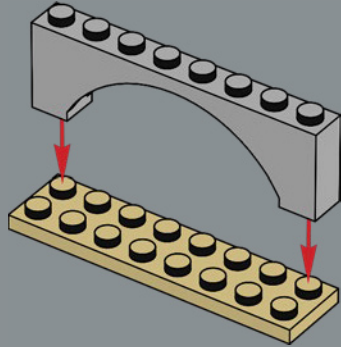

59

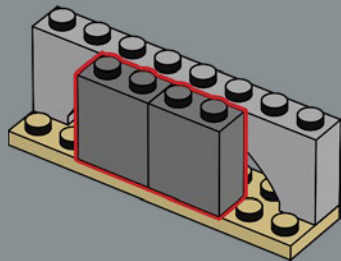

60

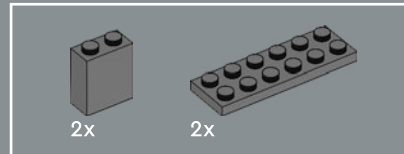
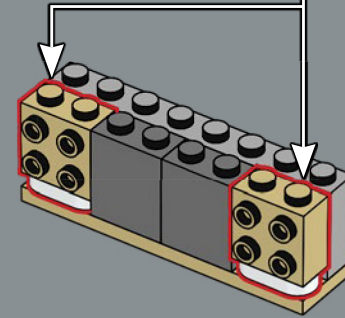
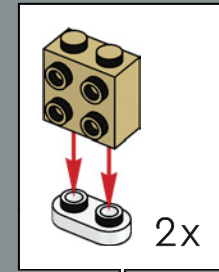

61

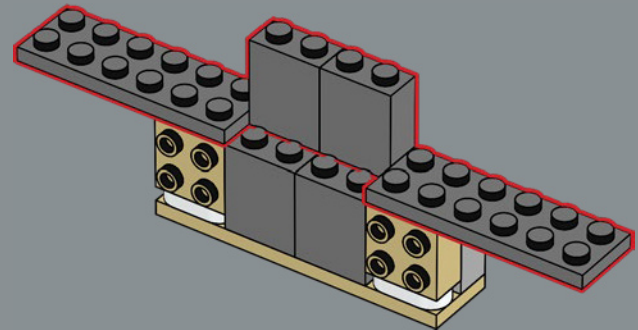

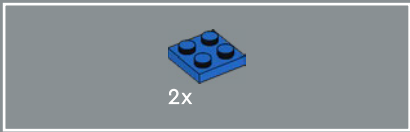

62

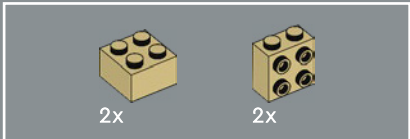
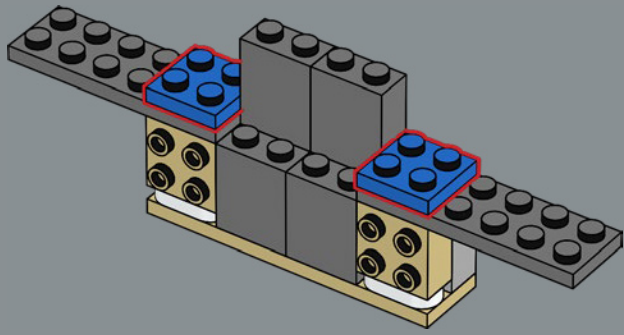

63

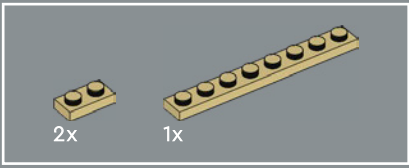
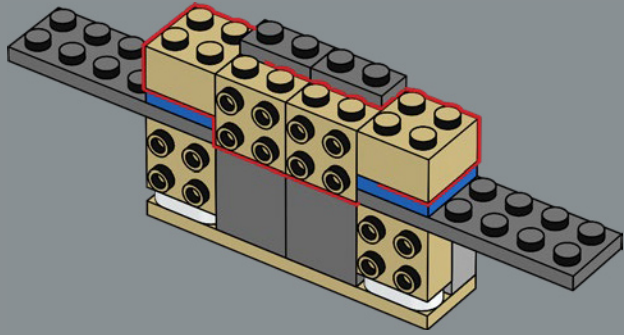

64

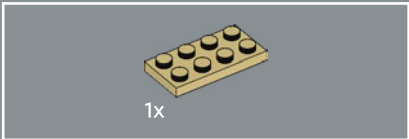
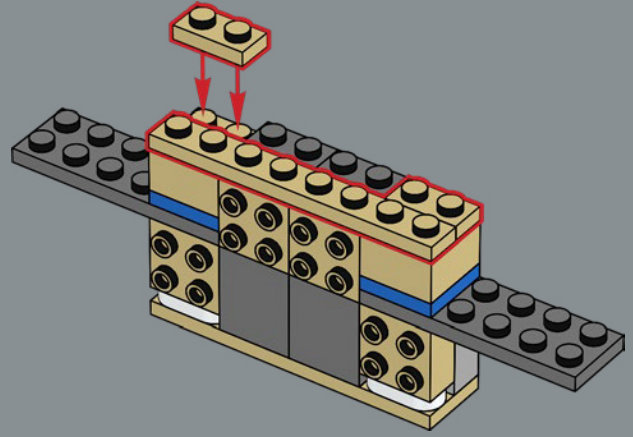

65

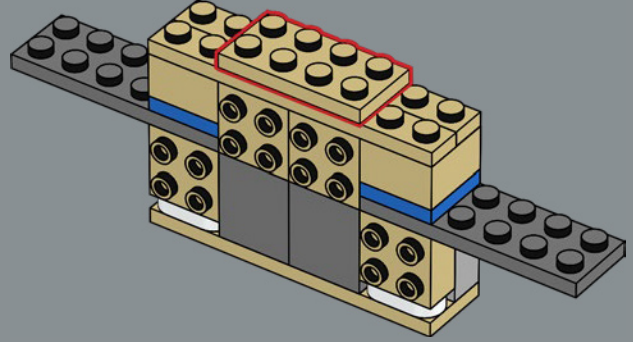



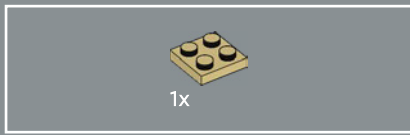

66

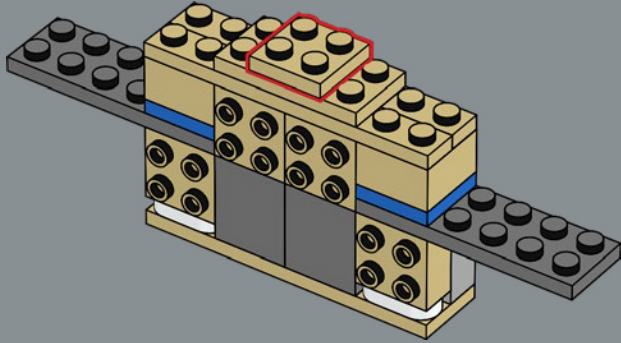

67

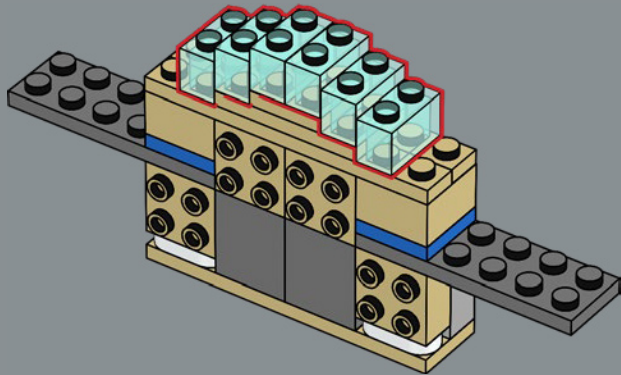

68

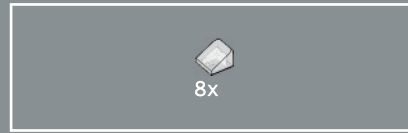
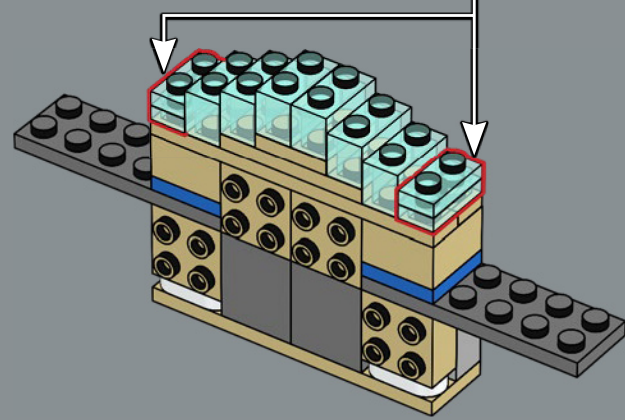
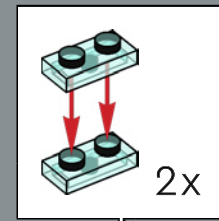

69

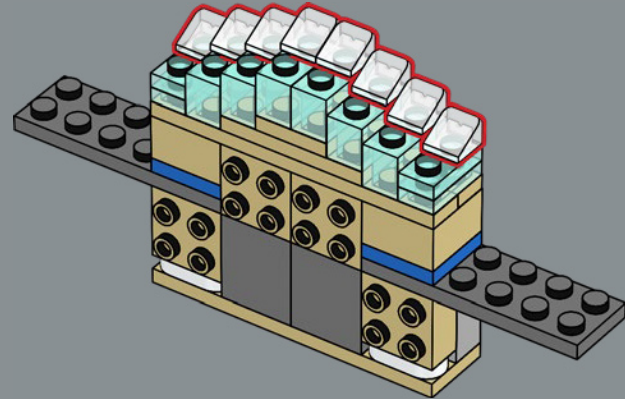

La Fontana di Trevi fu costruita in corrispondenza della sezione terminale dell'antica Acqua Vergine, e gli acquedotti continuano ad alimentarla ancora oggi.

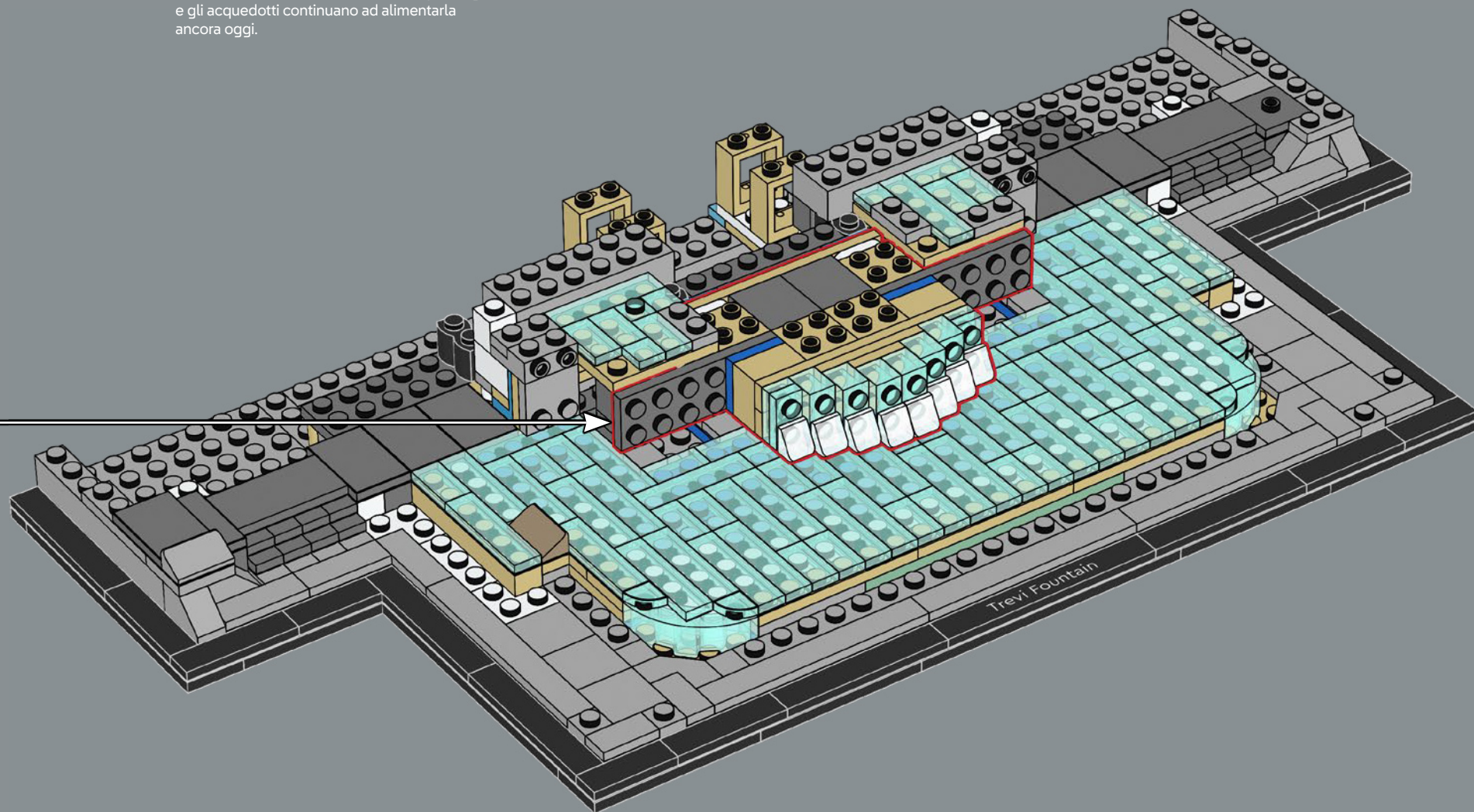

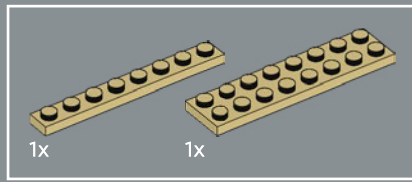

71

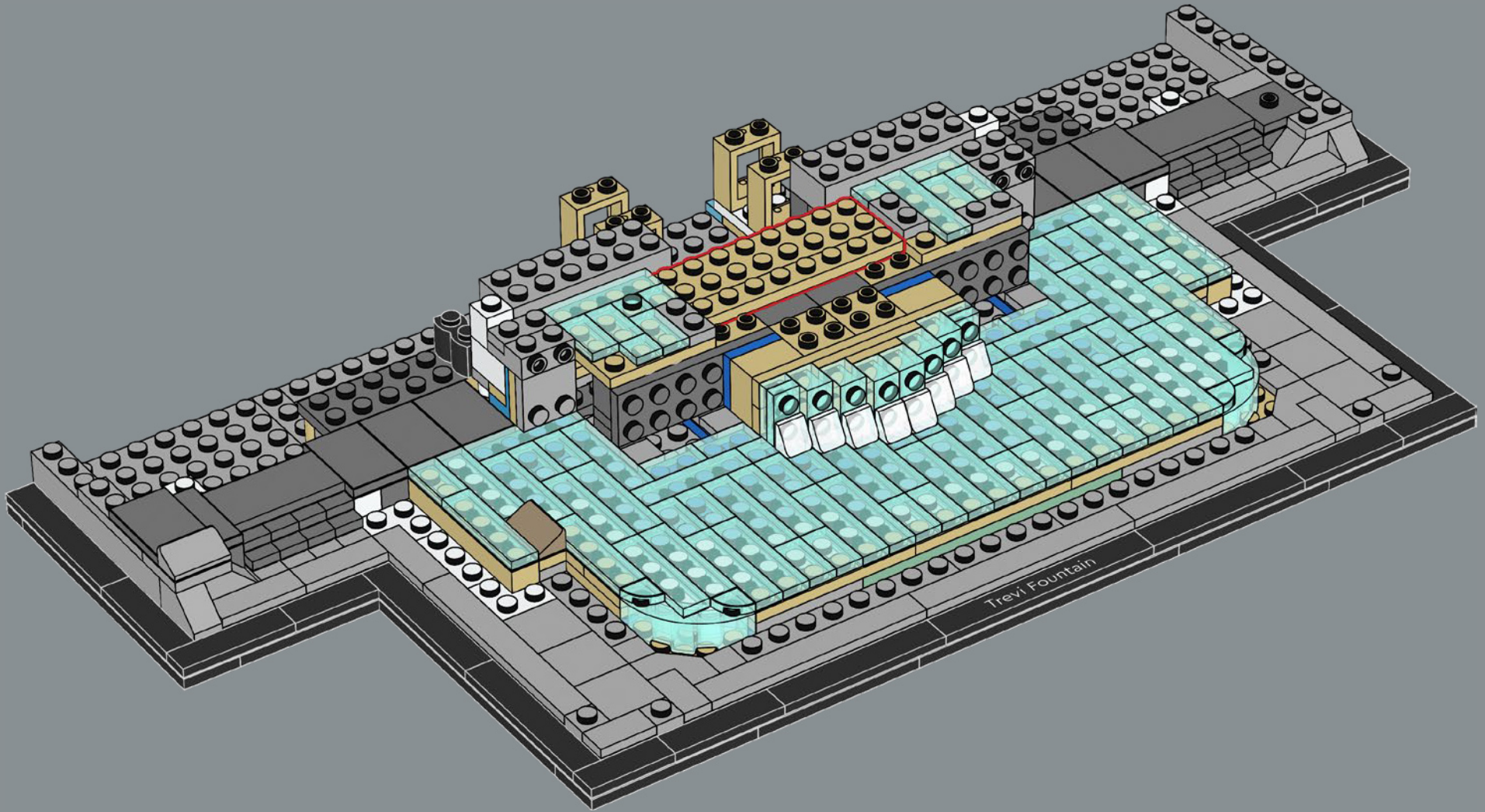

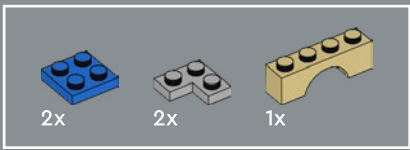

72

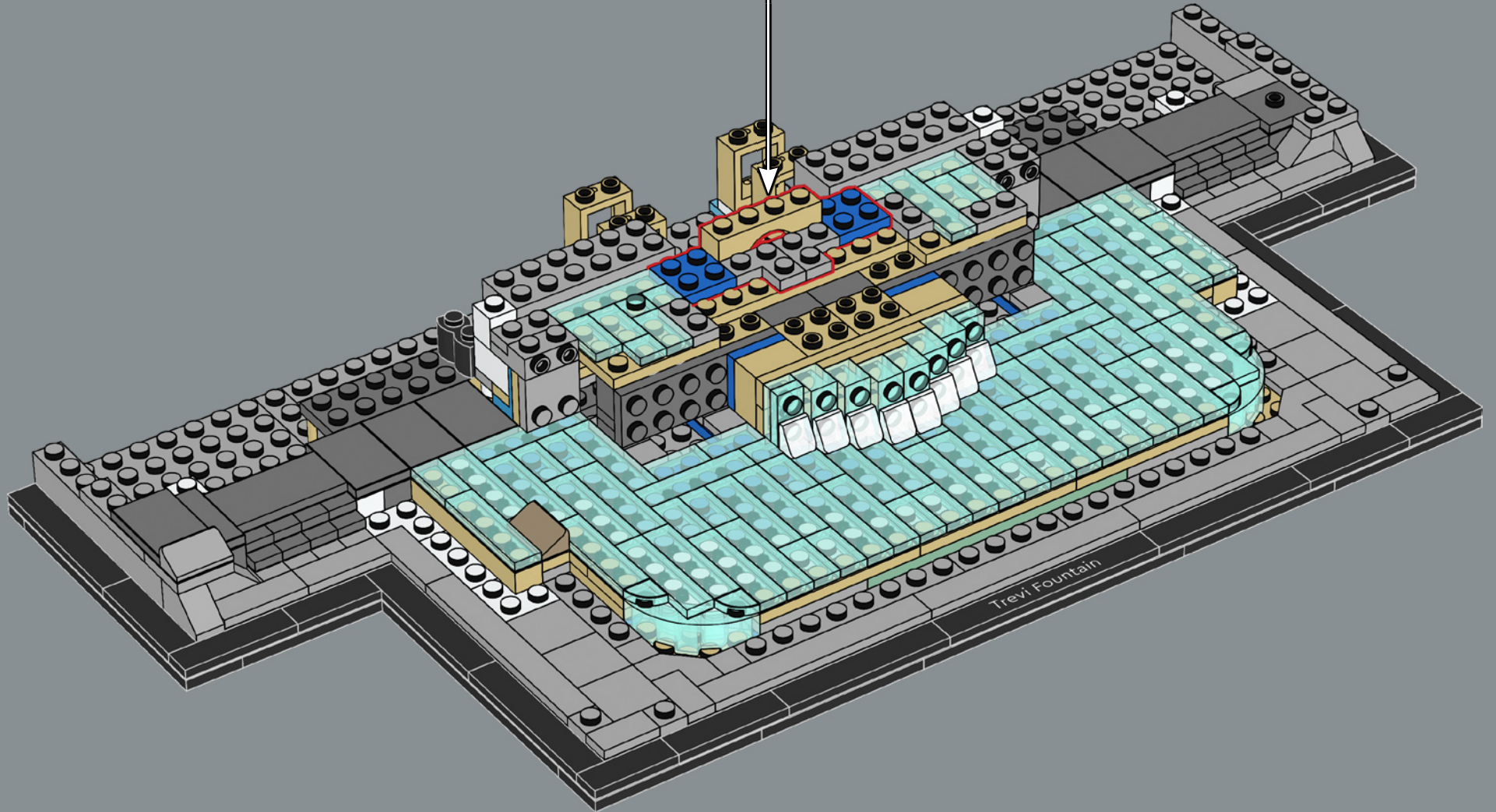
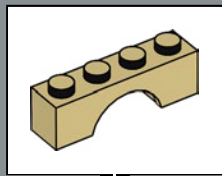

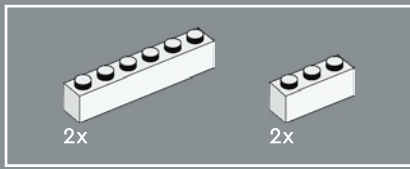

73

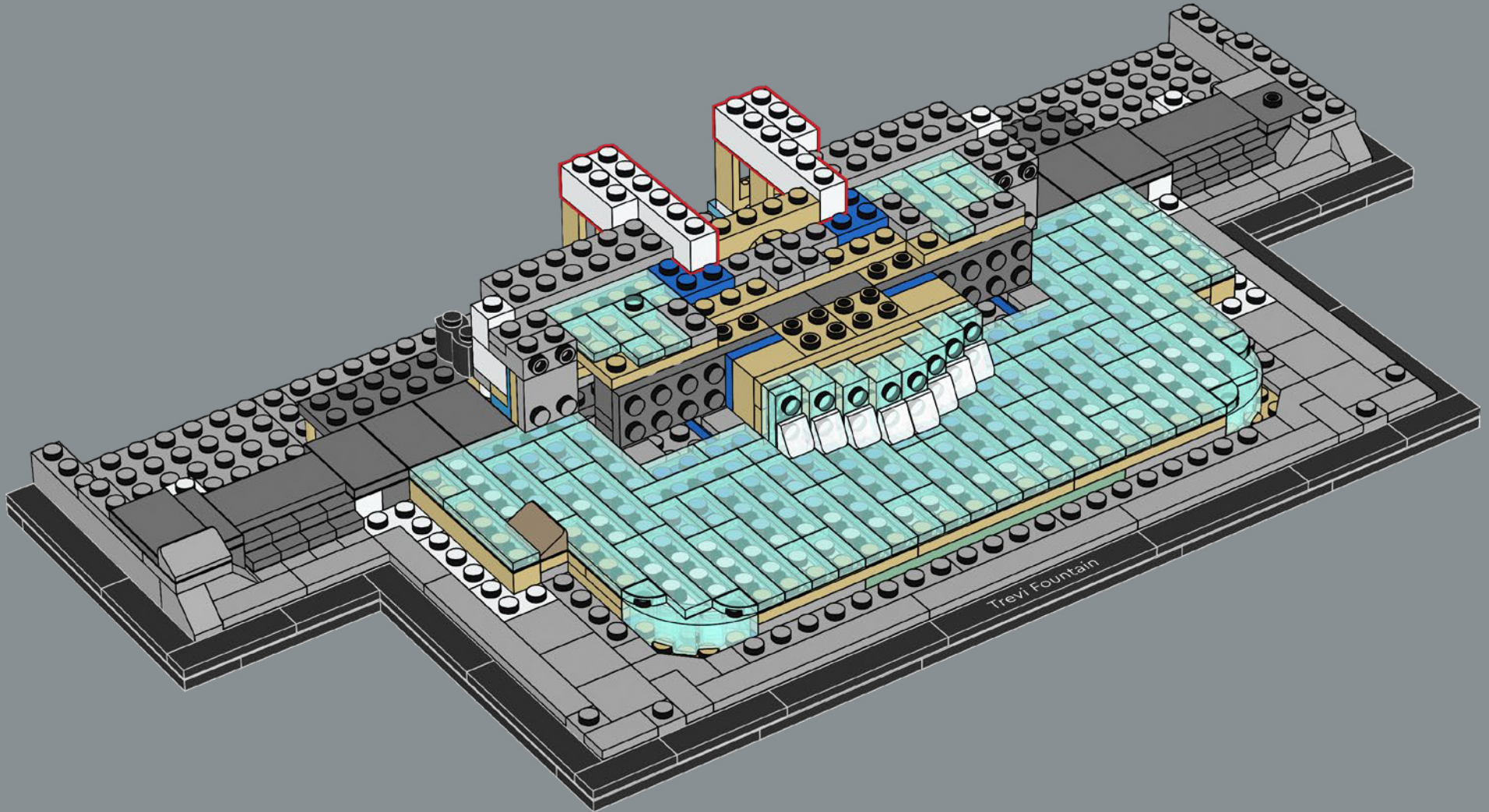

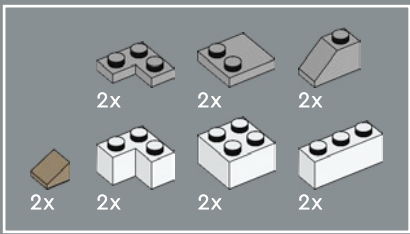

74

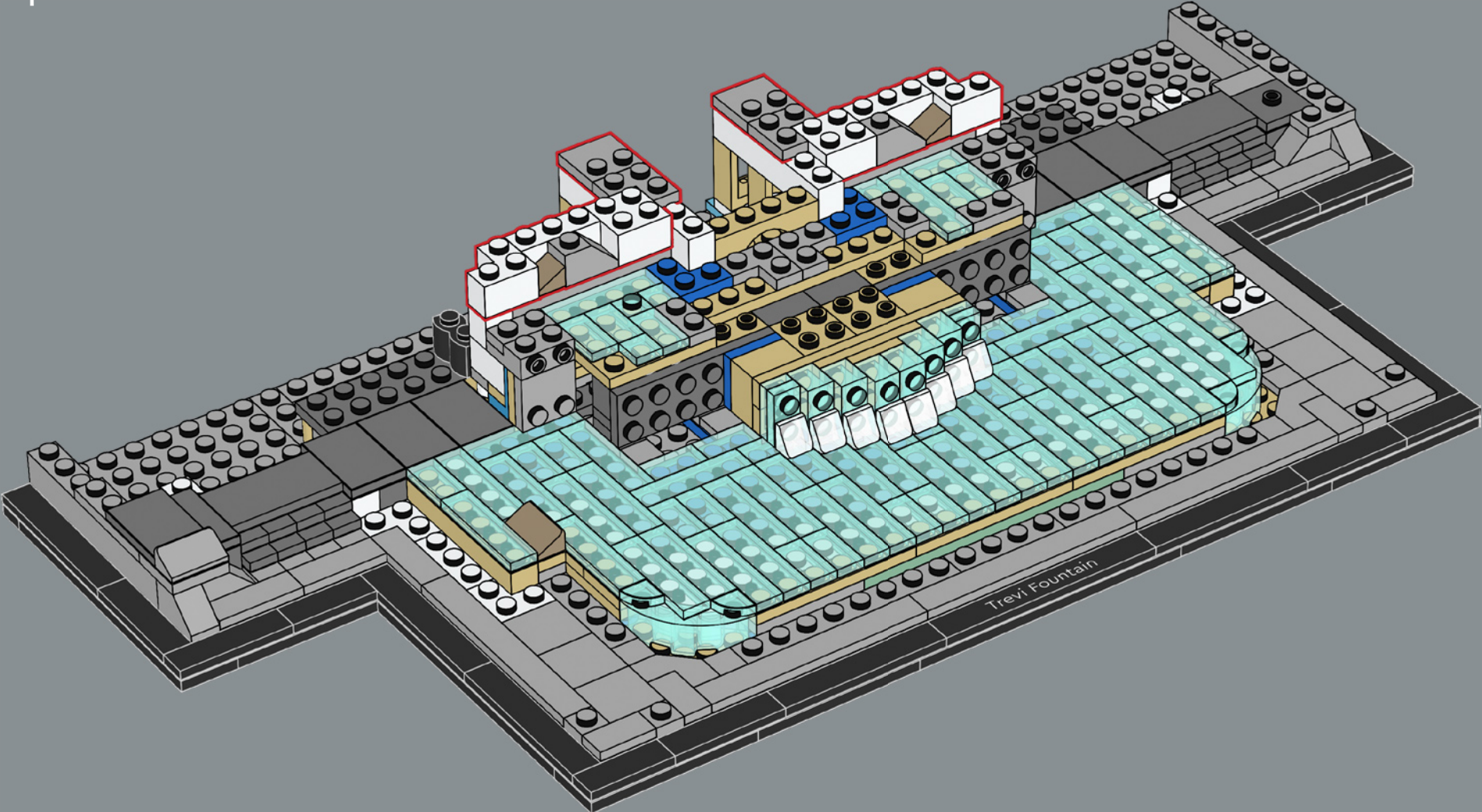

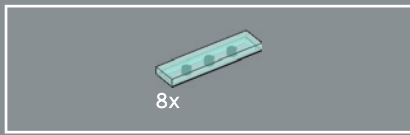

75

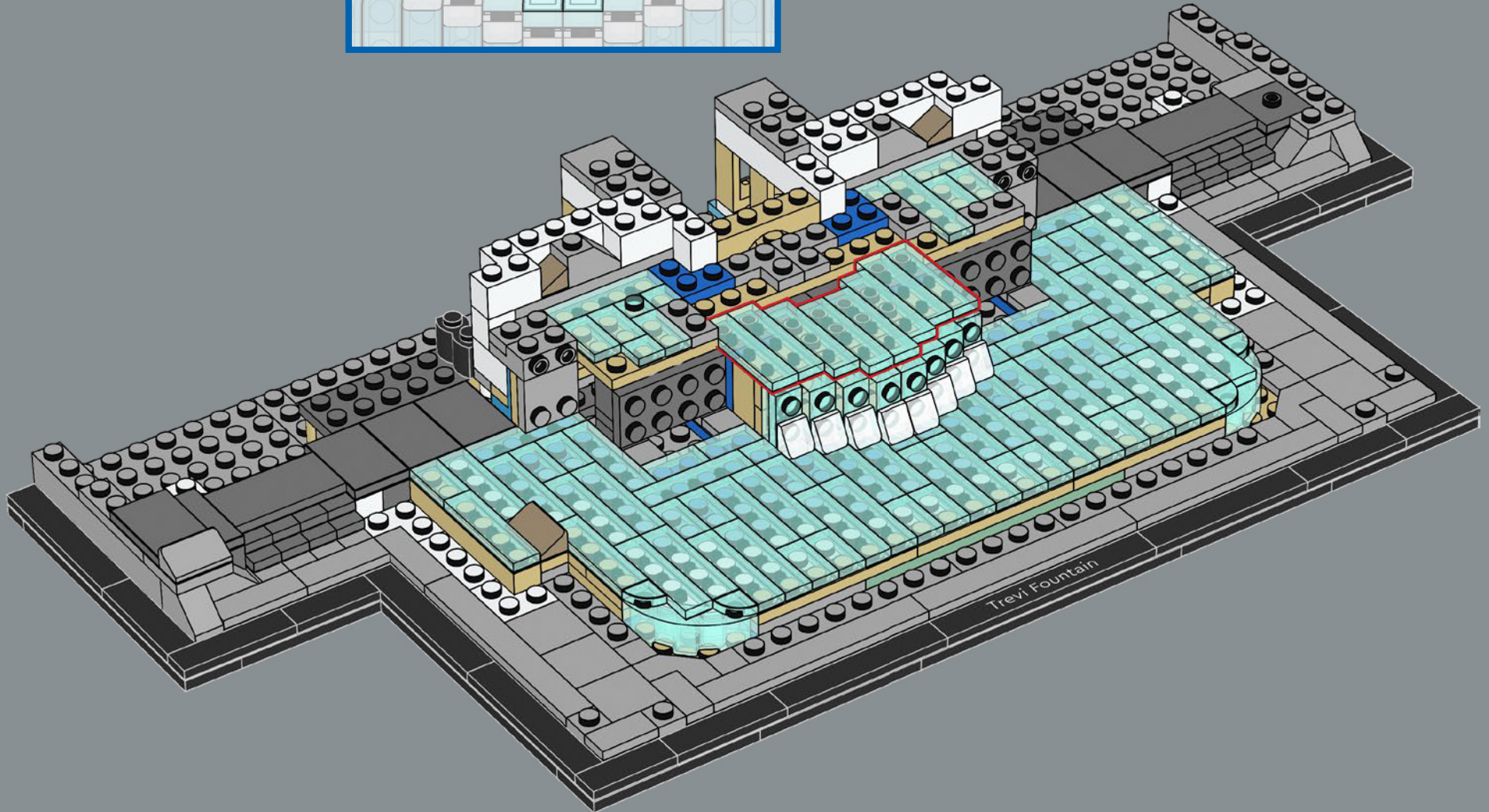
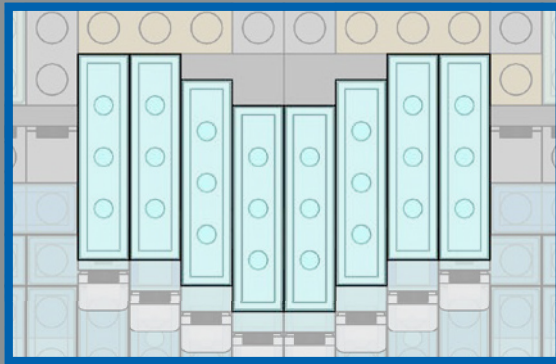

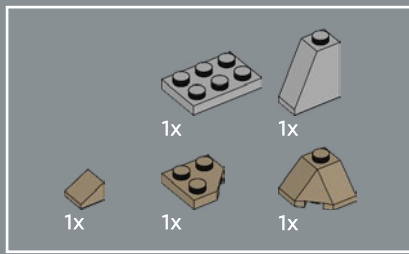

76

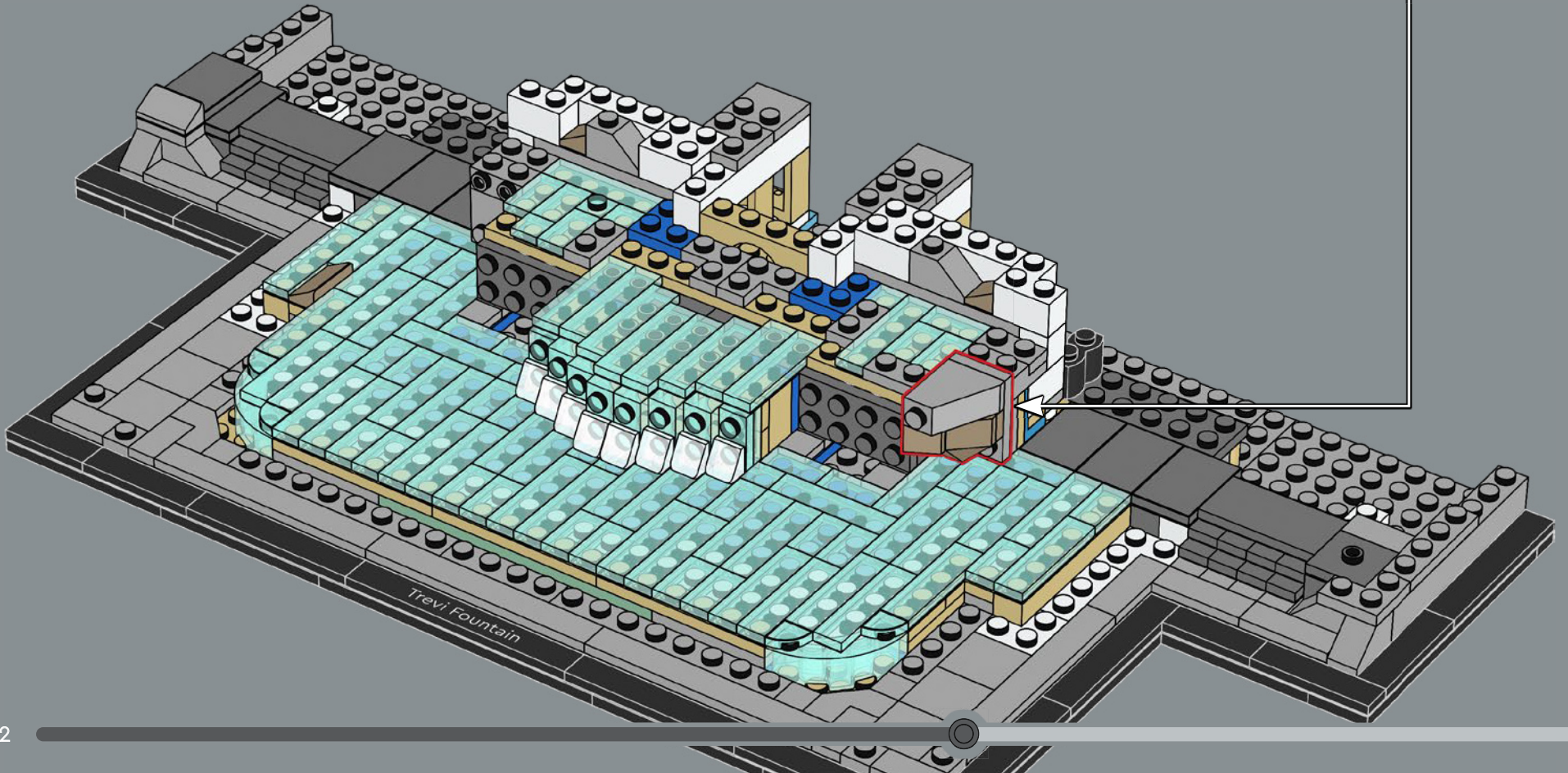
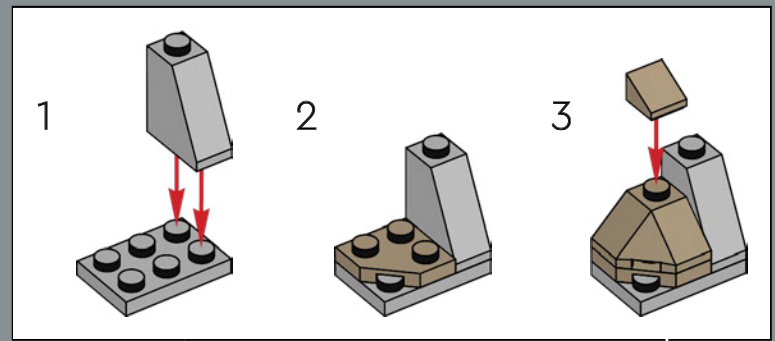



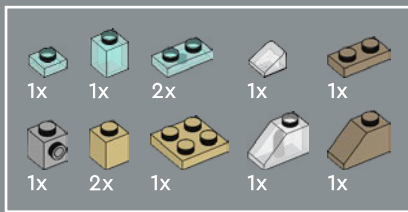

77

1

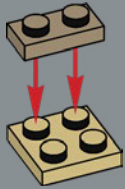

2

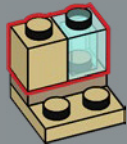

3

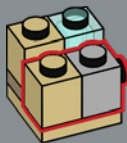

4



5



6

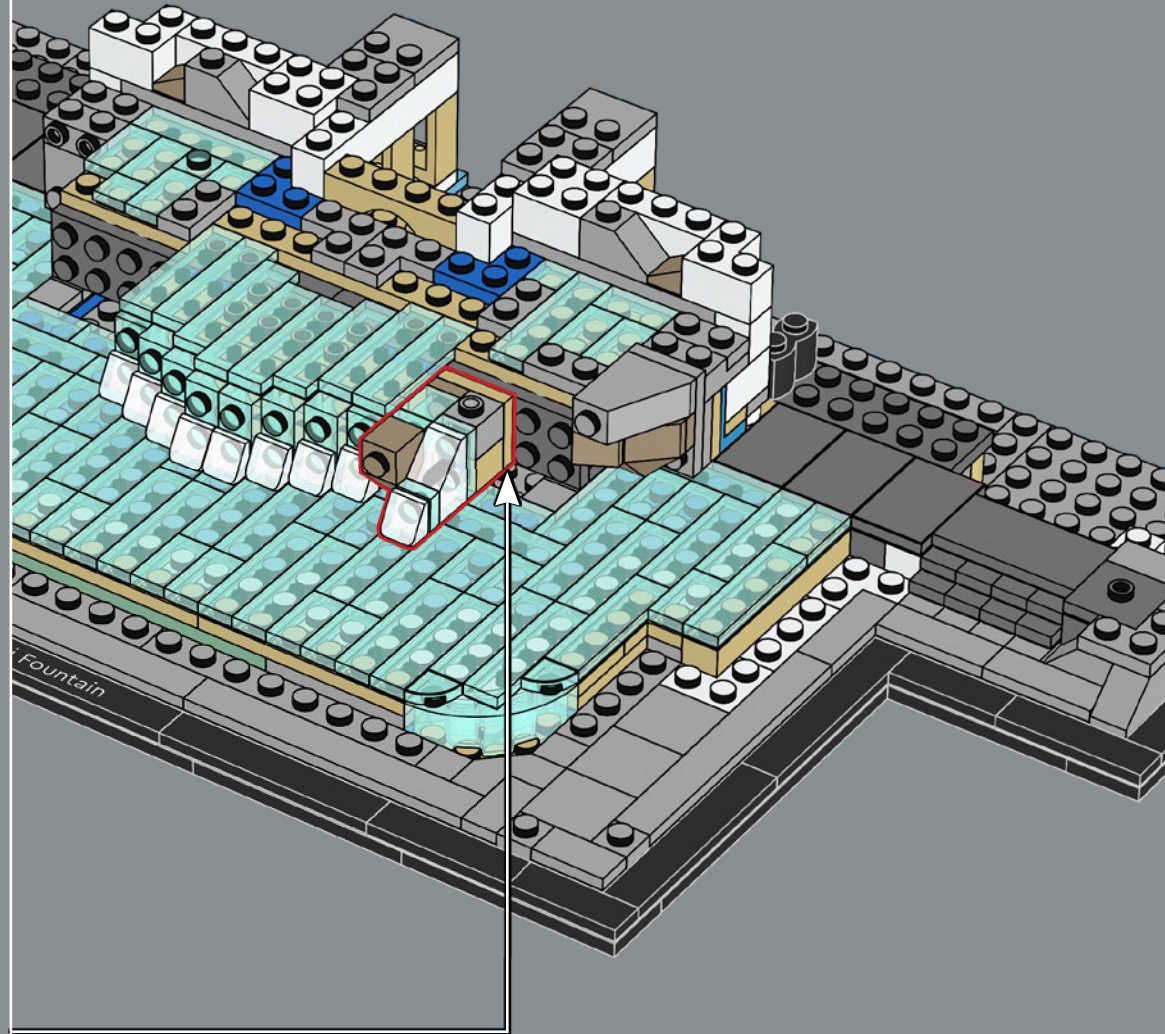

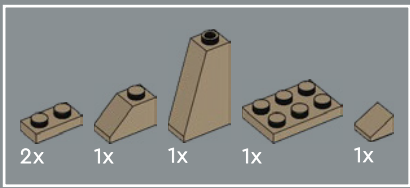

78

1

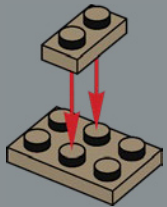

2

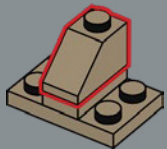

3

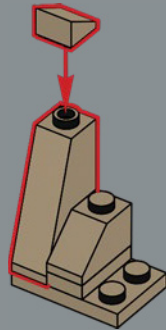

4

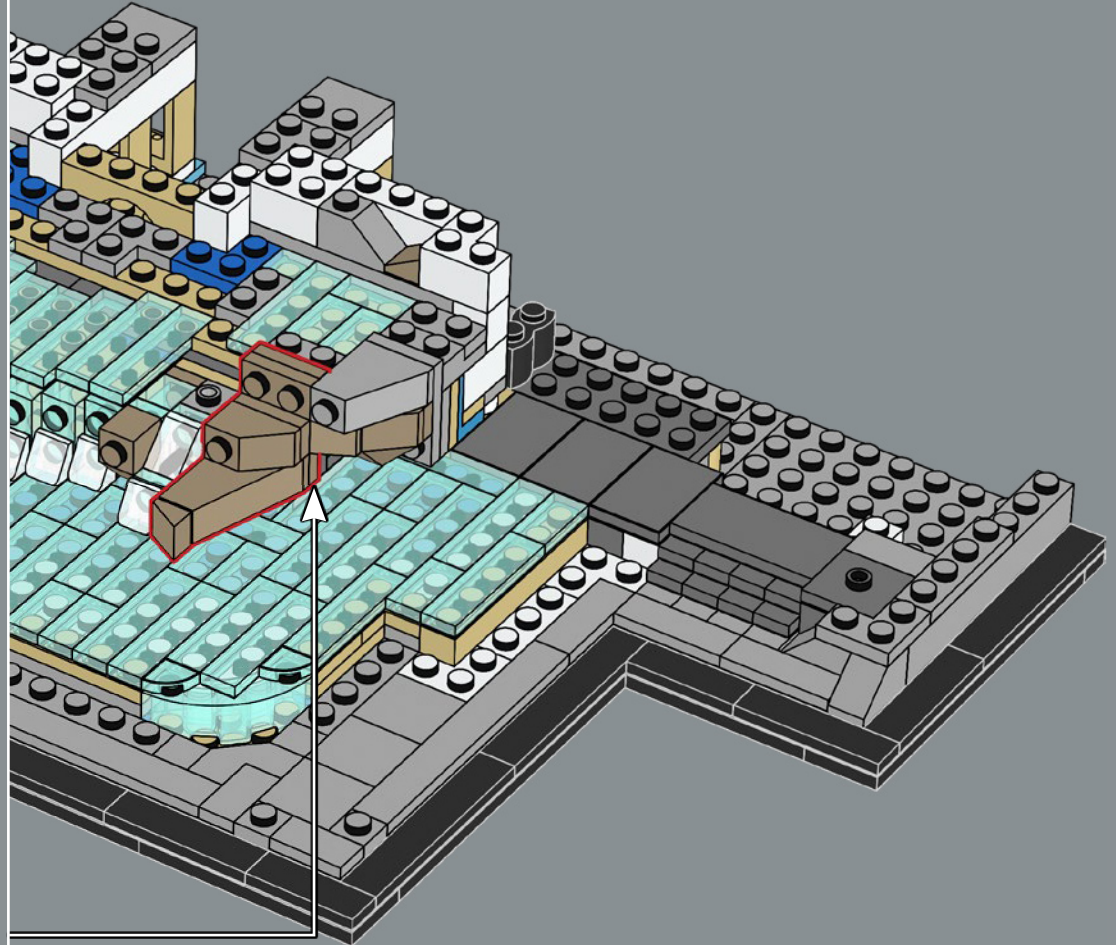
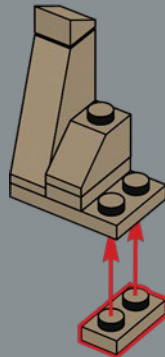

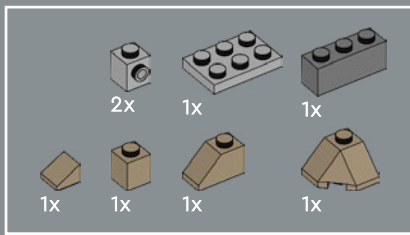

79

1

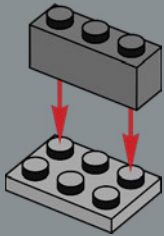

2

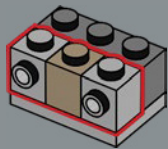

3

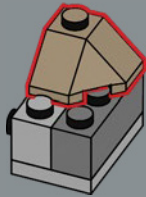

4

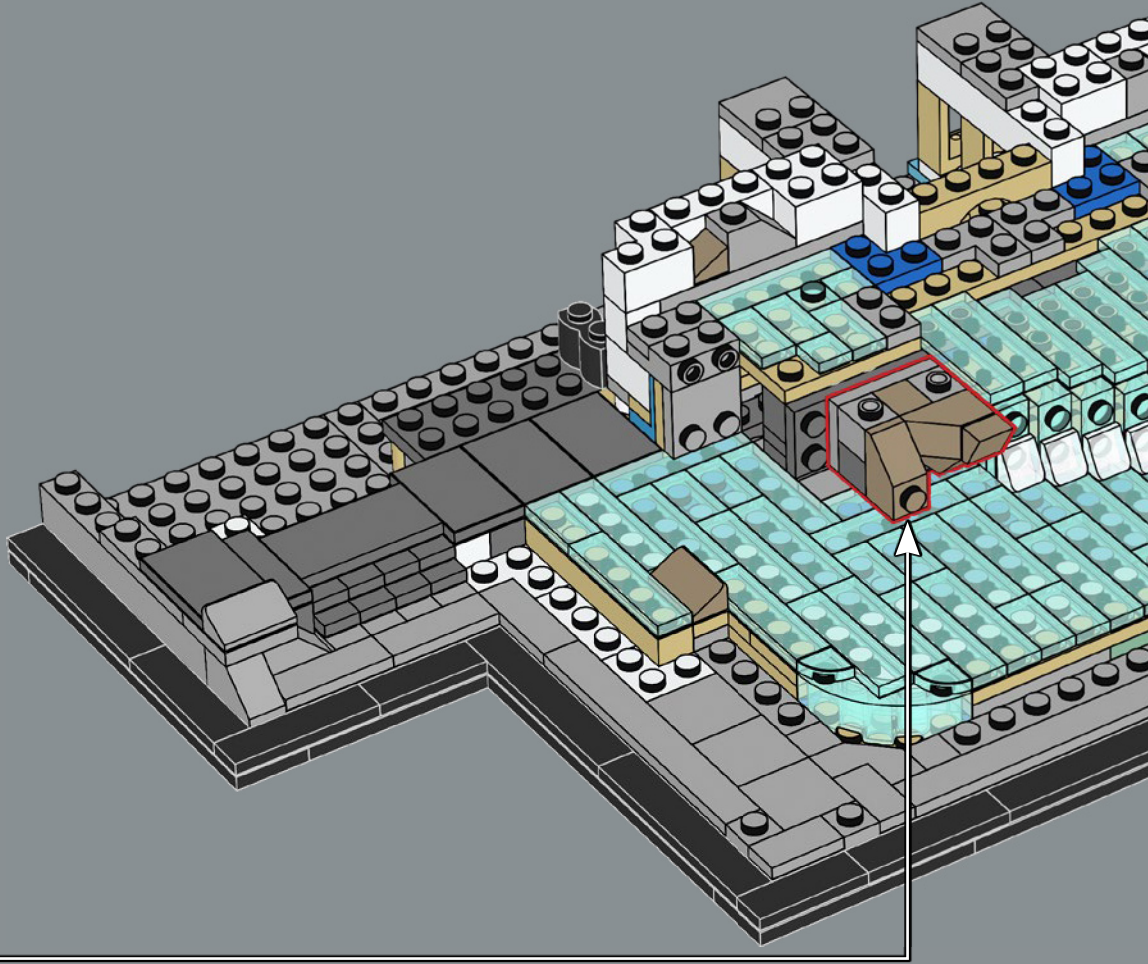
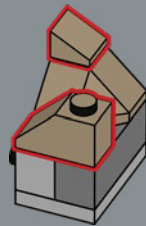

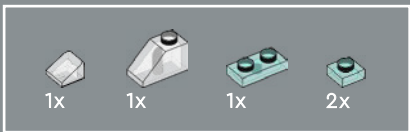

80

1

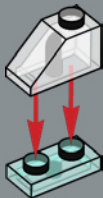

2

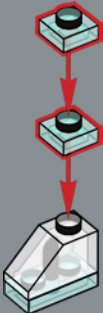

3

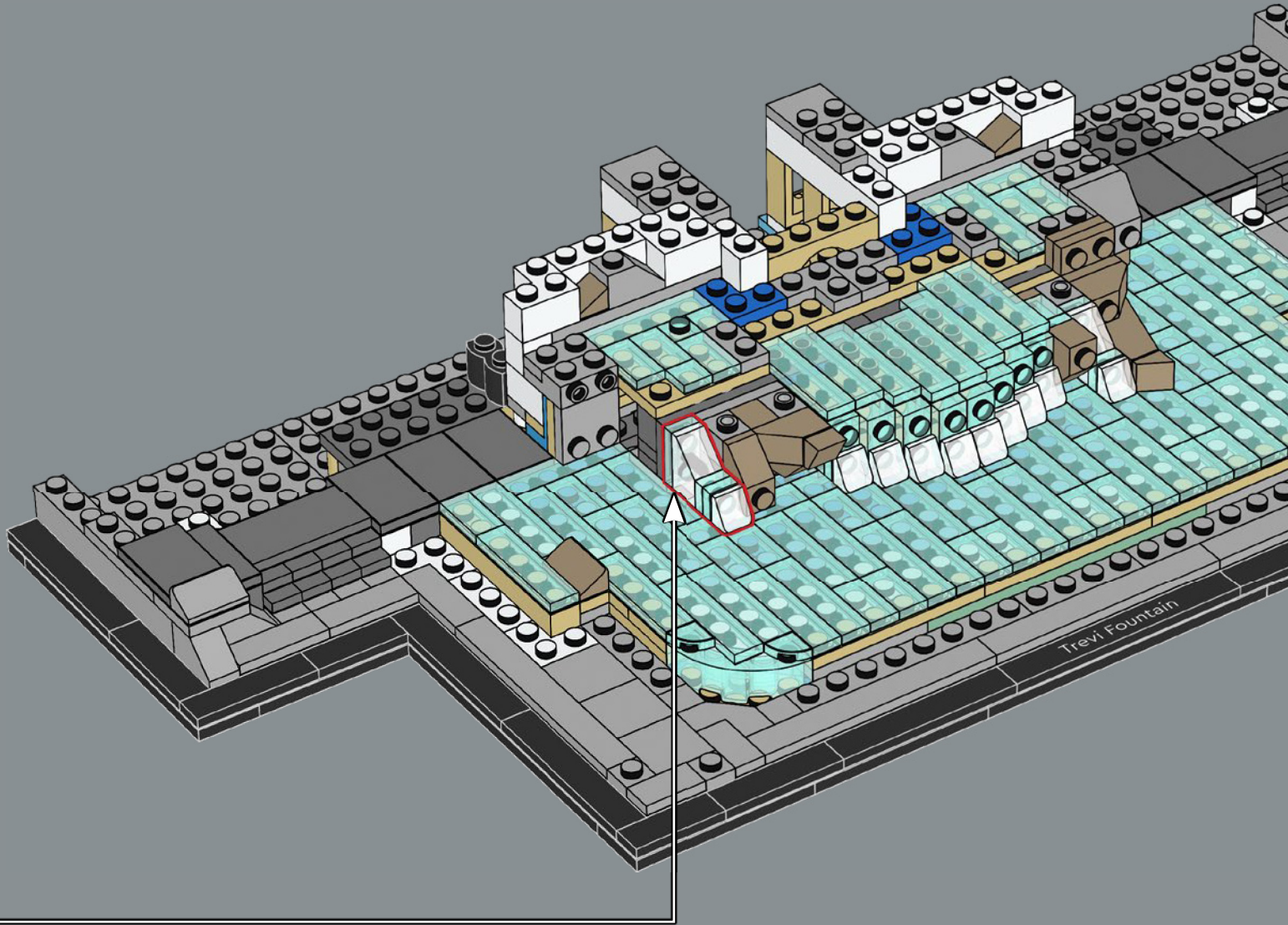

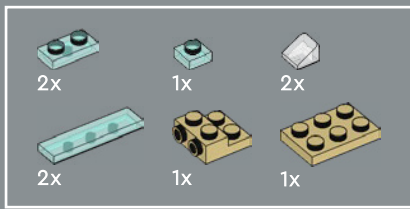

81

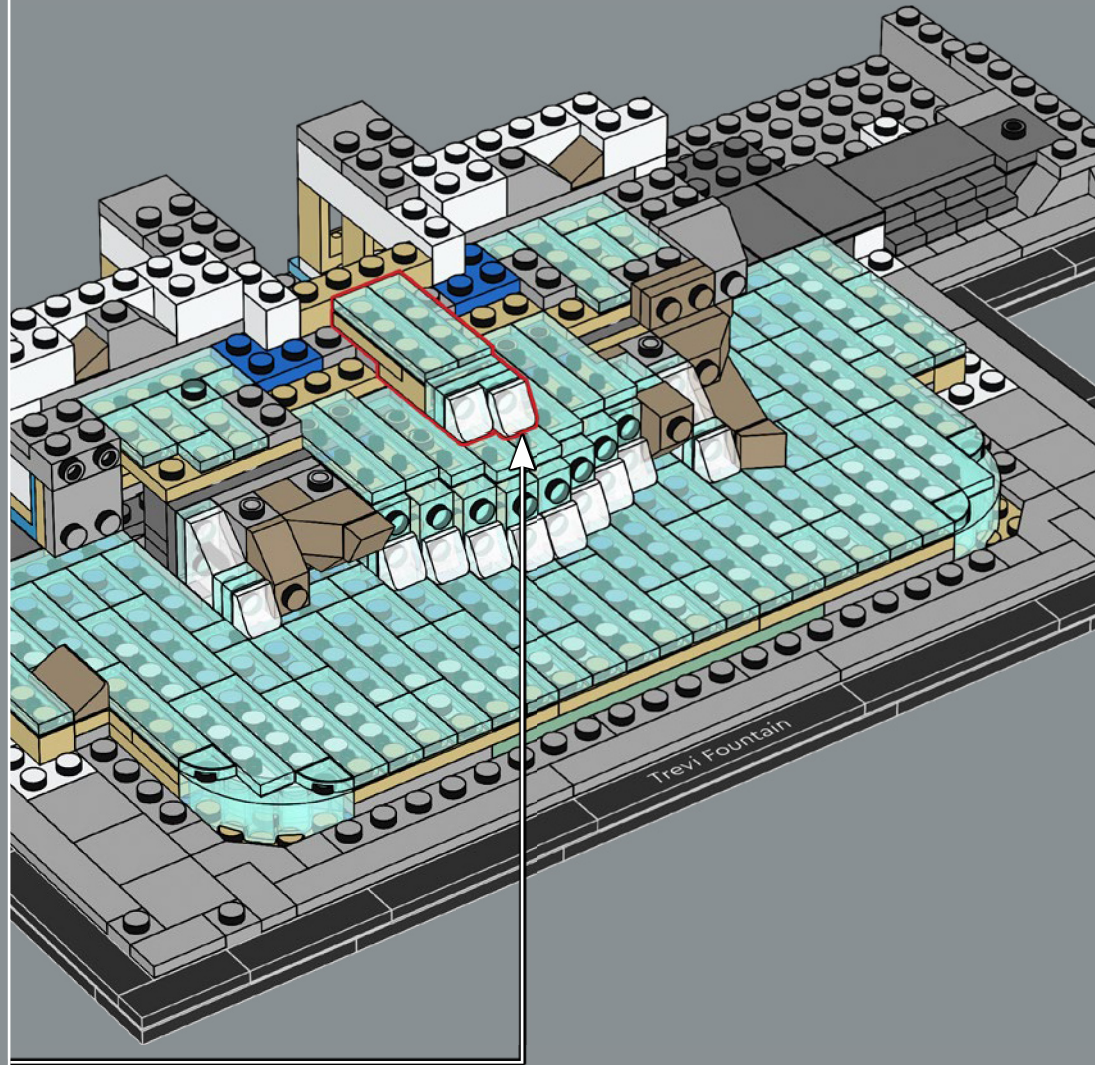
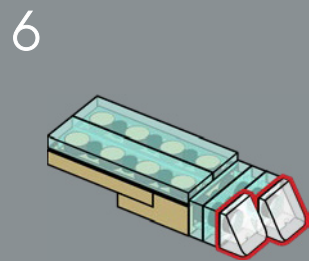
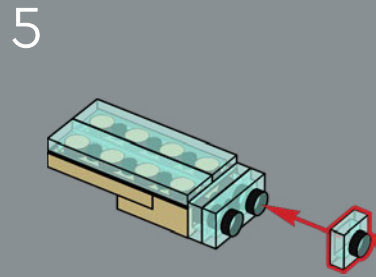
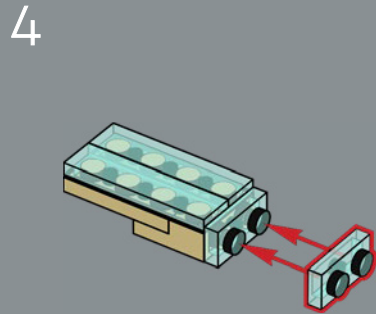
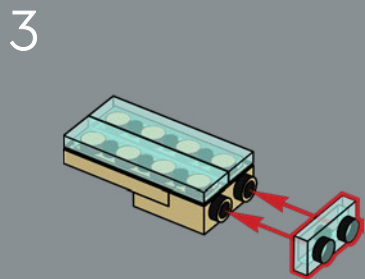
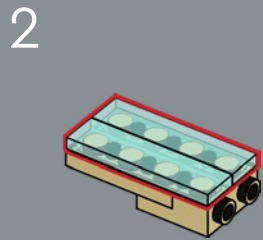
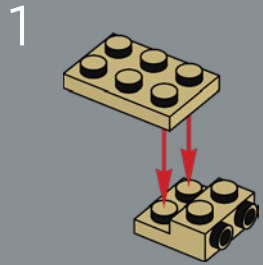

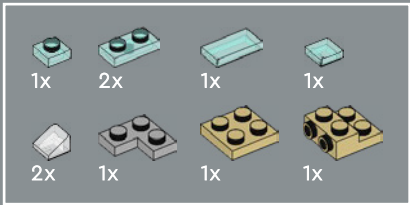

82

1

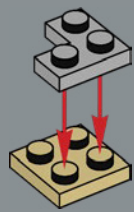

2

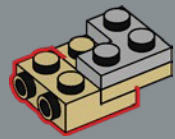

3

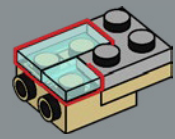

4

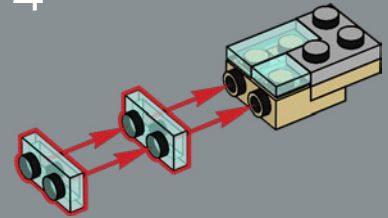

5

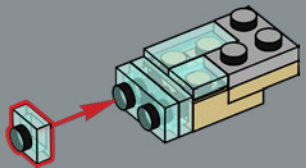

6

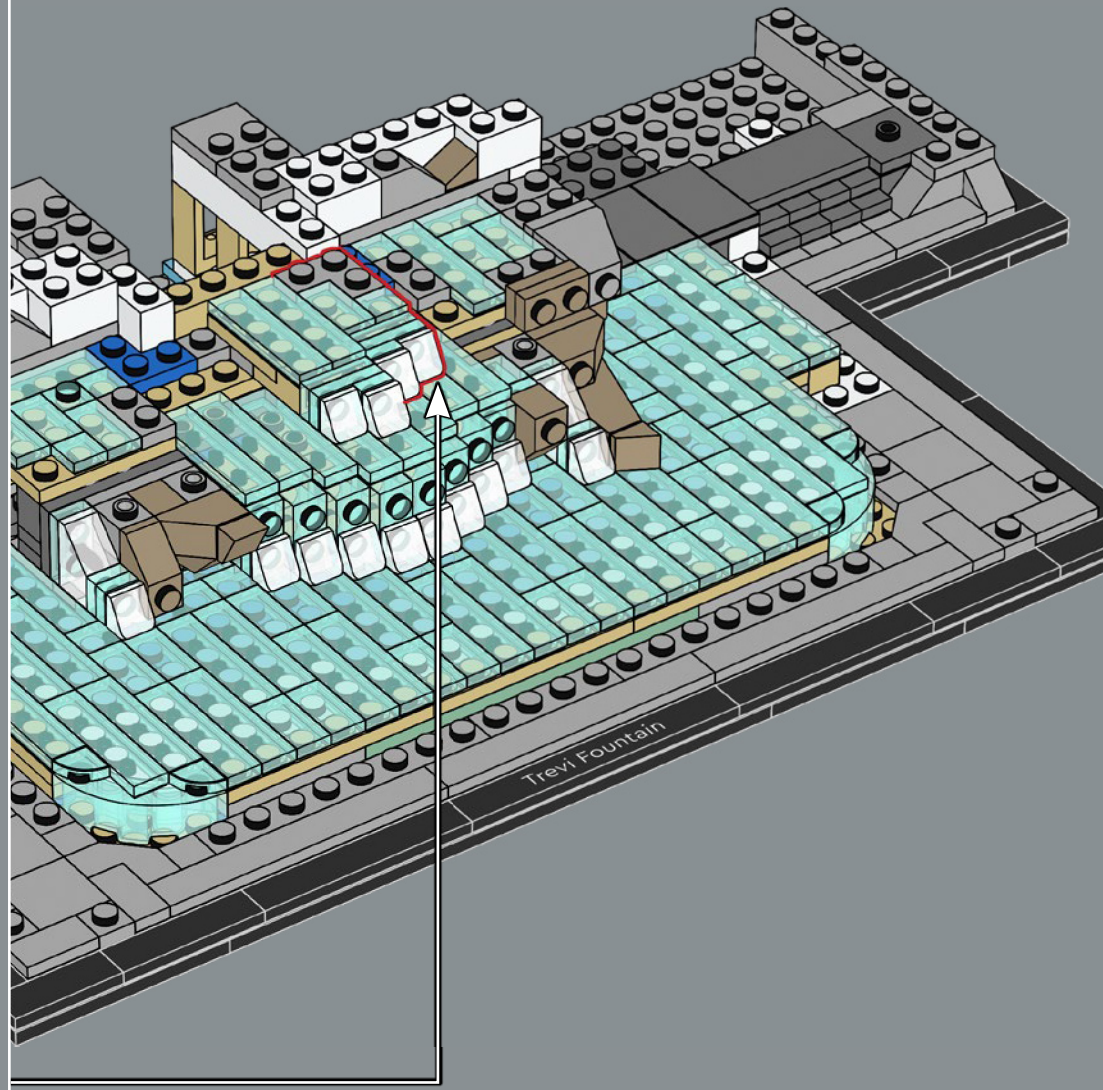
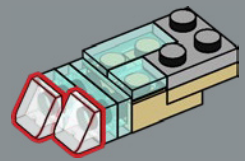

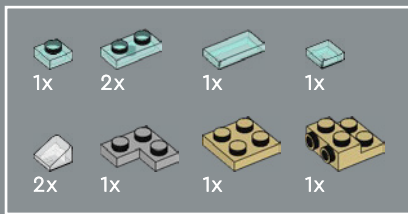

83

1

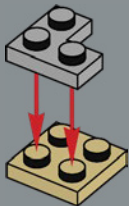

2

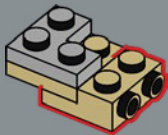

3

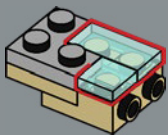

4

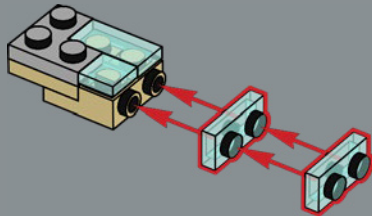

5

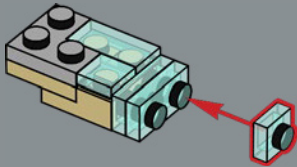

6

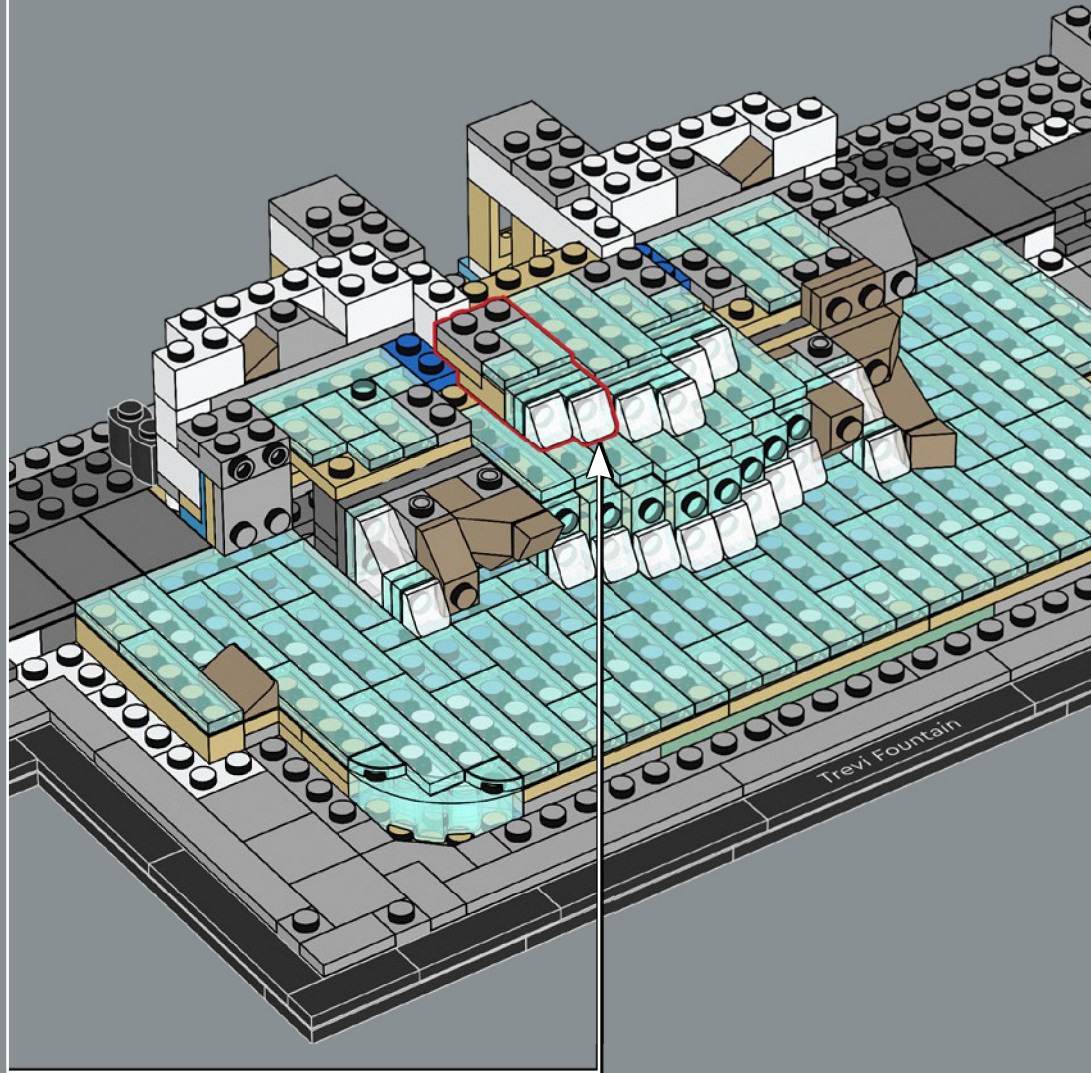
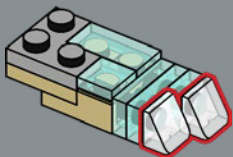

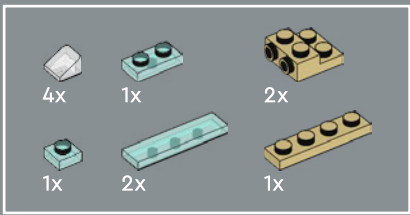

# 84

1

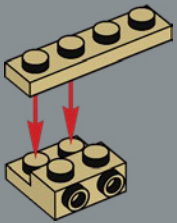

2

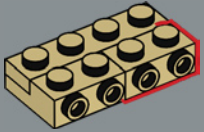

3

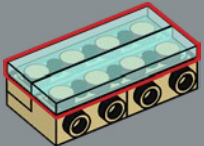

4

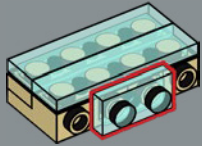

5

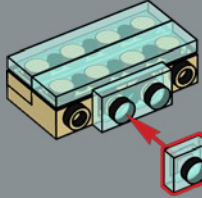

6

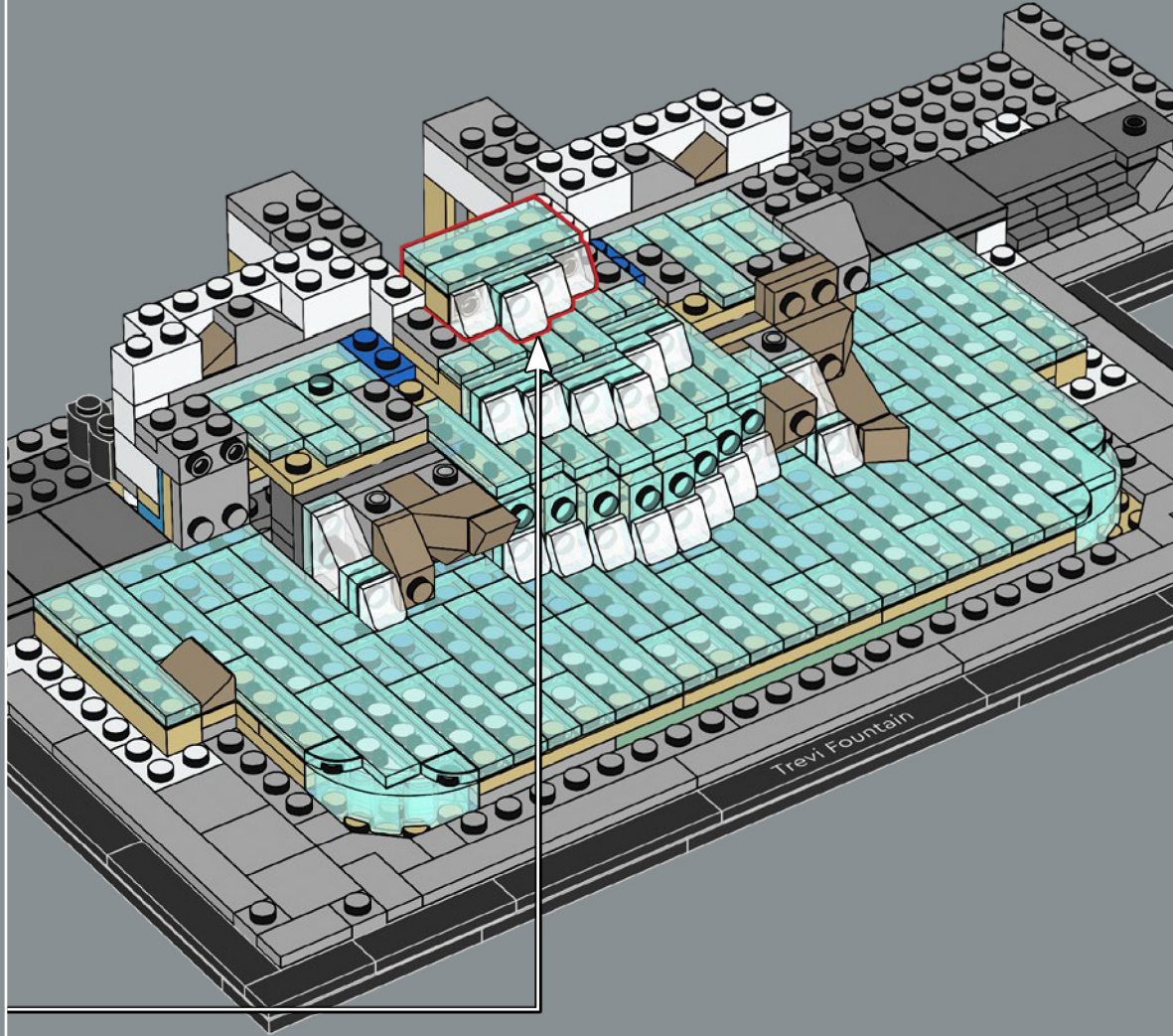





Il colore sotto il blu trasparente riflette quello reale. Nelle porzioni superiori, l'acqua scorre sulla roccia, evidenziando il colore della pietra sottostante, ma più in basso nella vasca, la profondità è indicata con sfumature di blu più scure.

85

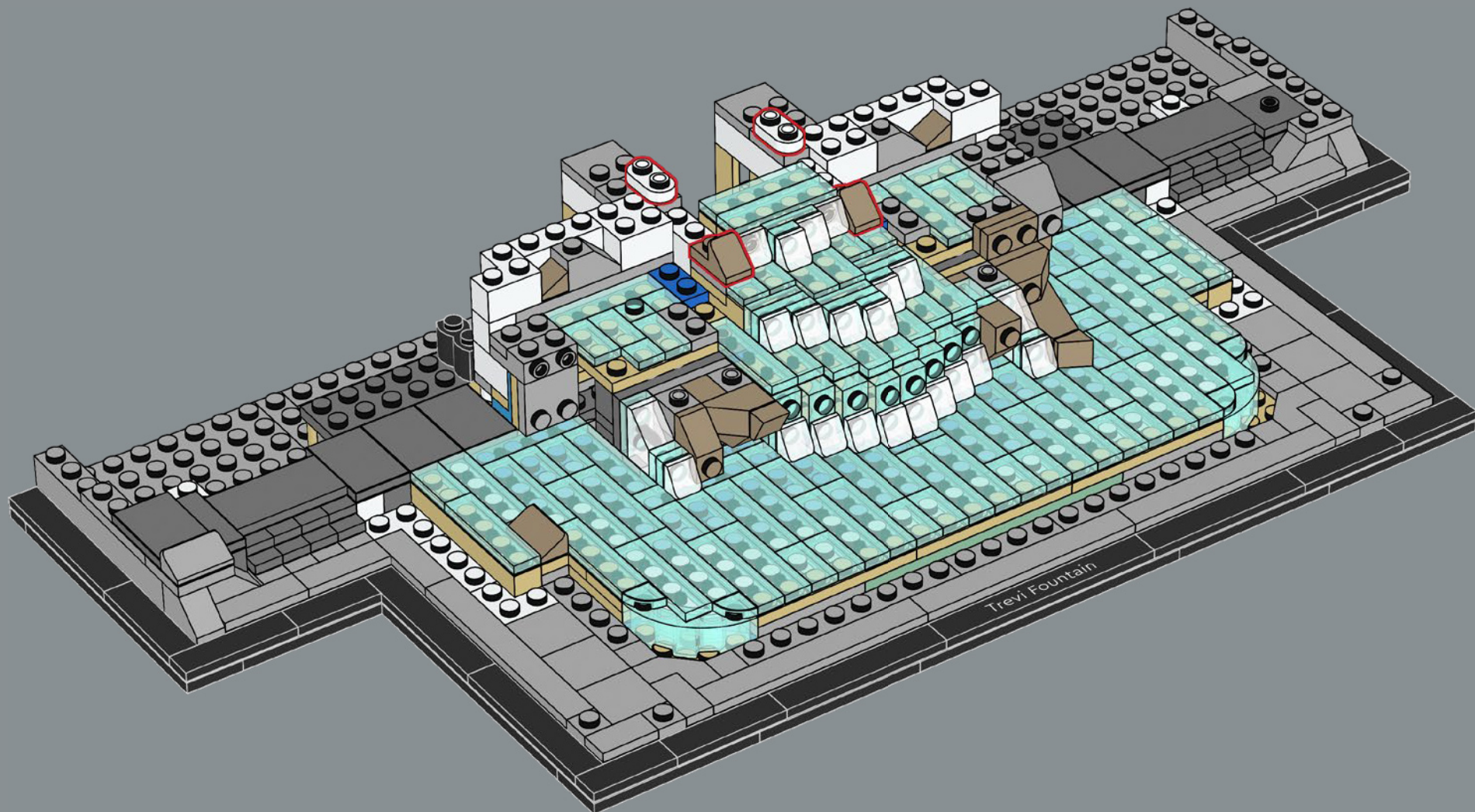

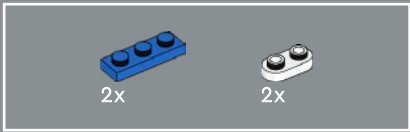

86

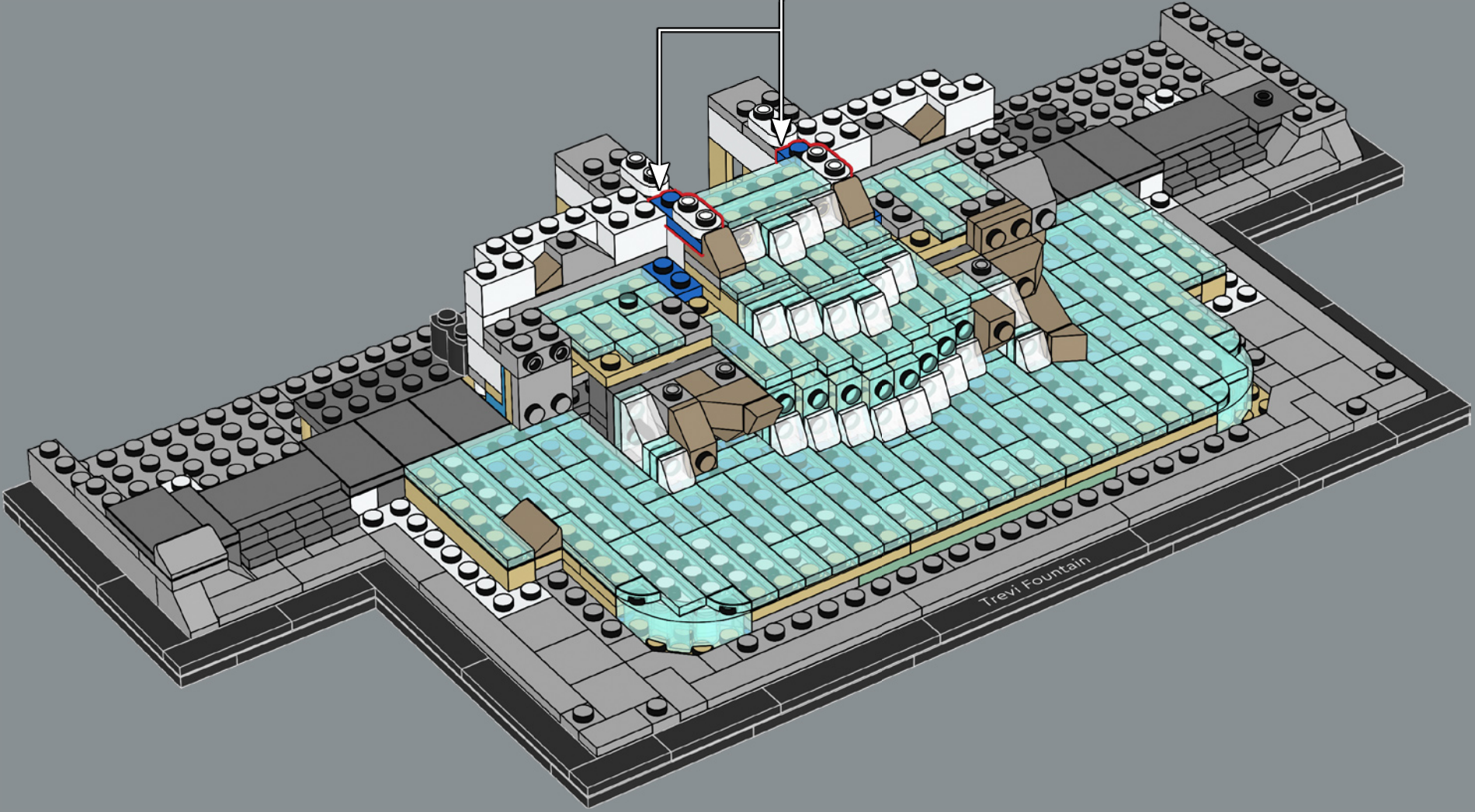
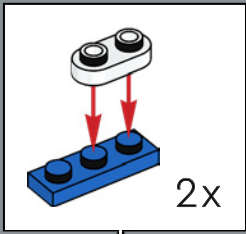

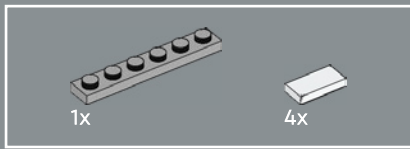

87

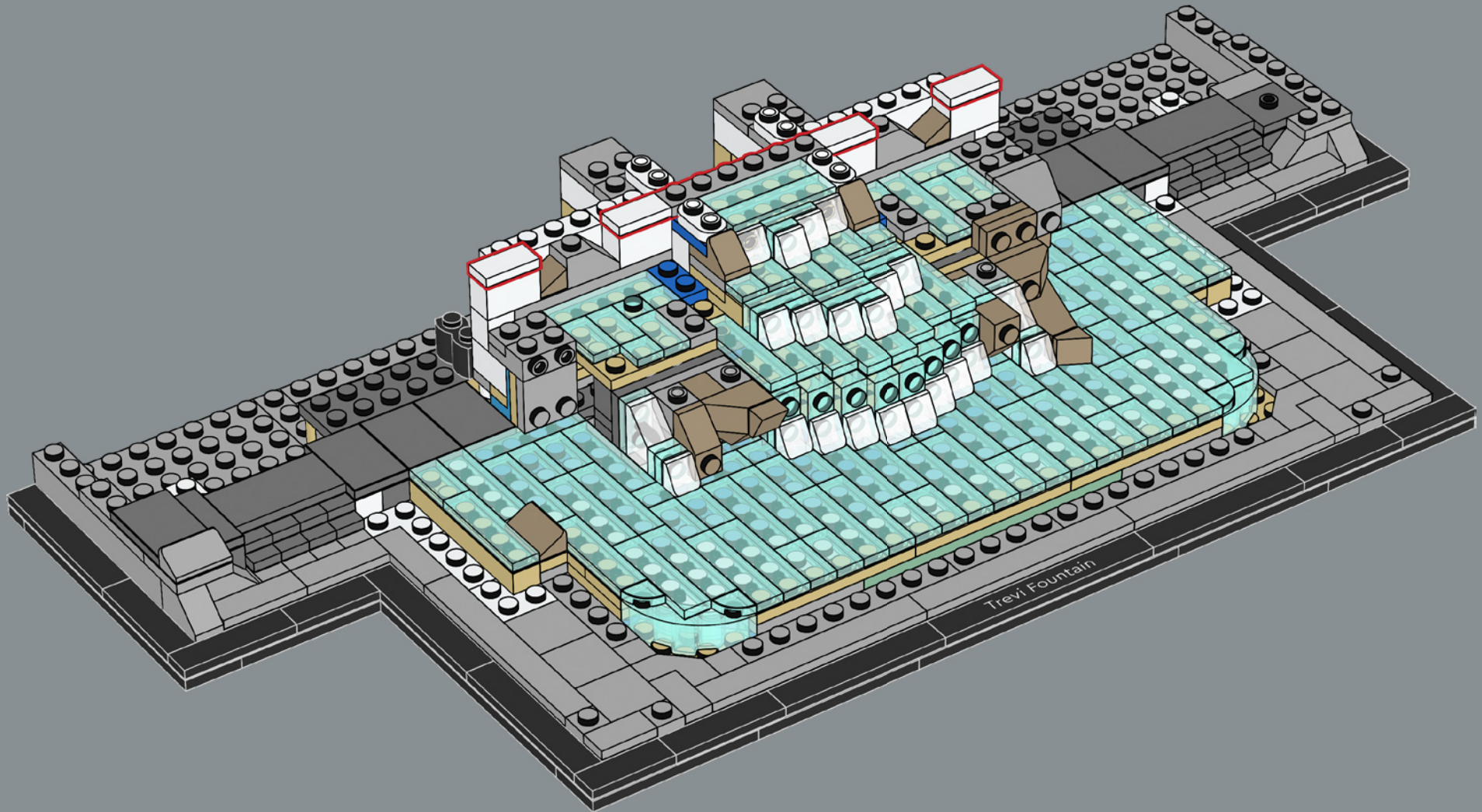

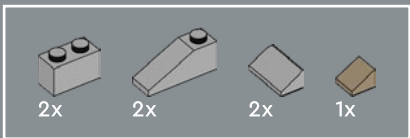

88

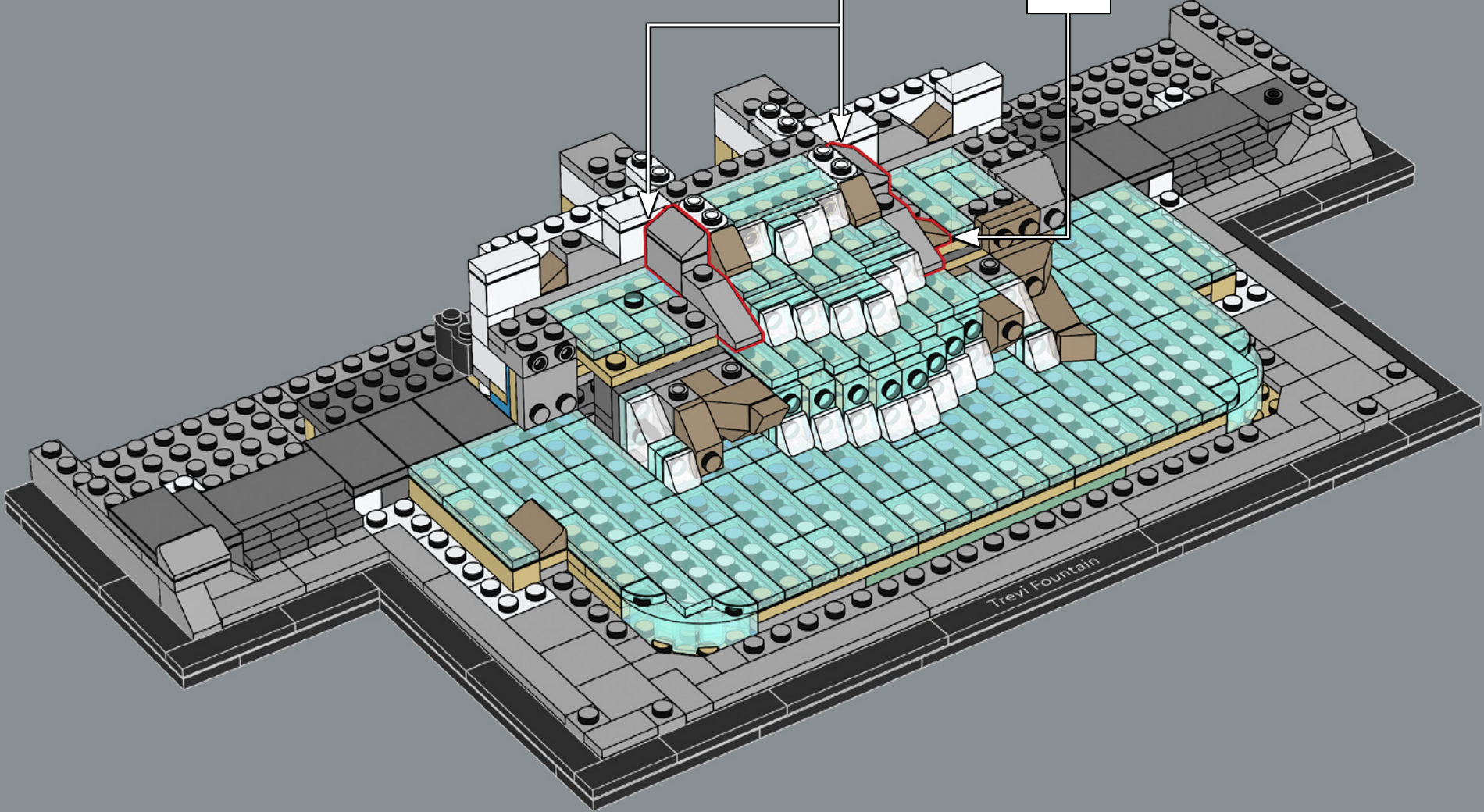
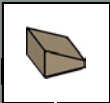
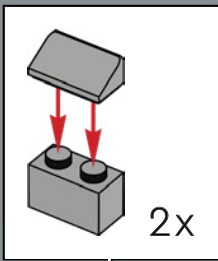

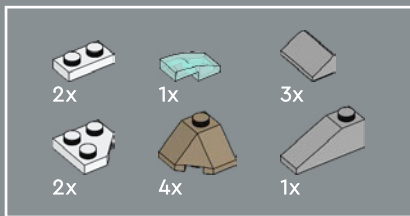

89

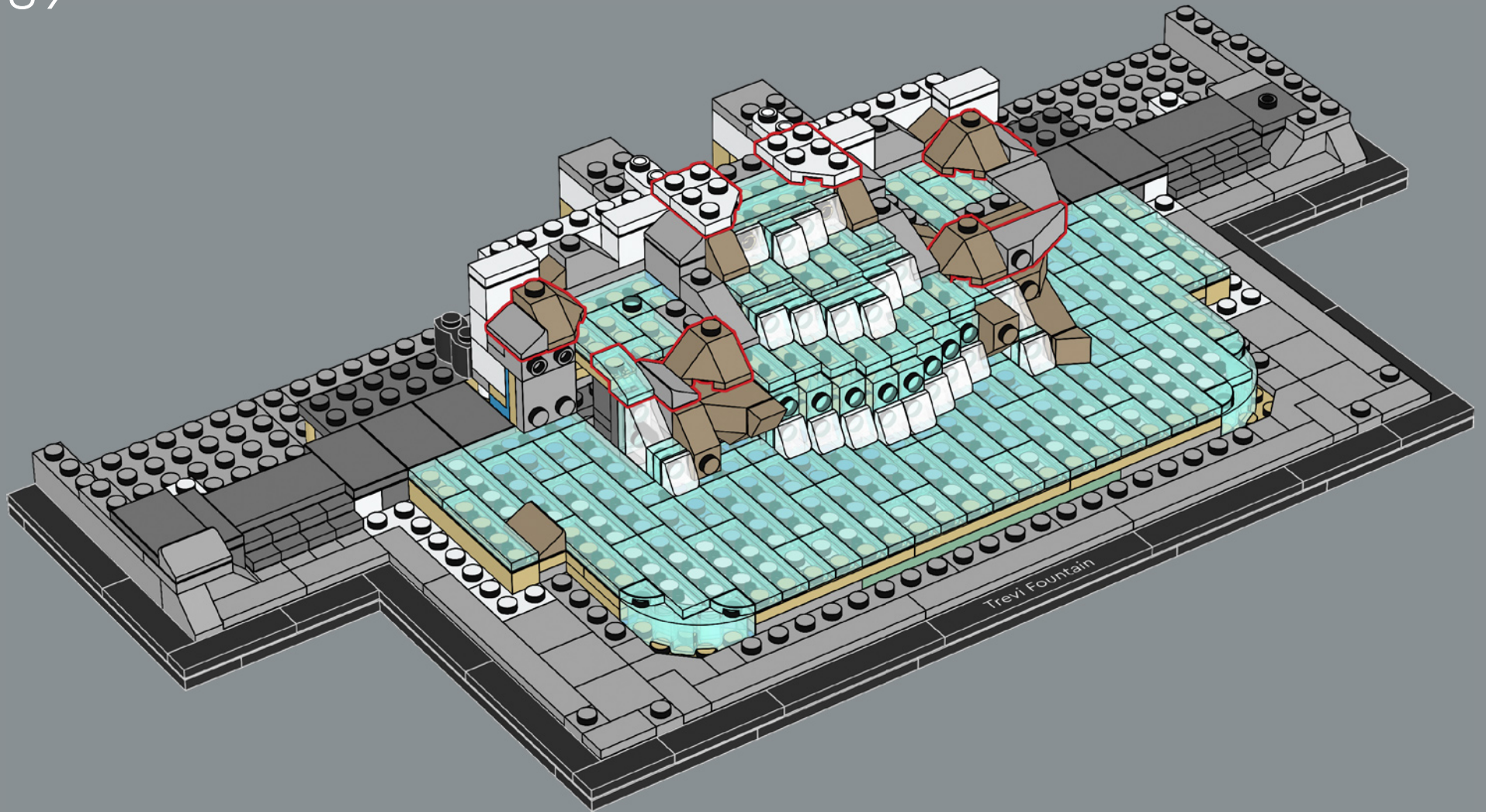

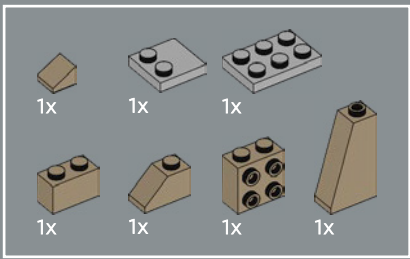

90

1

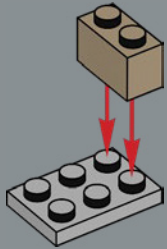

2

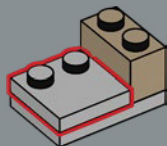

3

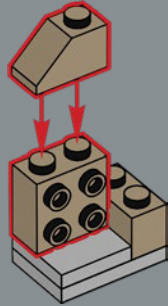

4

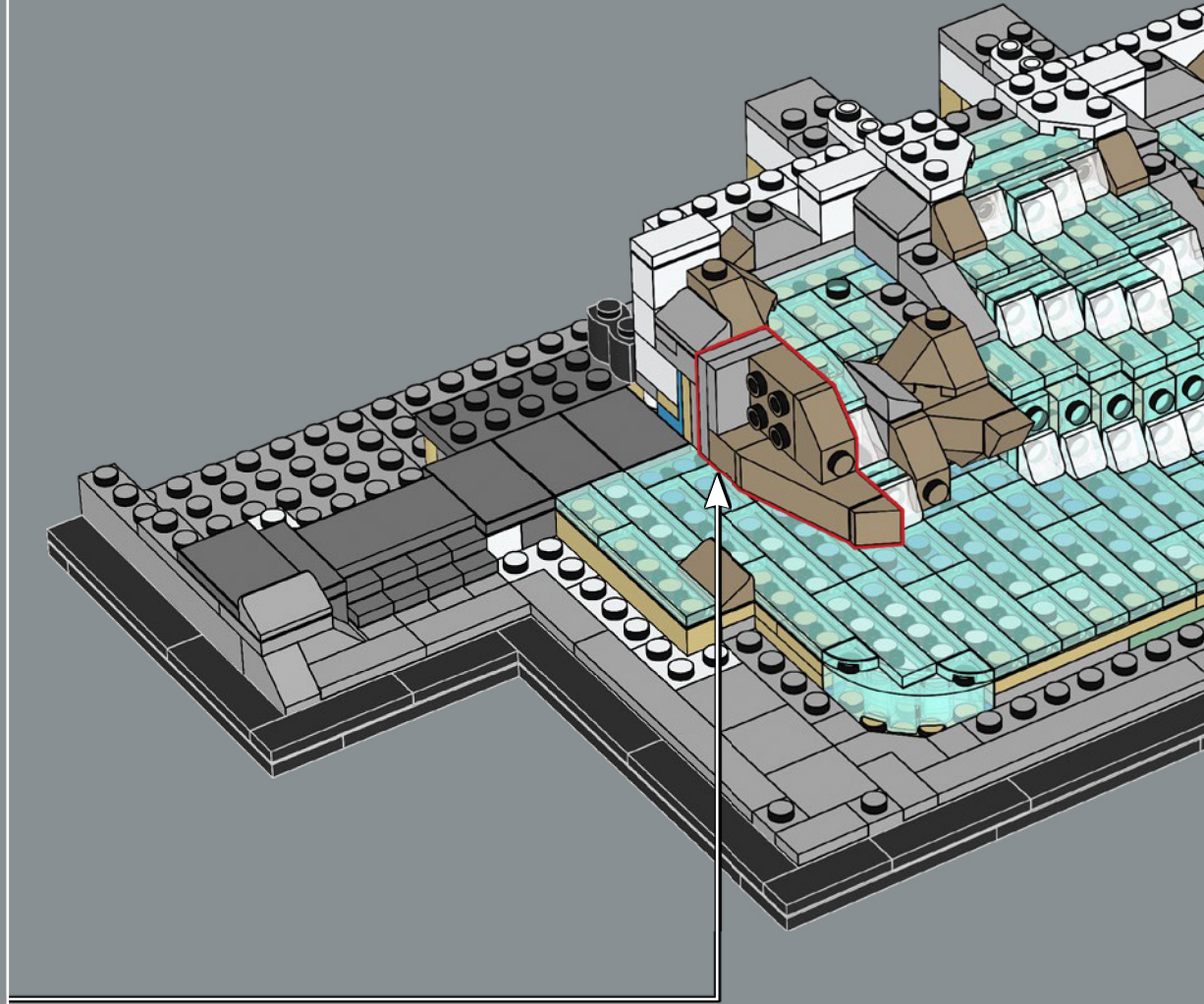
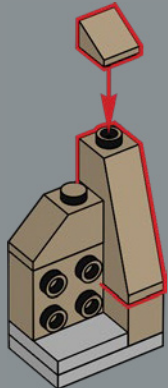

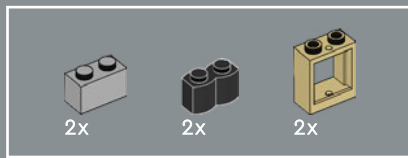

91

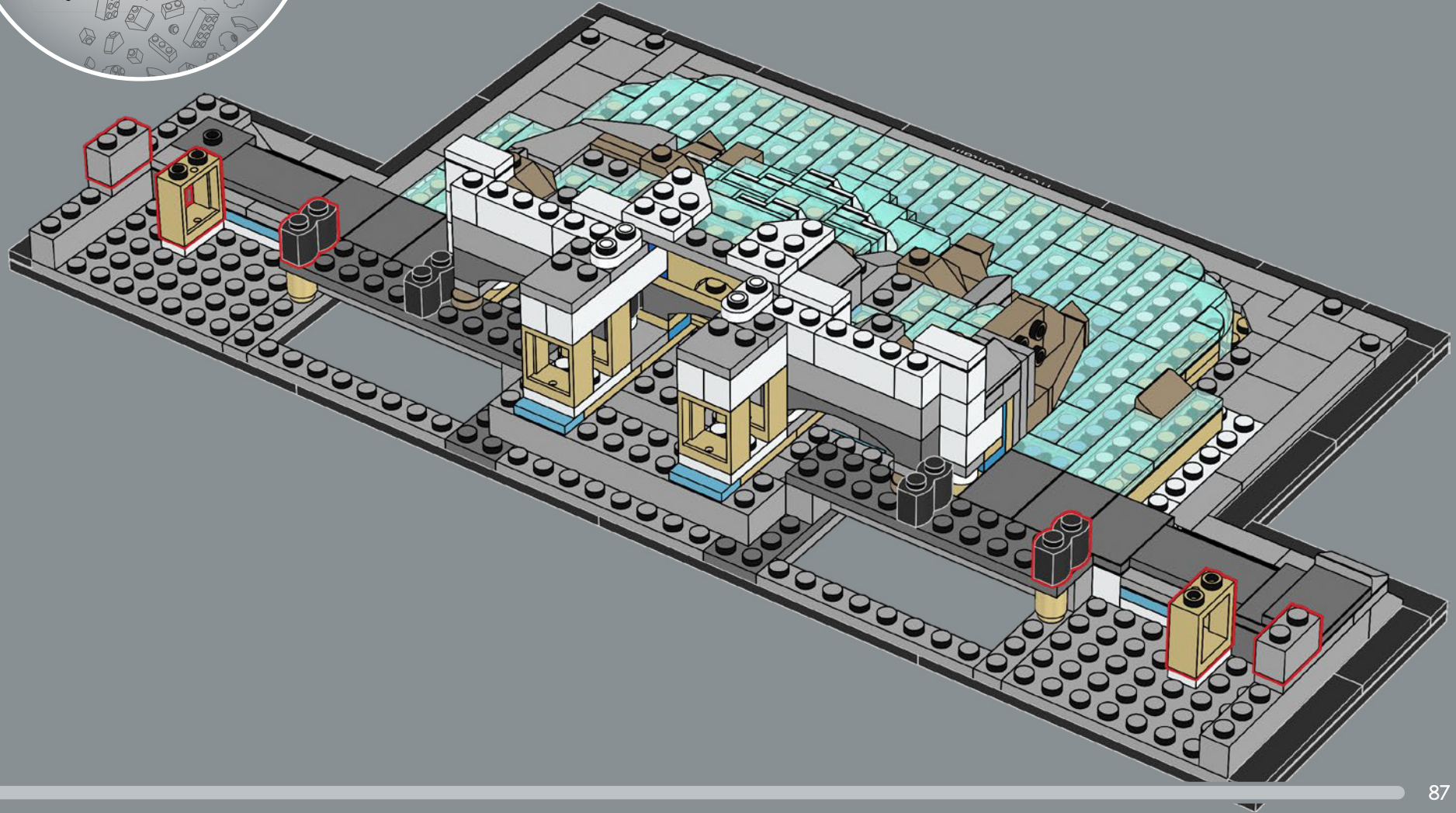

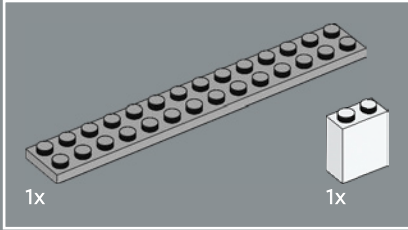
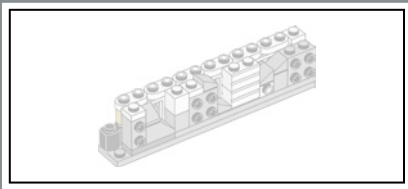

92

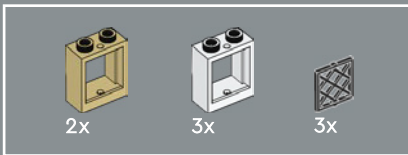
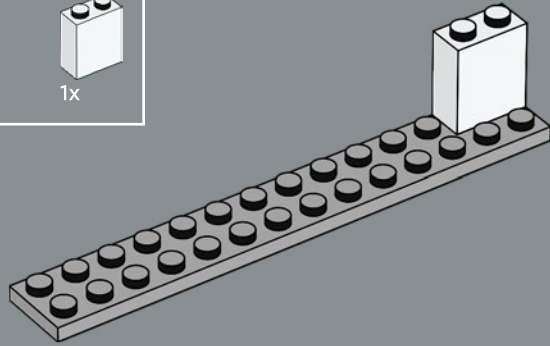

93

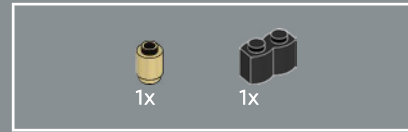
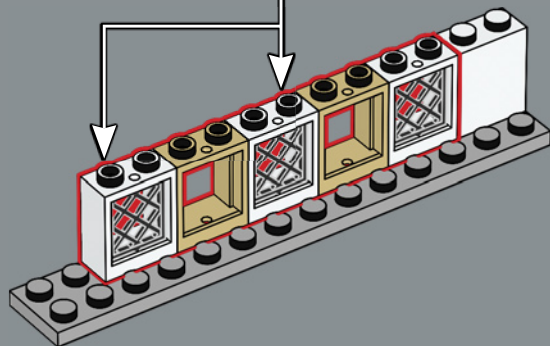
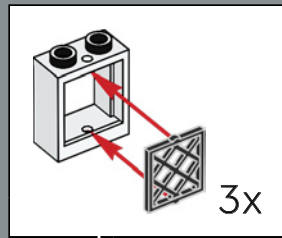

94

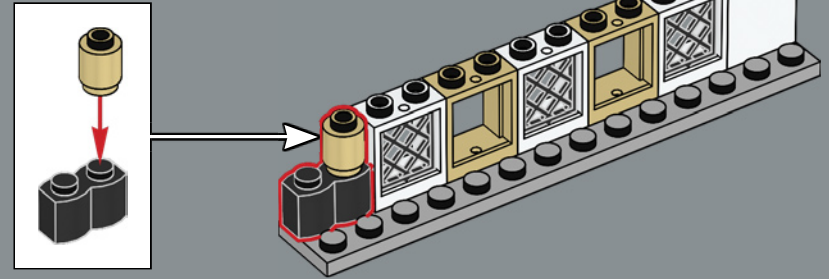

95

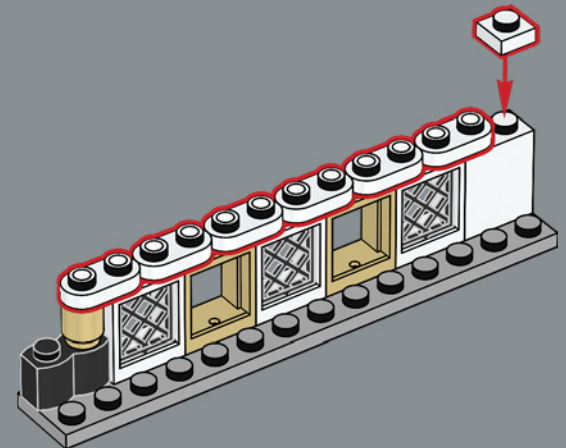



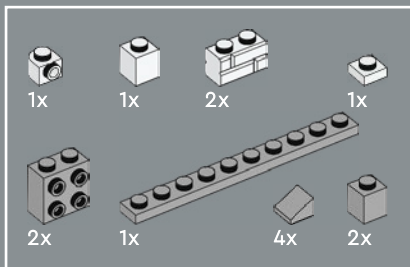

96

Dietro queste finestre si trovano i canali d'acqua degli acquedotti che sgorgano attraverso la cascata.

1

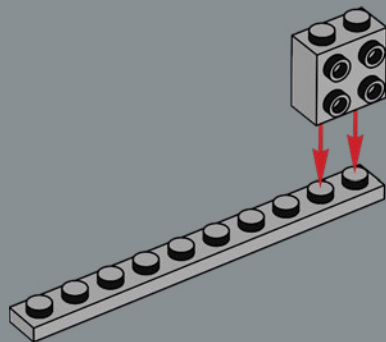

2

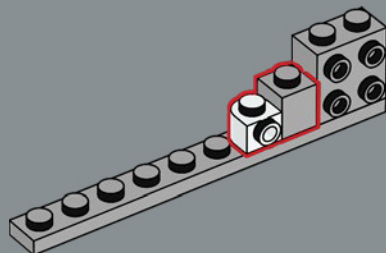

3

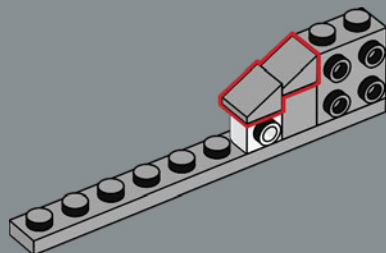

4

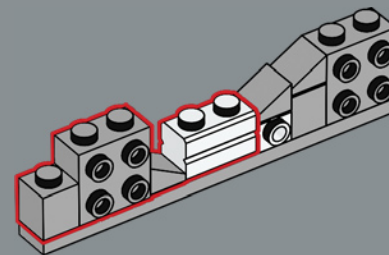

5

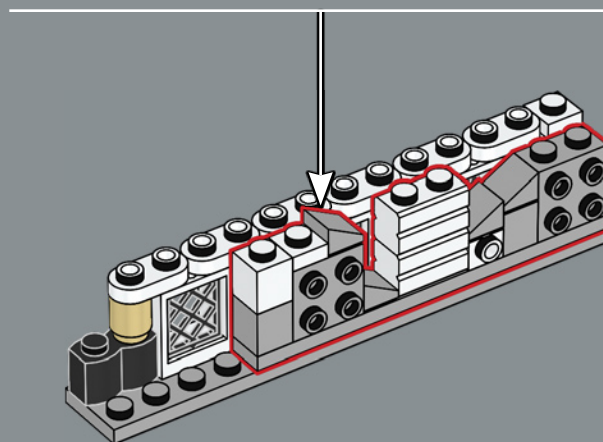
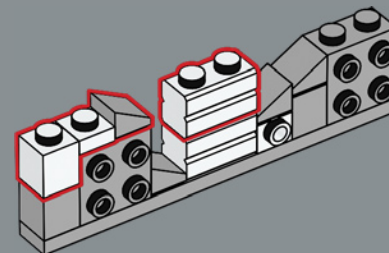

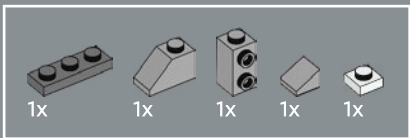

97

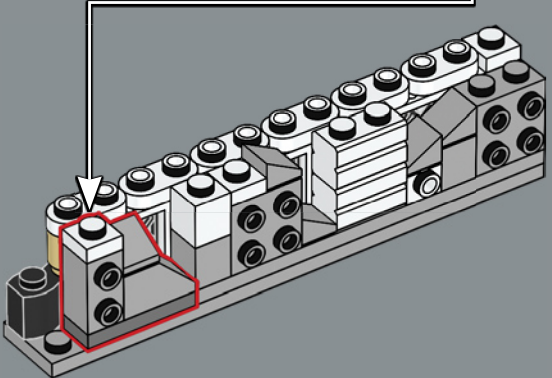
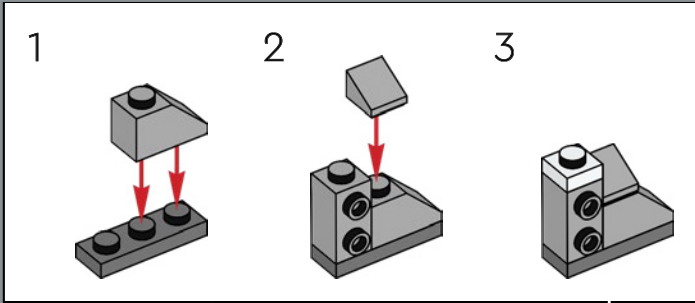

98

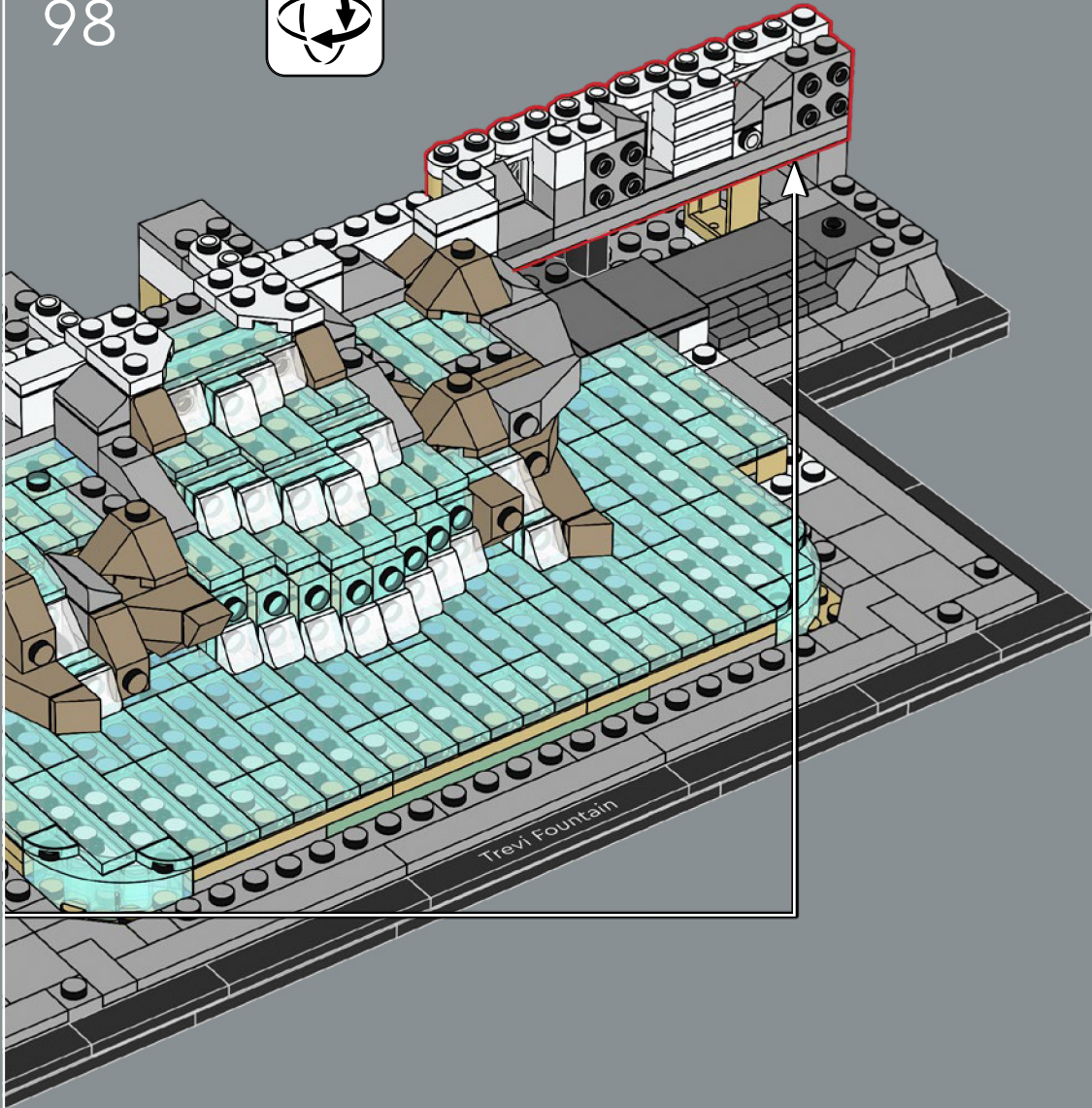

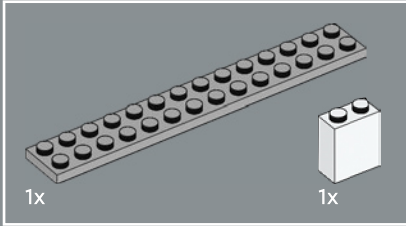
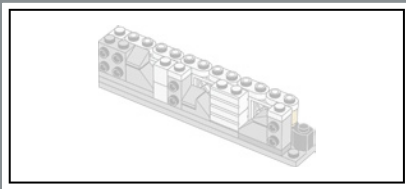

99

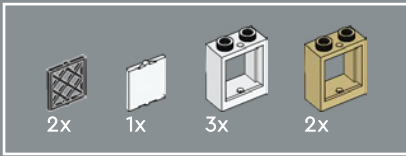
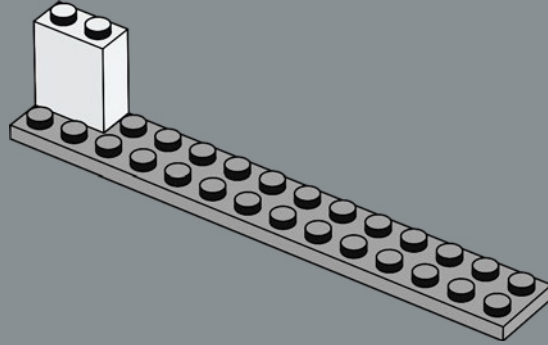

100

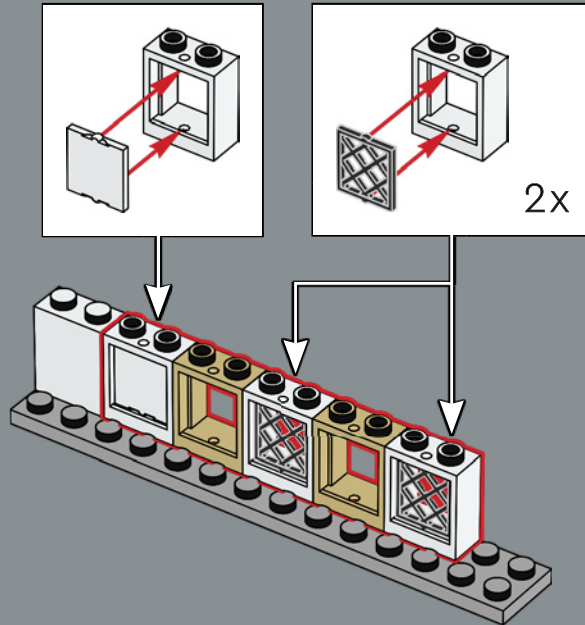

101

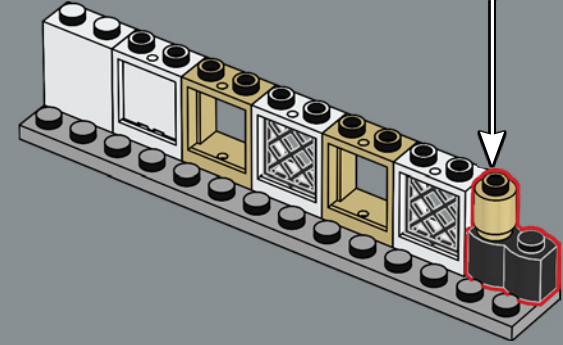
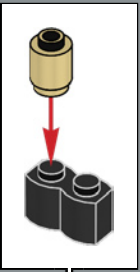

102

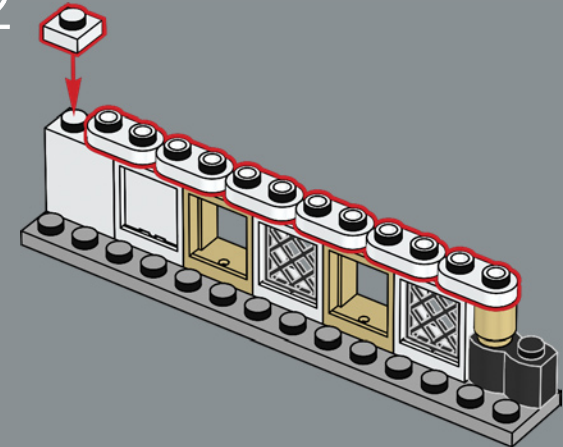

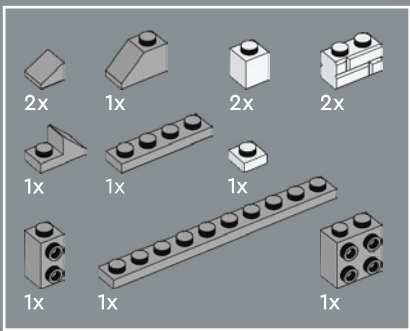

103

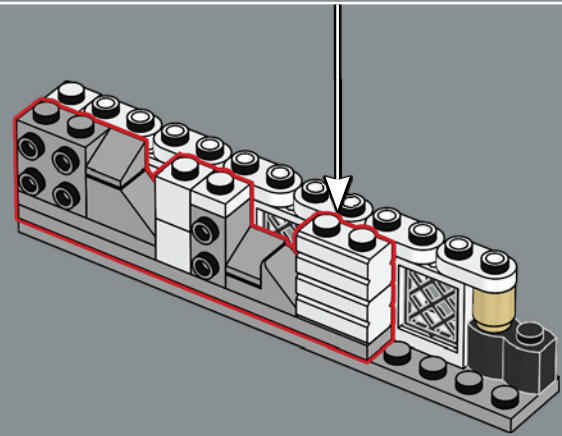
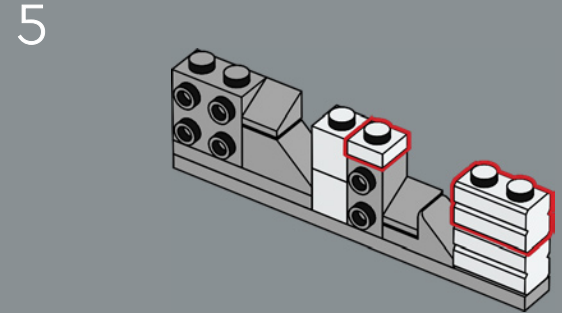
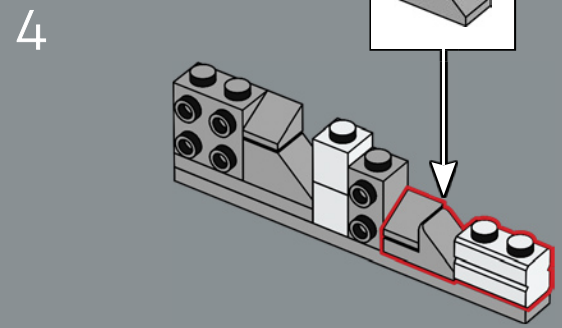
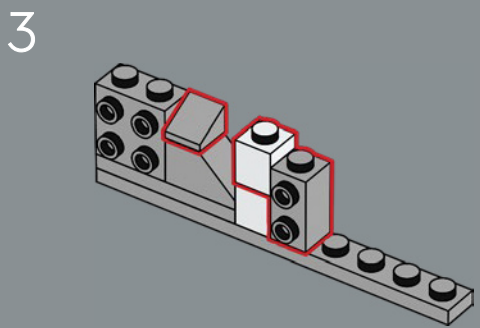
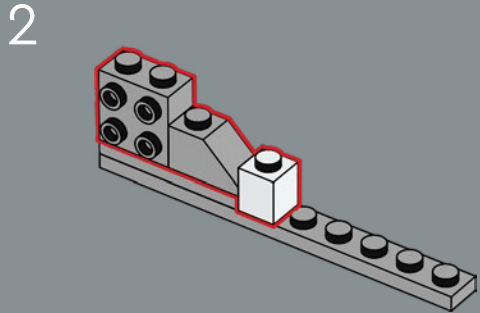
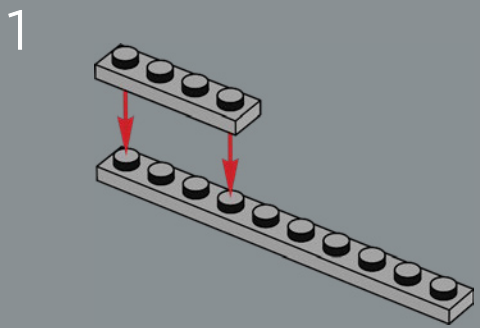

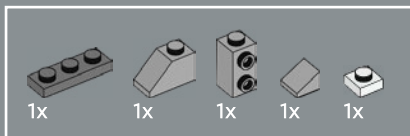

104

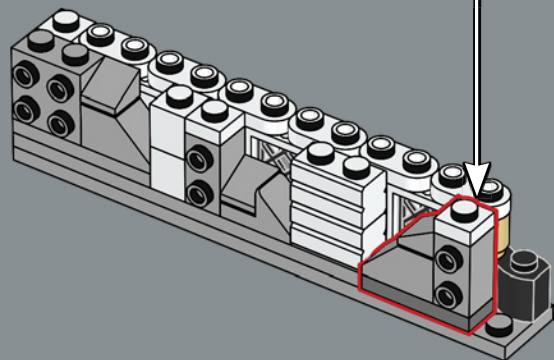
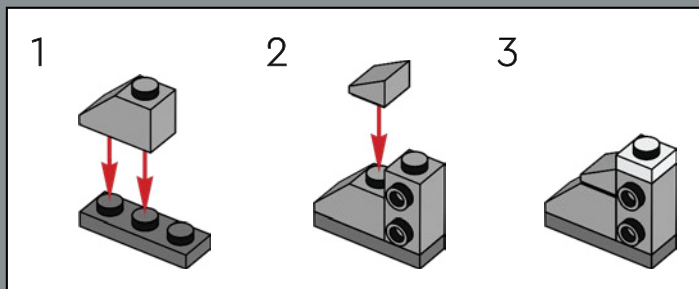

105

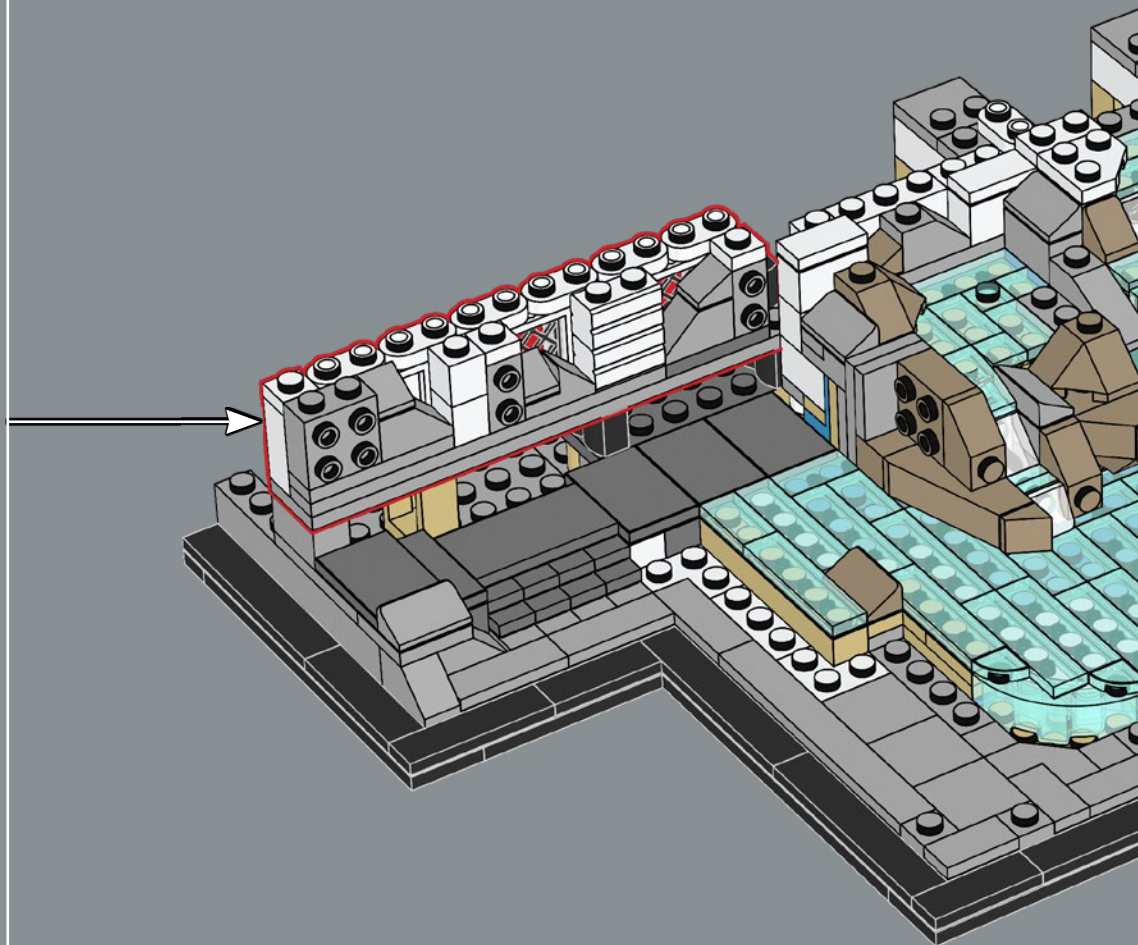

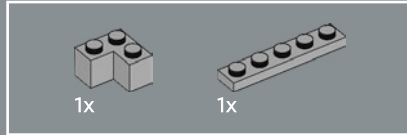
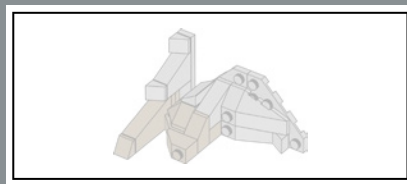

106

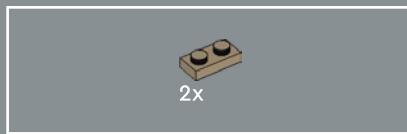
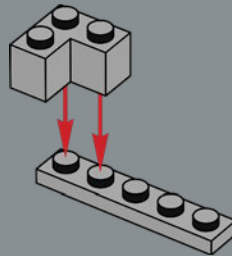

107

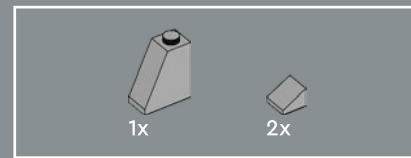
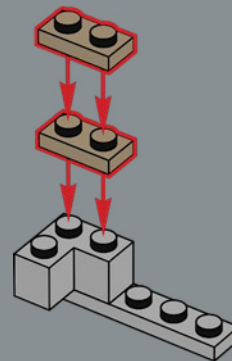

108

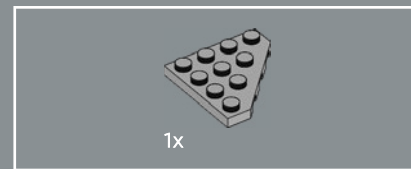
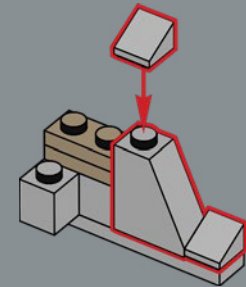

109

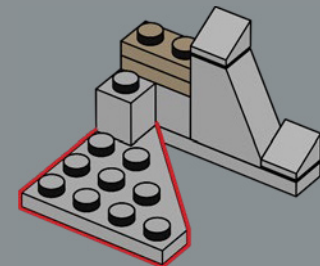

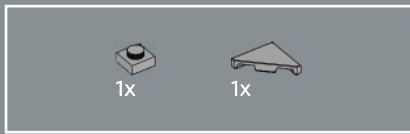

110

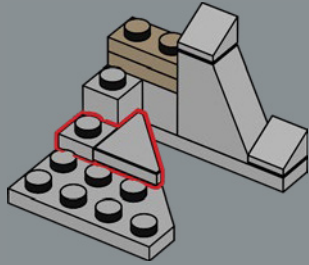

112

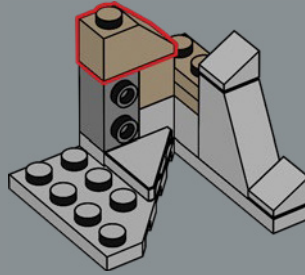

114

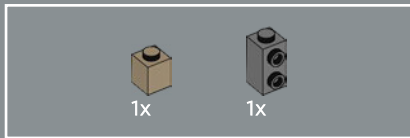
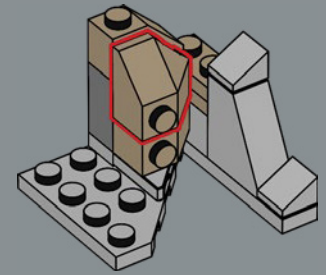

111

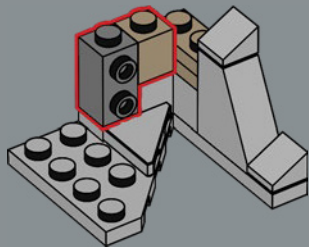

113

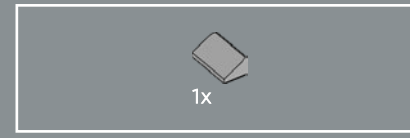
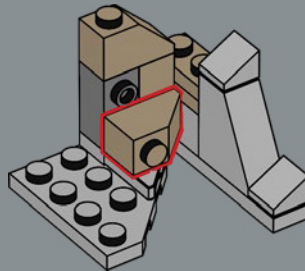

115

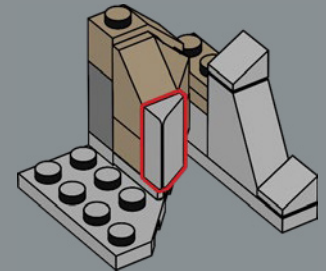

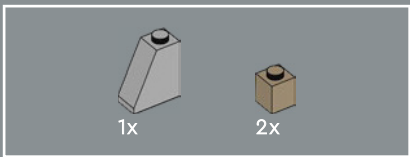

116

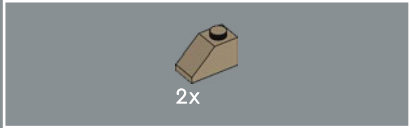
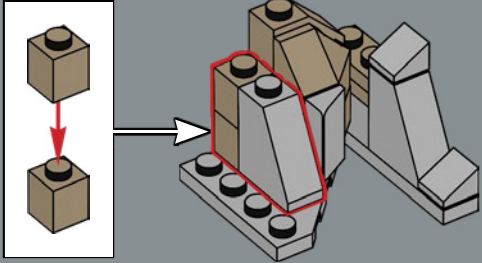

117

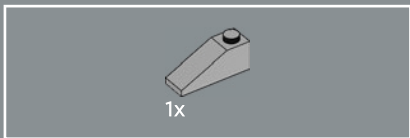
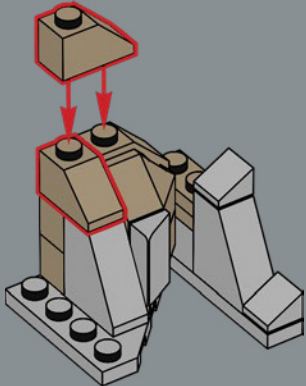

118

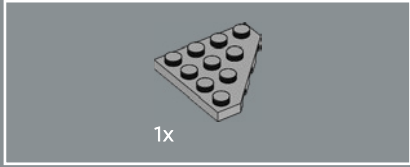
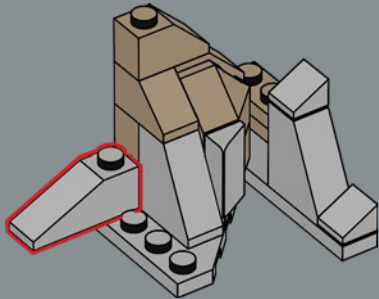

119

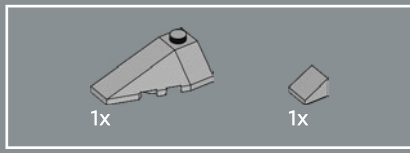
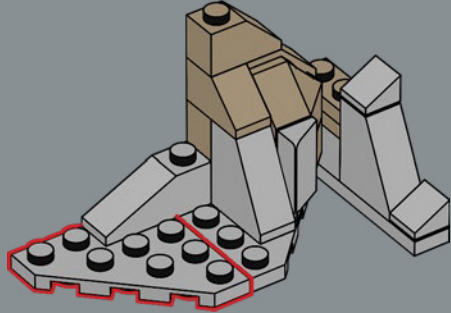

120

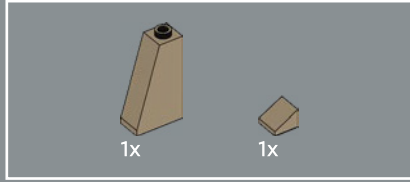
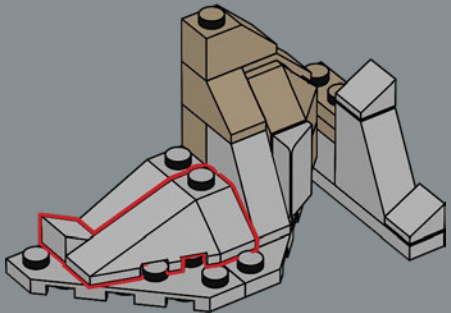

121

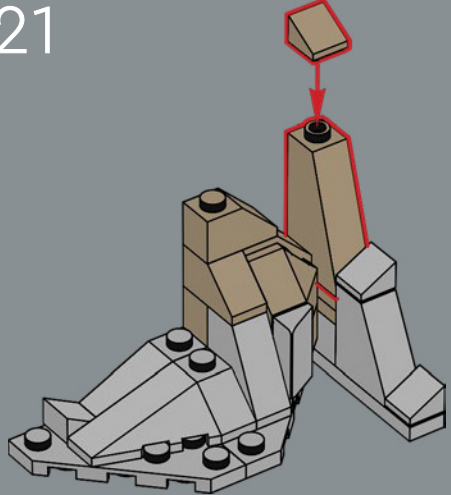



122

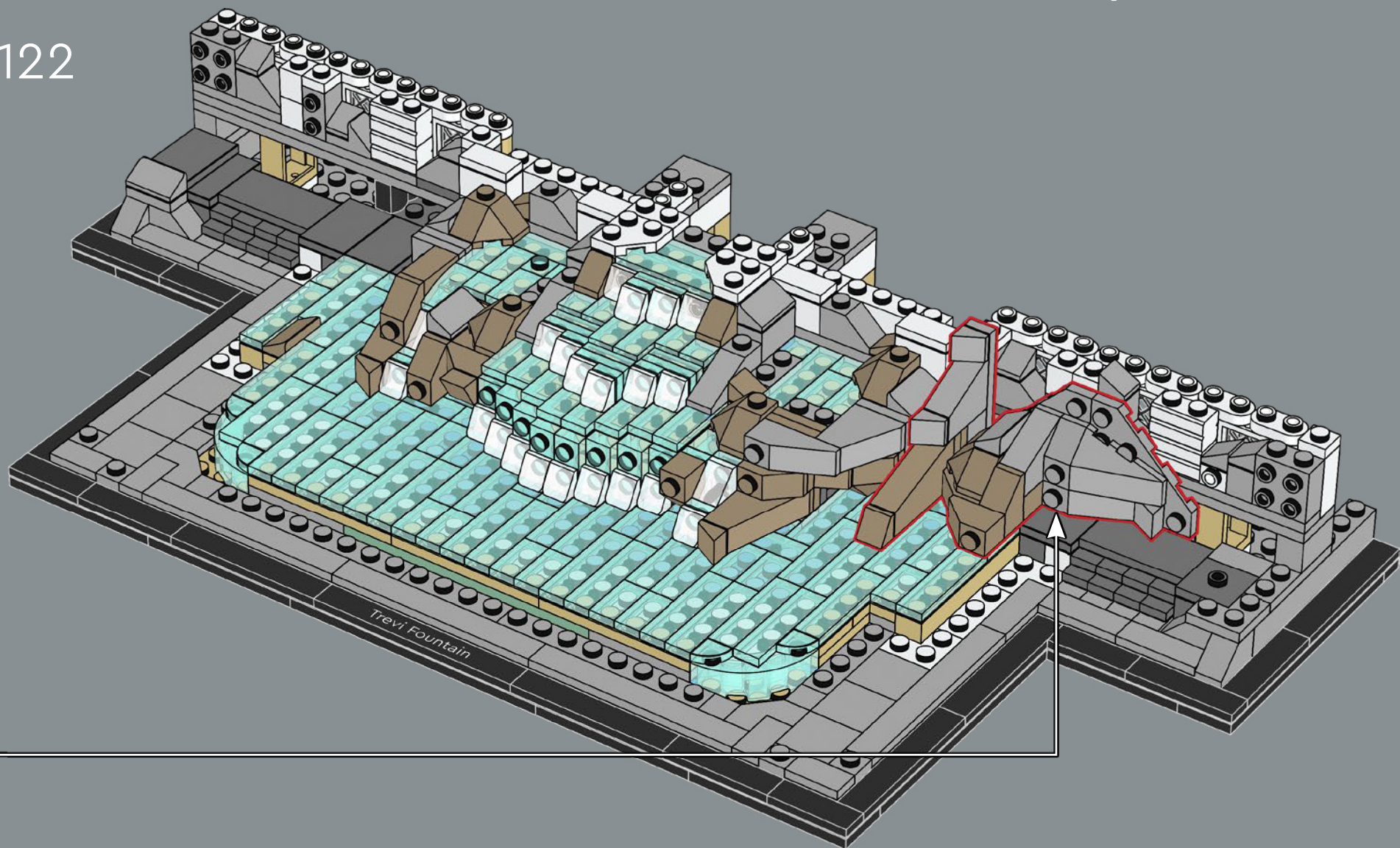

Le parti in roccia sono uno dei pochi dettagli che sconvolge la simmetria complessiva della struttura barocca, aggiungendo allo stesso tempo uno straordinario contrasto con il resto della facciata con le sue forme organiche.

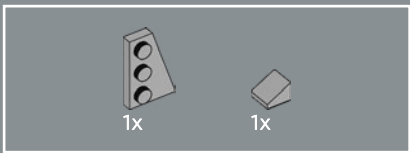

123

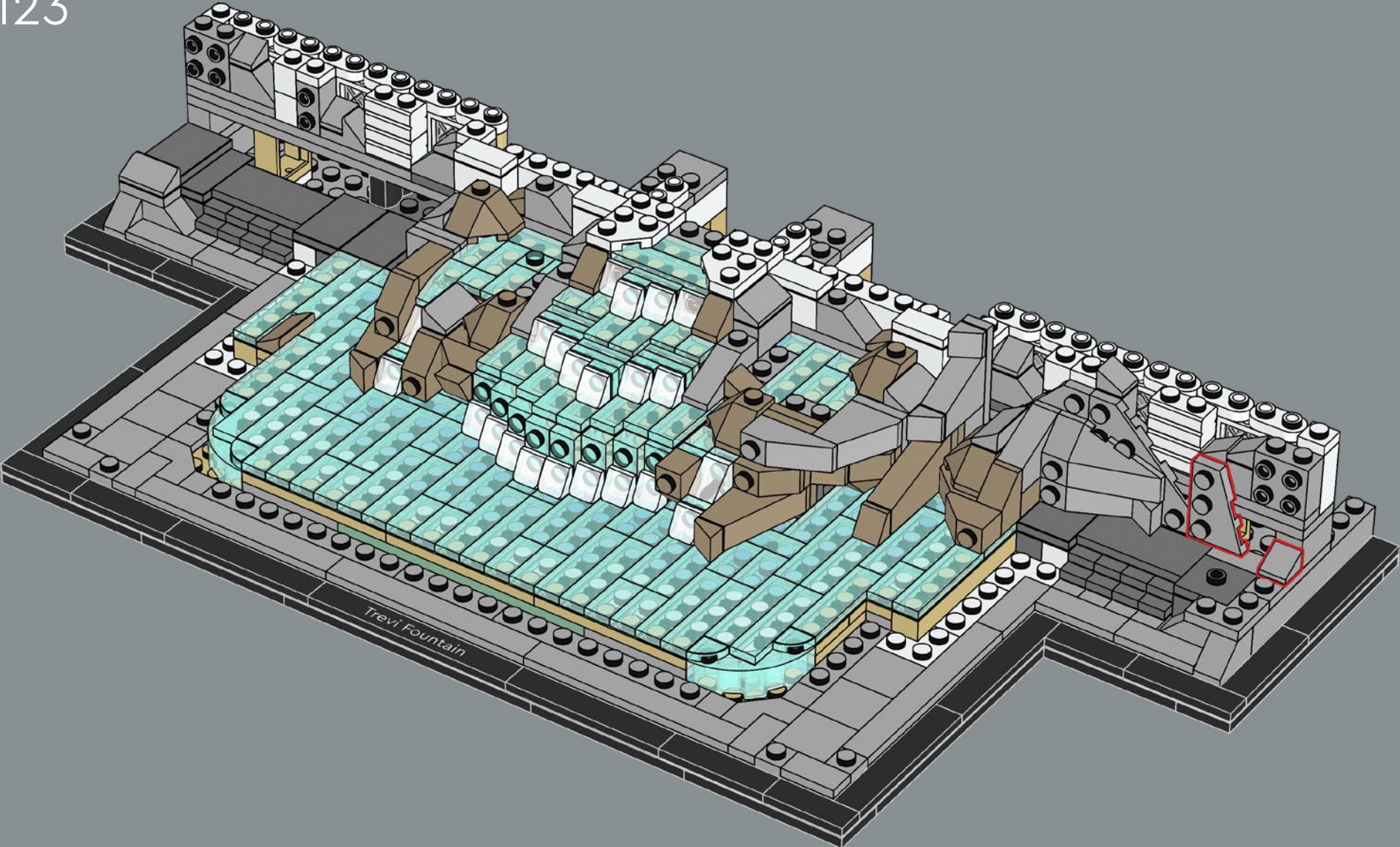

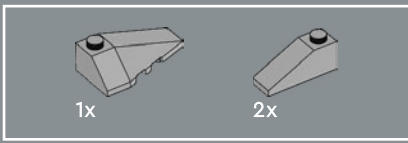

124

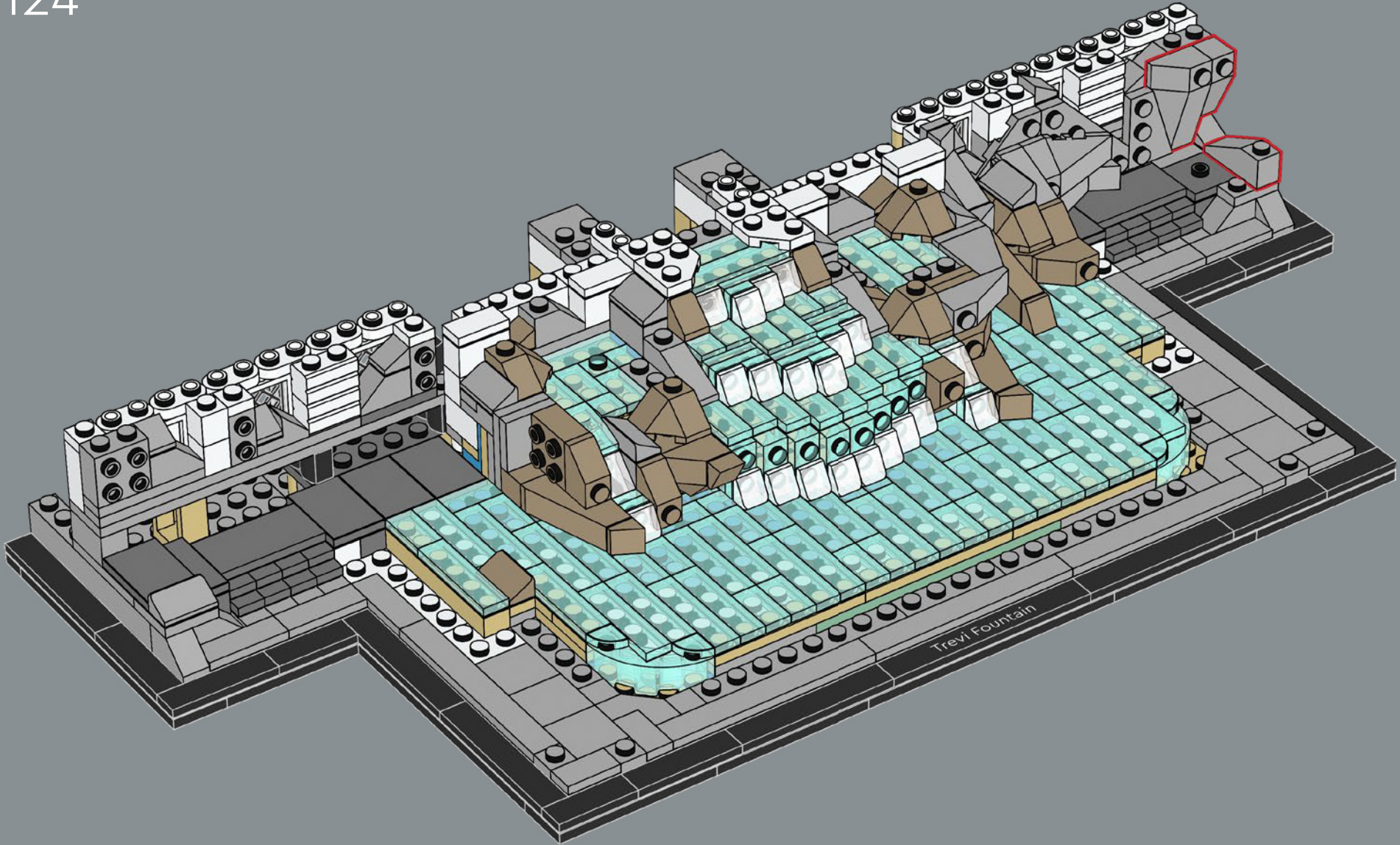

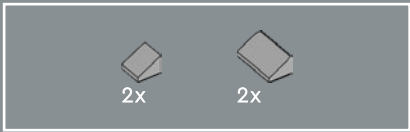

125

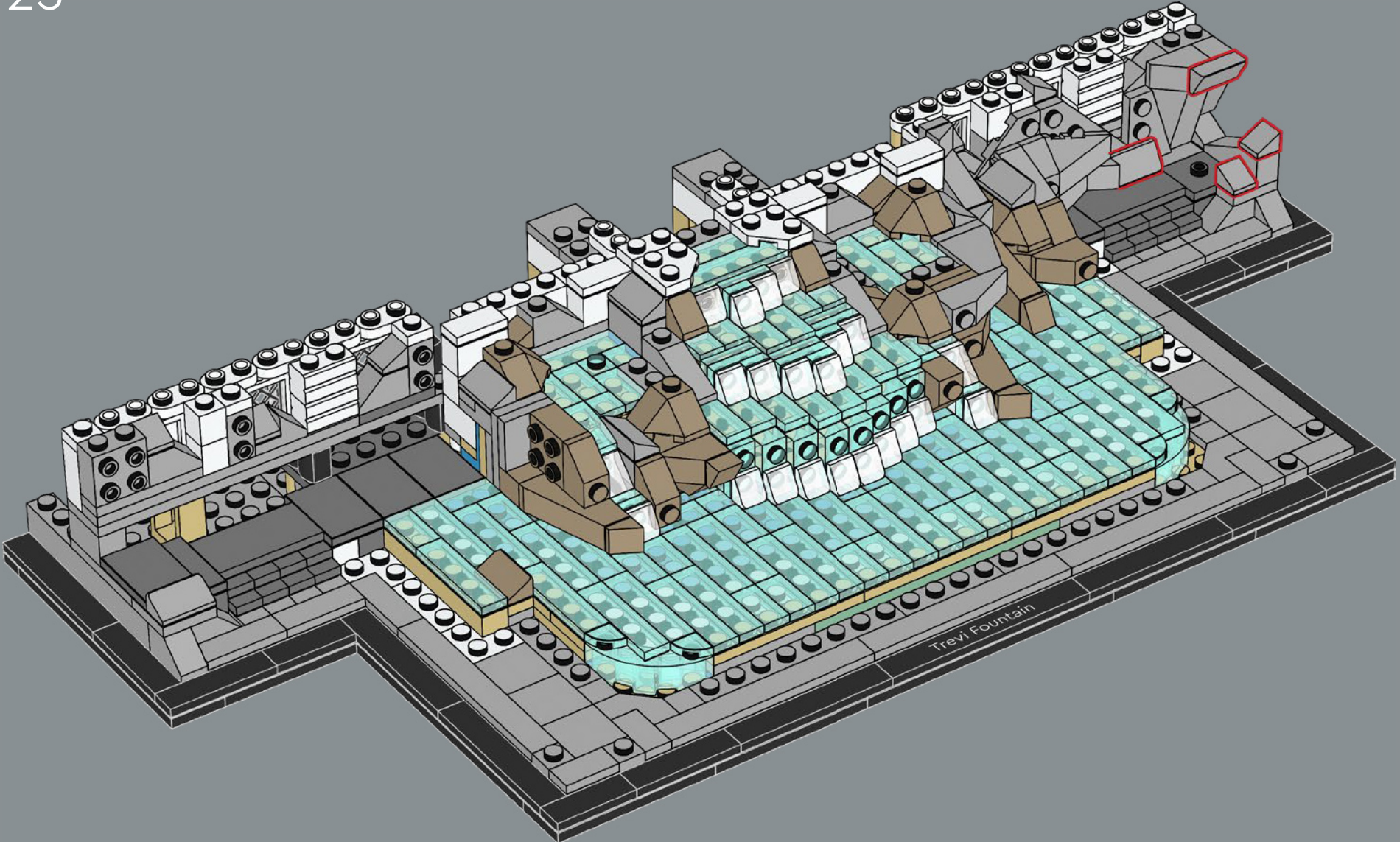

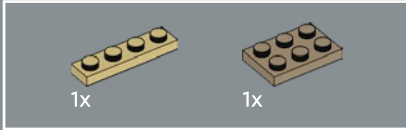
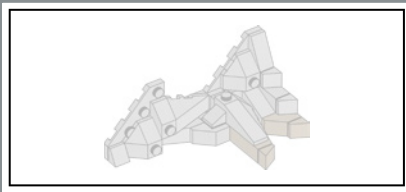

126

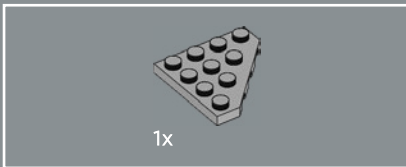
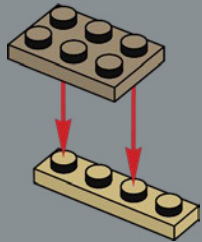

127

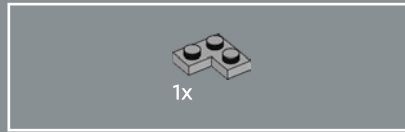
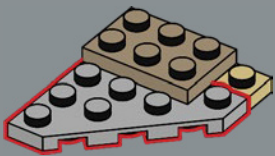

128

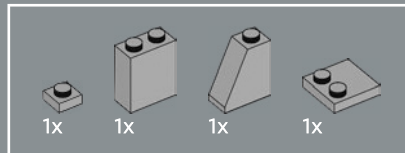
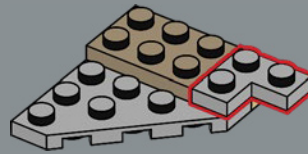

129

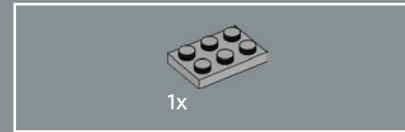
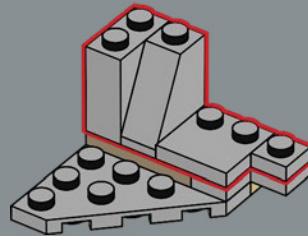

130

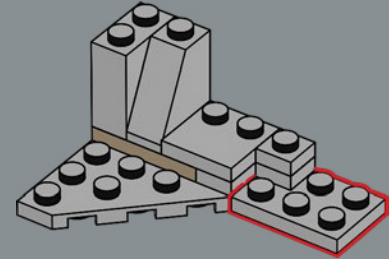

131

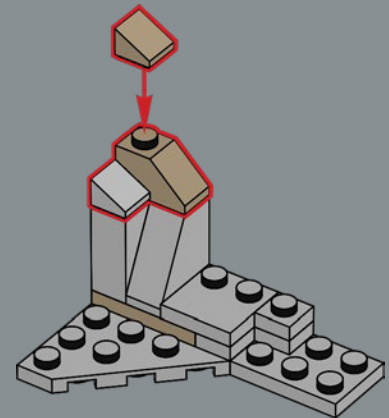



132

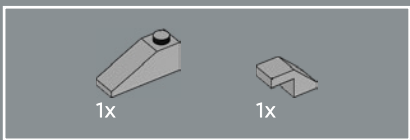
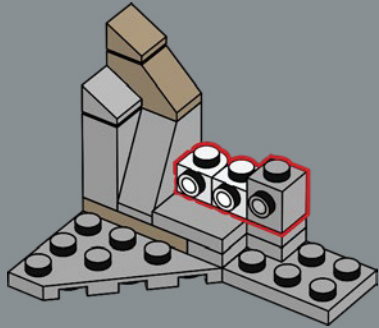

133

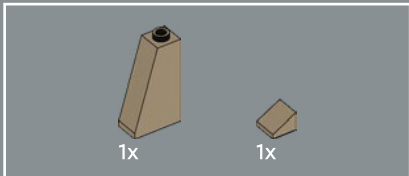
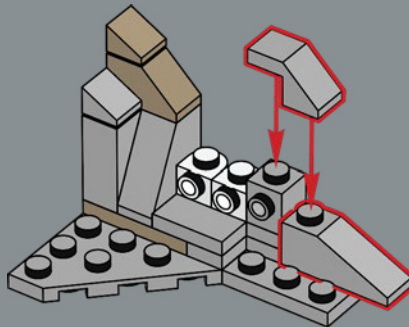

134

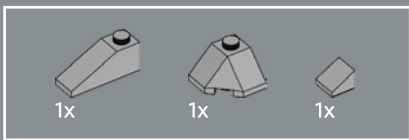
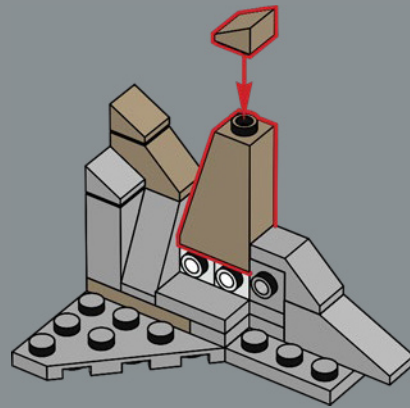

135

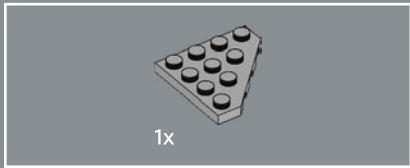
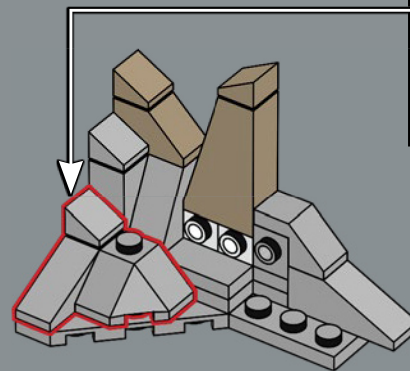

136

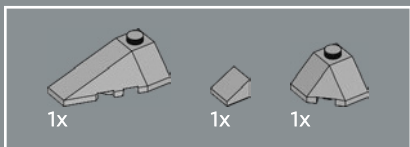
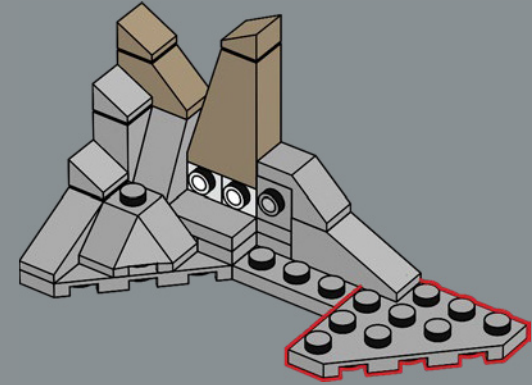

137

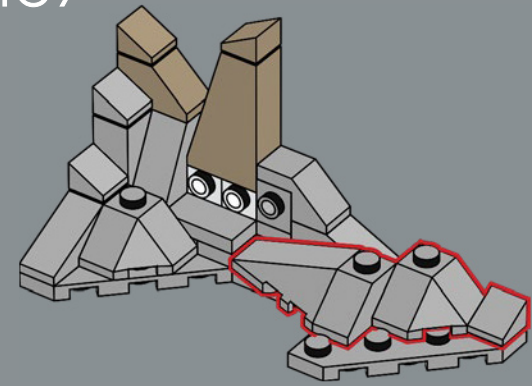

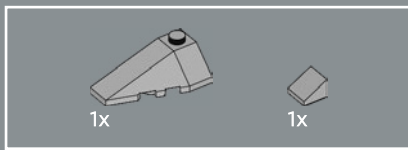

138

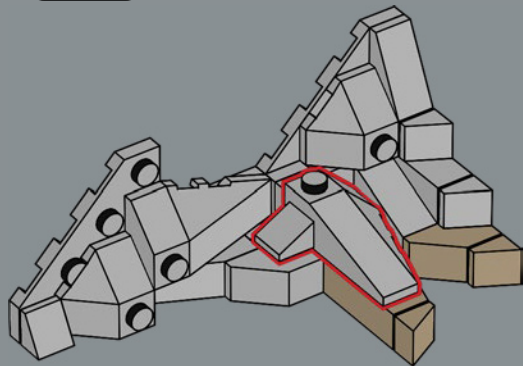

139

Persino l'usura della fontana gioca un ruolo nel modo in cui viene ammirata. Un certo degrado ambientale è presente negli angoli e nelle fessure della facciata scolpita, lasciando incisioni anche superficiali di colore più scuro rispetto alla roccia circostante.

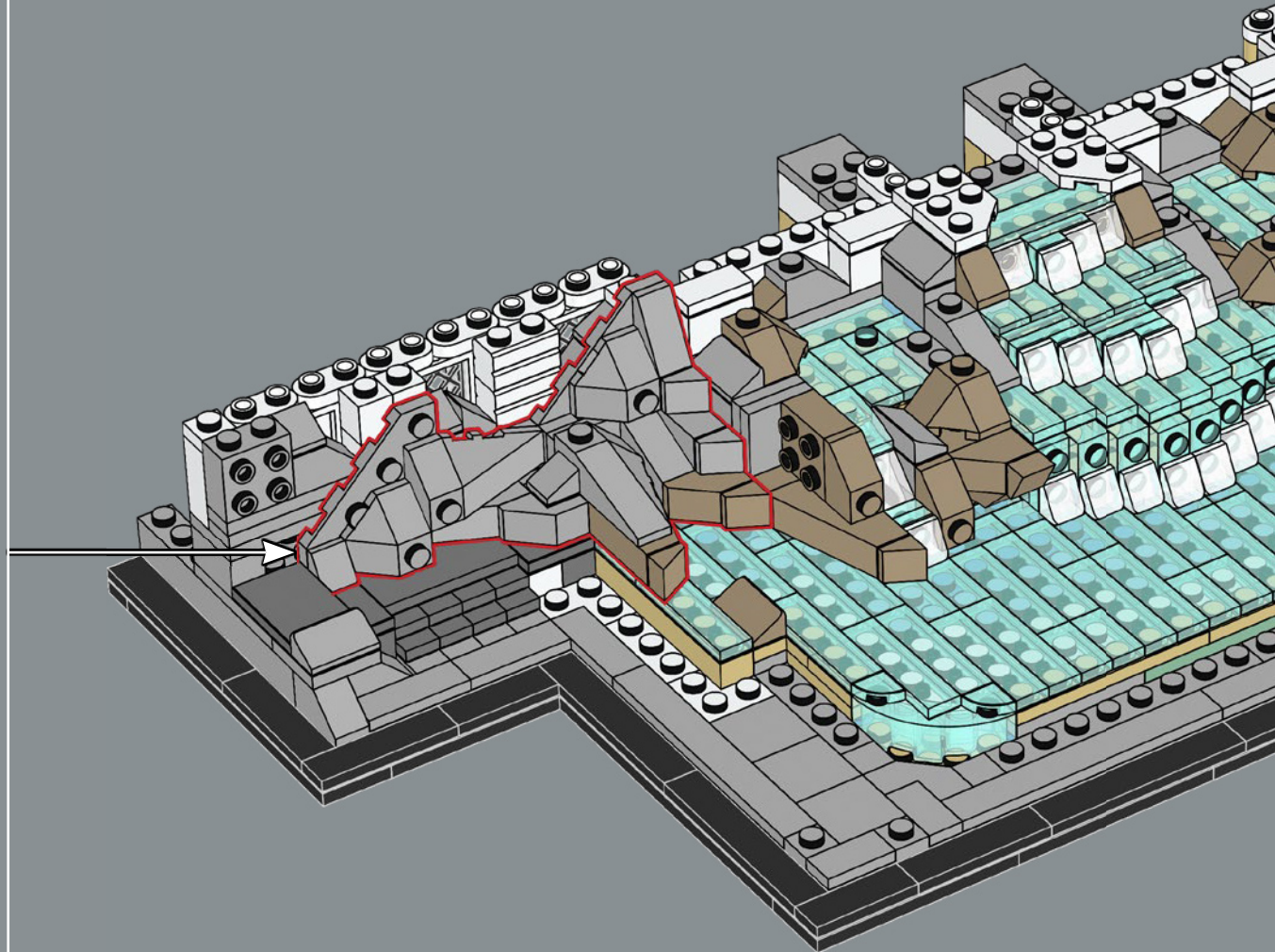

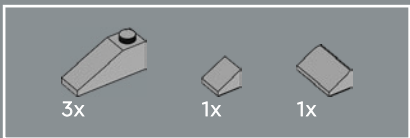

140

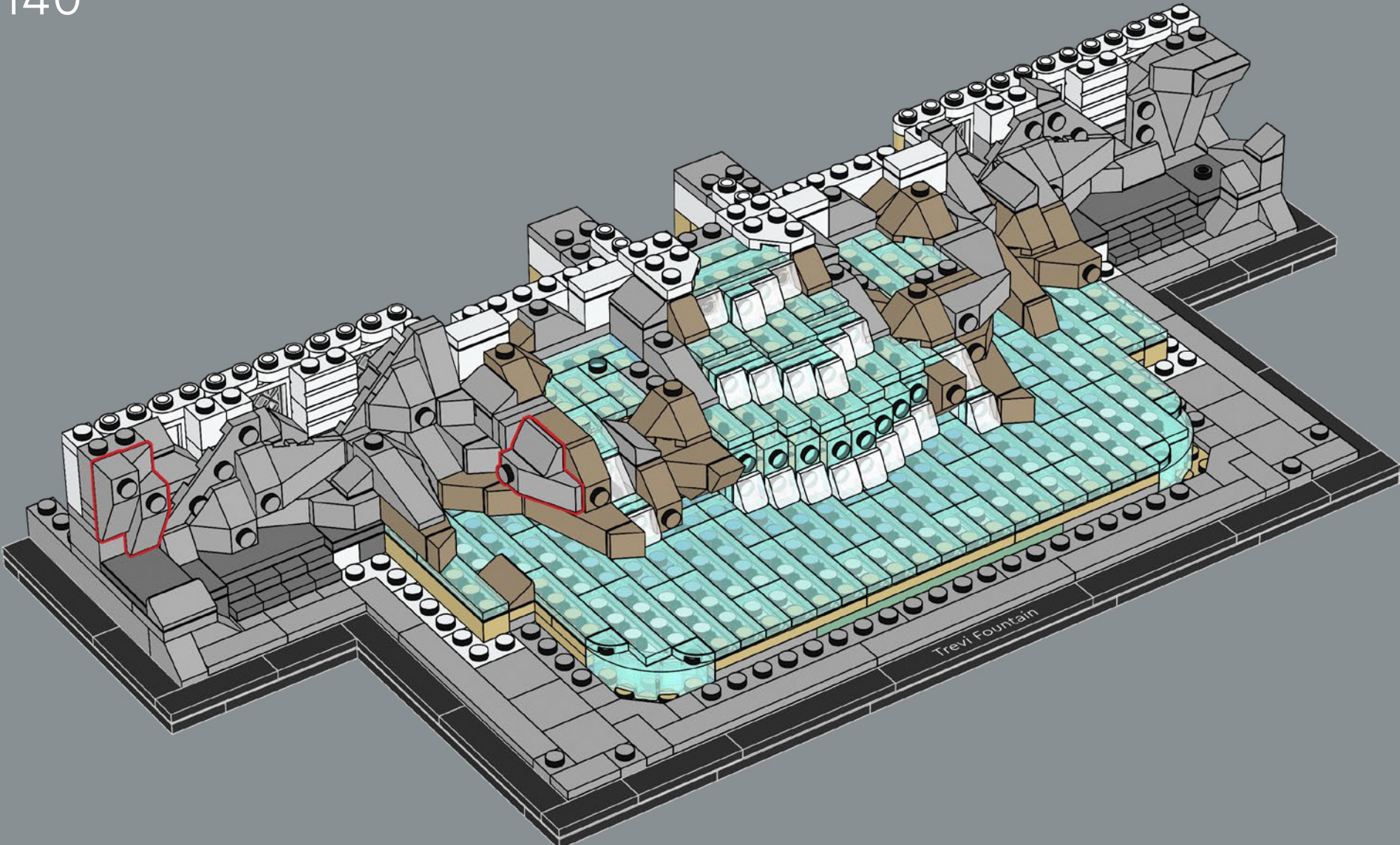



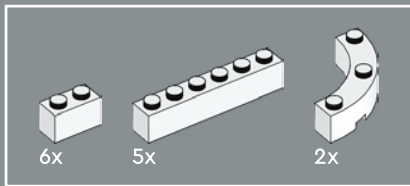

141

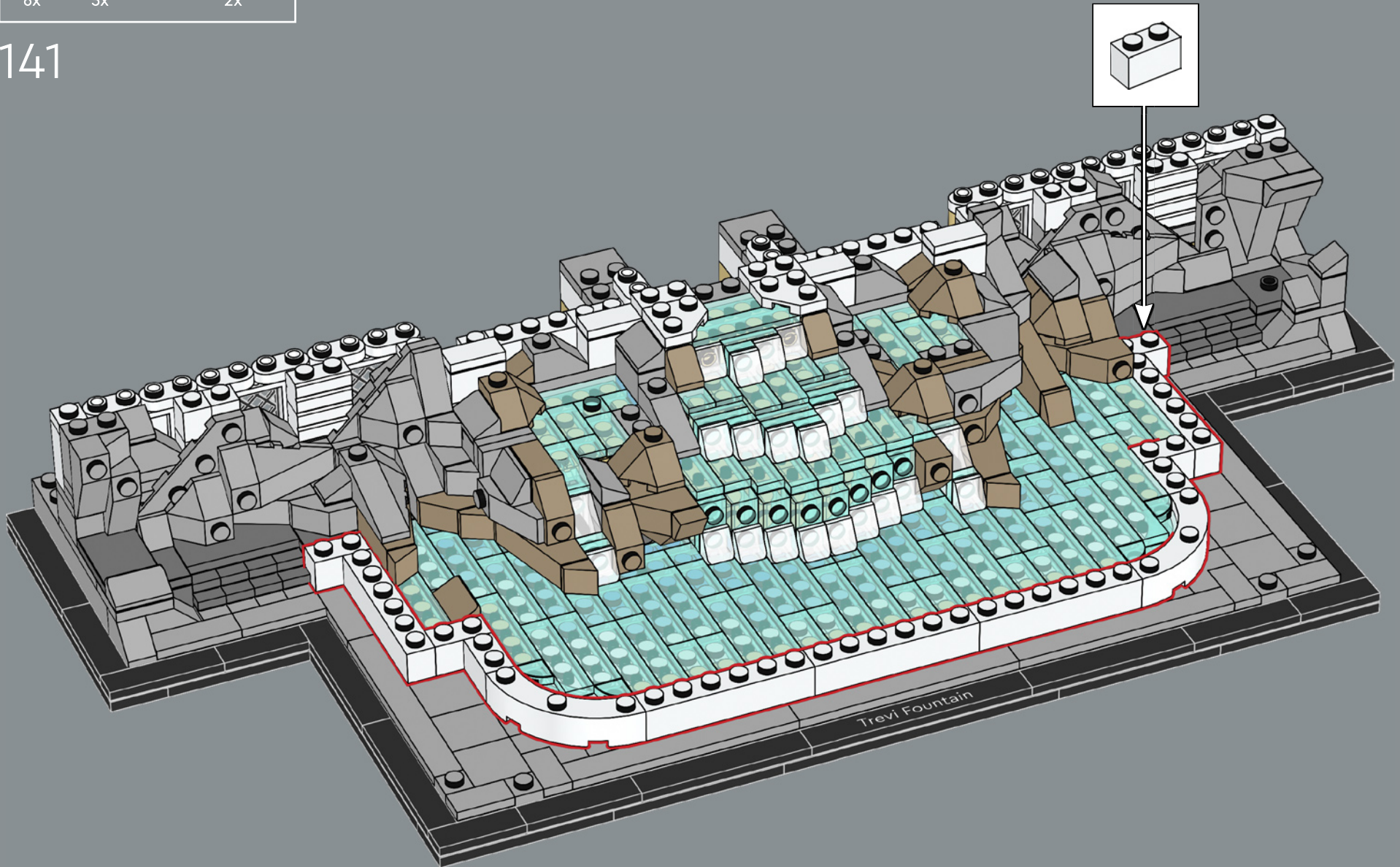

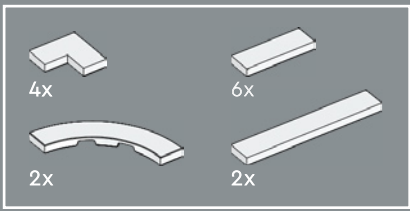

142

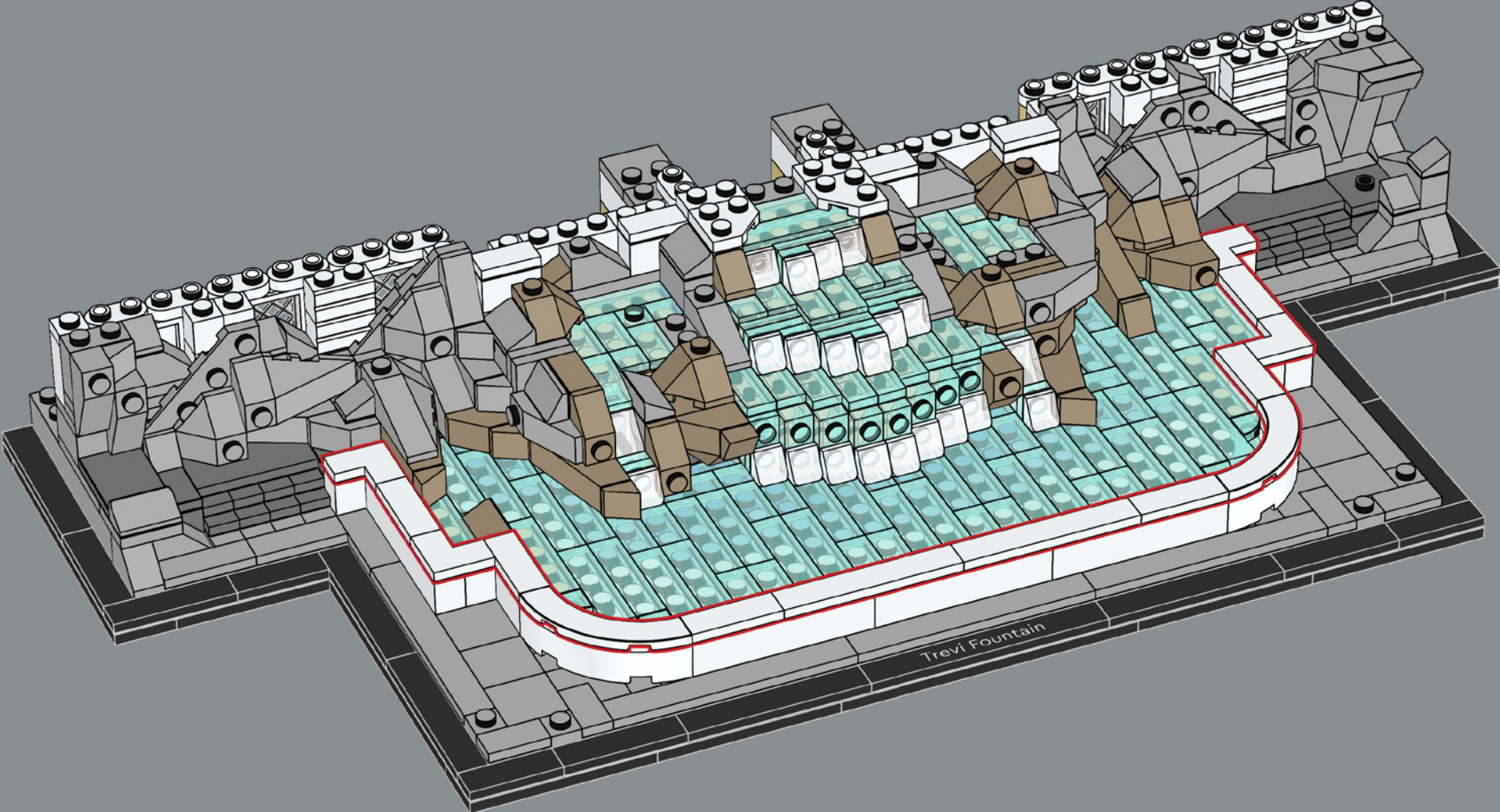

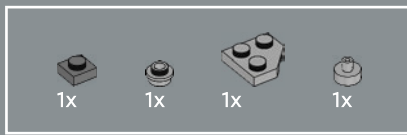

143

Questa piccola fontana è chiamata Fontana degli Innamorati per via dei suoi getti d'acqua incrociati. La leggenda dice che se due innamorati bevono da questa fontana rimarranno fedeli l'uno all'altro per sempre.

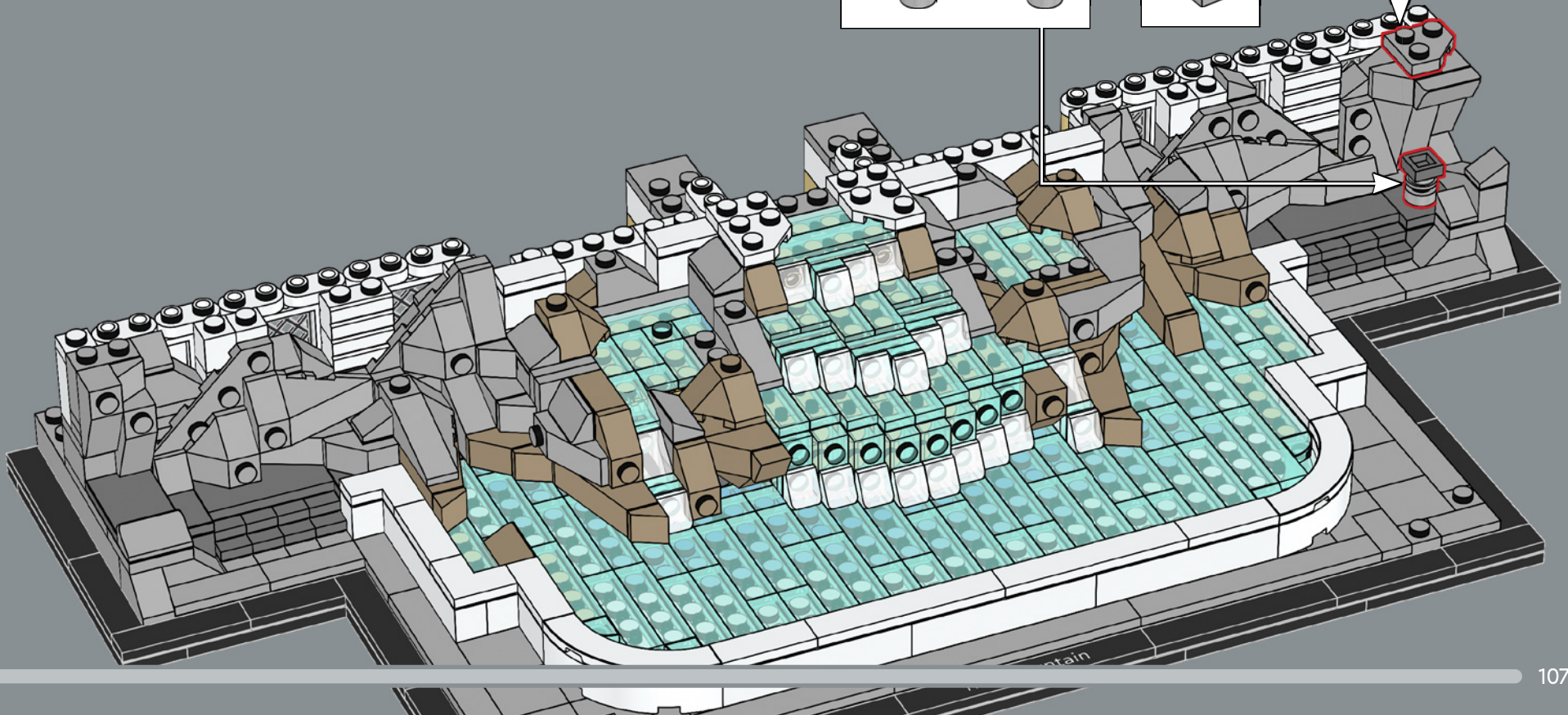
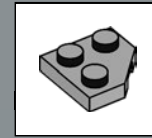
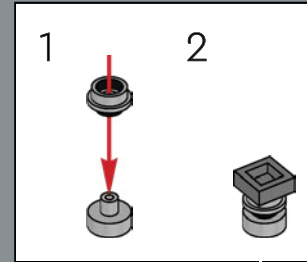

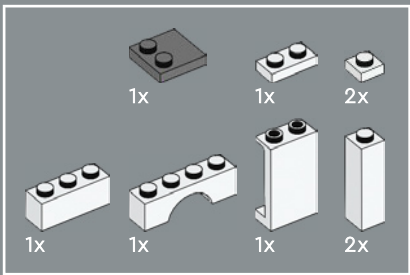

144

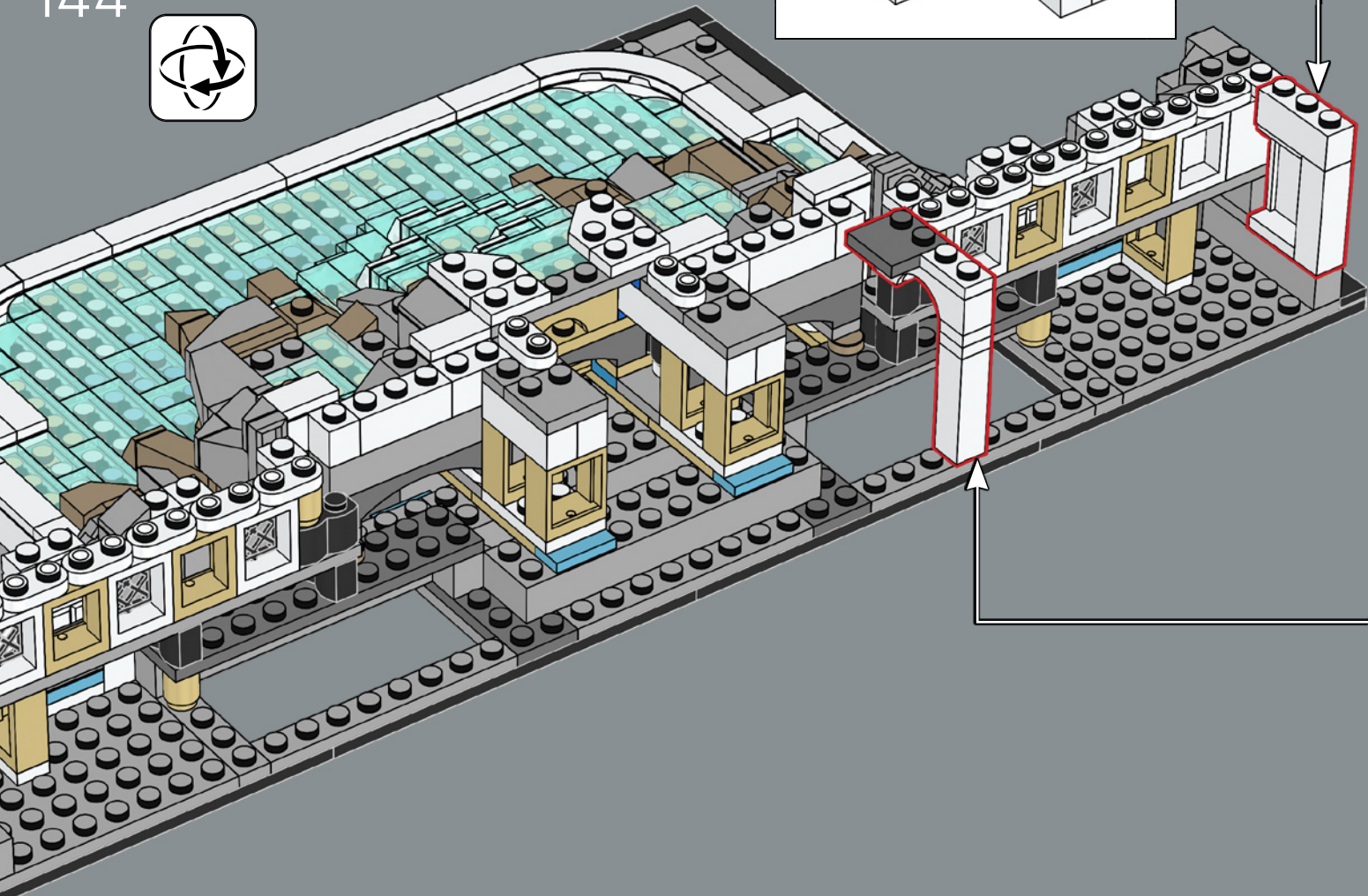
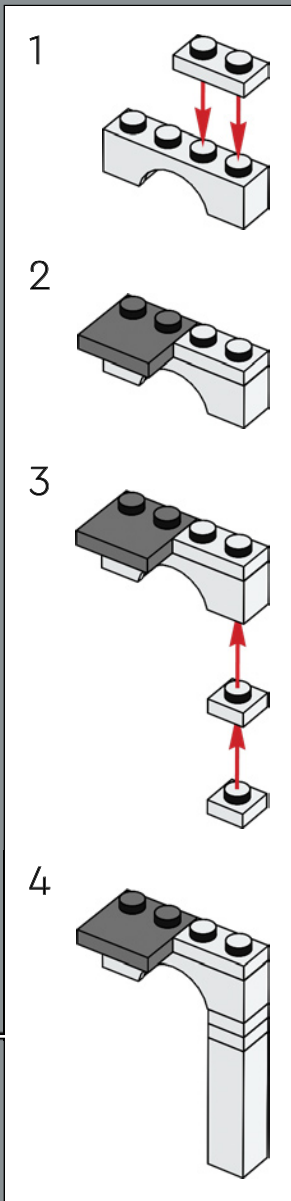
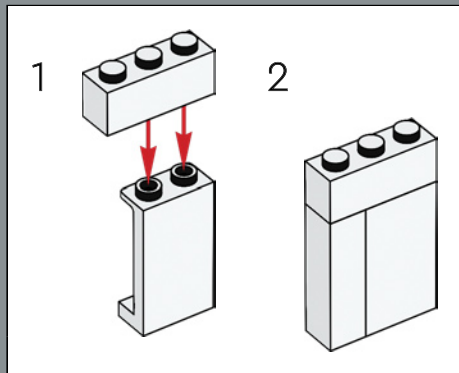

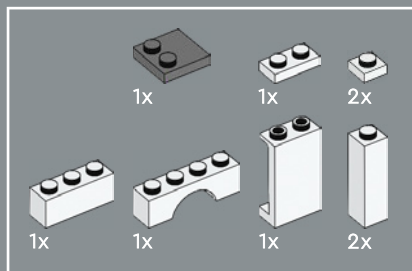

145

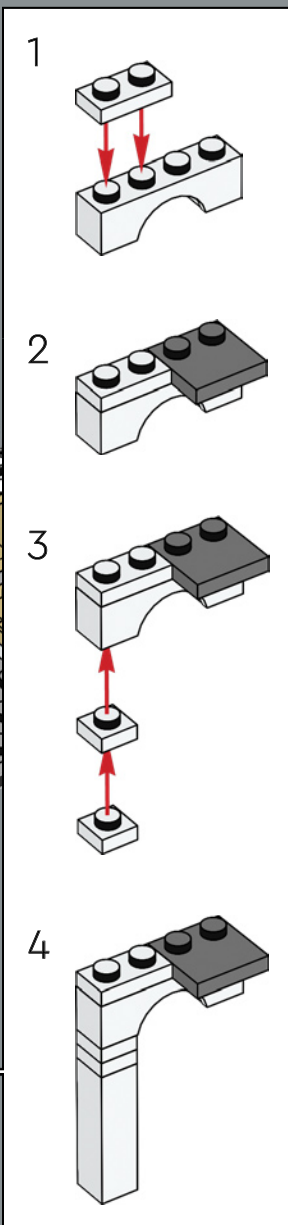
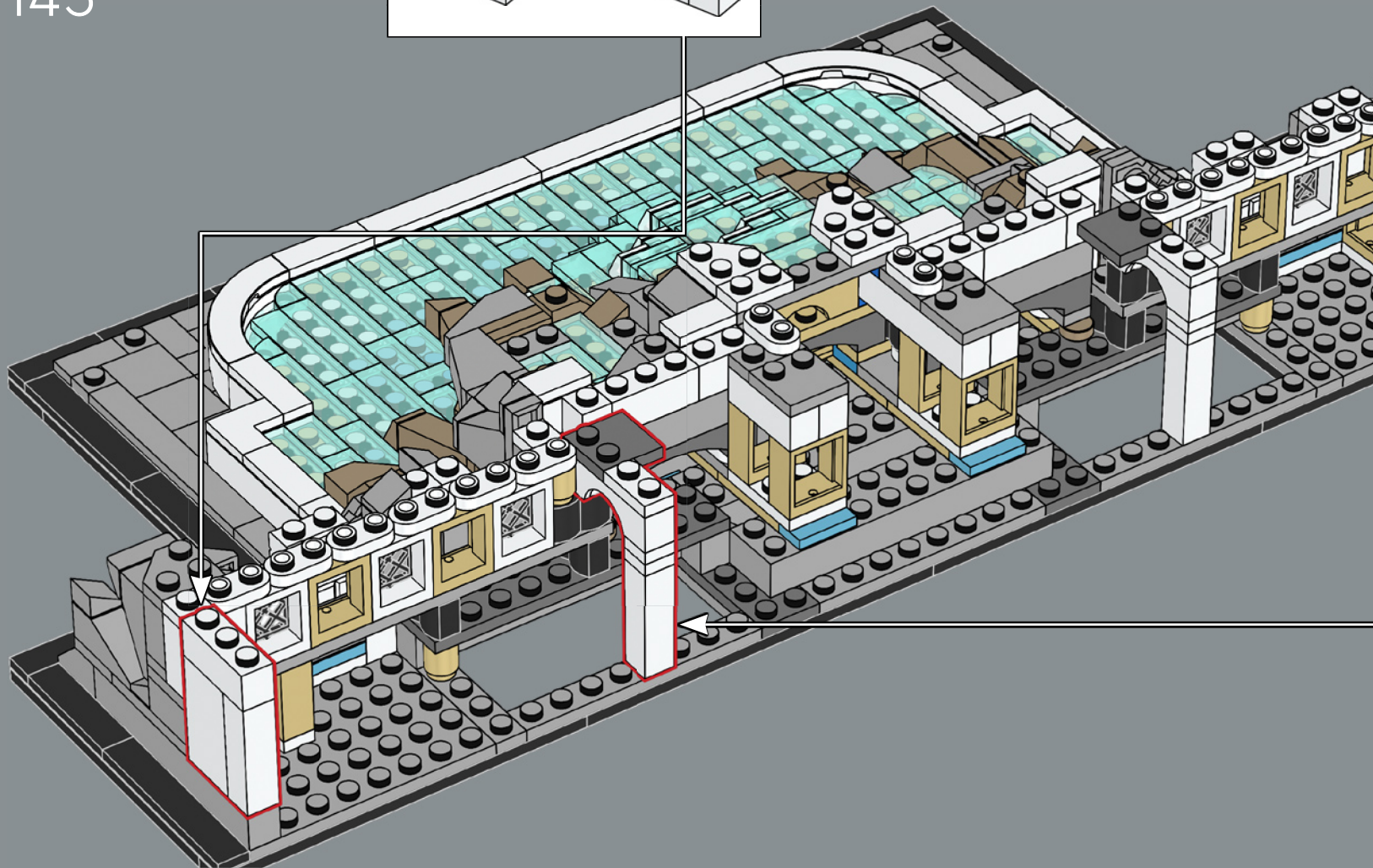
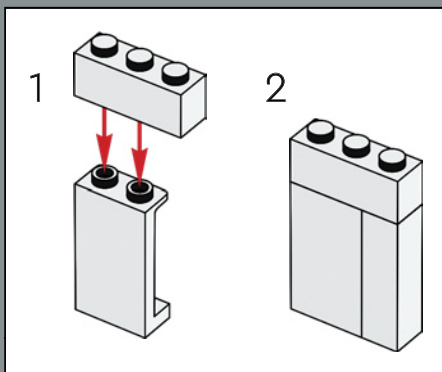

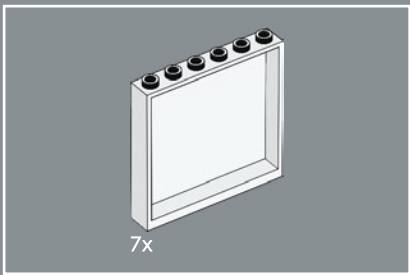

146

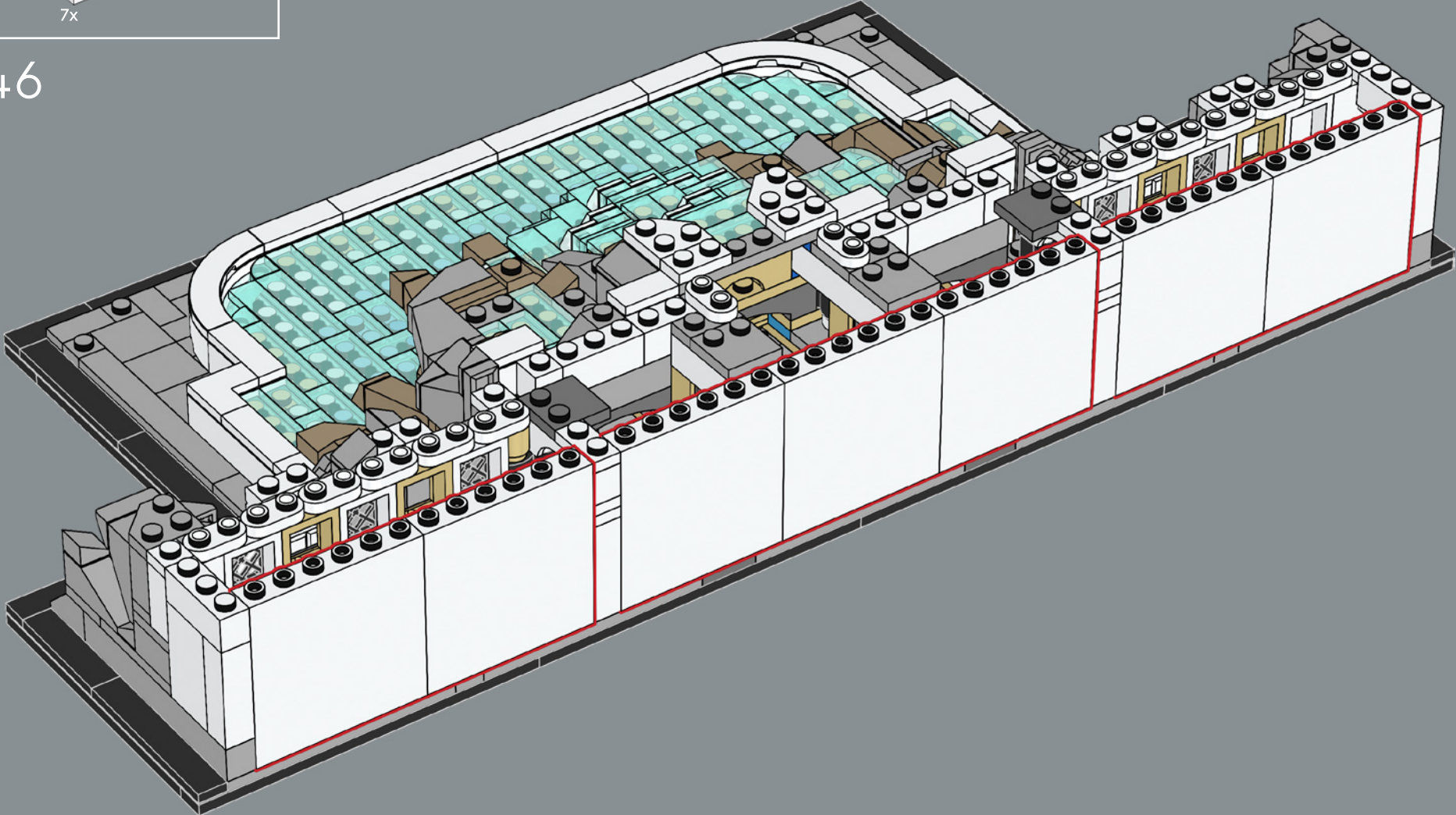

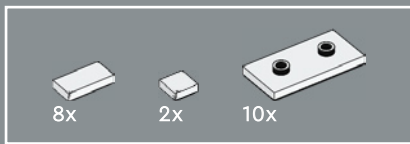

147

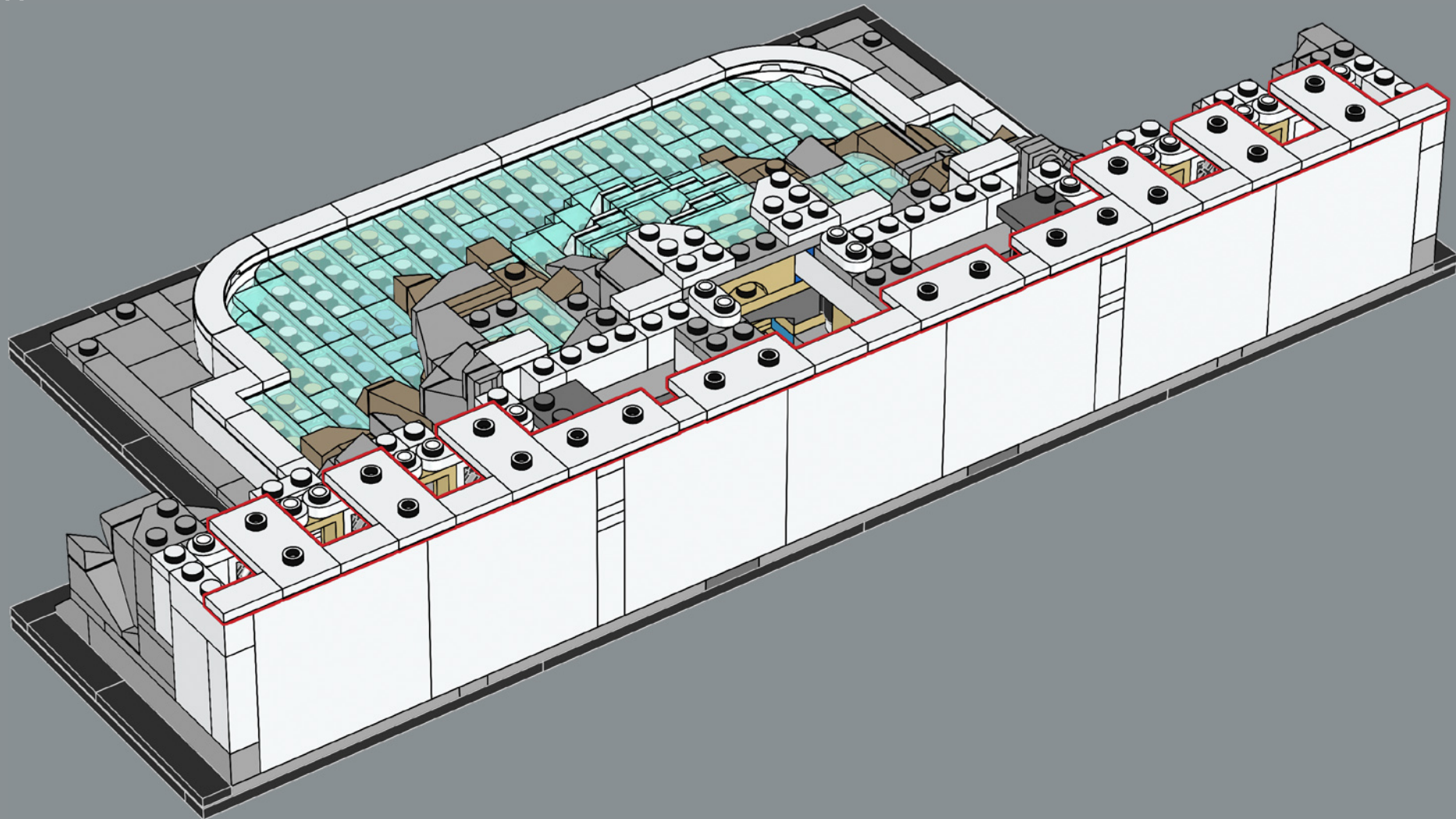

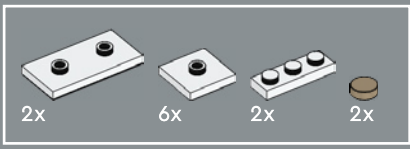

148

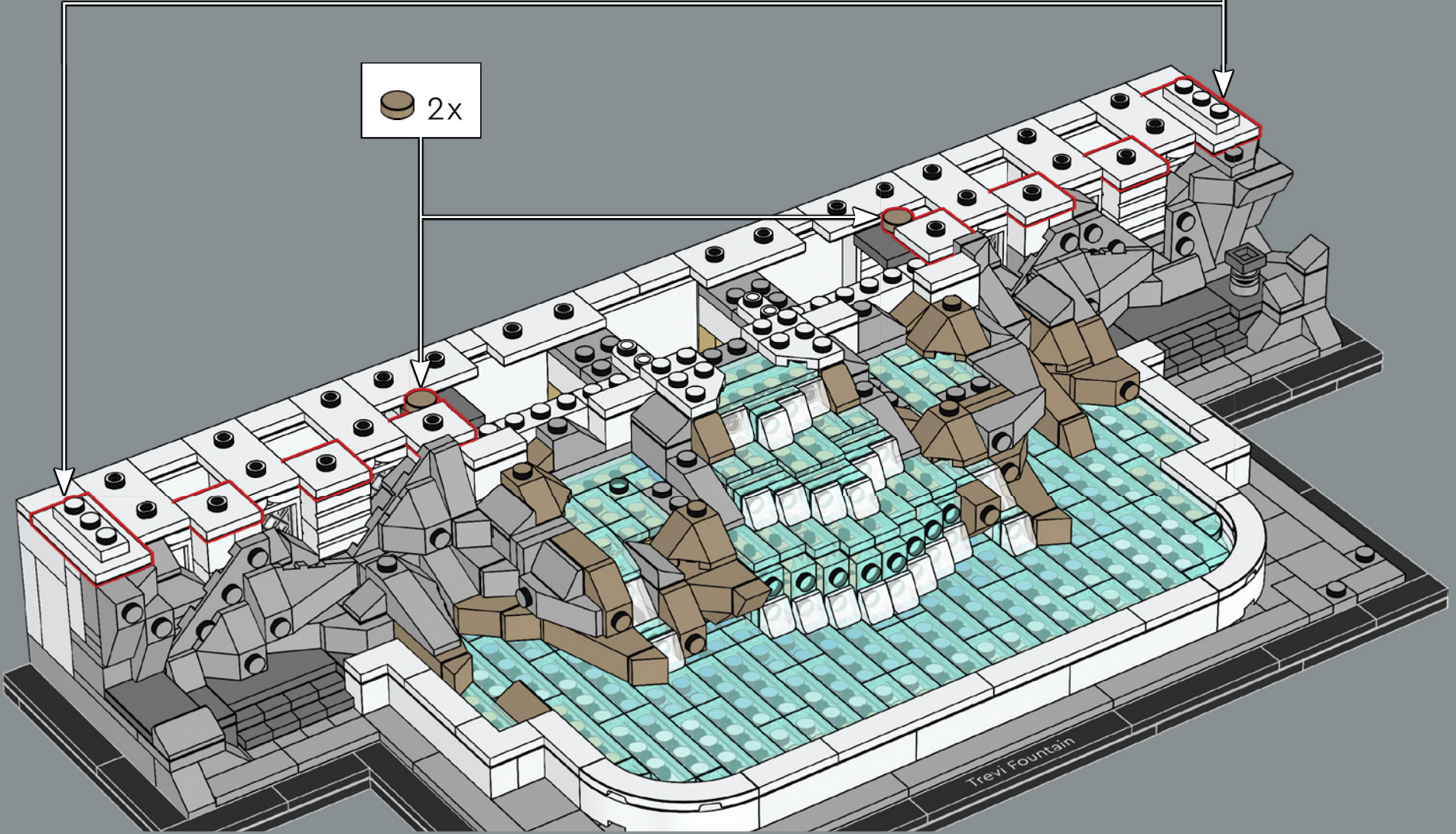
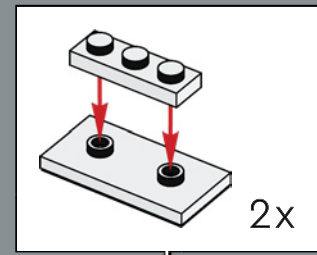



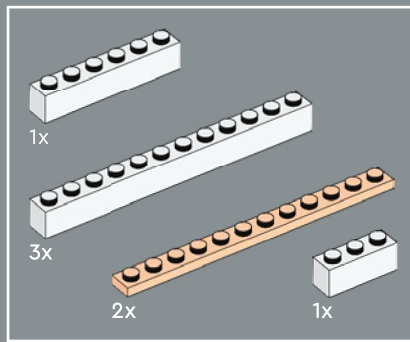

Per catturare correttamente i dettagli e la spaziatura nelle sporgenze e nelle porzioni sfalsate della facciata, abbiamo alternato griglie LEGO® standard con 1/2 basi fuori griglia. Questo ci ha aiutato a creare un flusso di costruzione regolare e un modello molto resistente.

149

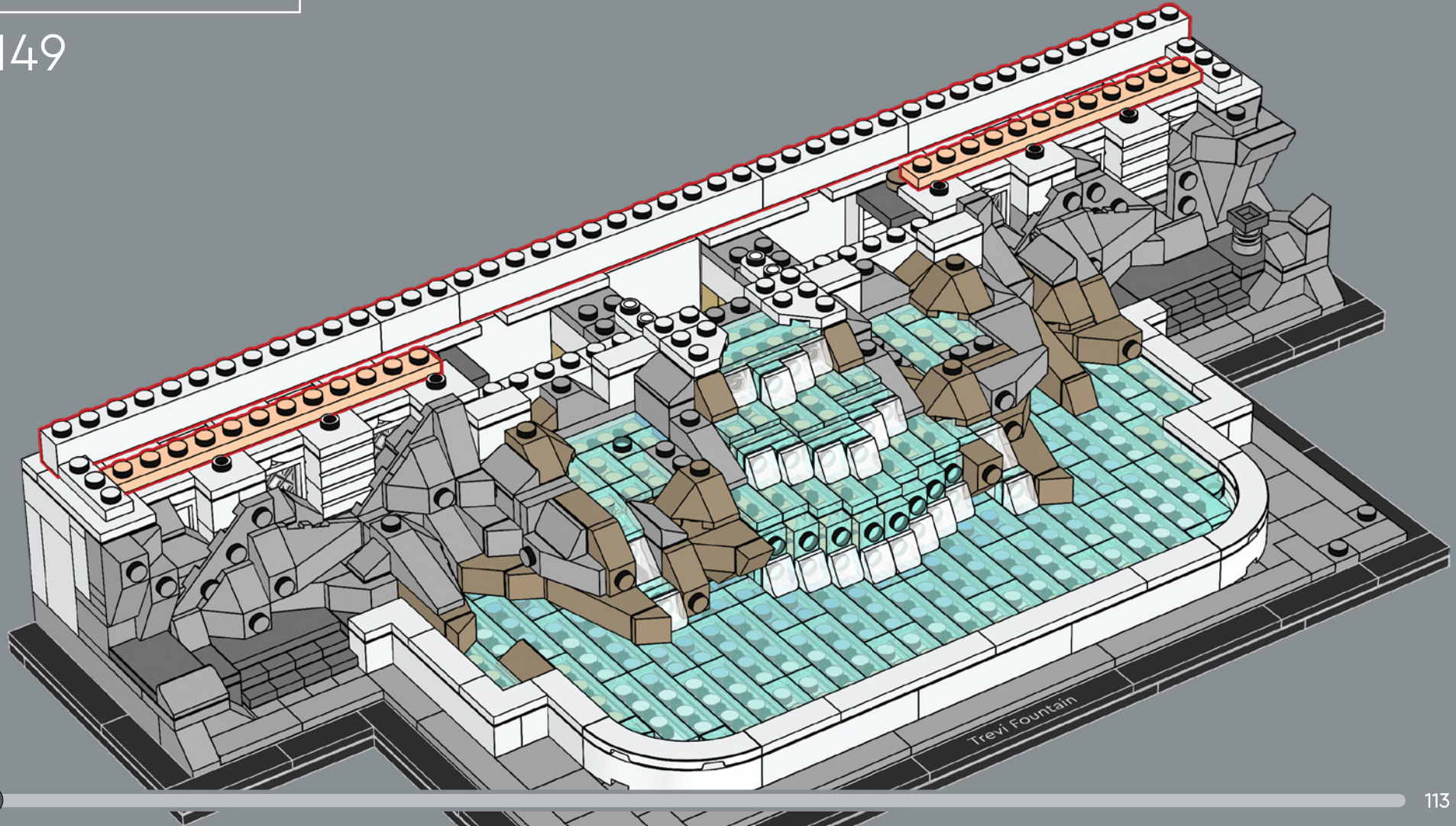



6x

150



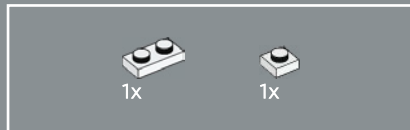
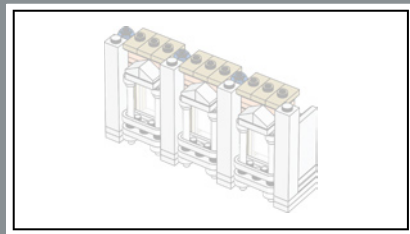

151

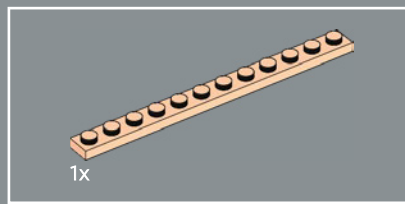
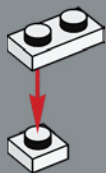

152

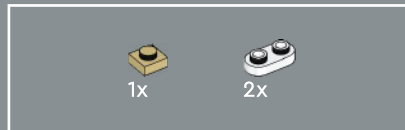
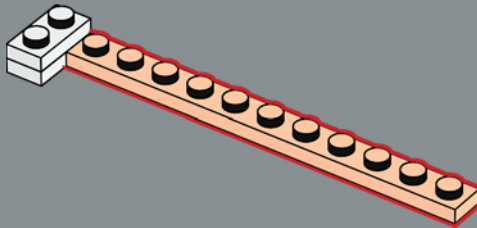

153

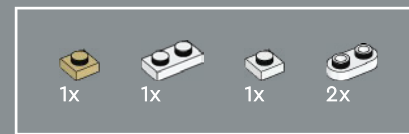
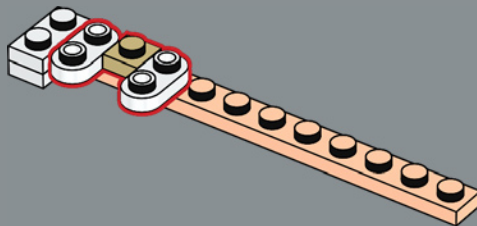

154

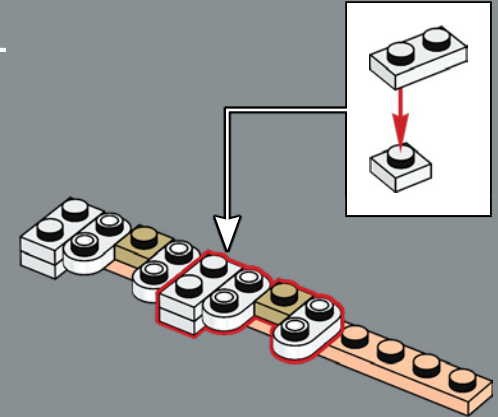

155

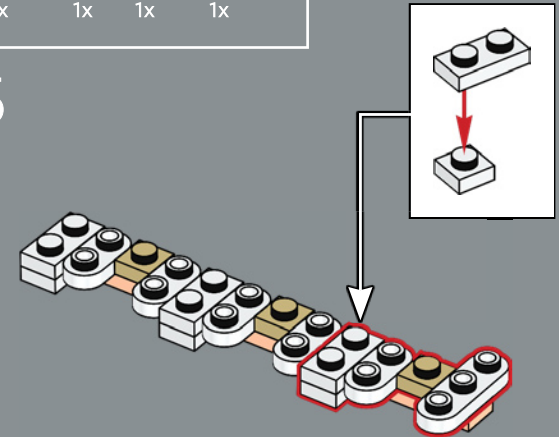

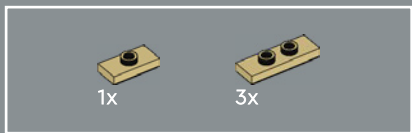

156

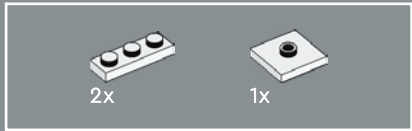
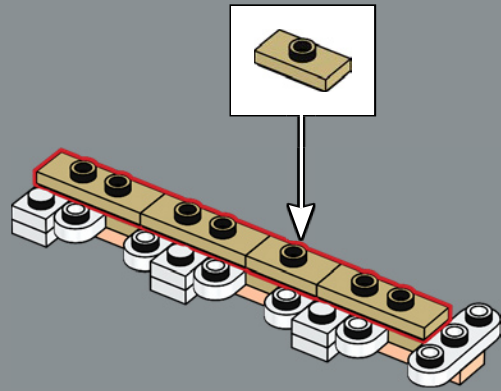

157

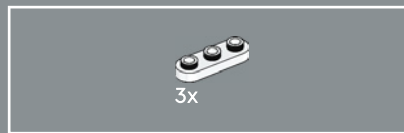
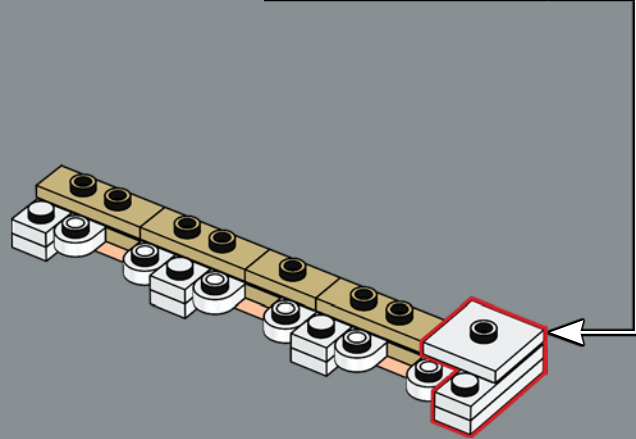
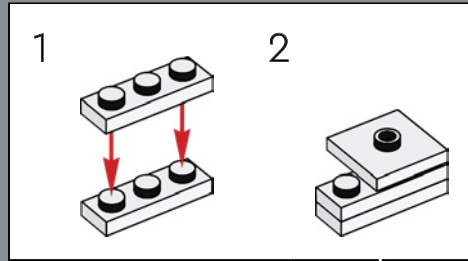

158

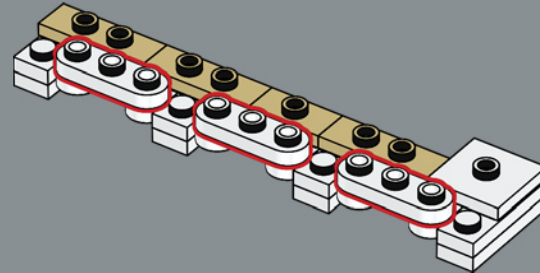

159

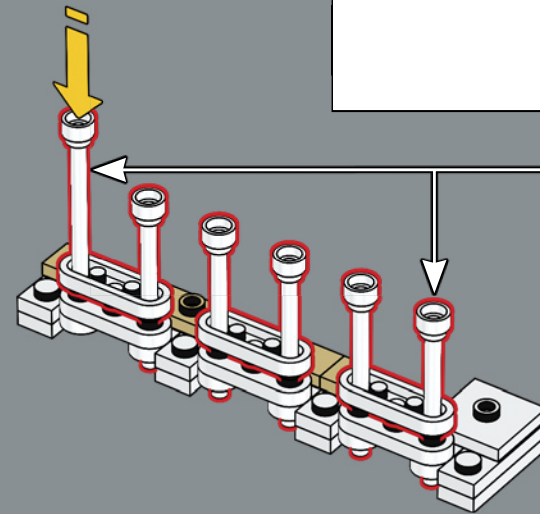
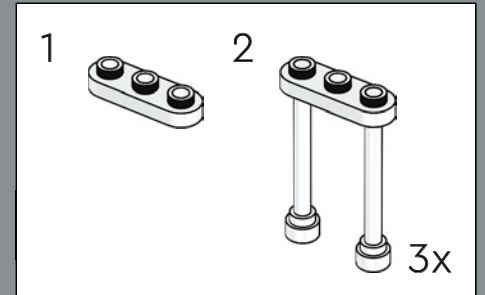

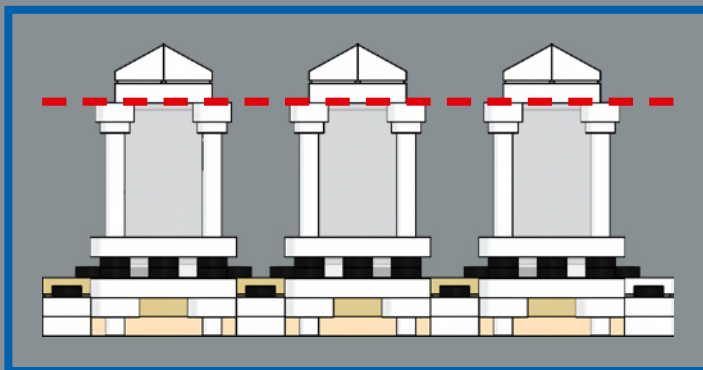
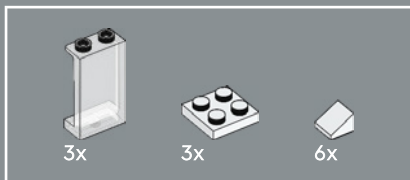

160

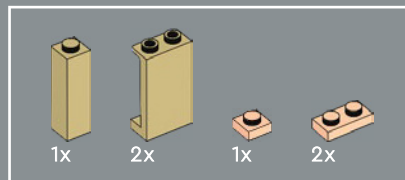
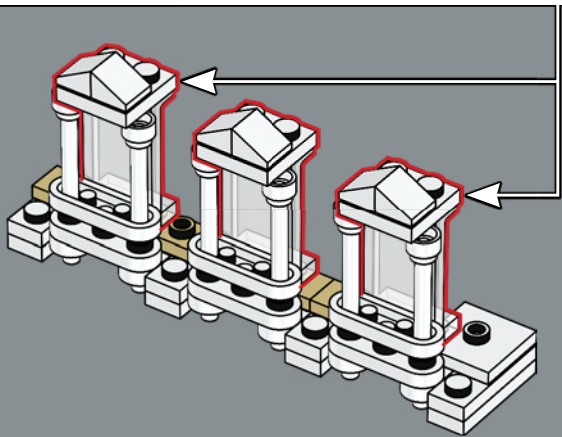
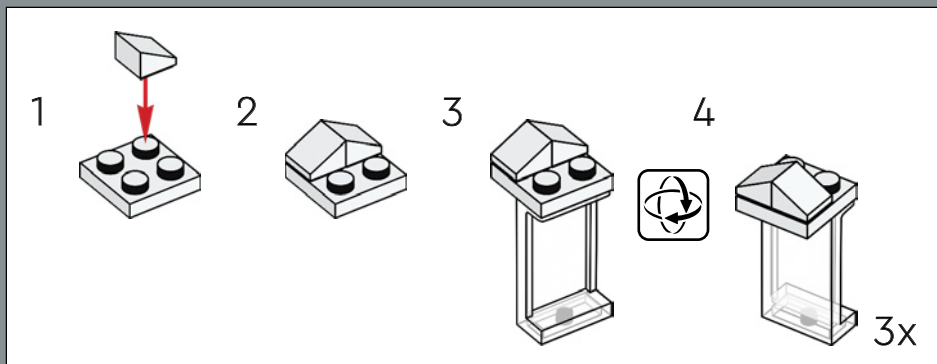

161

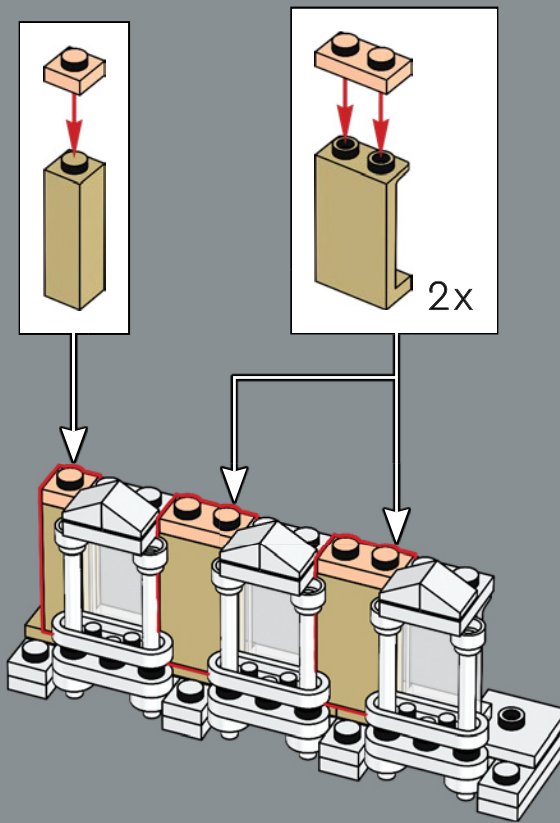

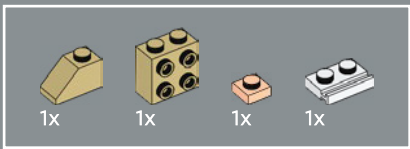

162

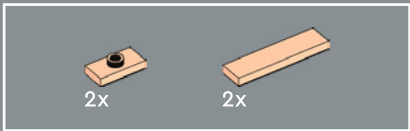
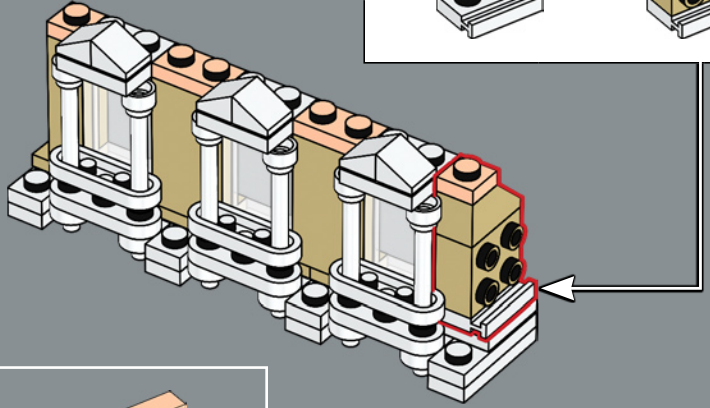
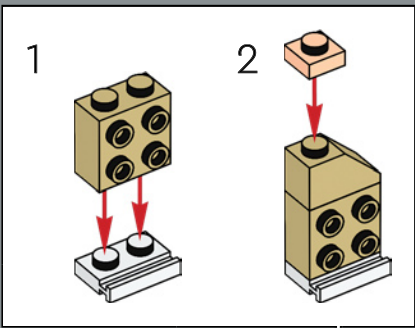

163

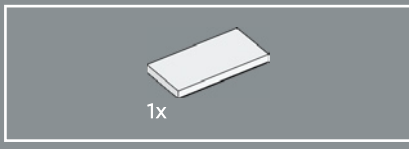
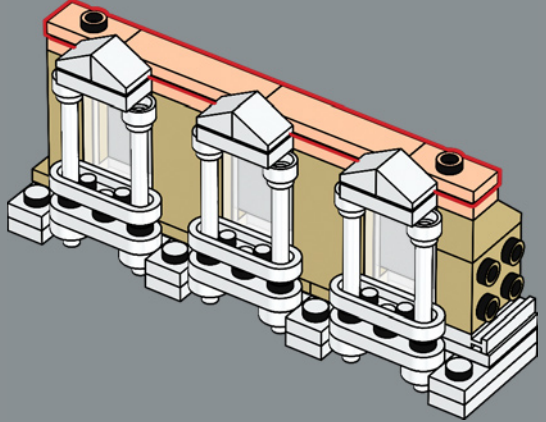

164

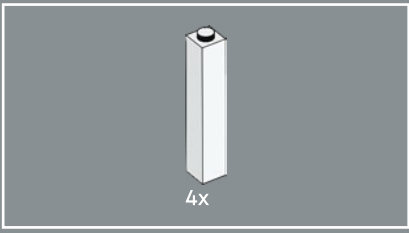
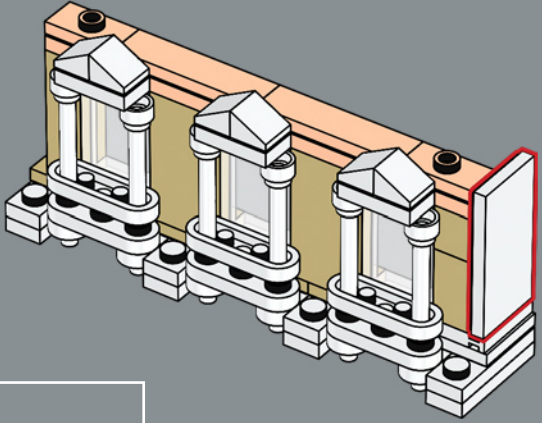

165

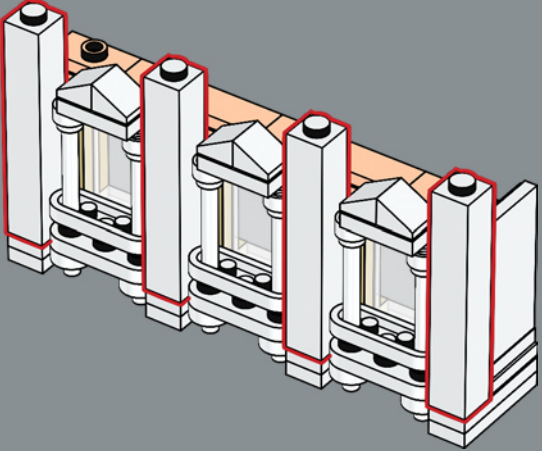

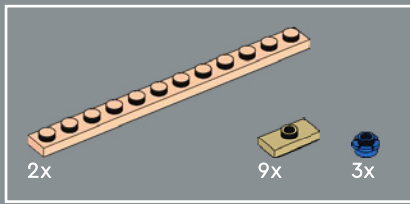

166

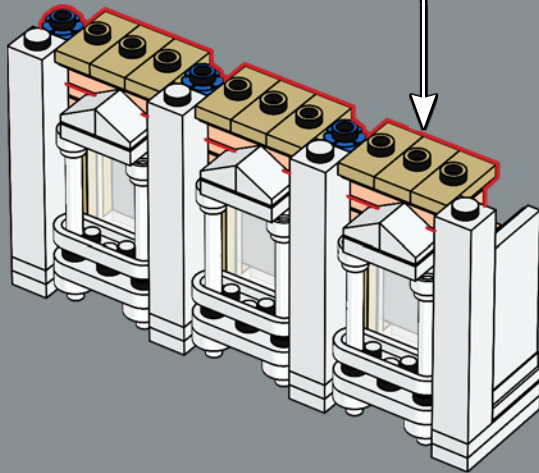
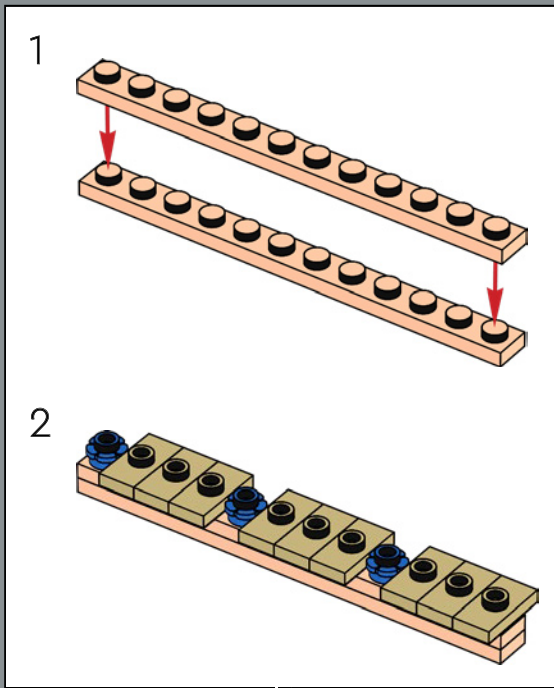

167

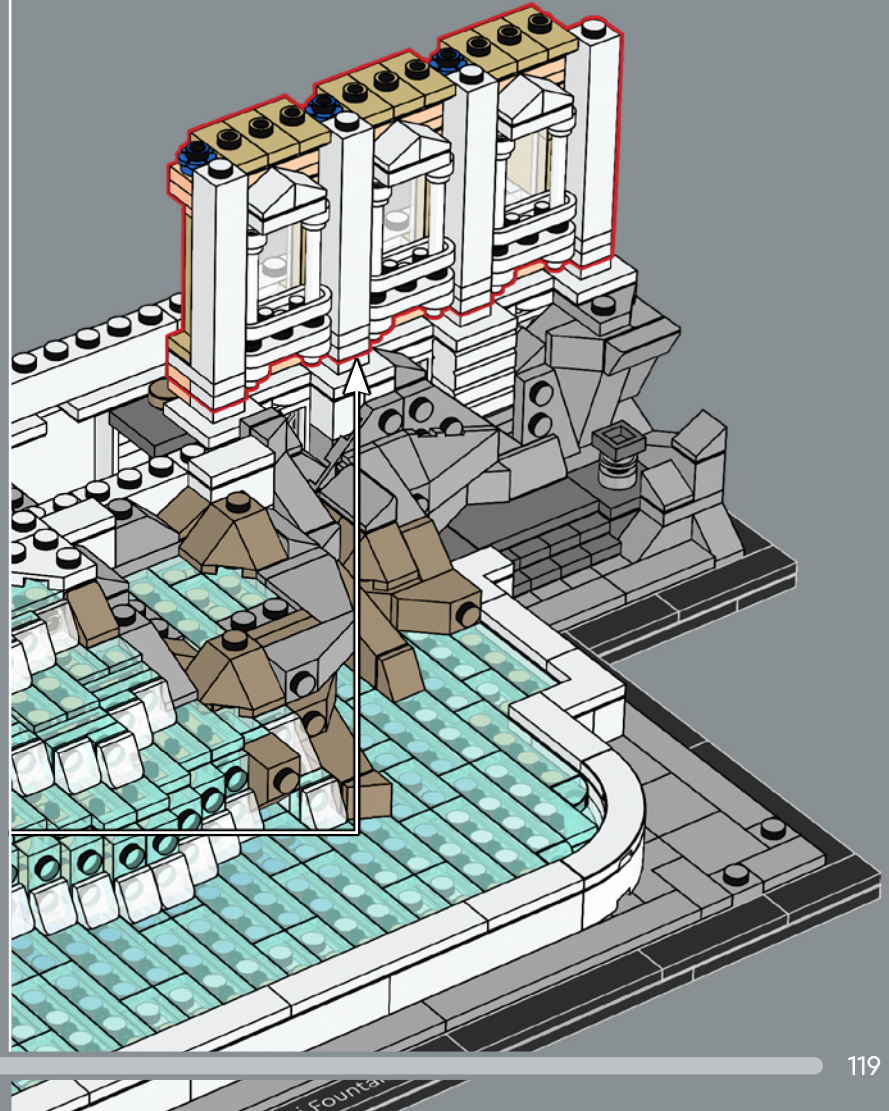

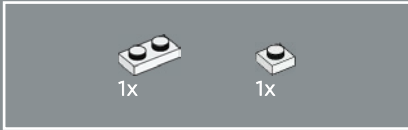
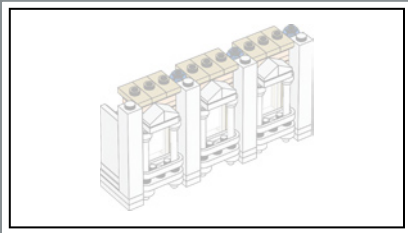

168

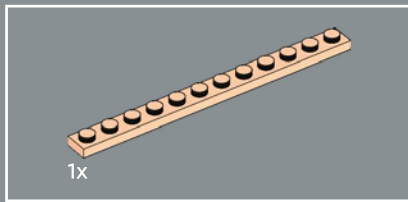
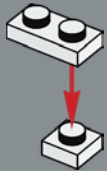

169

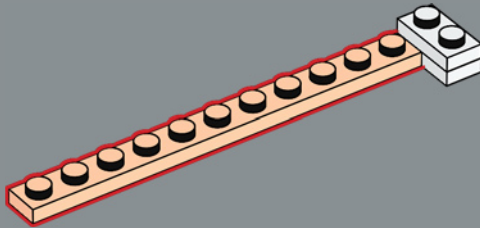

170

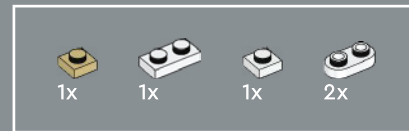
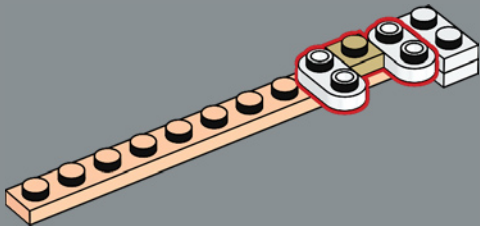

171

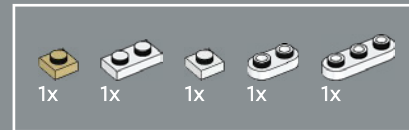
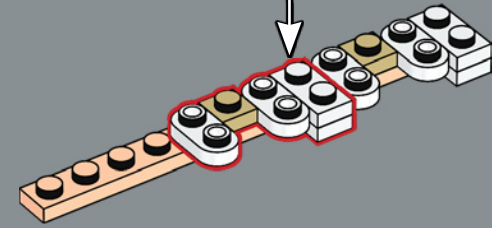
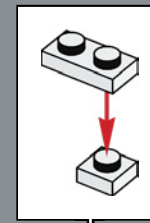

172

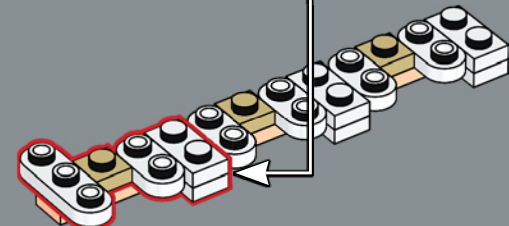
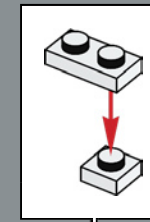



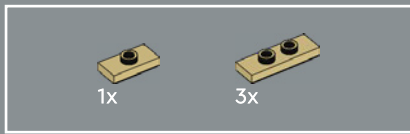

173

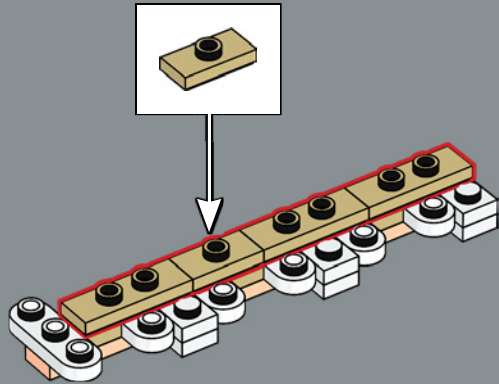

174

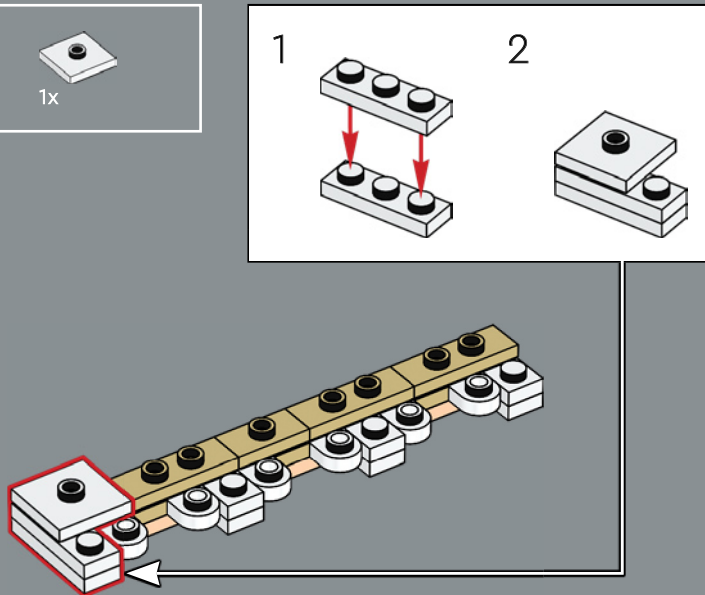

175

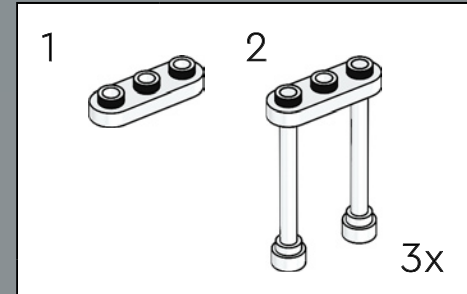
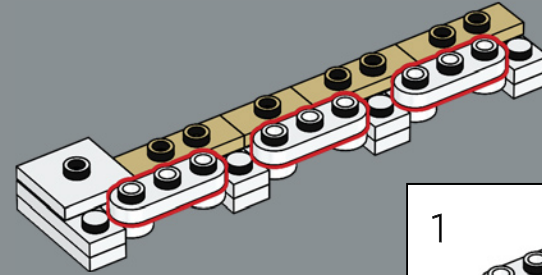

176

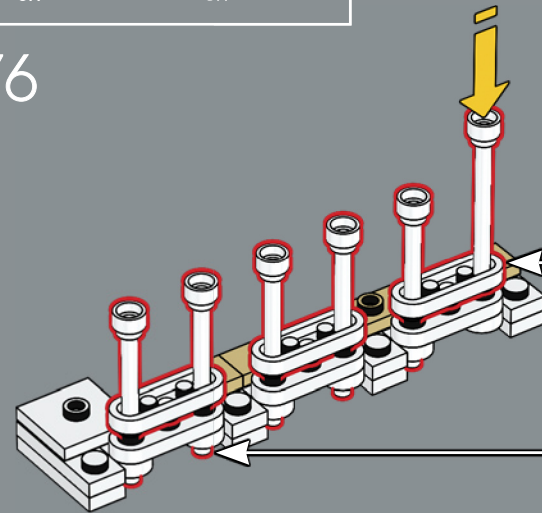

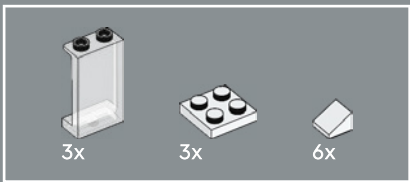

177

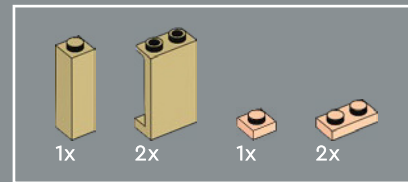
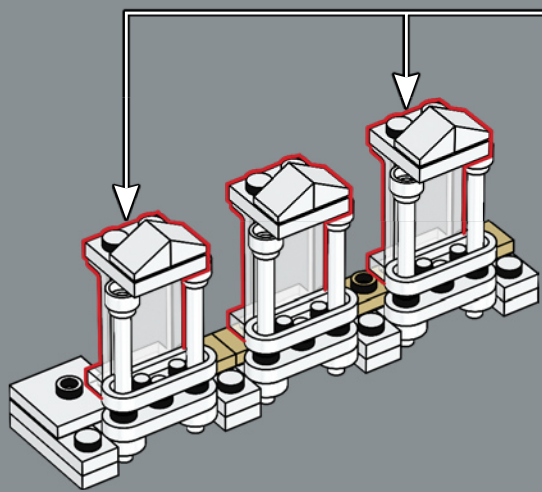
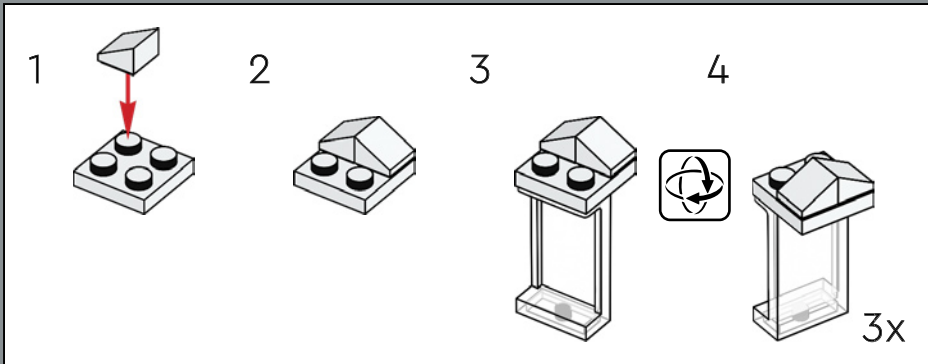
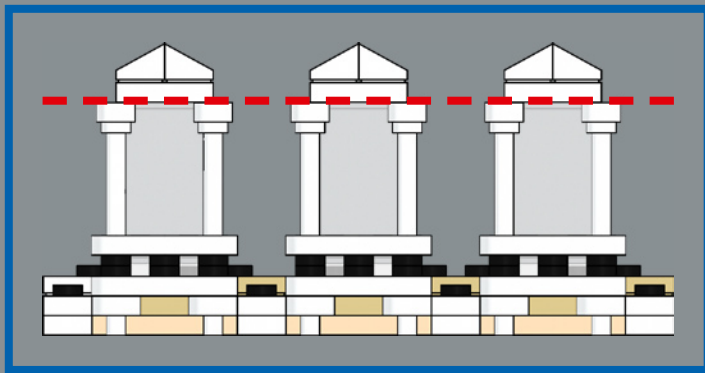

178

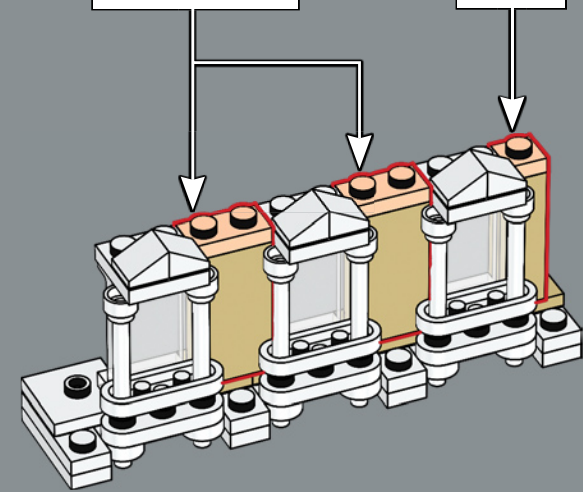
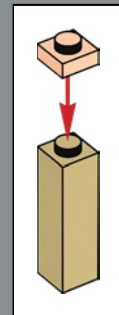
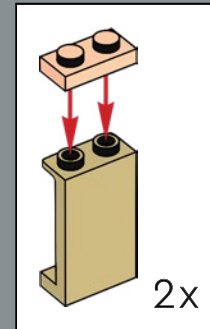

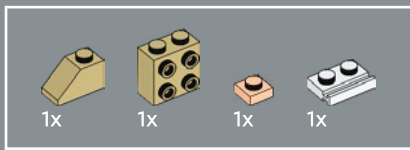

179

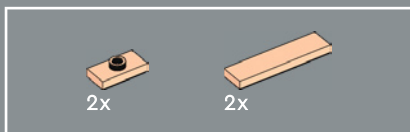
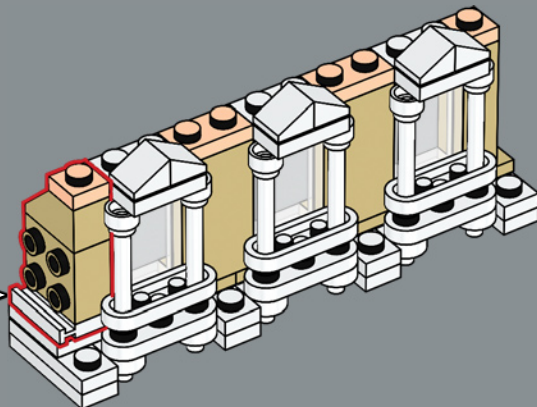
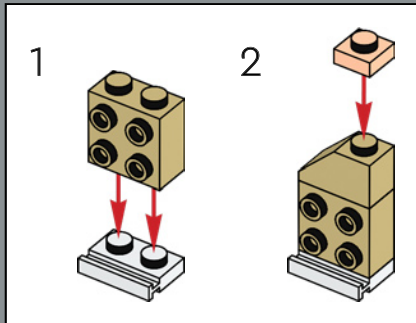

180

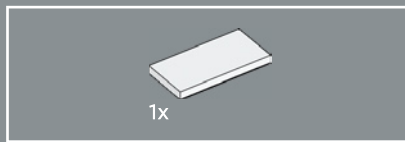
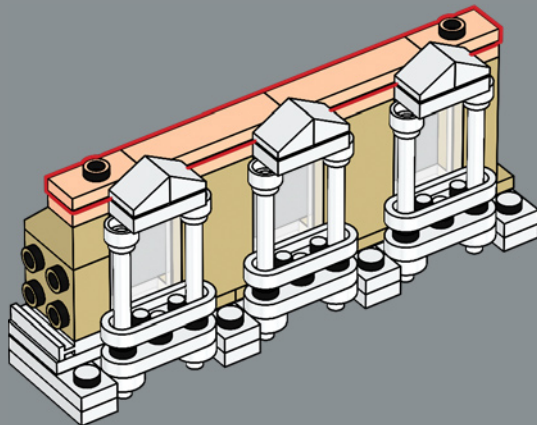

181

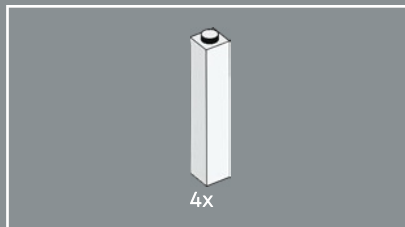
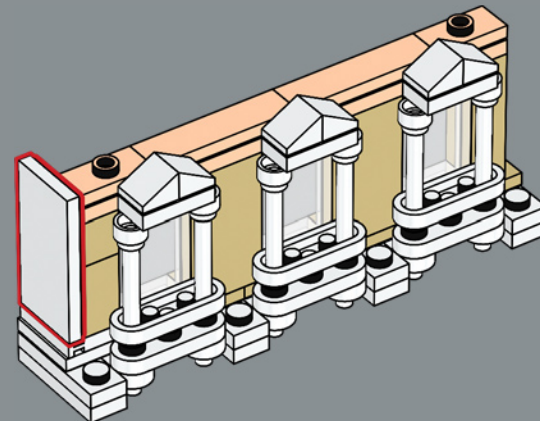

182

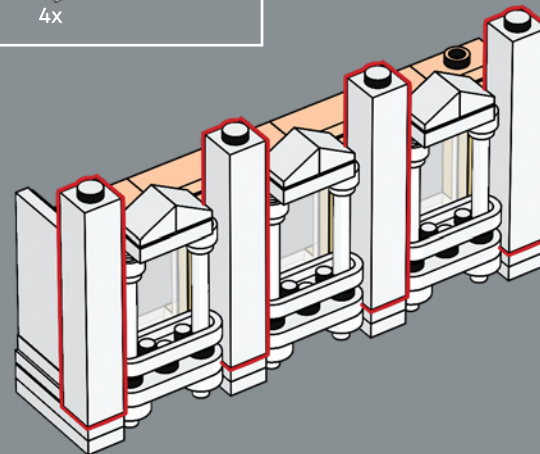

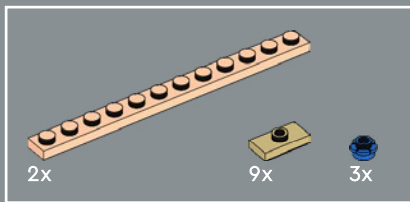

183

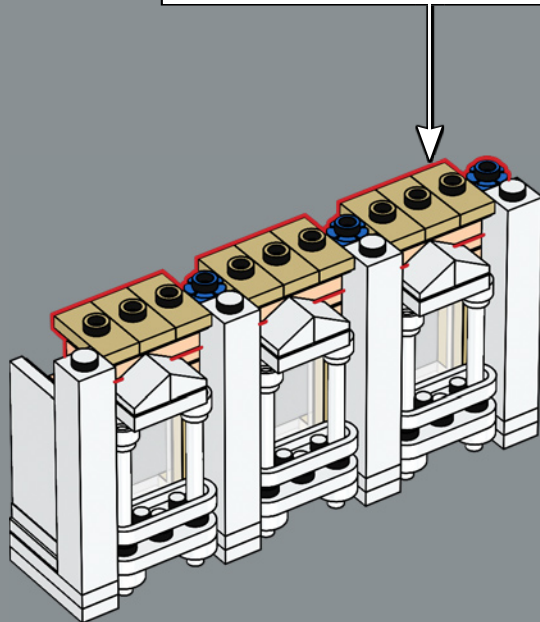
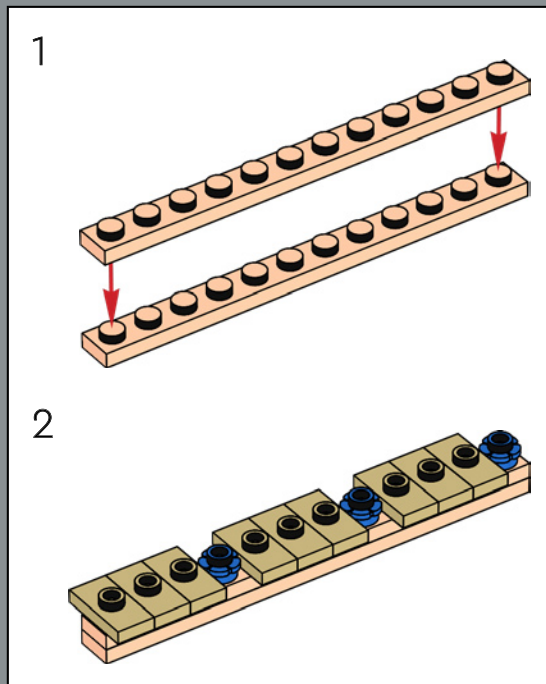

184

Il colore sabbia è riservato alle zone più in ombra della fontana, sotto gli oggetti e dietro le cornici delle finestre.

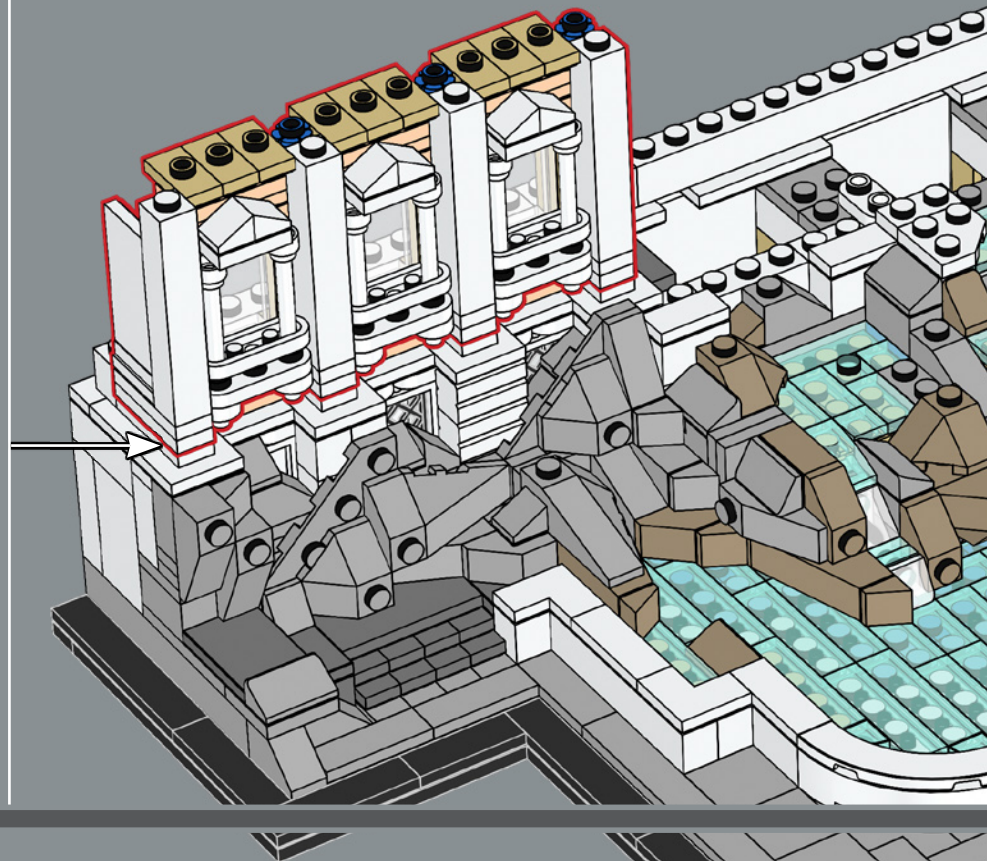

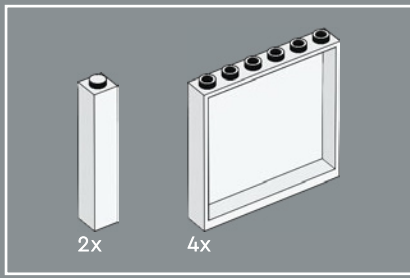

185

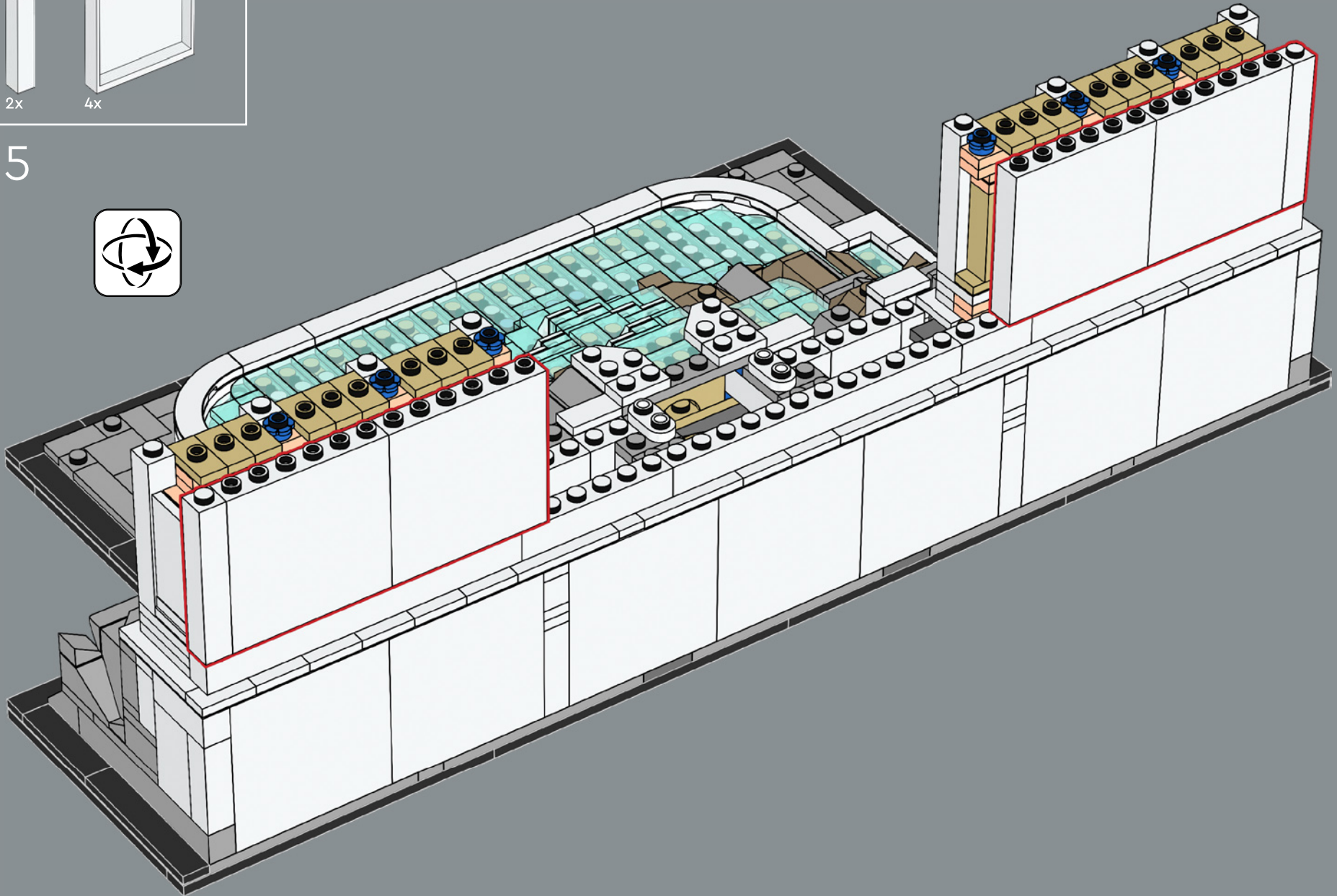

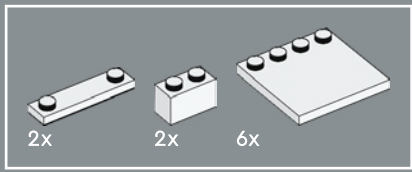

186

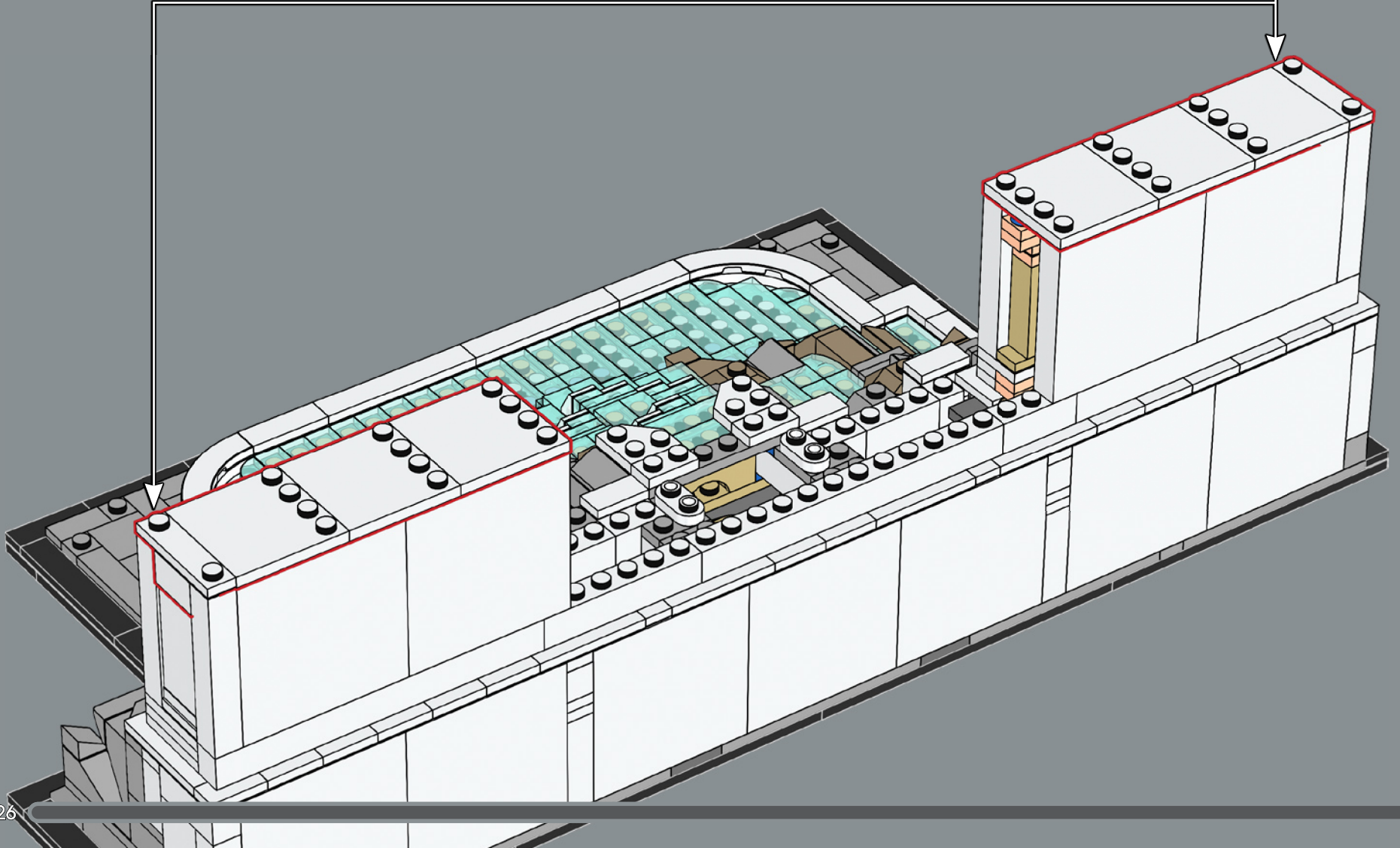
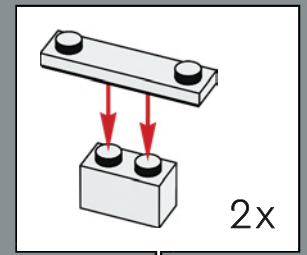

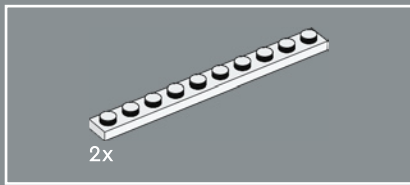

187

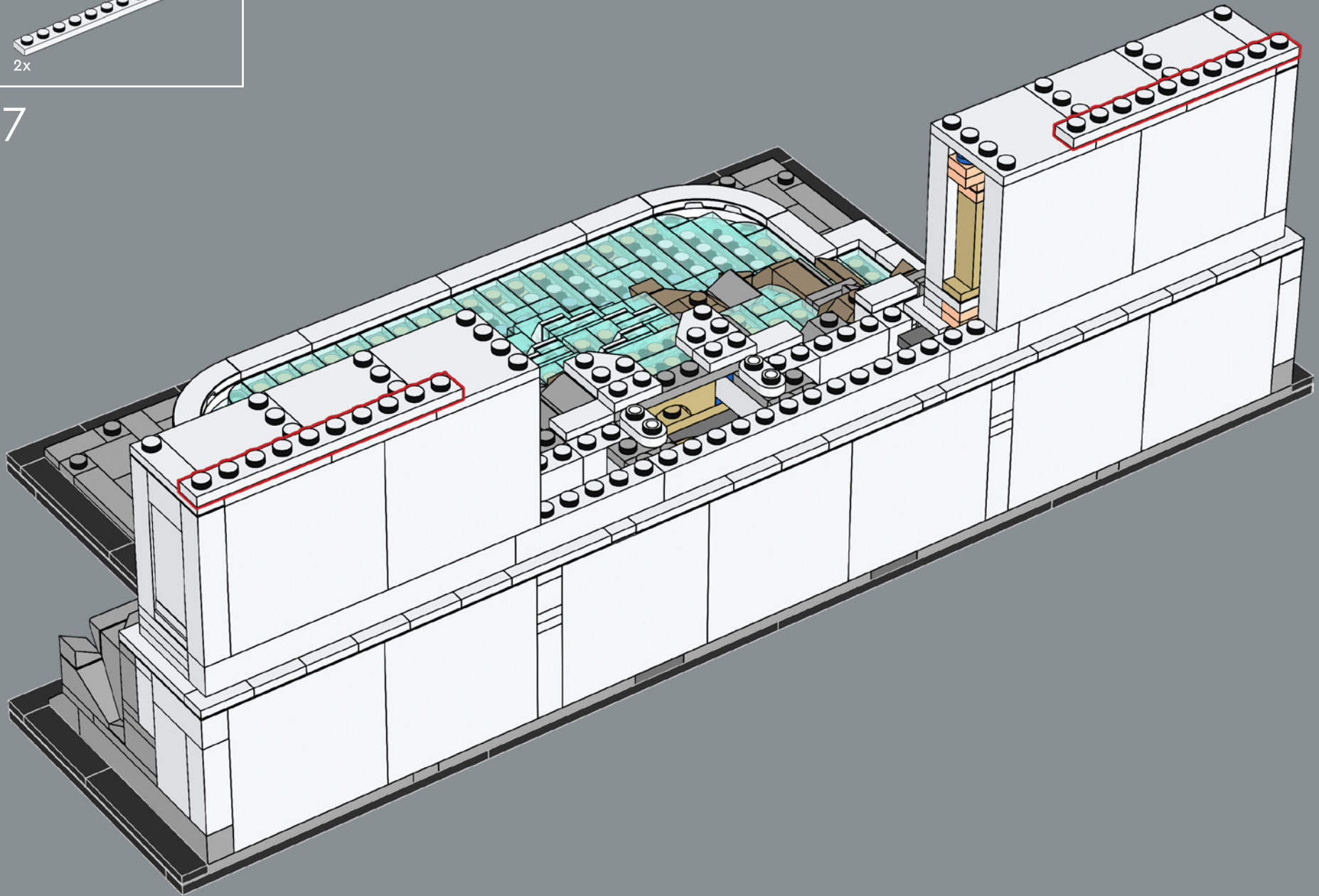

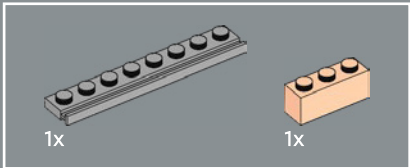
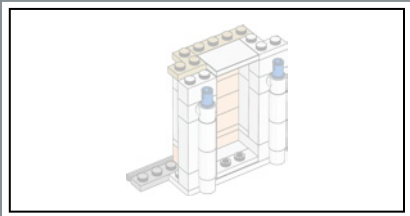

188

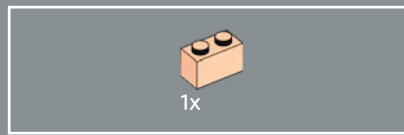
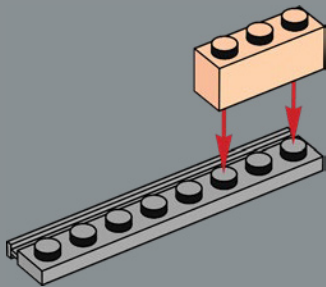

189

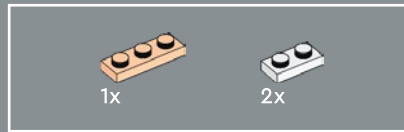
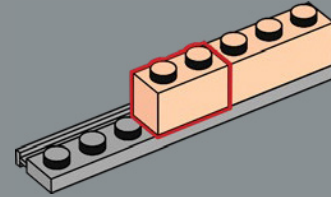

190

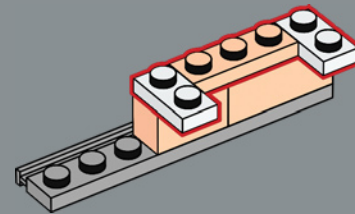



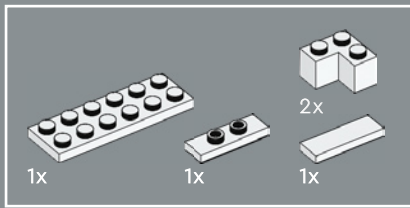

191

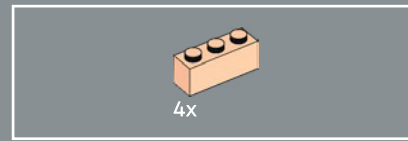
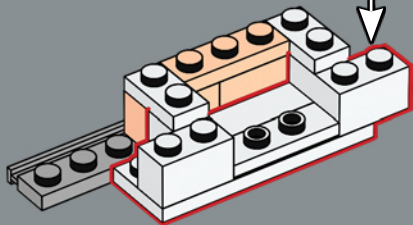
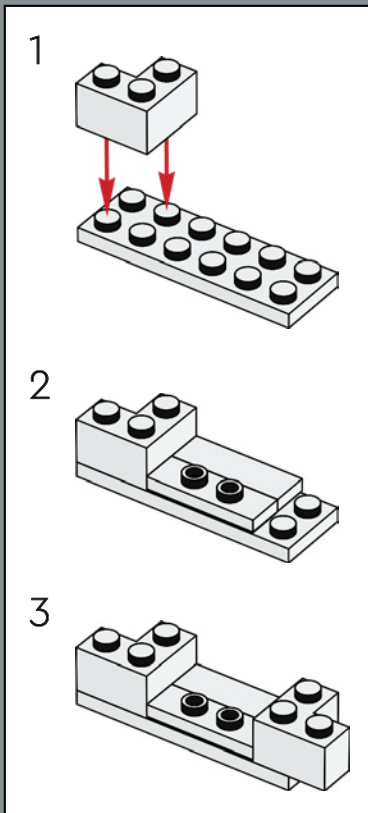

192

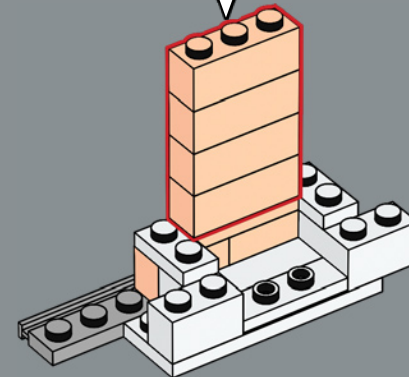
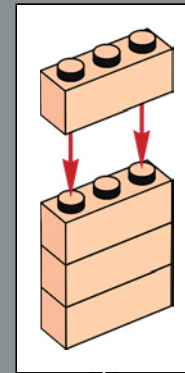

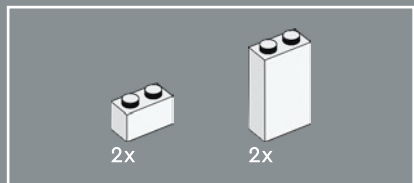

193

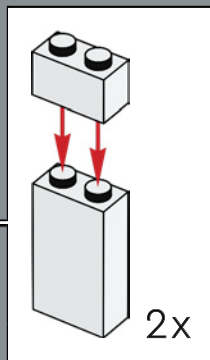
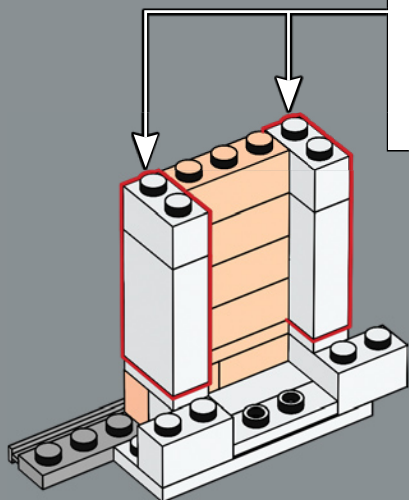

2x

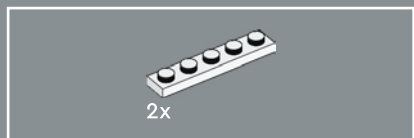

194

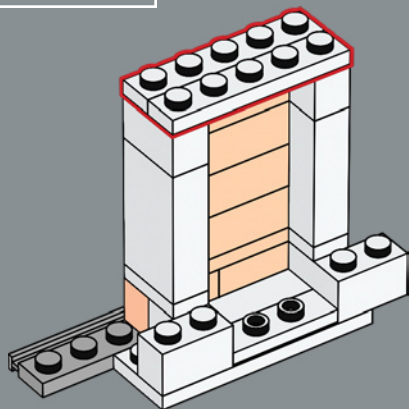

195

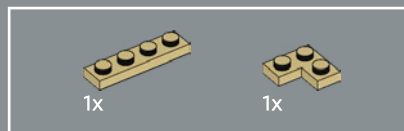
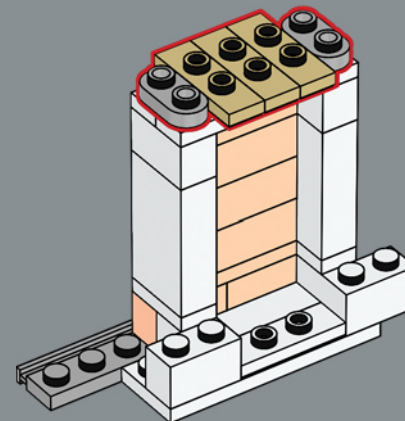

196

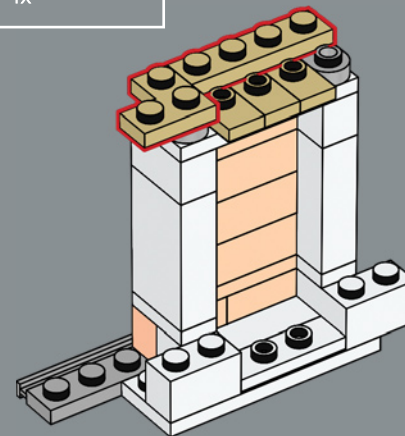

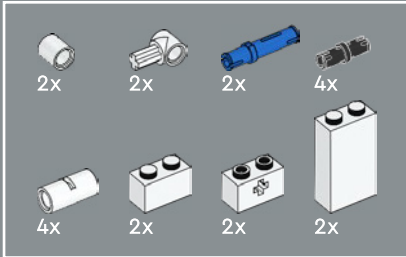
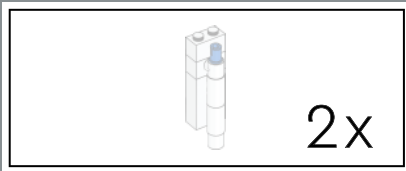

197

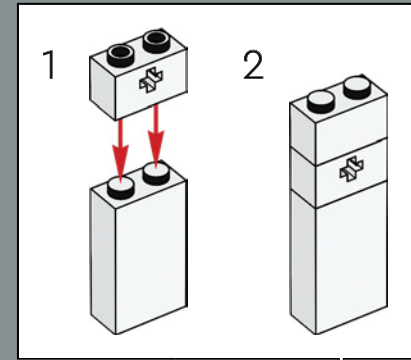
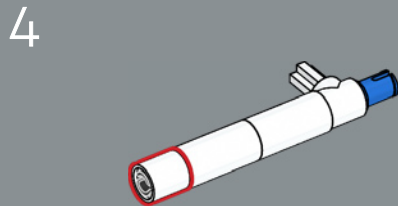
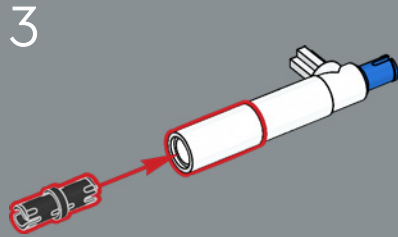
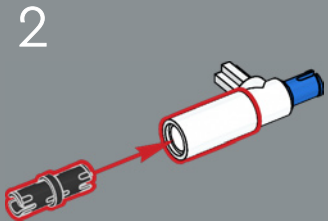
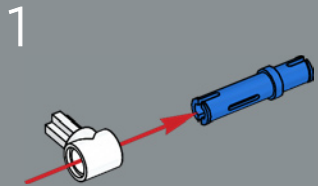

5



2x

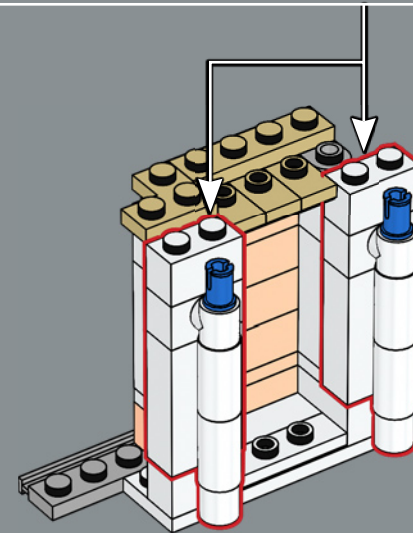

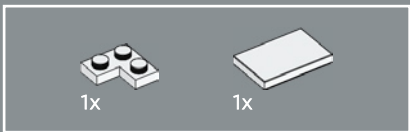

198

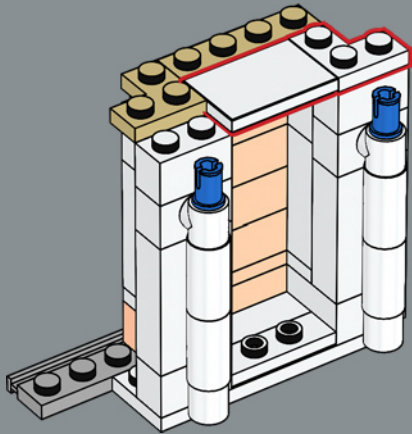

199

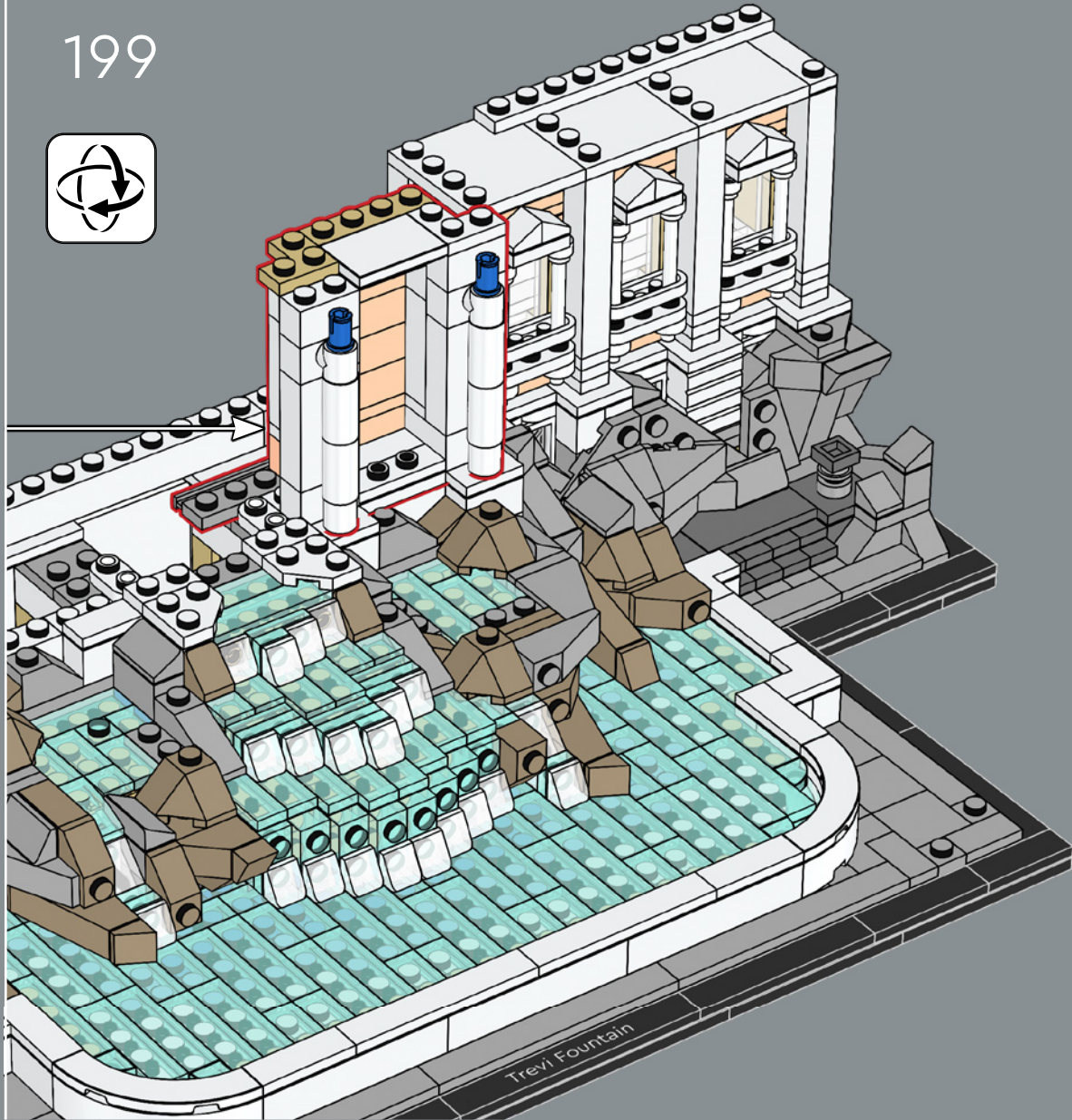

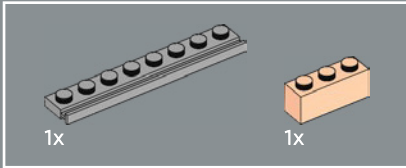
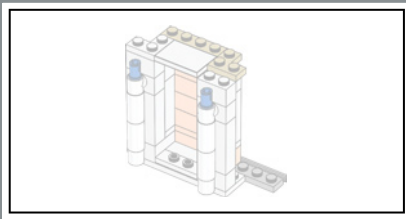

200

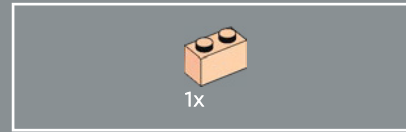
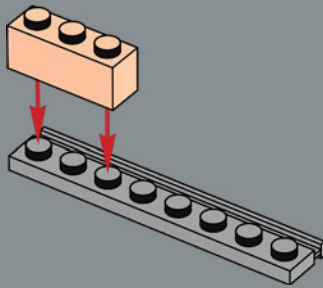

201

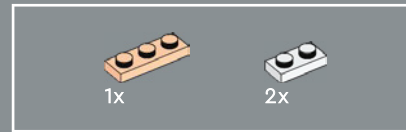
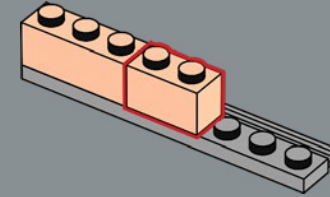

202

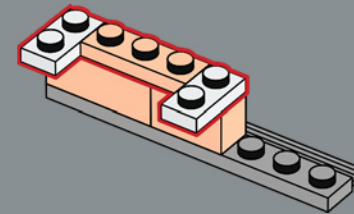

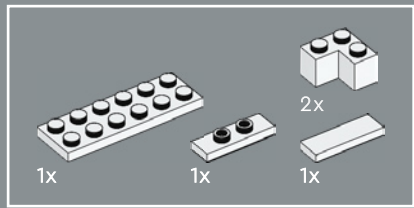

203

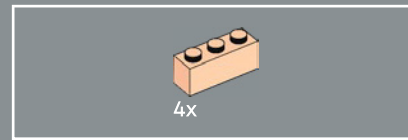
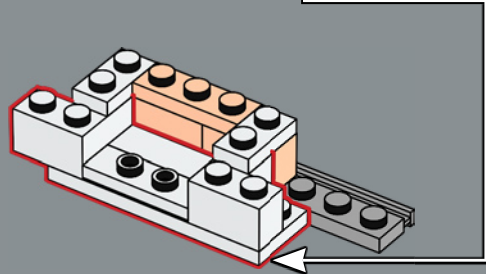
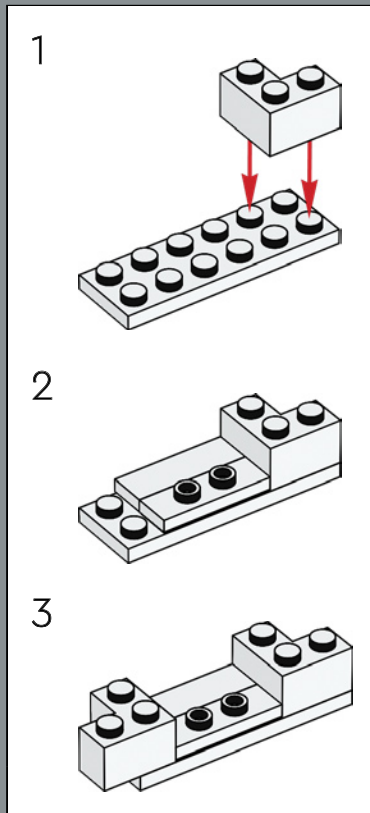

204

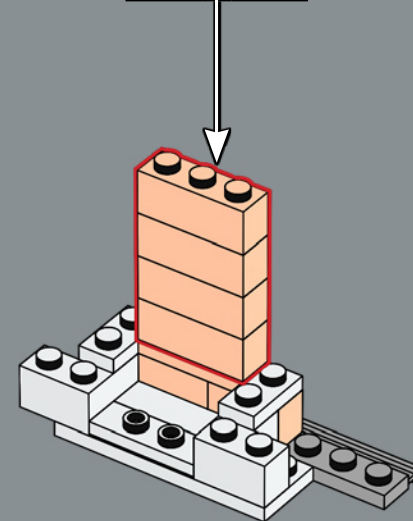
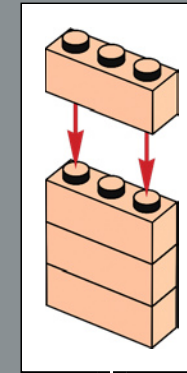

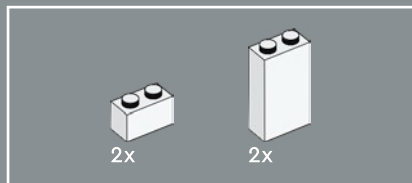

205

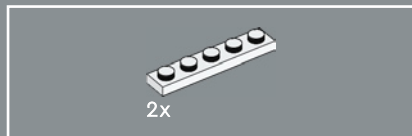
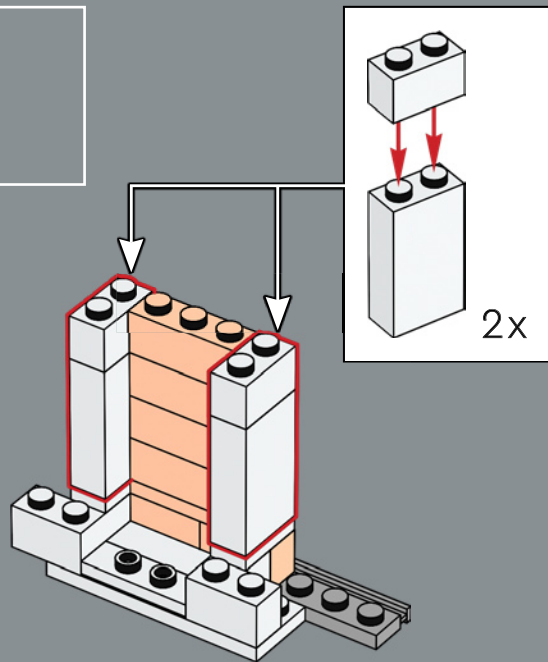

206

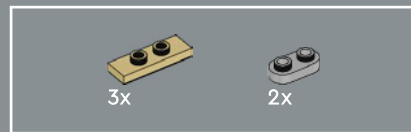
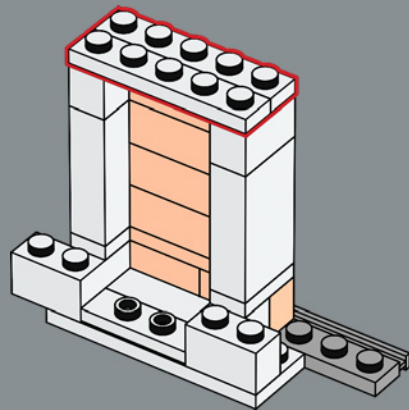

207

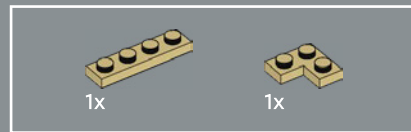
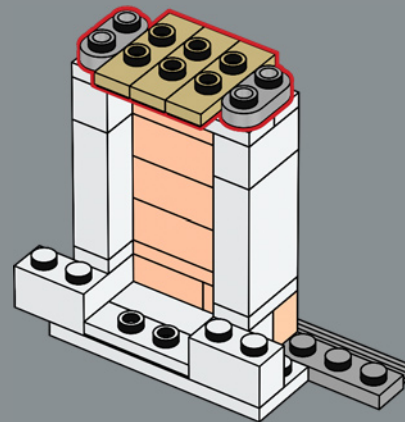

208

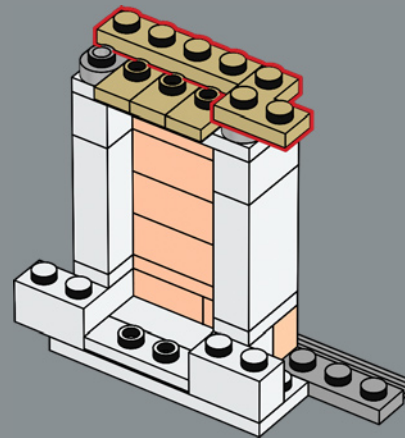

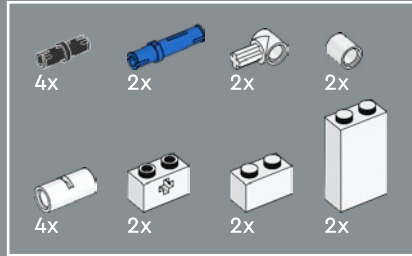
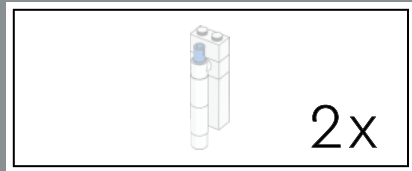

209

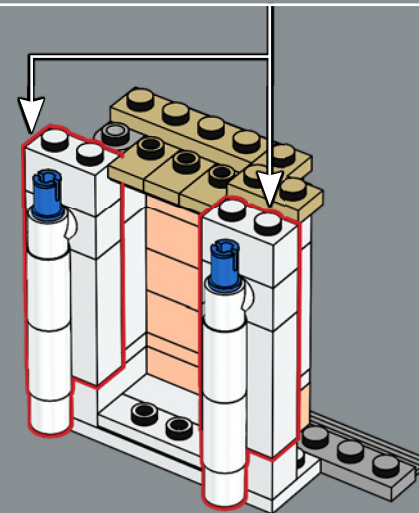
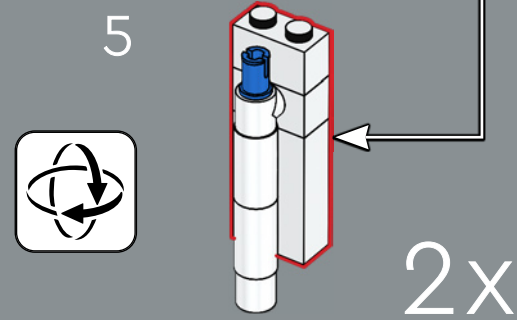
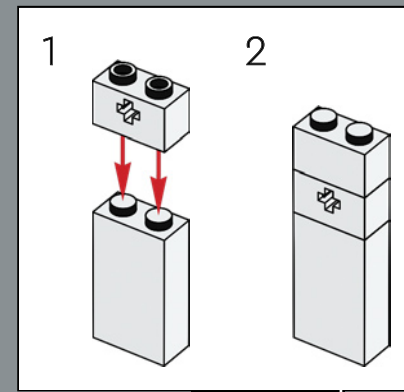
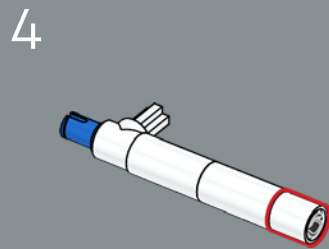
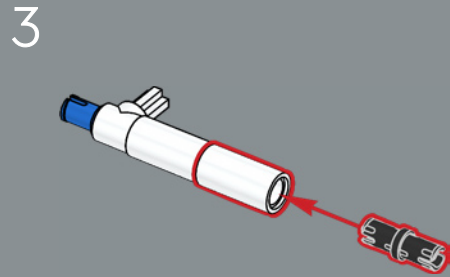
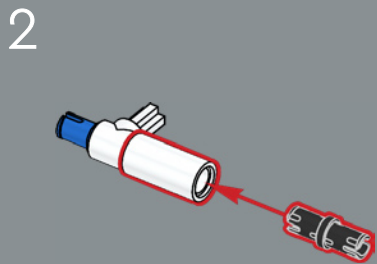
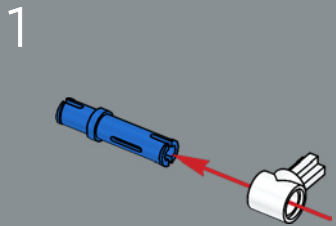



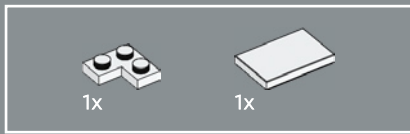

210

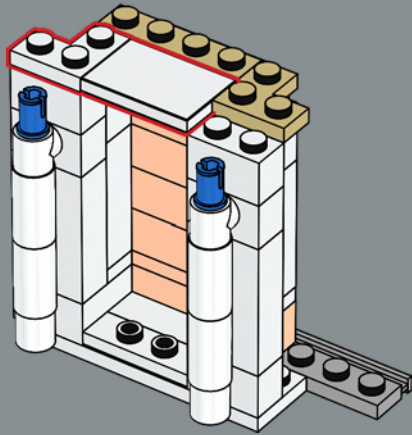

211

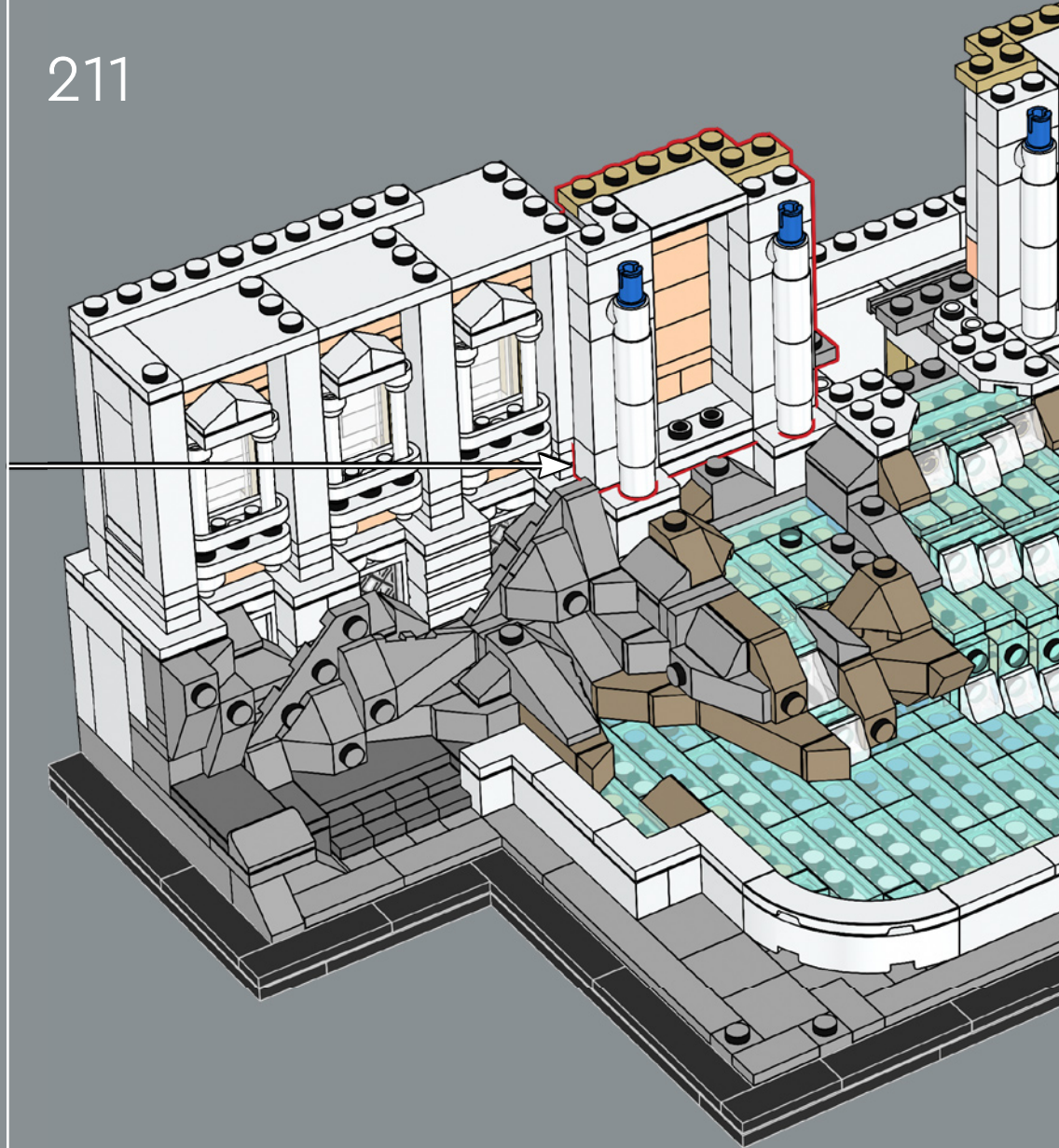

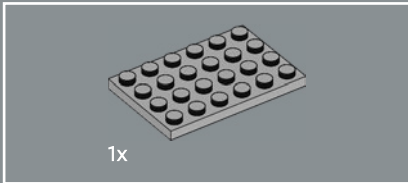
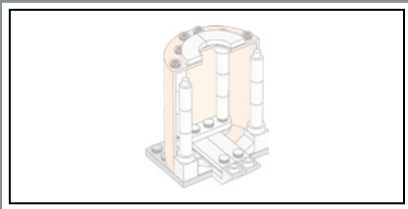

212

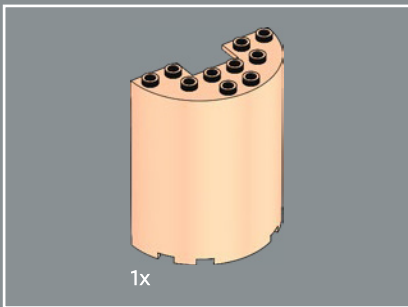
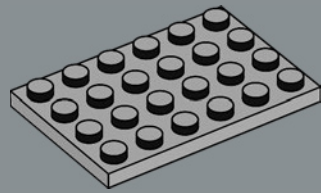

213

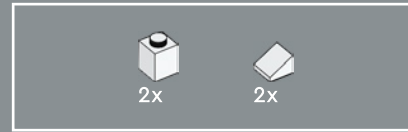
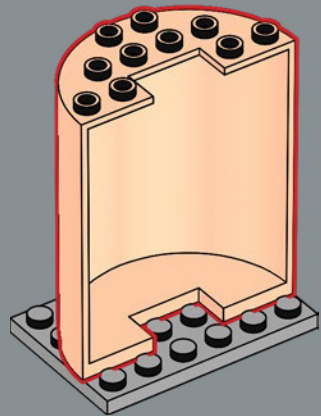

214

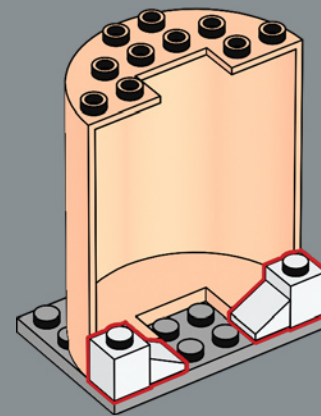

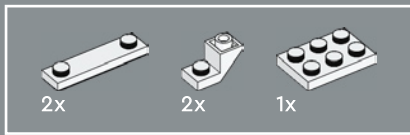

215

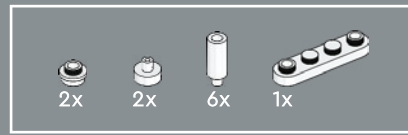
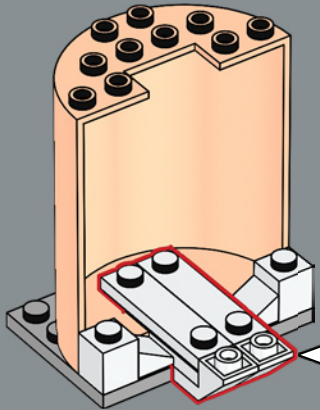
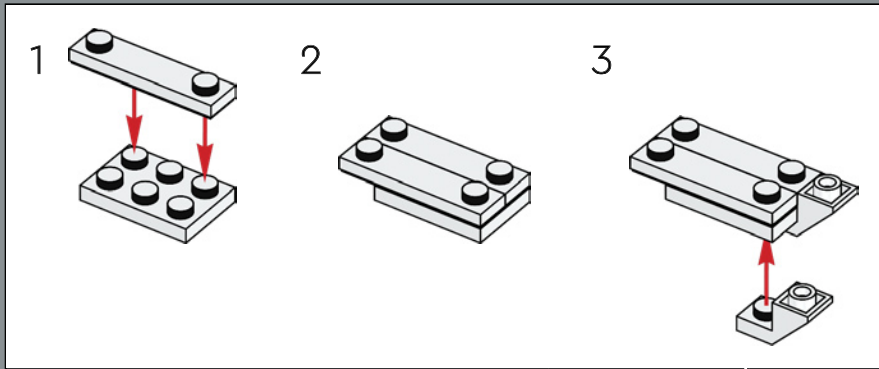

216

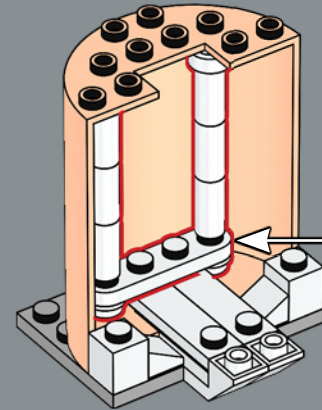
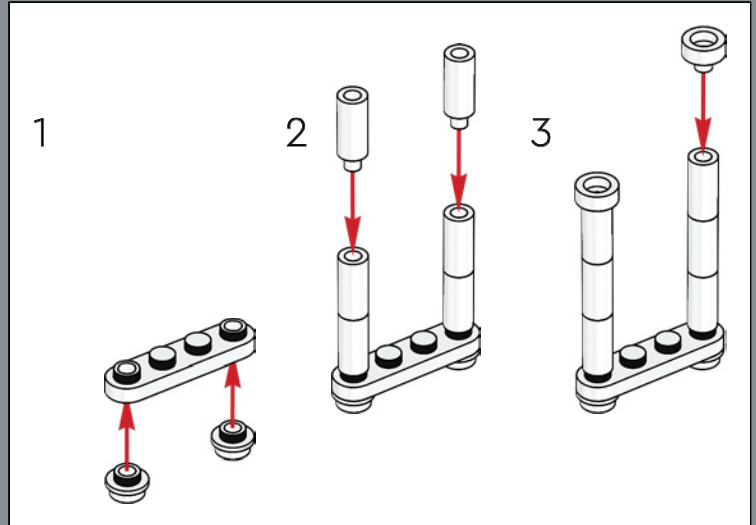



217

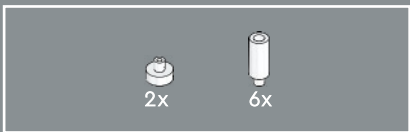
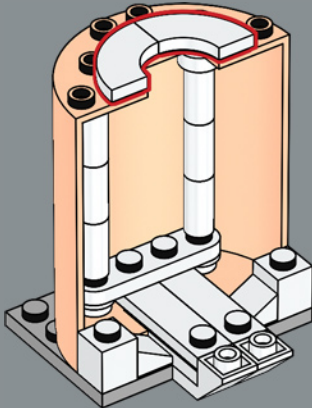

218

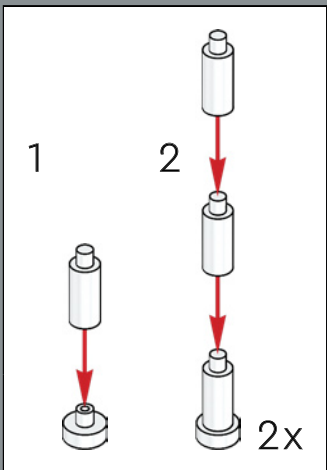
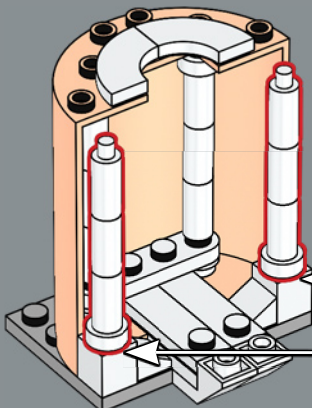

L'intera facciata è divisa in nove sezioni verticali e questa soluzione ha consentito di creare un punto focale centrale. Replicare questa soluzione con i mattoncini LEGO® ha richiesto un numero dispari di moduli e basi di collegamento per centrare l'arco principale.

219

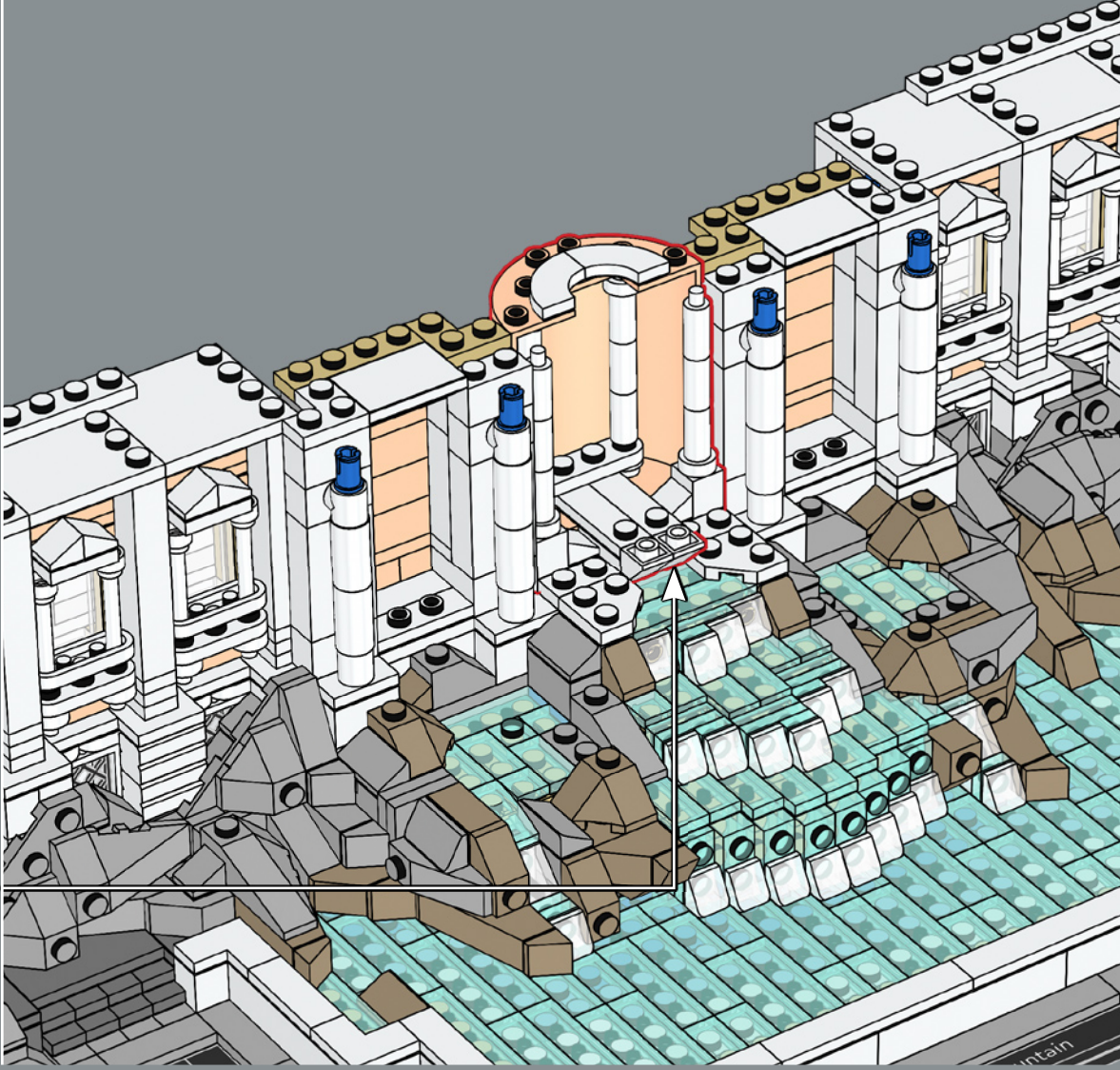

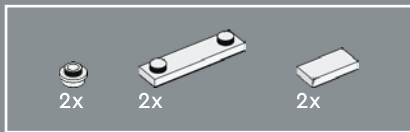

220

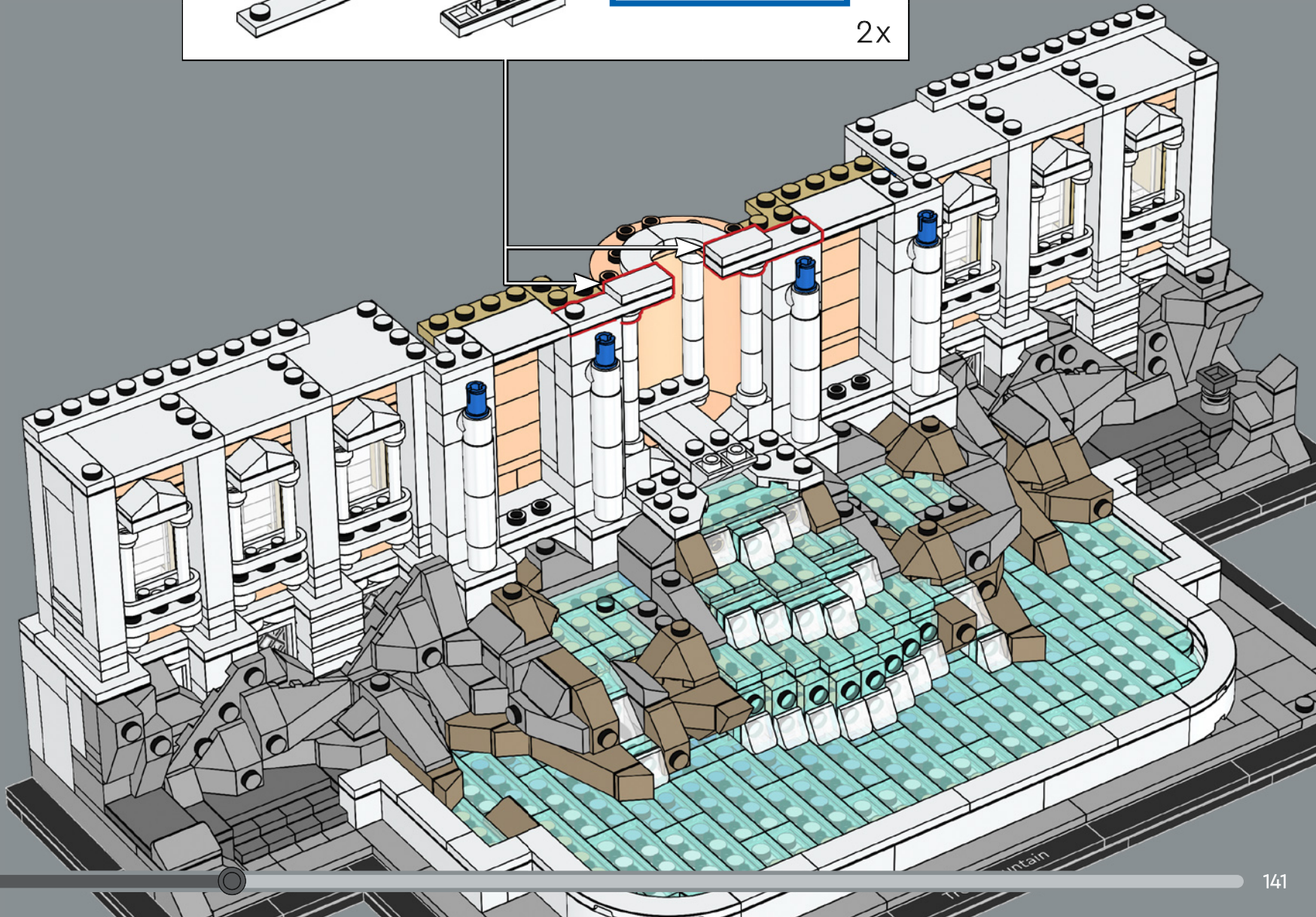
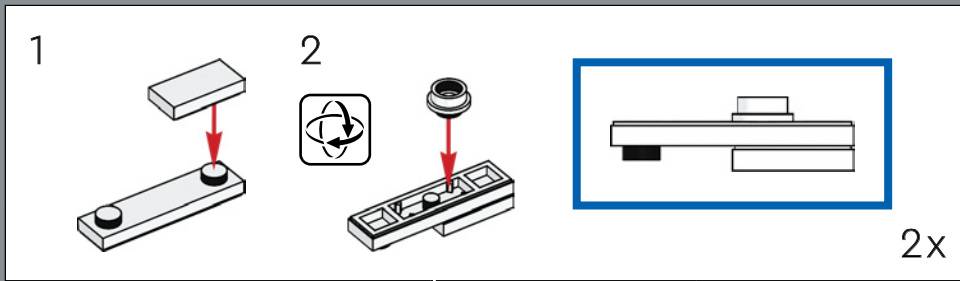

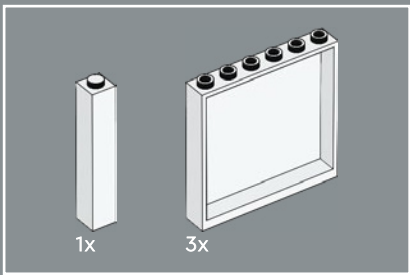

221

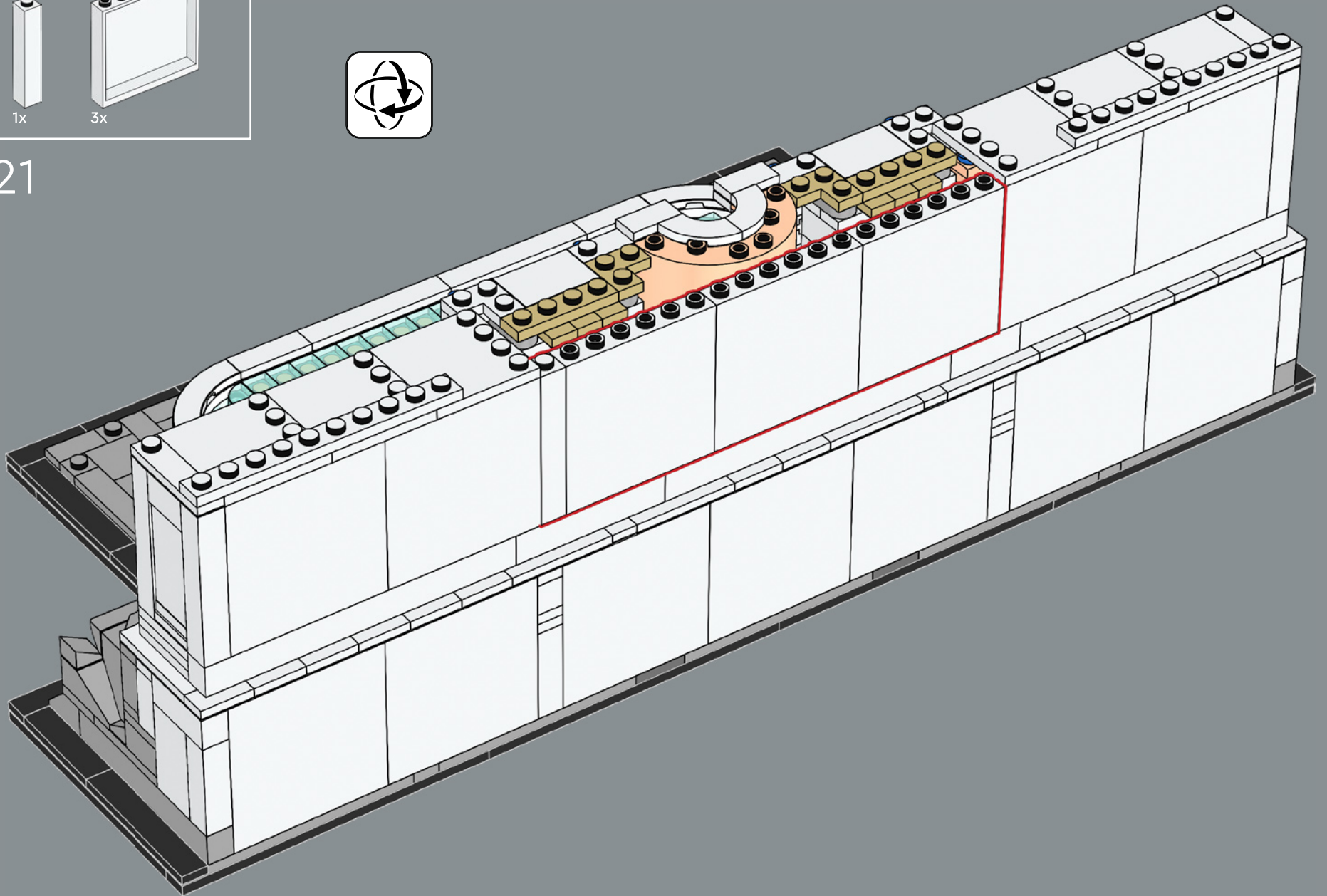

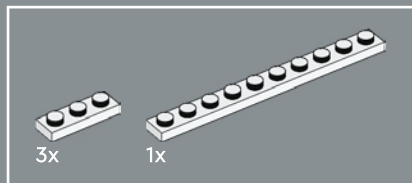

222

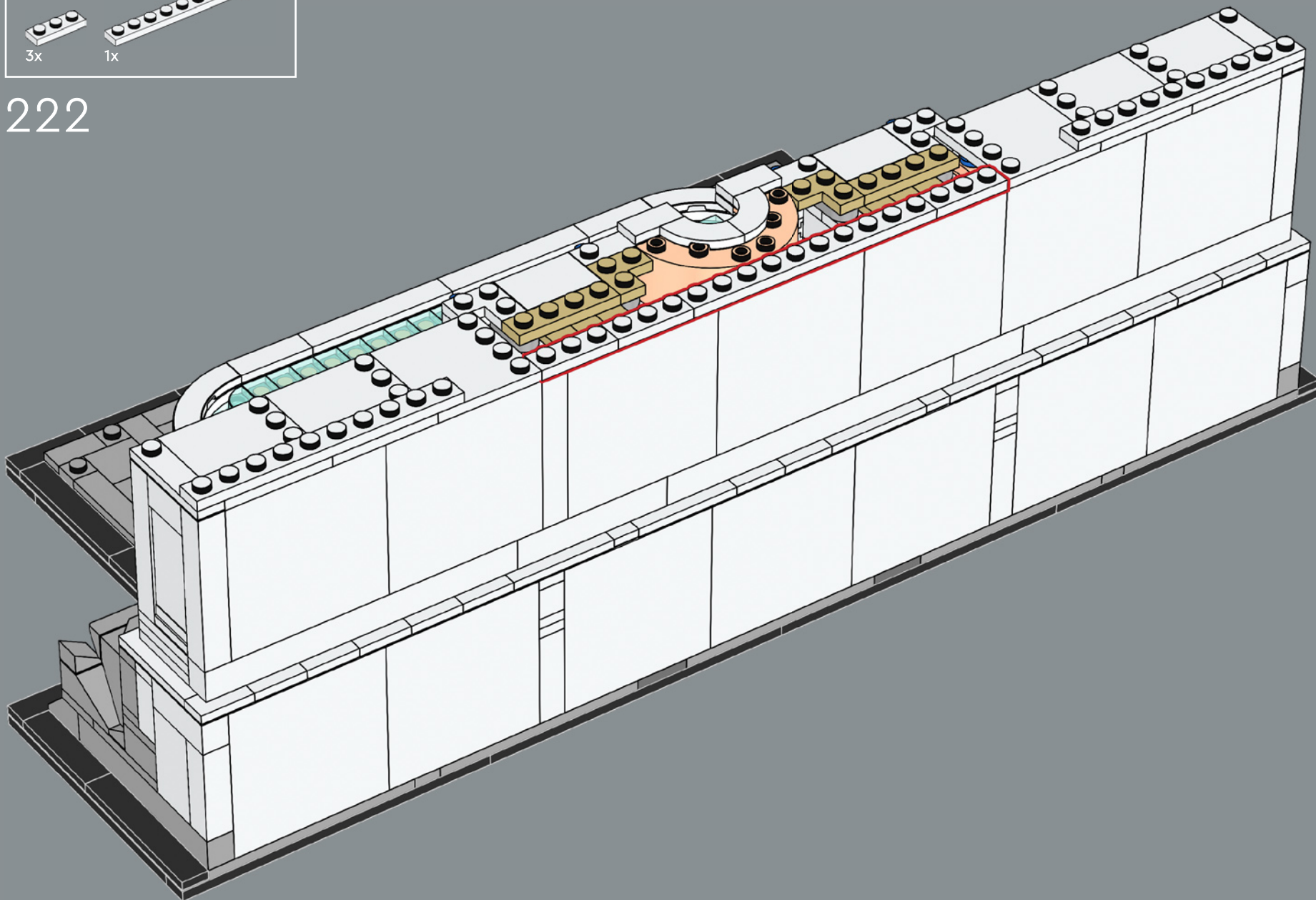

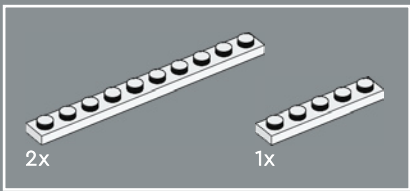

223

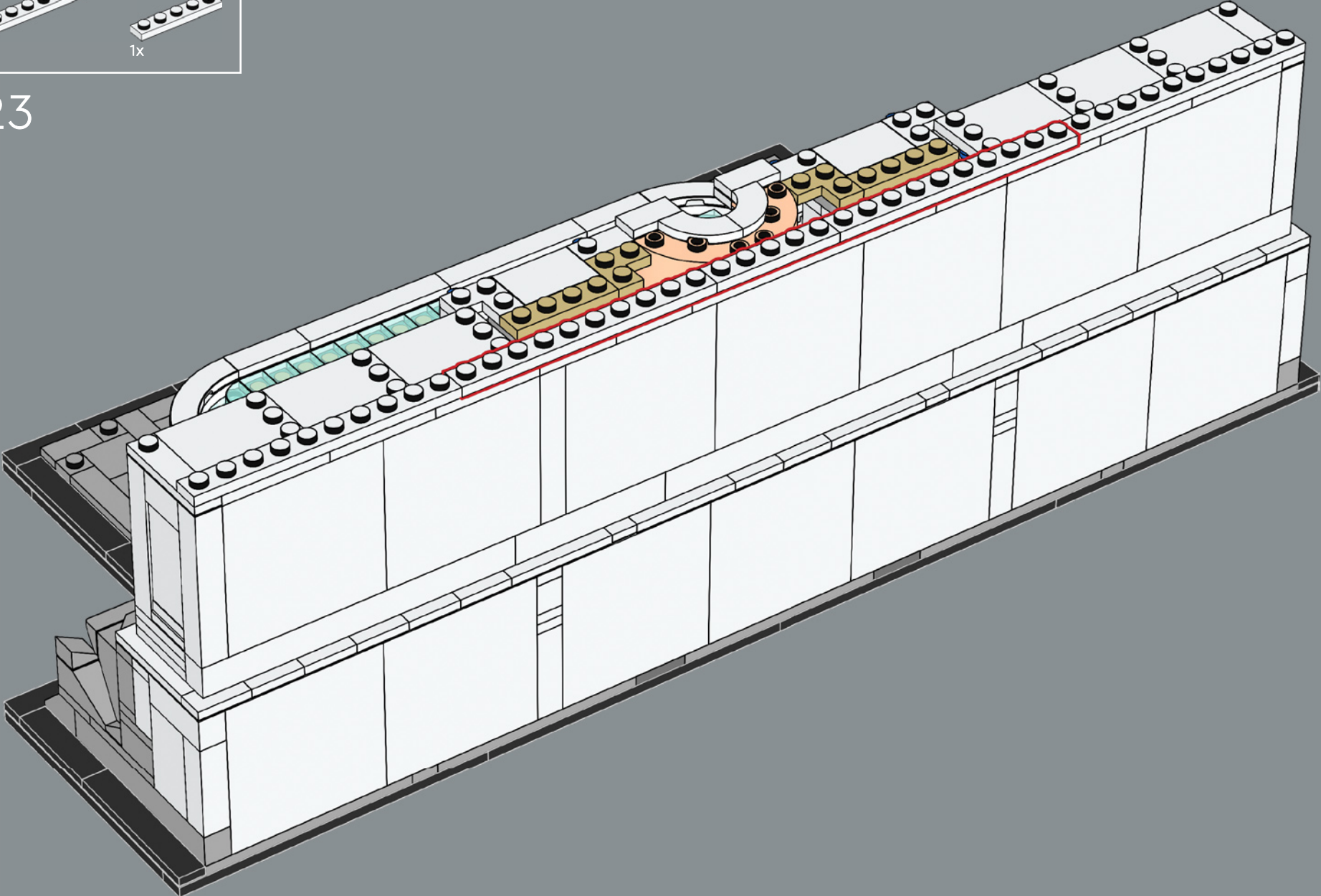



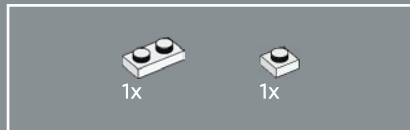
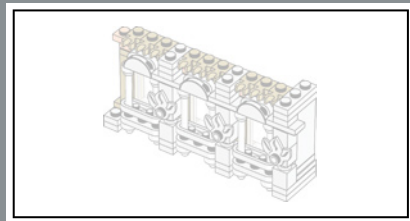

224

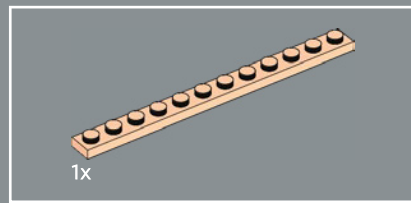
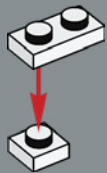

225

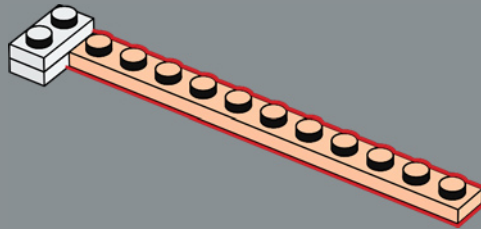

226

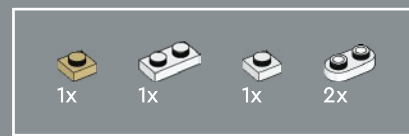
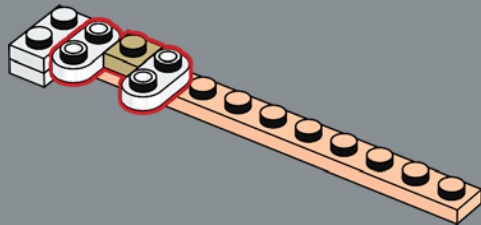

227

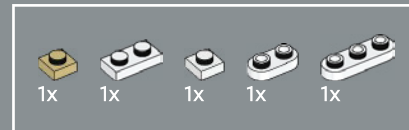
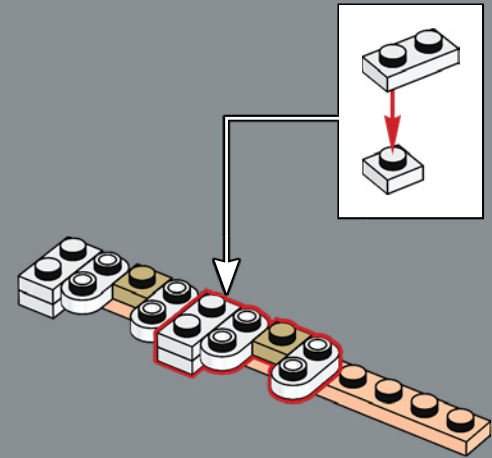

228

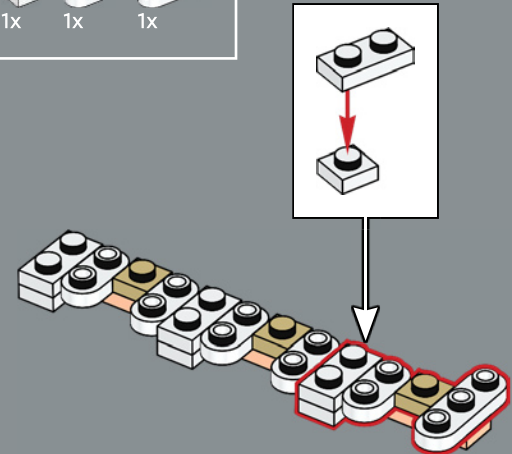

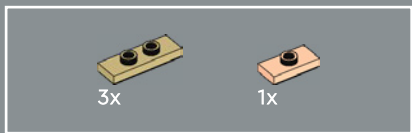

229

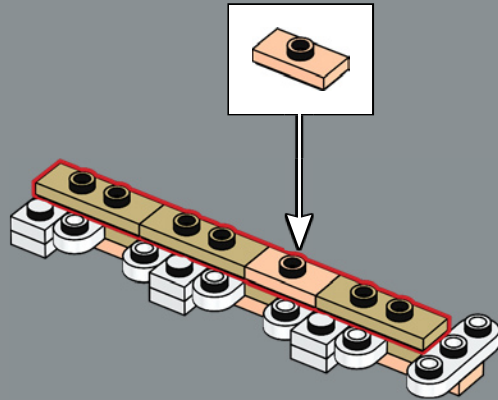

230

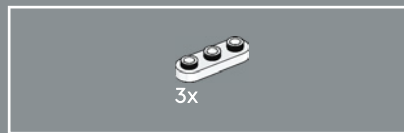
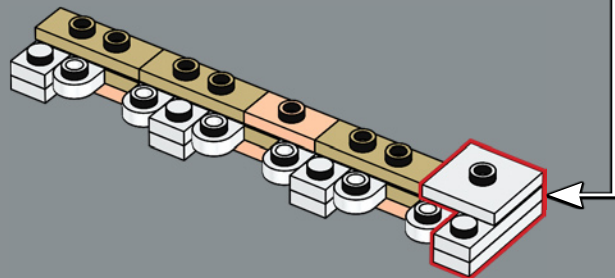
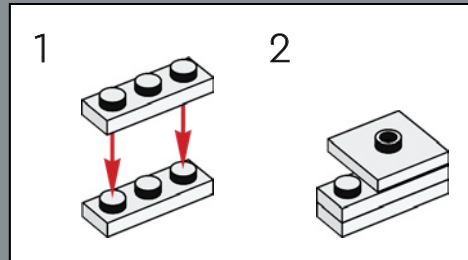

231

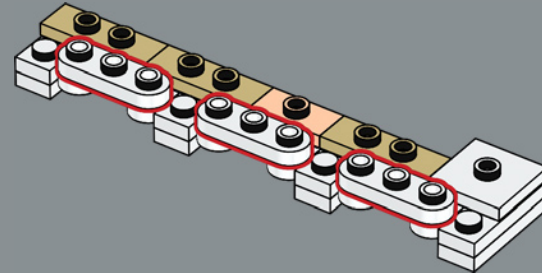

232

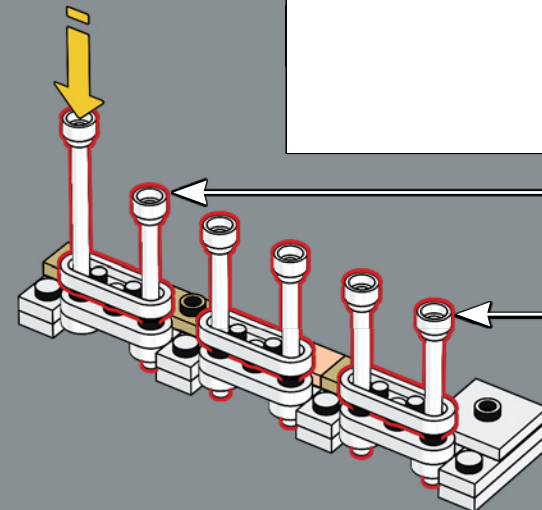
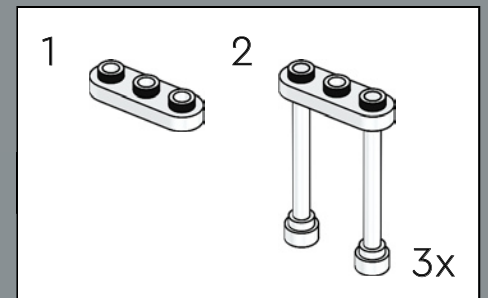

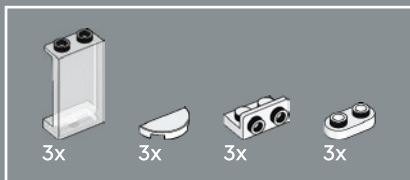

233

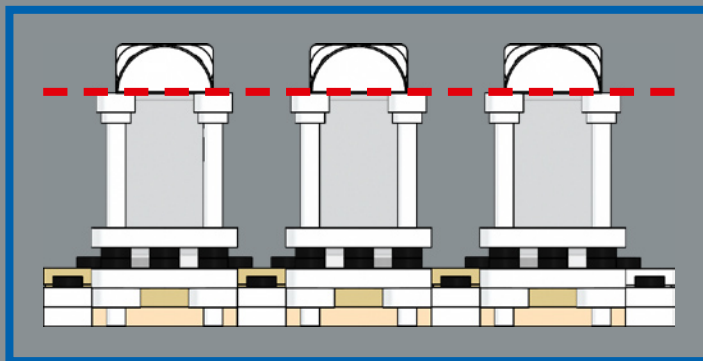

La "finestra" più a destra è in realtà solo un muro dipinto che va ad aggiungersi alle altre 11 finestre.

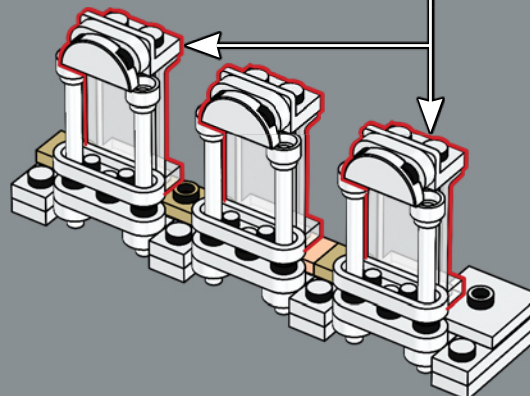
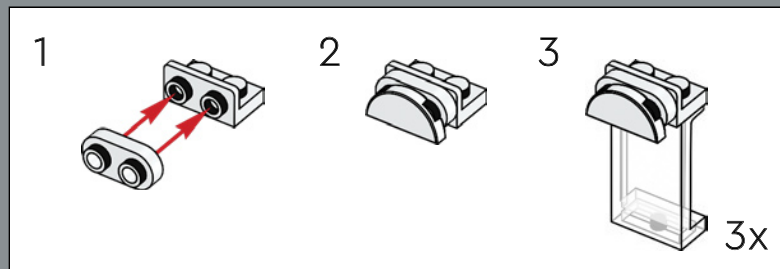

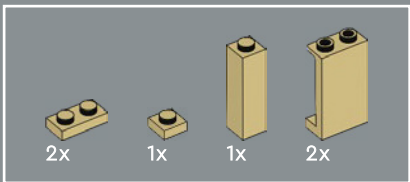

234

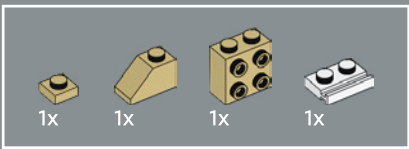
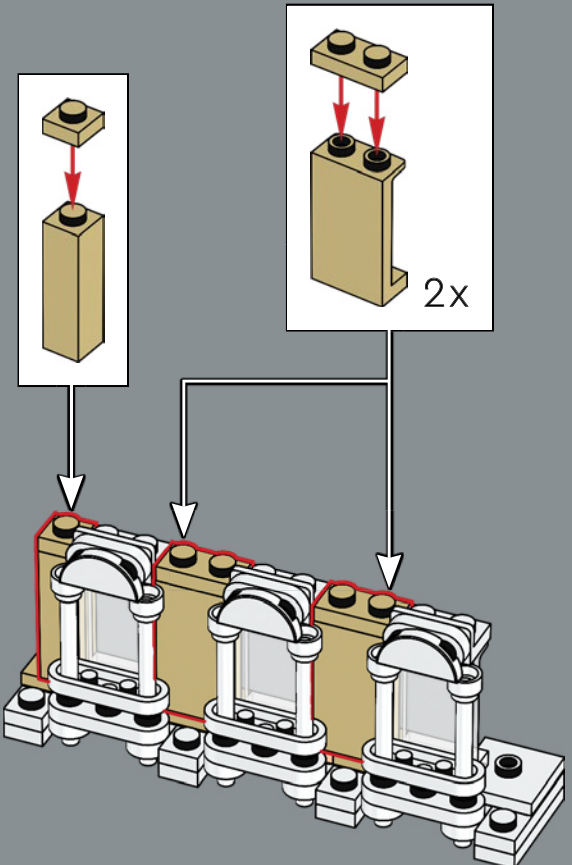

235

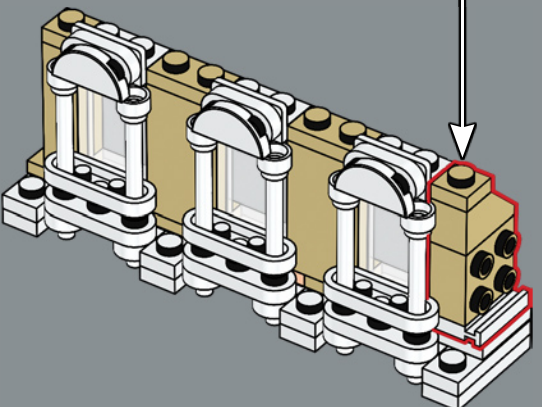
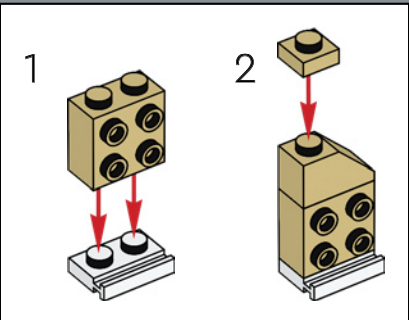

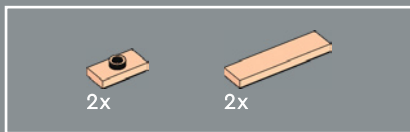

236

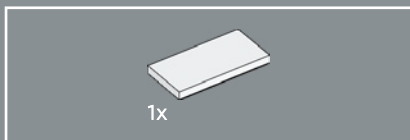
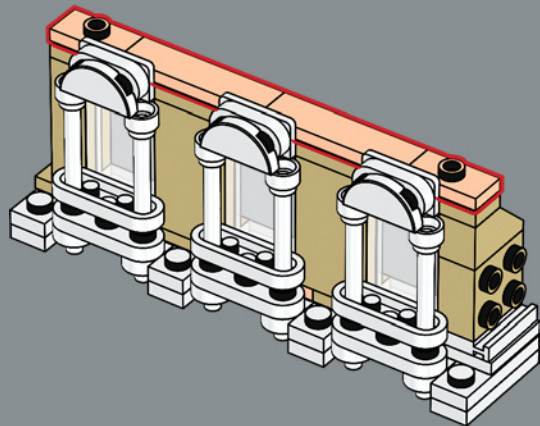

237

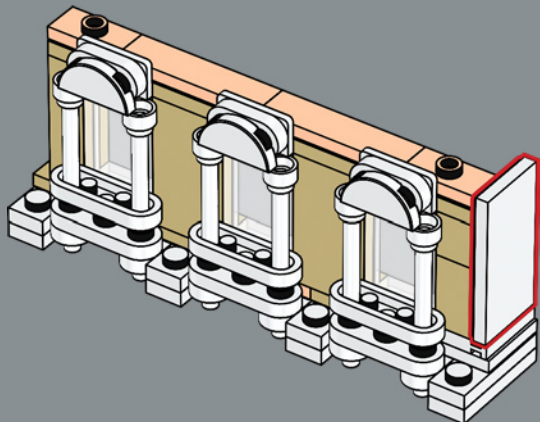

238

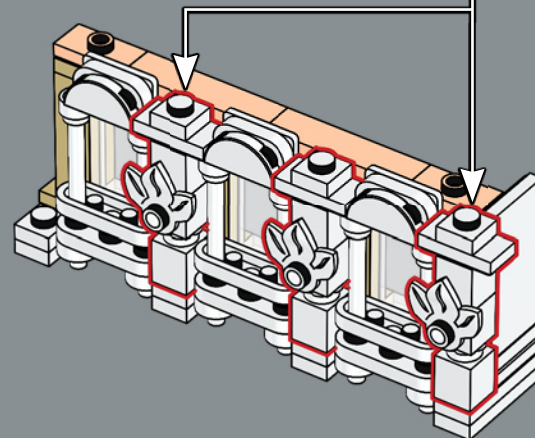
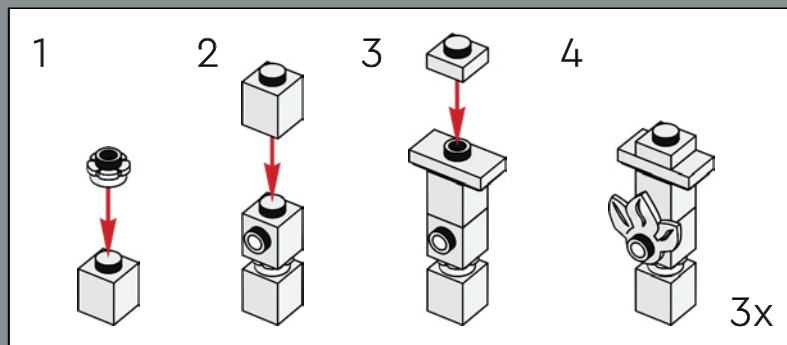

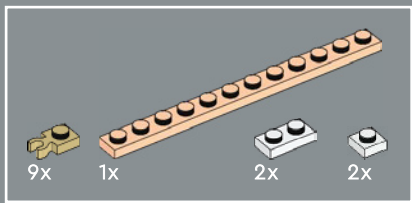

239

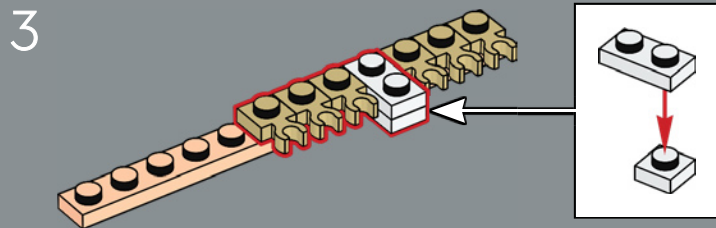
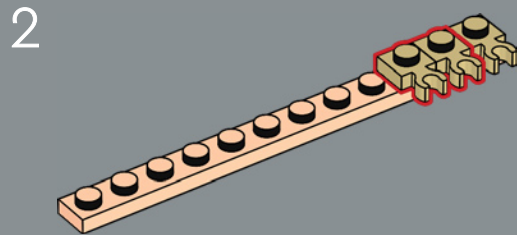
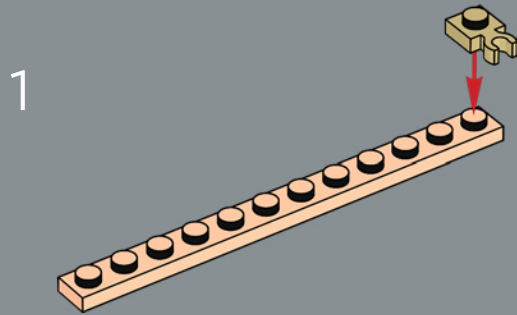

4

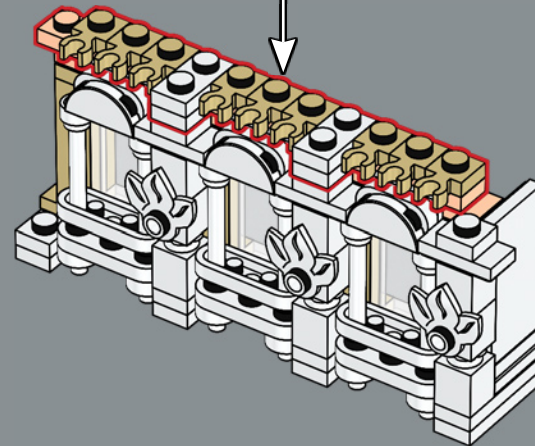
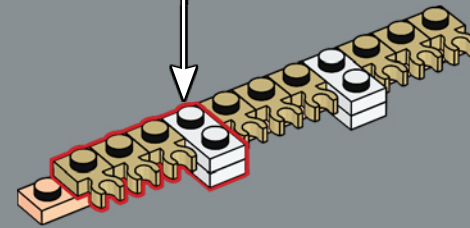
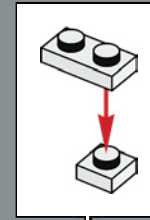

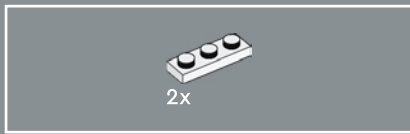

240

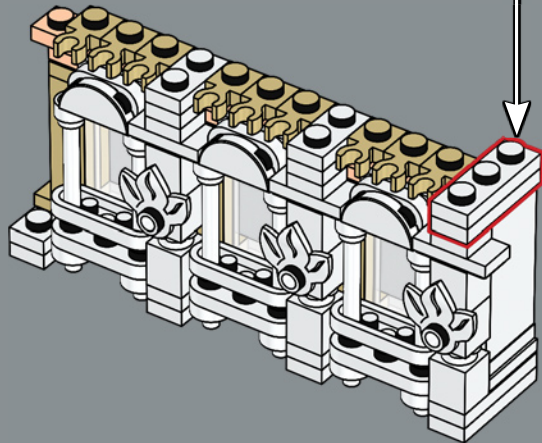
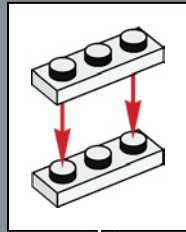

241

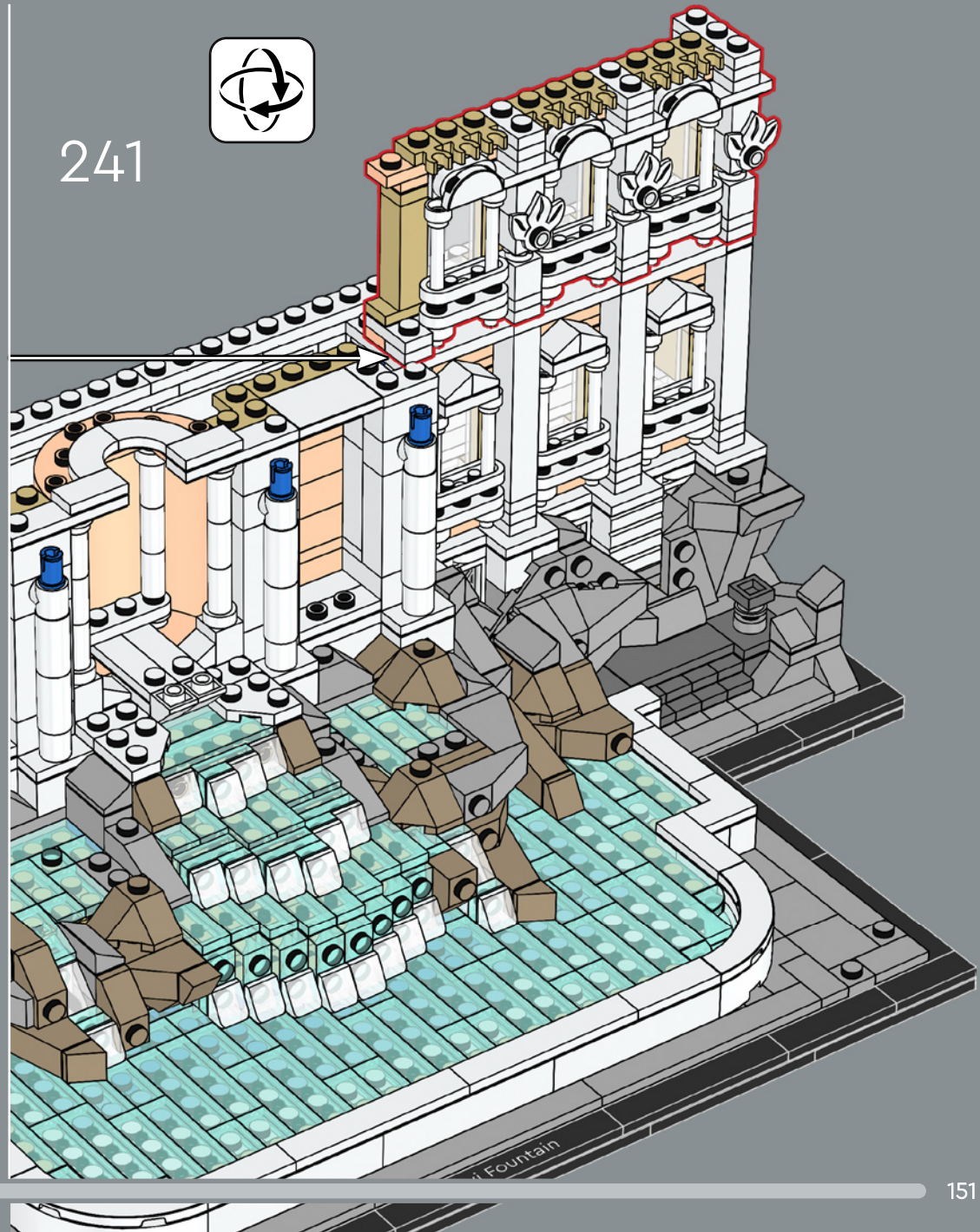

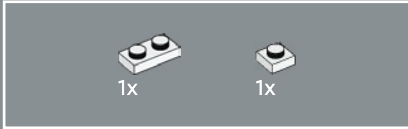
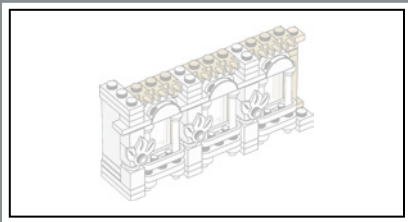

242

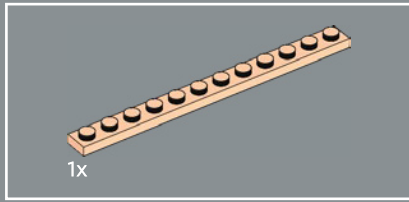
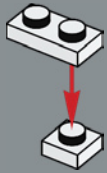

243

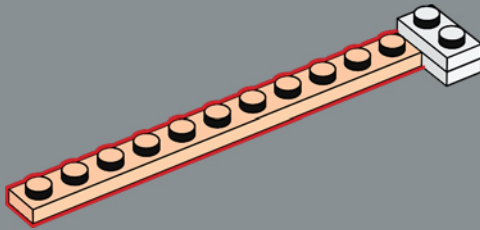

244

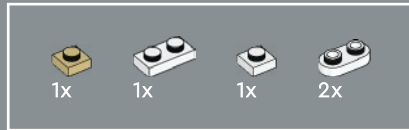
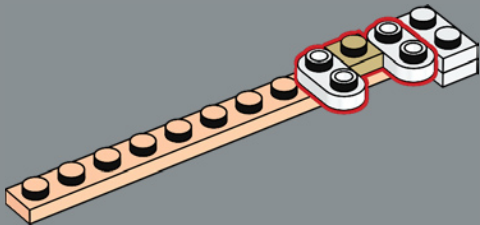

245

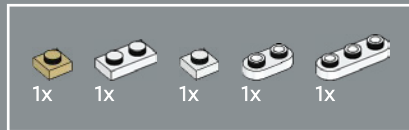
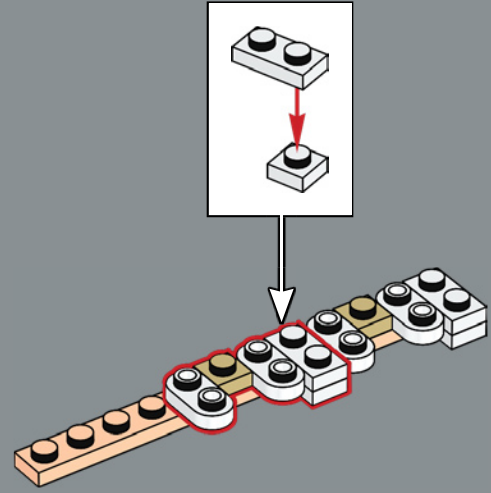

246

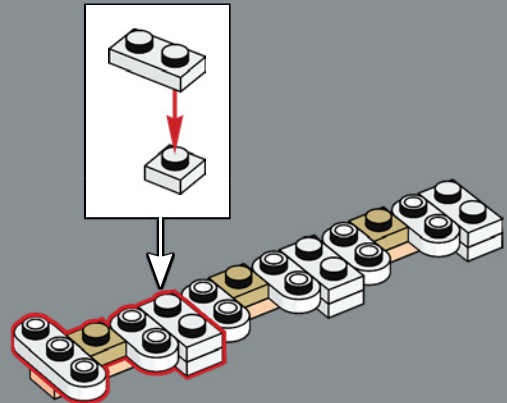



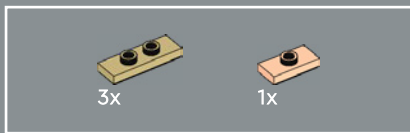

247

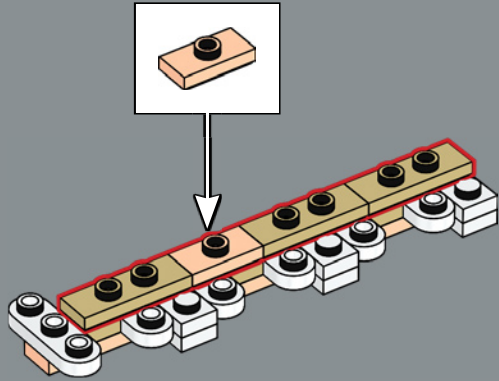

248

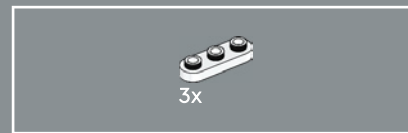
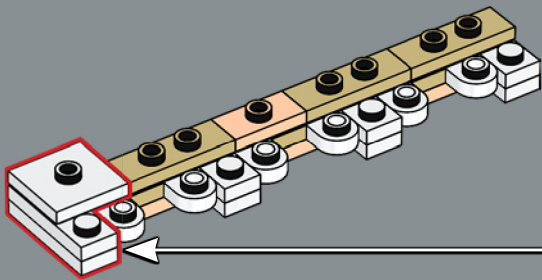
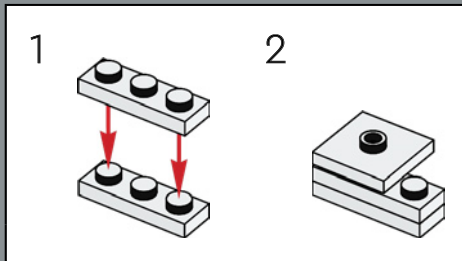

249

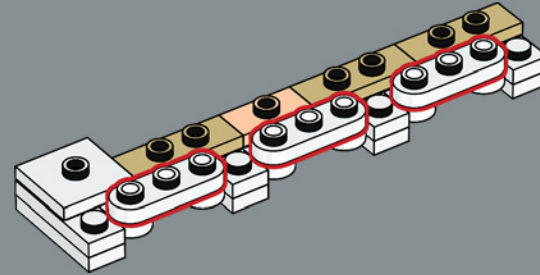

250

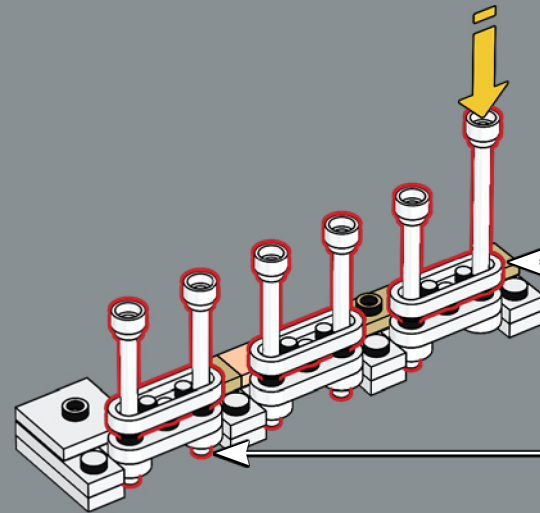
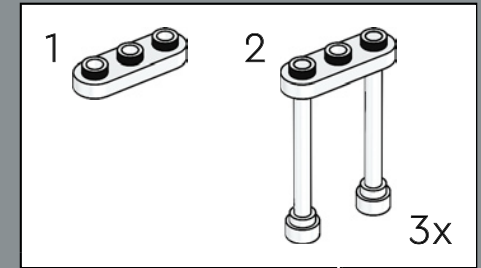

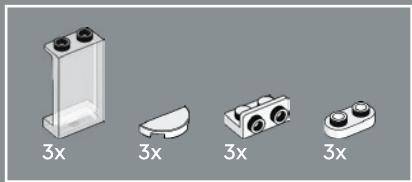

251

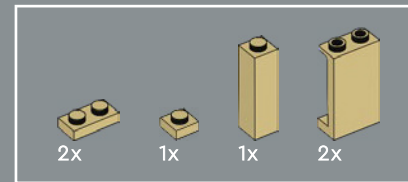
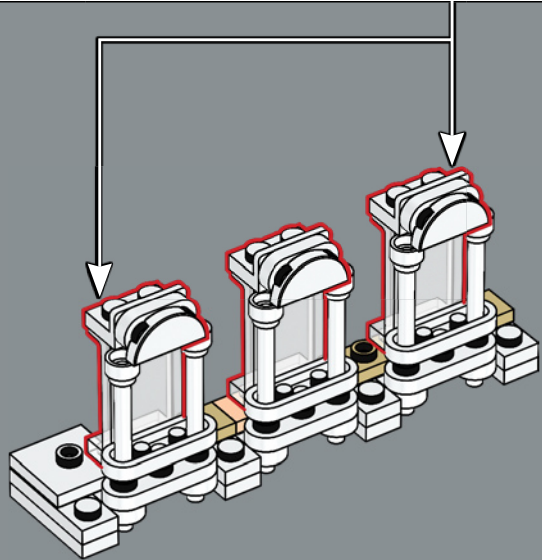
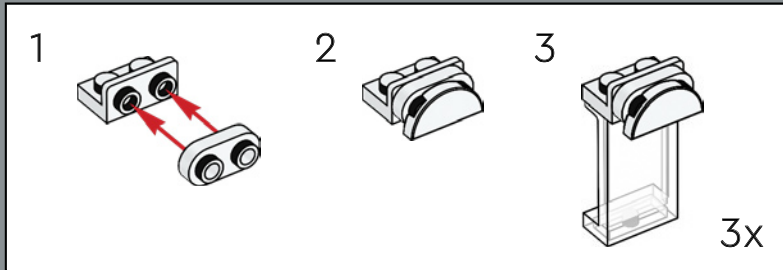
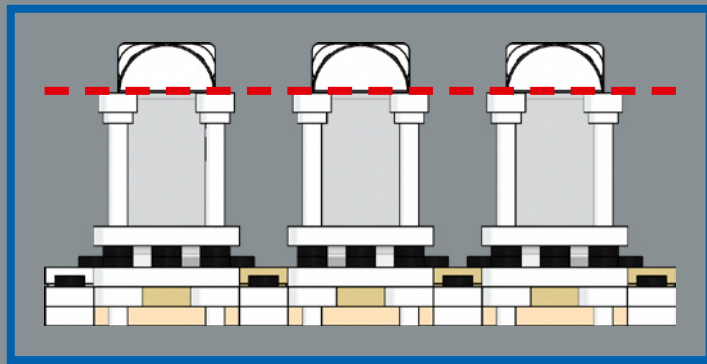

252

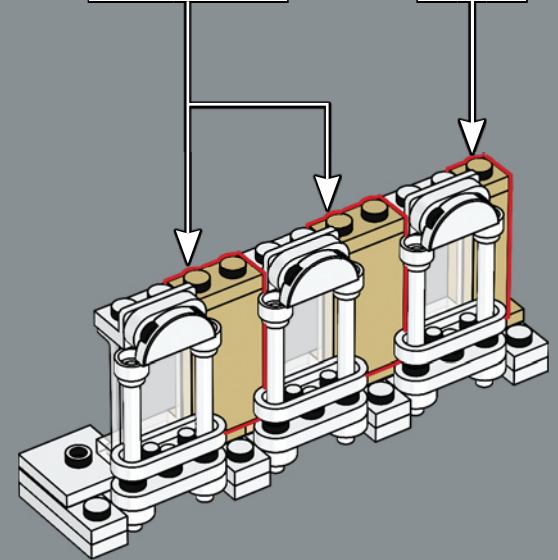
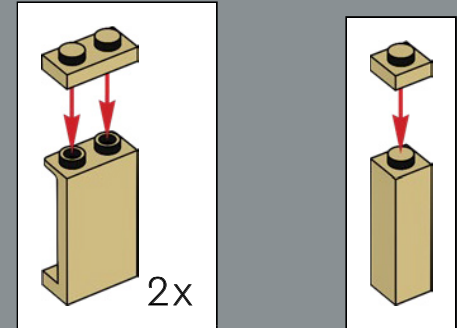

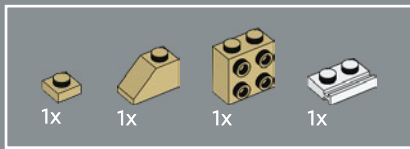

253

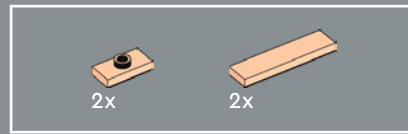
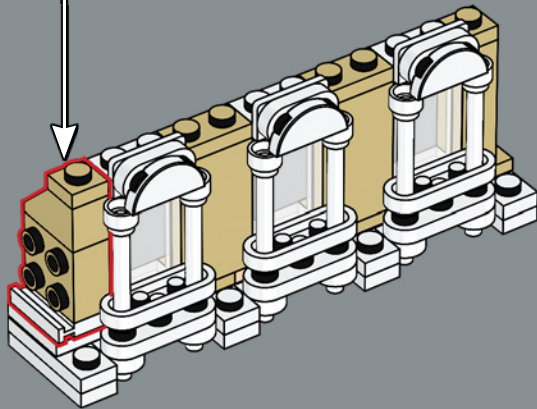
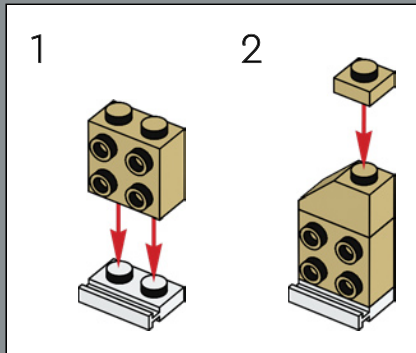

254

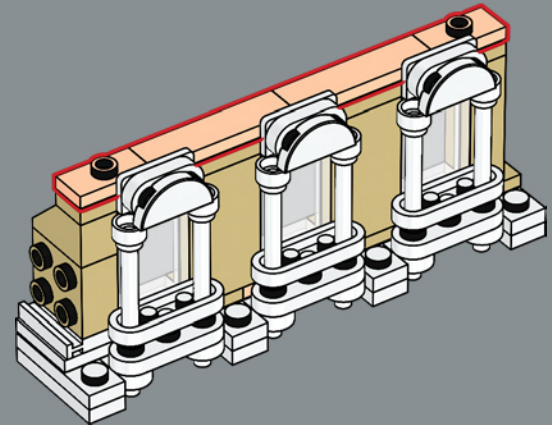

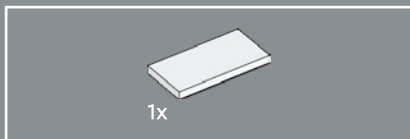

255

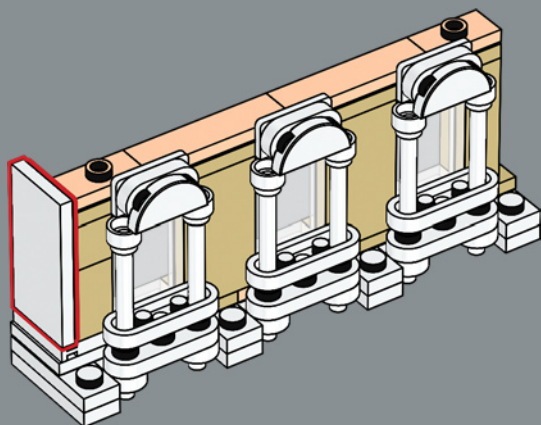

256

Gli elementi foglia LEGO® utilizzati qui aiutano a creare i capitelli dei pilastri corinzi.

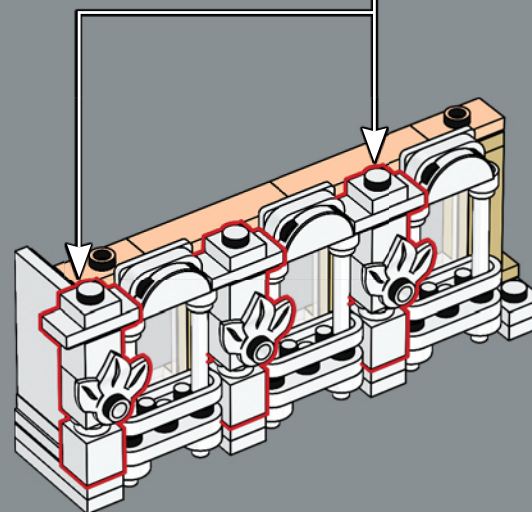
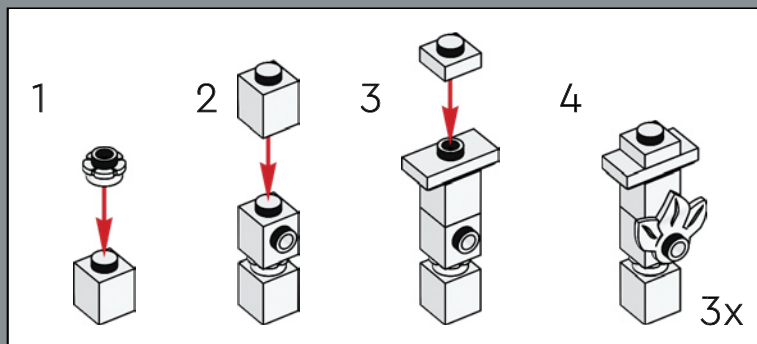

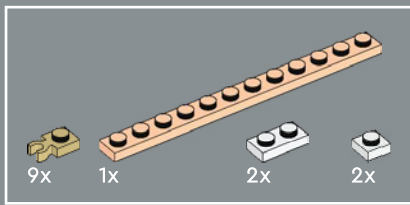

257

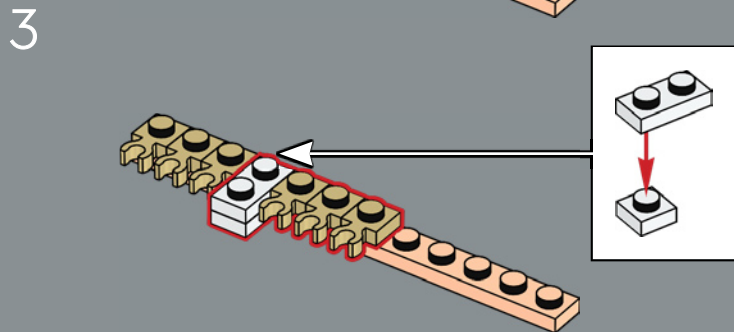
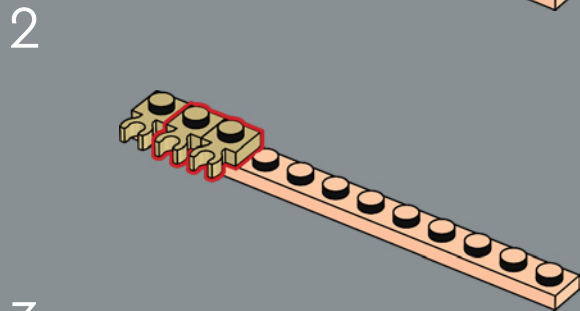
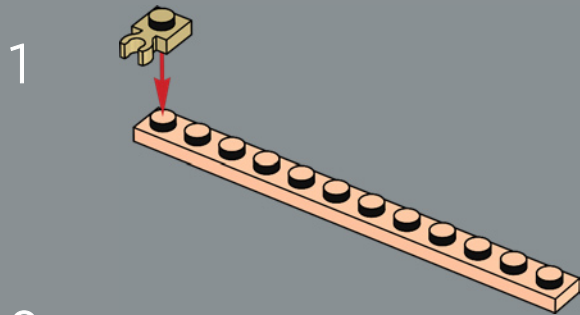

4

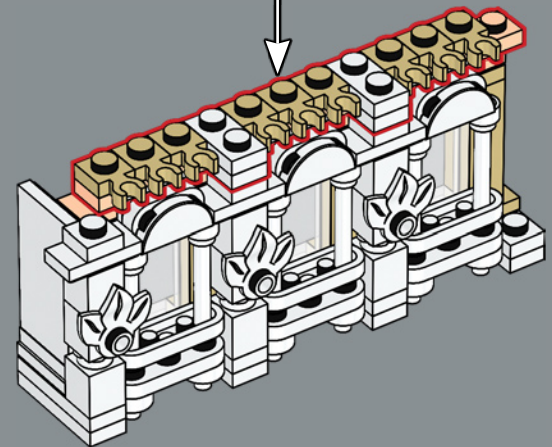
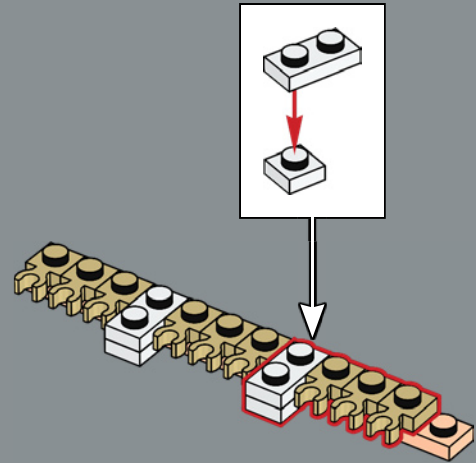

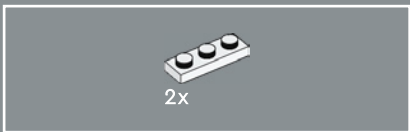

258

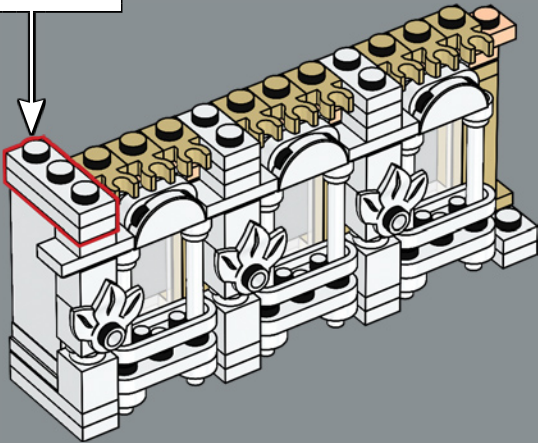
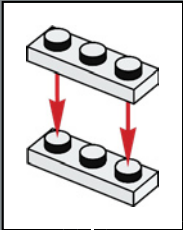

259

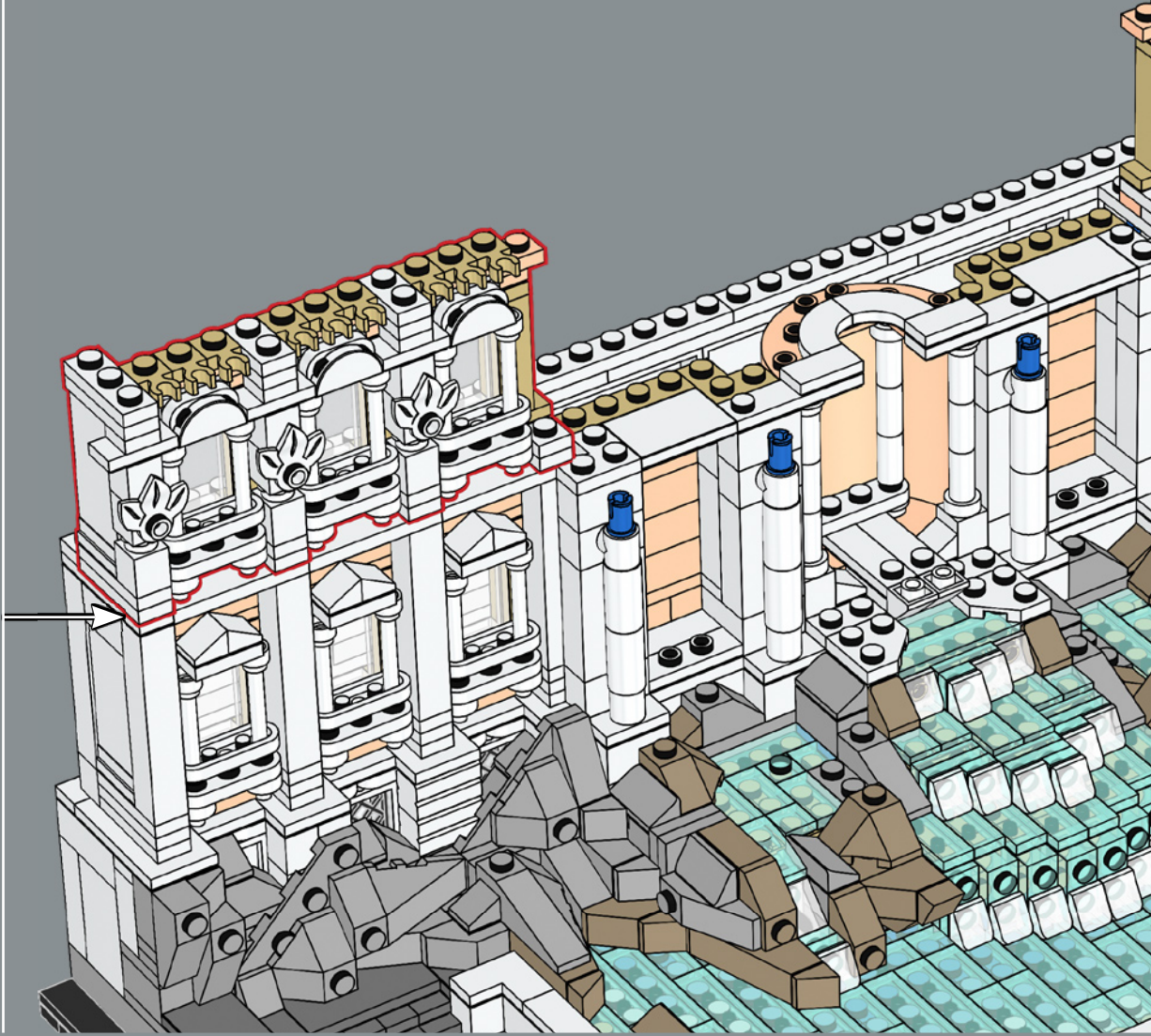

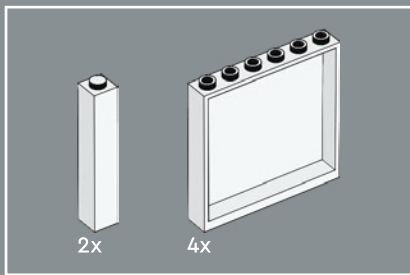

260

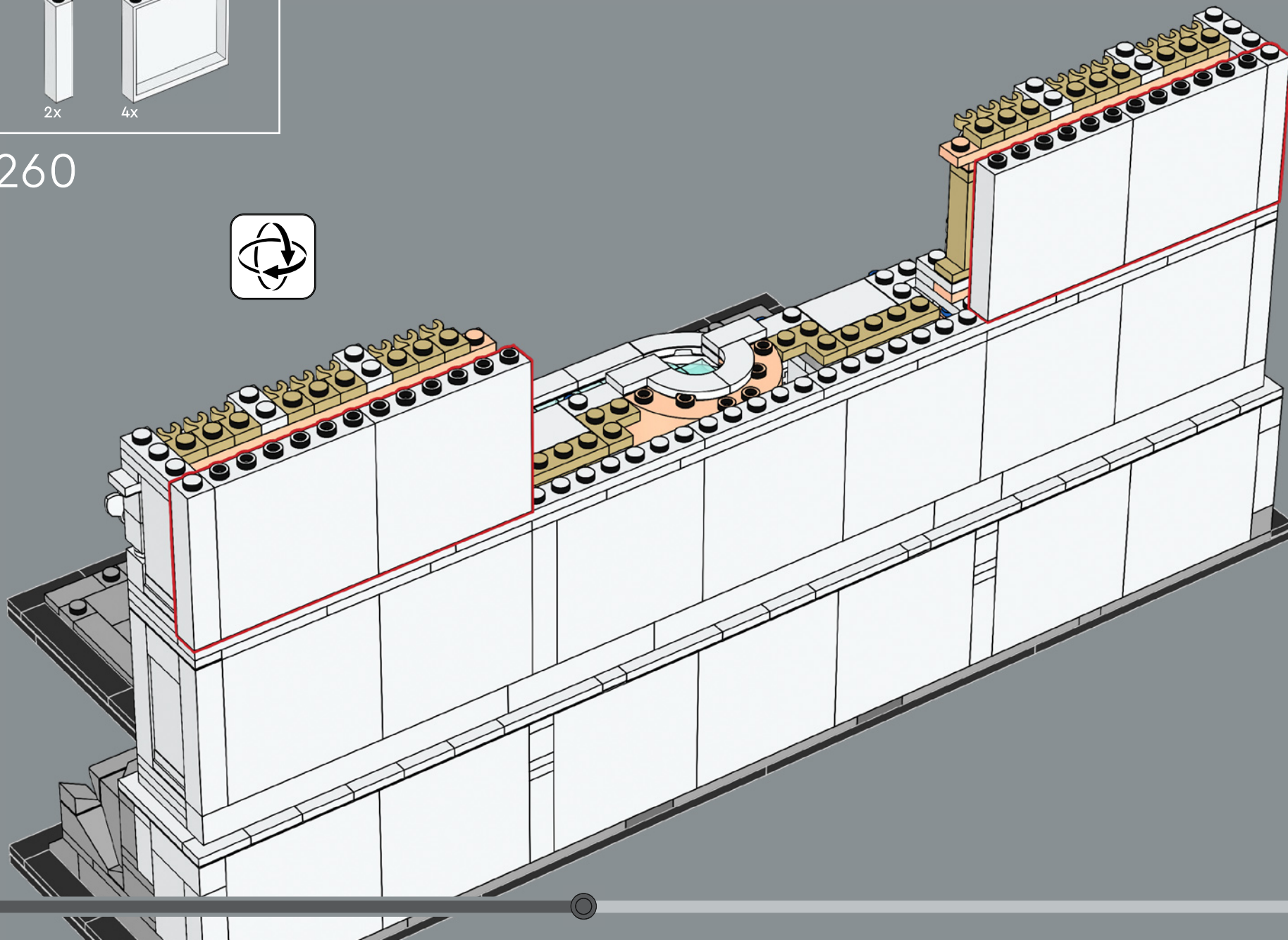



261

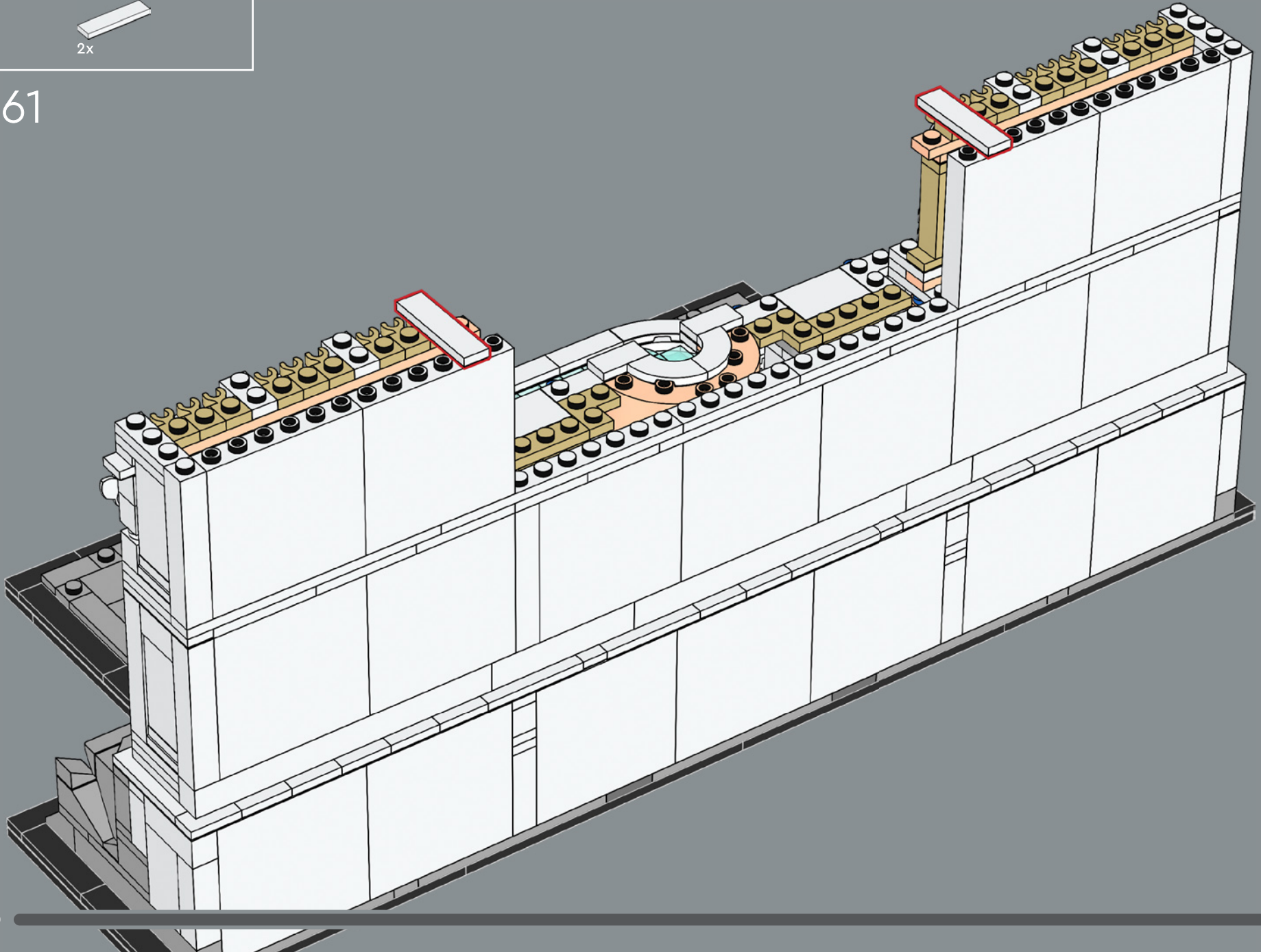



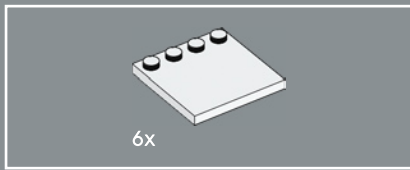

262

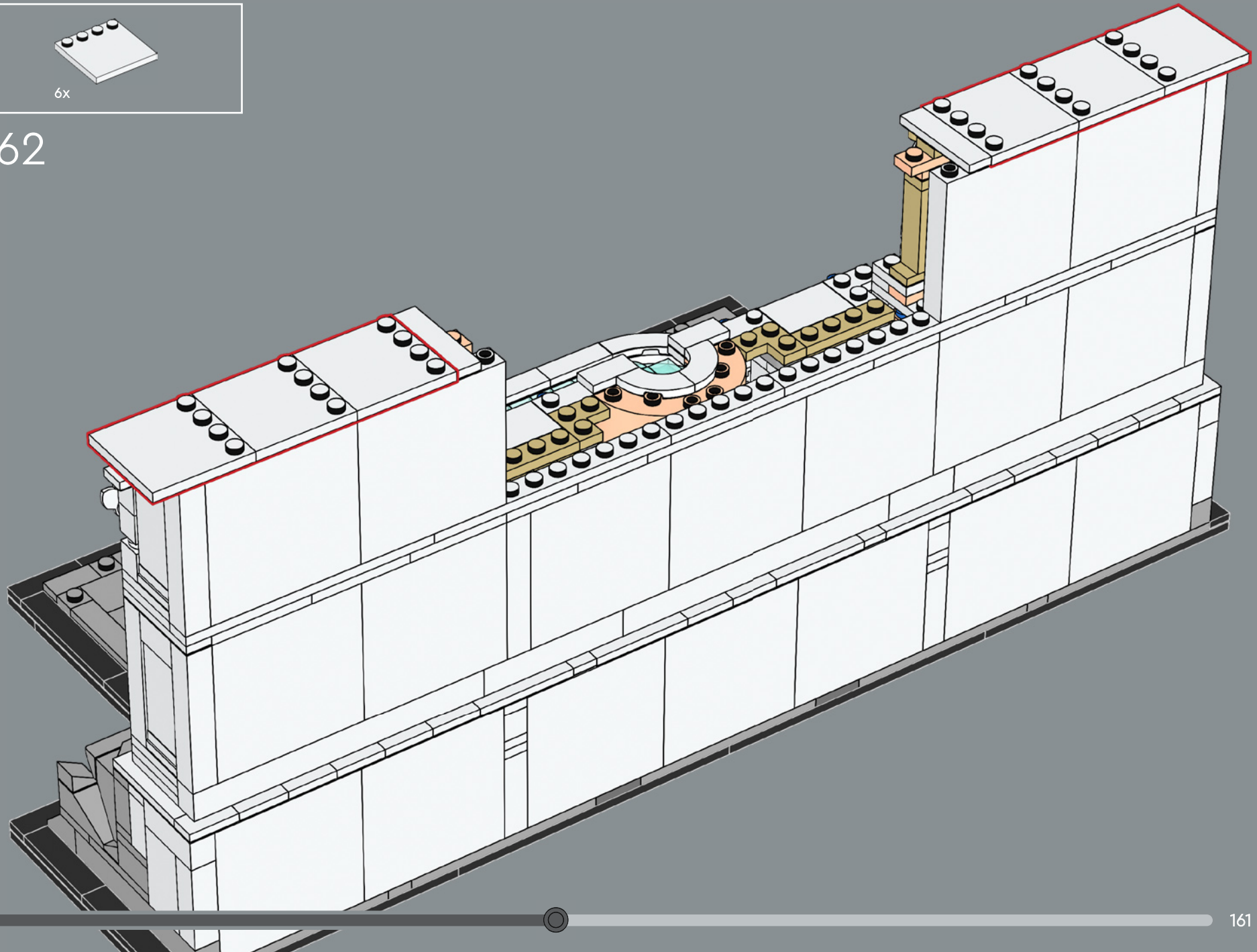

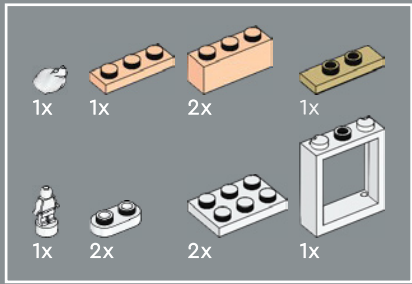

263

1

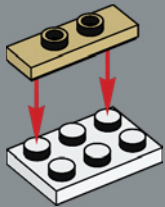

2

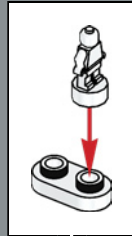
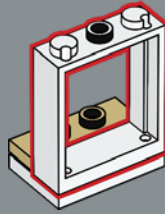

3

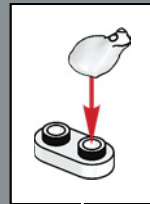
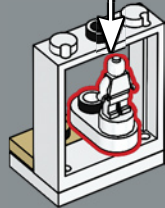

4



1

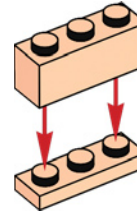

2

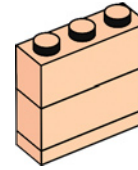

5



6



Sia il rilievo sinistro sia quello destro includono una figura in piedi e una inginocchiata, qui rappresentate da una minifigure LEGO® e da una rana.

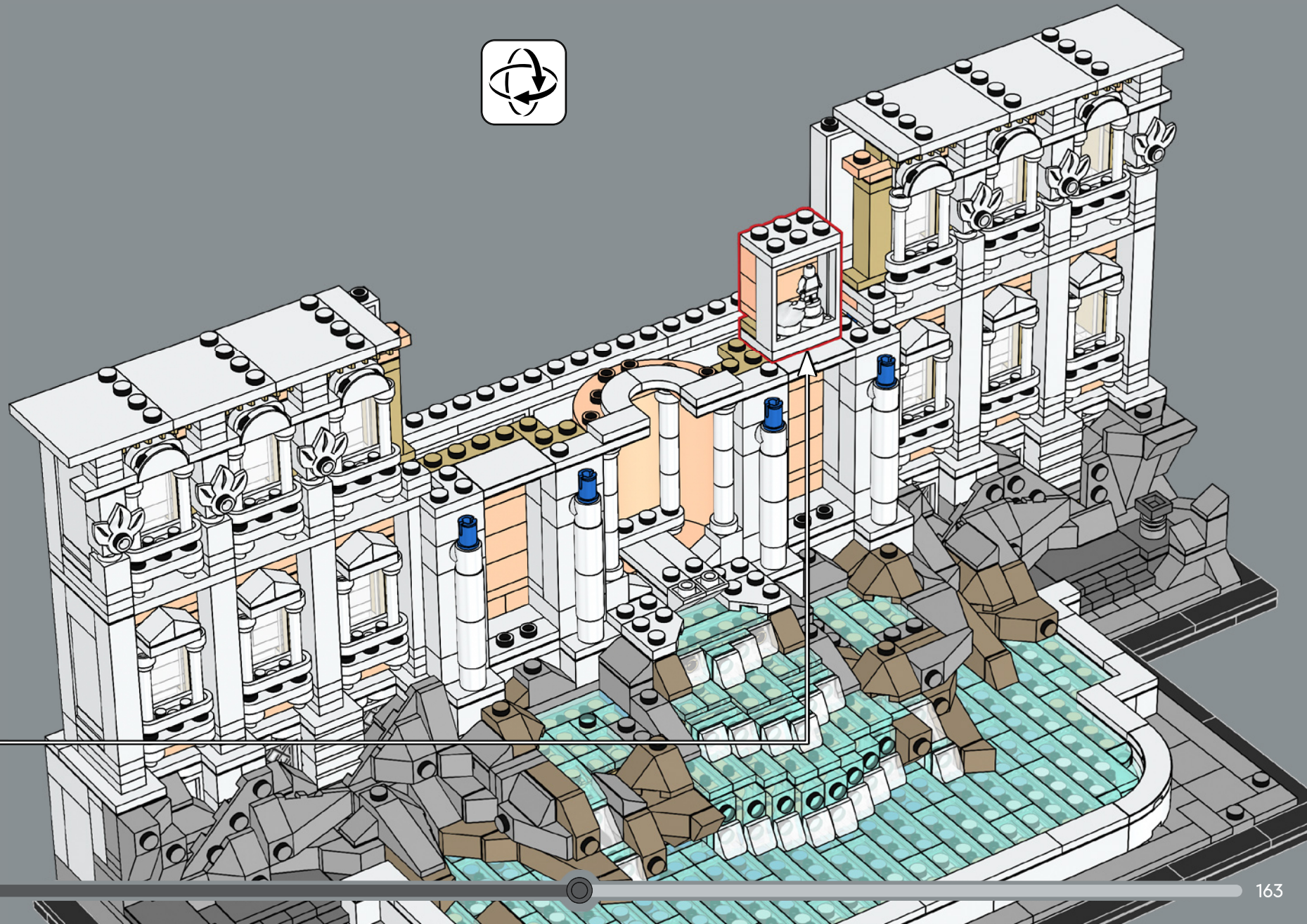

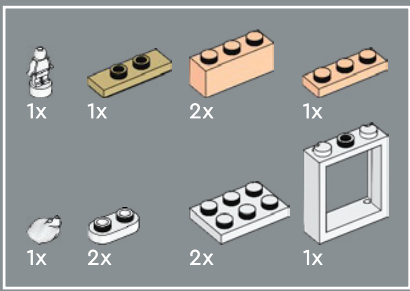

264

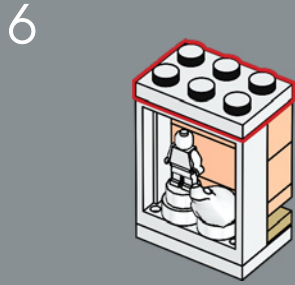
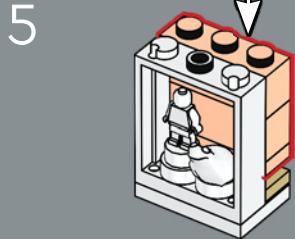
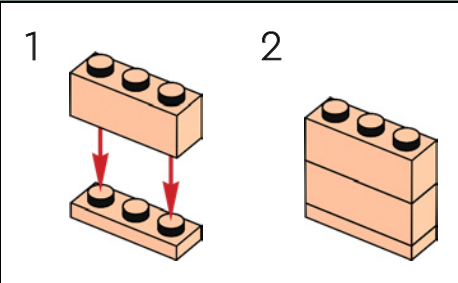
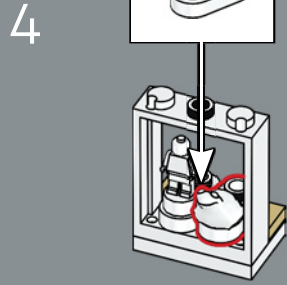
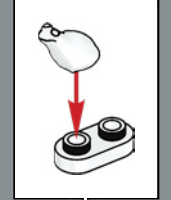
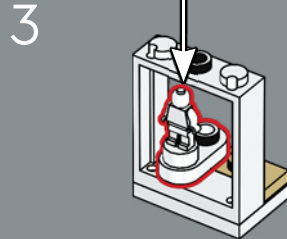
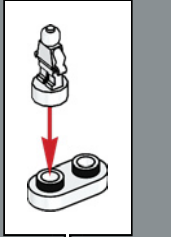
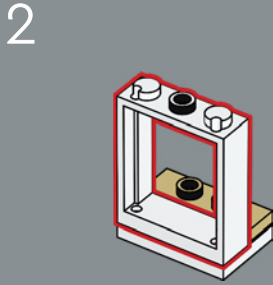
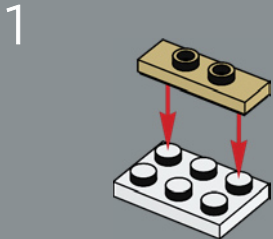

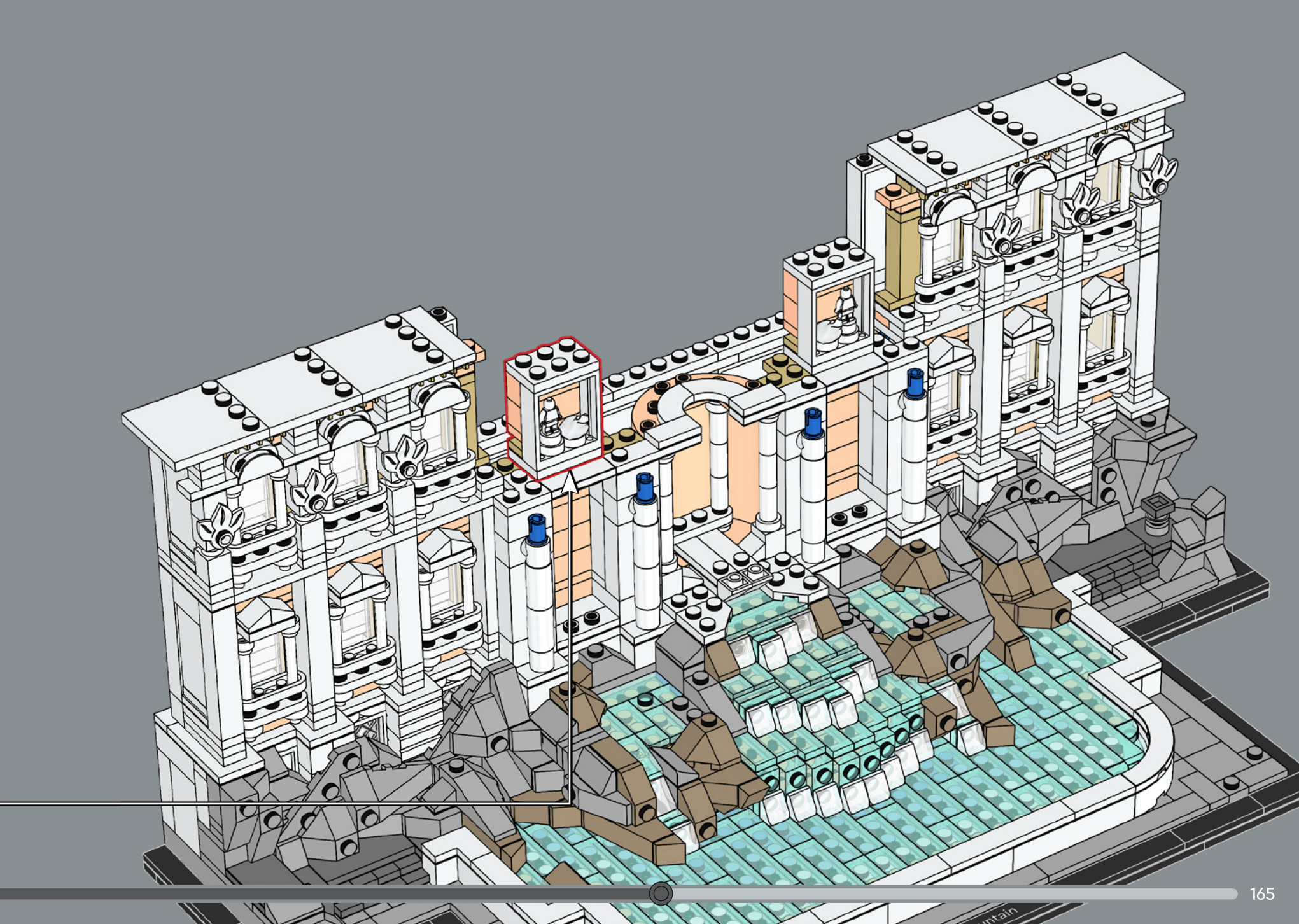

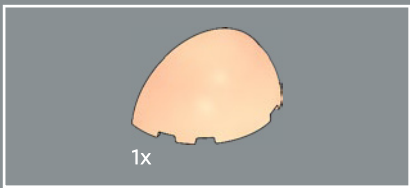

265

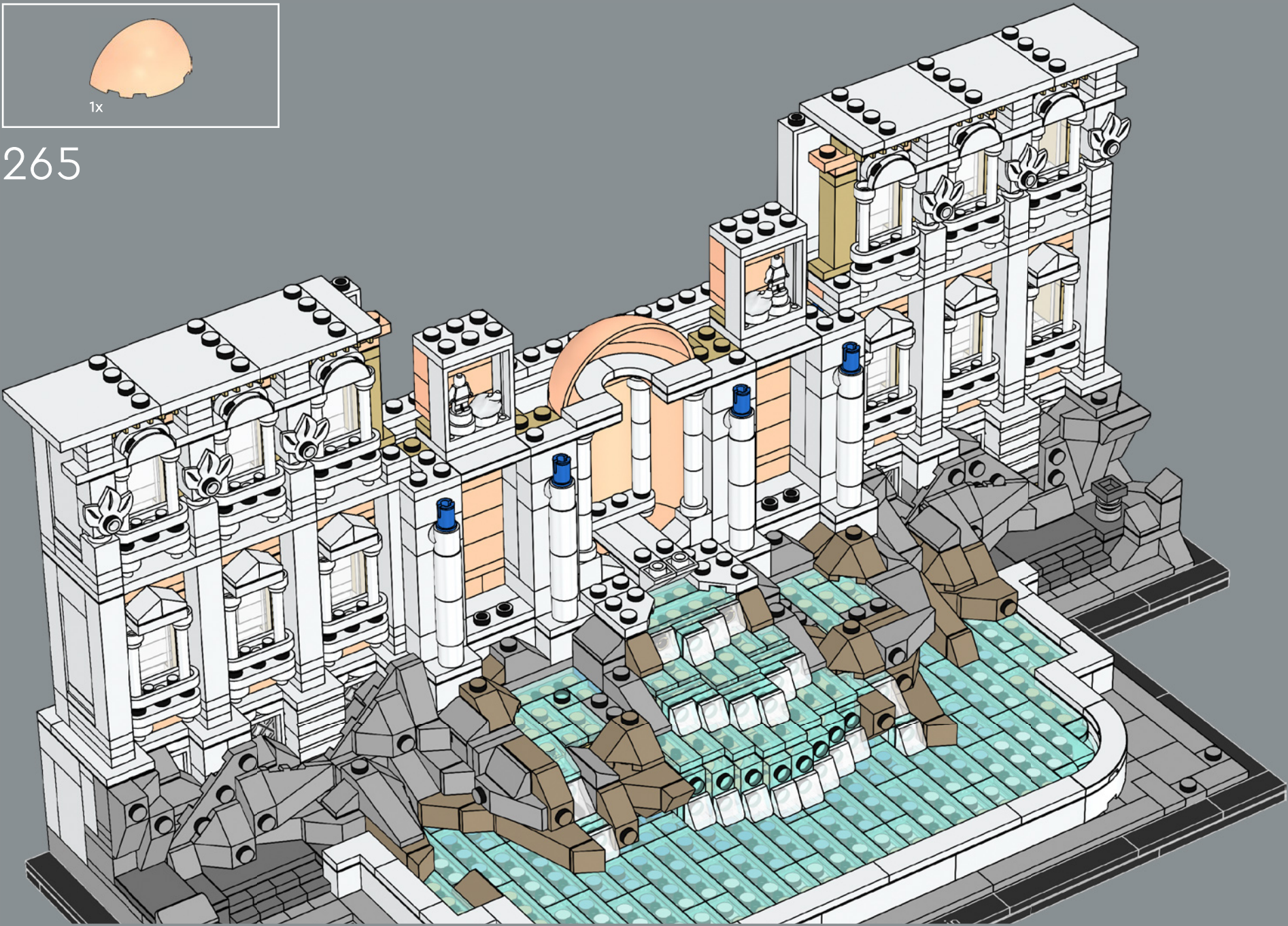

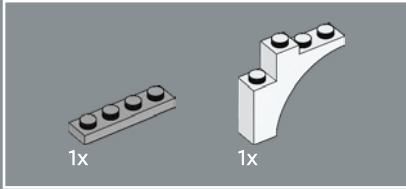
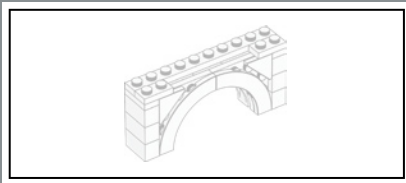

266

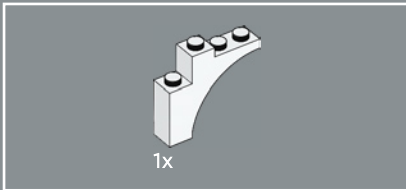
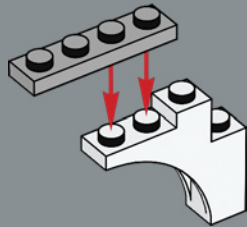

267

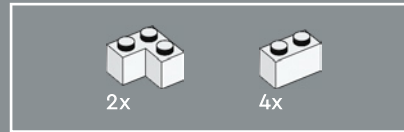
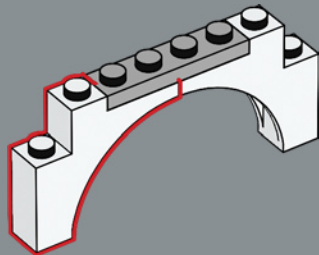

268

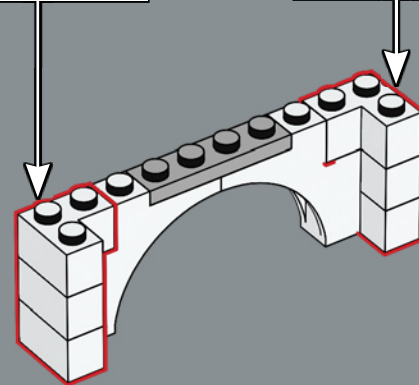
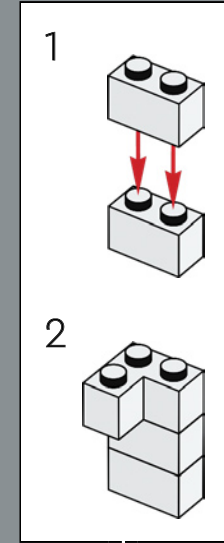
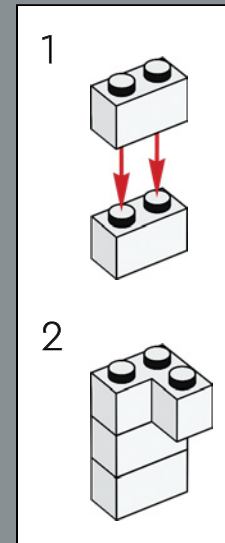

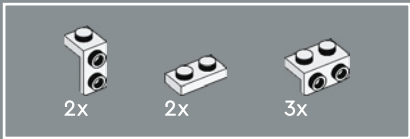

269

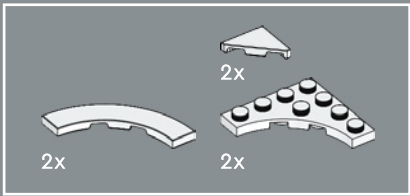
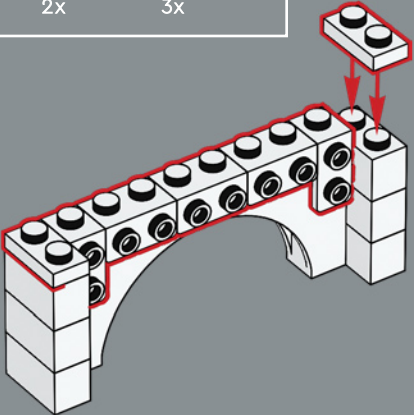

270

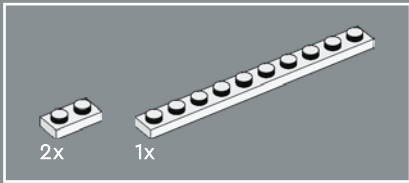
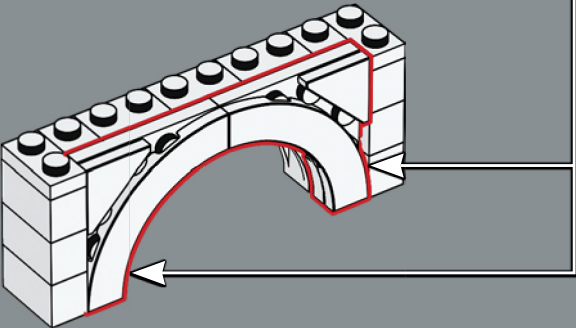
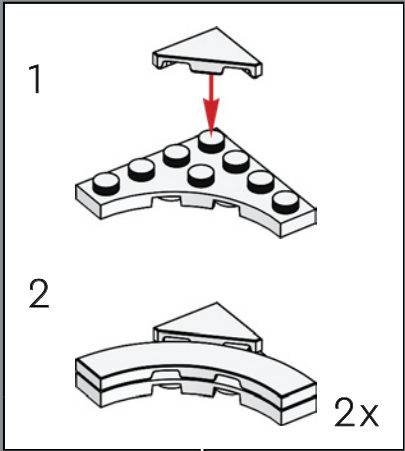

271

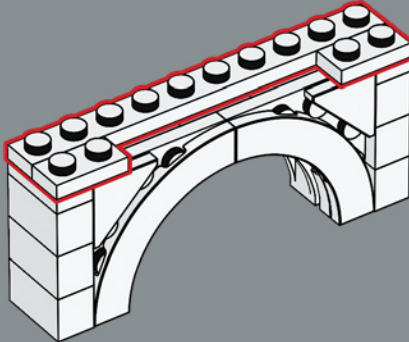



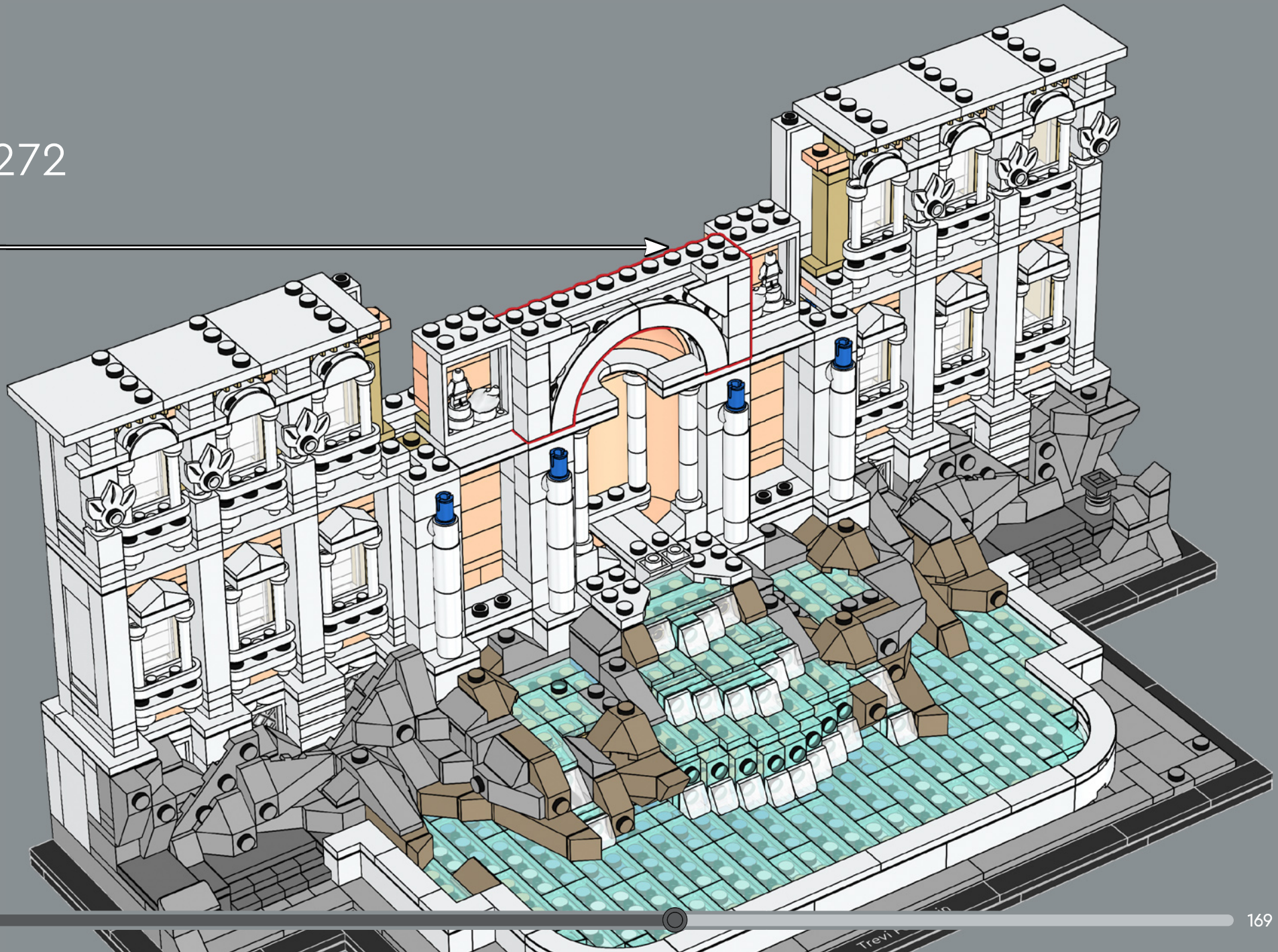

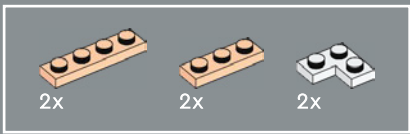

273

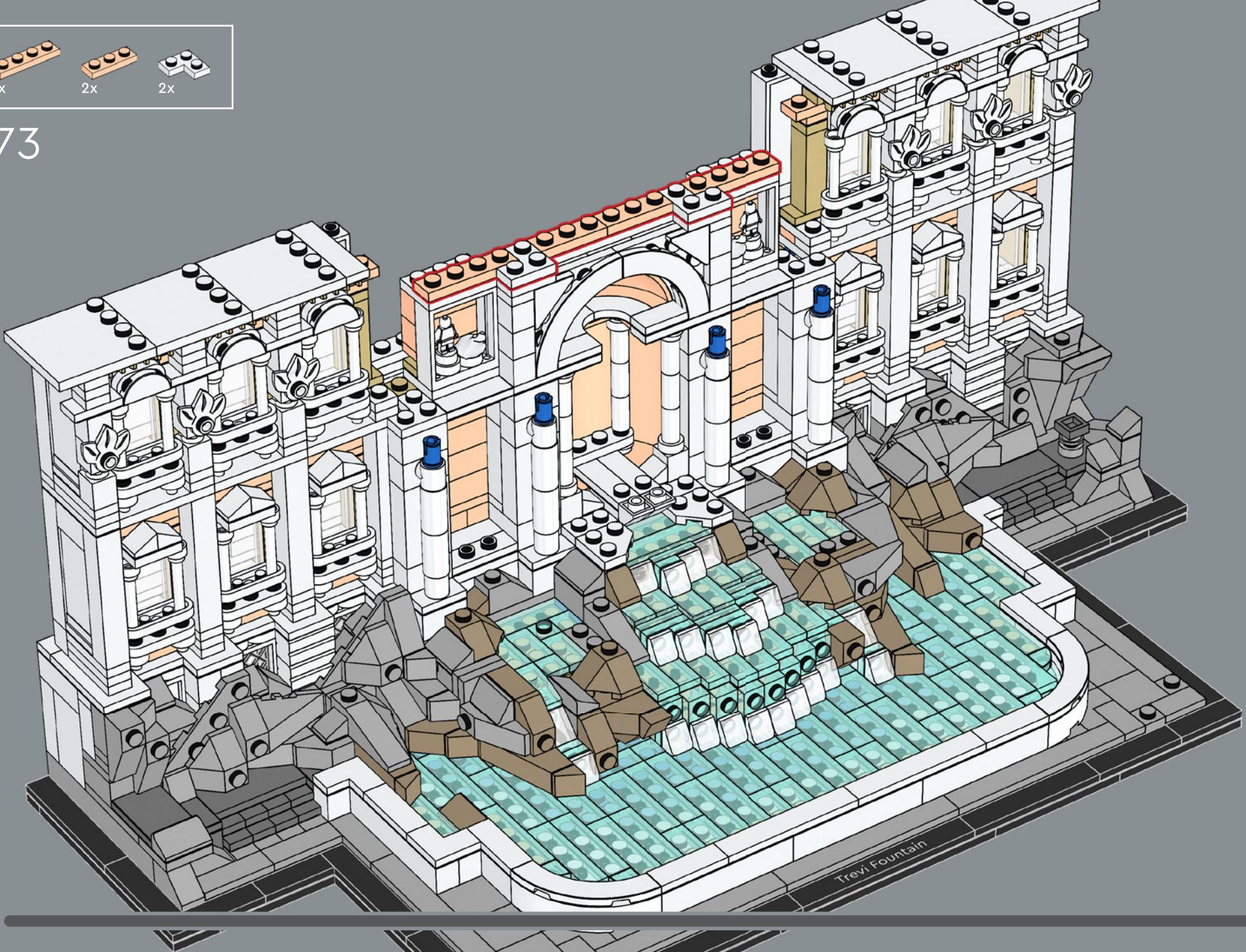

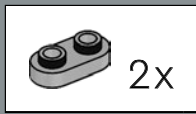
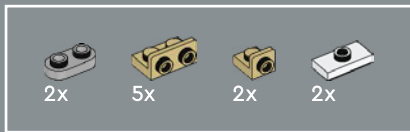

274

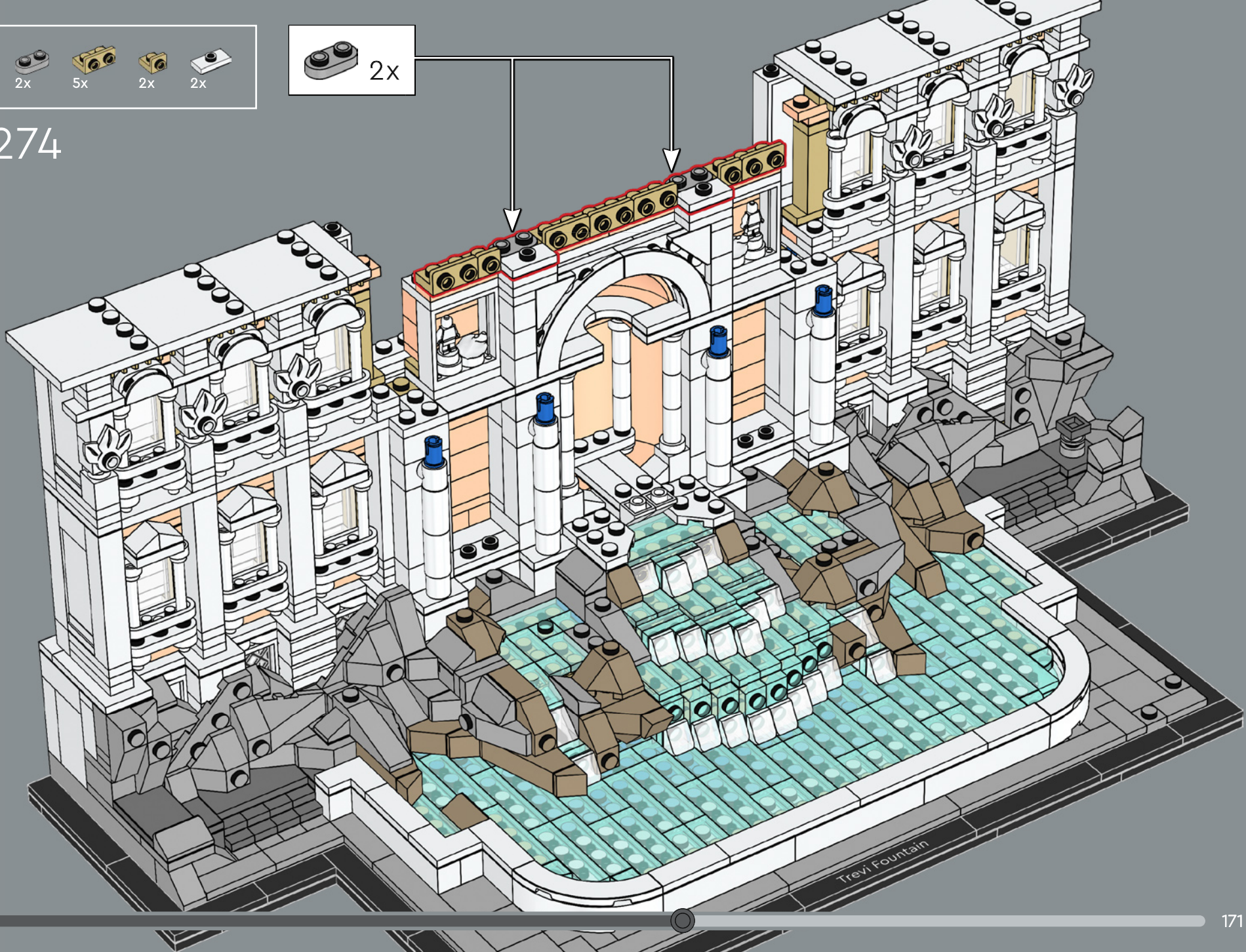

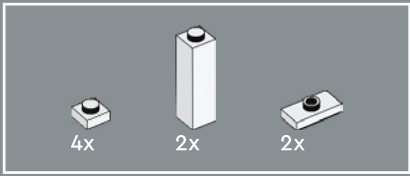

275

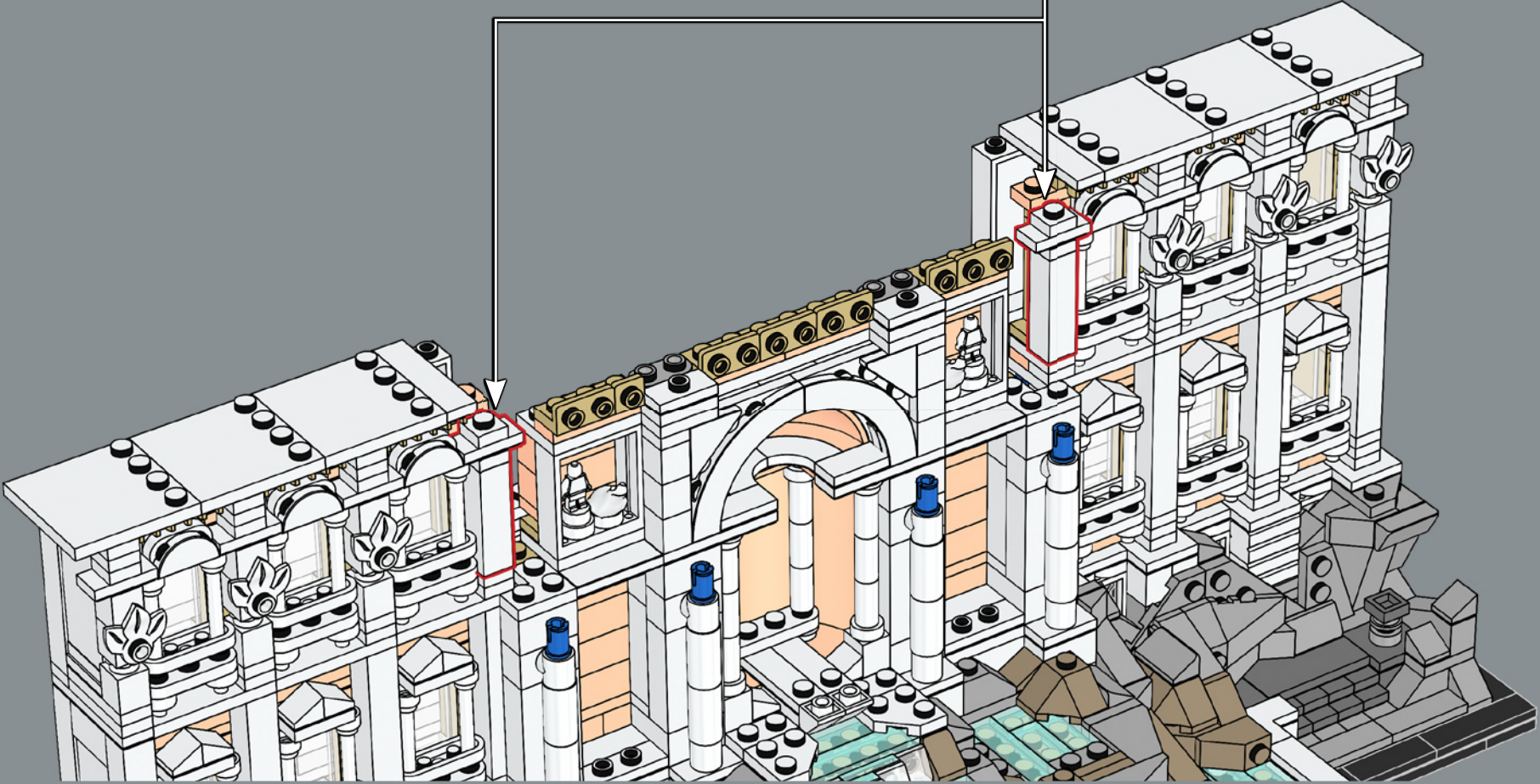
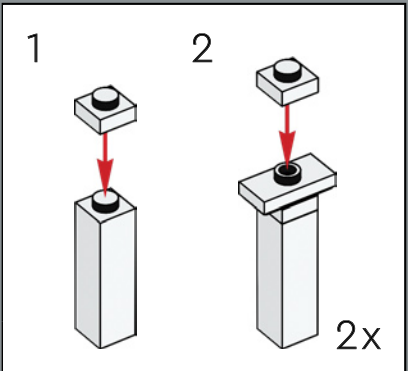

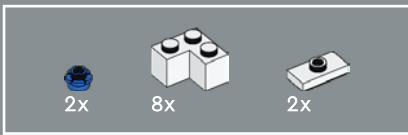

276

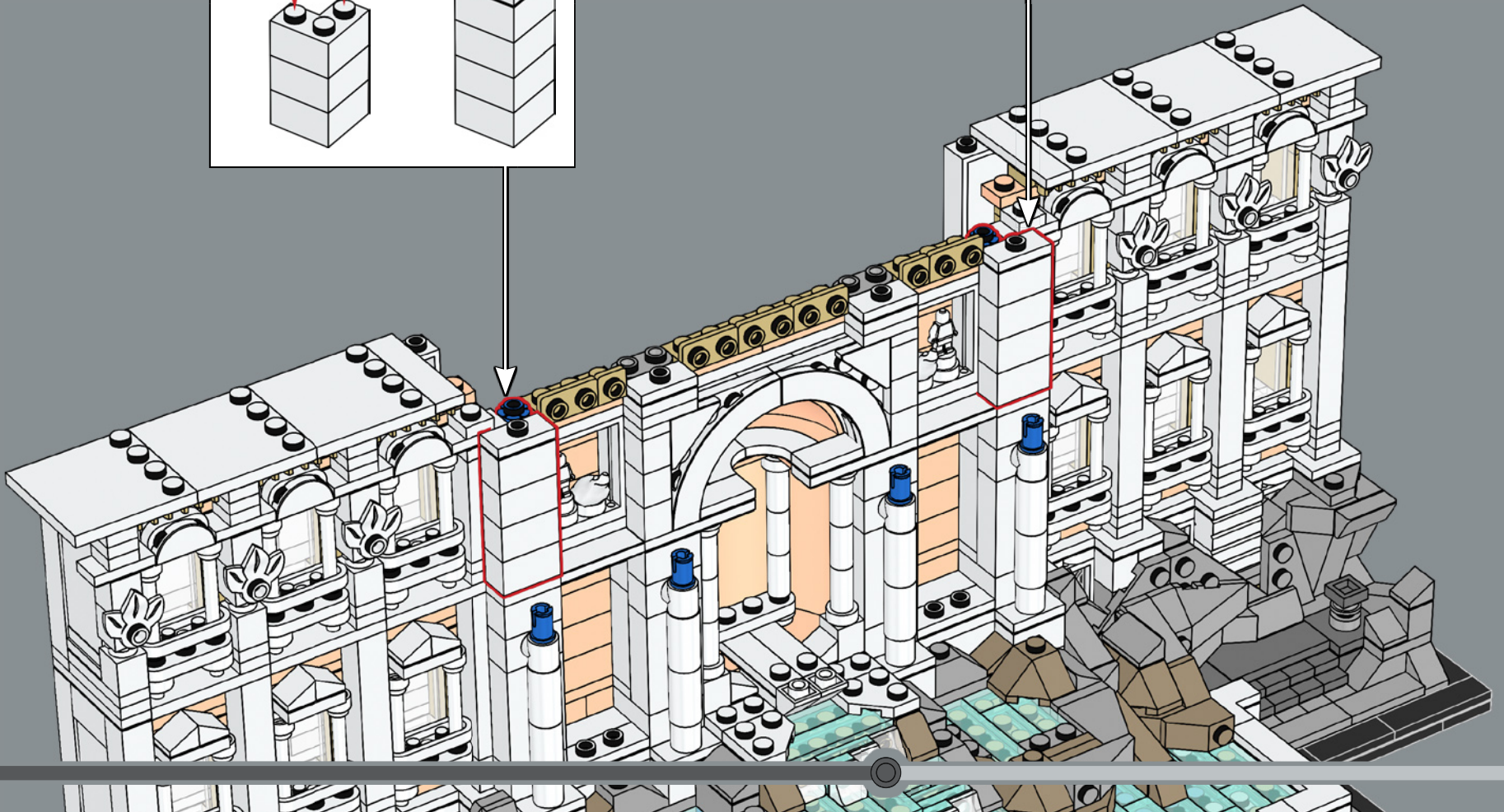
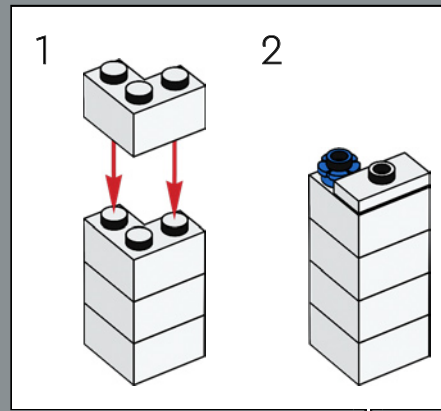
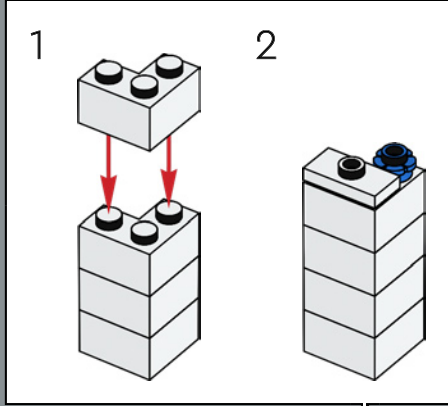



2x



277

1



3



2



4



5

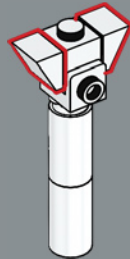

6

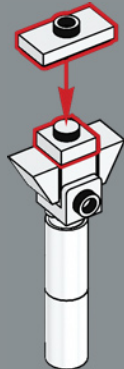

7

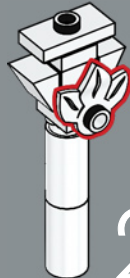

2x

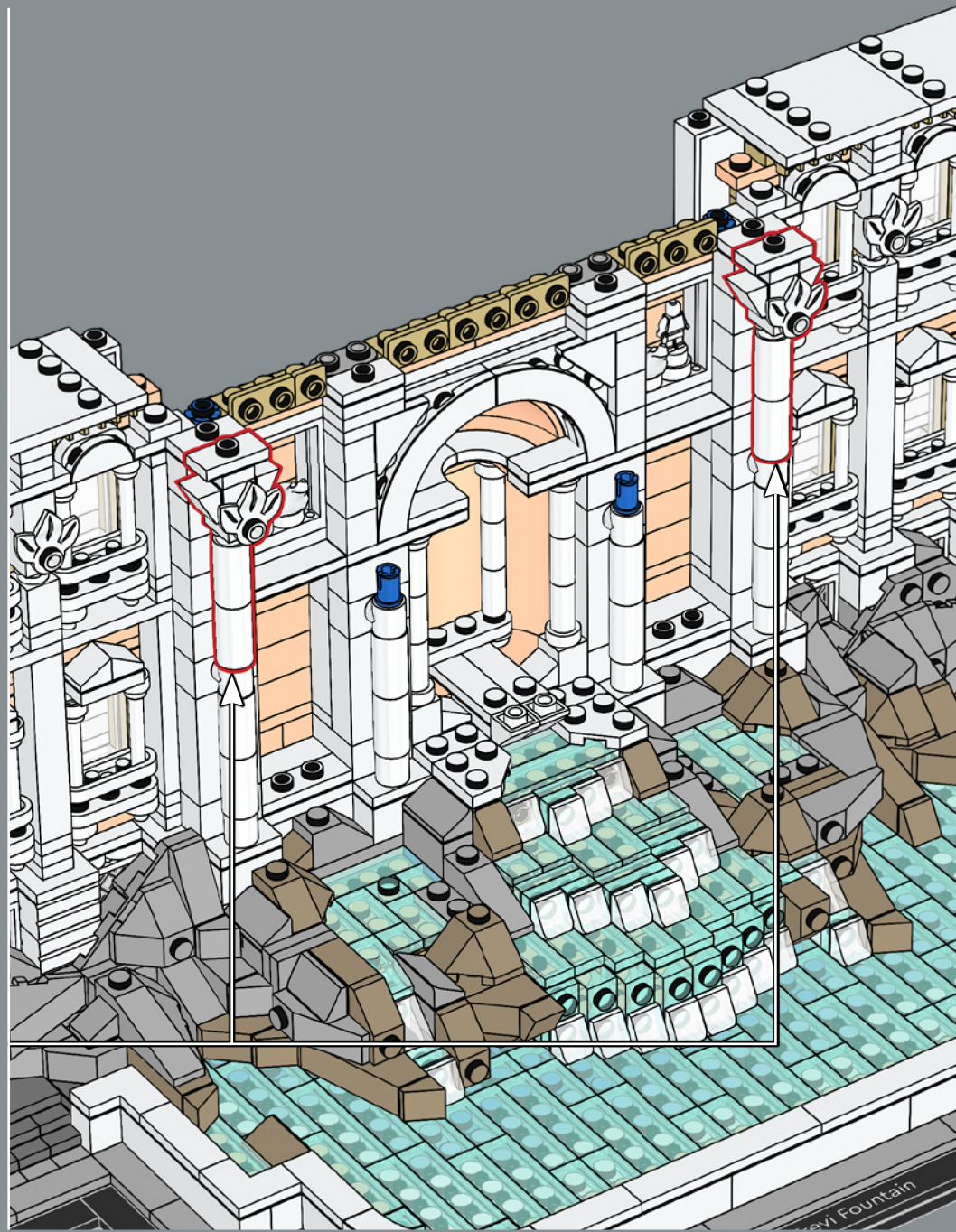

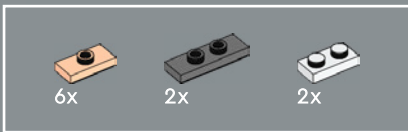

278

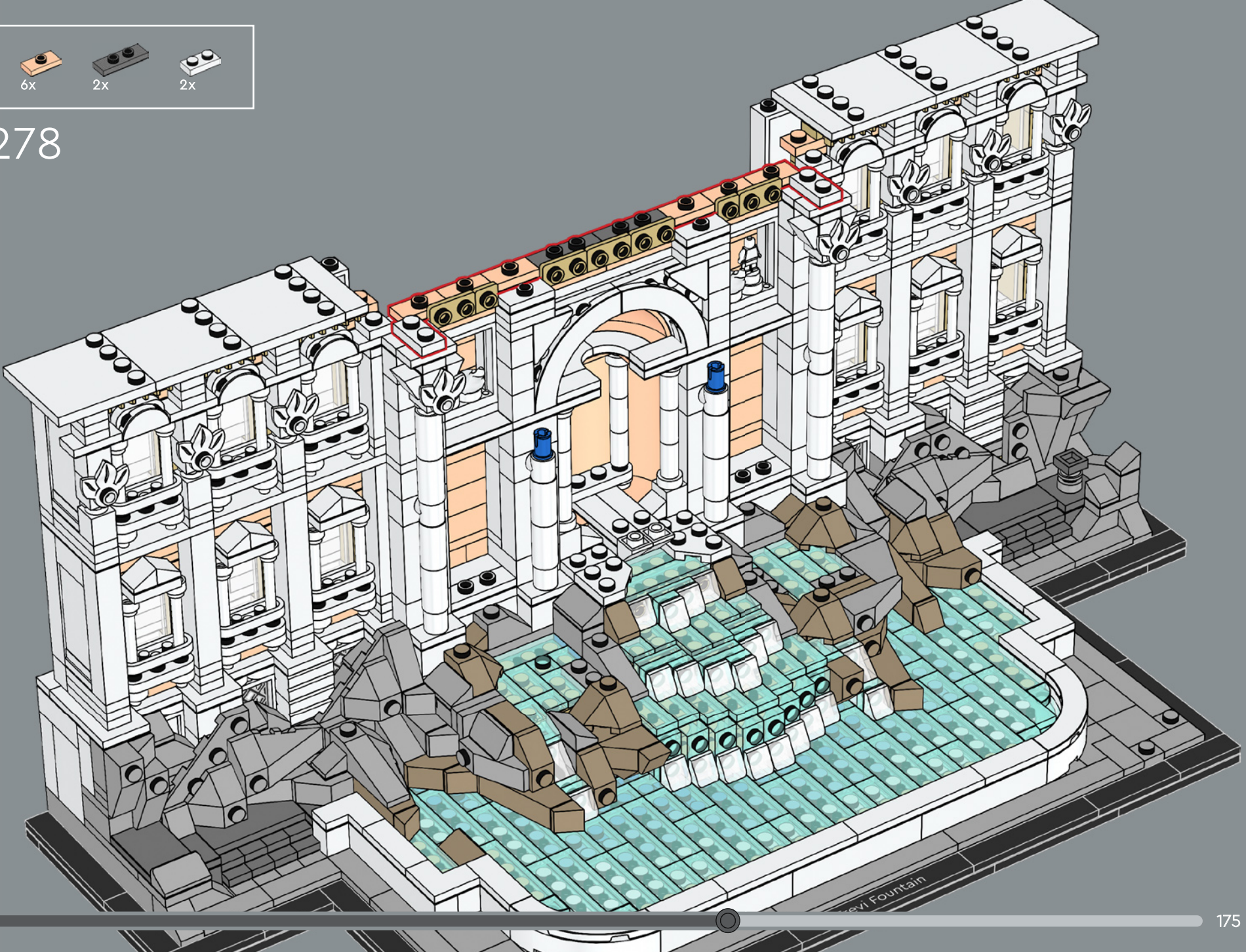

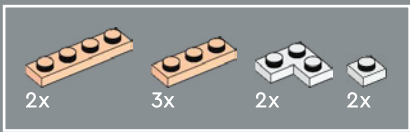

279

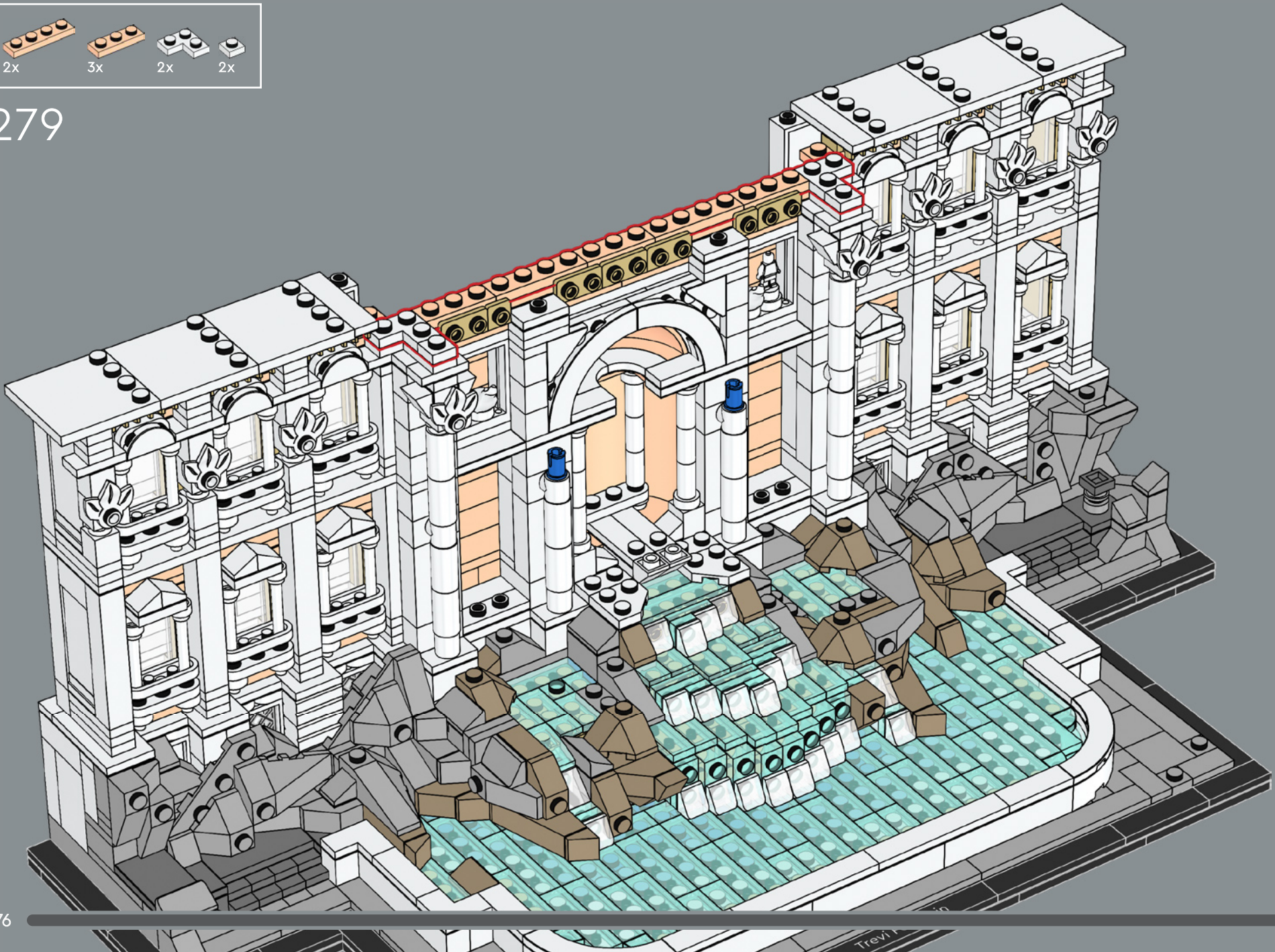



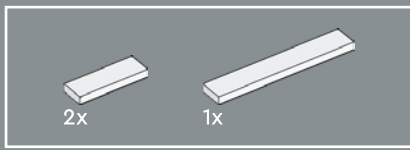

280

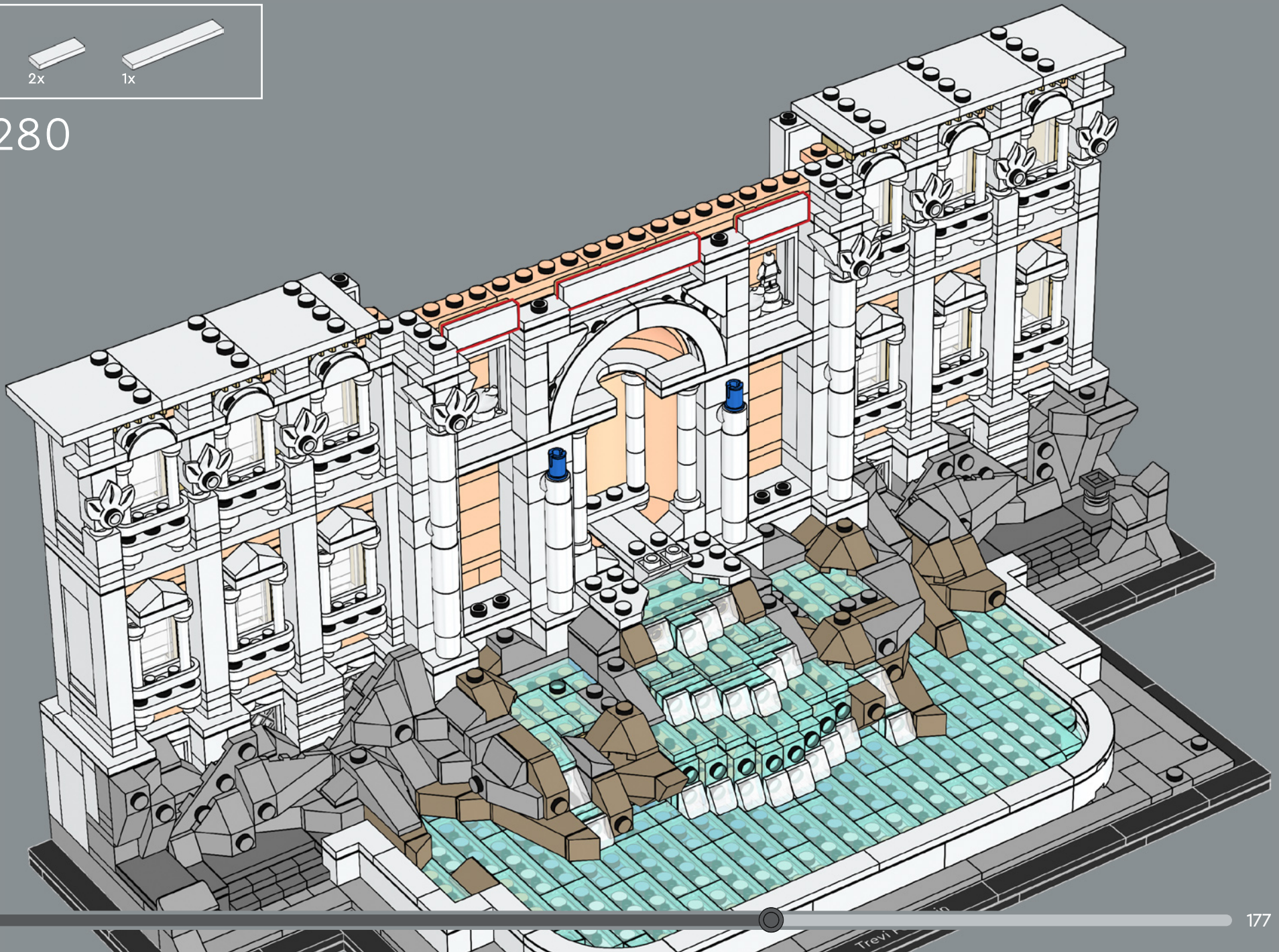



2x



281

1



3



2



4



5

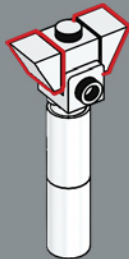

6

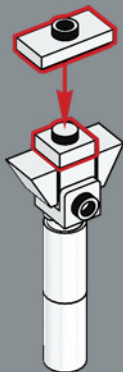

7

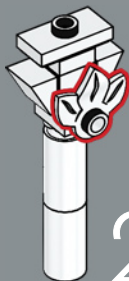

2x

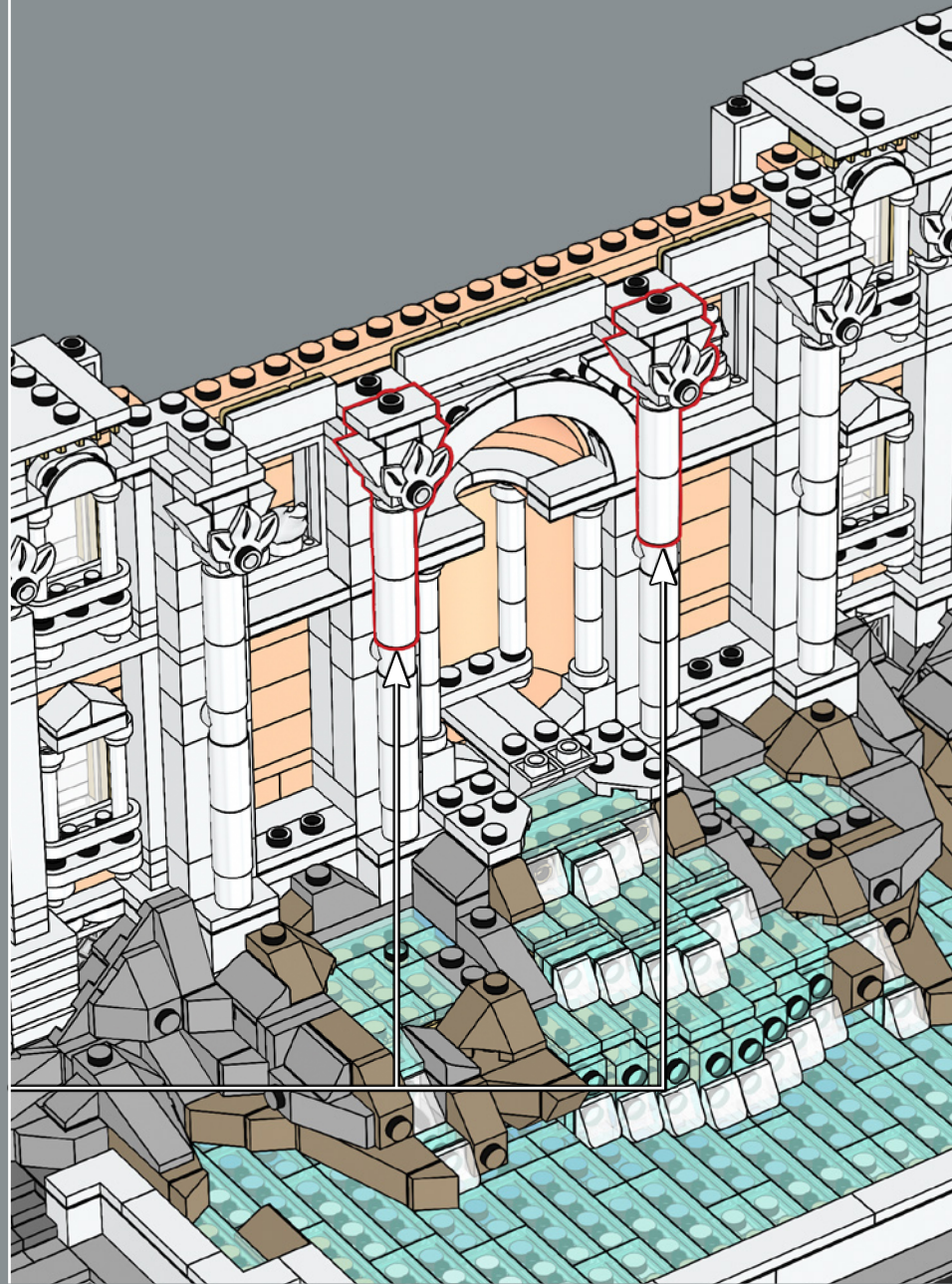

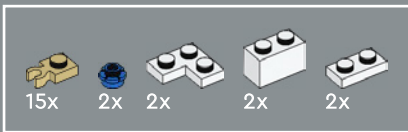

282

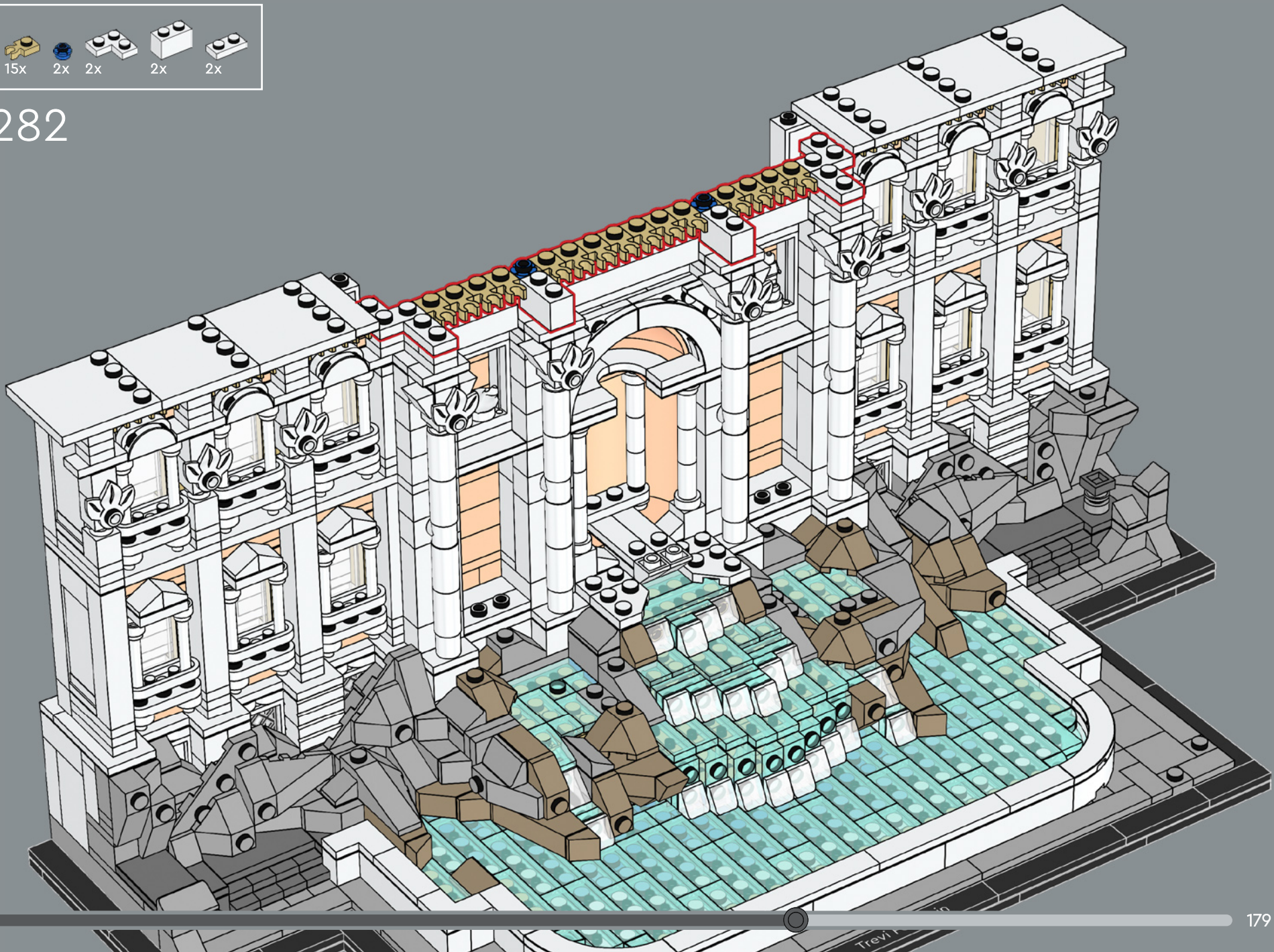

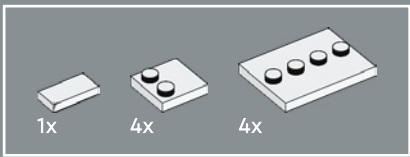

283

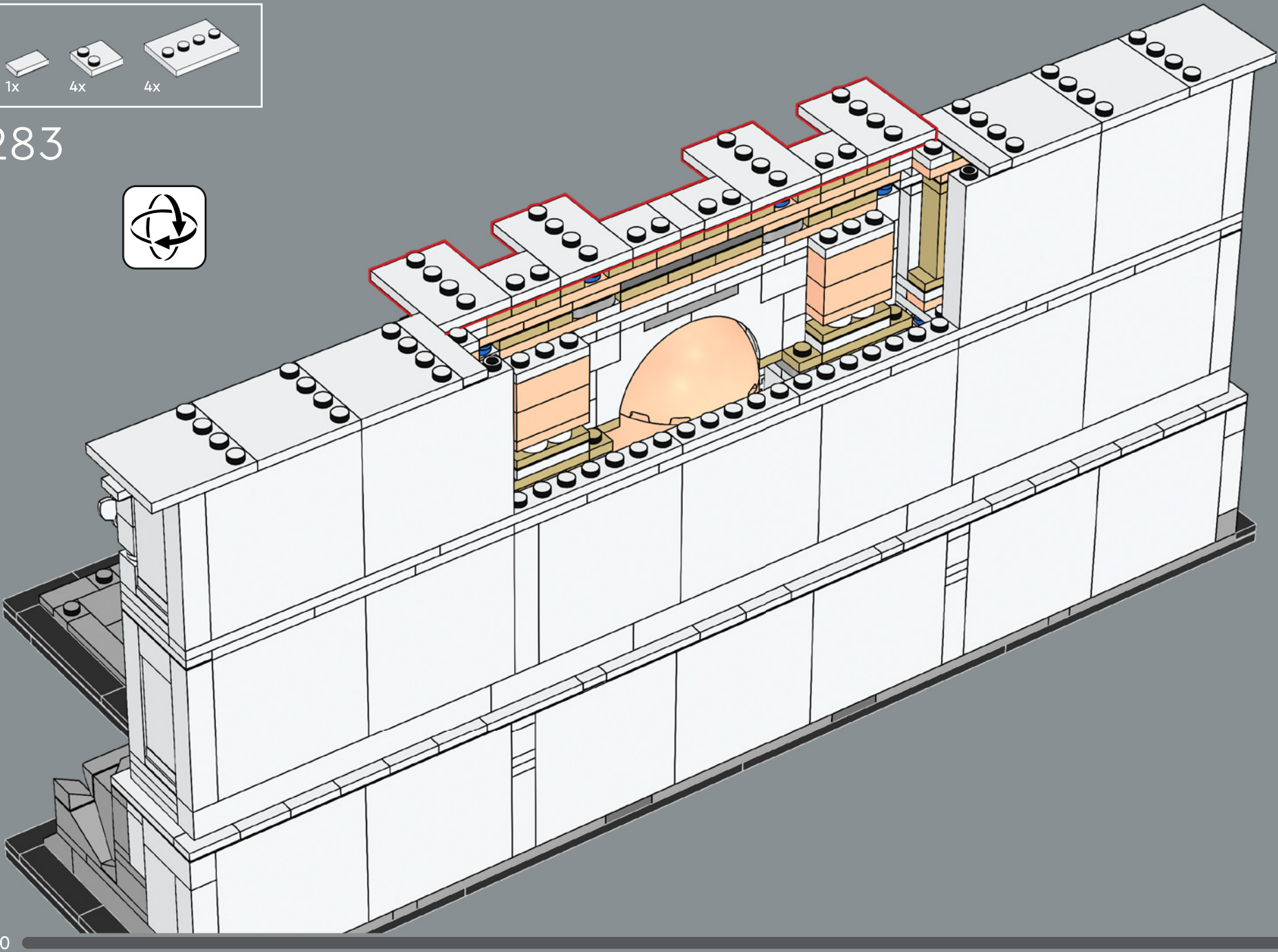

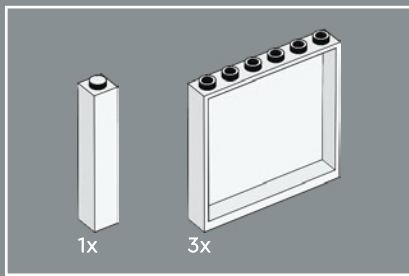

284

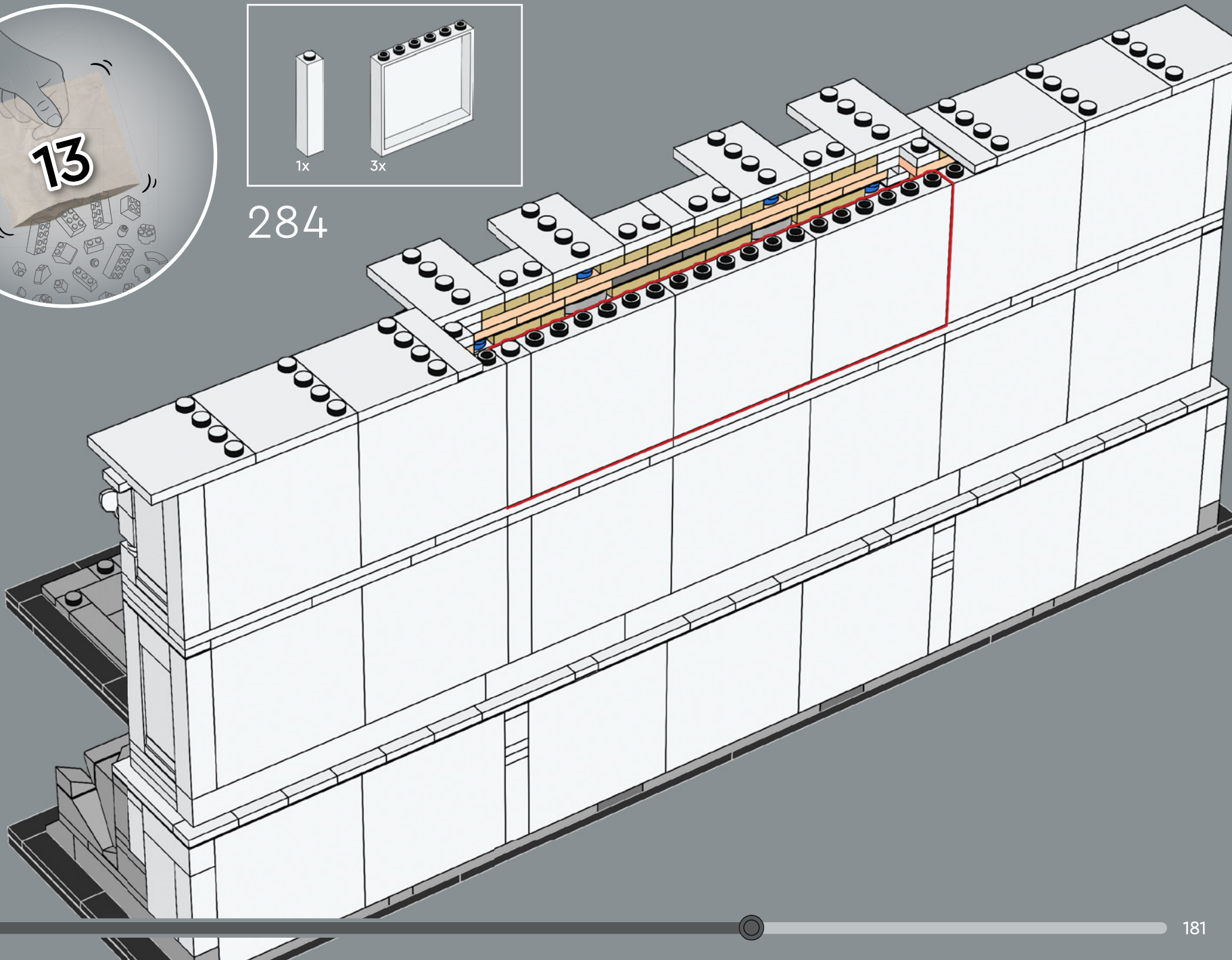

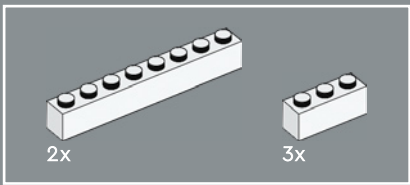

Nella vita reale, la Fontana di Trevi è la facciata di Palazzo Poli, ex residenza papale che ora ospita un museo. L'edificio prosegue all'indietro con un'architettura più abbinata agli edifici circostanti che allo stile barocco della fontana.

285

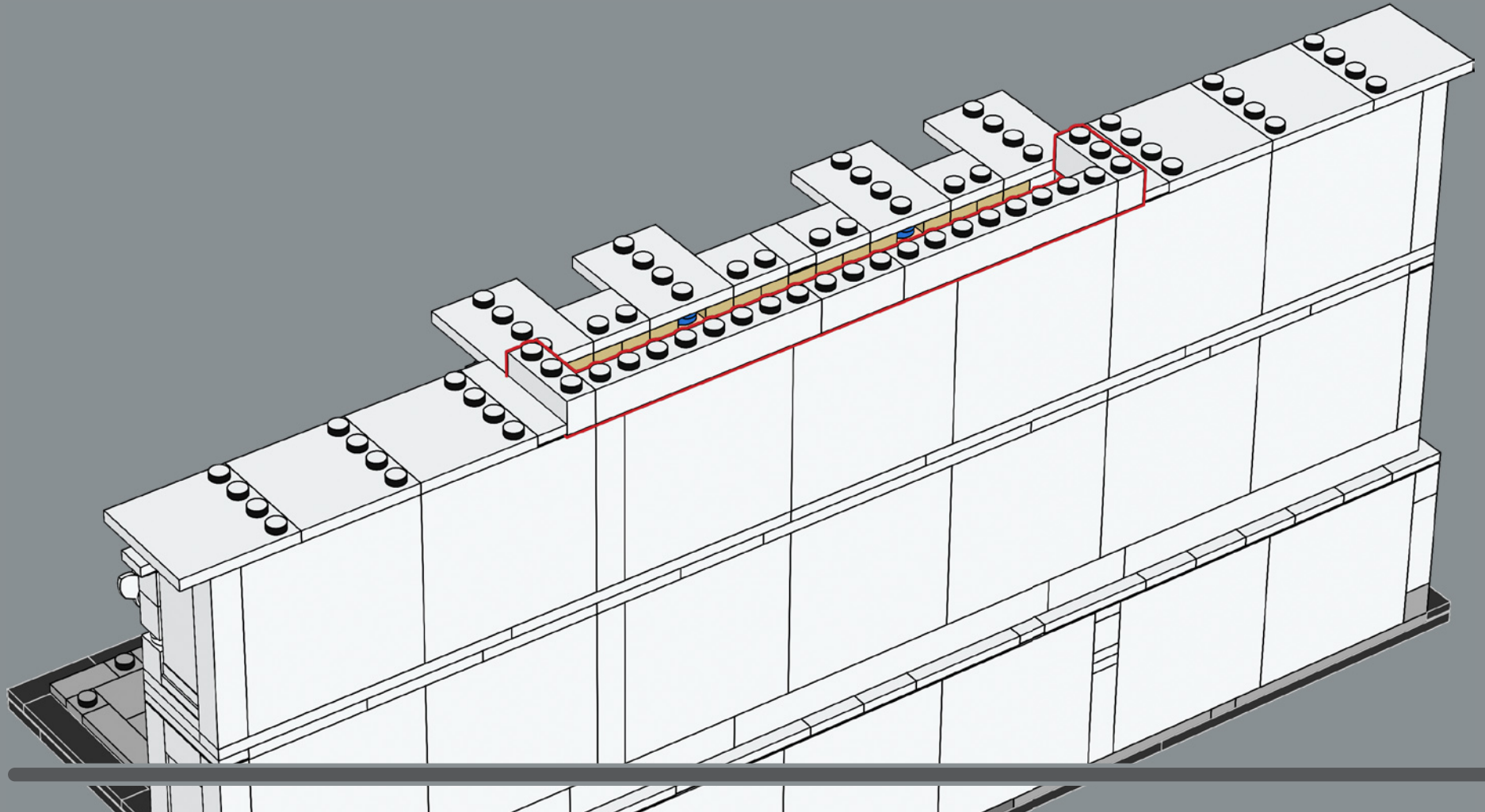

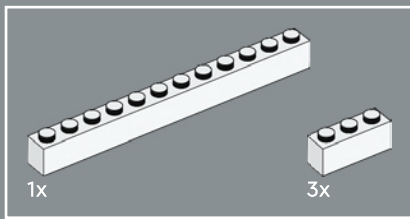

286

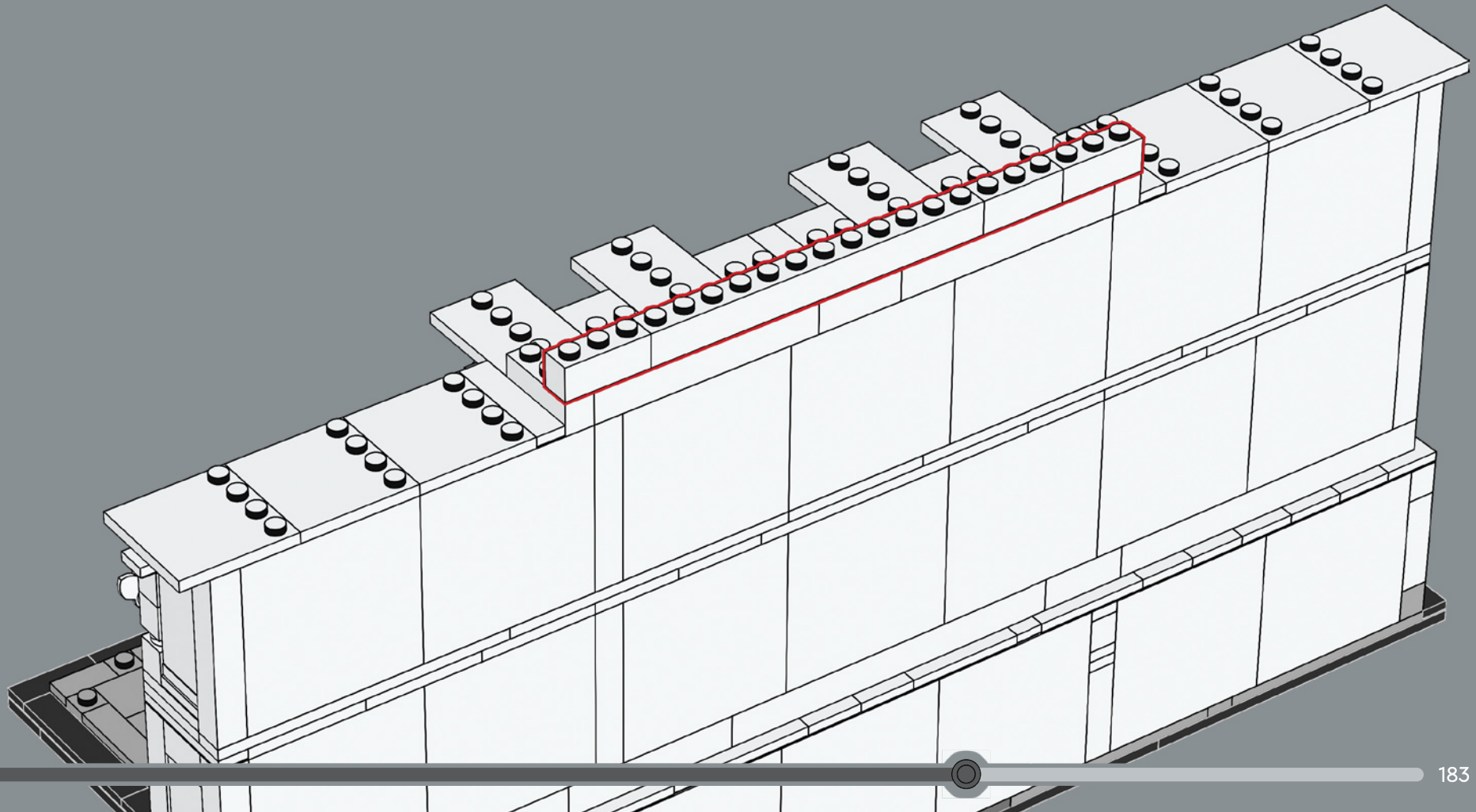

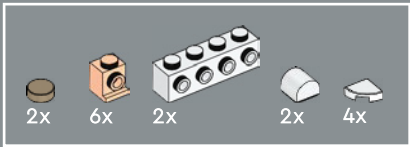

287

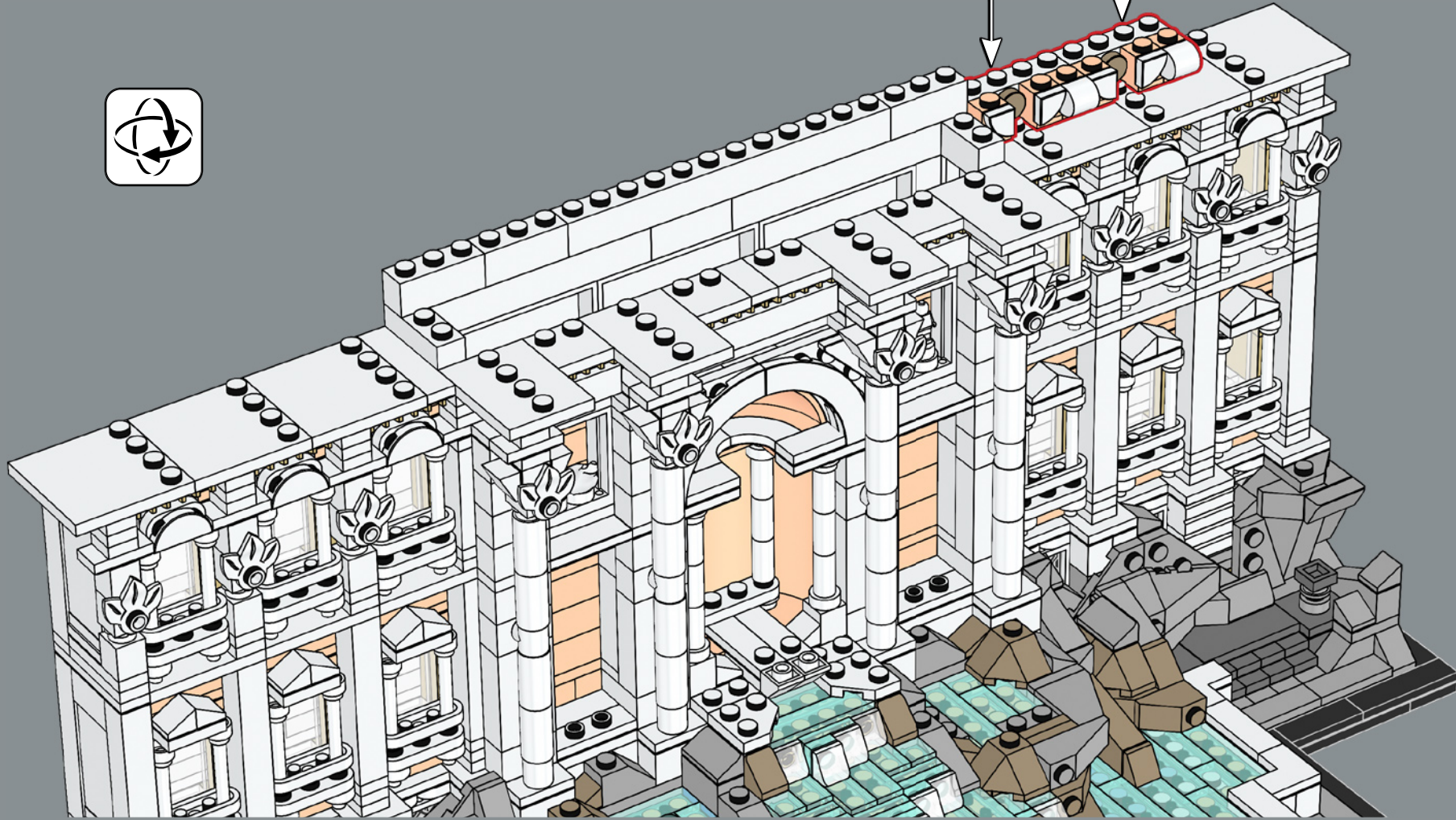
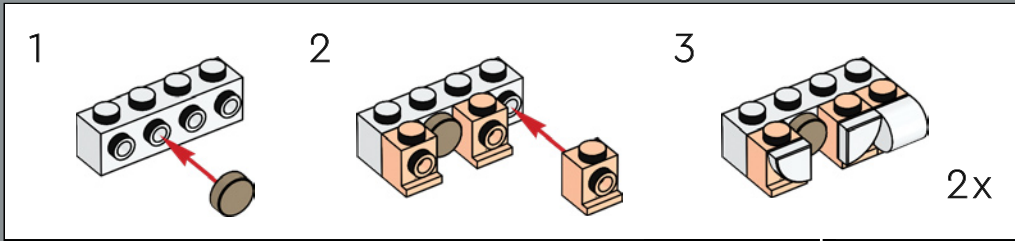



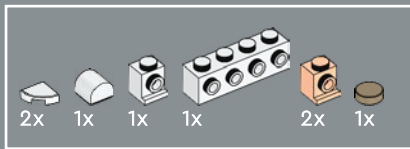

288

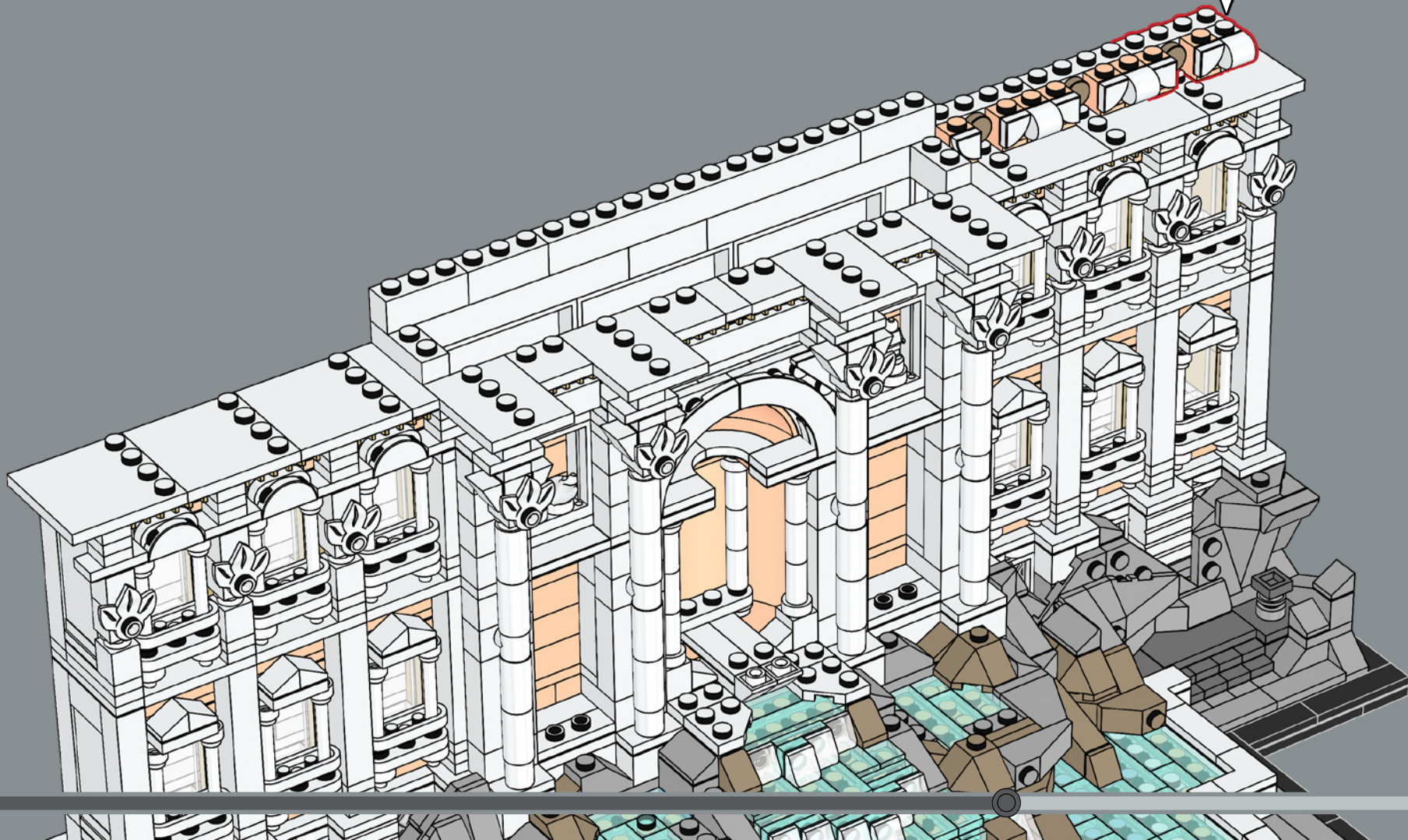
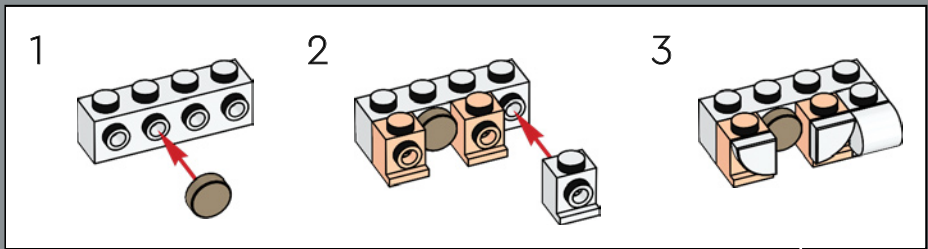

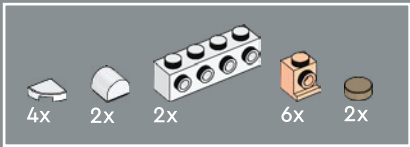

289

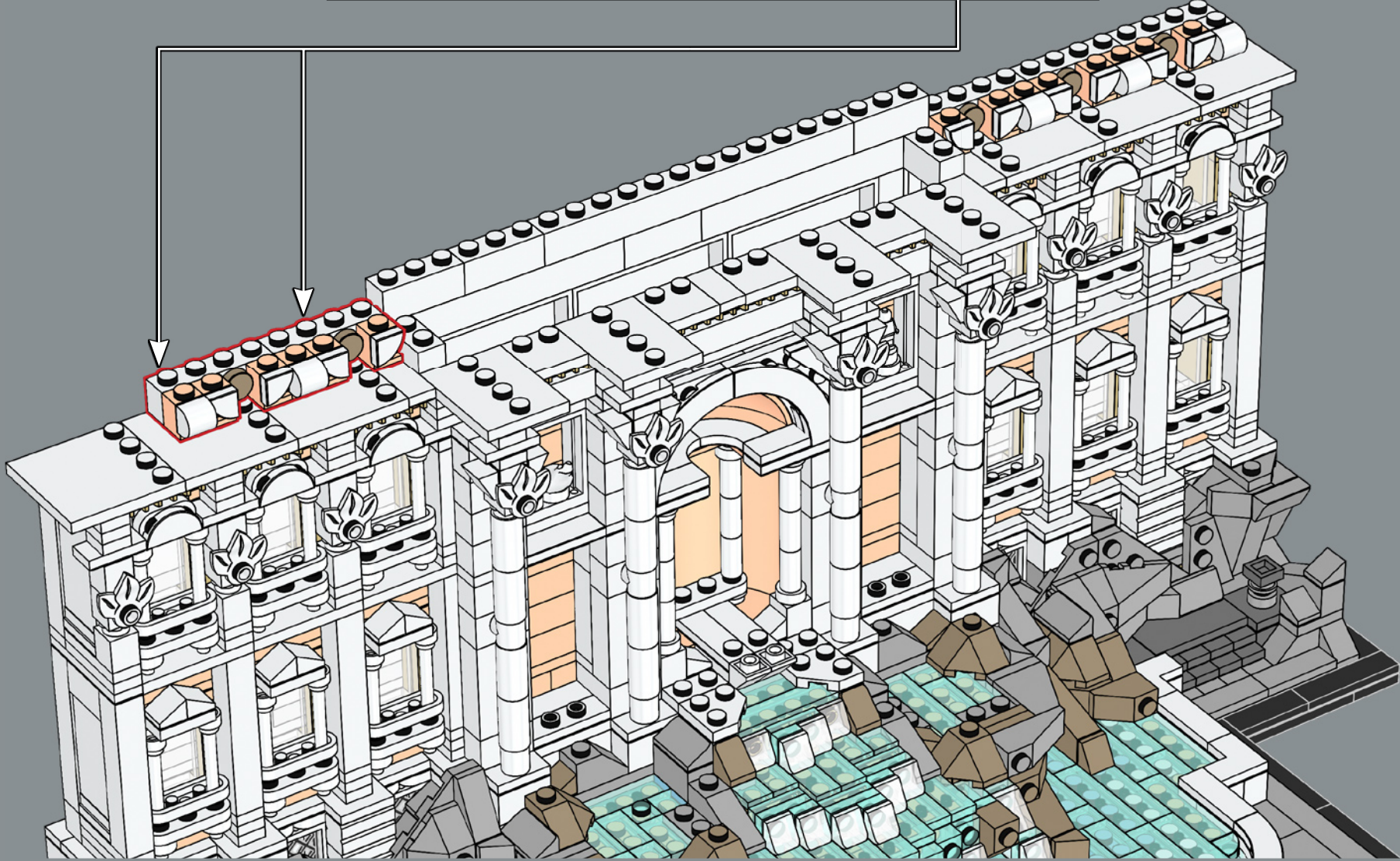
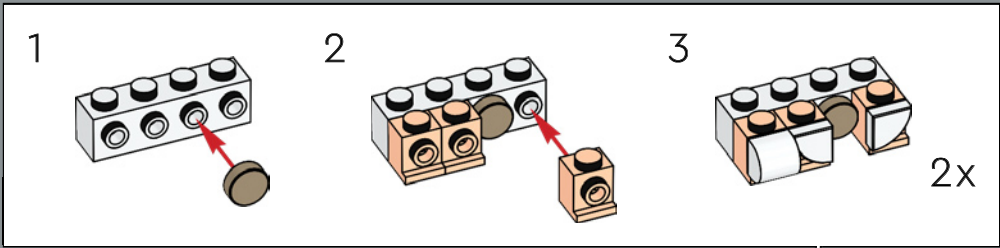

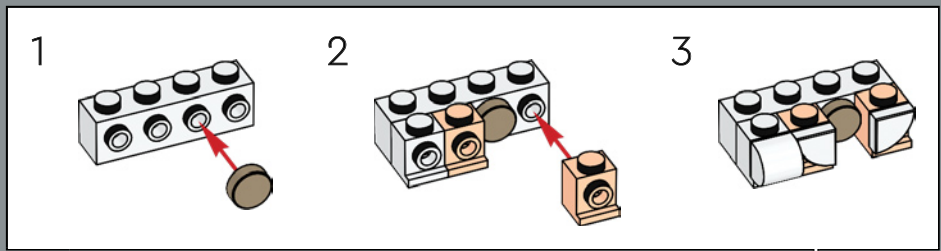
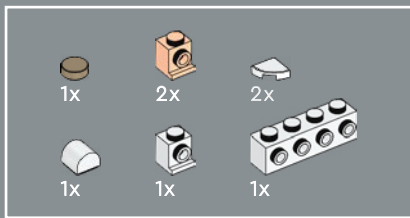

290

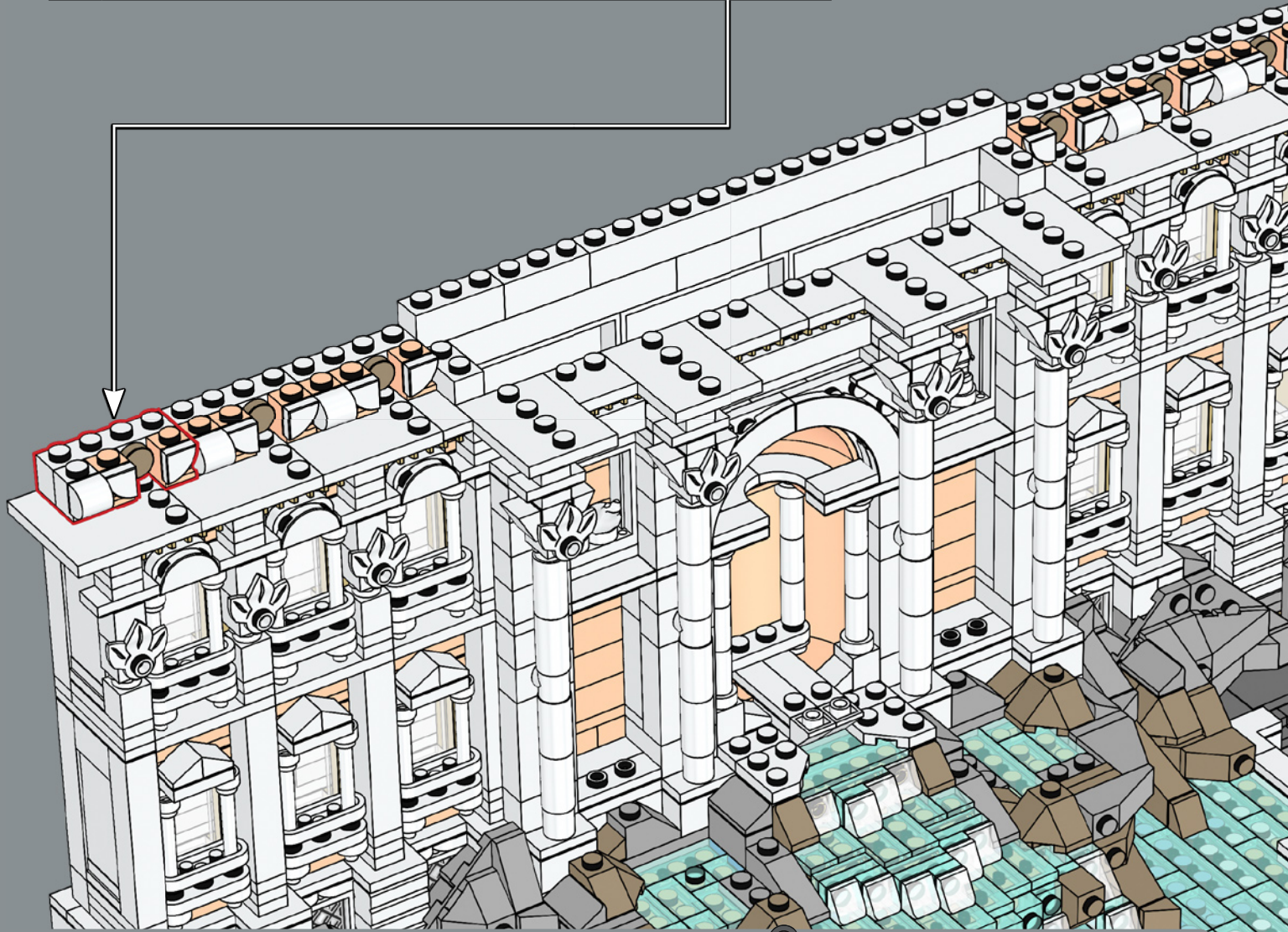



6x

291

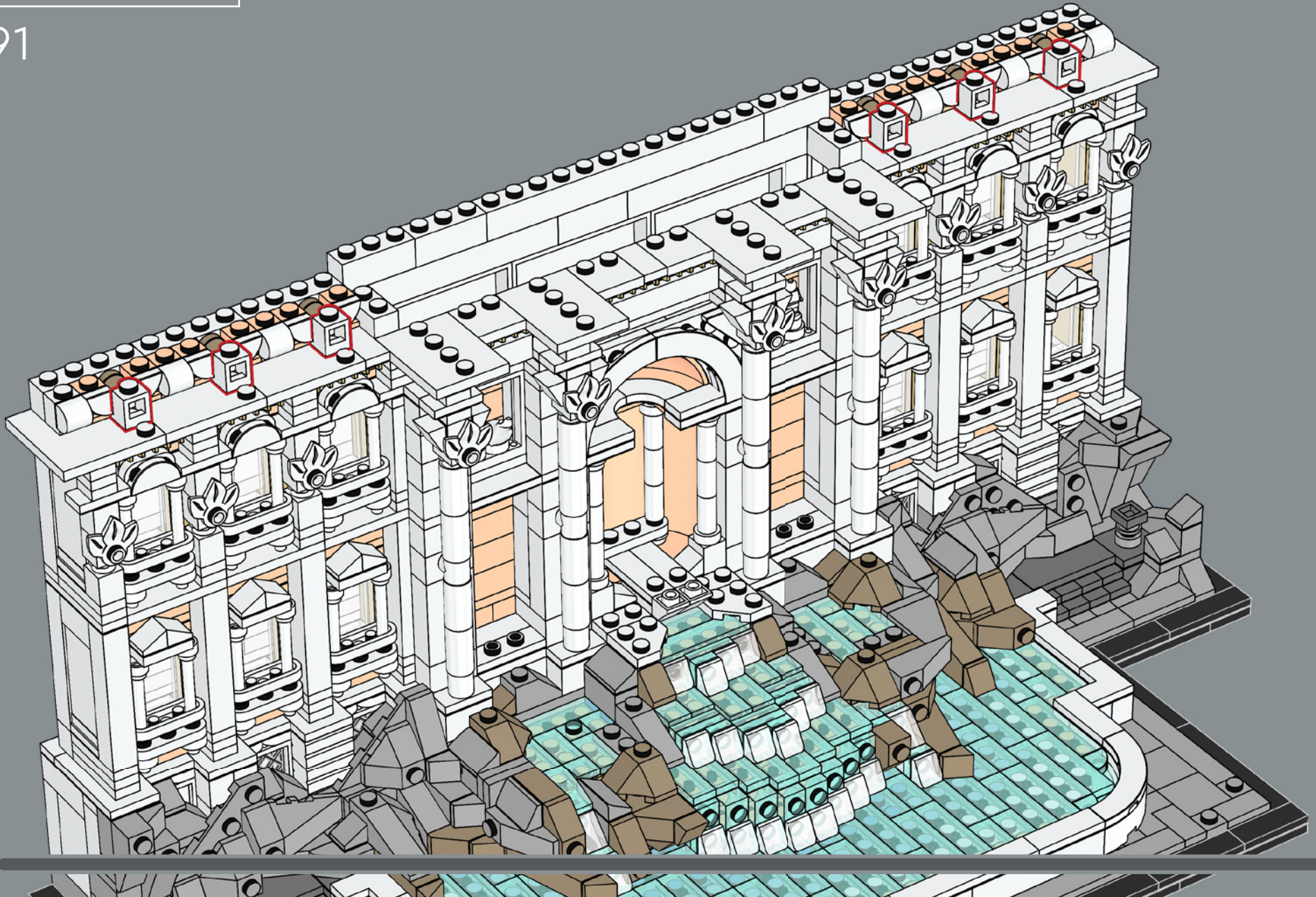

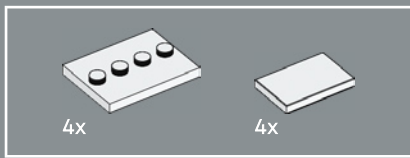

292

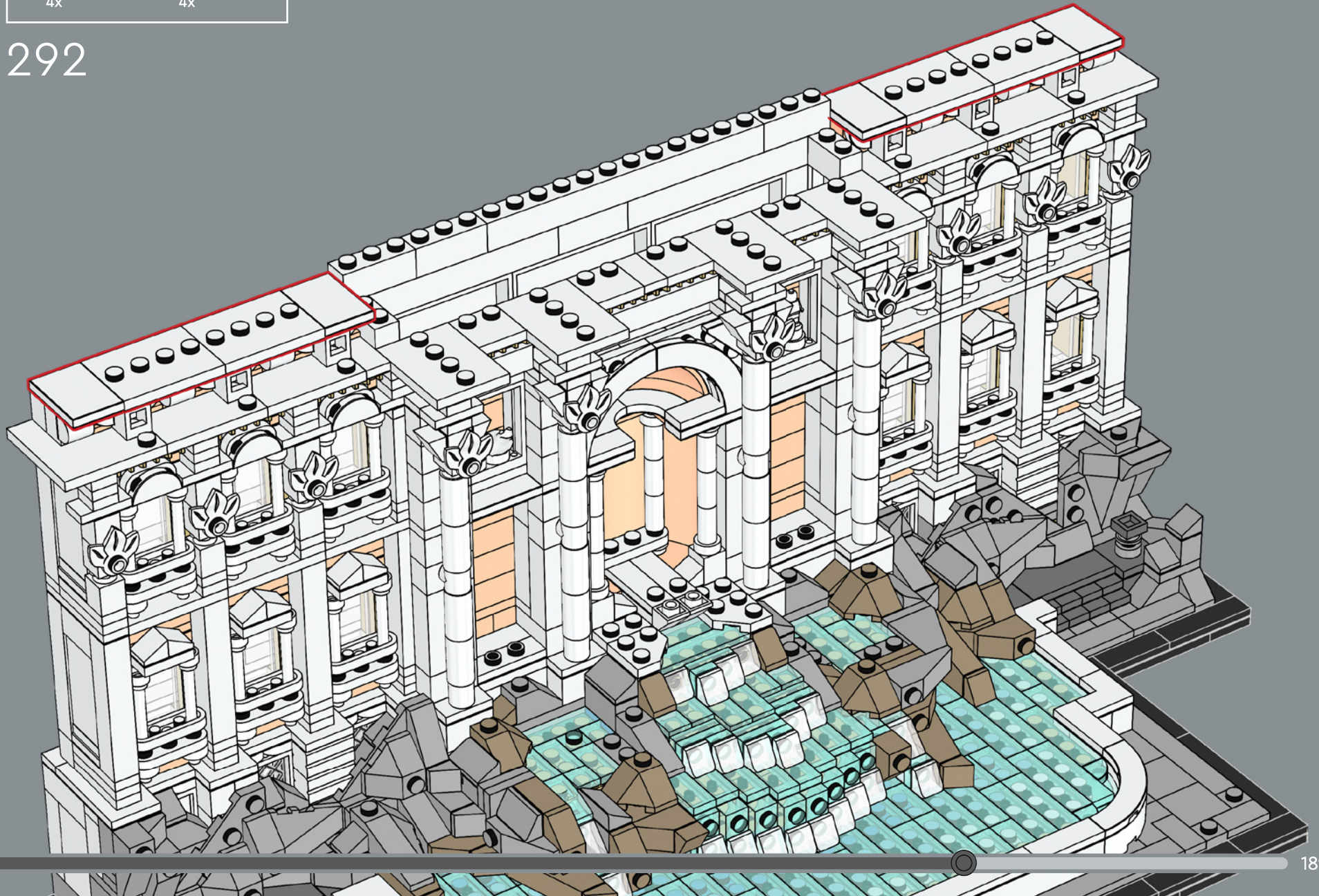

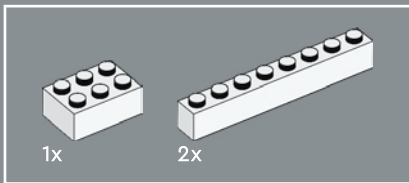

293

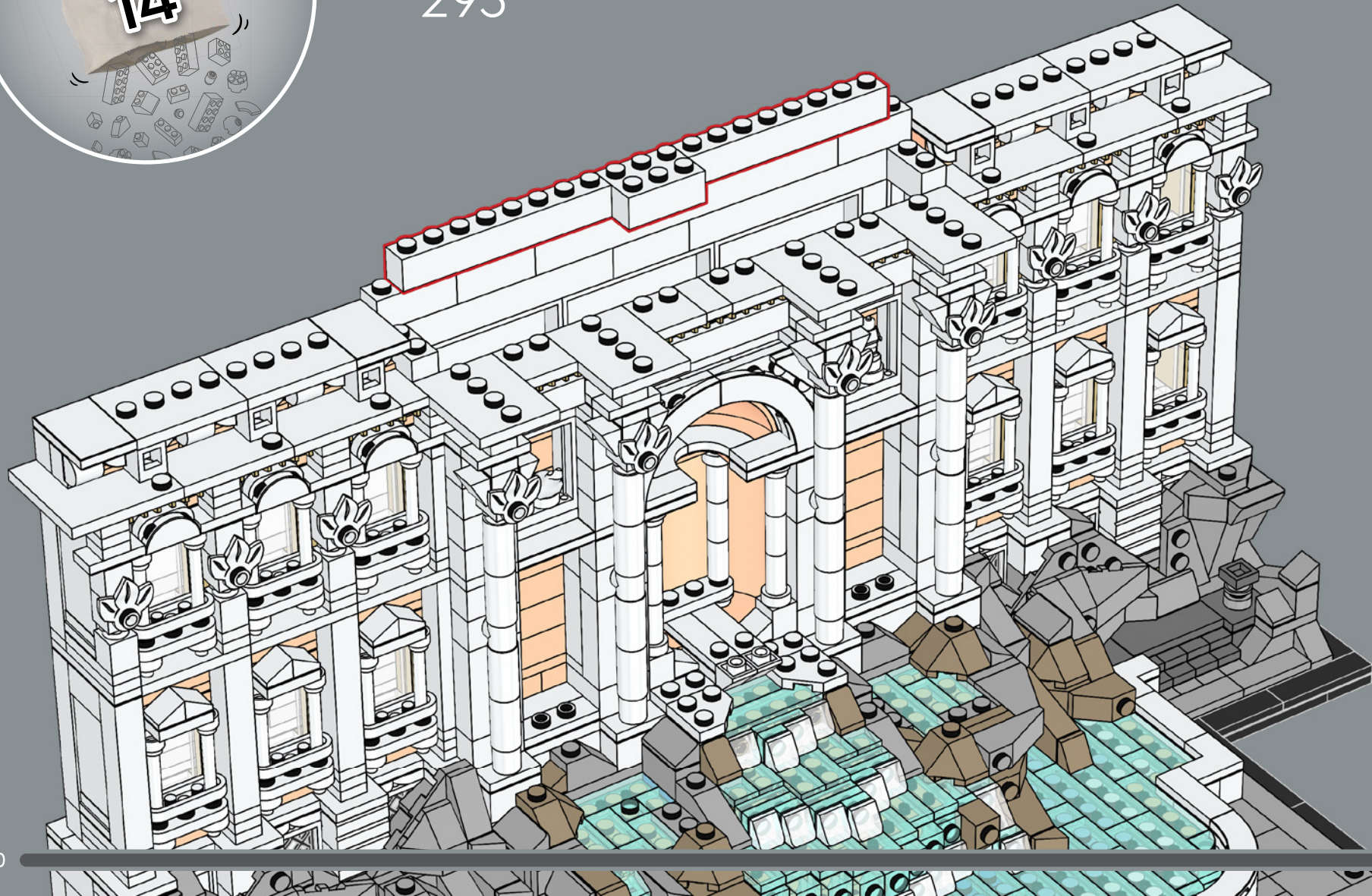

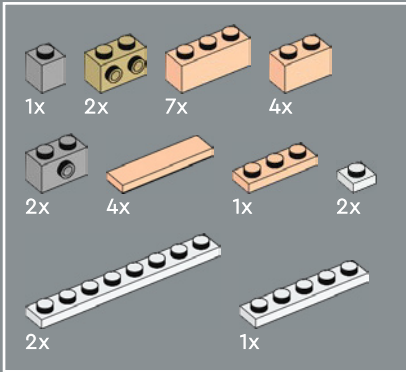
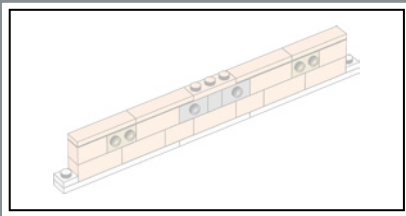

294

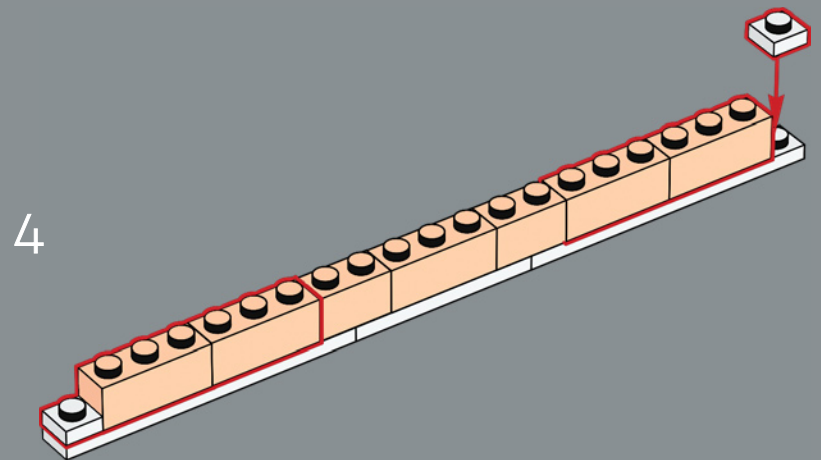
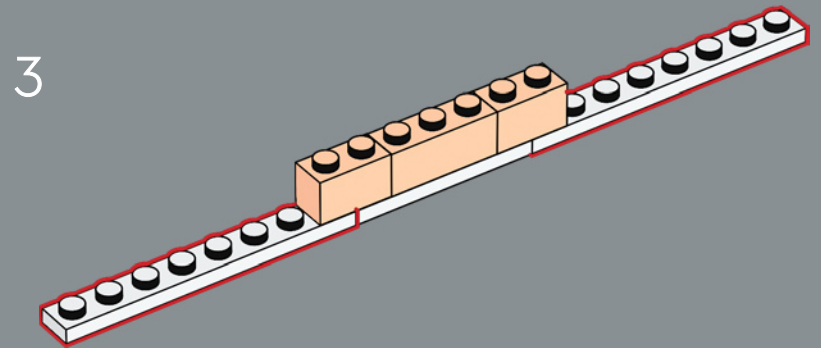
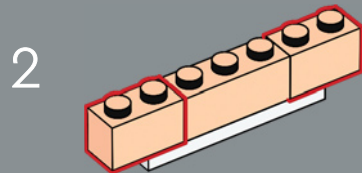
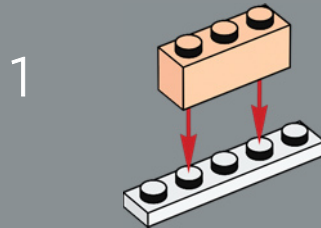

5

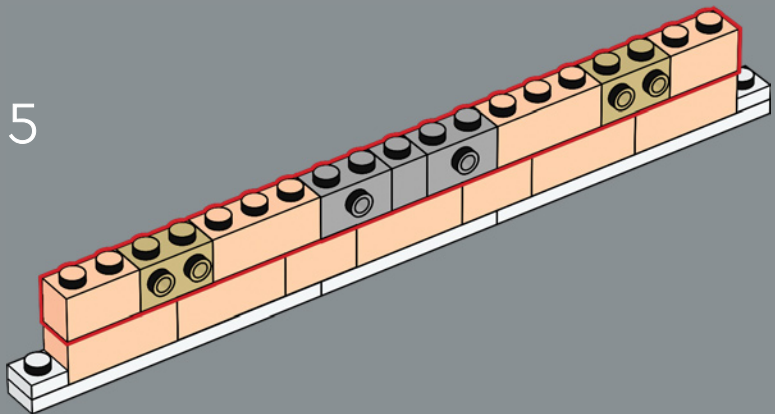

6

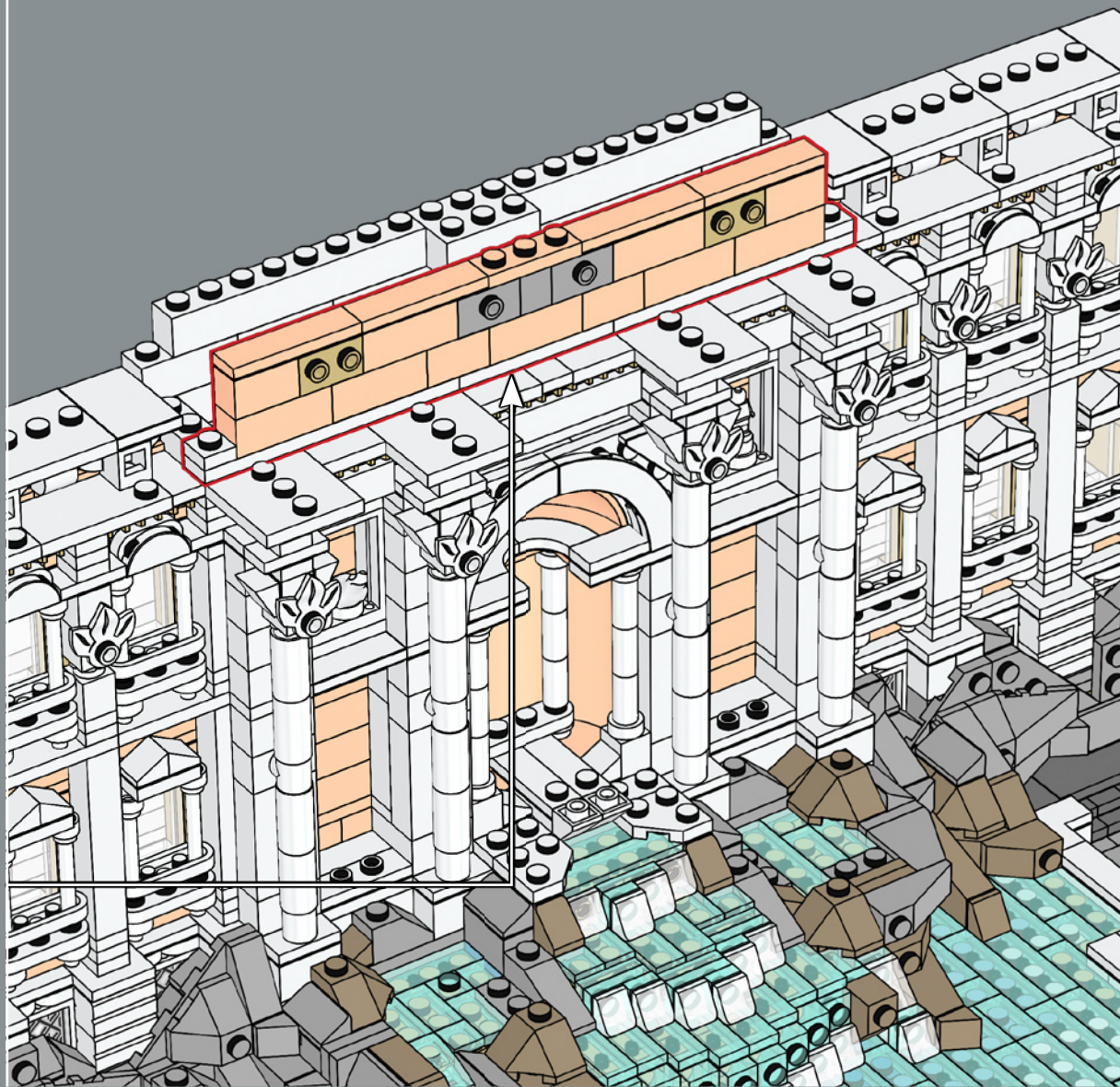
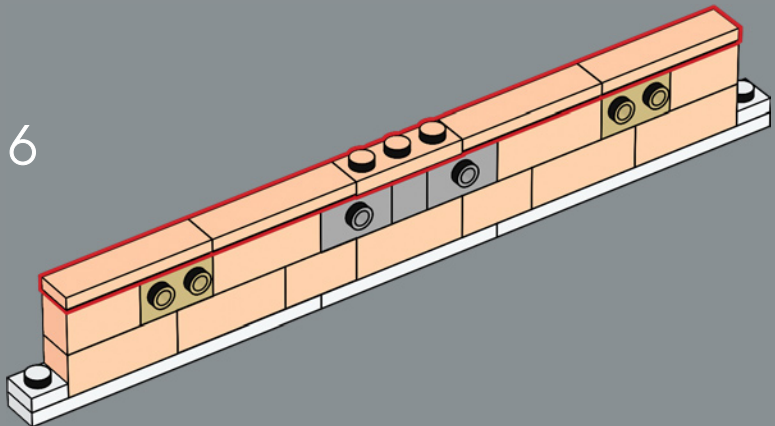



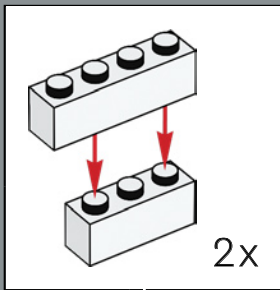
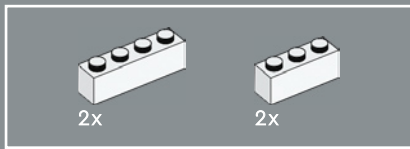

295

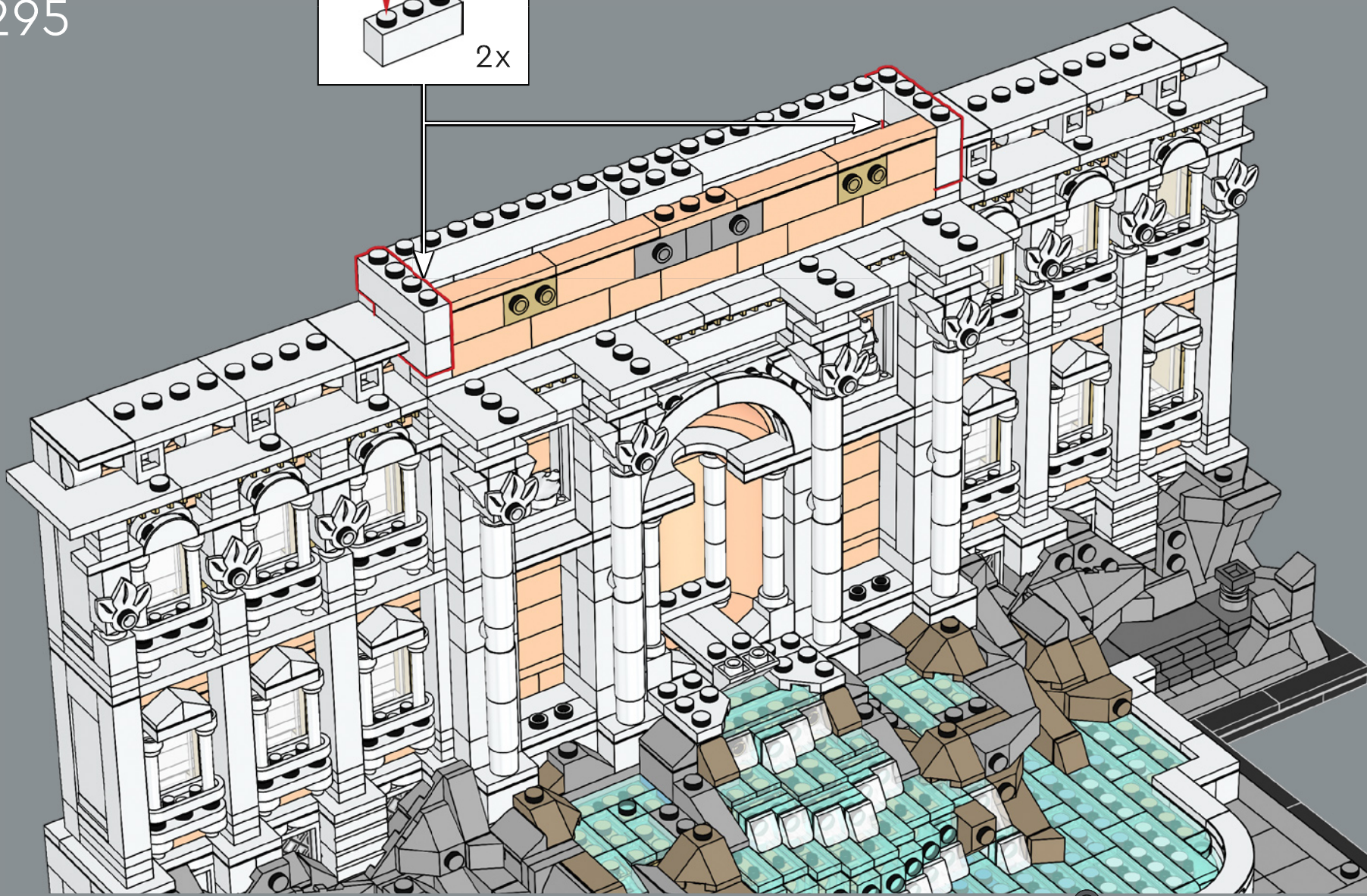

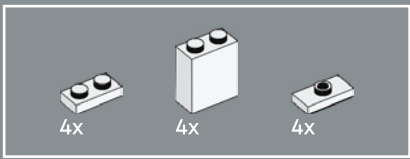

296

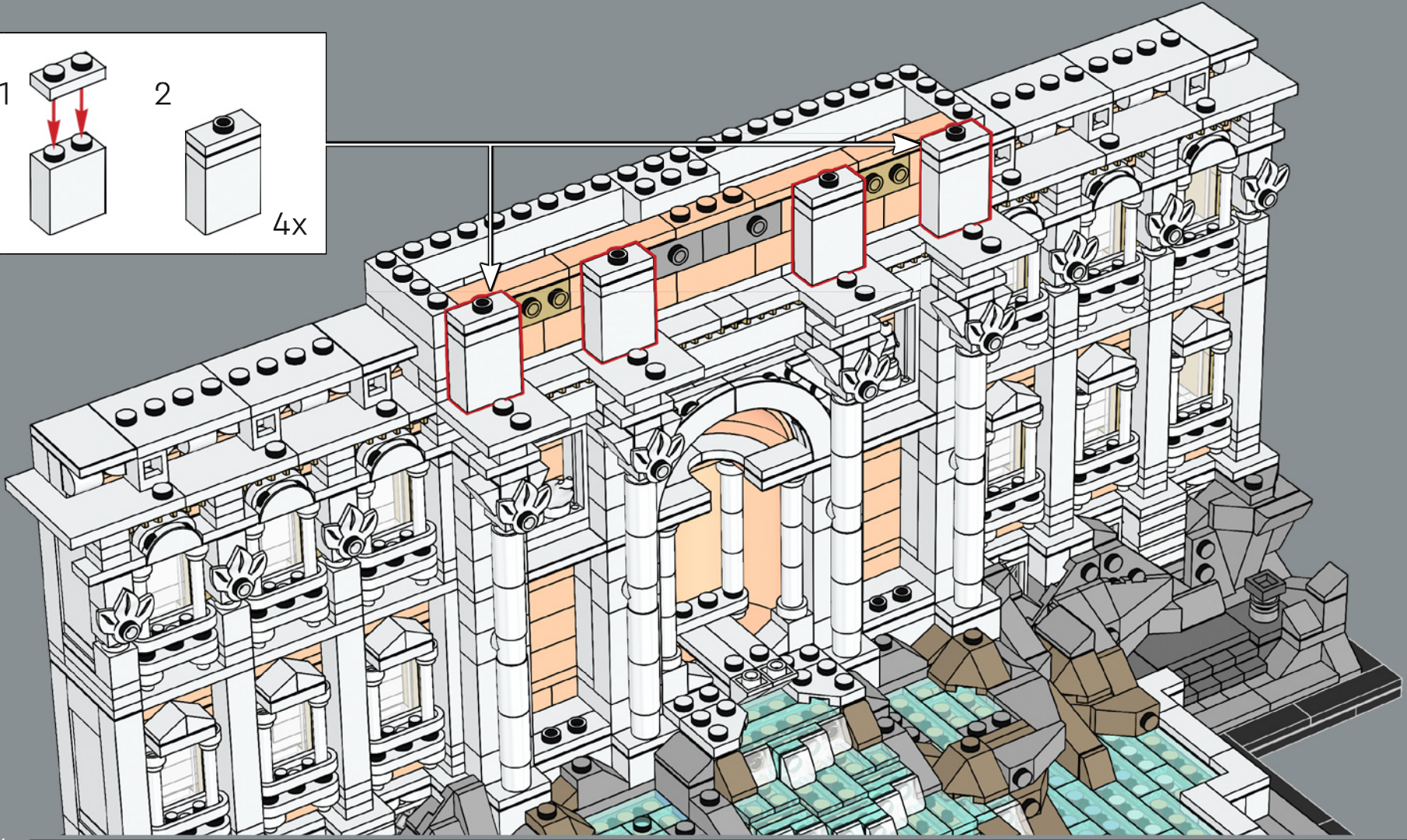
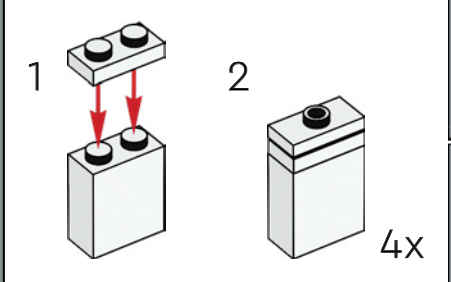

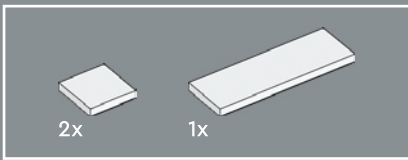

297

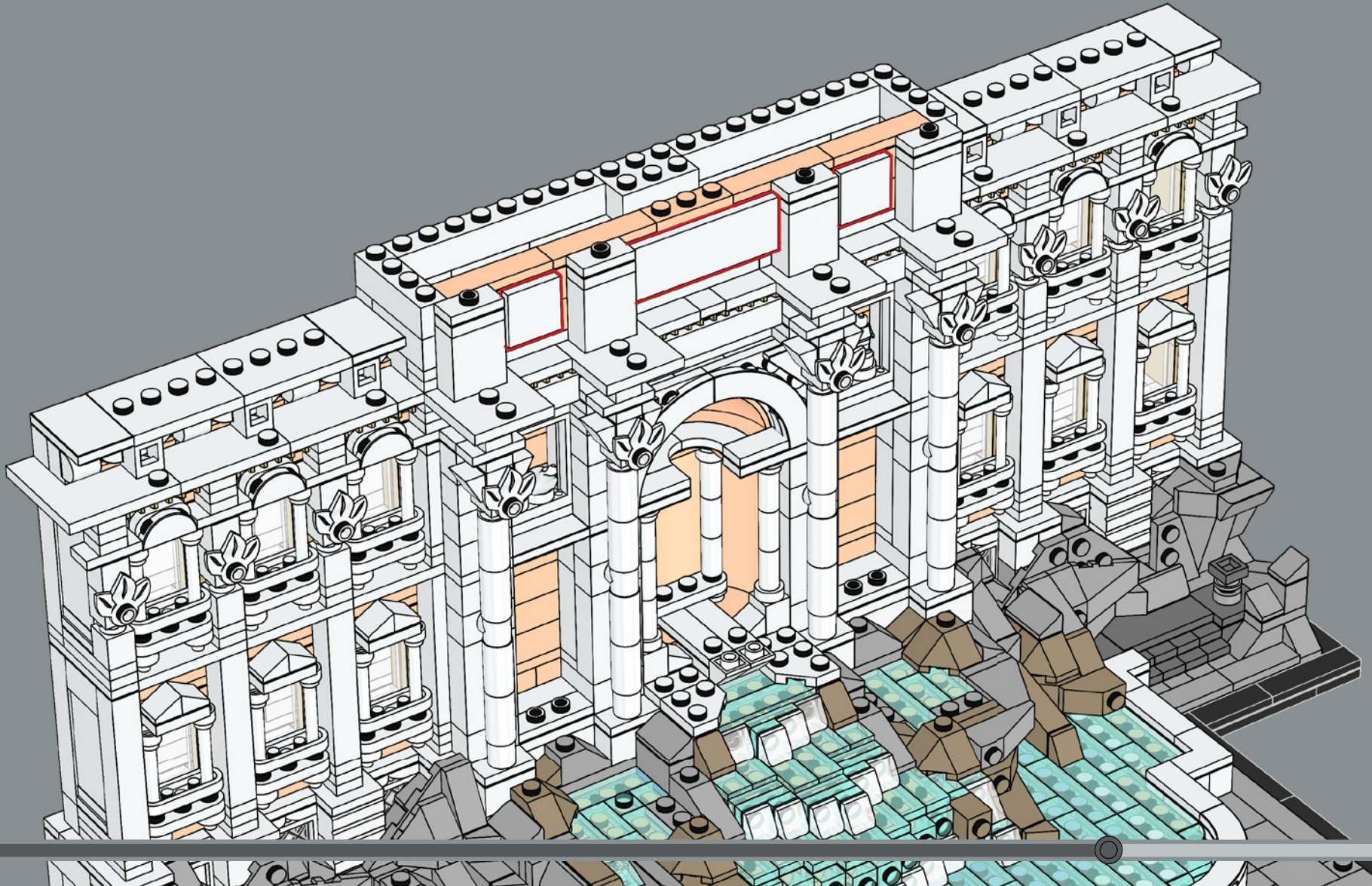

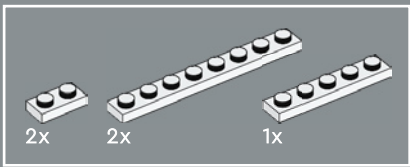

298

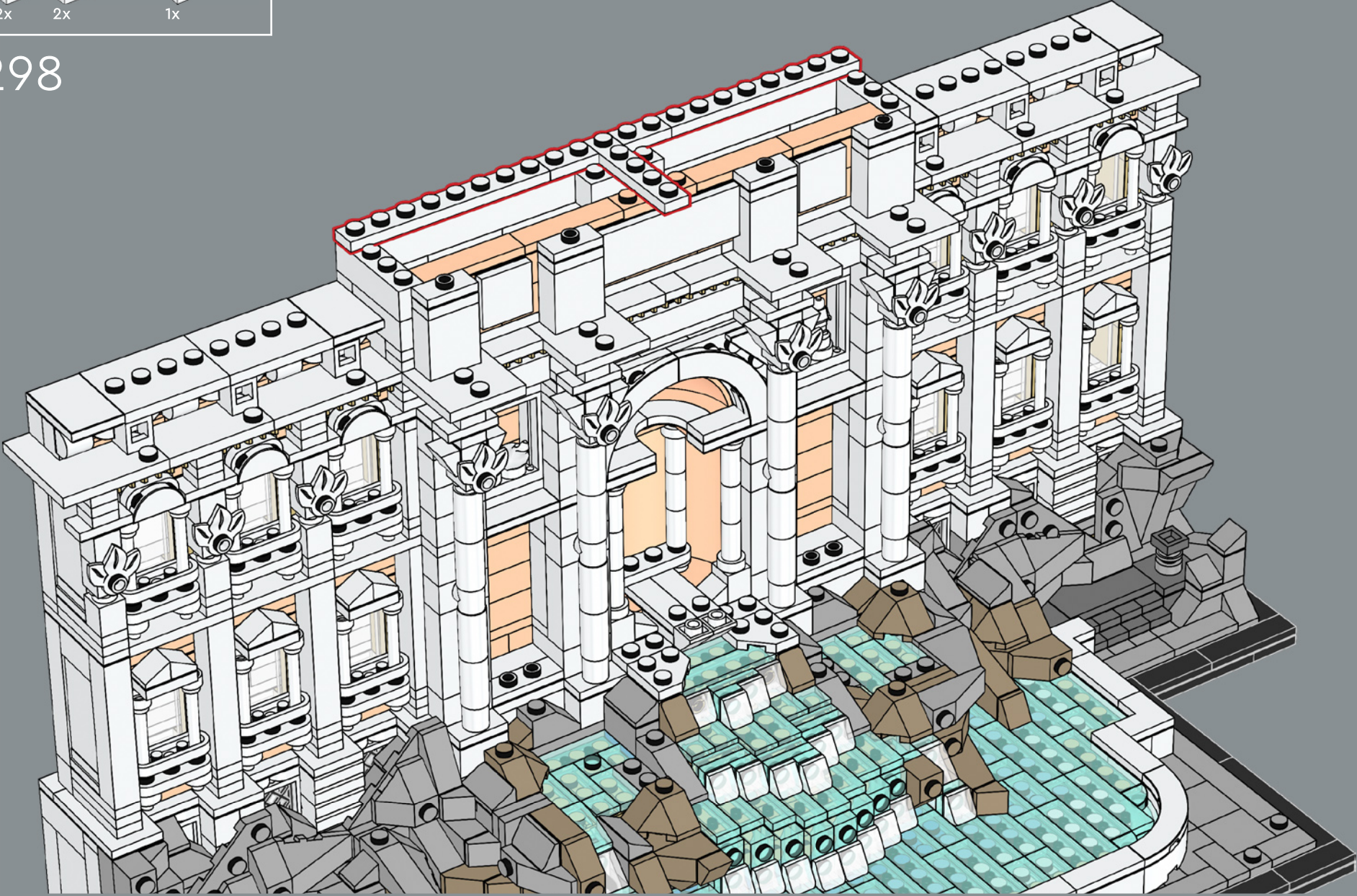

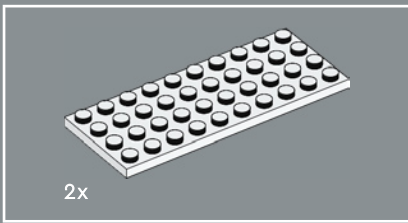

299

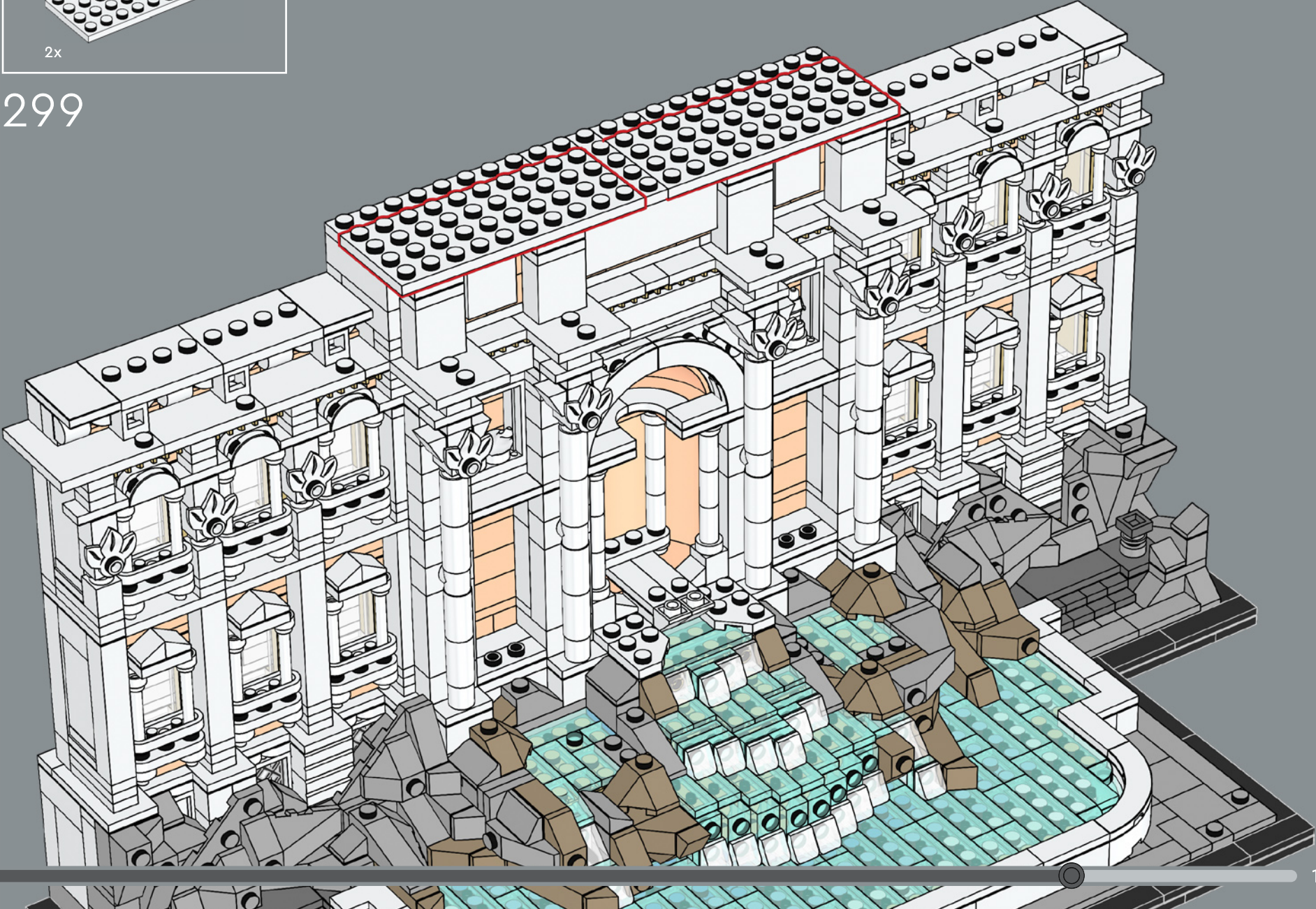

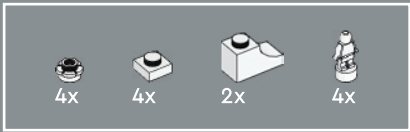

Queste statue rappresentano le quattro stagioni:  
l'Abbondanza della frutta, la Fertilità dei campi, la  
Ricchezza dell'autunno e l'Amenità dei giardini.

300

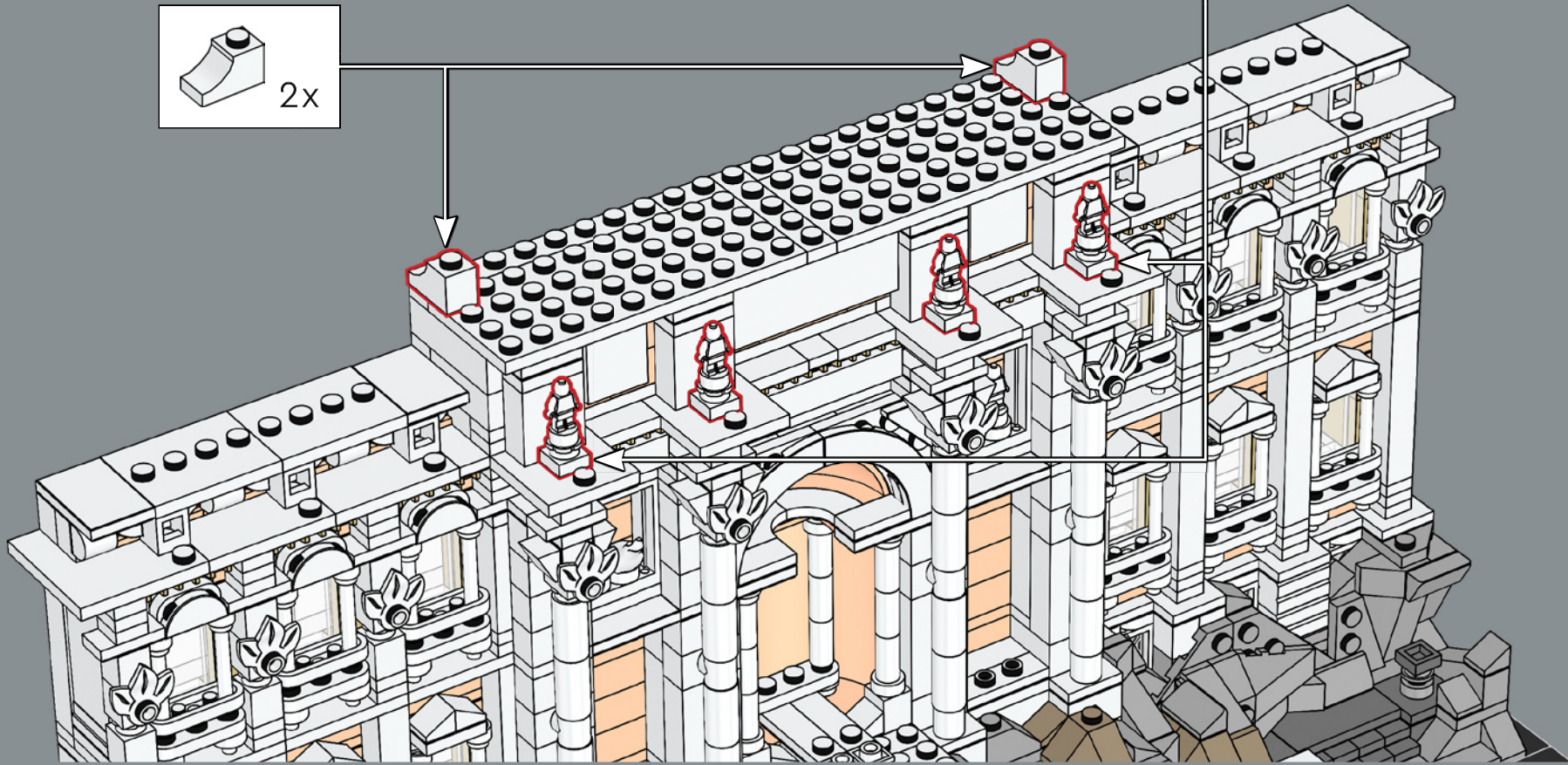
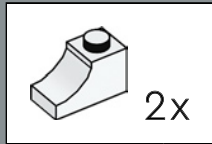
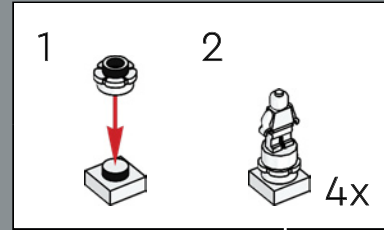

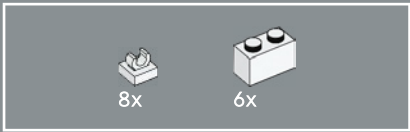

301

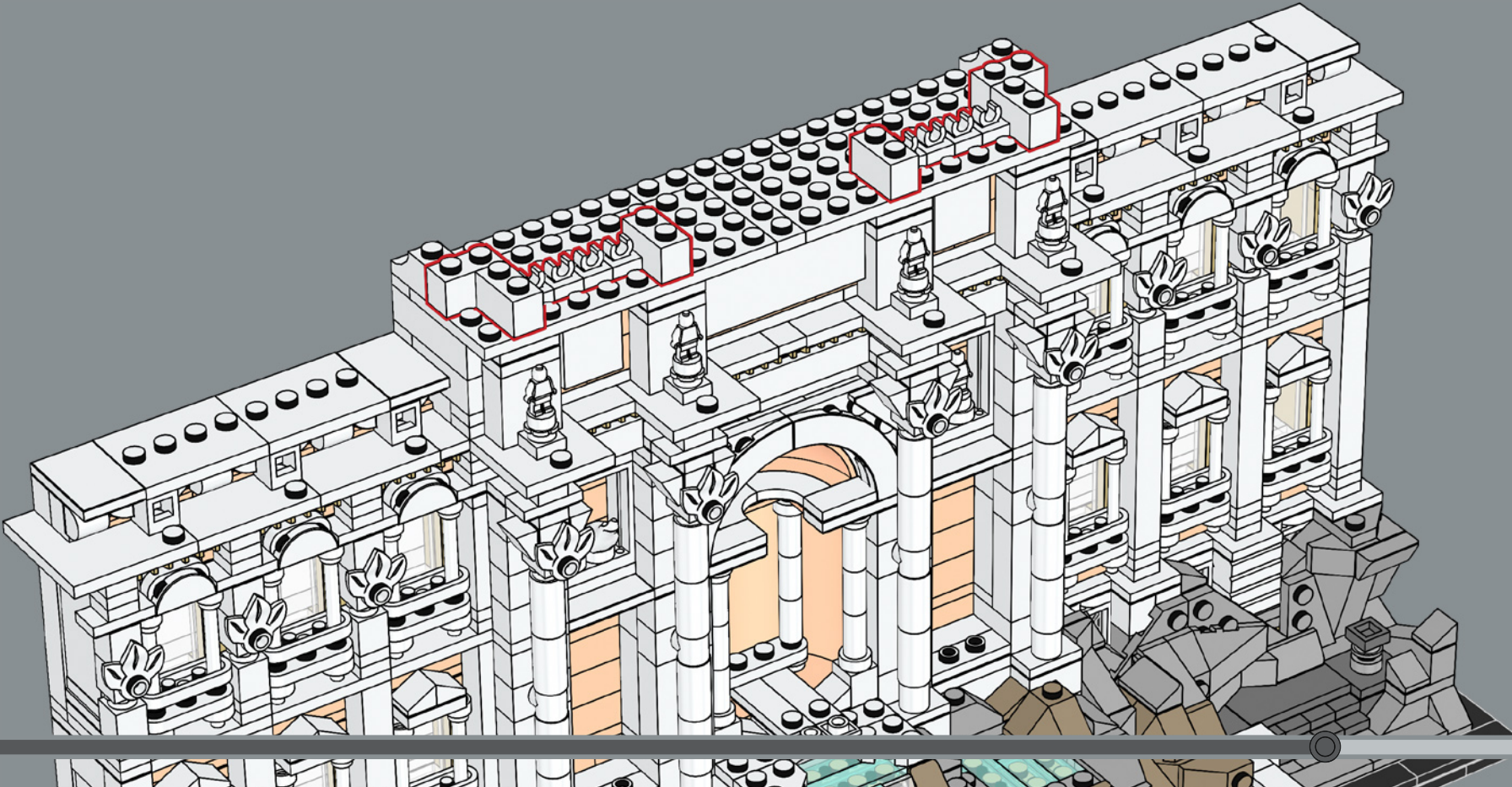

2x 1x 2x

302

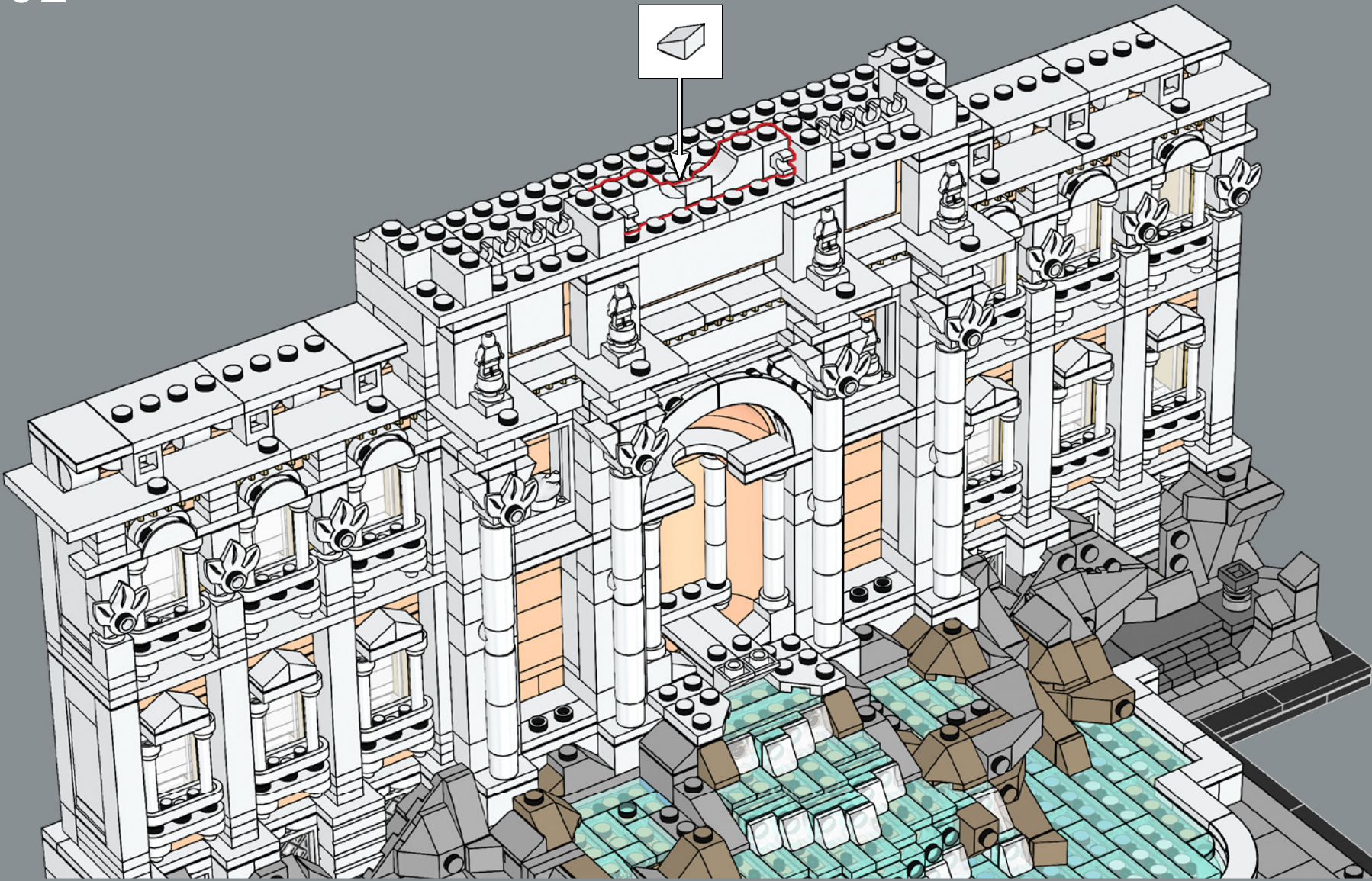
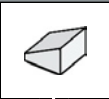



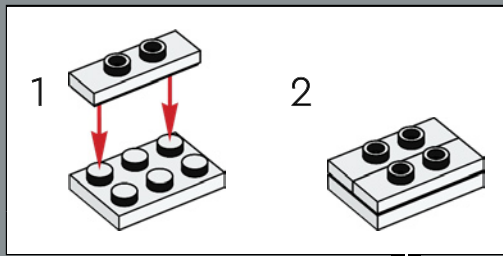
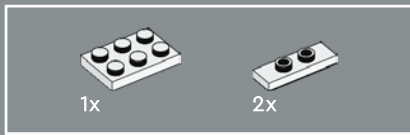

303

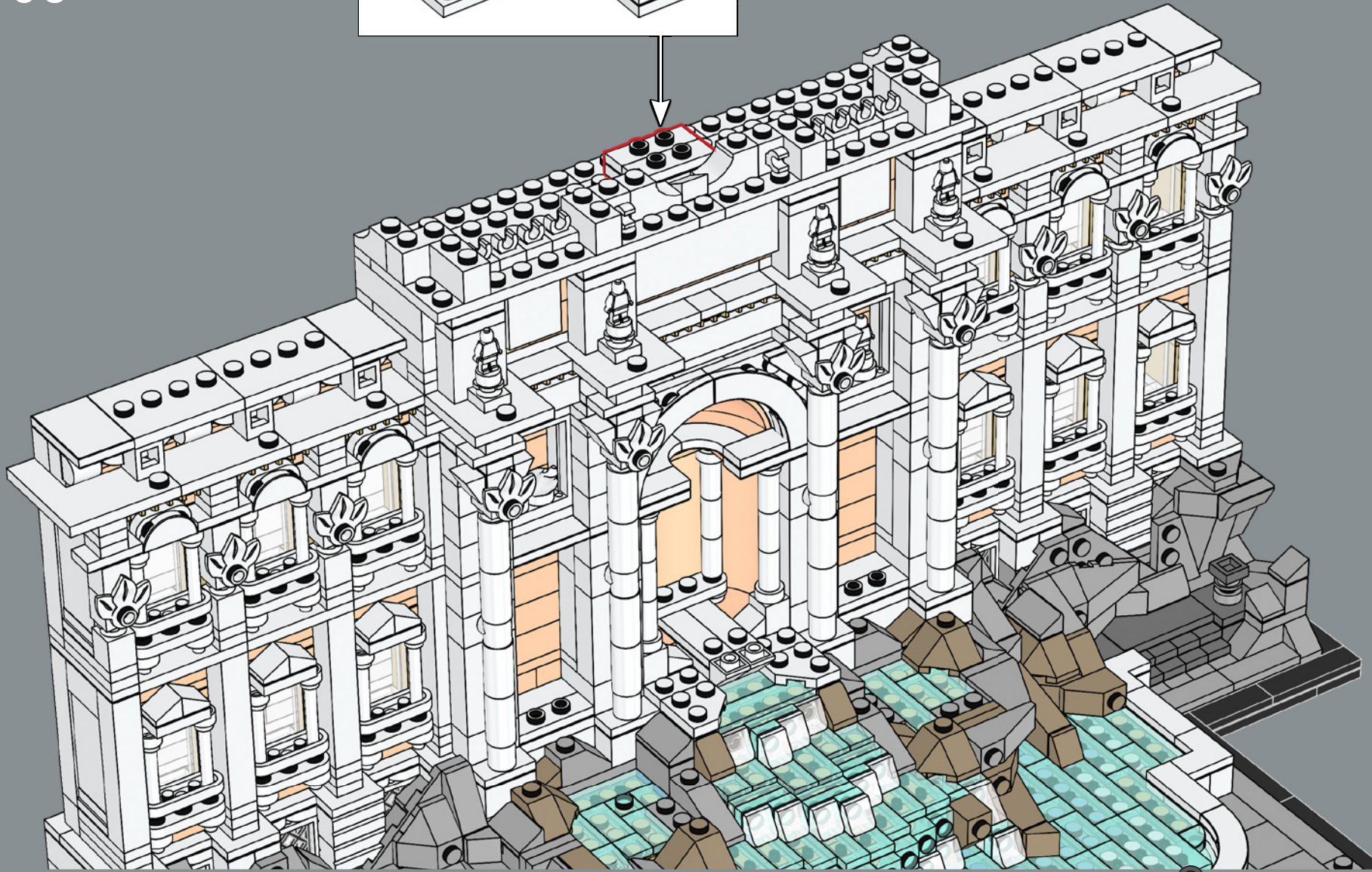

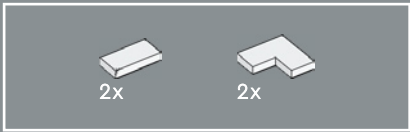

304

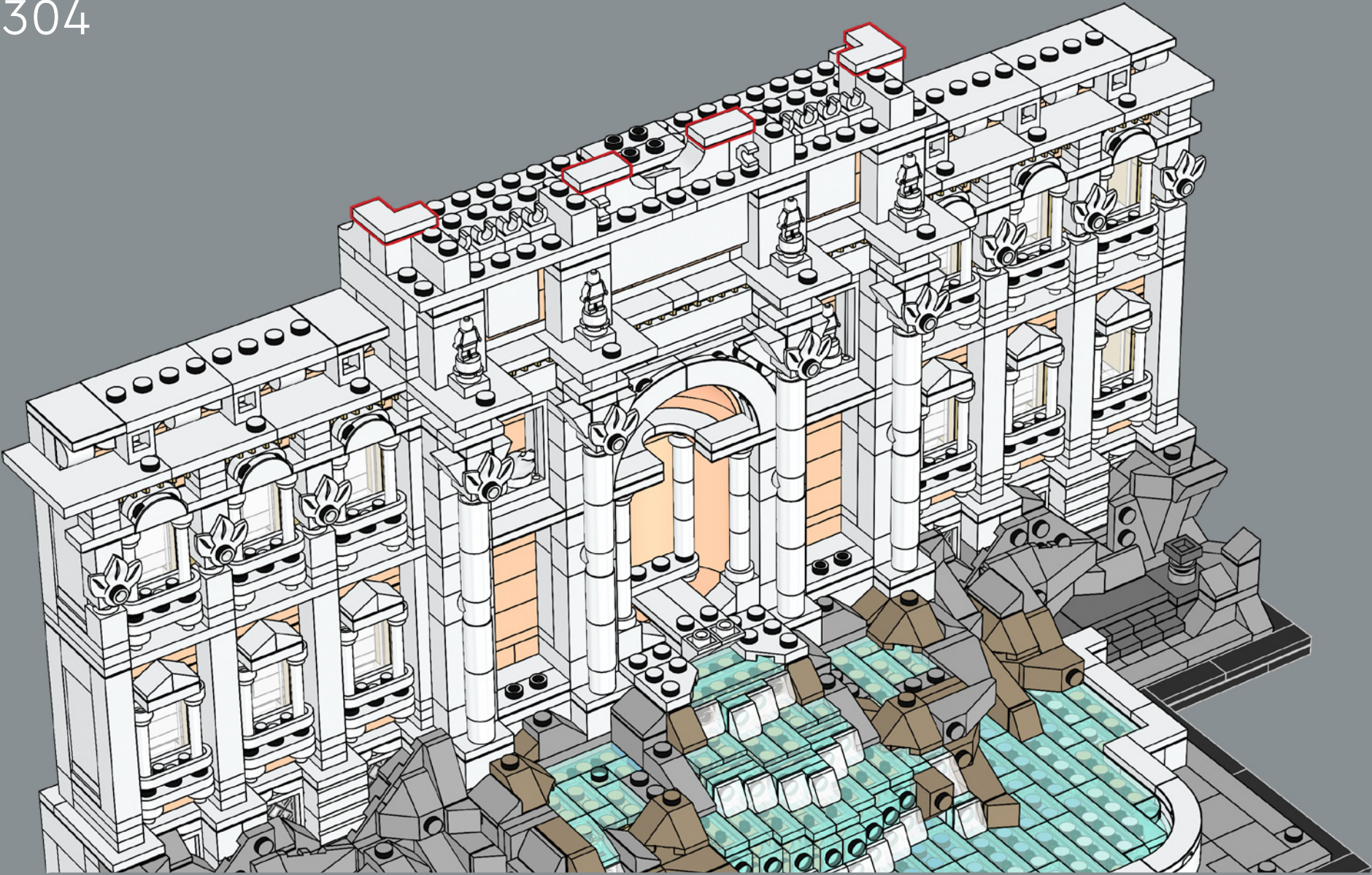

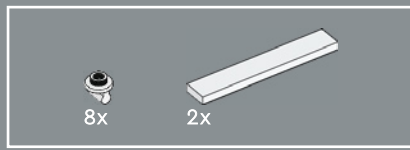

305

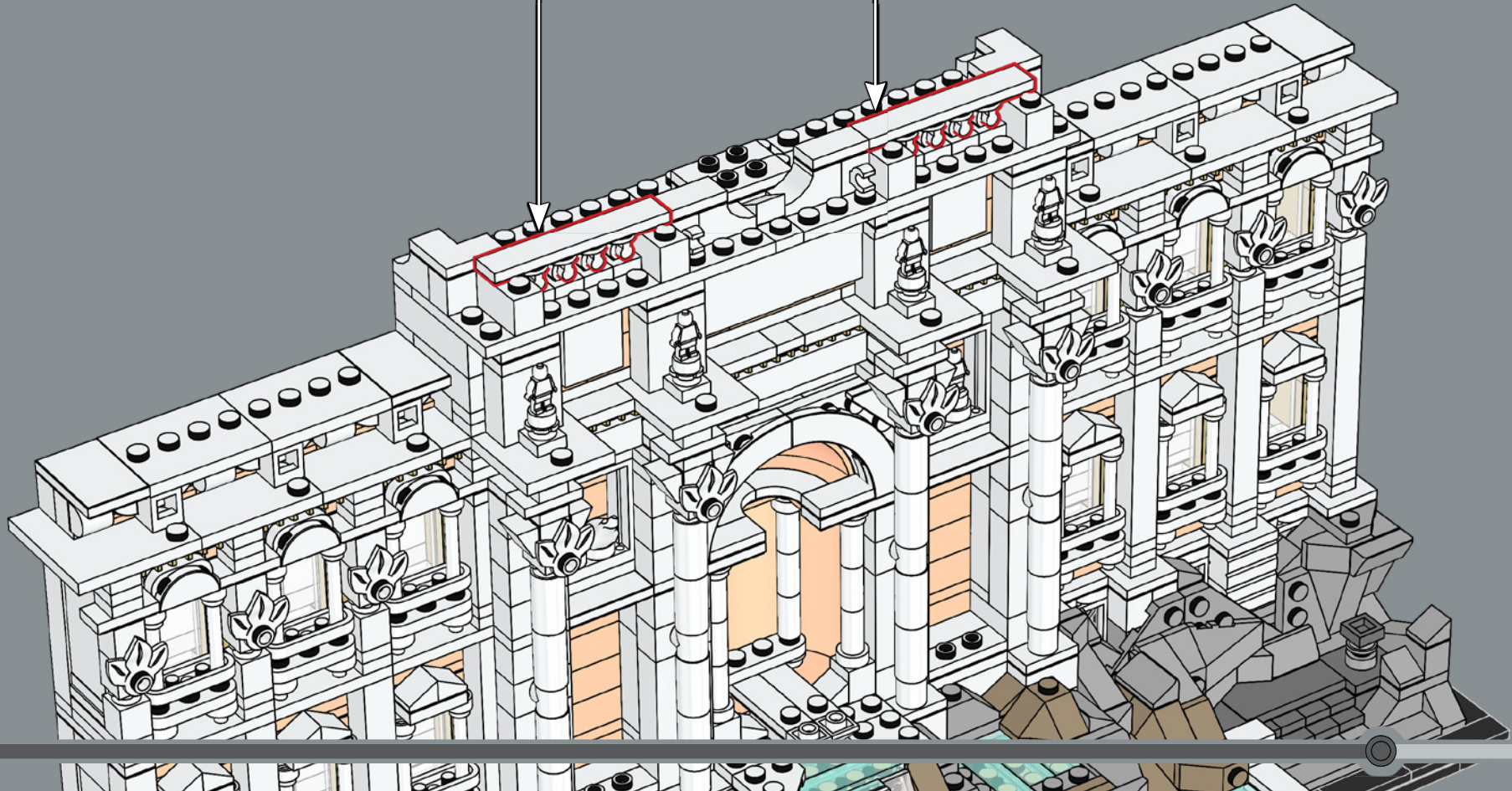
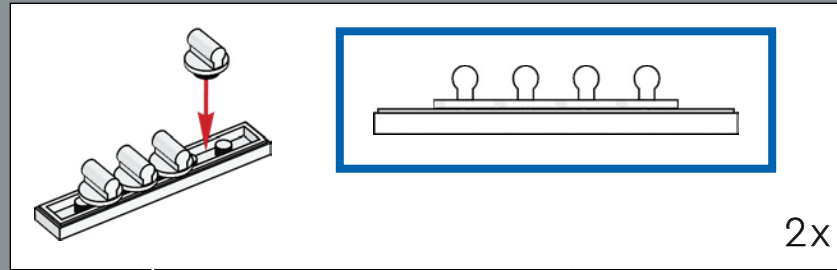

4x  2x 

306

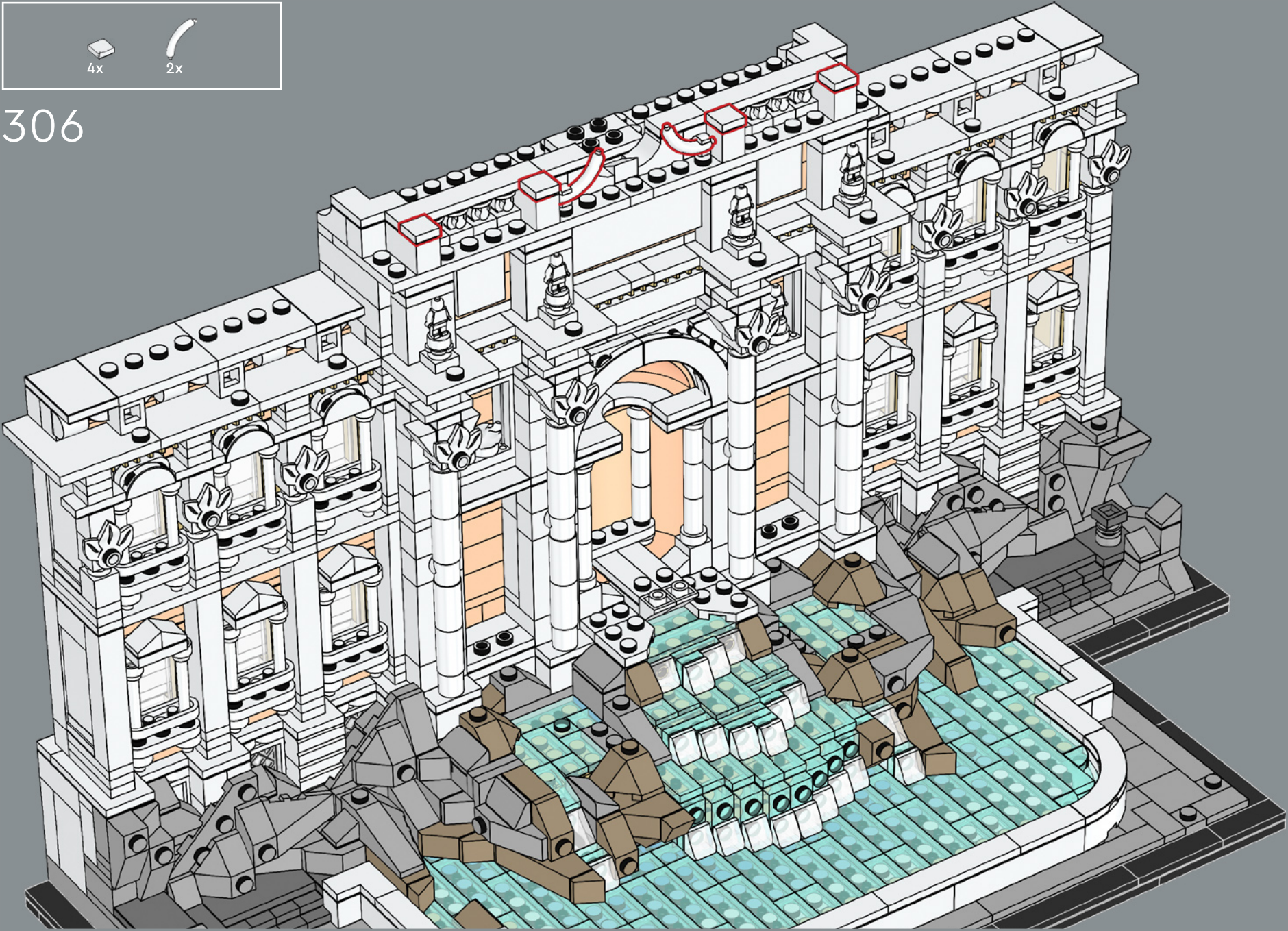

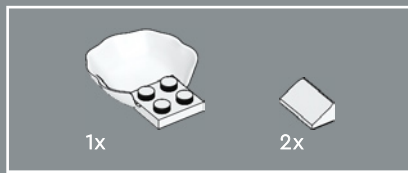

307



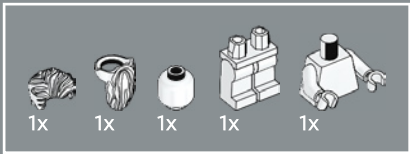

308

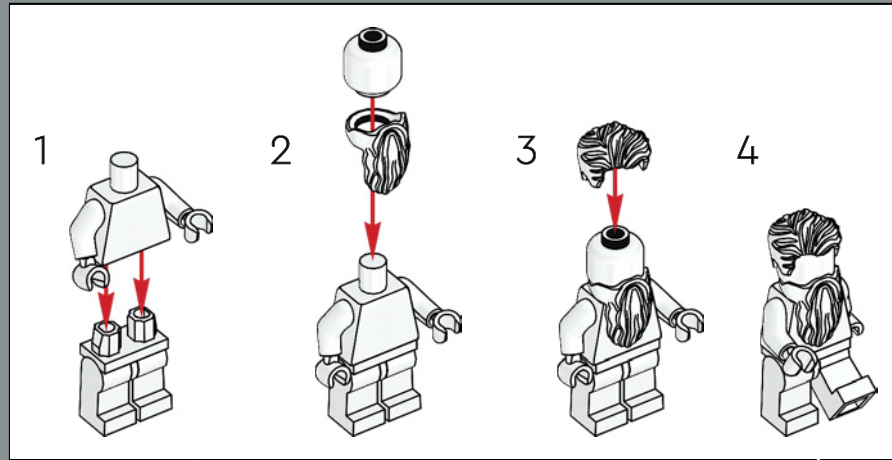

Questa è la prima volta che una minifigure appare in un set LEGO® Architecture.

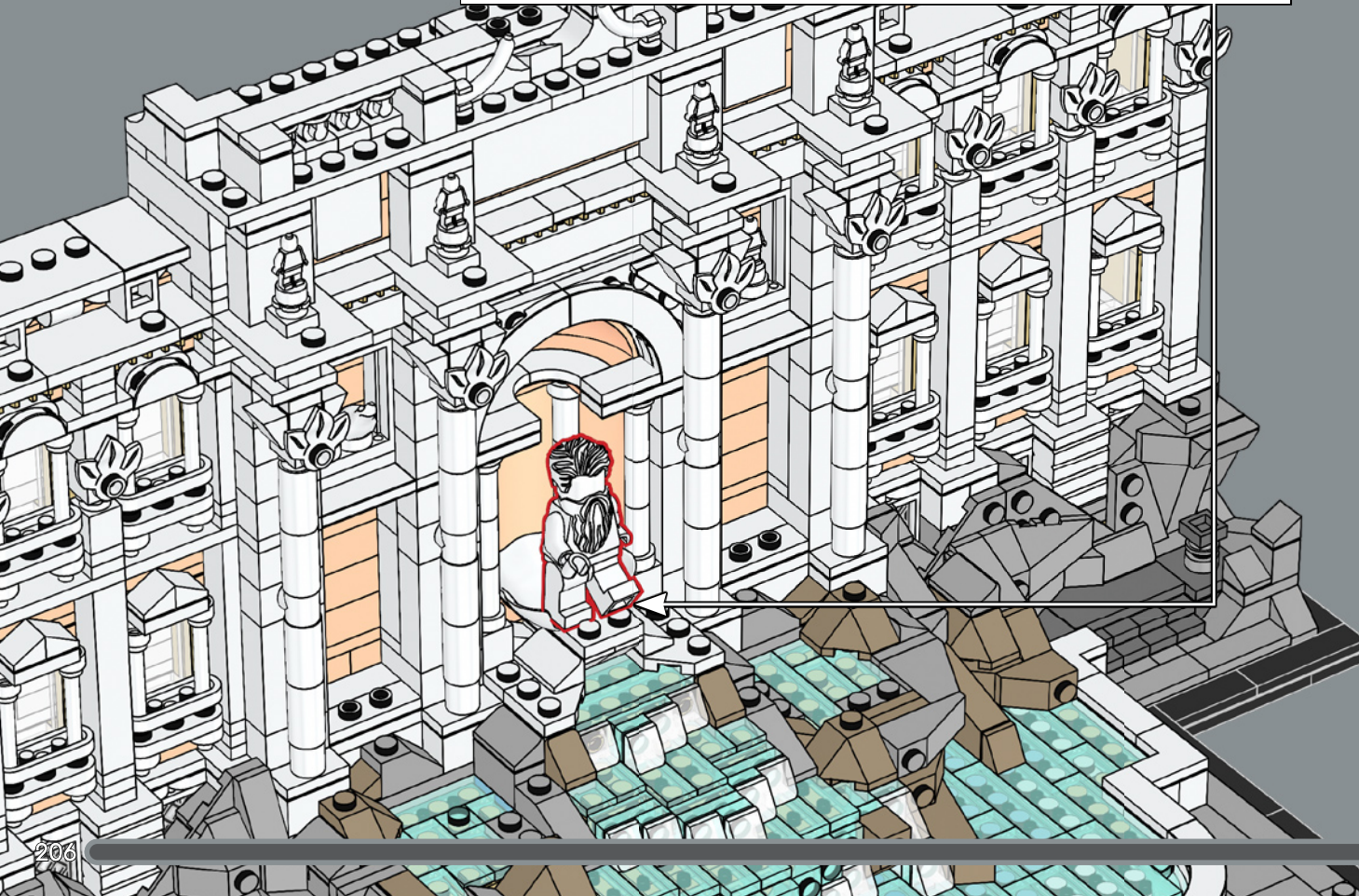

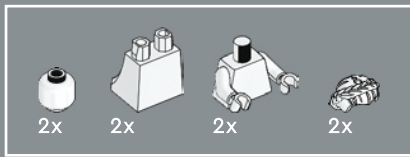

309

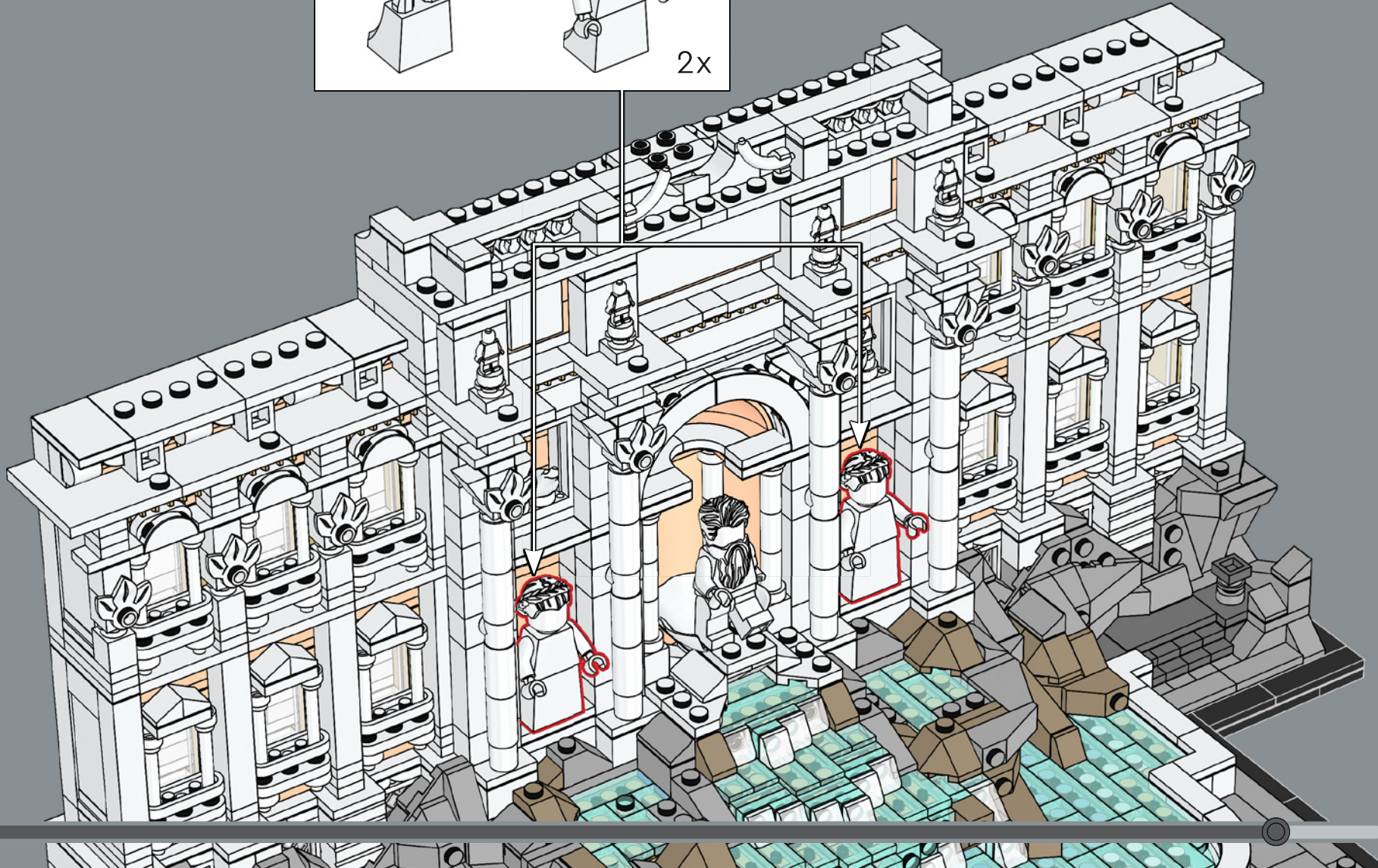
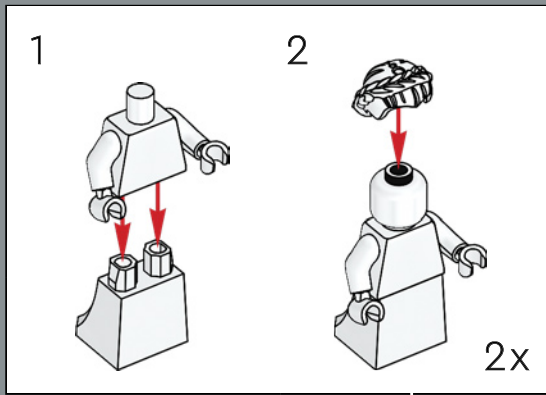

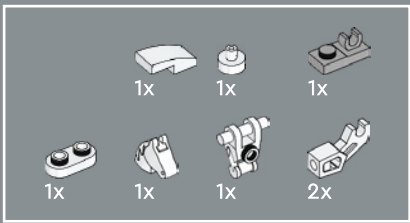

# 310

La testa di cavallo LEGO® proviene da una serie di Minifigure LEGO collezionabili ed è stata usata per conferire dettagli ai cavalli marini.

1



2

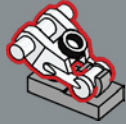

3

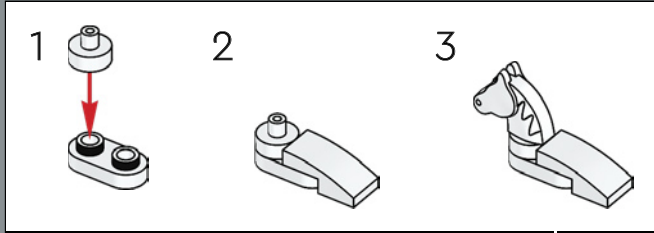
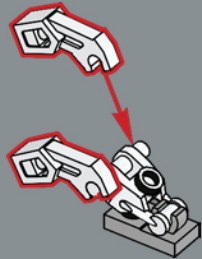

4

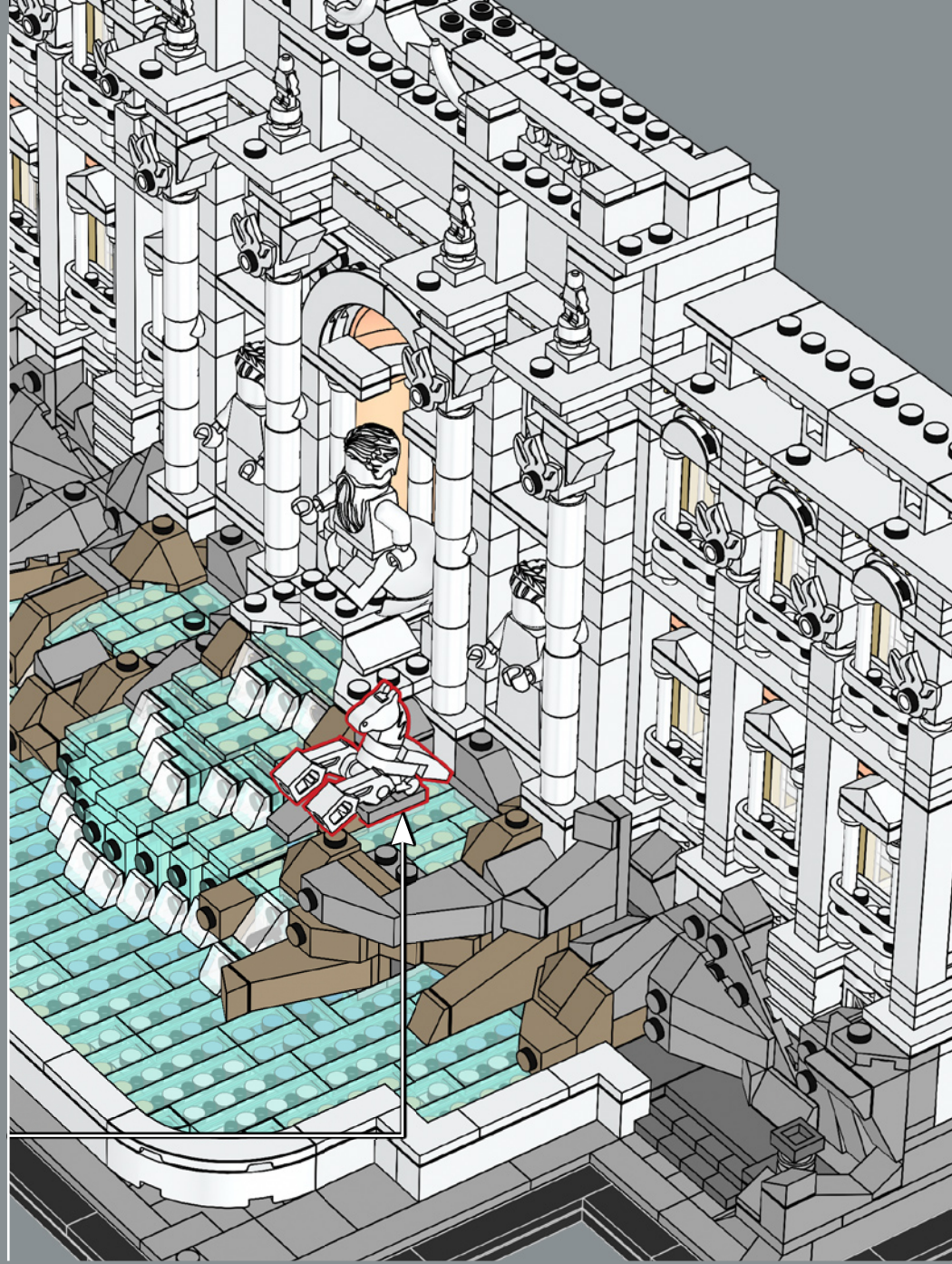
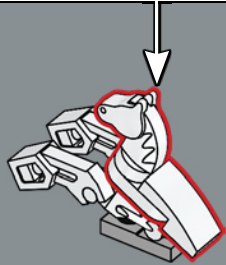





311

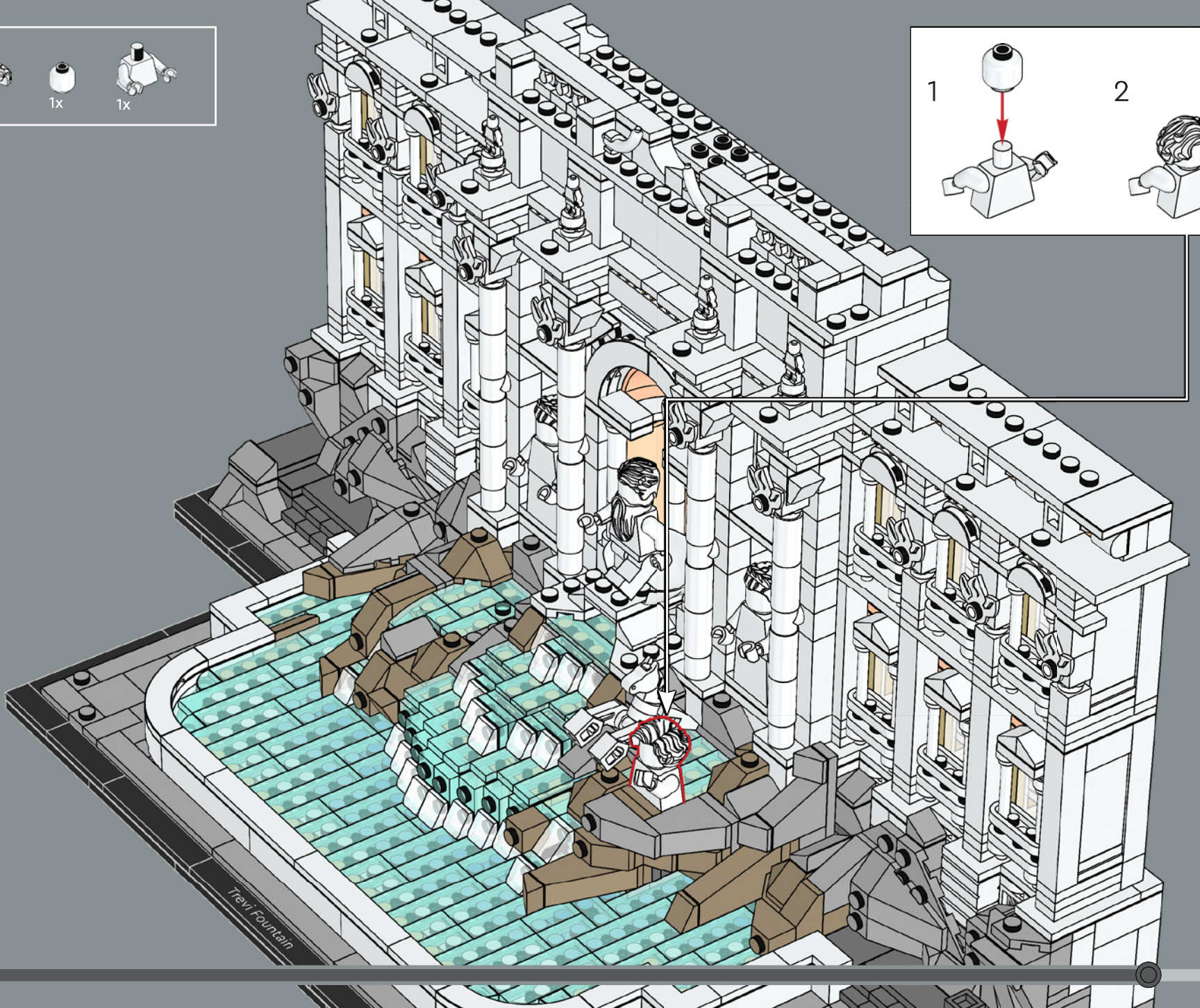
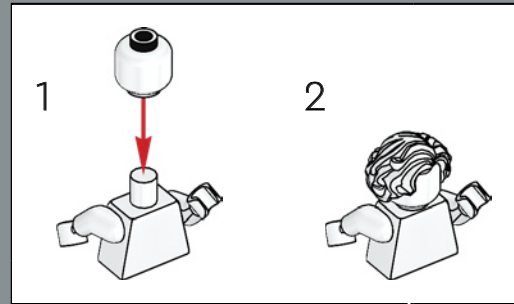



312

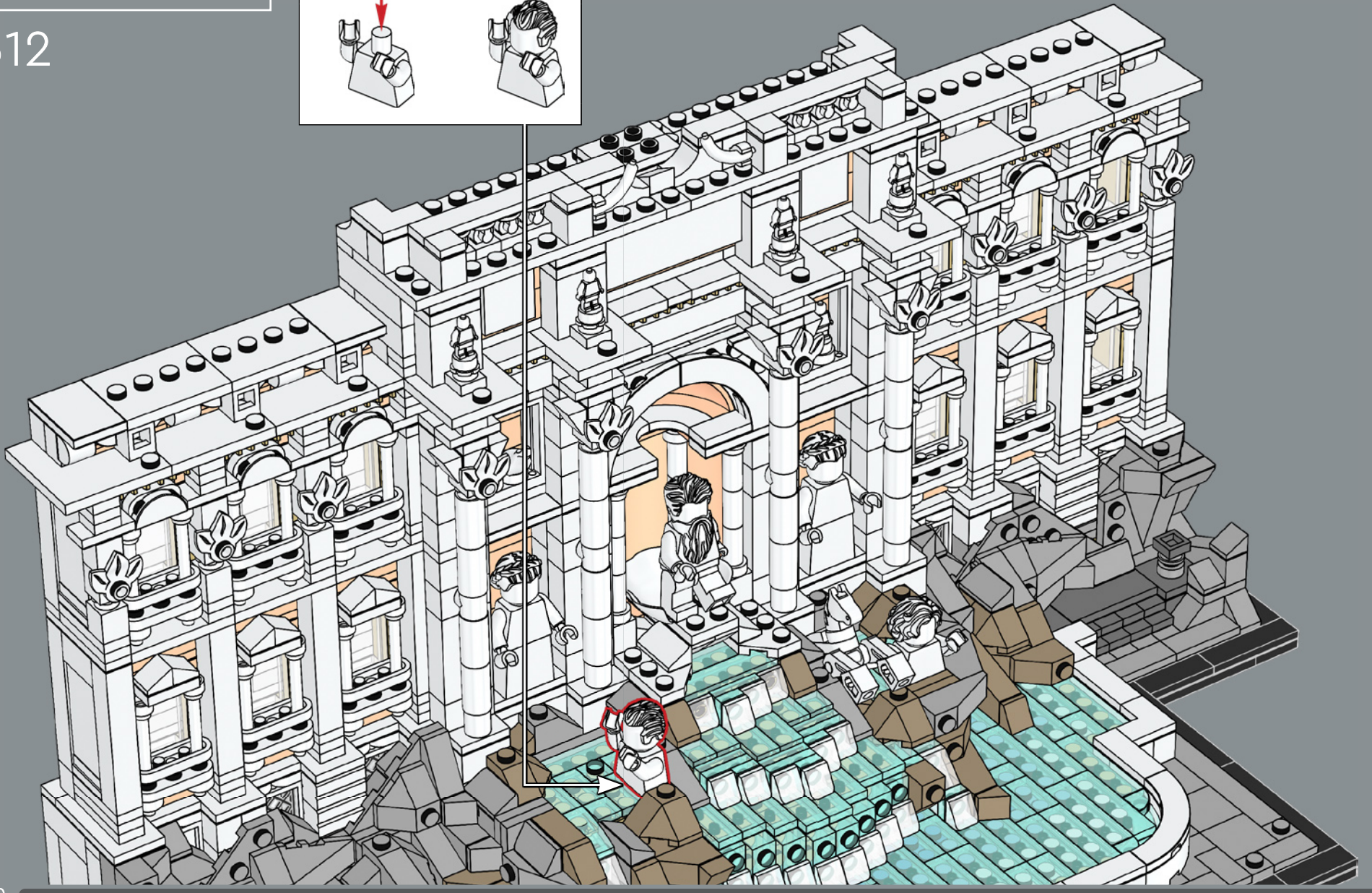
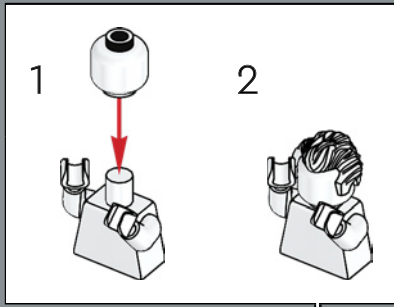

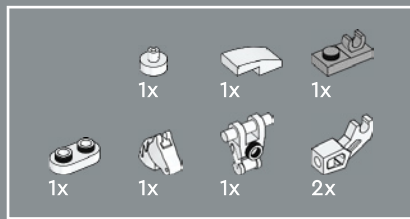

313

1



2

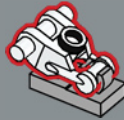

3

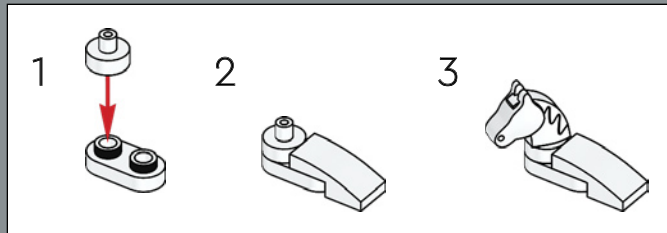
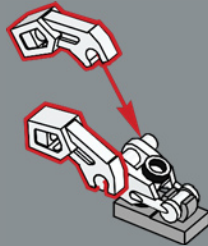

4

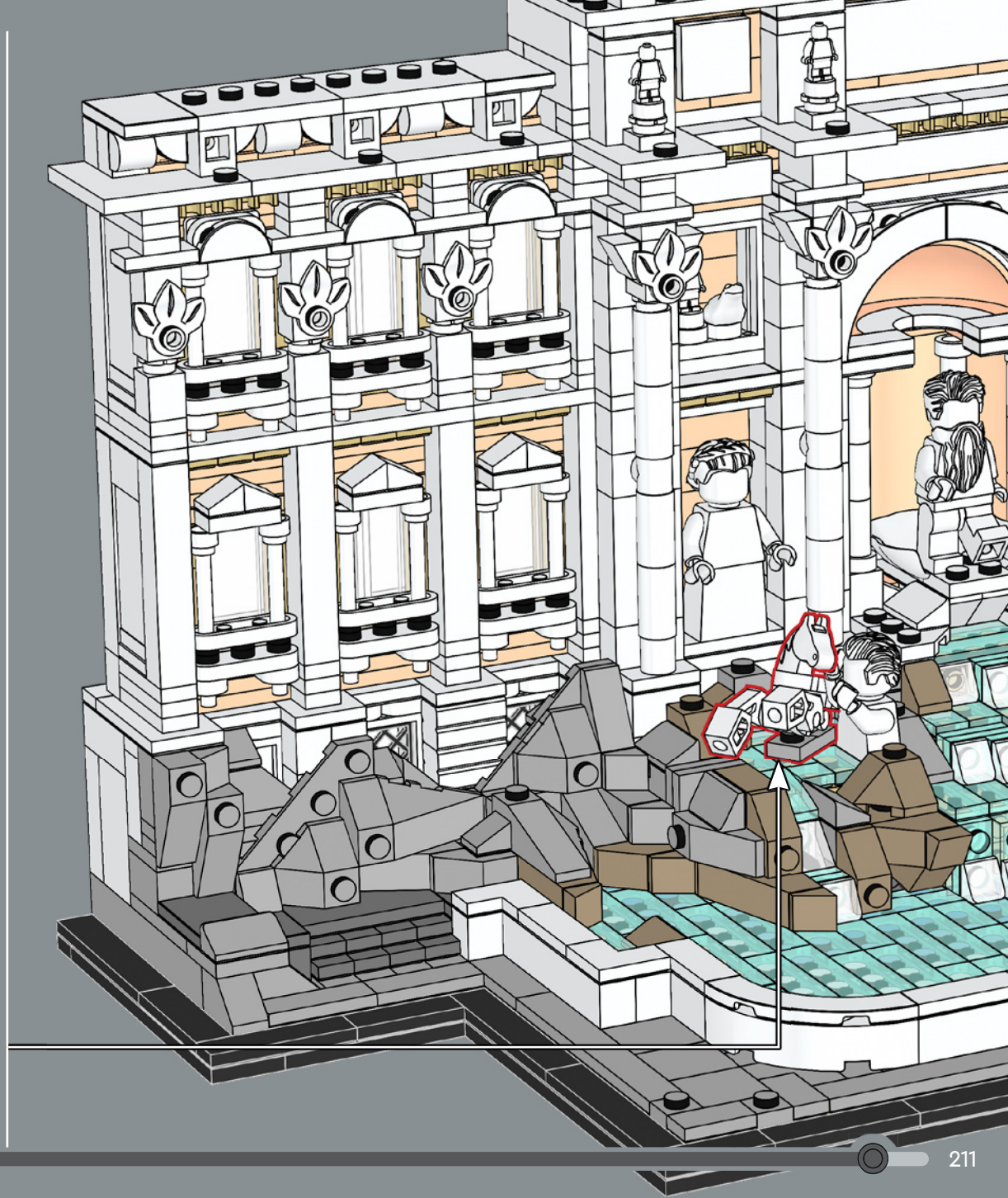
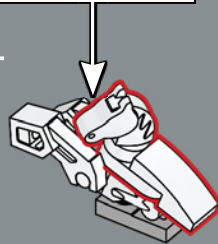

2x 2x

314

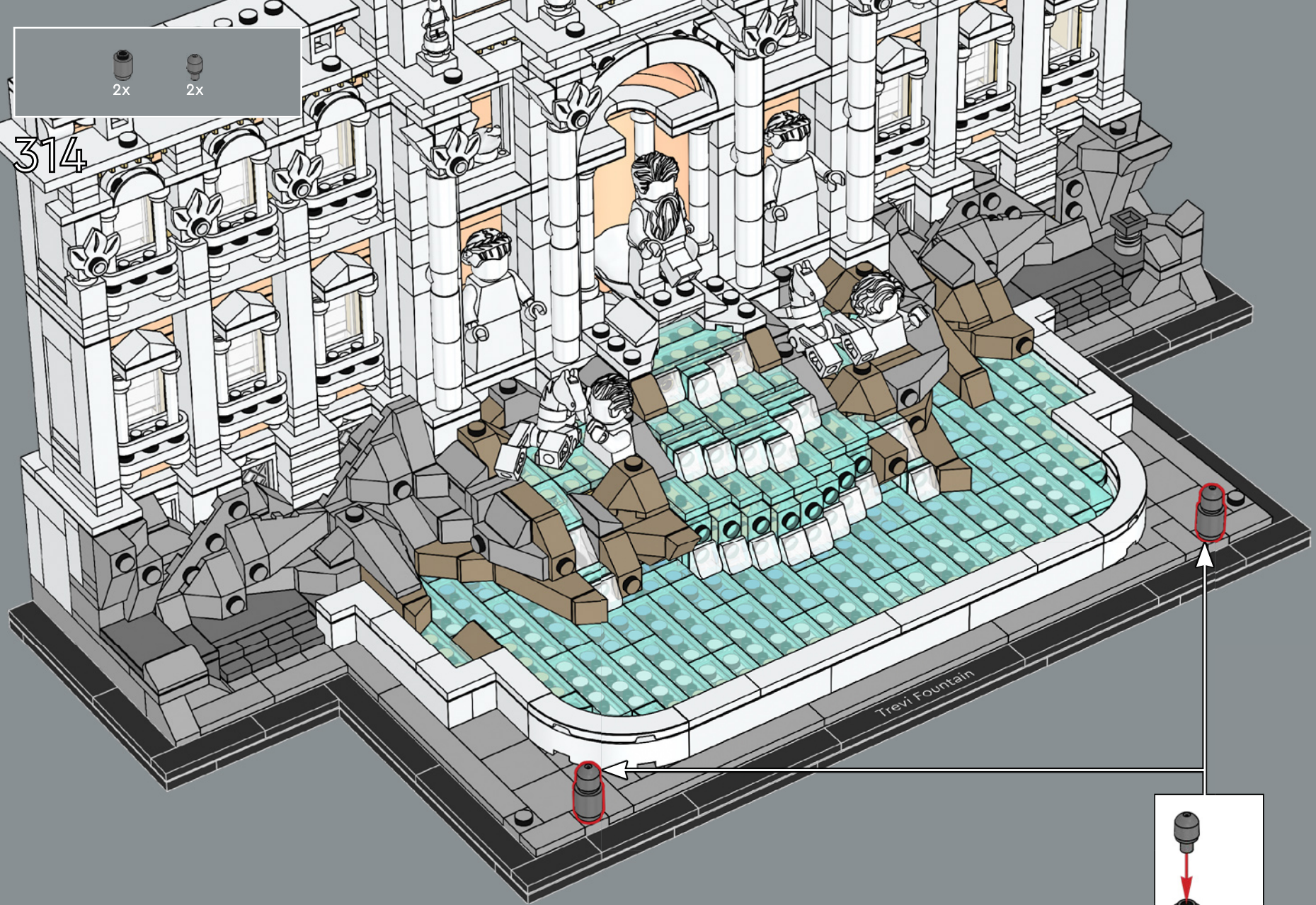

Trevi Fountain

2x

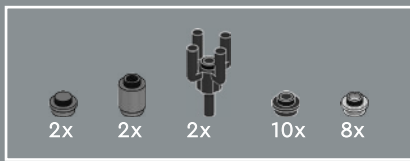

315

1

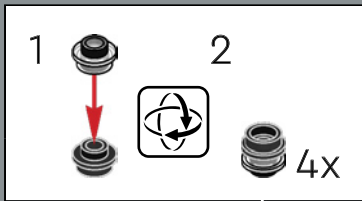
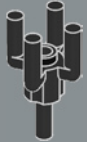

2

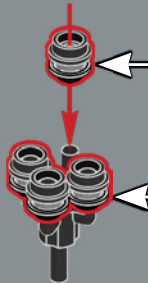

3

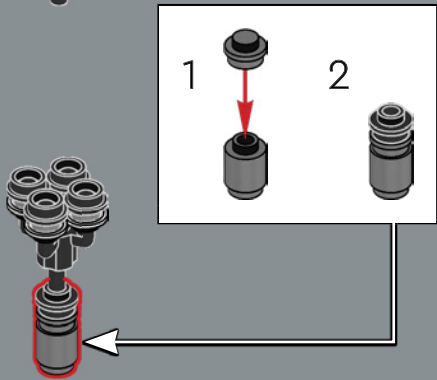

2x

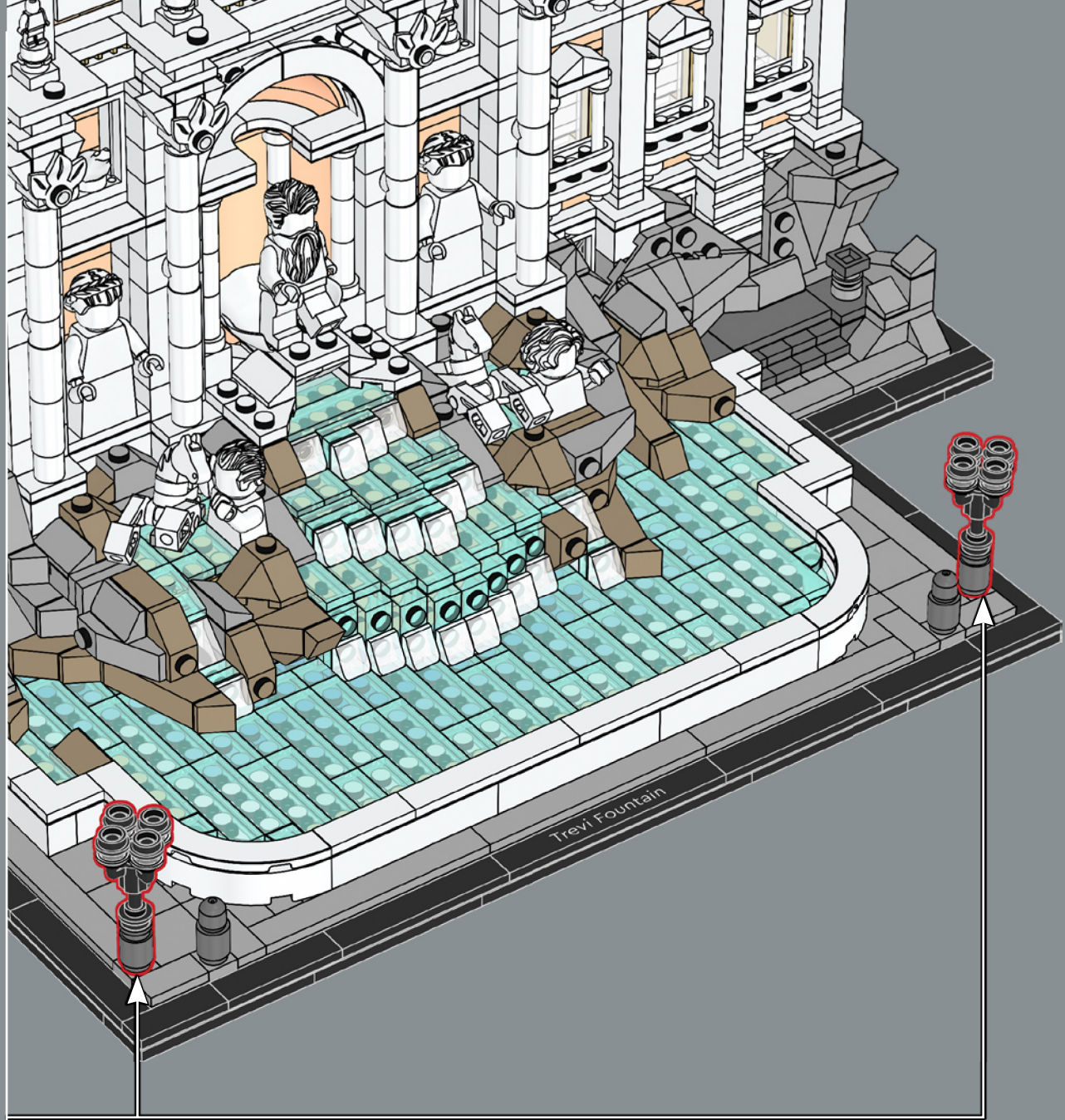

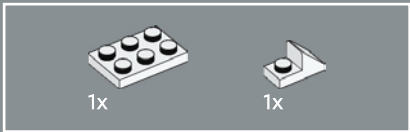

316

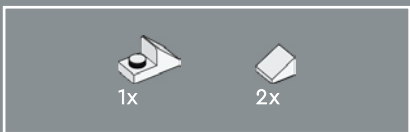
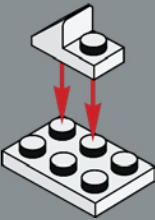

317

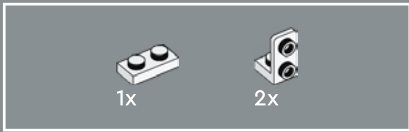

318

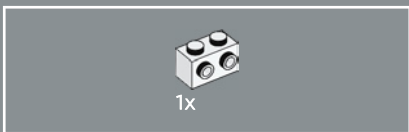
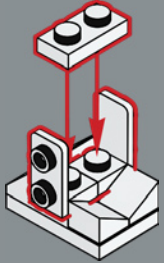

319

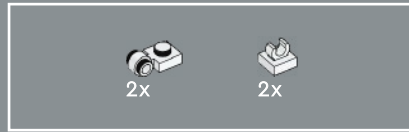
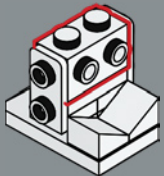

320

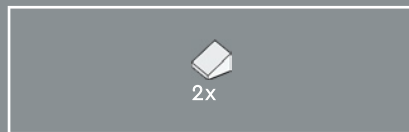
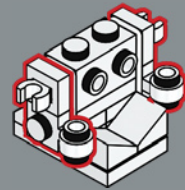

321

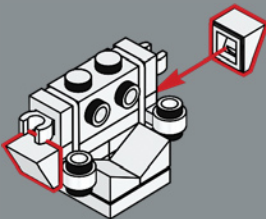

322

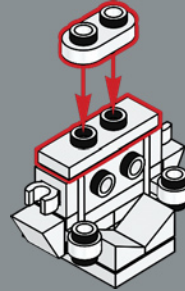

323

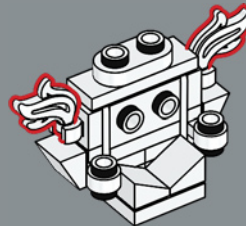



2x

324

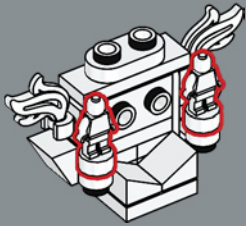

1x

325

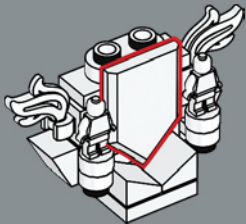

2x

326

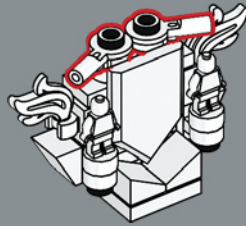

1x



1x

327

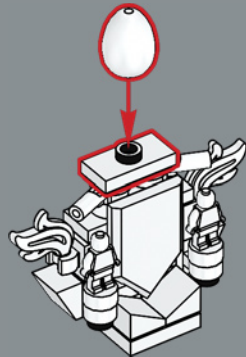

328

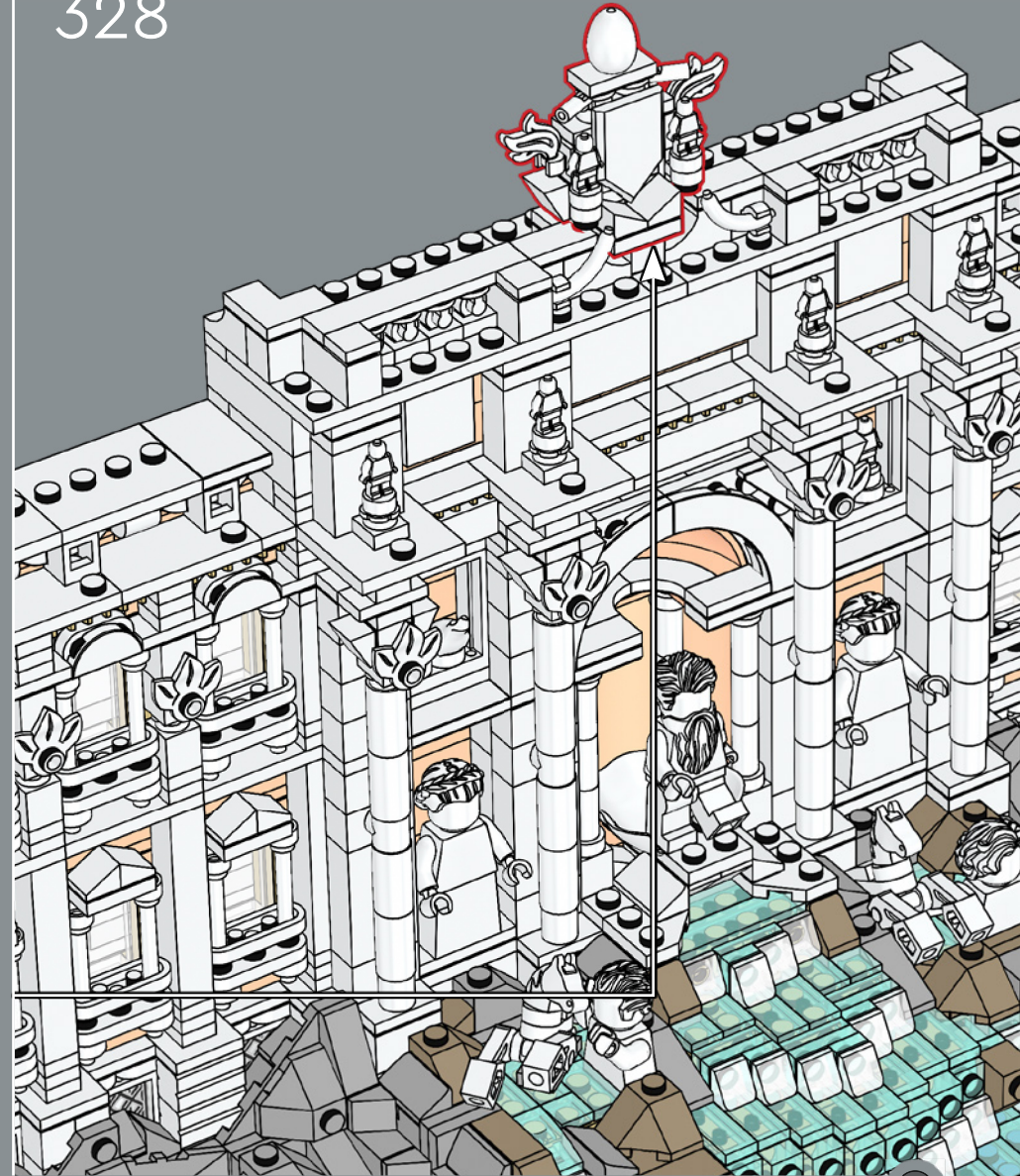

La Fontana di Trevi, in travertino, ha fatto da sfondo a molti film classici, tra cui *La Dolce Vita* di Federico Fellini (1960).

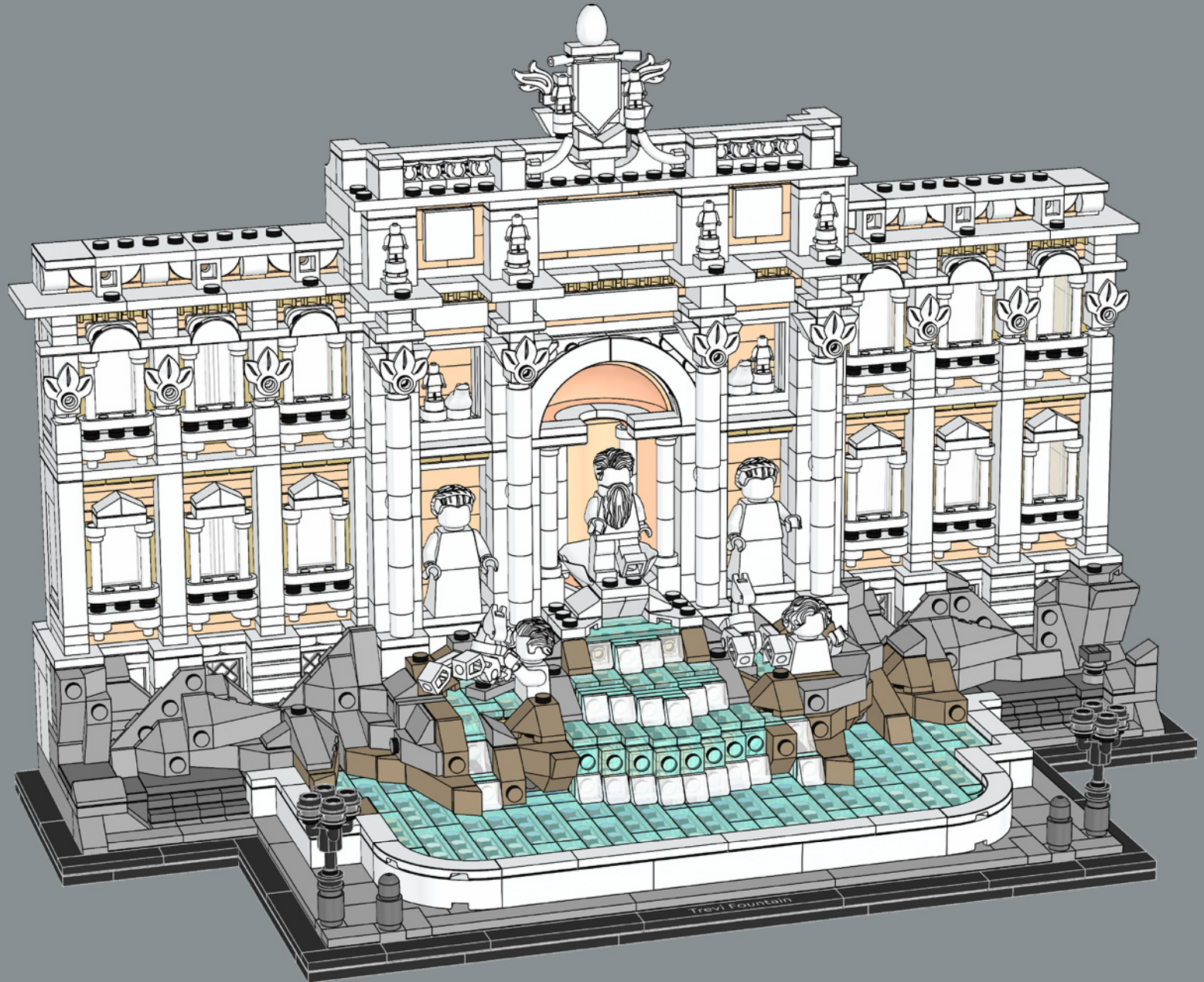



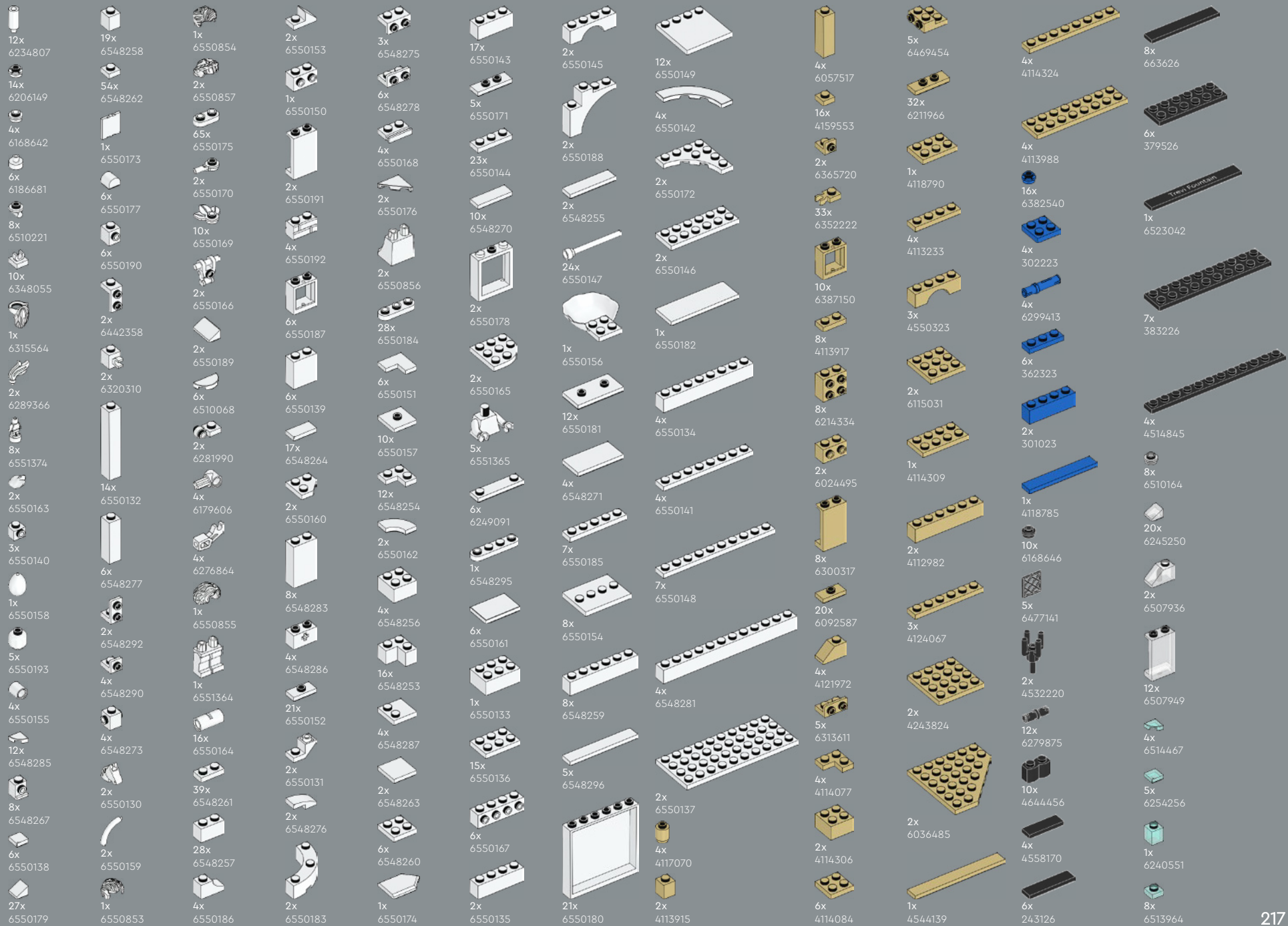

- 2x 6537848
- 14x 6514007
- 39x 6514224
- 6x 6514268
- 1x 6508249
- 54x 6510178
- 1x 6240515
- 10x 6322841
- 4x 6001824
- 9x 4530678
- 5x 4528604
- 4x 4653509
- 1x 6449563
- 1x 4521914
- 2x 6093064
- 1x 6228921
- 7x 6331865
- 2x 6035540
- 10x 6040126
- 1x 6015449
- 1x 6168647
- 1x 6258831
- 3x 4211389
- 19x 4521921
- 3x 6225242
- 6x 4211399
- 8x 4211415
- 4x 4558953
- 6x 6248890
- 1x 4211791
- 10x 4568637
- 1x 6213378
- 1x 6186657
- 3x 6123809
- 4x 4515374
- 11x 4211614
- 4x 6066097
- 9x 4211414
- 4x 4211388
- 1x 6093859
- 1x 4211564
- 5x 4211398
- 2x 6326078
- 2x 6383177
- 1x 6217876
- 1x 4211349
- 2x 6177078
- 6x 4211413
- 2x 6034676
- 8x 6212077
- 11x 4211353
- 2x 6469440
- 11x 4211488
- 6x 4558169
- 8x 6211969
- 4x 4211396
- 4x 4160560
- 7x 4211445
- 1x 4180418
- 3x 4180408
- 1x 6372029
- 1x 4211438
- 6x 4211452
- 2x 4211795
- 7x 4211425
- 2x 4211392
- 5x 4211481
- 1x 6313653
- 5x 4211404
- 1x 4210719
- 16x 6092572
- 4x 4210978
- 1x 6126083
- 2x 6309059
- 2x 4211133
- 1x 4211104
- 2x 6343852
- 8x 6187008
- 2x 4211105
- 4x 4211001
- 2x 4560184
- 3x 4620760
- 2x 4211002
- 2x 4211498
- 2x 4251149
- 5x 4617862
- 4x 4211408
- 2x 4211360
- 2x 4662161
- 1x 6528242
- 2x 6344216
- 4x 4211090
- 2x 4210633
- 4x 6395635
- 1x 6228923
- 4x 4558955
- 2x 4211107
- 2x 4211061
- 2x 4210678
- 4x 6000970
- 16x 6426347
- 4x 6357797
- 6x 6369189
- 16x 6329282
- 4x 6369188
- 21x 6357794
- 10x 6501239
- 4x 6440965
- 12x 6424071
- 1x 6541427
- 1x 6537849
- 12x 6537846
- 2x 6329604
- 4x 6439745
- 8x 6206809
- 4x 6144149
- 4x 4649741
- 2x 6070757
- 8x 4655256
- 2x 6146701
- 6x 6141592
- 2x 6138662



 [LEGO.com/service](https://www.LEGO.com/service)



# YOU COULD WIN



## YOU COULD WIN

Your feedback will help shape the future development of this product series.

Visit:

## DU KÖNNTEST GEWINNEN

Dein Feedback trägt zur Weiterentwicklung dieser Produktreihe bei.

Geh auf:

## VOUS POURRIEZ GAGNER

Vos commentaires nous aideront à concevoir les futurs produits de cette gamme.

Visitez :

## POTRESTI VINCERE TU

La tua opinione ci aiuterà a migliorare la creazione futura di questa linea di prodotti.

Visita:

## PUEDES GANAR

Tu opinión contribuirá al futuro de esta serie de productos.

Visita:

## 轻松获奖

您的反馈将有助于我们在今后改进本产品系列。

请访问:

---

**[LEGO.com/productfeedback](https://www.lego.com/productfeedback)**

---

You also have the chance to win a LEGO® set.

Terms and conditions apply.\*

Außerdem hast du die Chance, ein LEGO® Set zu gewinnen.

Es gelten die Teilnahmebedingungen.\*

Vous pourriez également gagner un ensemble LEGO®.

Des conditions s'appliquent.\*

Hai anche la possibilità di vincere un set LEGO®.

Termini e condizioni sono applicabili.\*

También tienes la oportunidad de ganar un set LEGO®.

Aplican términos y condiciones.\*

您还有机会赢取乐高®套装。

条款和条件适用。\*

\*[LEGO.com/productfeedback-terms](https://www.lego.com/productfeedback-terms)

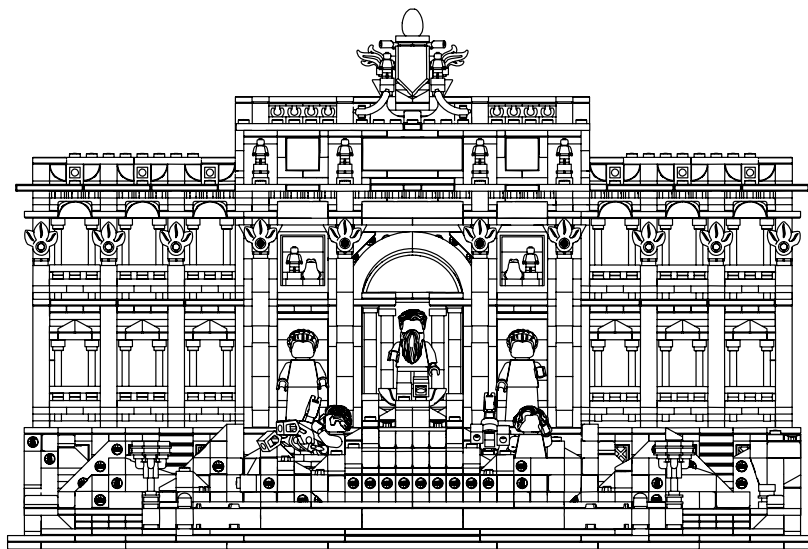

LEGO and the LEGO logo are trademarks of the LEGO Group. ©2025 The LEGO Group.  
Adam Reed Tucker is the co-developer of the LEGO® Architecture product line.