



10359





LEGO.com/sustainable-packaging



FR
DONNEZ
OU
RECYCLEZ



OU



OU



ASSOCIATION MAGASIN DÉCHÈTERIE

Adresses sur quefairedemesdechets.fr



BUILDER



Apple and the Apple logo are trademarks of Apple Inc., registered in the U.S. and other countries and regions. App Store is a service mark of Apple Inc. Google Play and the Google Play logo are trademarks of Google LLC. Tencent and the Tencent logo are trademarks of Tencent Inc.

LEGO.com/devicecheck



LEGO® Builder

Costruire serenità

Lasciati trasportare in un giardino sereno e tranquillo, dove potrai soggiornare a tuo piacimento. Forse ti sentirai ispirato a nutrire le tue radici creative o a coltivare il tuo piccolo angolo di attività e riflessione. Questo è il tuo spazio.

Ci auguriamo che ti sentirai come a casa tua tra la rigogliosa flora e fauna vicino alla fontana. Forse riconoscerai alcune specie presenti nel tuo giardino o in un luogo familiare che hai visitato nel corso di un meraviglioso viaggio. Ogni elemento è il più autentico possibile in termini di area, cultura e architettura. Le splendide piastrelle decorative si ispirano alle piastrelle *zellij*, che hanno influenzato le tradizioni edilizie del Nord Africa e dell'Europa meridionale nel corso della storia e aggiungono un'atmosfera meravigliosamente vivida agli edifici, alle decorazioni interne e ai giardini. Abbiamo anche deciso di introdurre una nuova specie alla collezione di falene e farfalle LEGO® con l'affascinante Farfalla luna spagnola. Puoi dare nuova vita al tuo giardino spostando le piante in luoghi diversi in base al tuo umore o lasciando che si alternino prendendo il sole o rinfrescandosi all'ombra. Puoi anche spostare parti più grandi del modello per creare forme ed espressioni diverse.



“Dai vita al Giardino della fontana e diffondi
un'atmosfera estiva nella tua abitazione,
tutto l'anno”.

- LEGO® Design Team







La vita nel
tuo giardino





1

Pelophylax perezi

Rana verde iberica



2

Emberiza citrinella

Zigolo giallo



3

Graellsia isabellae

Farfalla luna spagnola



4

Pelargonium x hortorum

Geranio zonale

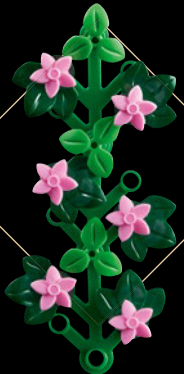

5

Bougainvillea

Fiori rosa di Bougainvillea



6

Tagetes patula

Tagete arancione



7

Hibiscus rosa-sinensis

Ibisco cinese

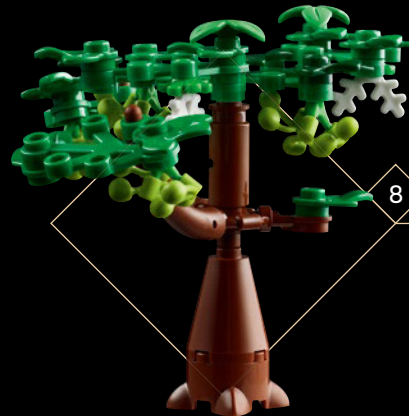

8

Vitis vinifera

Vite



9

Petunia axillaris

Petunia bianca



10

Cupressus sempervirens

Cipresso



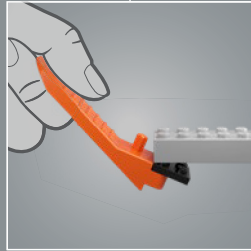
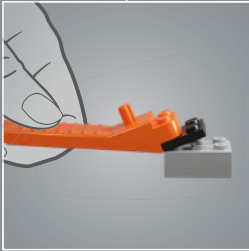
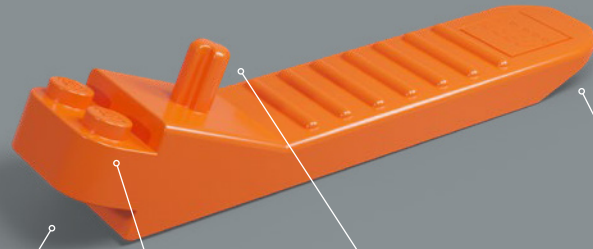

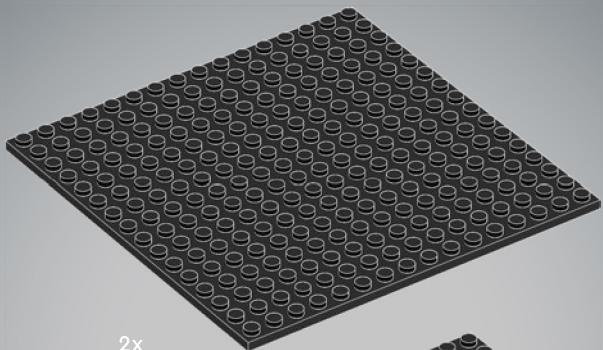

2x

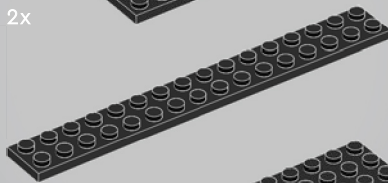

1x

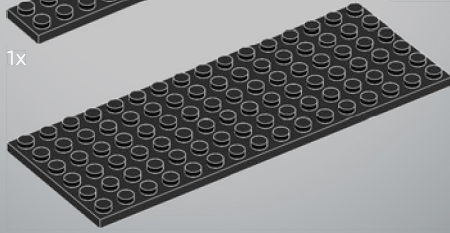

2x

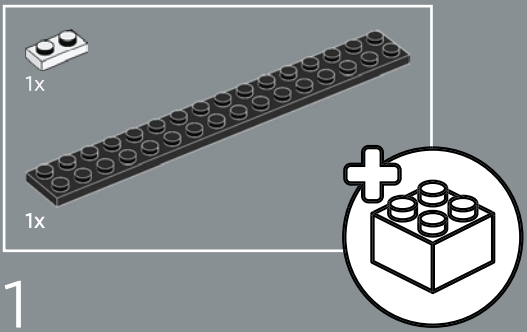

1

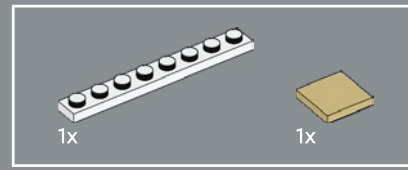
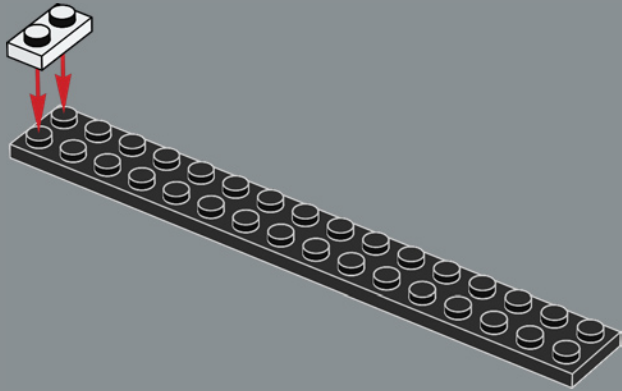

2

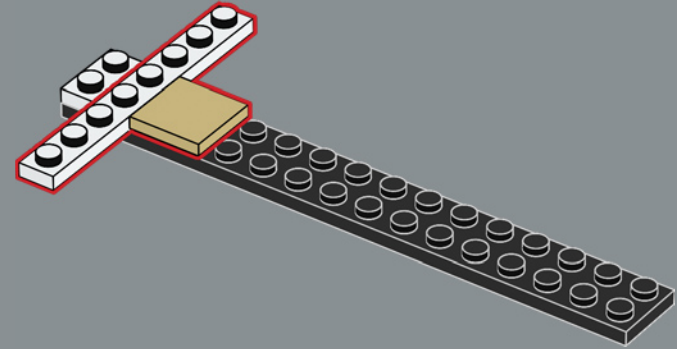

3

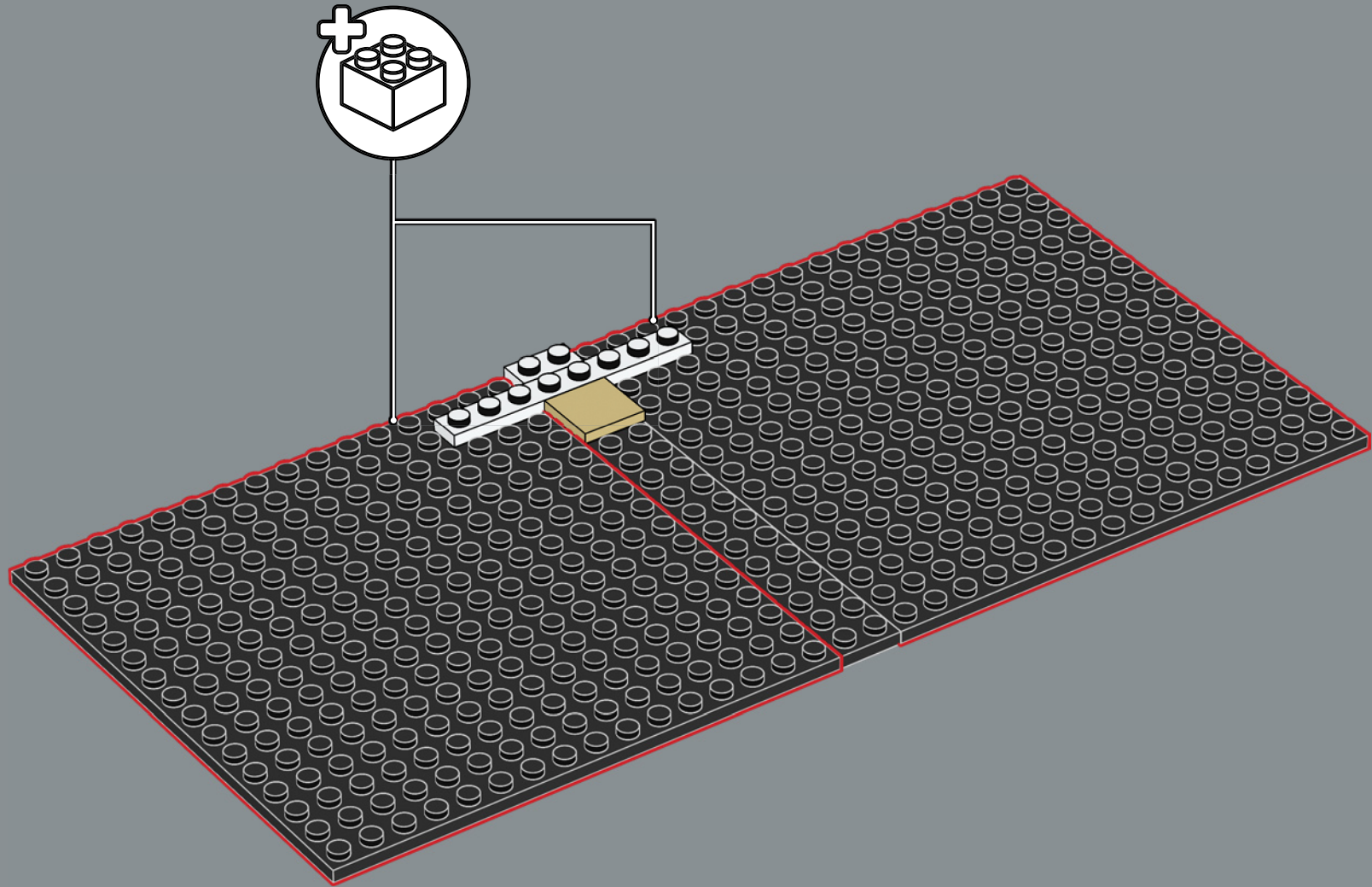

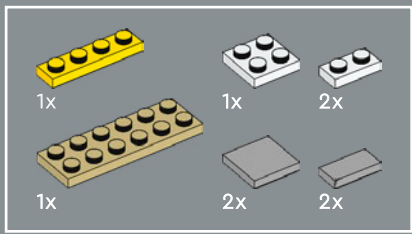

4

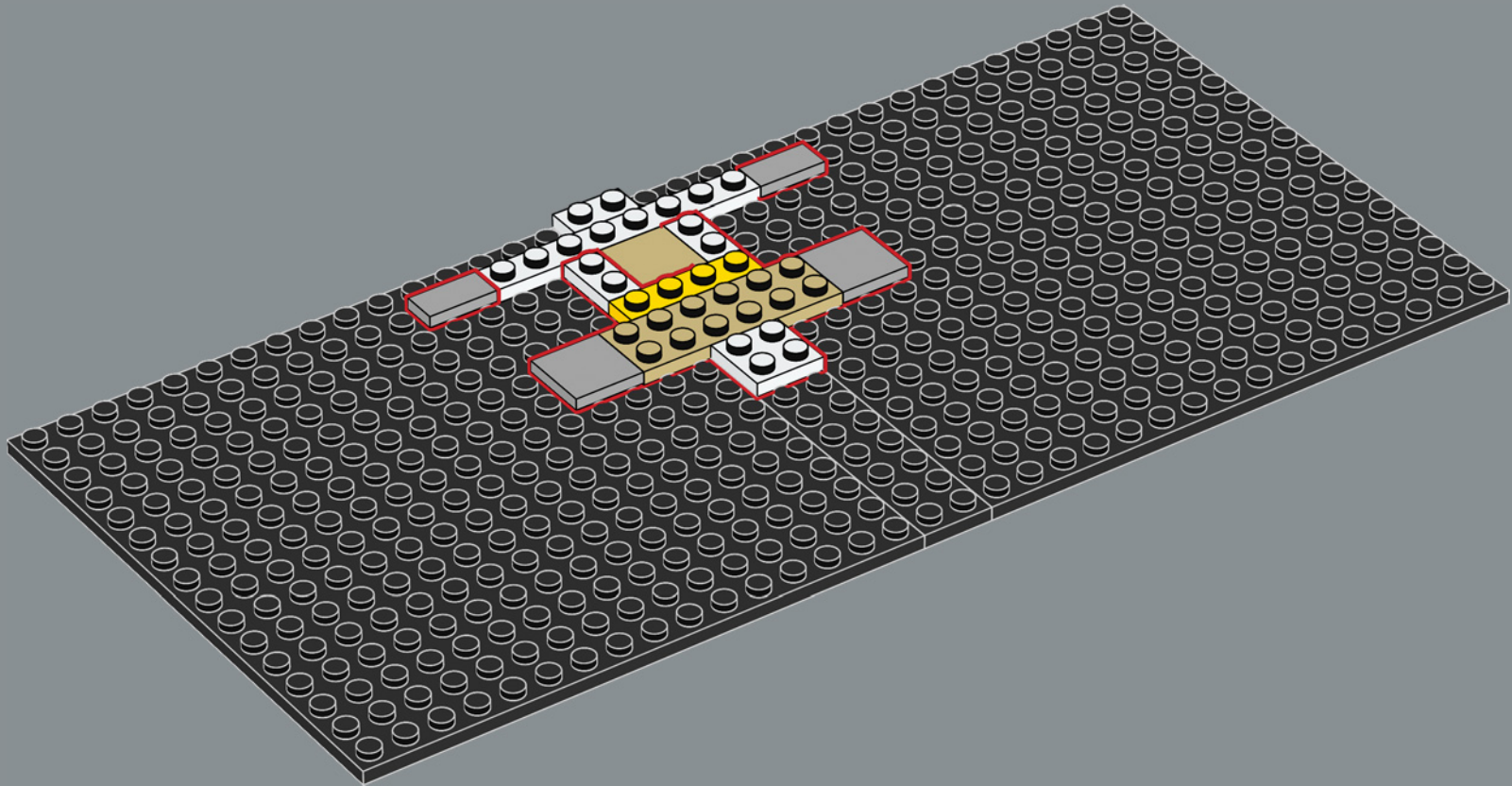

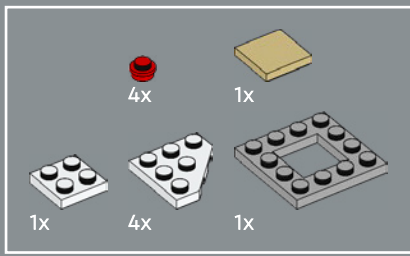

5

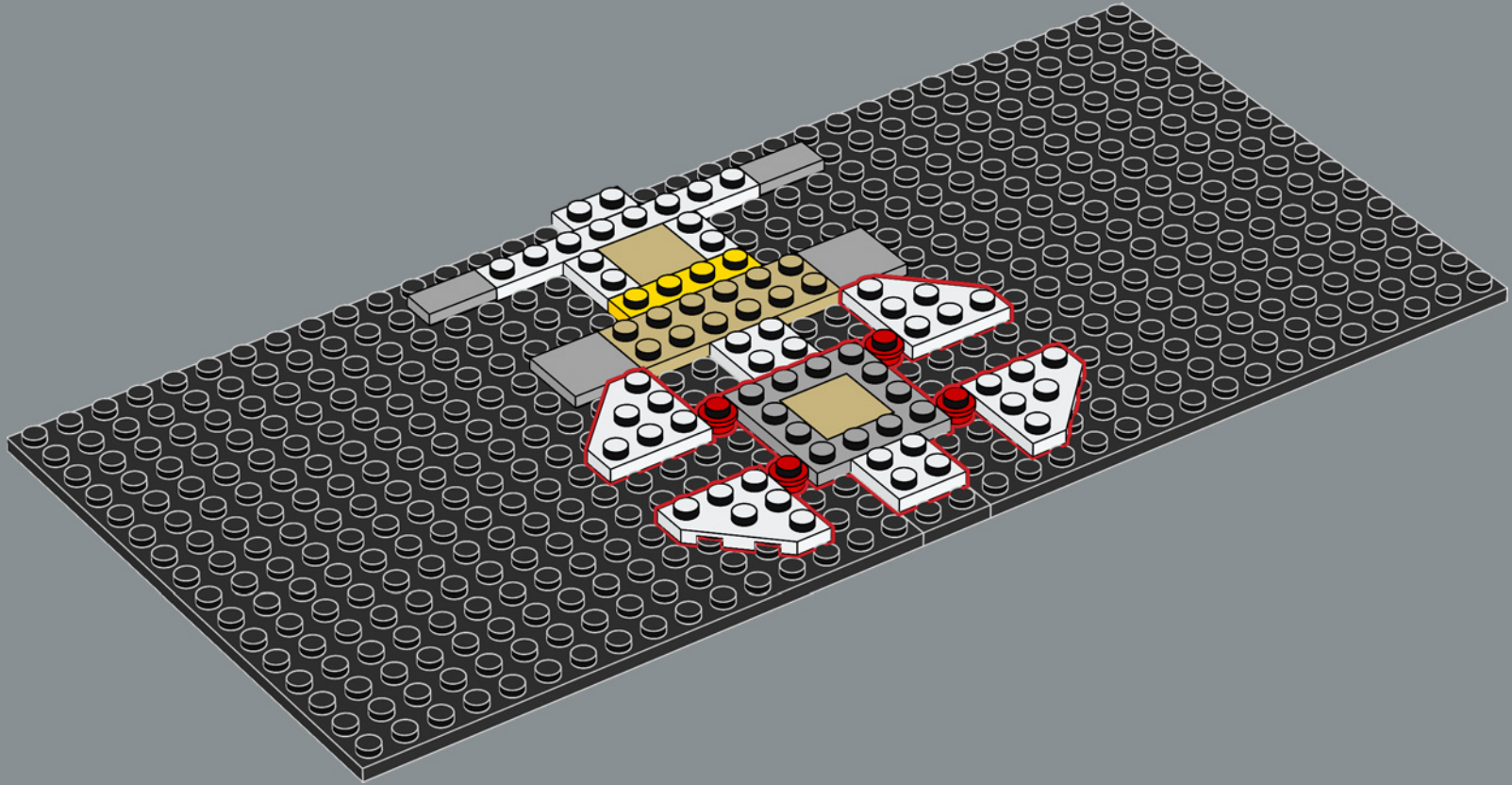

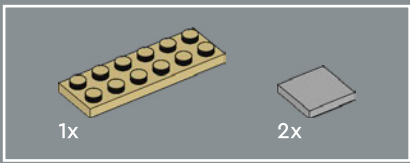

6

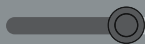
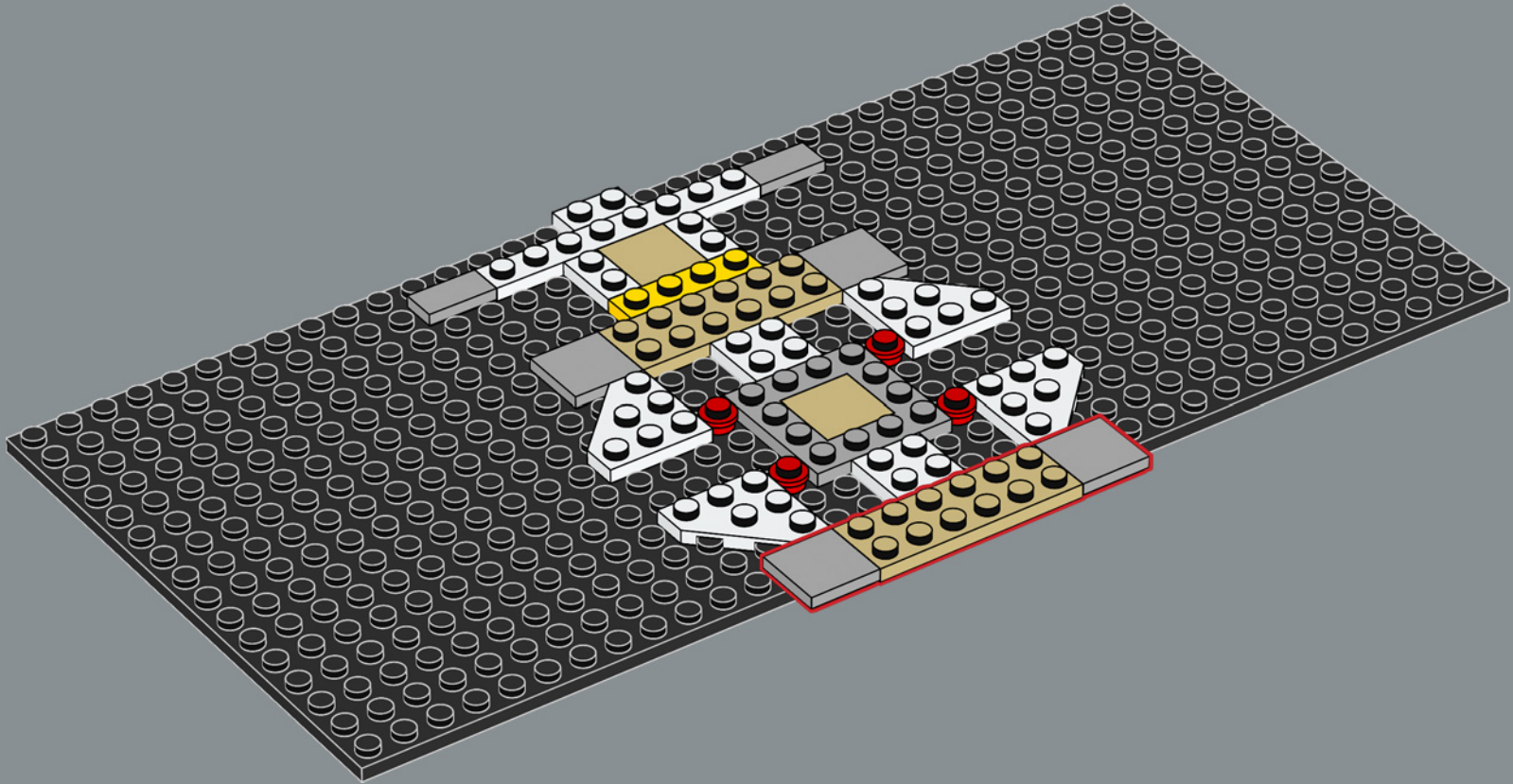

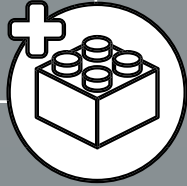
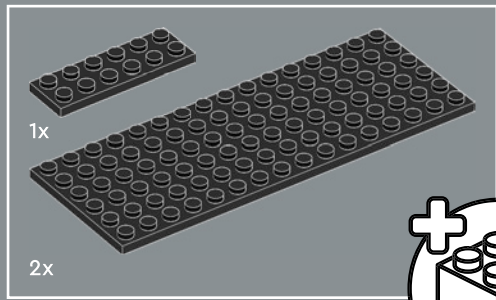

7

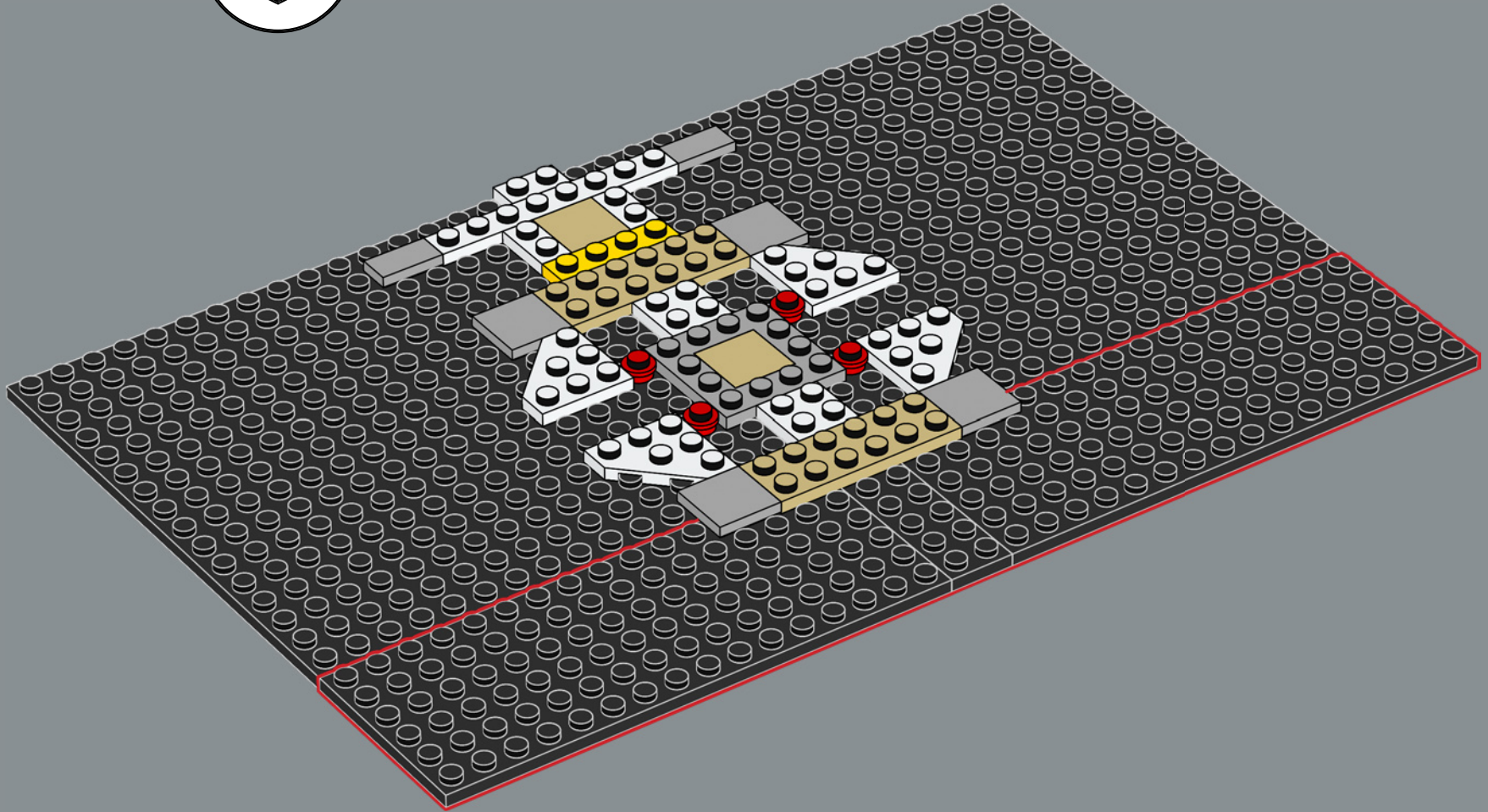

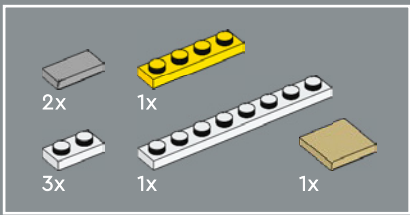

8

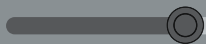
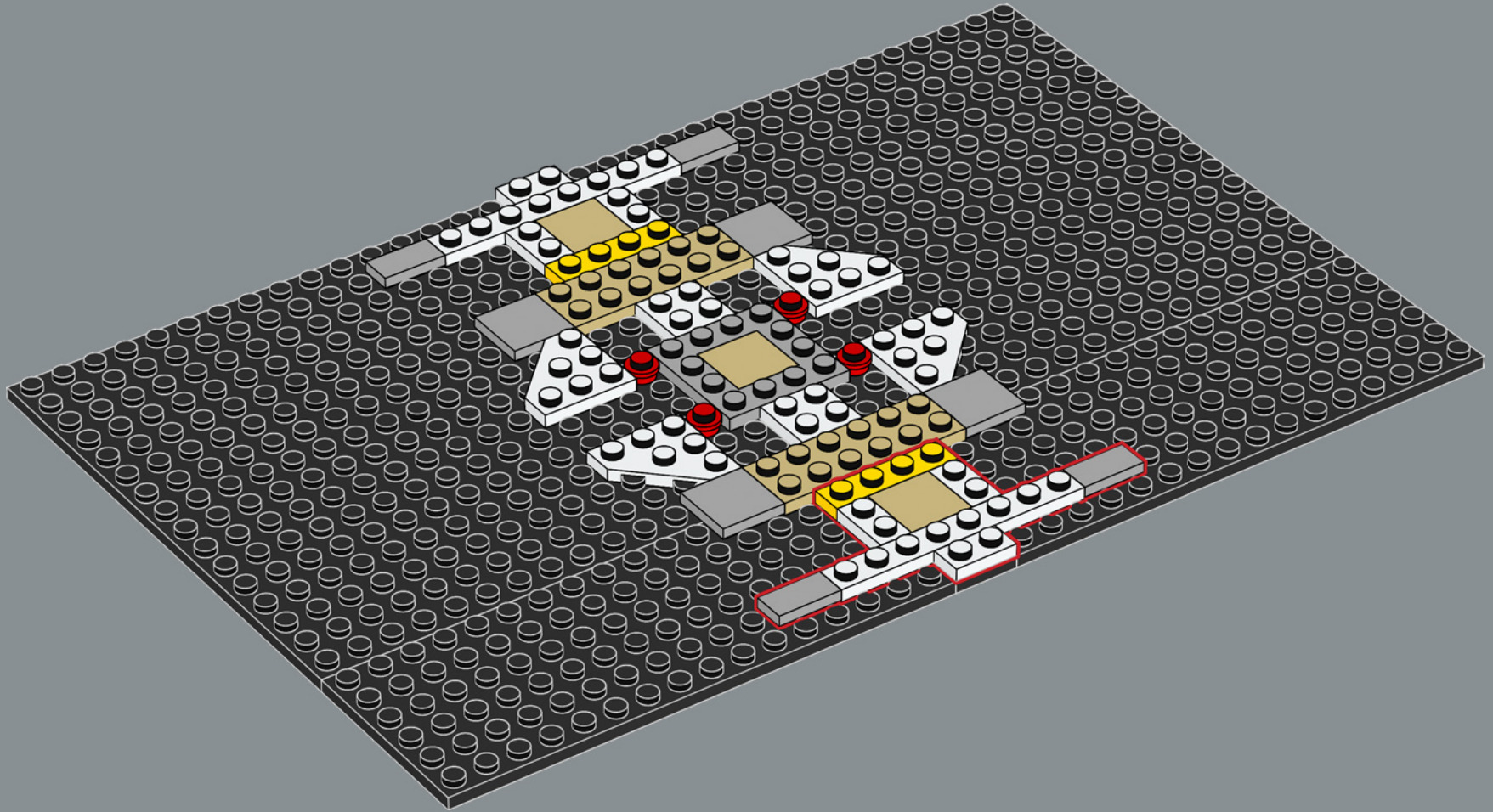

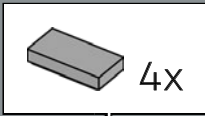
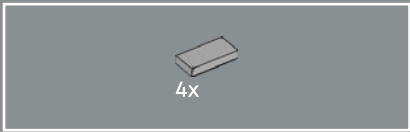

9

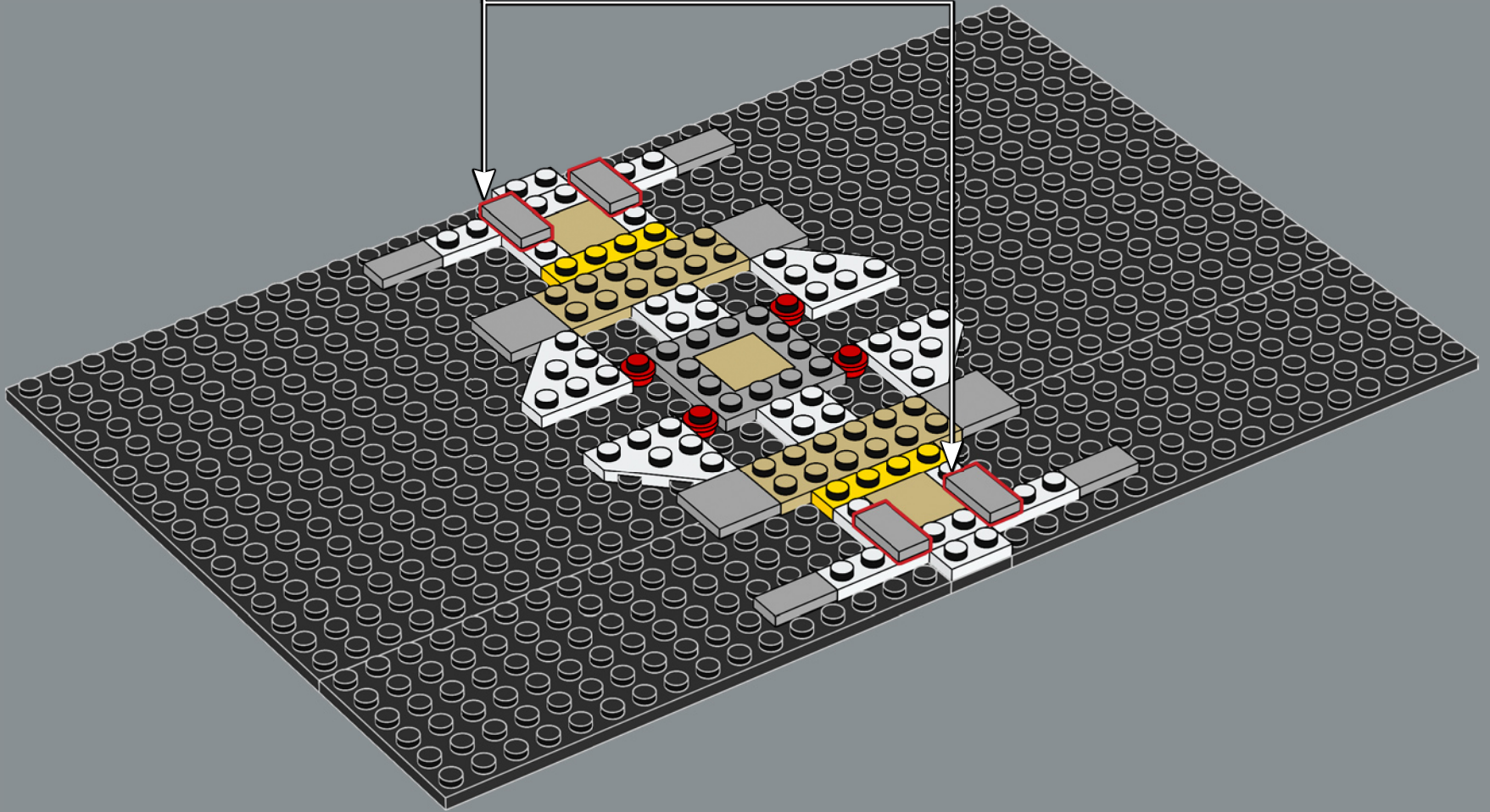

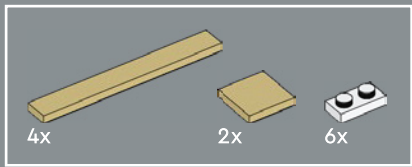

10

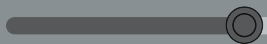
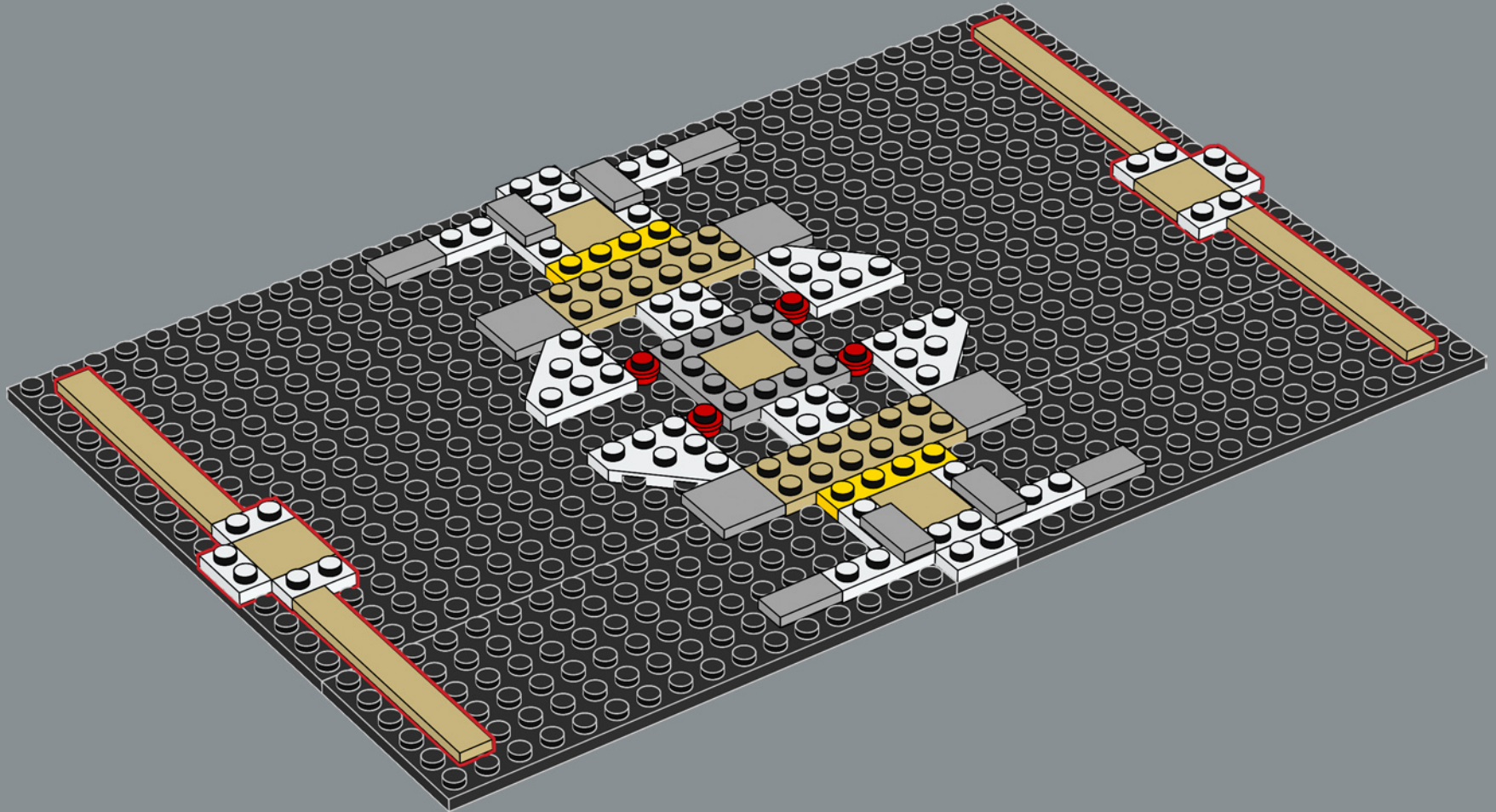

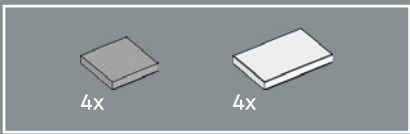

11

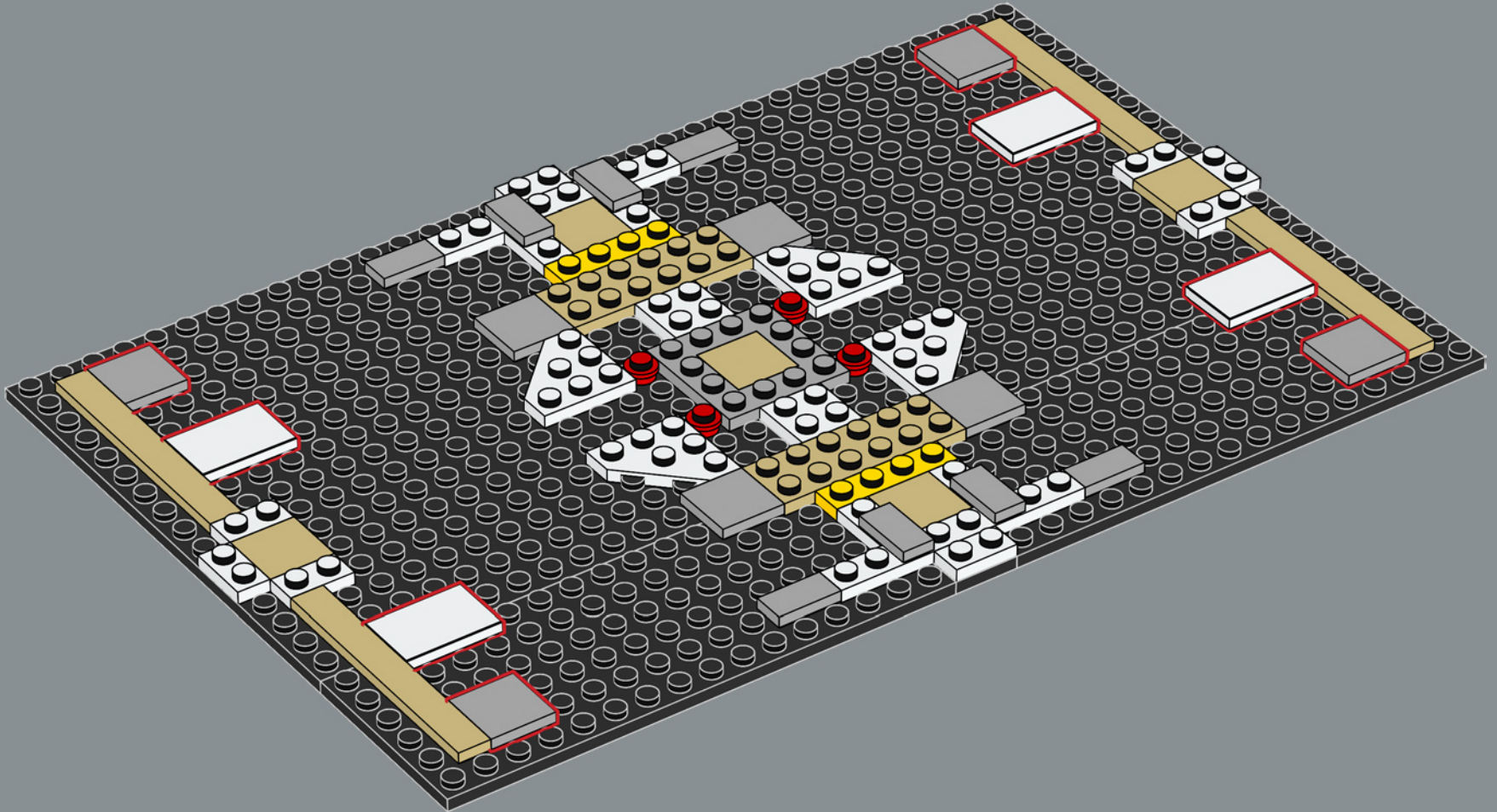

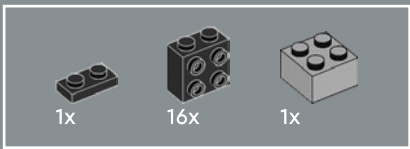

12

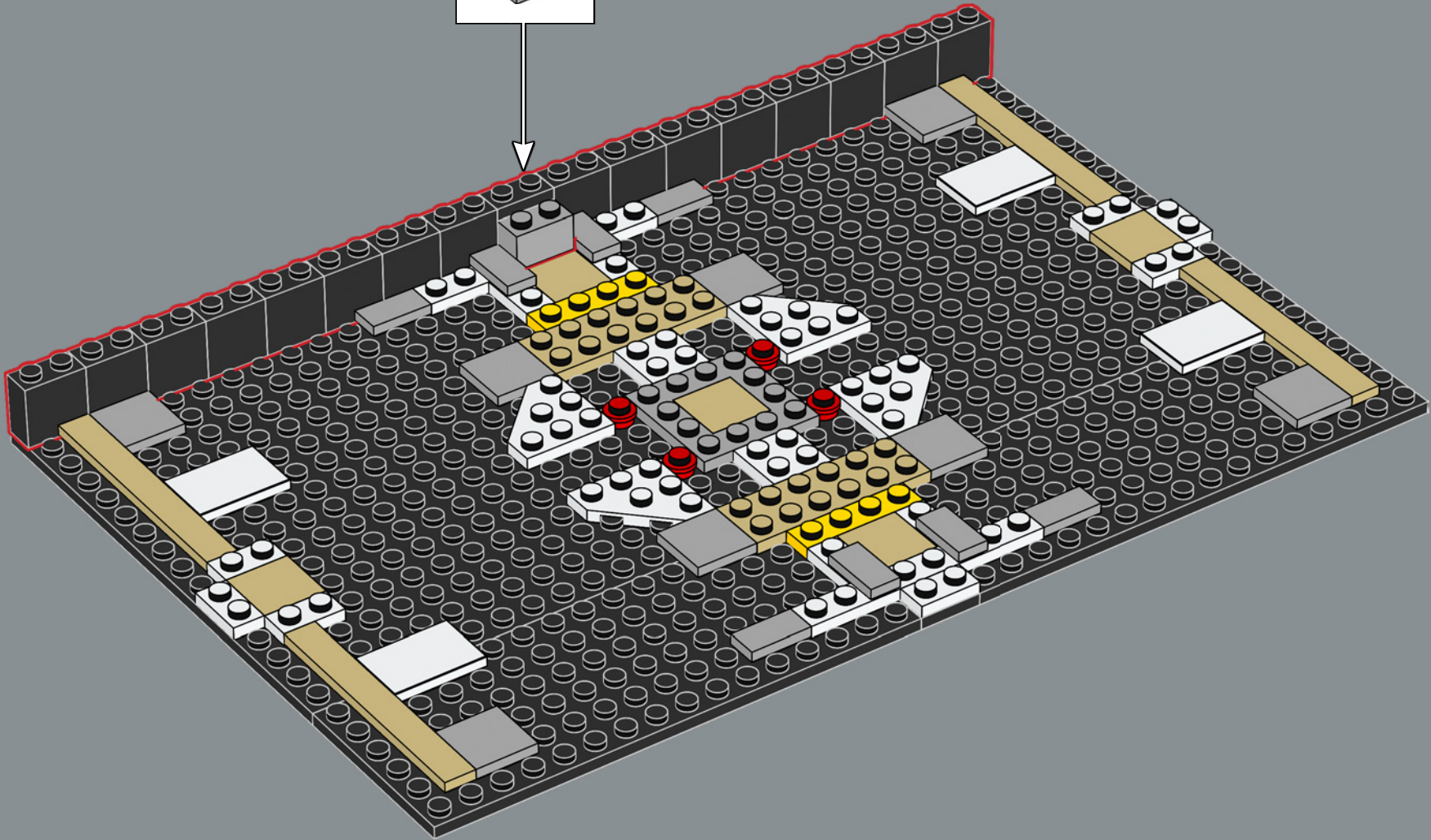
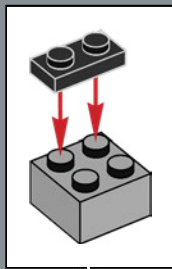

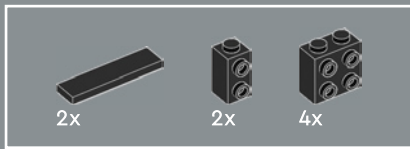

13

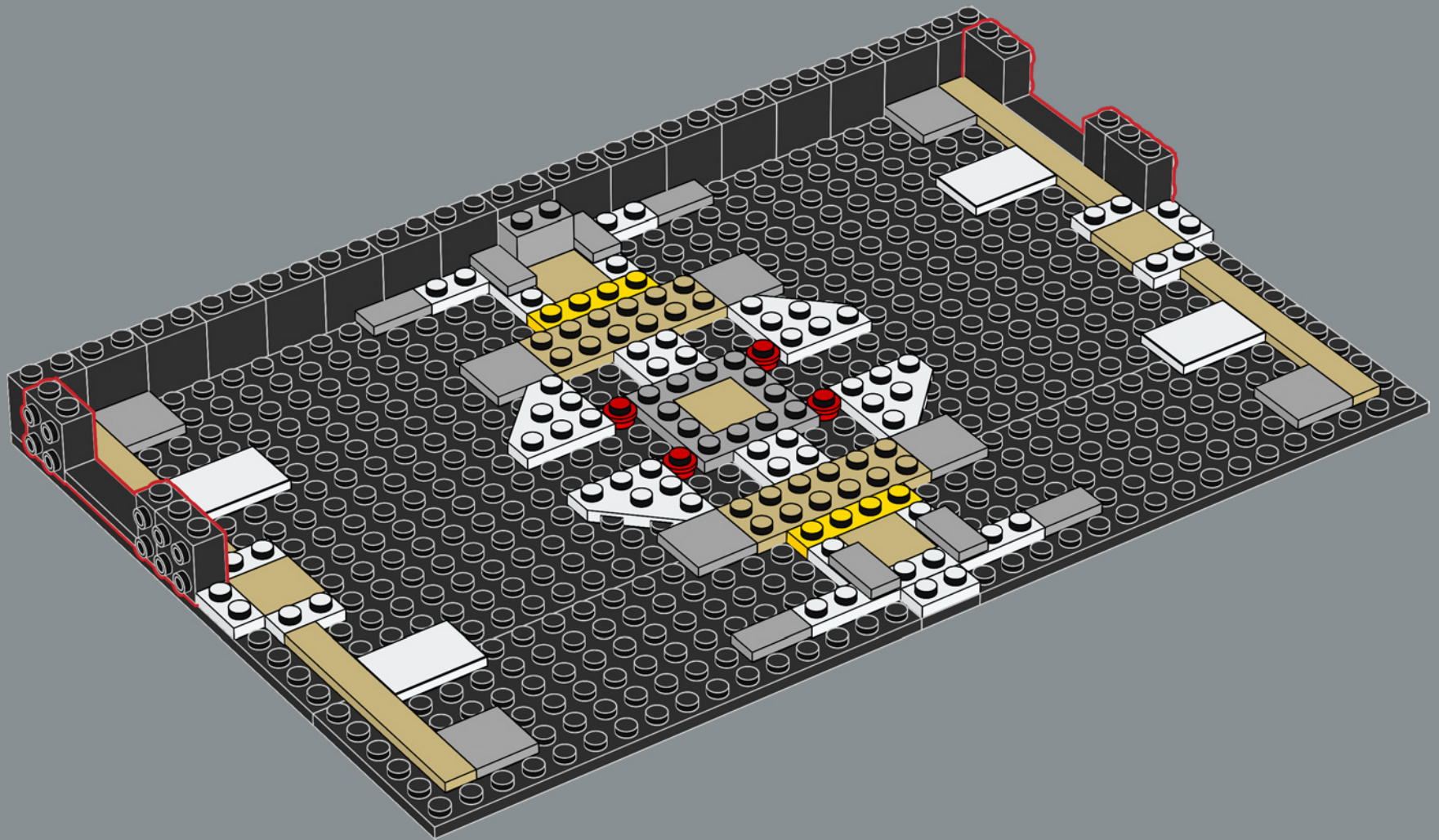

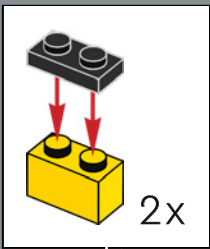
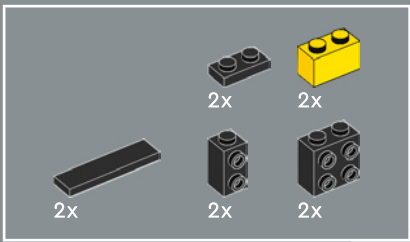

14

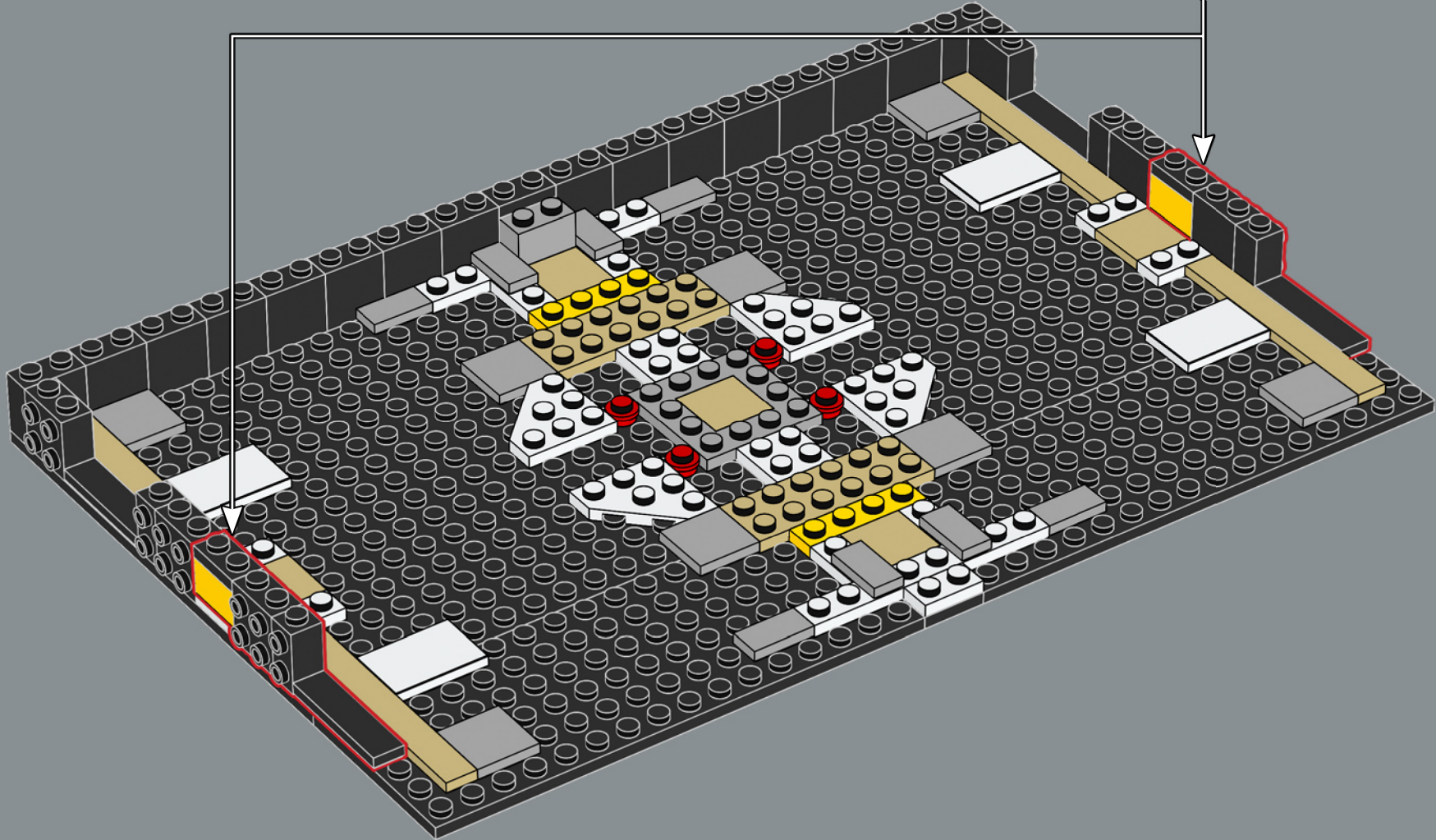

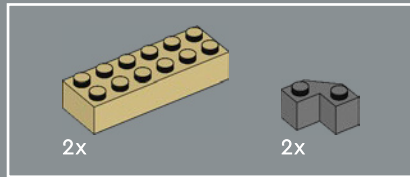

15

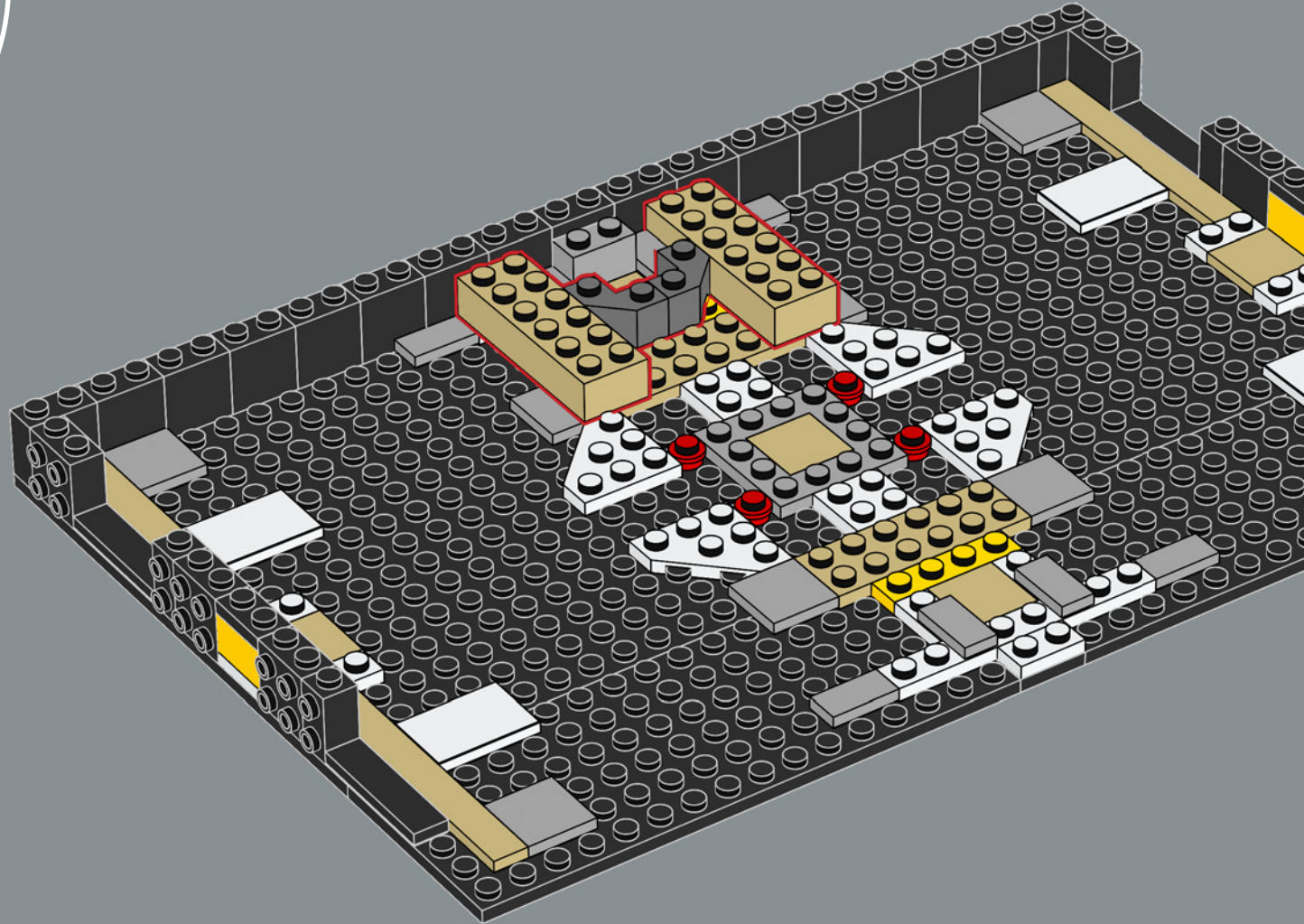

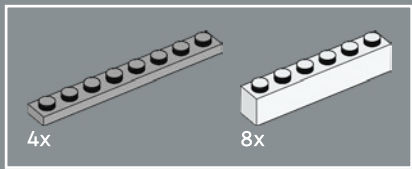

16

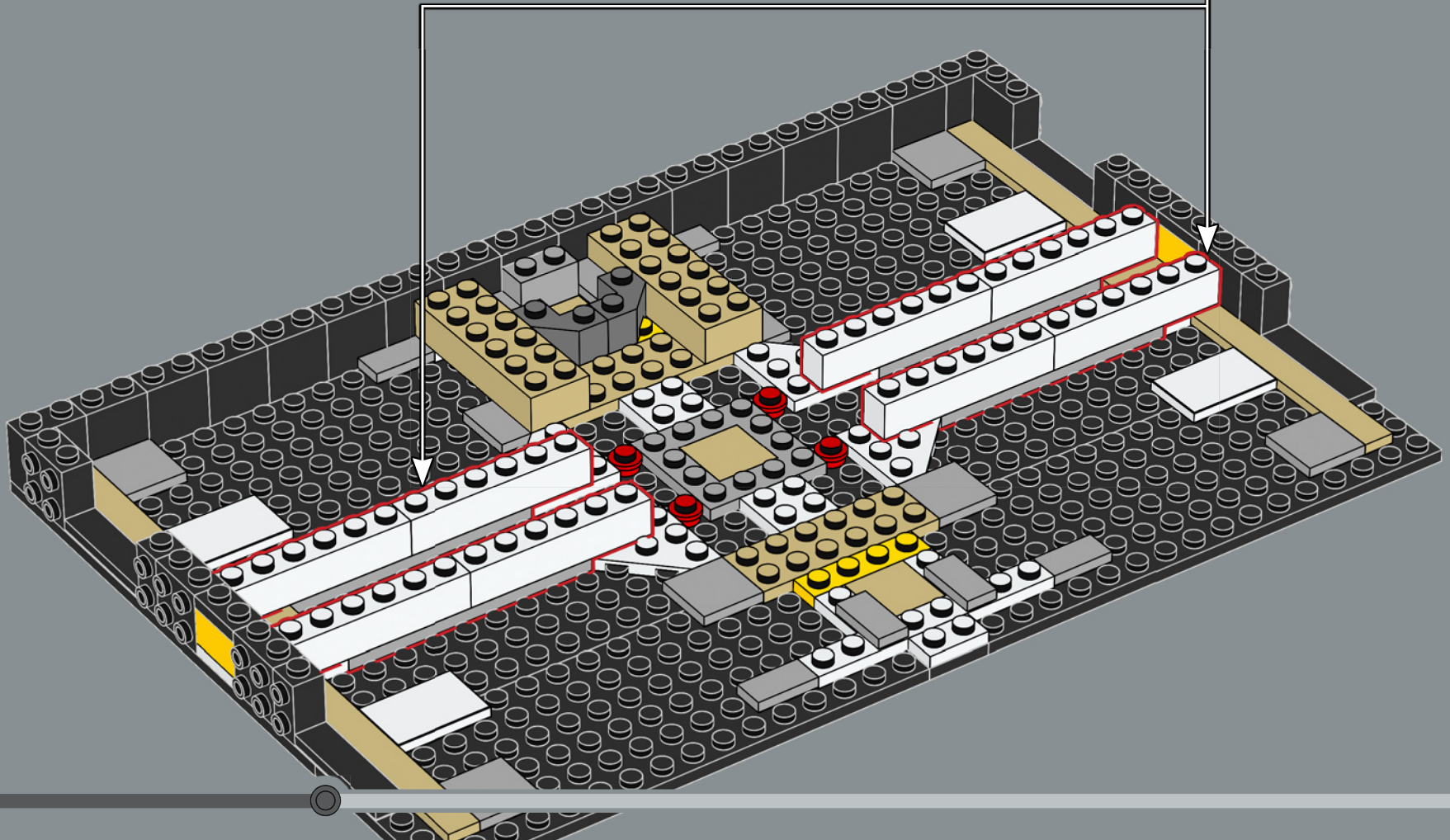
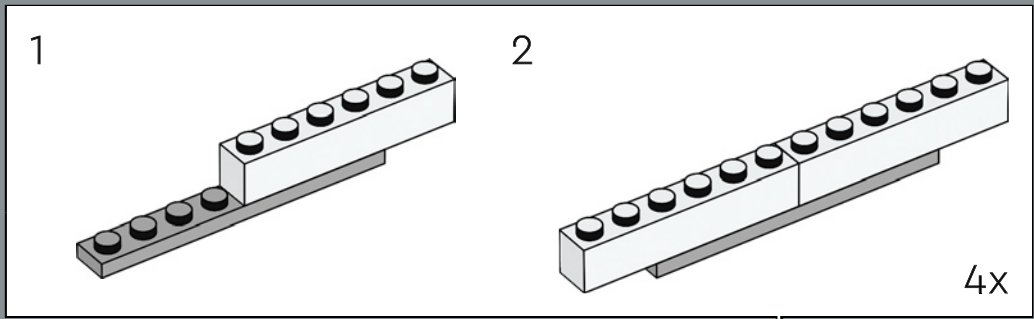

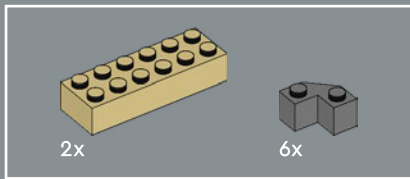

17

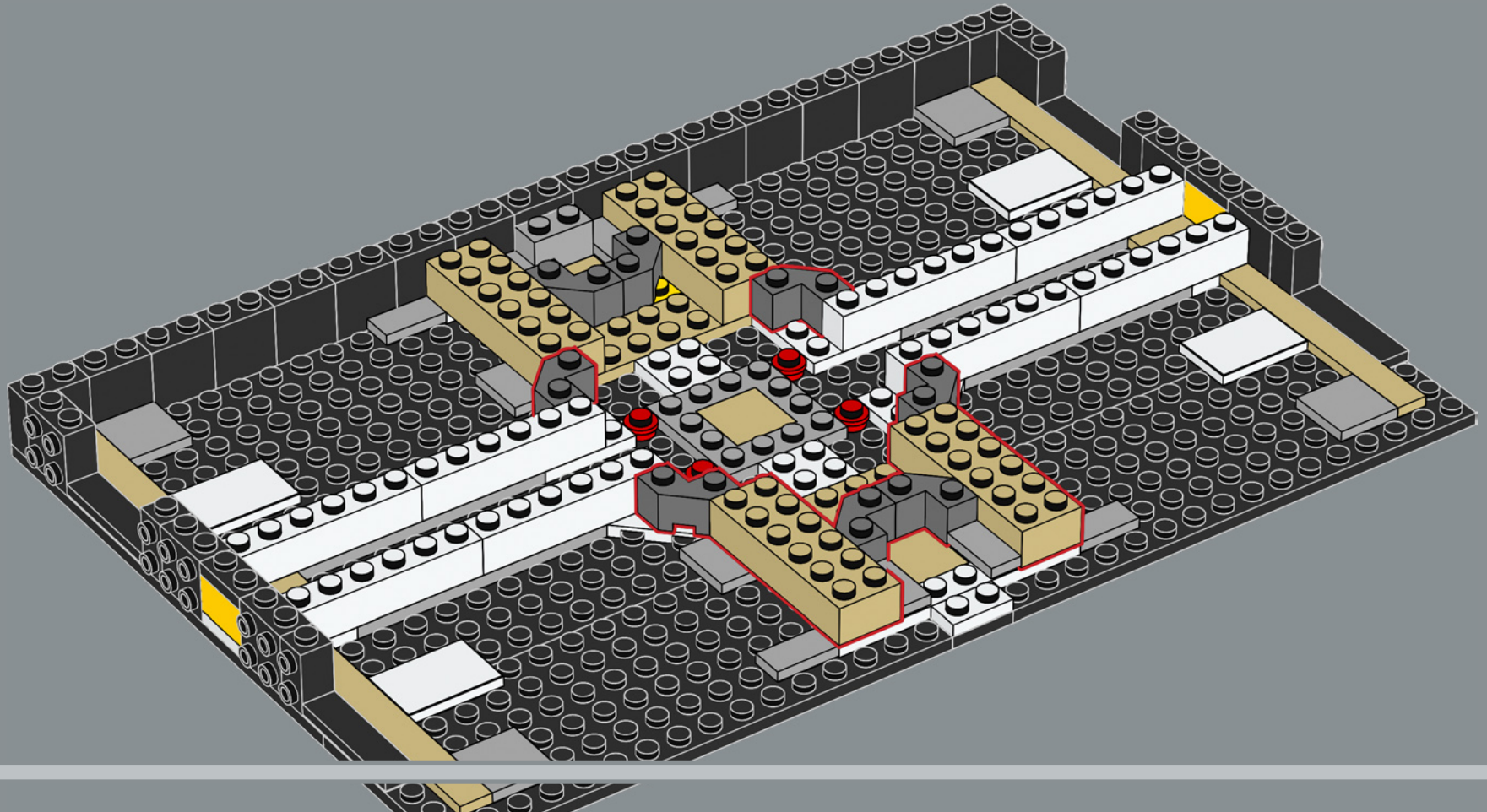

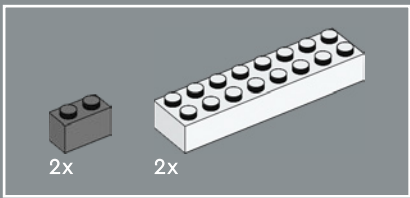

18

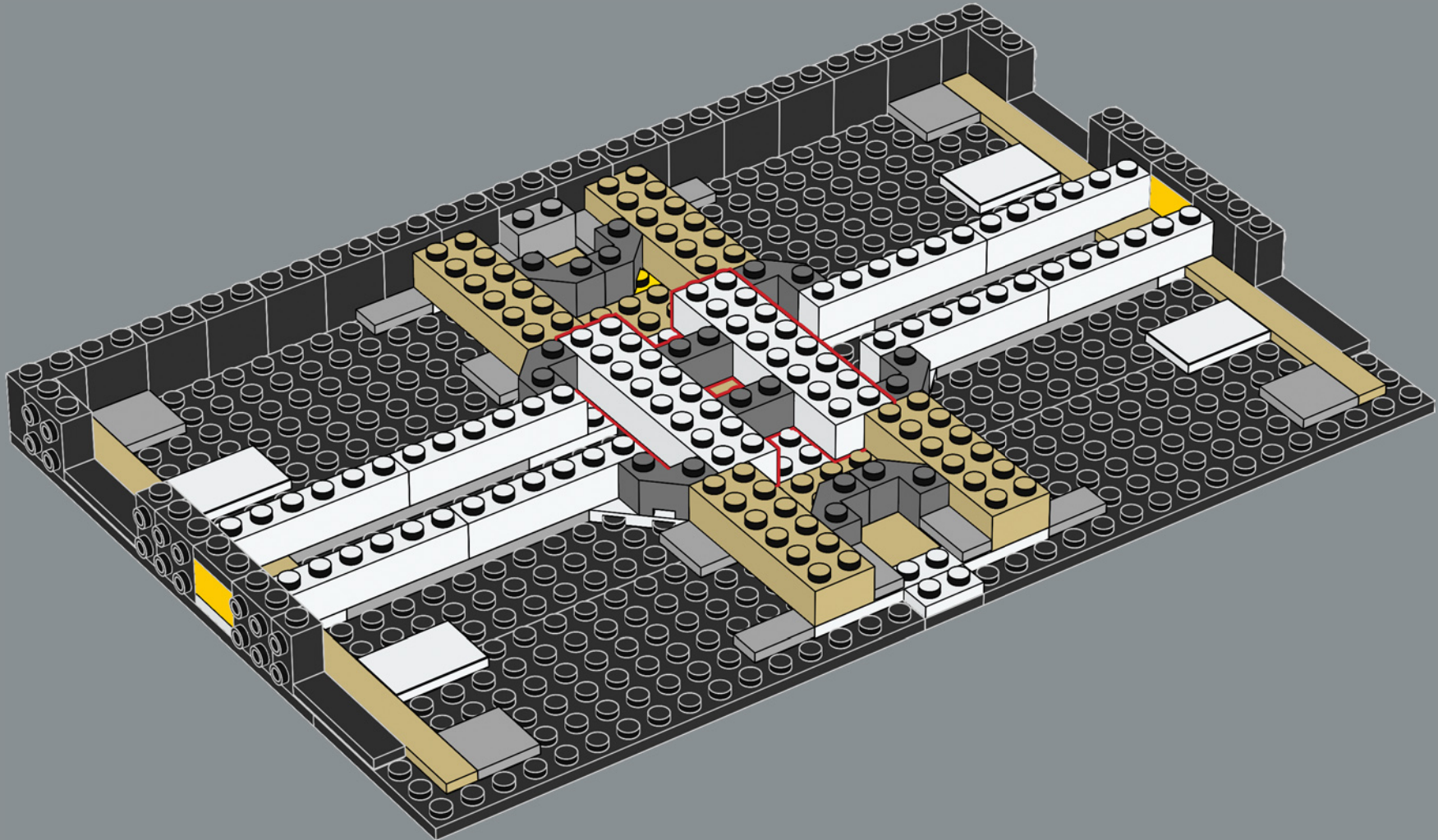

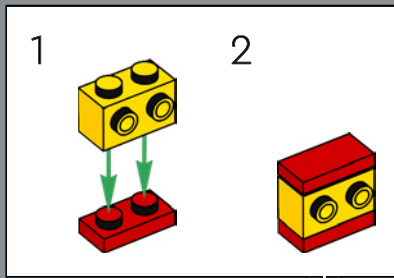
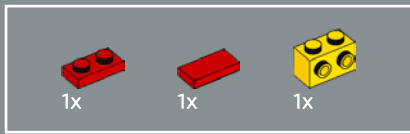

19

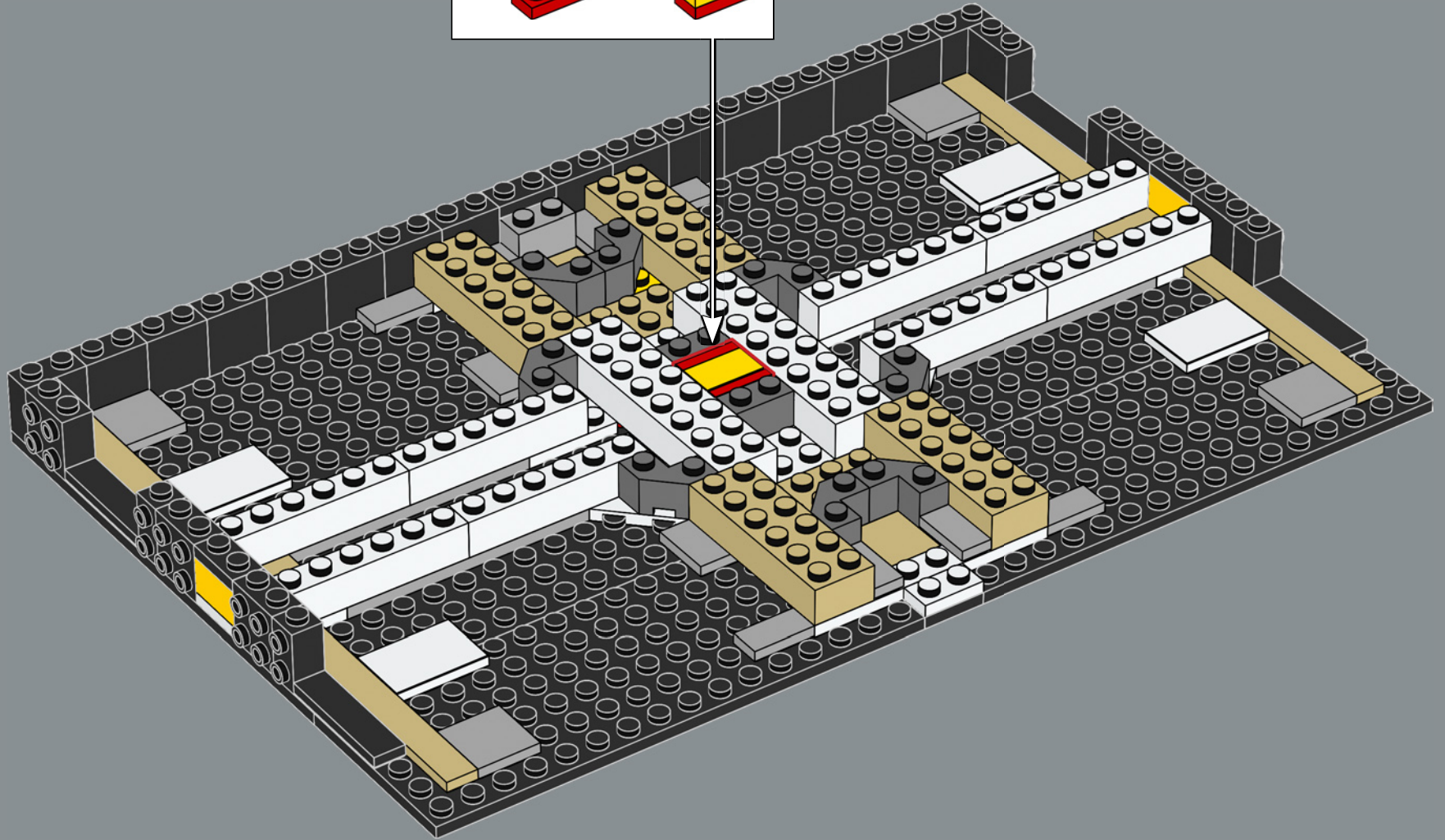



20

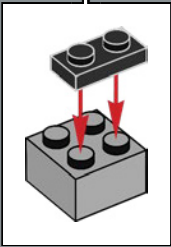
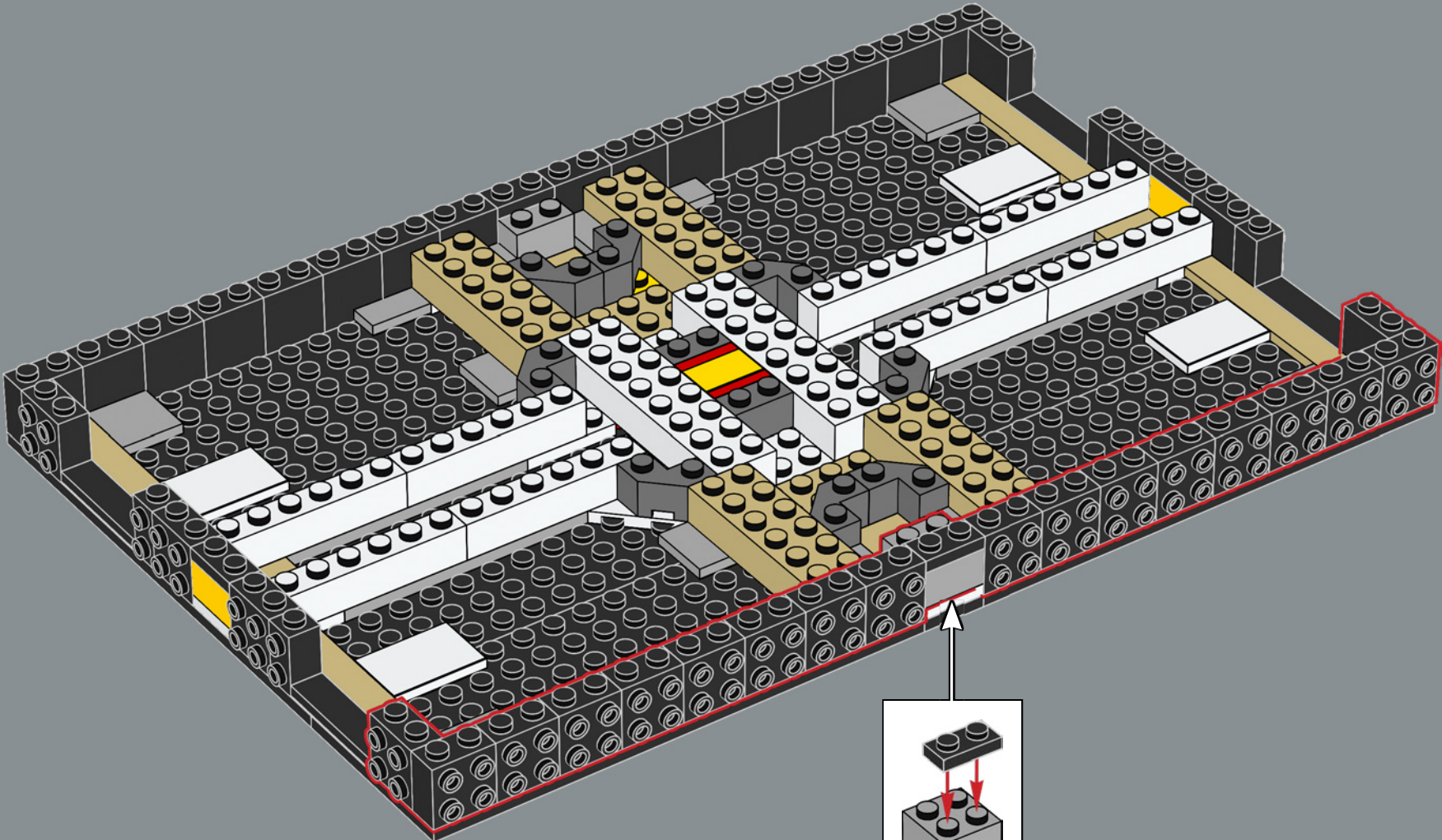

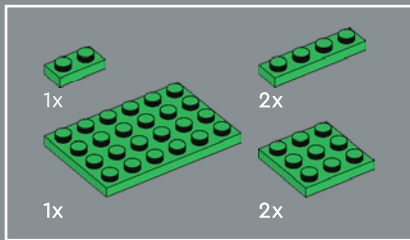

21

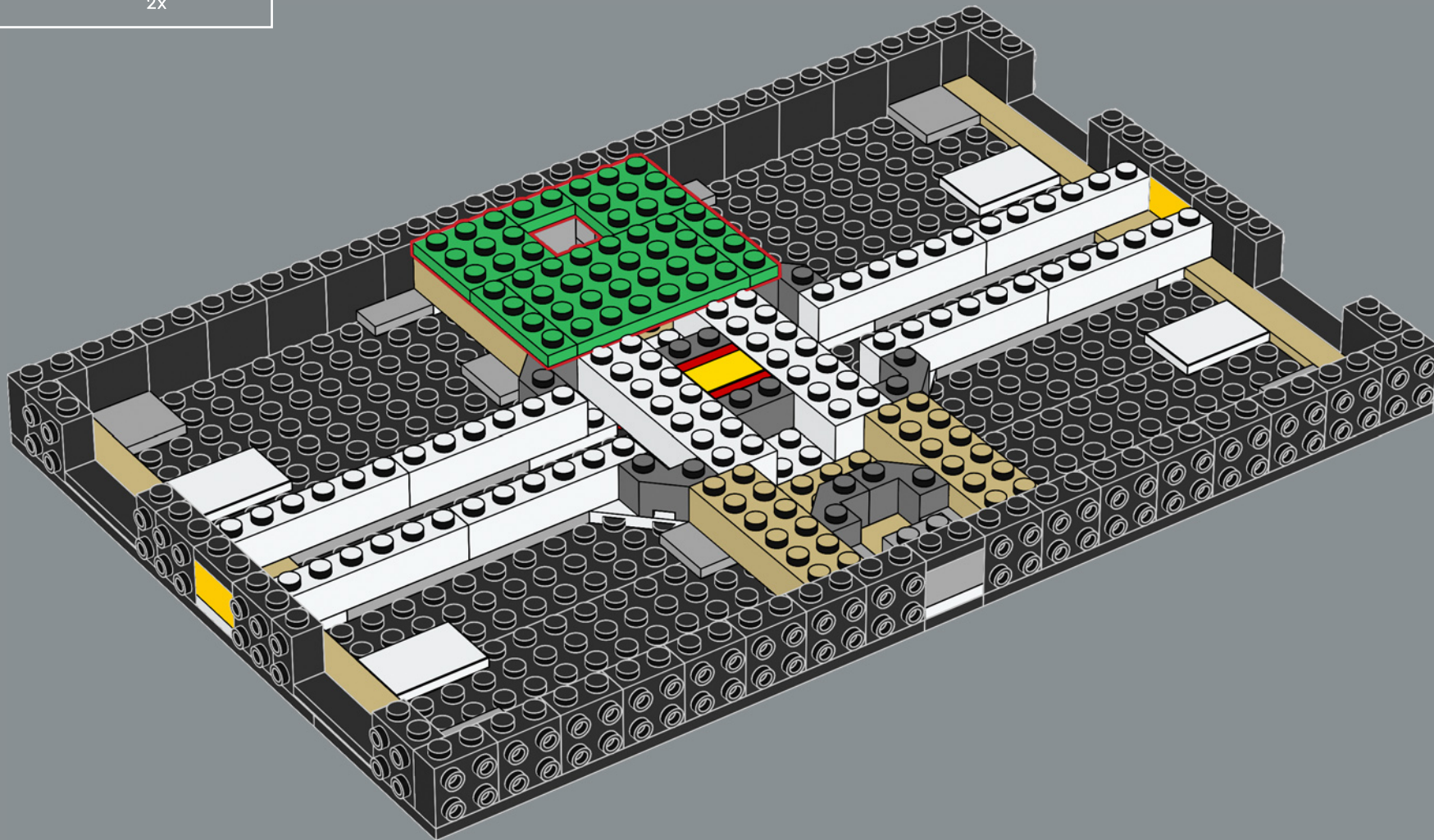

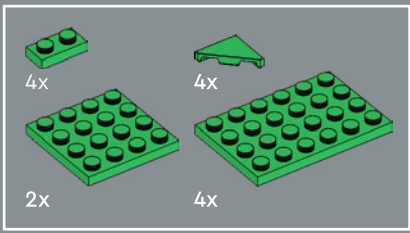

22

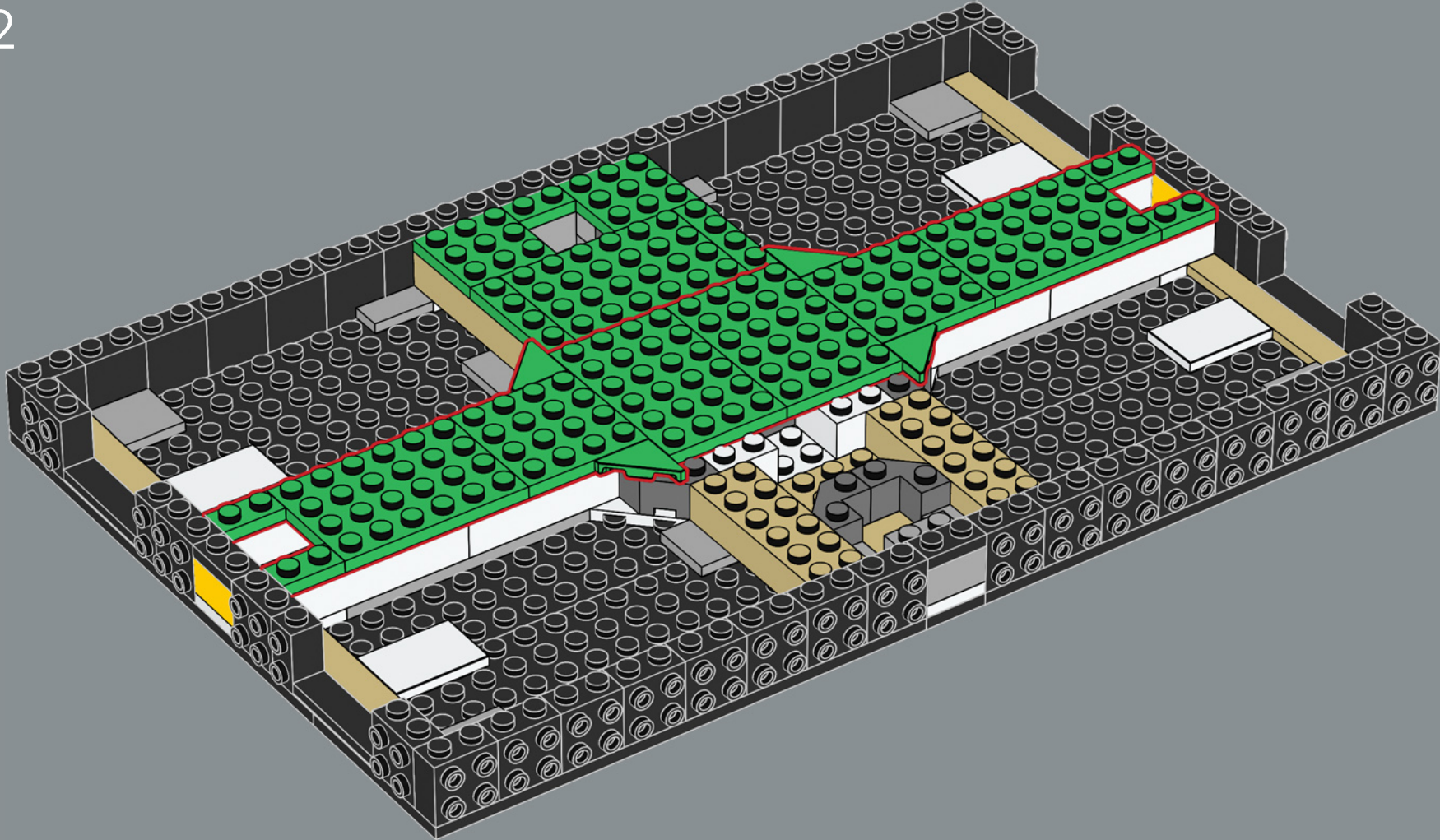

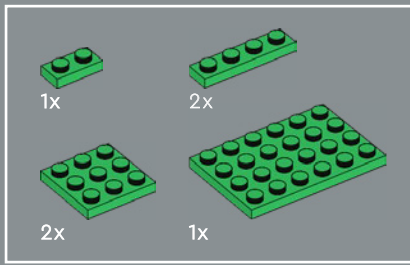

23

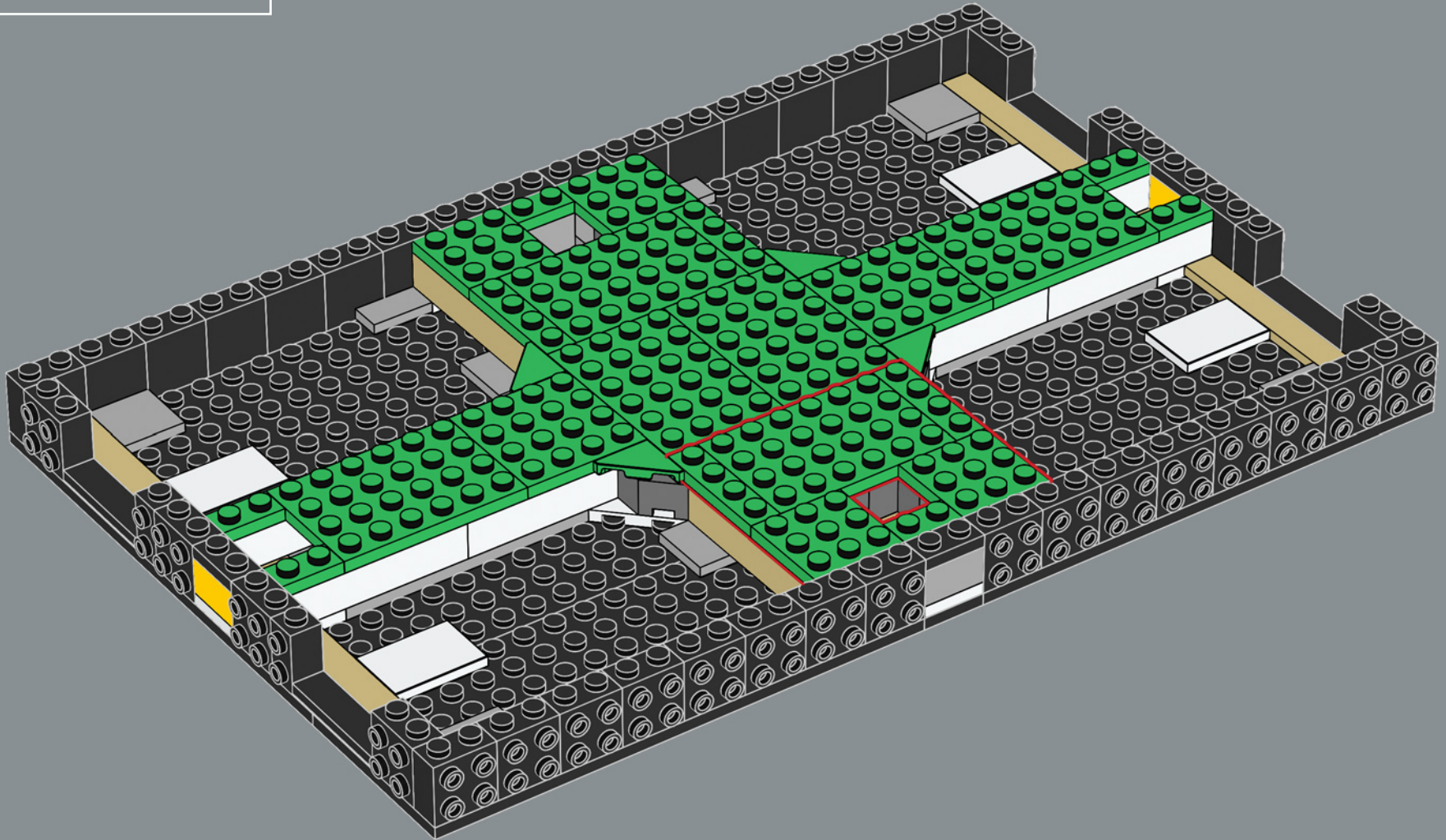



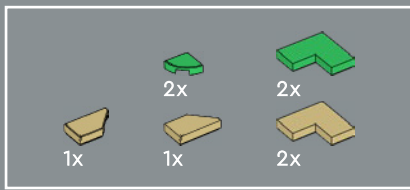

24

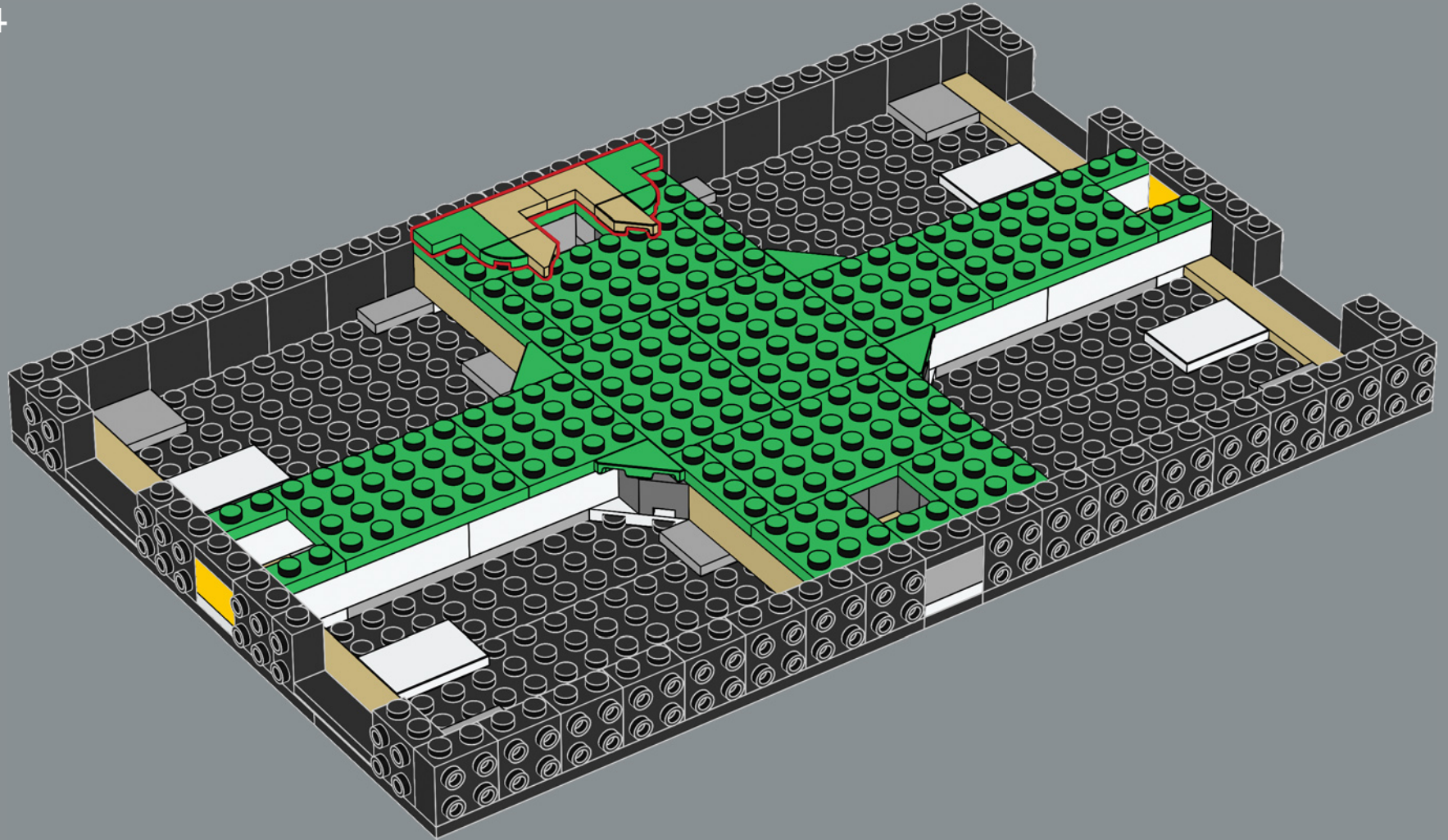



25

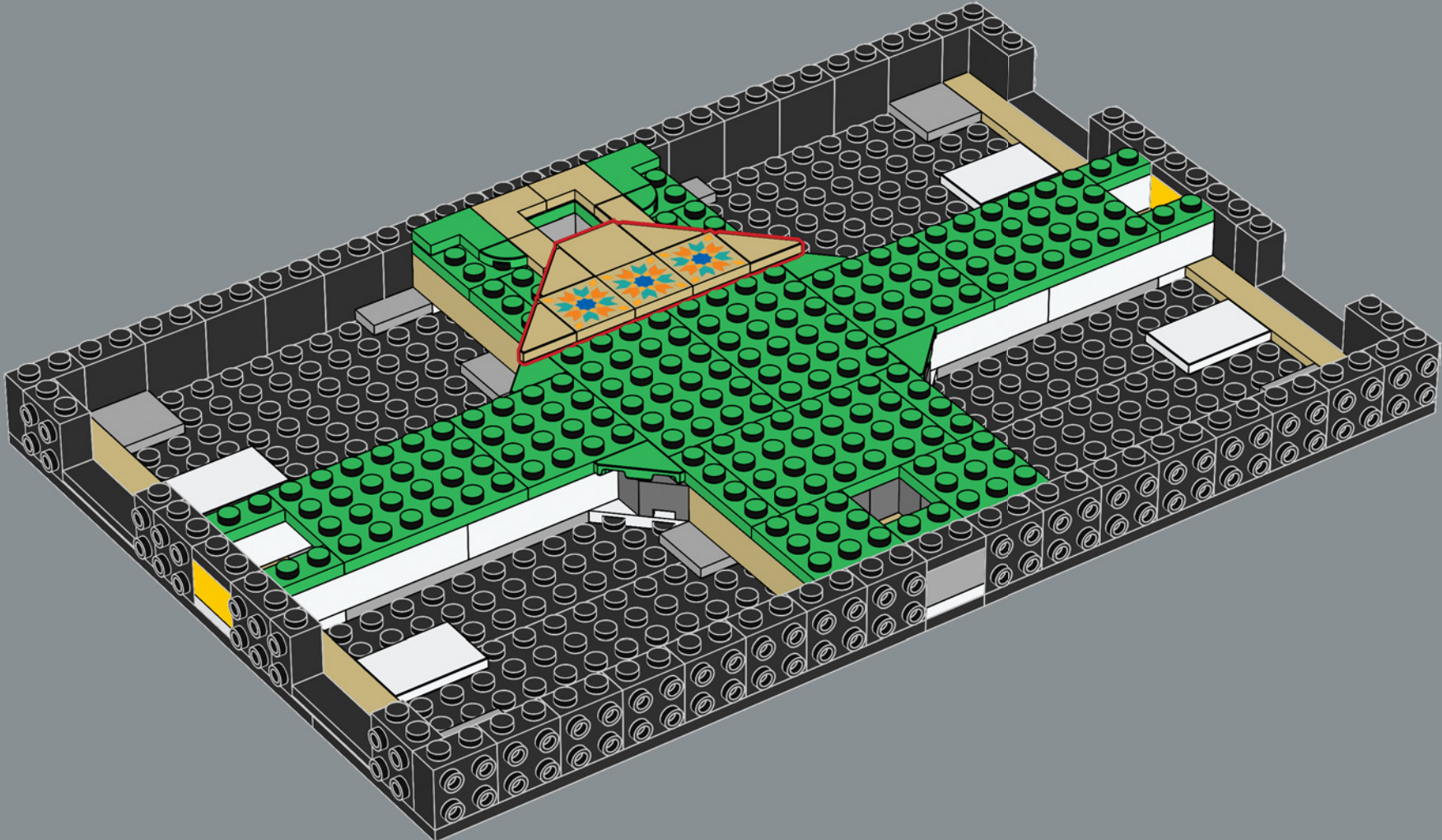

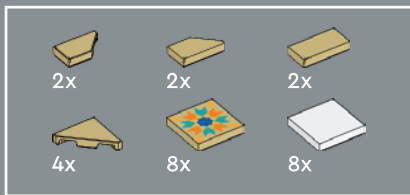

26

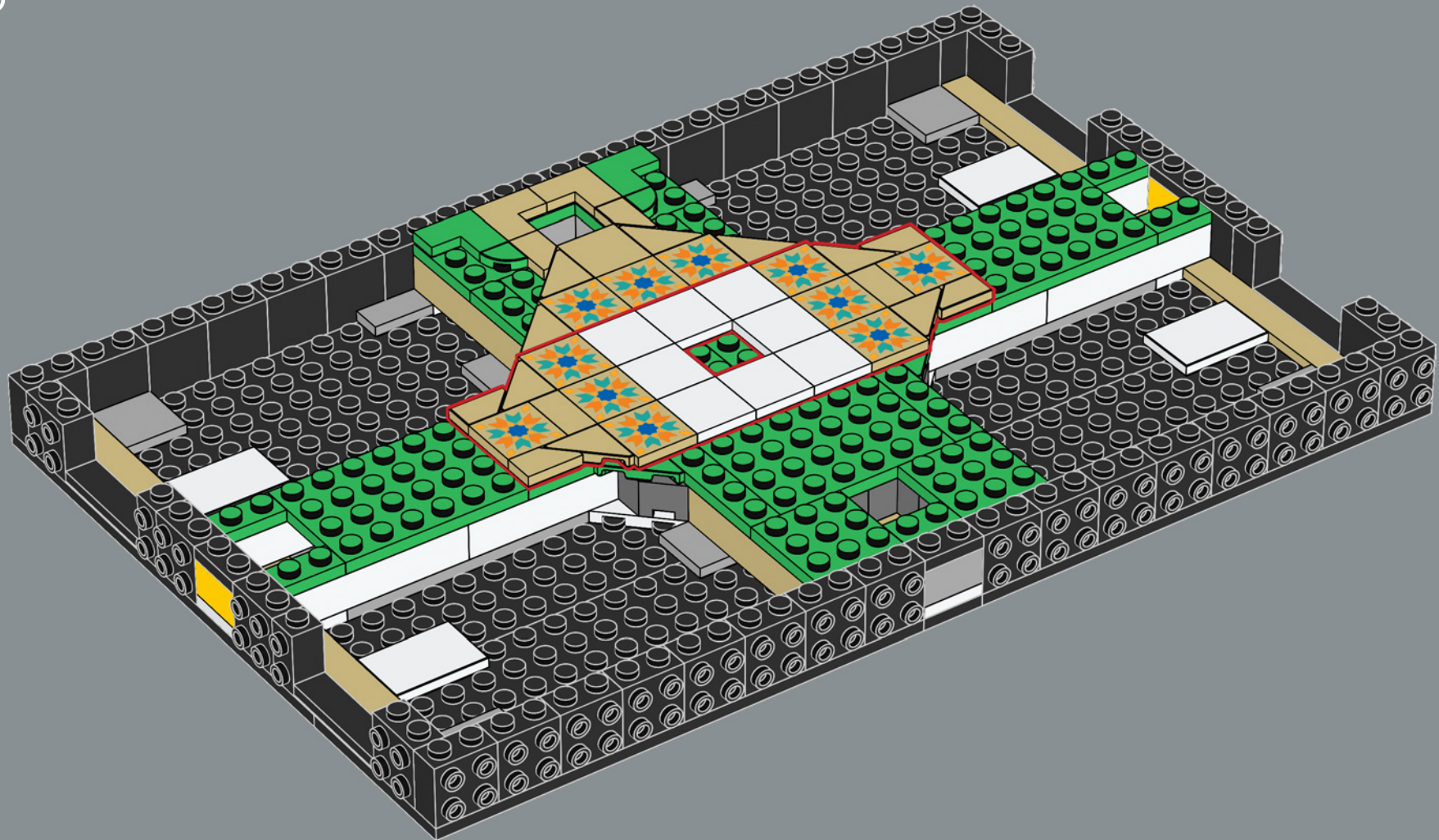



27

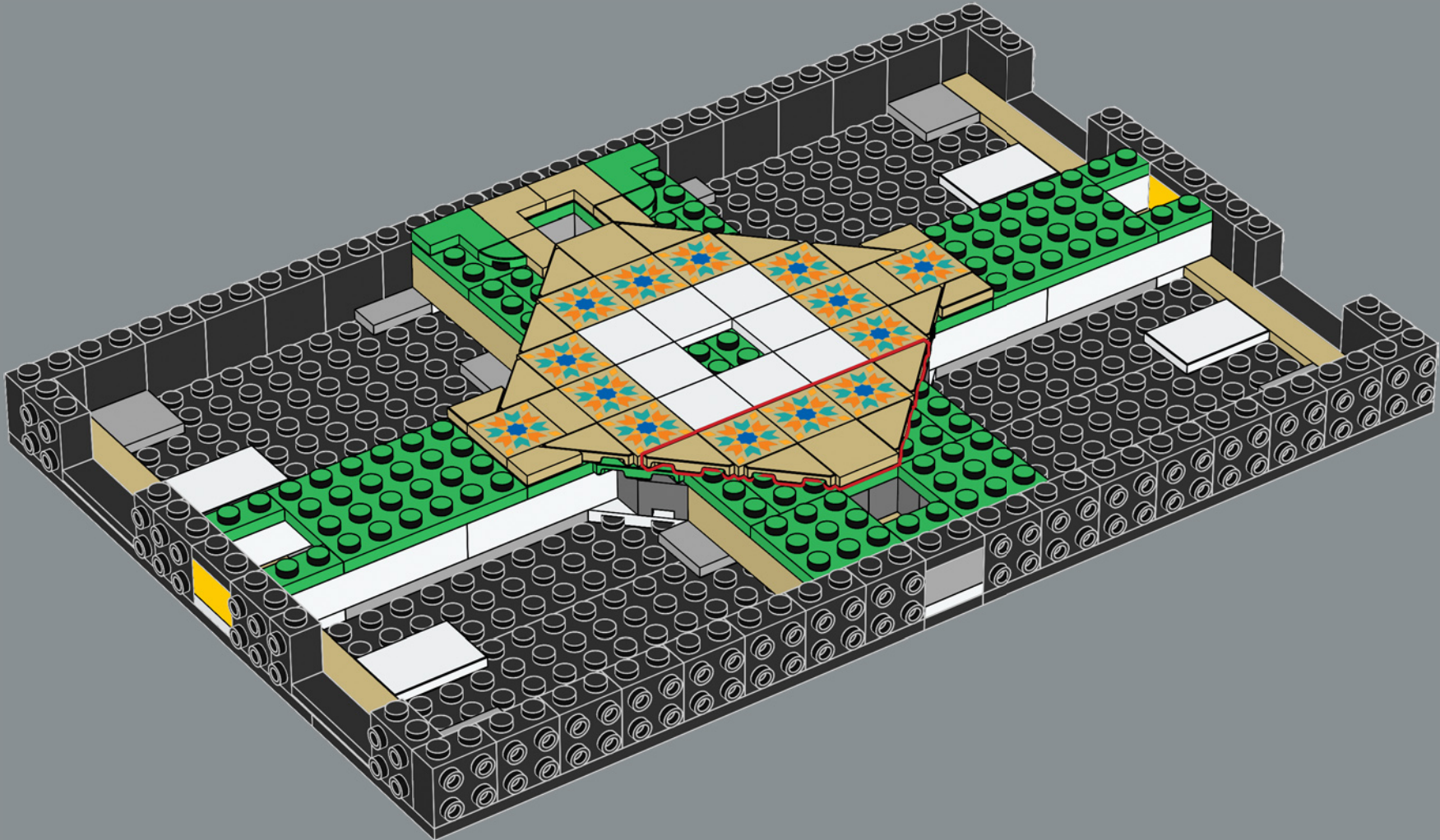

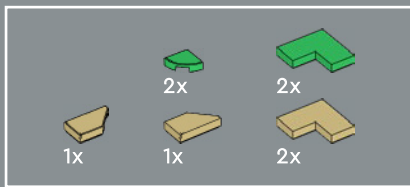

28

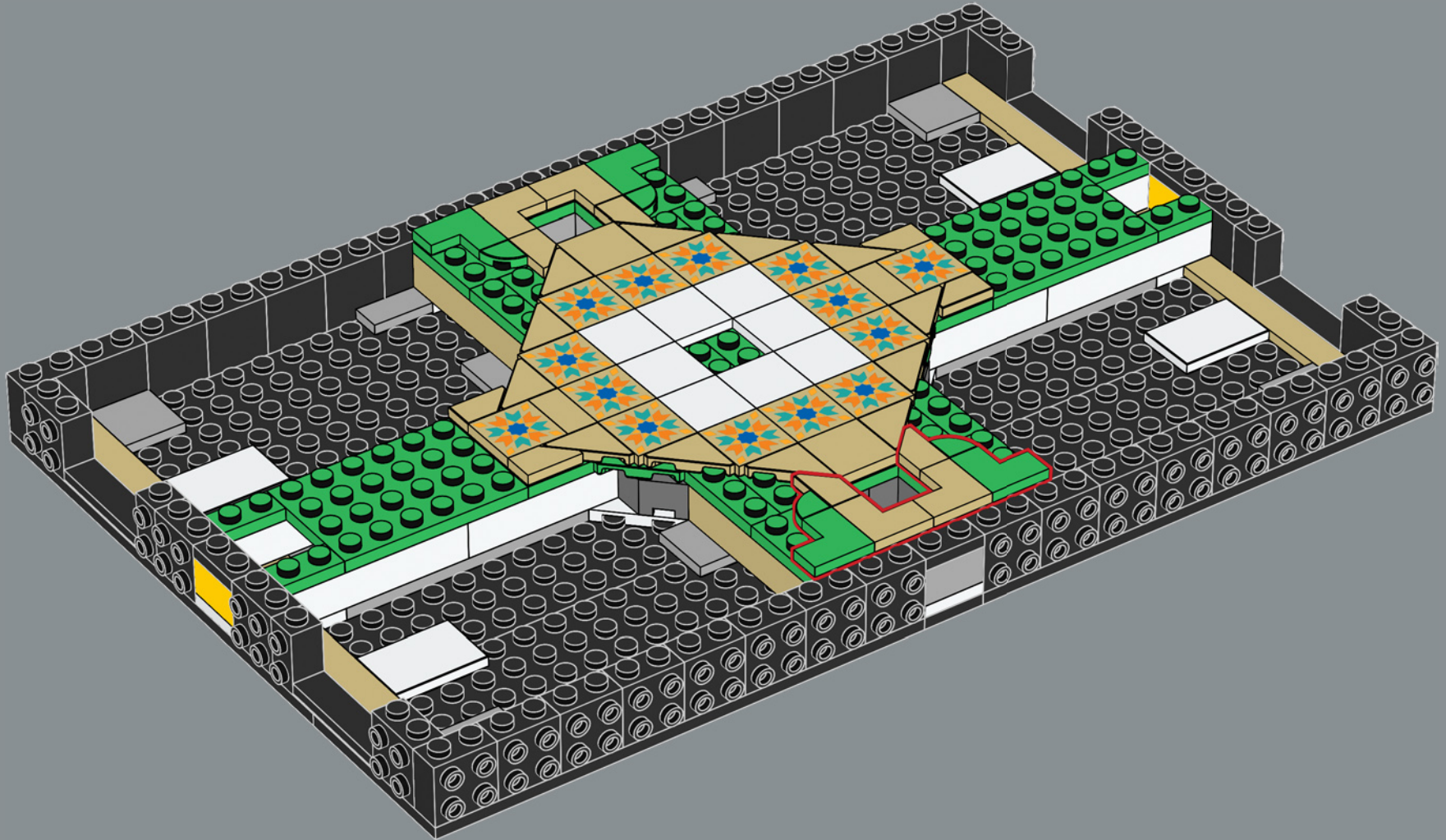

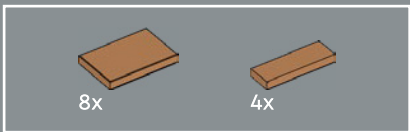

29

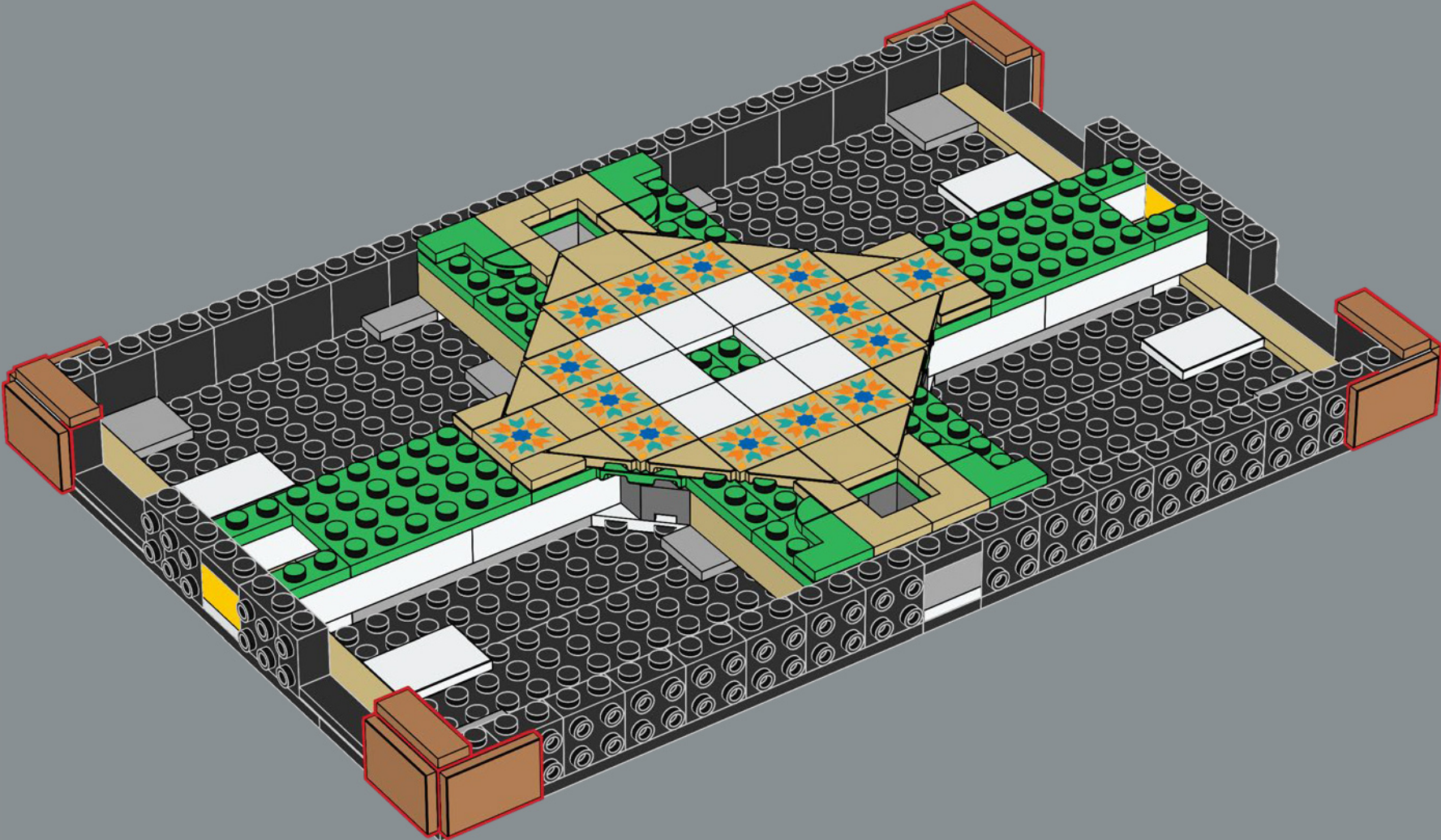



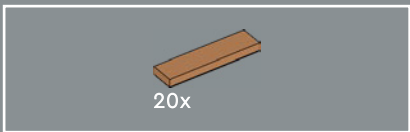

30

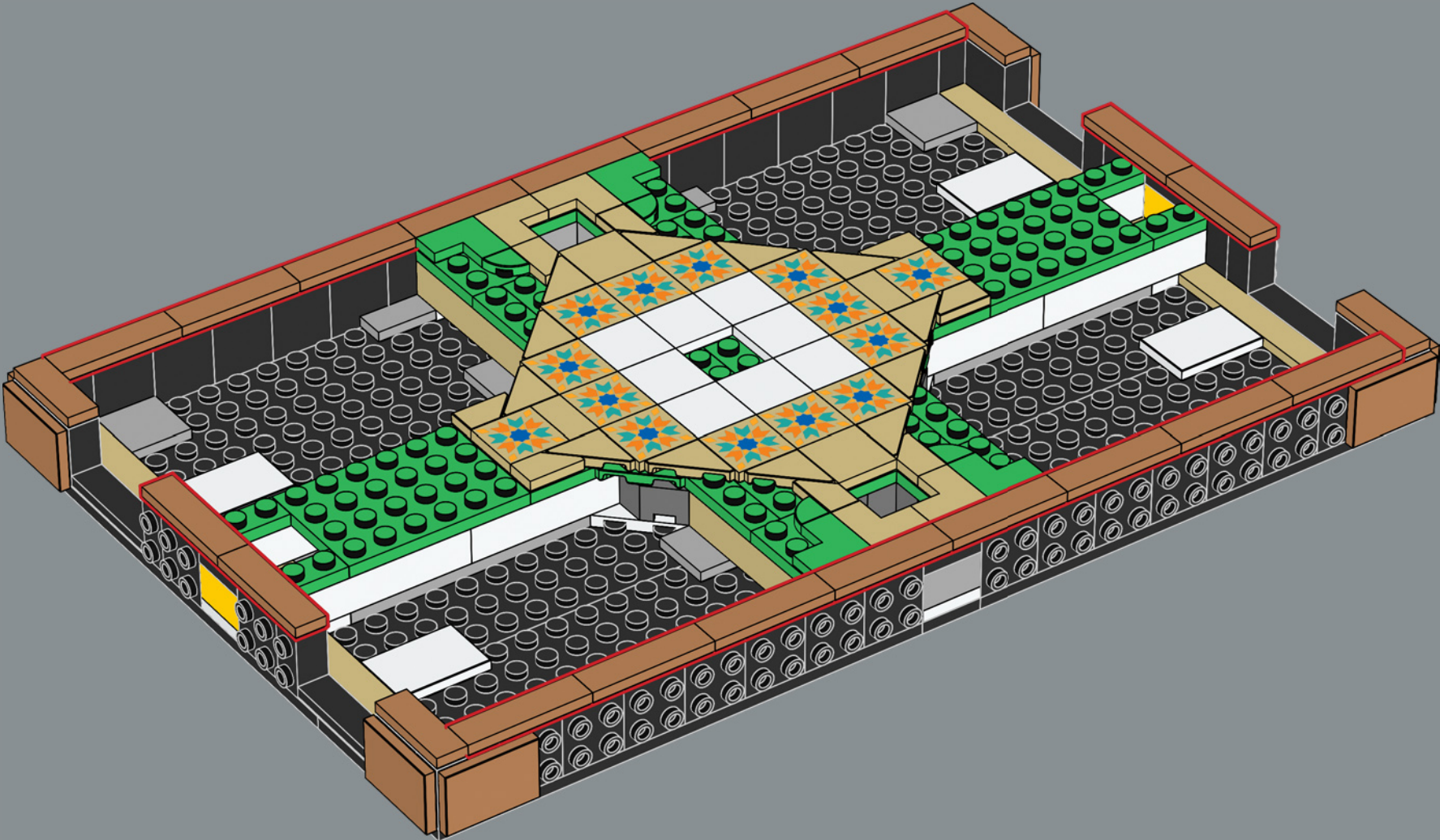

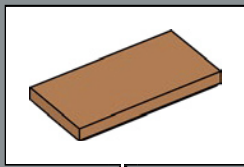

31

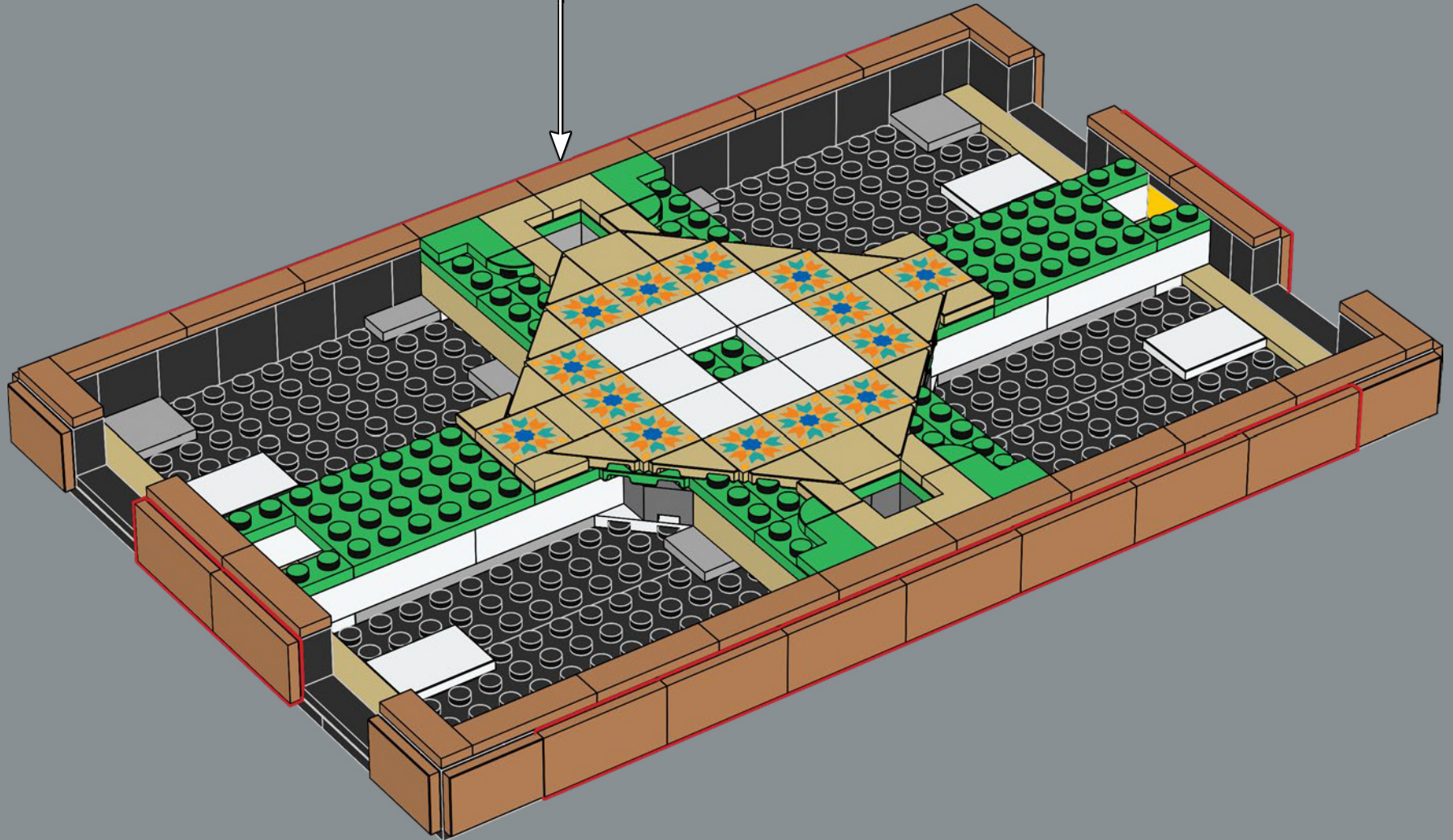

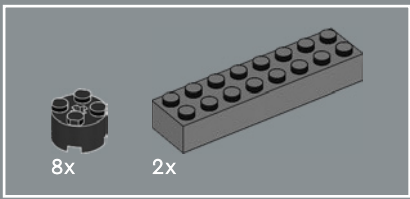

32

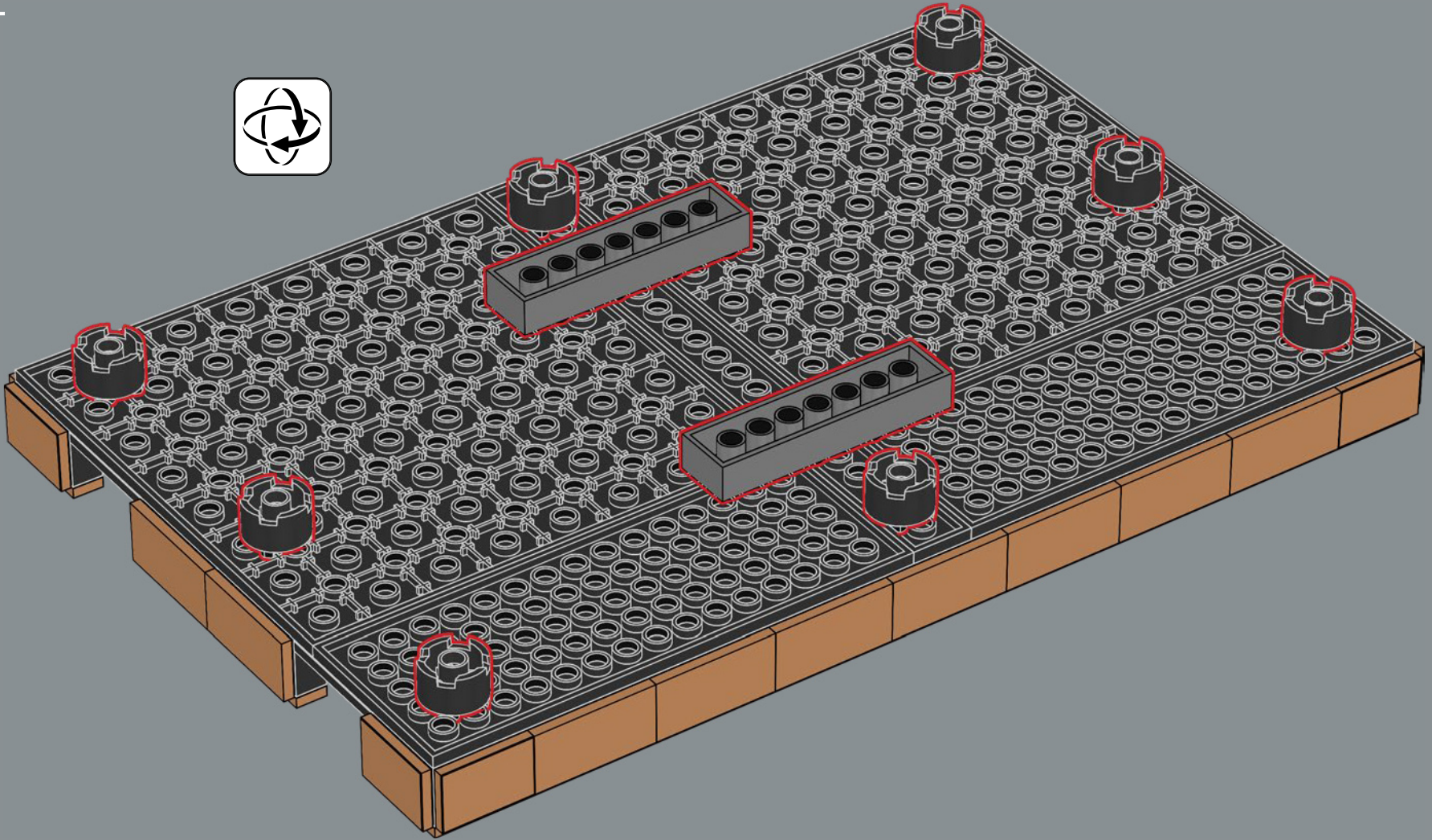

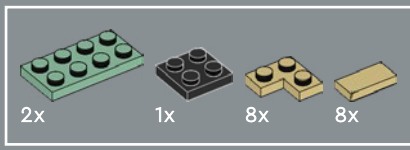

33

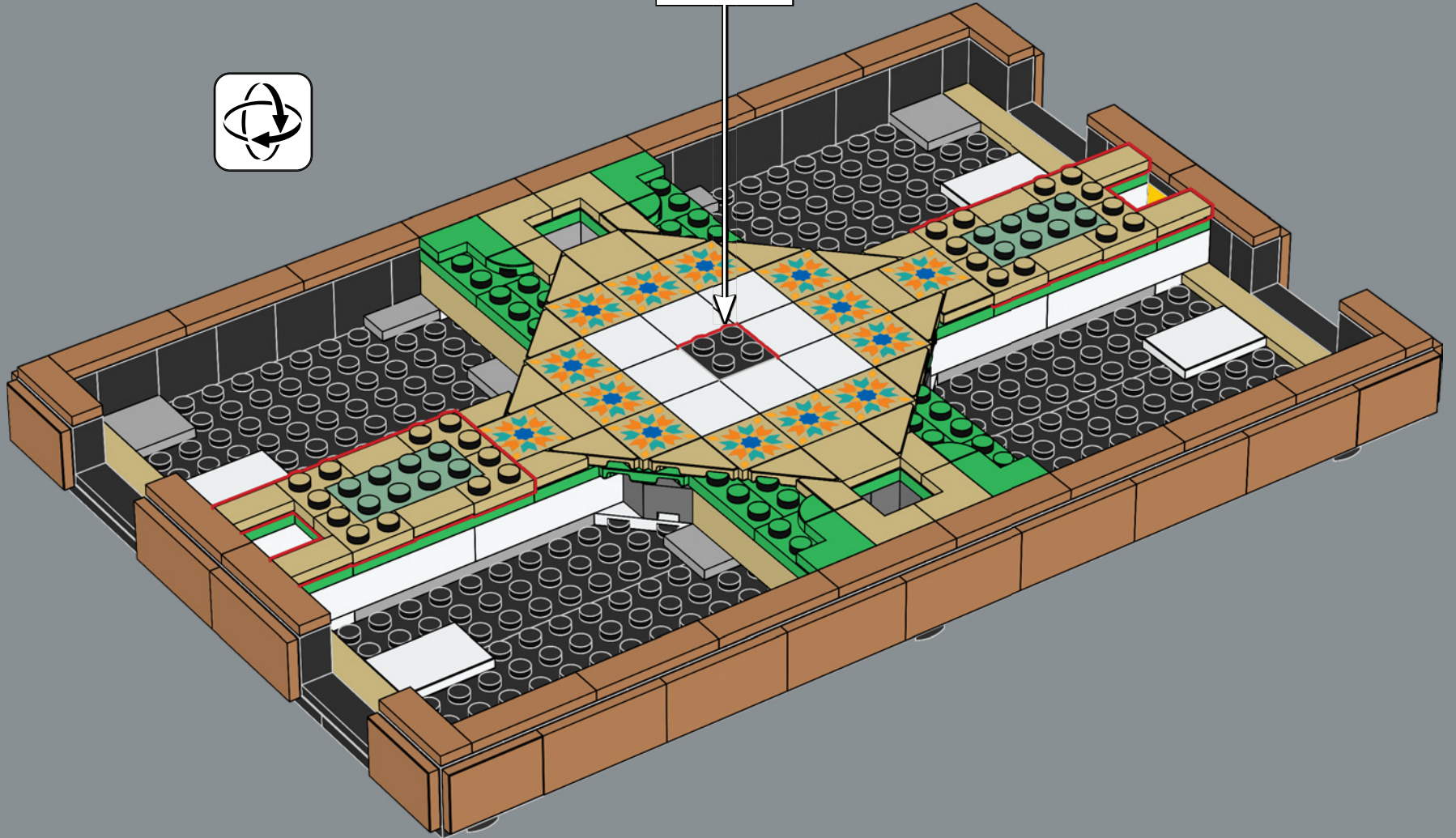
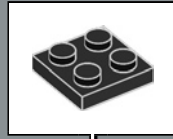



34

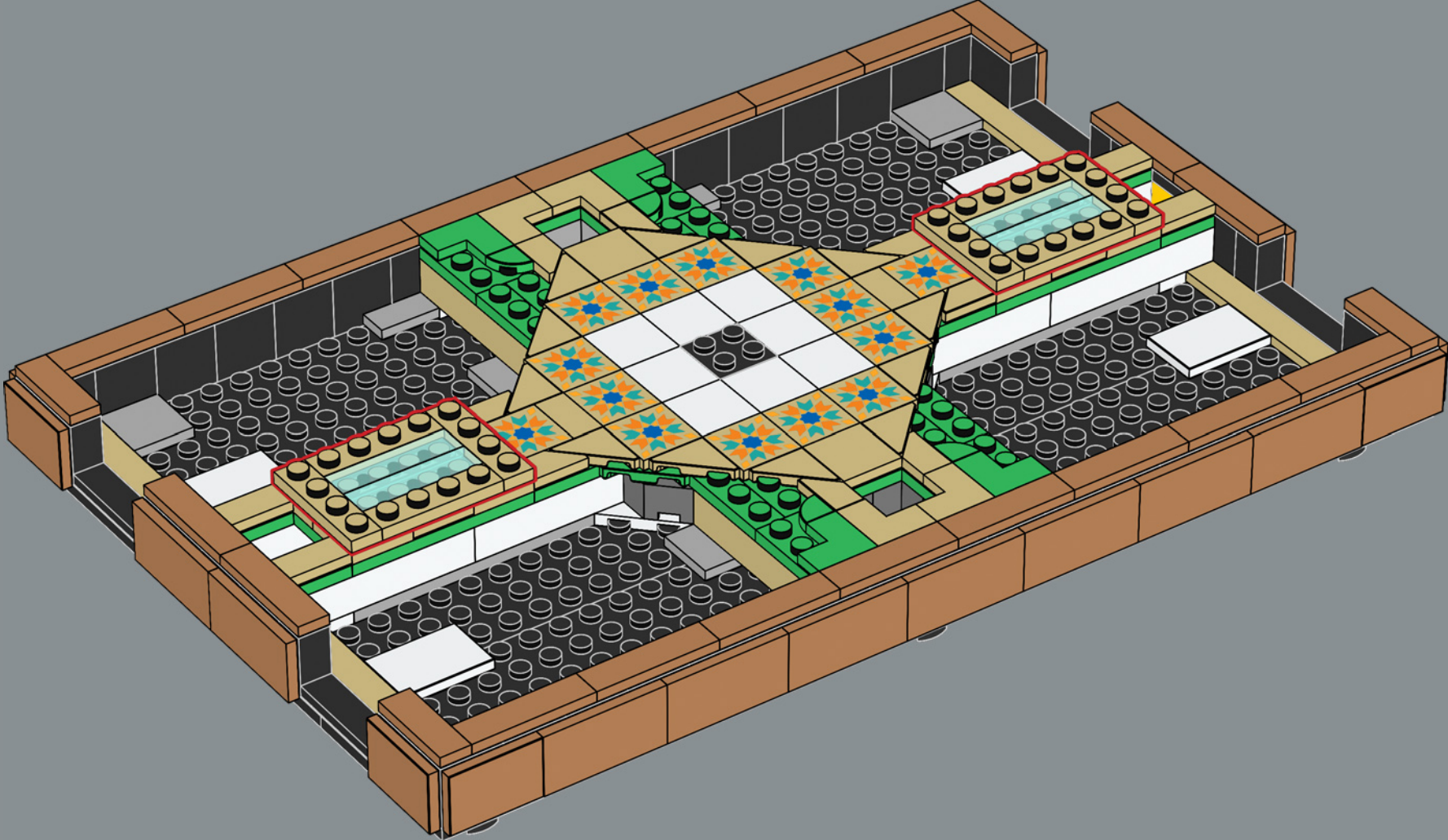

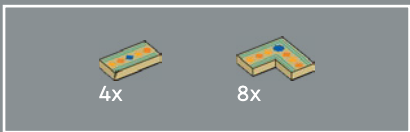

35

Per i pezzi decorati creati in questo set ci siamo ispirati alle piastrelle a mosaico in stile zellij. Si trovano spesso nell'architettura di antichi siti storici e monumenti in paesi come il Marocco, l'Algeria, la Tunisia e la regione andalusa del sud della Spagna.

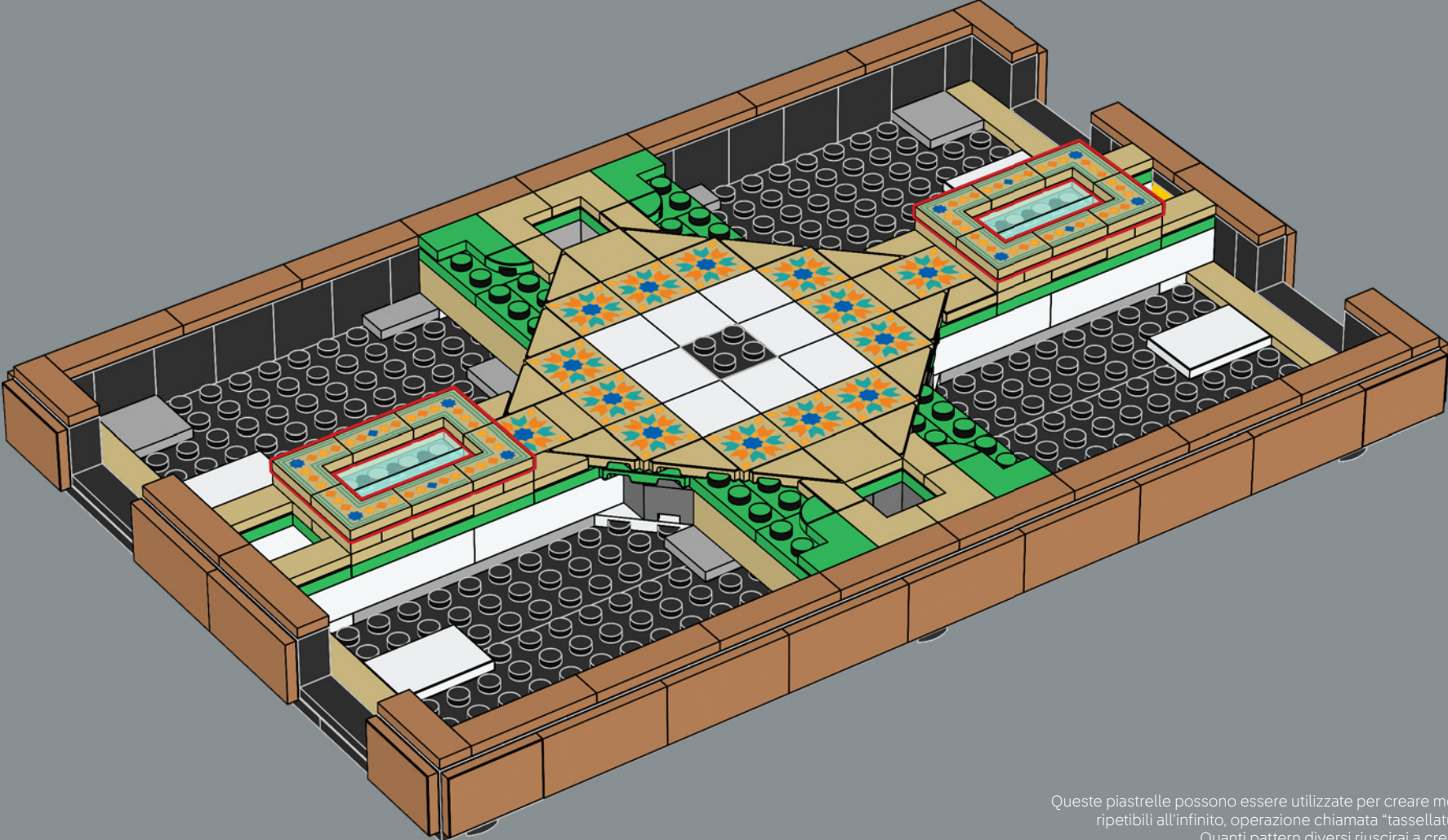

Queste piastrelle possono essere utilizzate per creare motivi ripetibili all'infinito, operazione chiamata "tassellatura". Quanti pattern diversi riuscirai a creare?

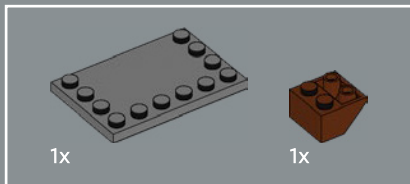
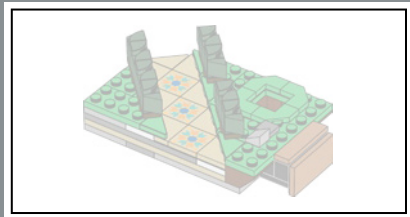

36

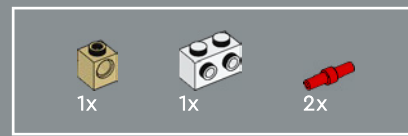
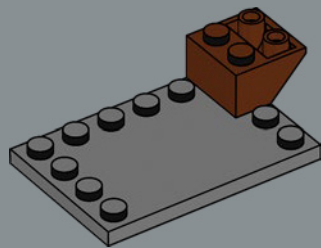

37

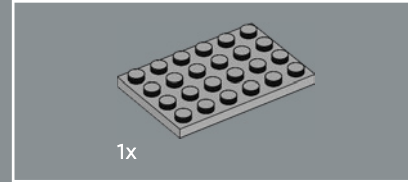
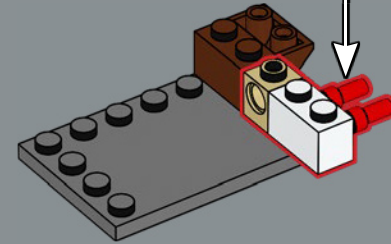
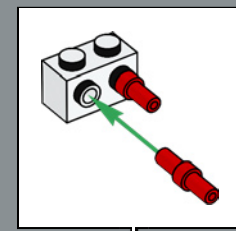

38

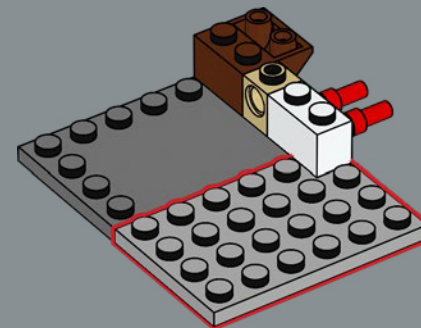

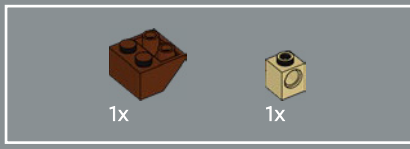

39

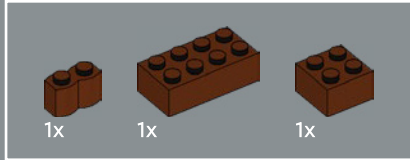
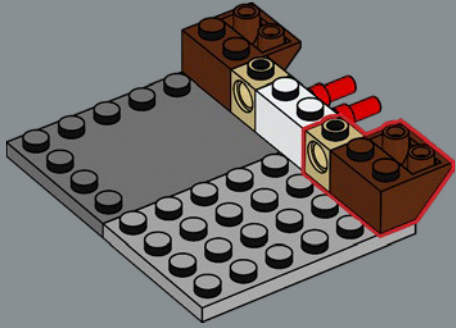

40

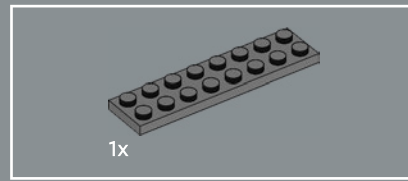
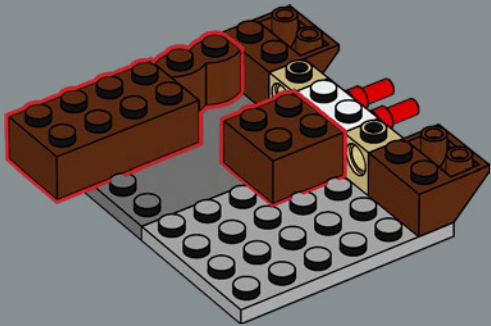

41

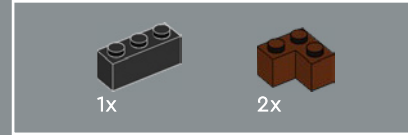
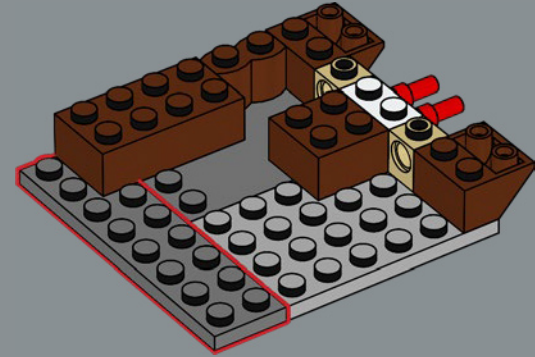

42

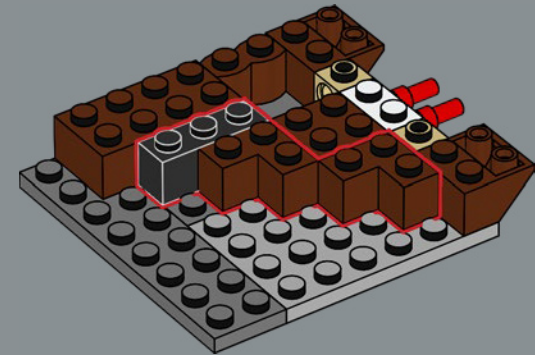

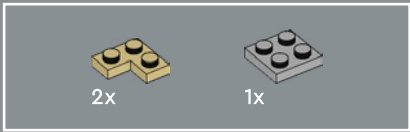

43

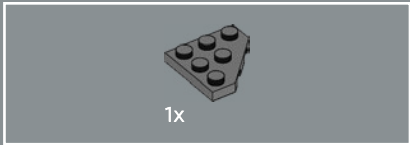
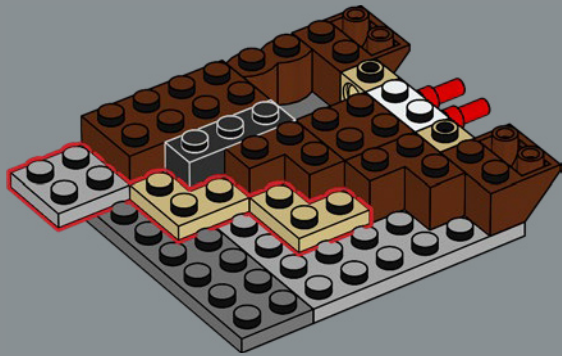

44

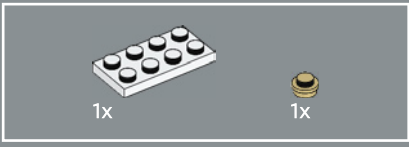
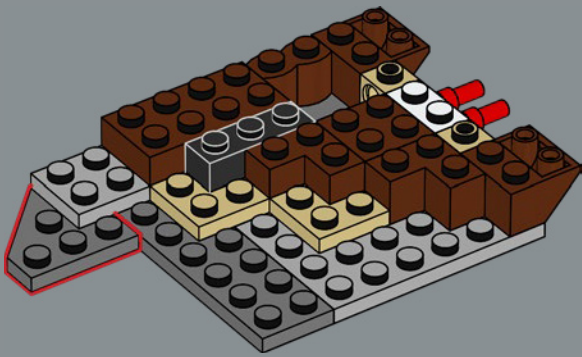

45

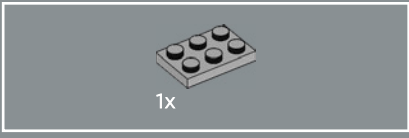
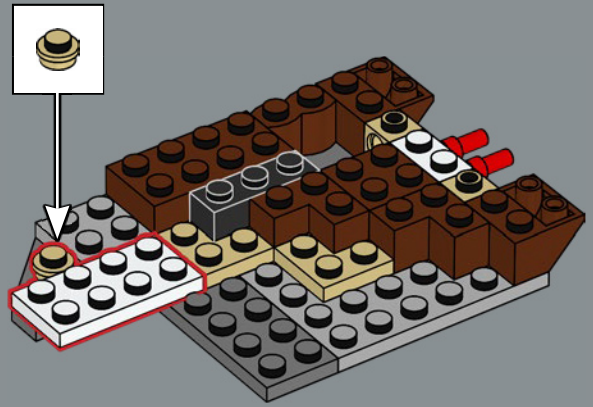

46

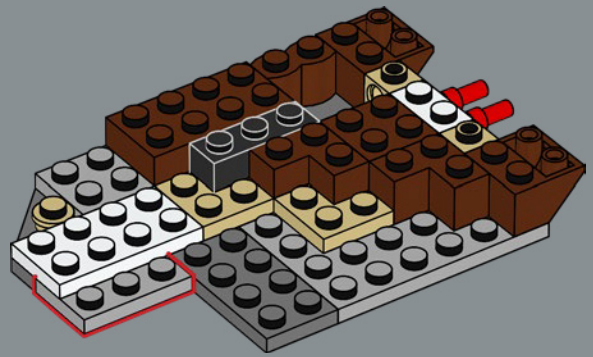

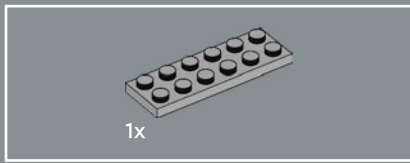

47

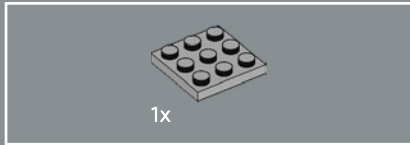
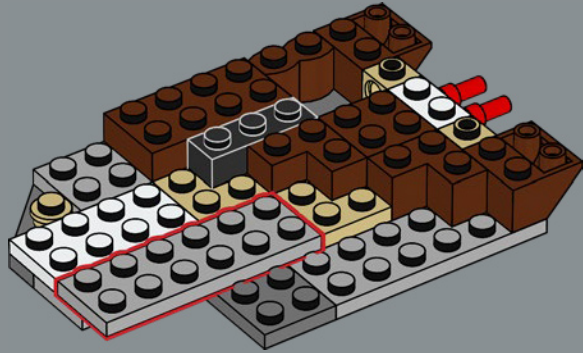

48

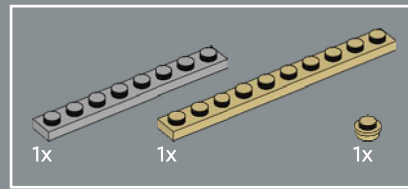
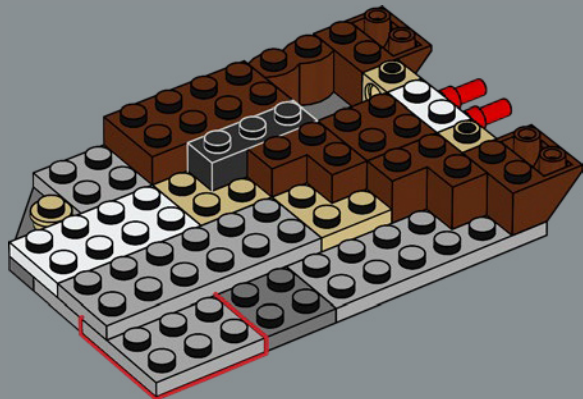

49

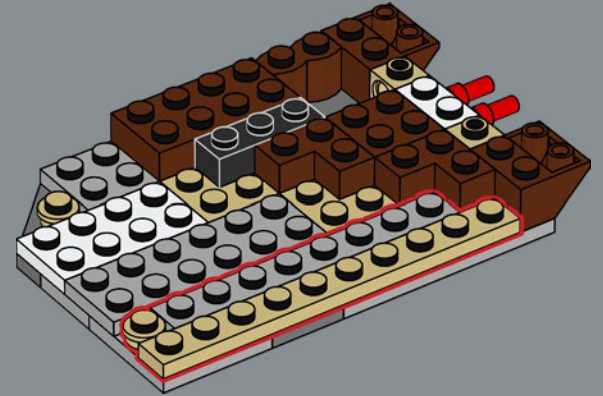

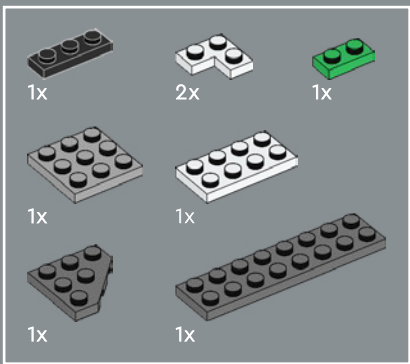

50

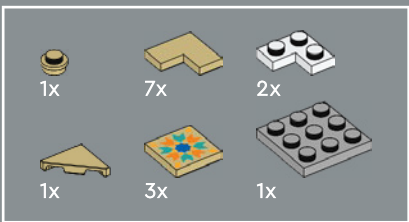

51

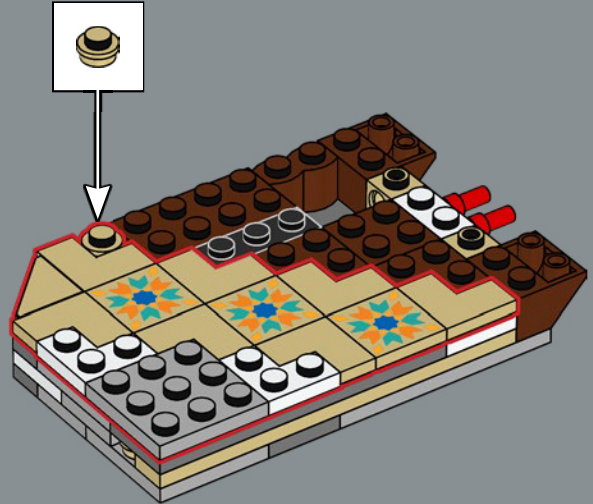

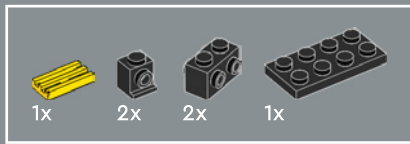

52

1

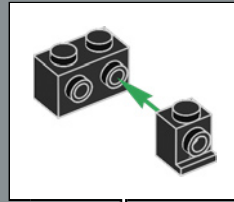
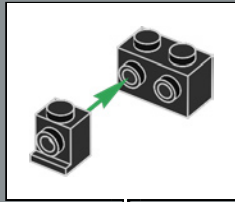
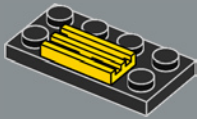

2

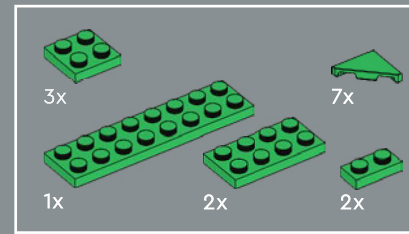
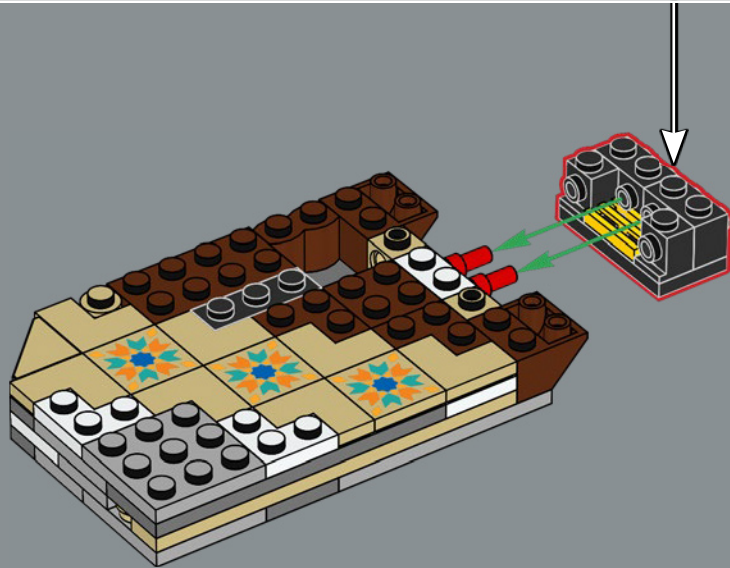
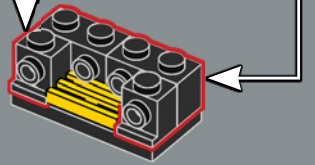

53

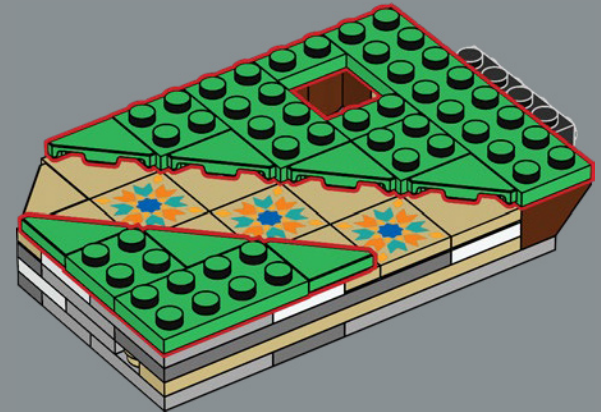



54

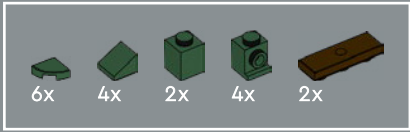
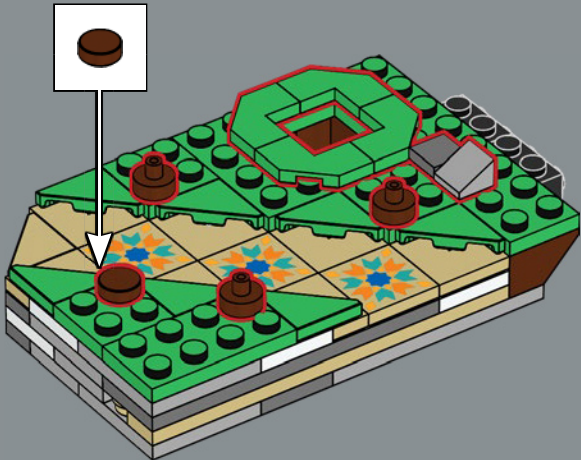

55

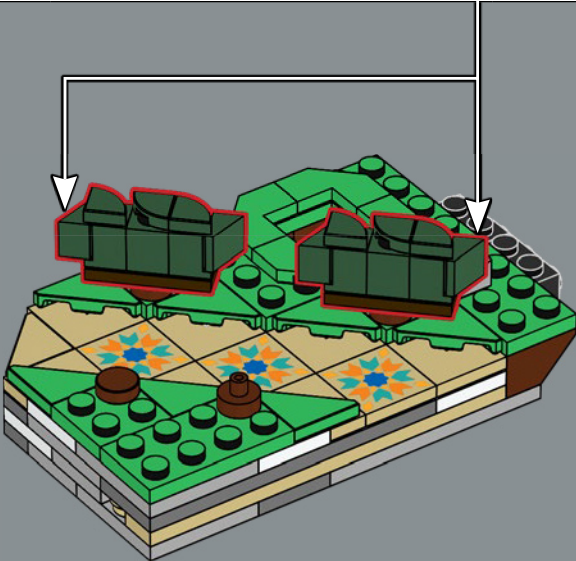
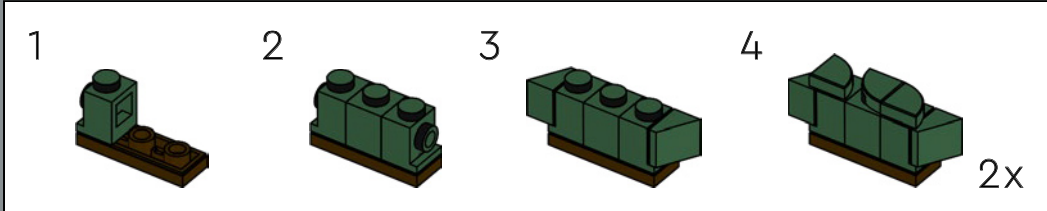

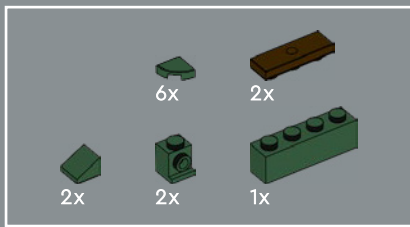

56

1



2

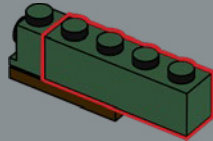

3

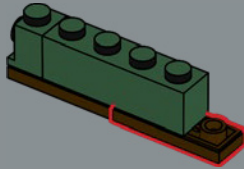

4

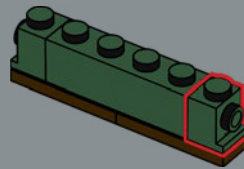

5

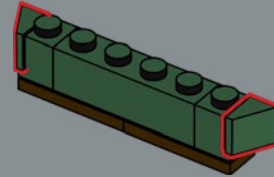

6

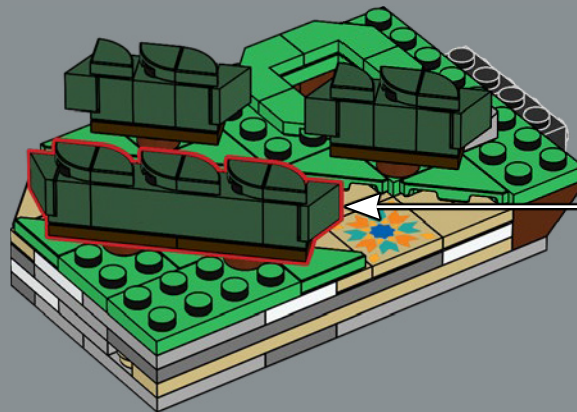
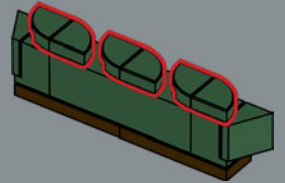

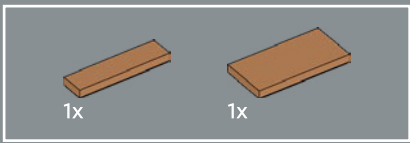

57

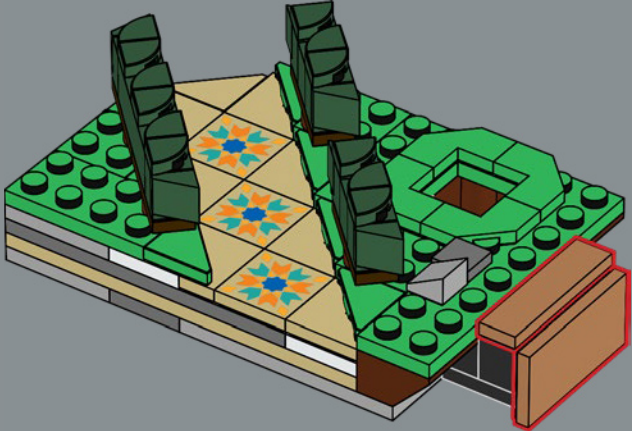

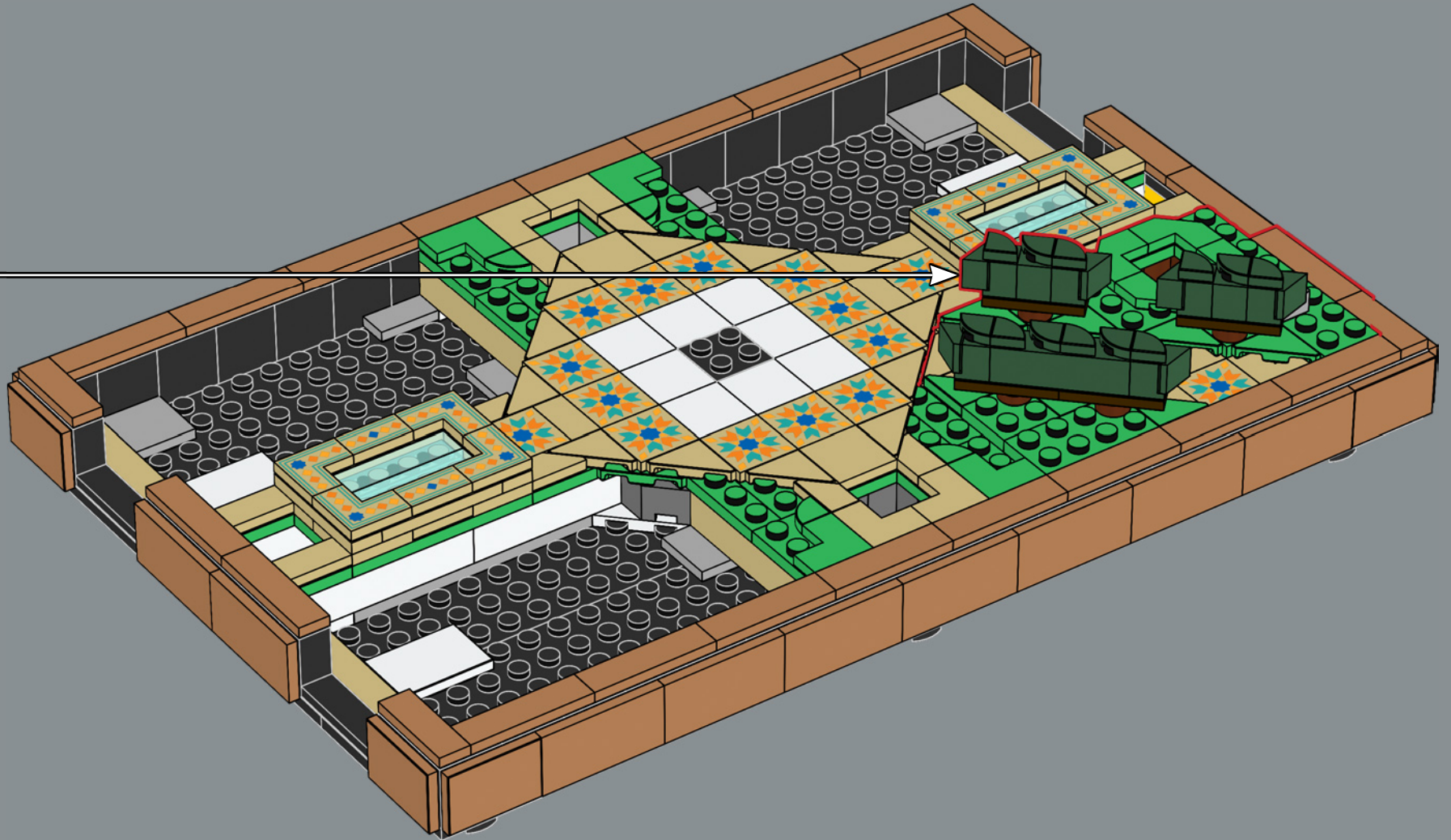

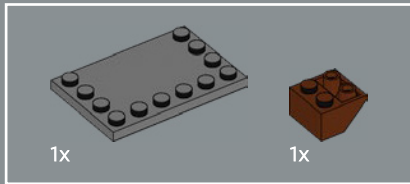
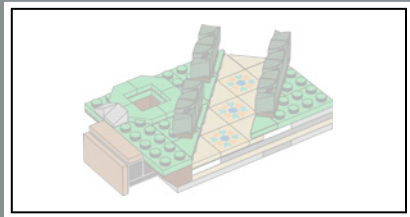

59

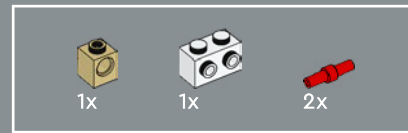
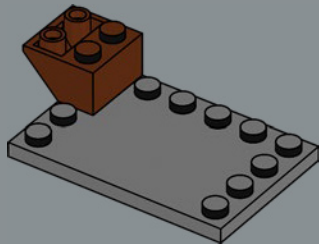

60

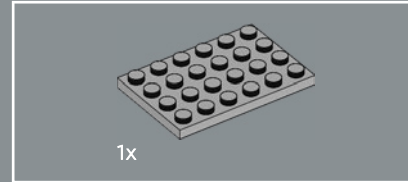
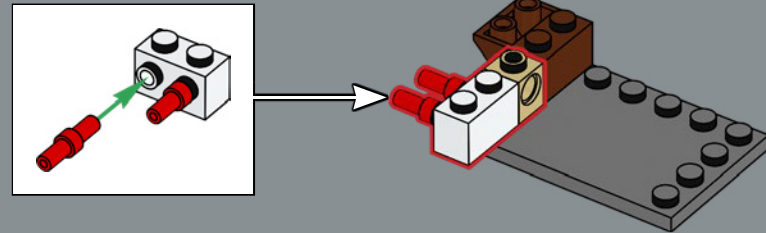

61

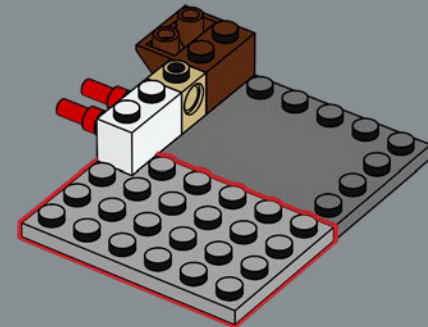

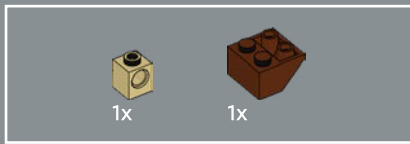

62

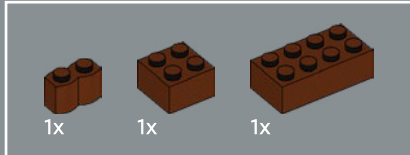
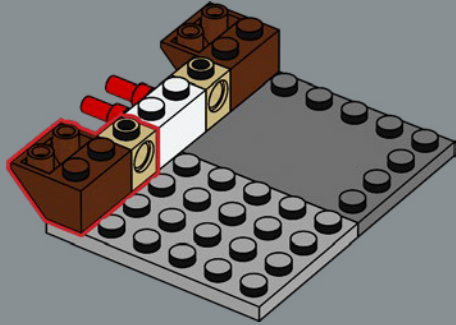

63

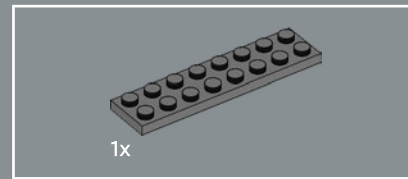
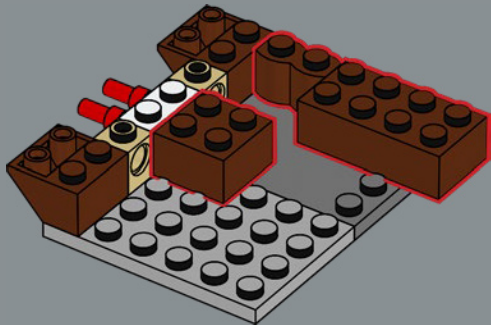

64

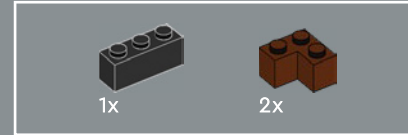
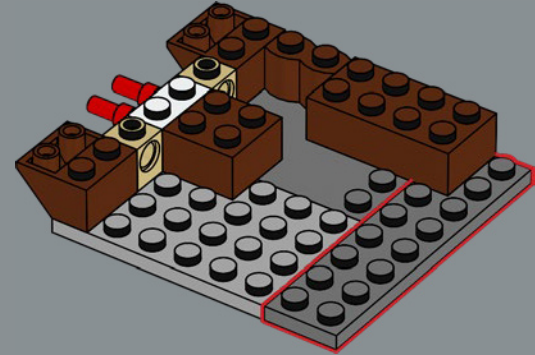

65

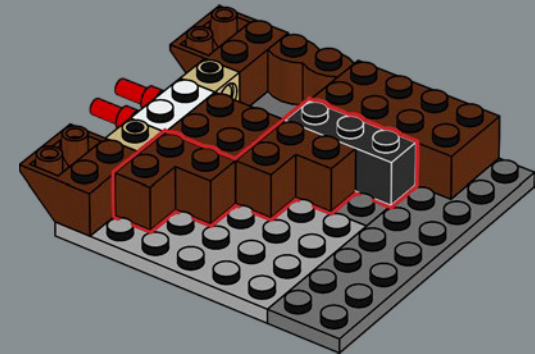

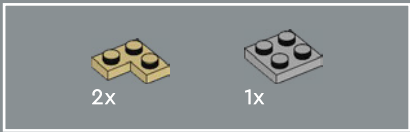

66

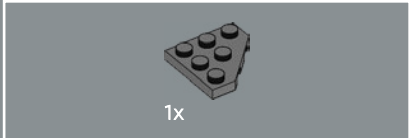
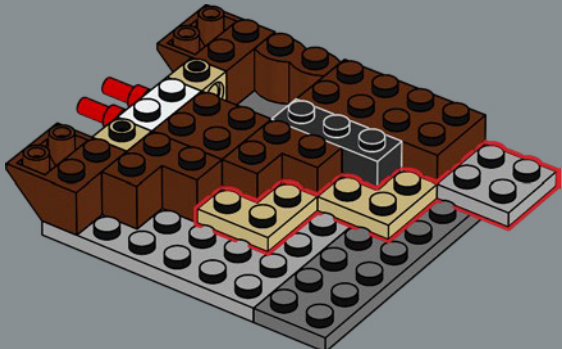

67

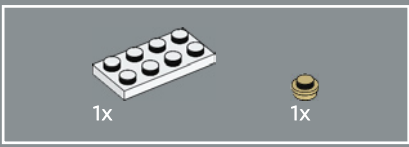
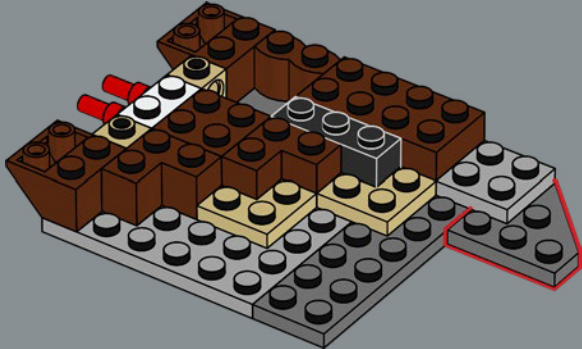

68

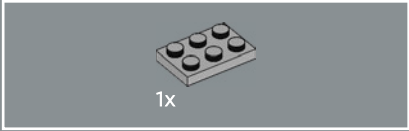
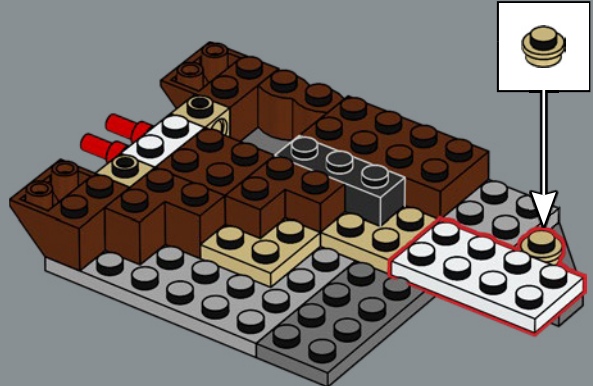

69

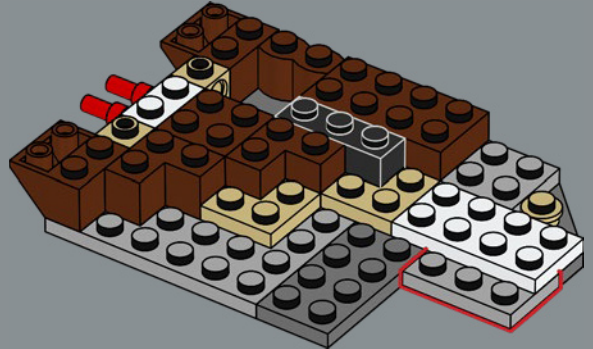

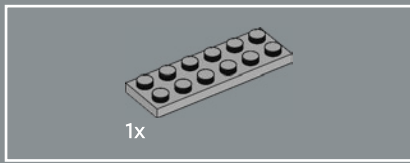

70

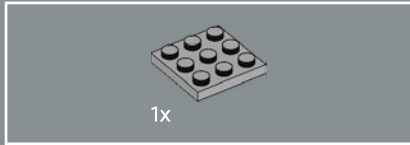
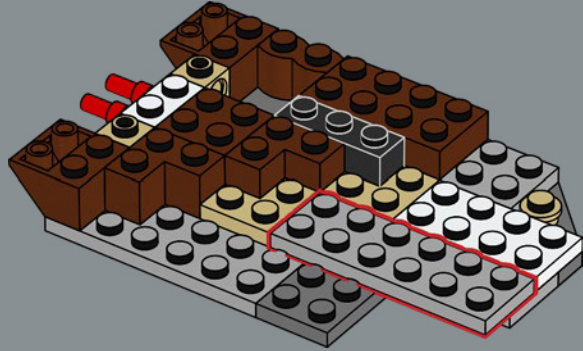

71

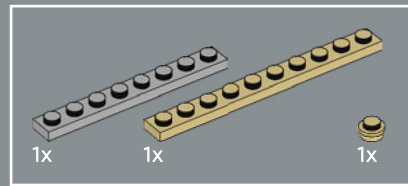
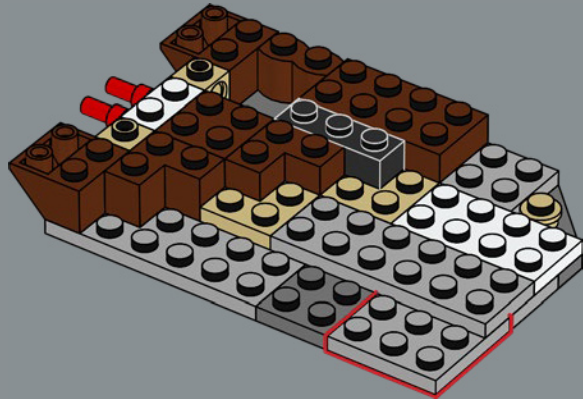

72

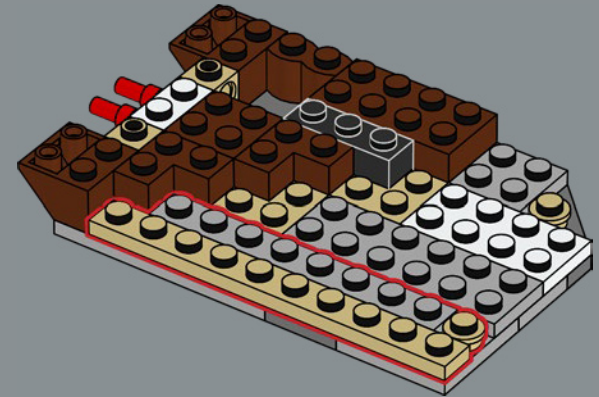

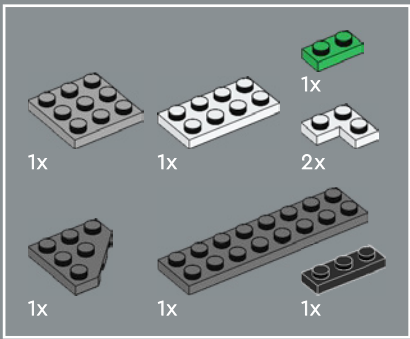

73

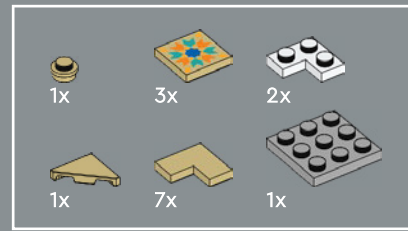
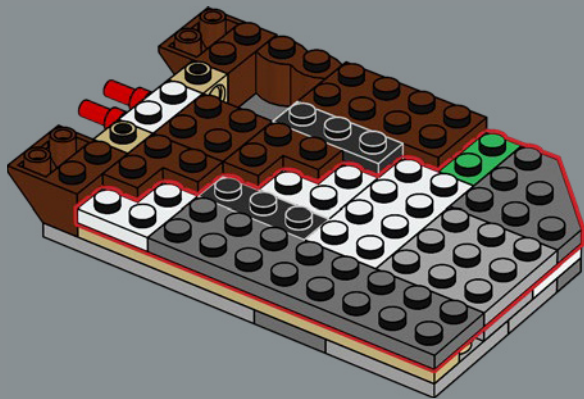

74

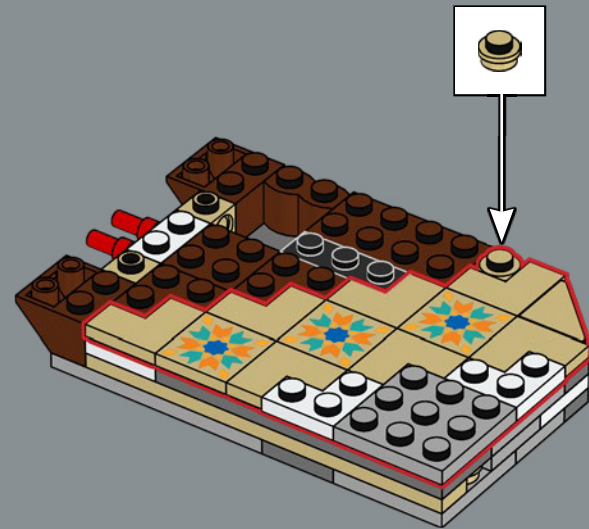

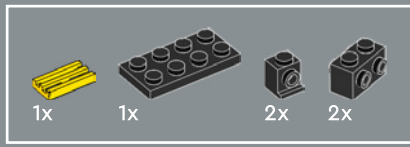

75

1

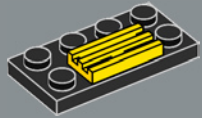

2

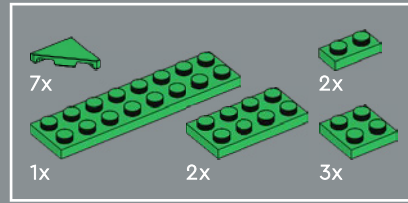
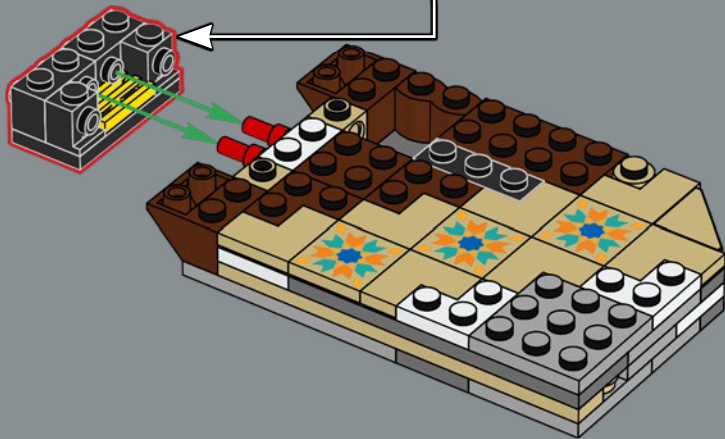
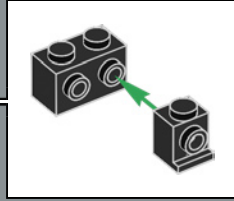
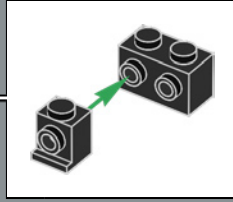
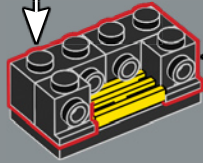

76

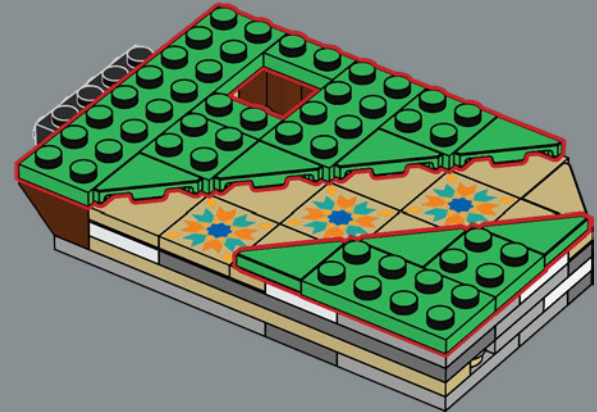

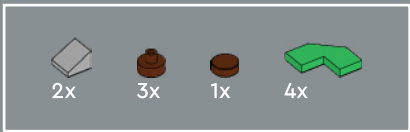

77

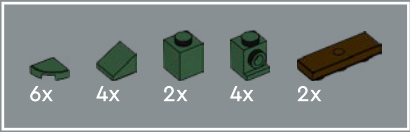
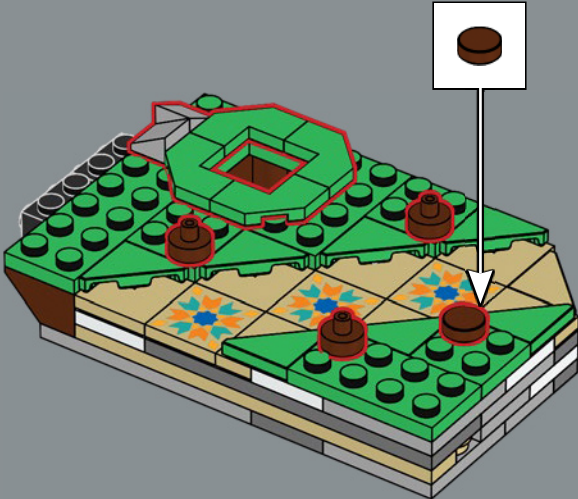

78

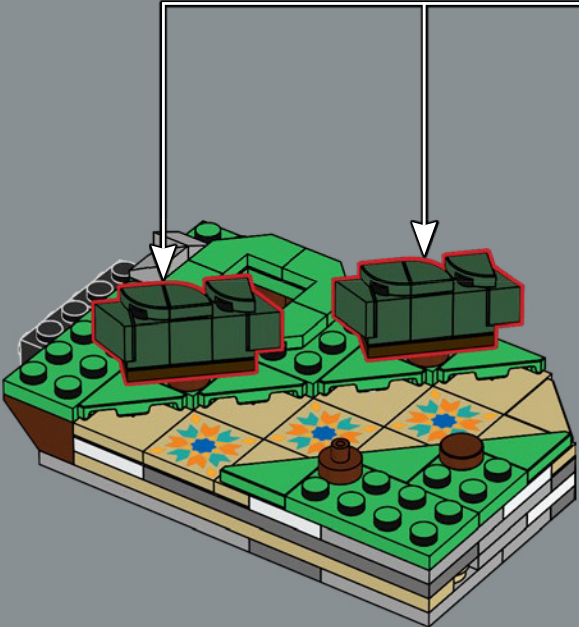
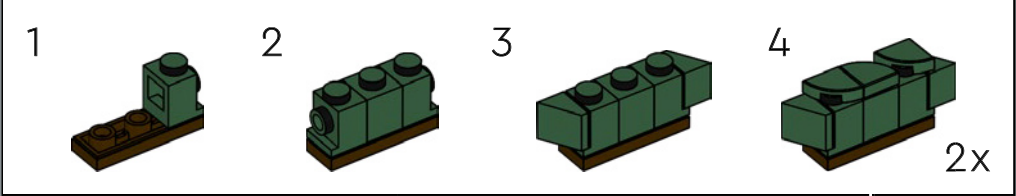

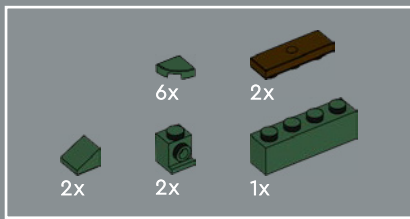

79

1



2

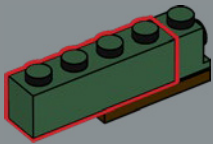

3

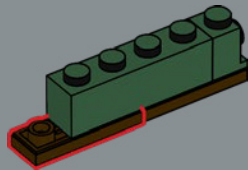

4

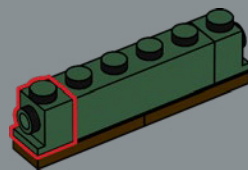

5

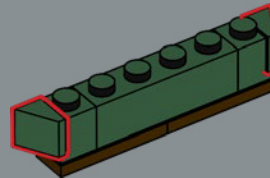

6

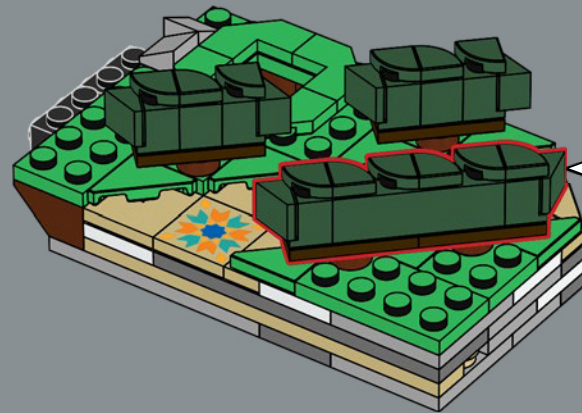
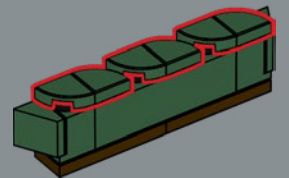

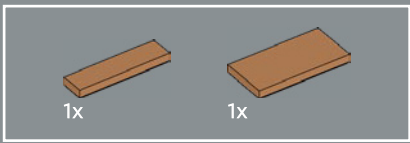

80

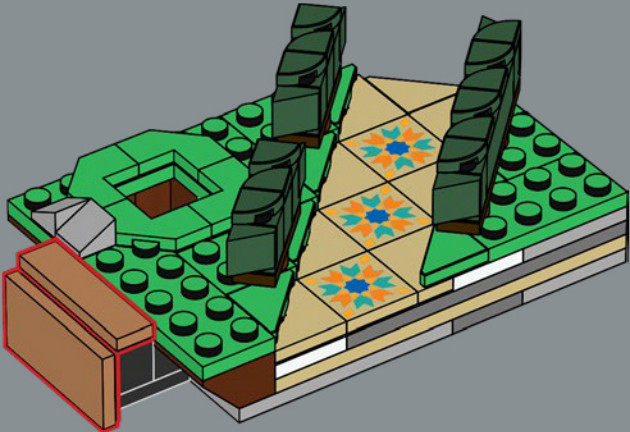

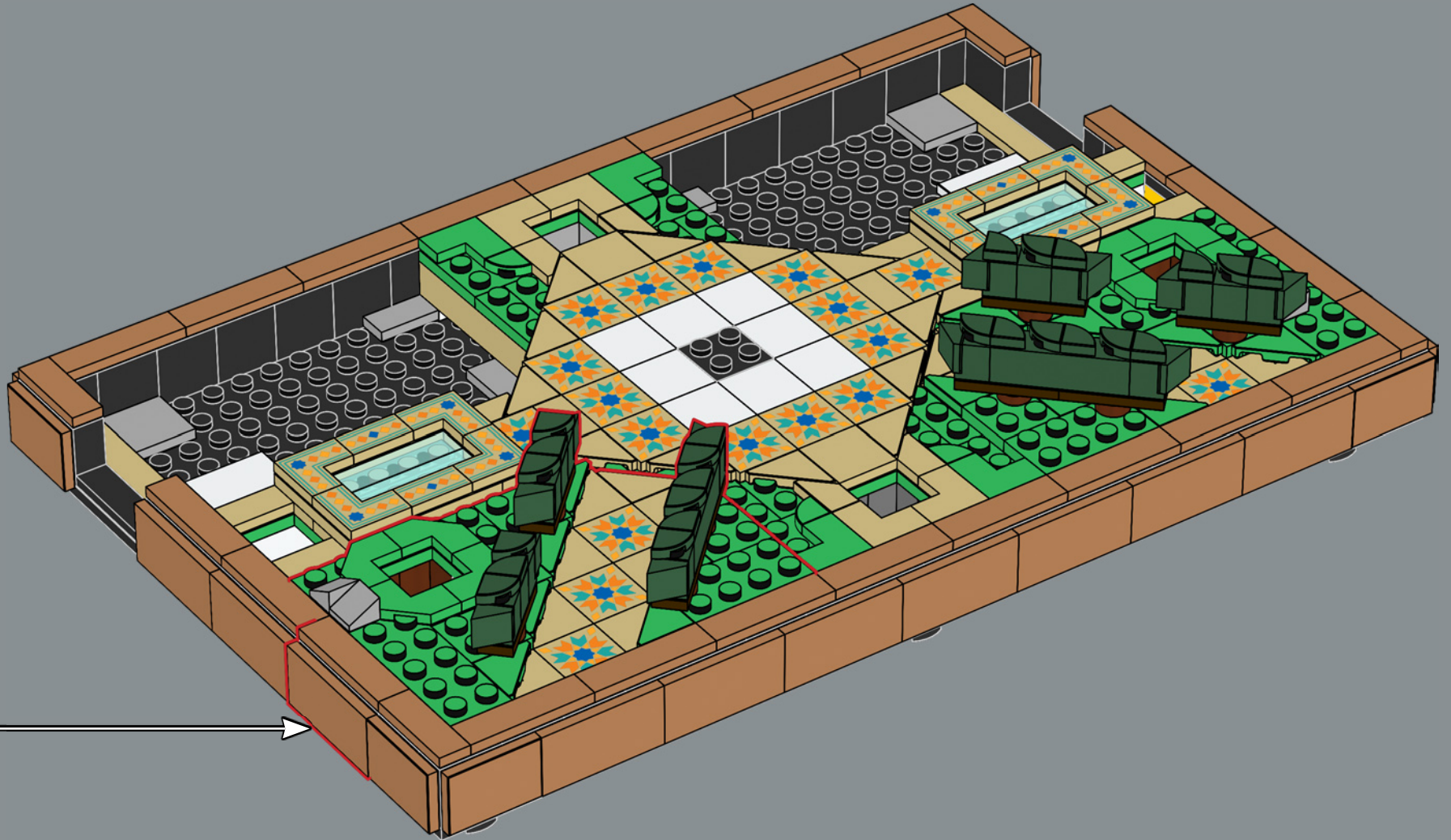

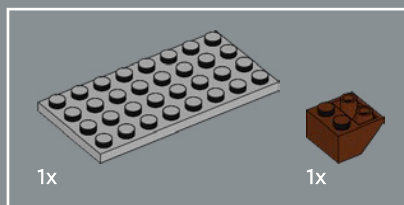
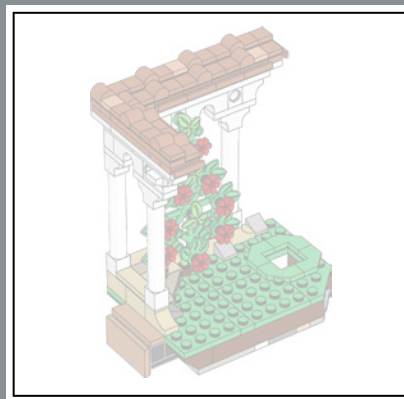

82

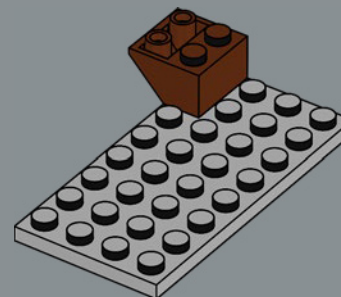

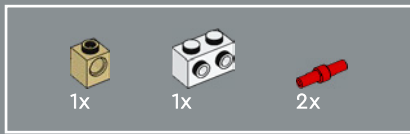

83

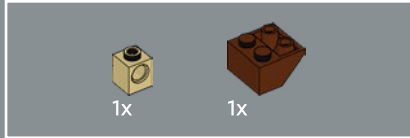
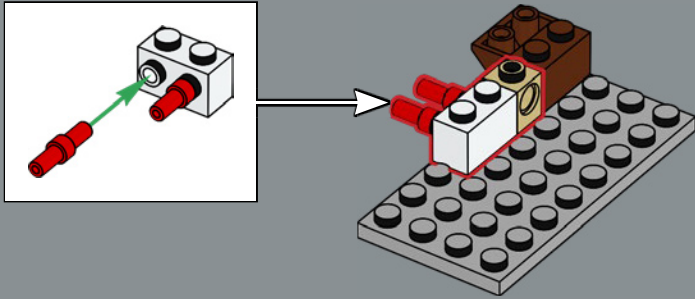

84

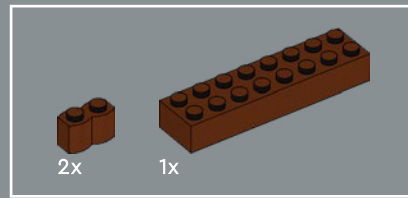
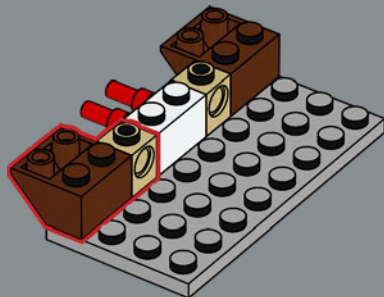

85

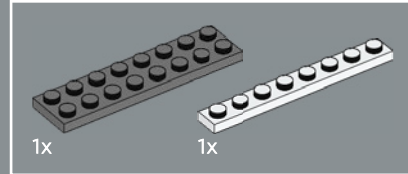
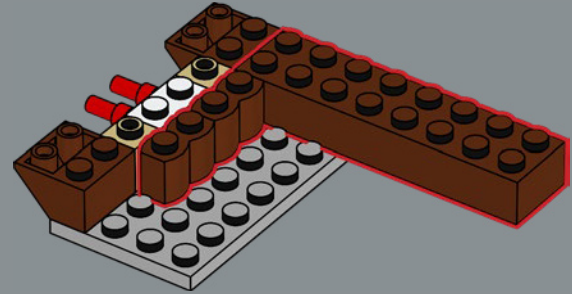

86

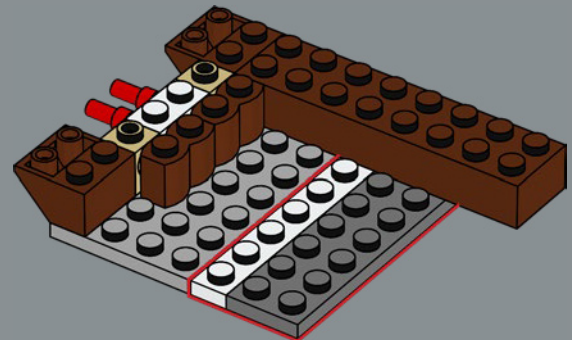

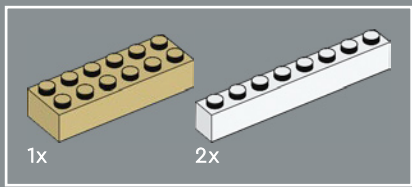

87

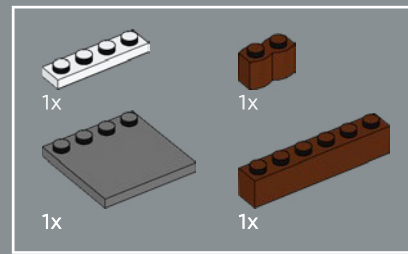
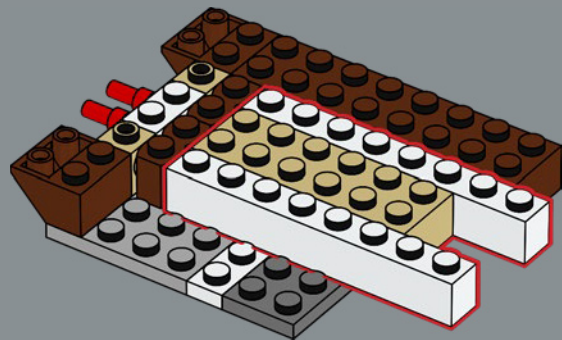

88

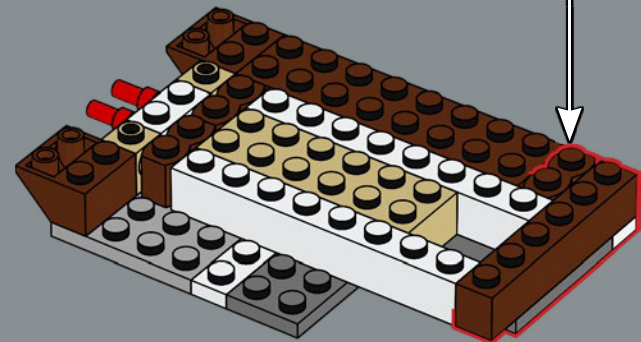
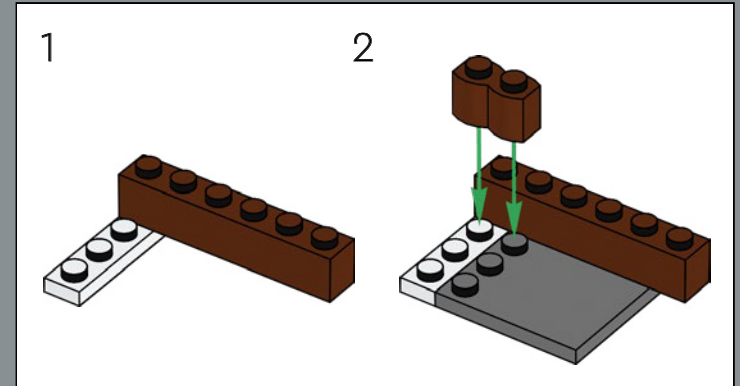

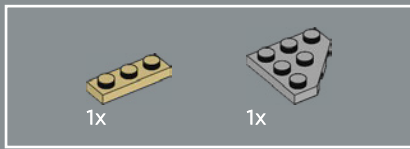

89

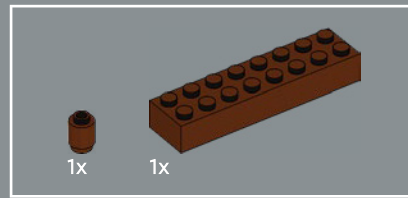
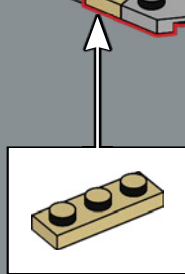
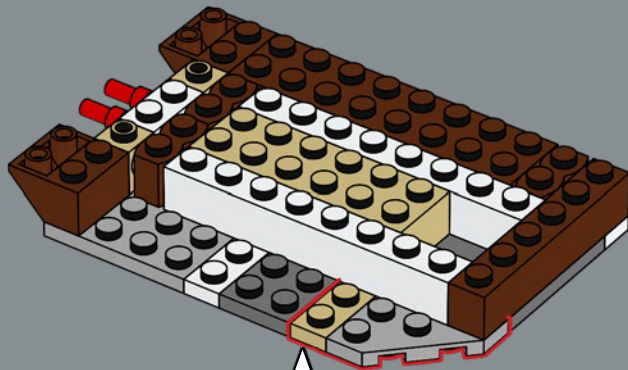

90

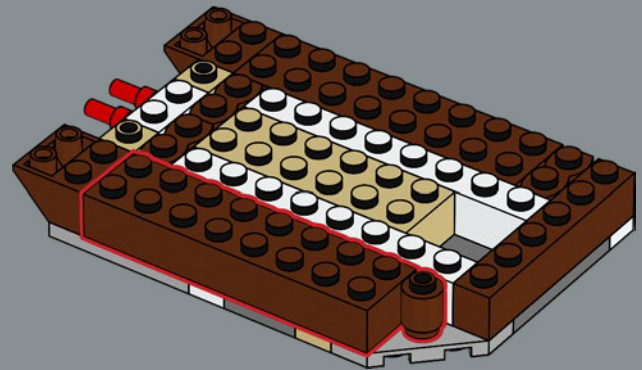

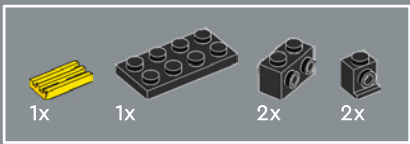

91

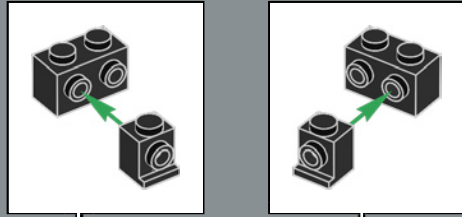

1

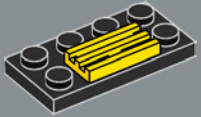

2

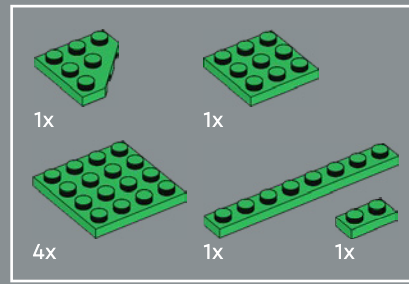
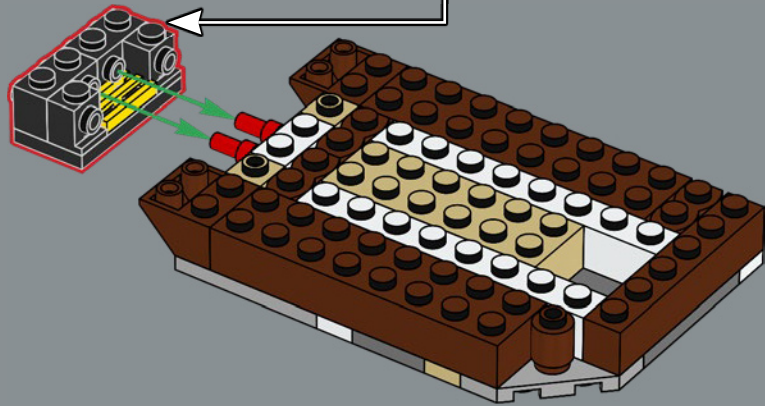
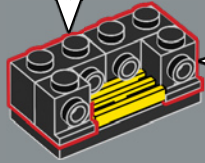

92



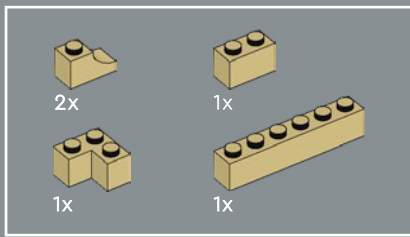

93

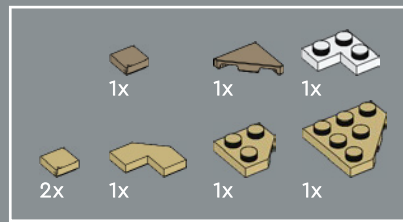
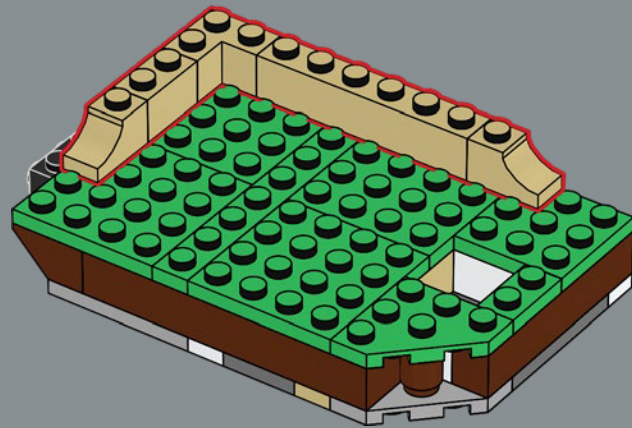

94

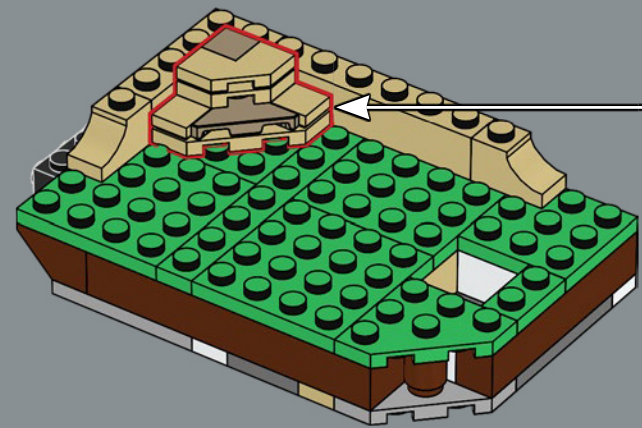
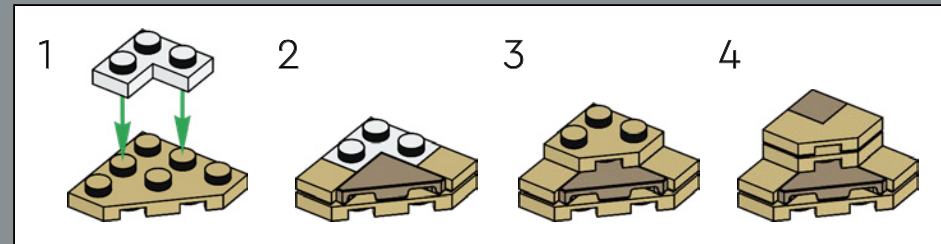



95

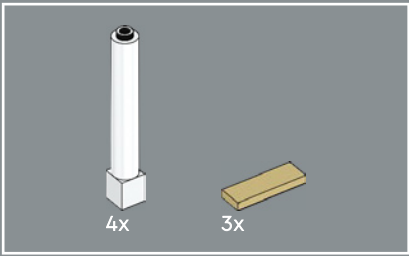
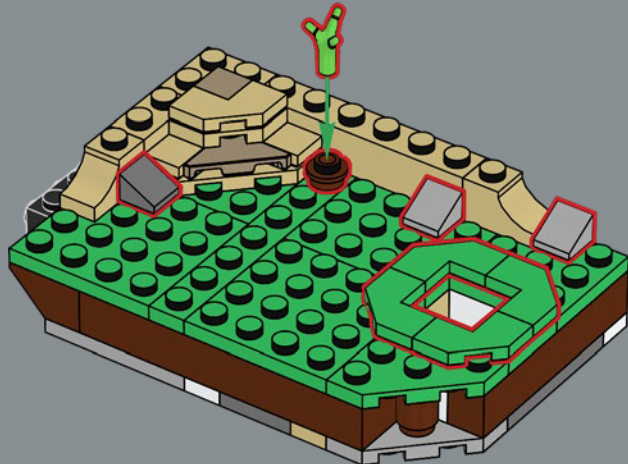

96

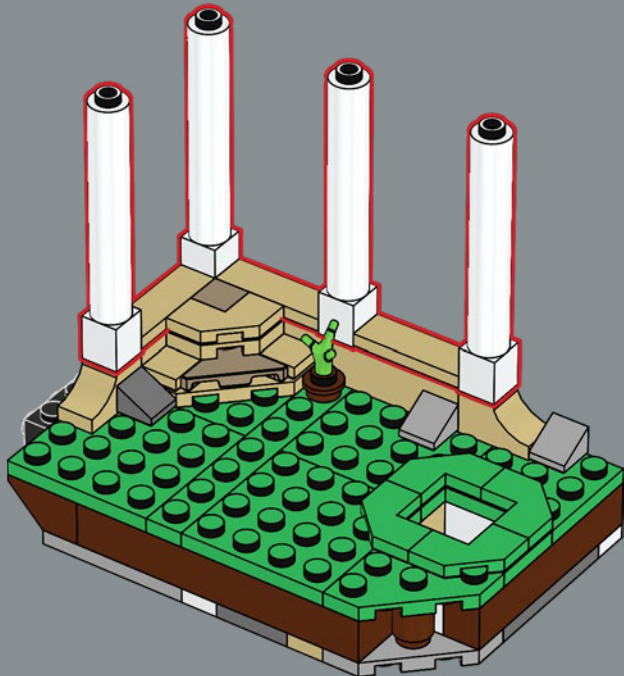

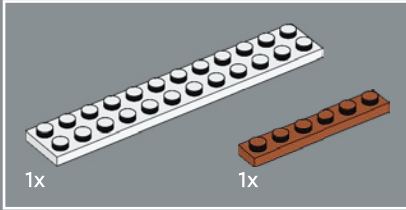
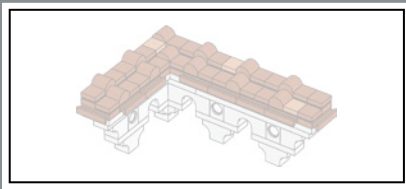

97

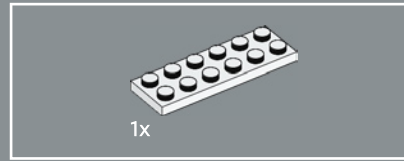
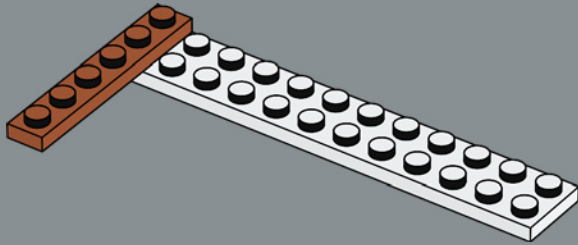

98

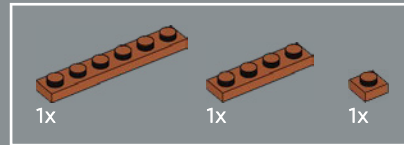
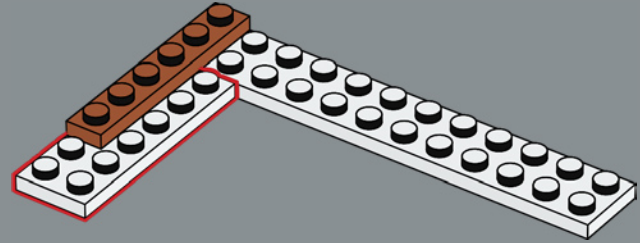

99

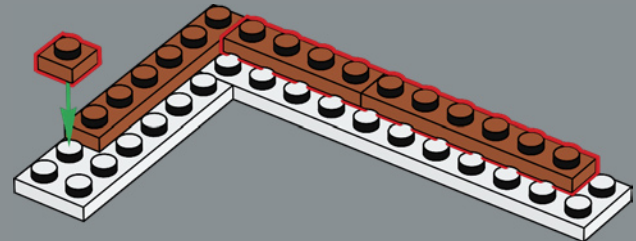



100

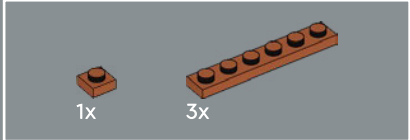
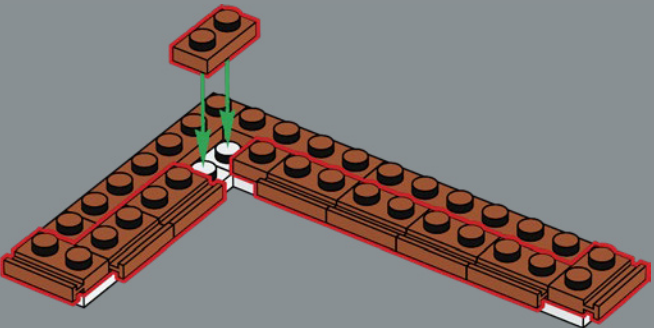

101

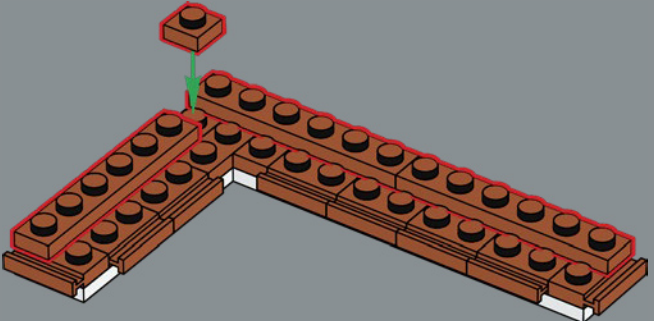

102

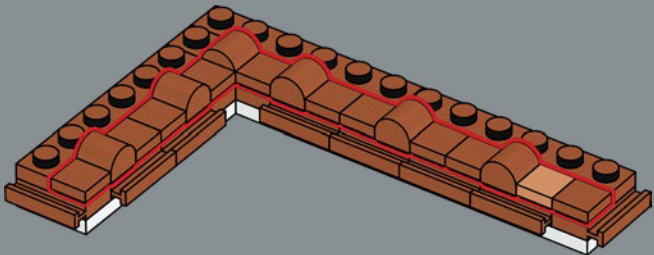

103

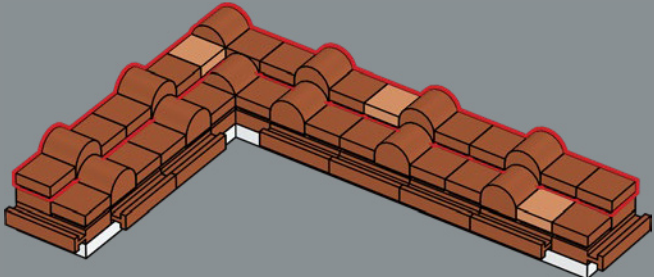

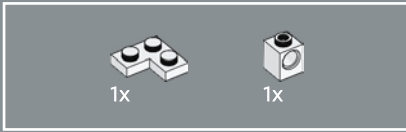
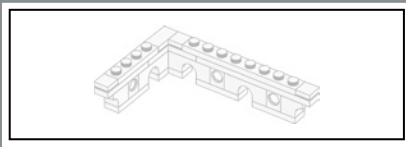

104

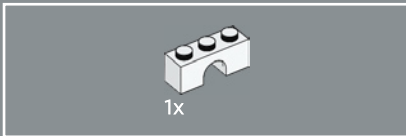
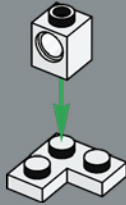

105

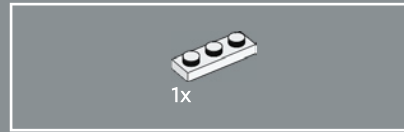
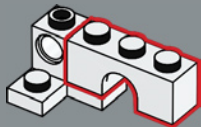

106

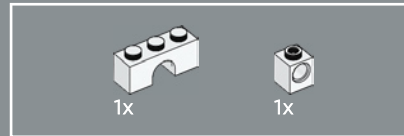
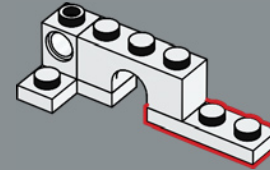

107

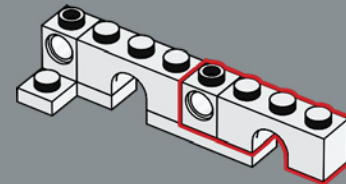

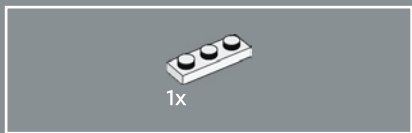

108

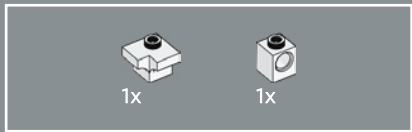
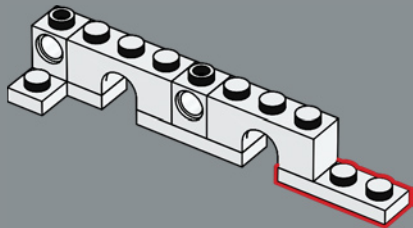

109

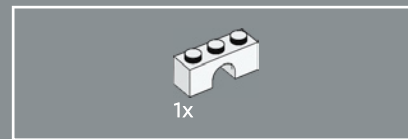
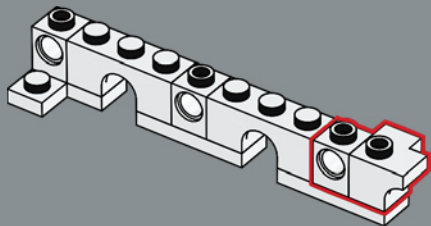

110

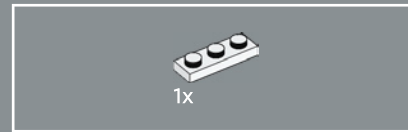
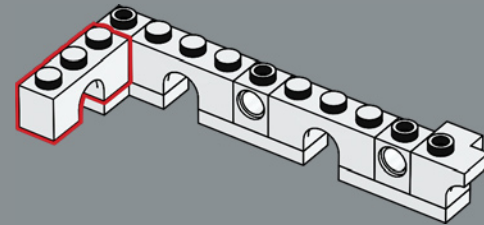

111

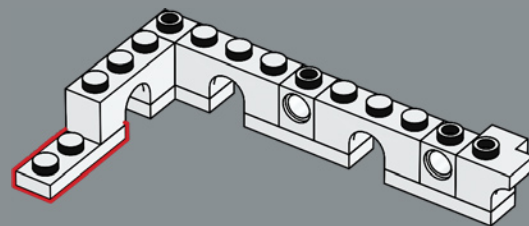

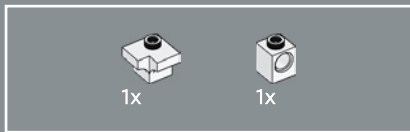

112

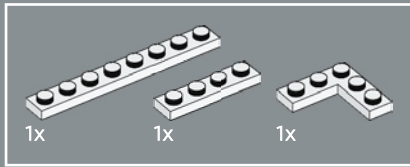
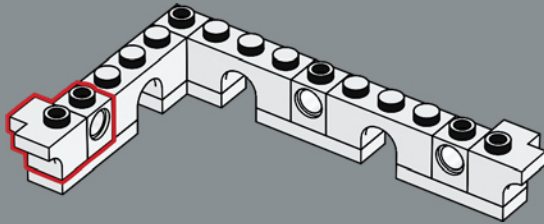

113

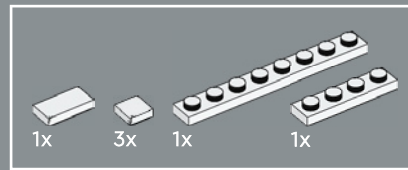
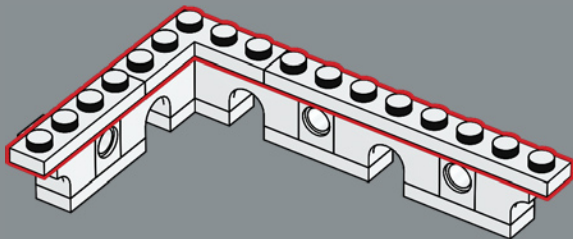

114

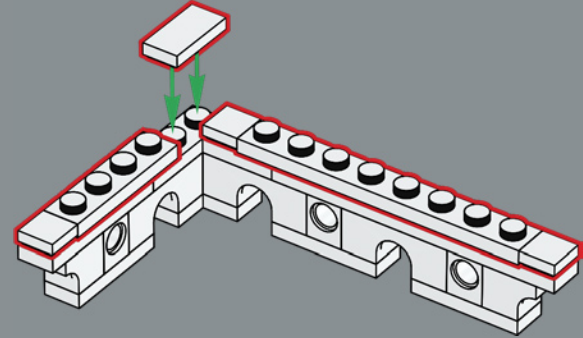

115

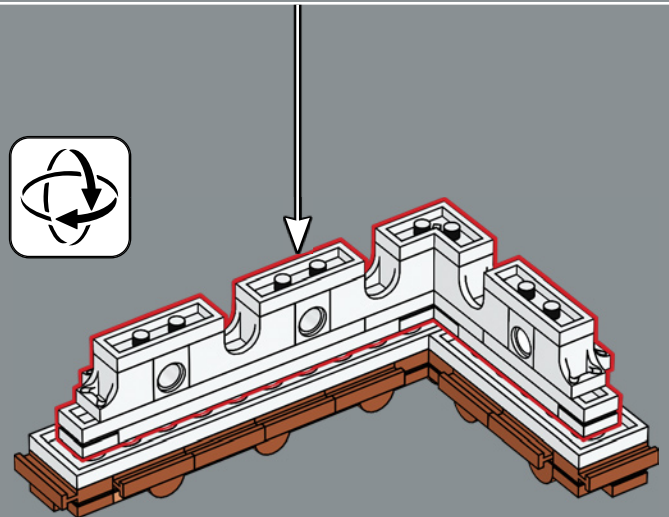

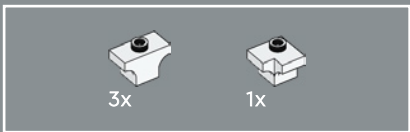

116

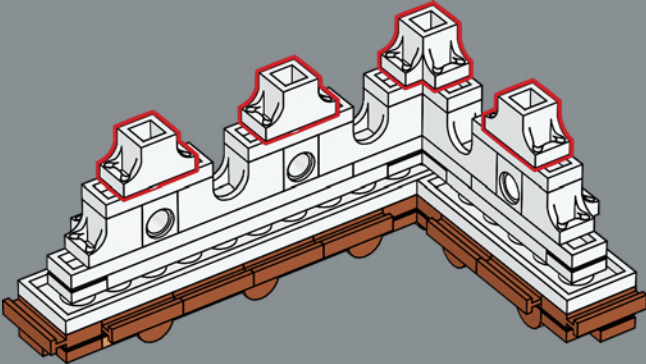

117

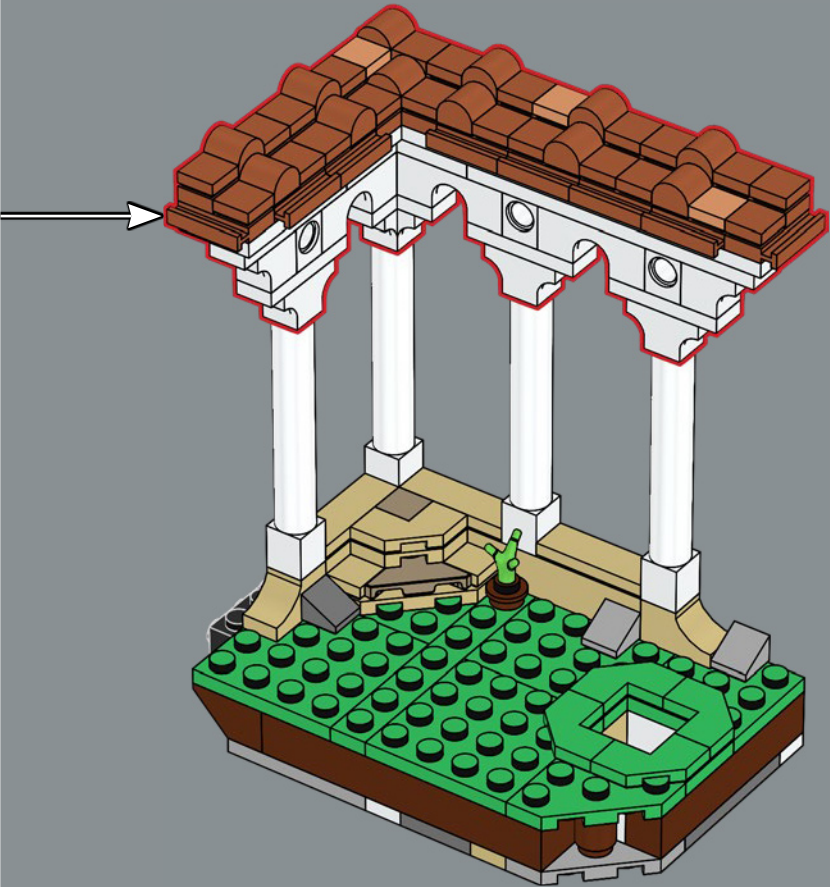

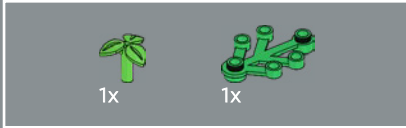
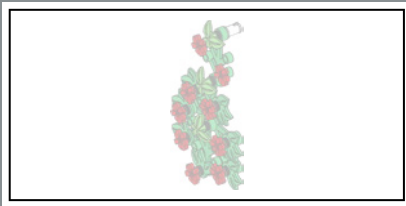

118

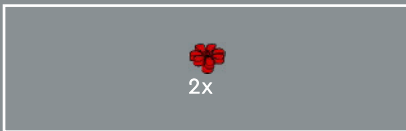
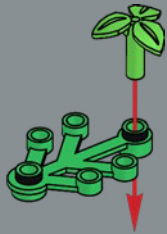

119

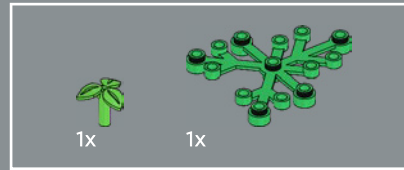

120

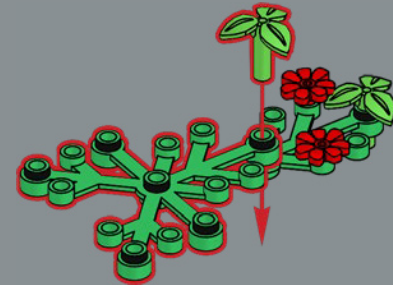

121

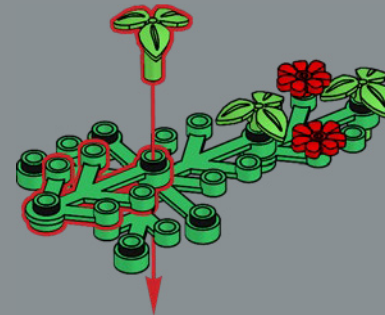



7x

122

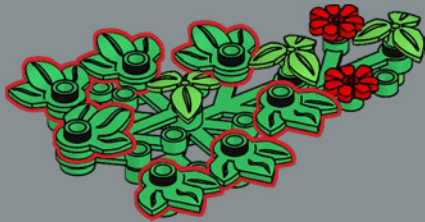

Ibisco cinese (*Hibiscus rosa-sinensis*)
I fiori di ibisco possono essere utilizzati per testare l'acidità di un liquido. Un fiore di ibisco diventerà rosa scuro in un acido o verde in una base. Perfetto per controllare l'acidità della tua fontana!



7x

123

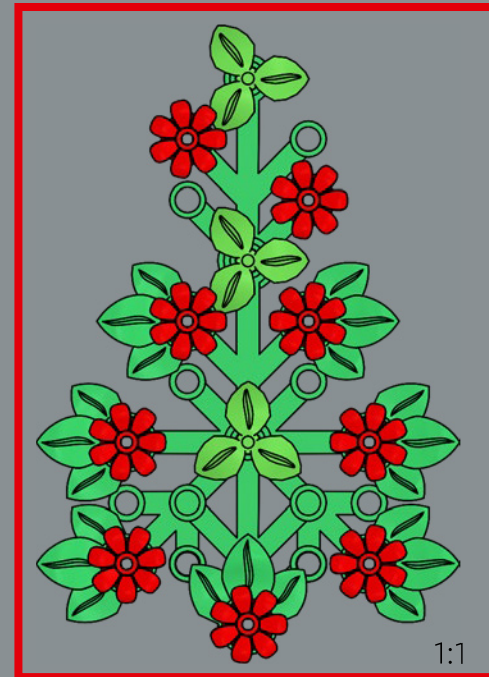
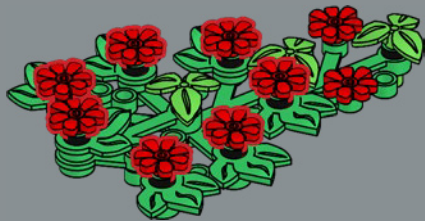



124

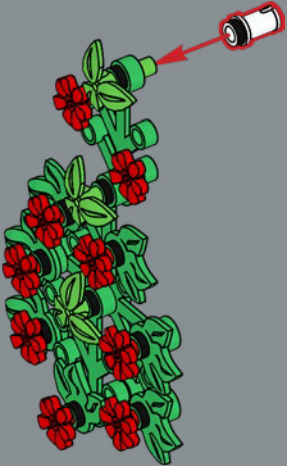

125

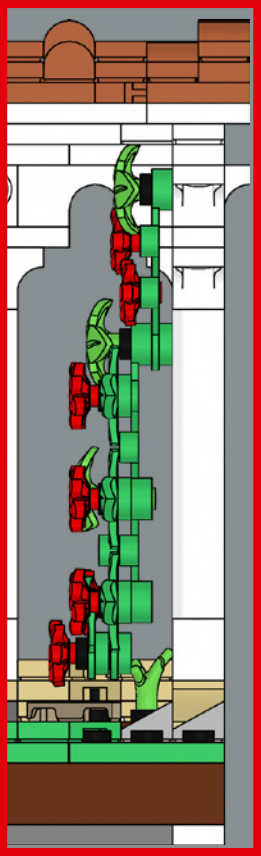

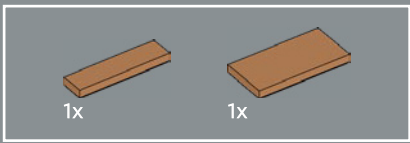

126

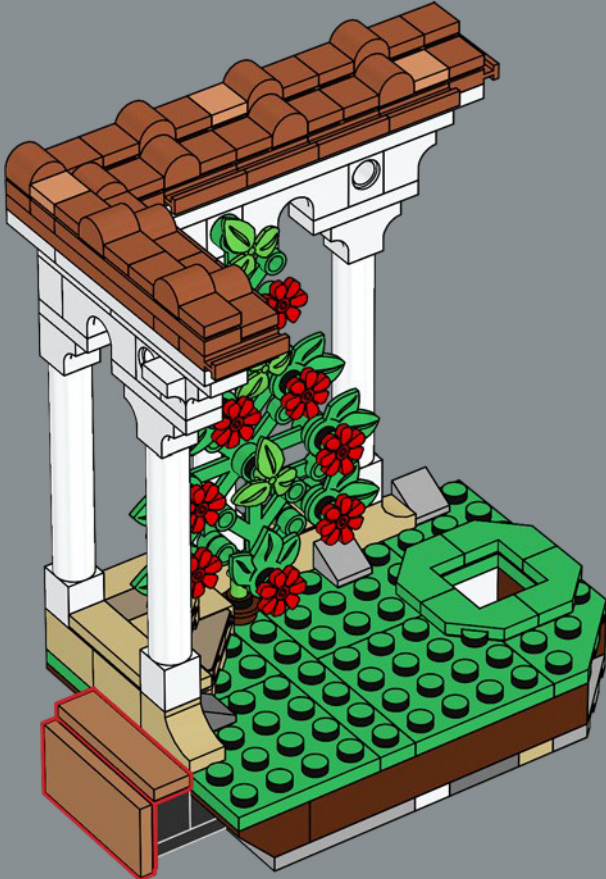

127



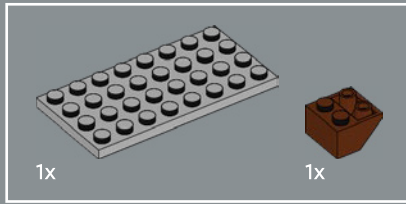
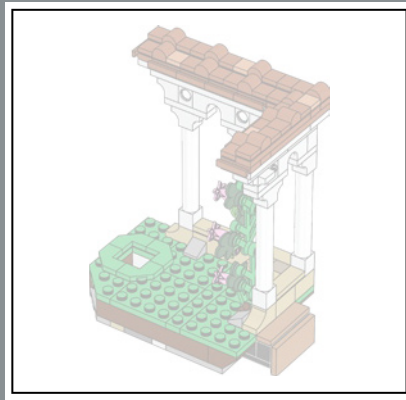

128

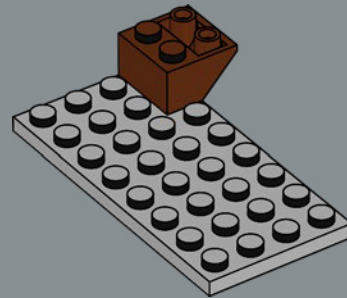

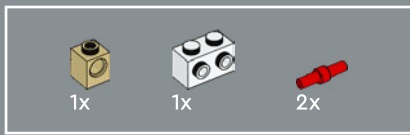

129

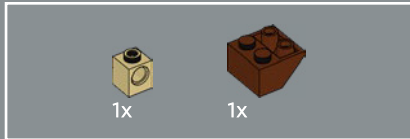
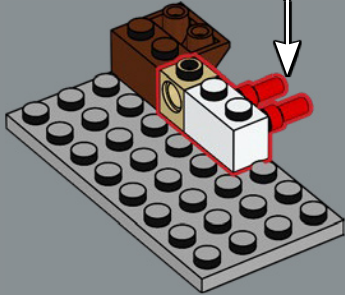
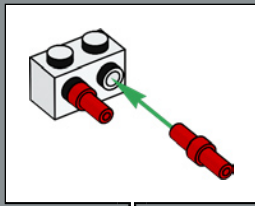

130

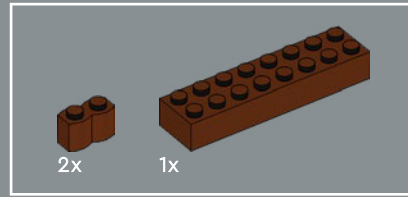
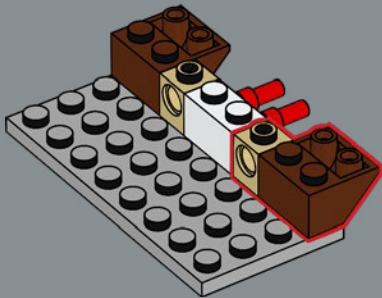

131

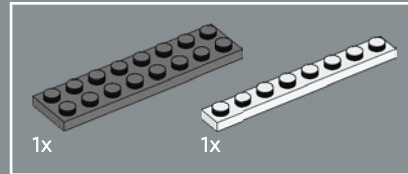
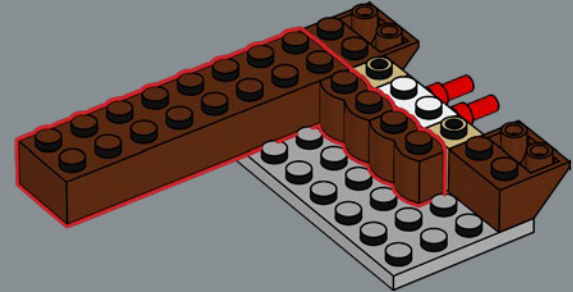

132

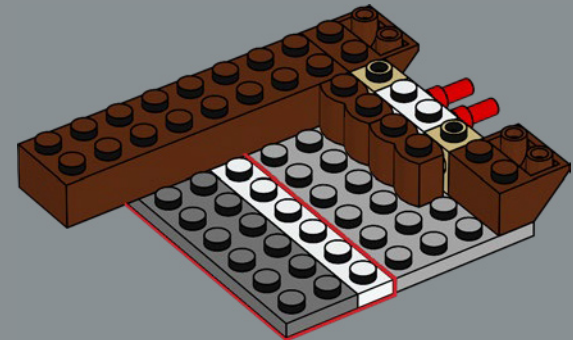

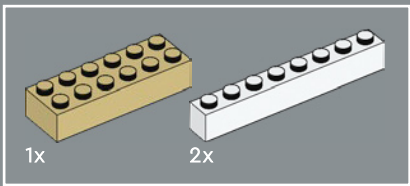

133

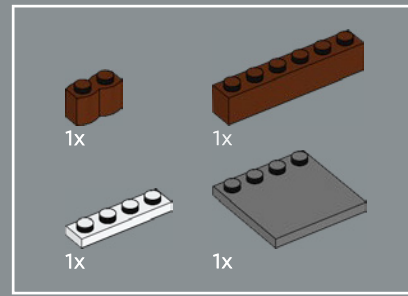
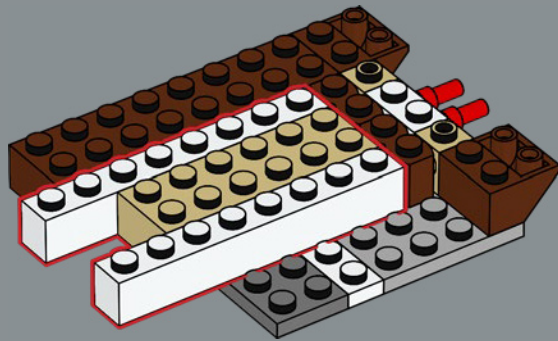

134

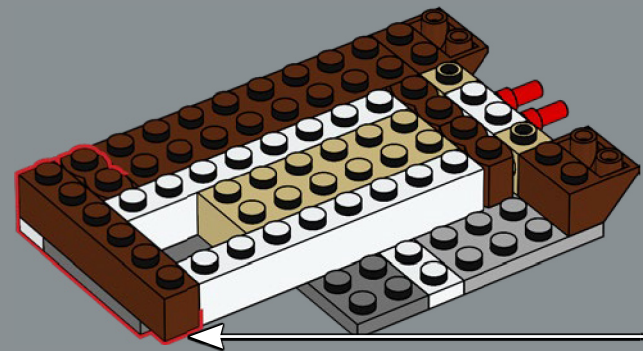
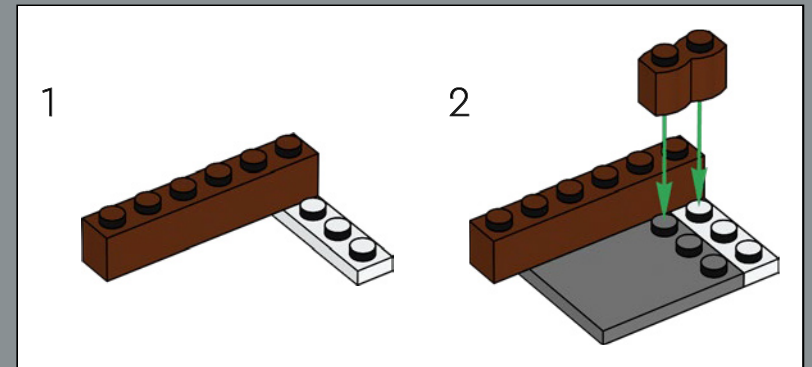

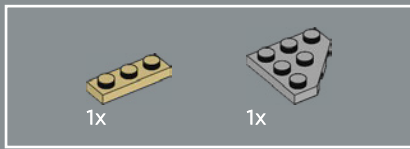

135

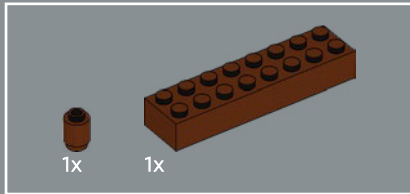
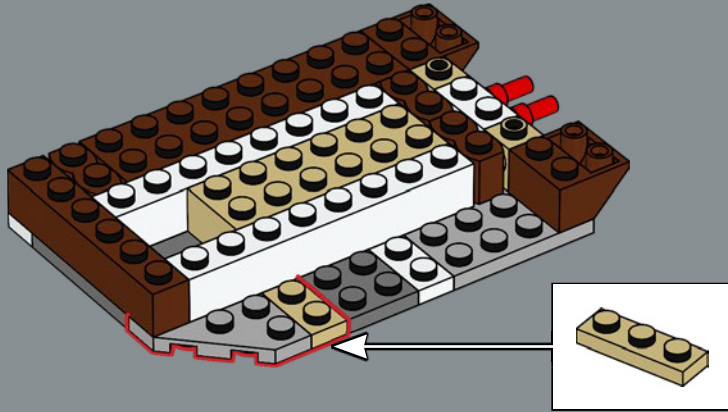

136

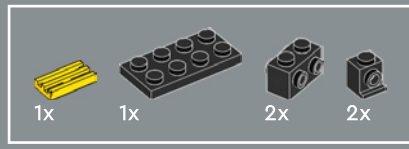
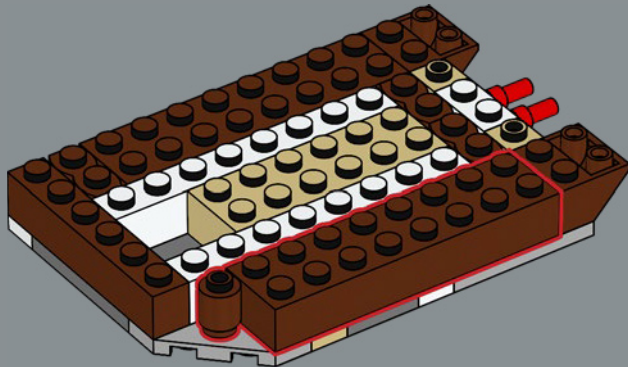

137

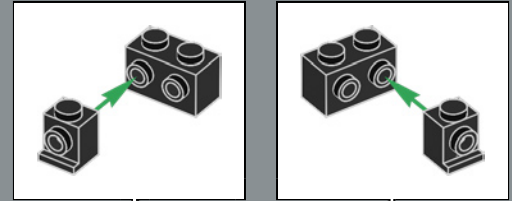

1

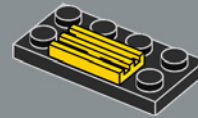

2

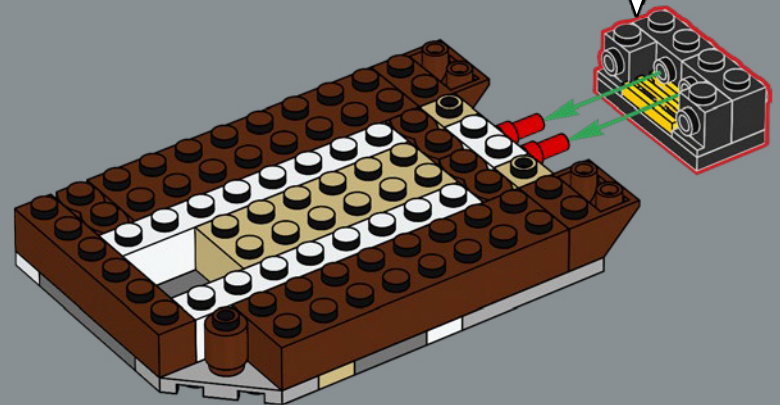
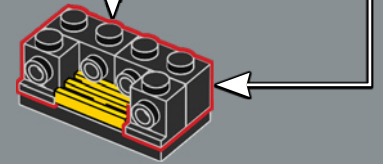

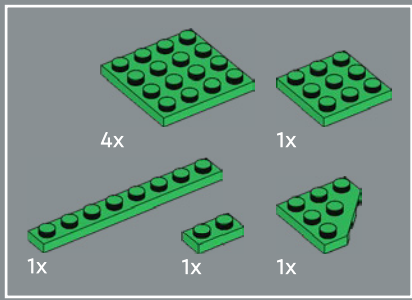

138

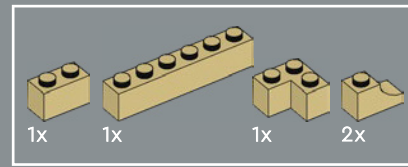

139

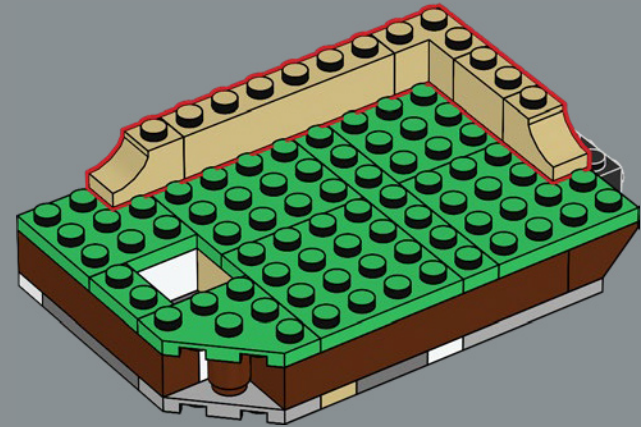

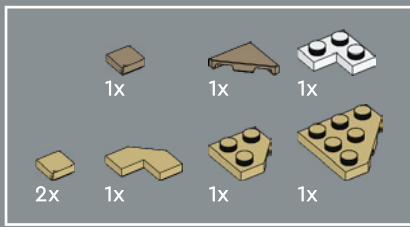

140

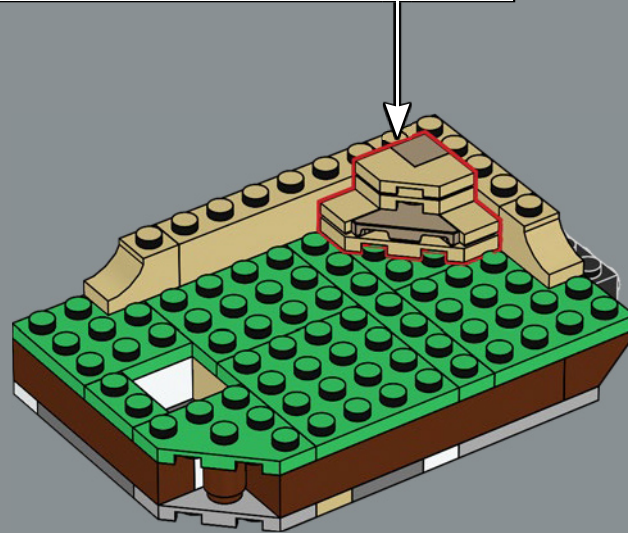
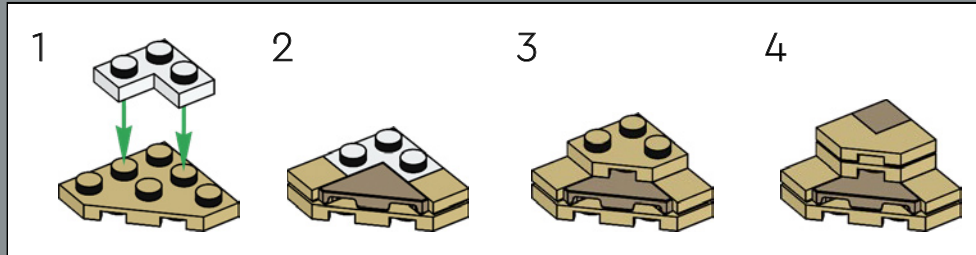

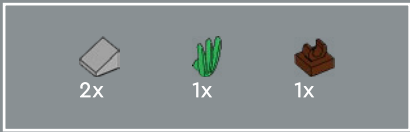

141

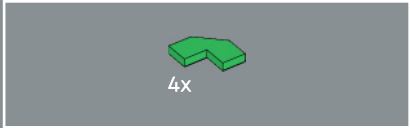
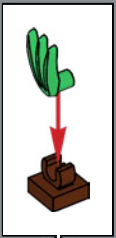

142

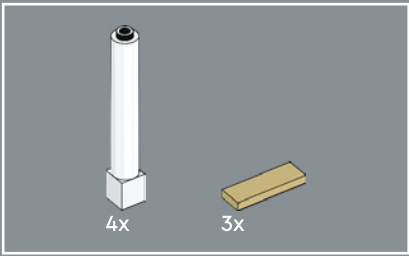
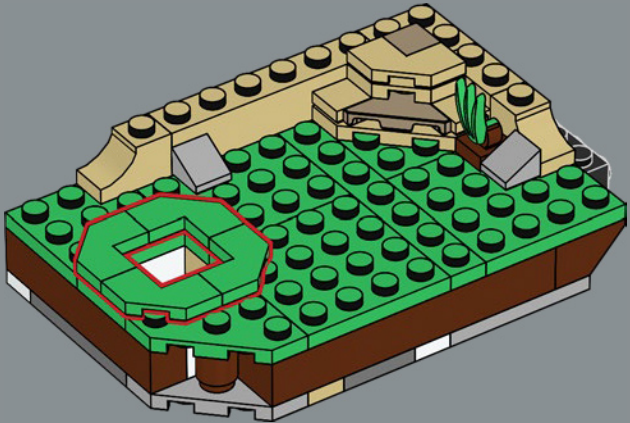

143

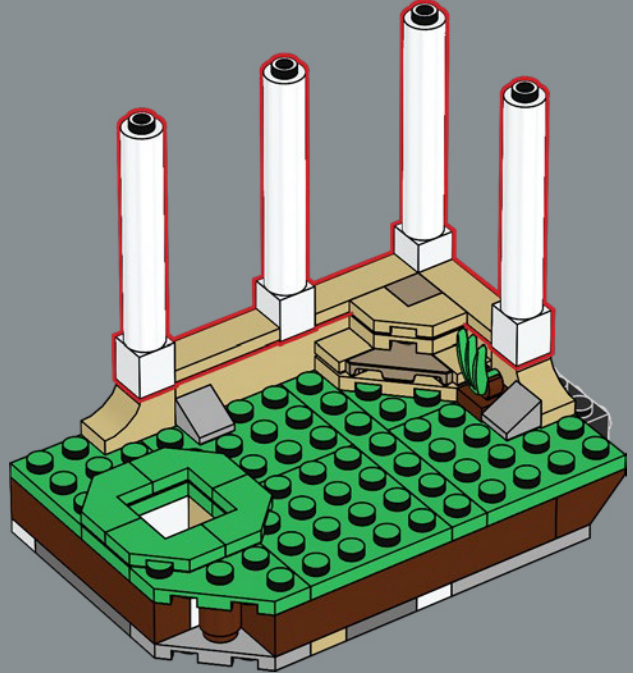

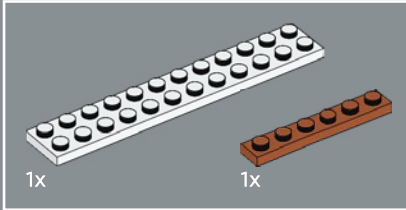
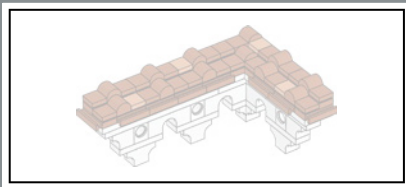

144

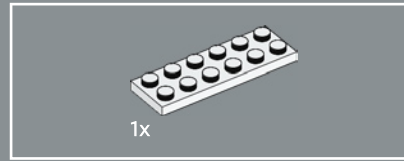
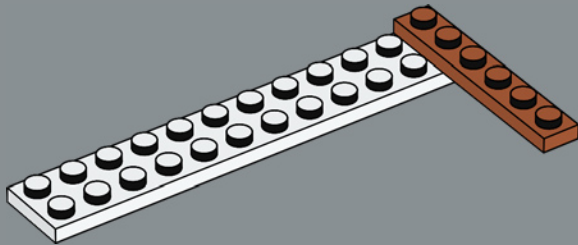

145

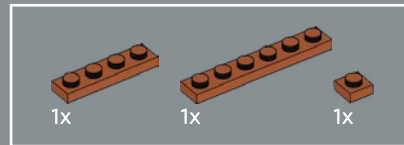
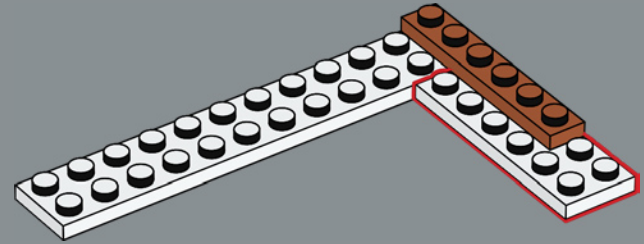

146

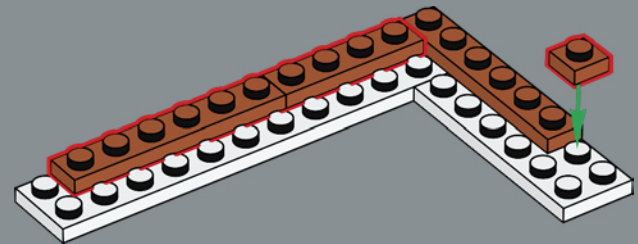



147

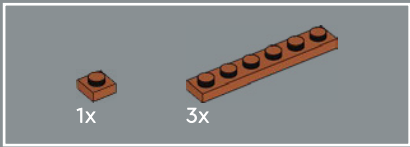
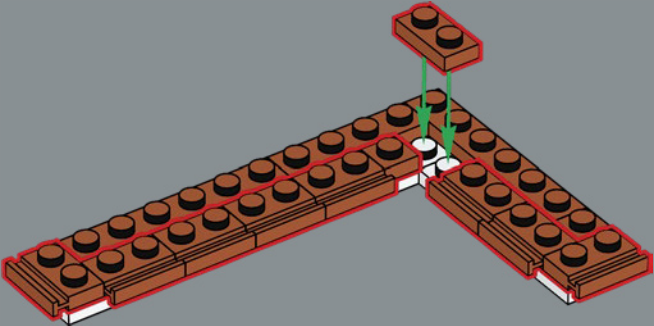

148

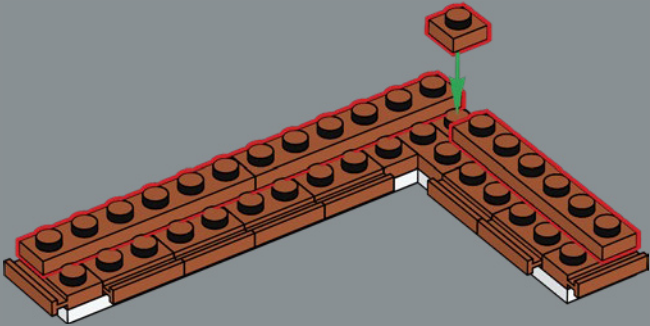

149

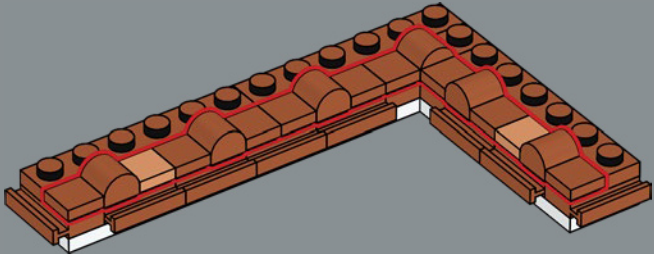

150

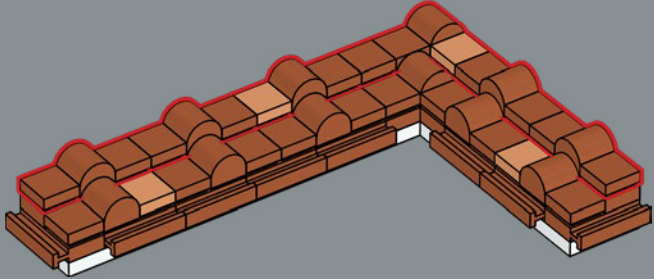

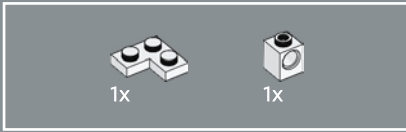
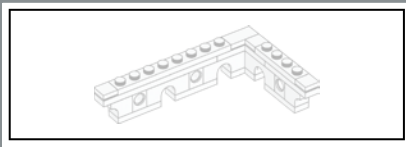

151

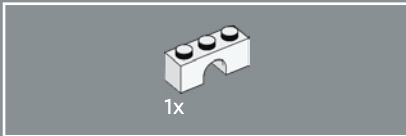
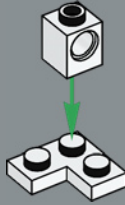

152

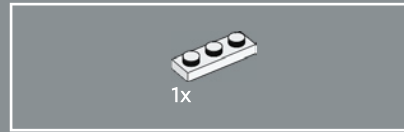
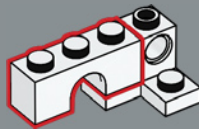

153

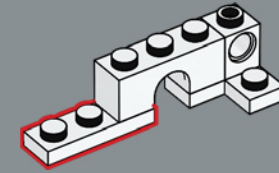

154

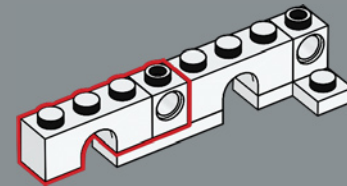

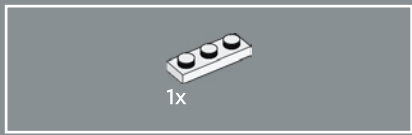

155

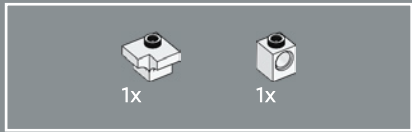
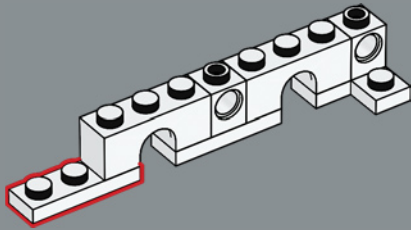

156

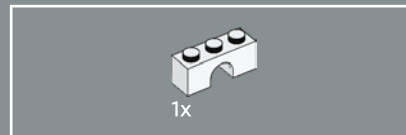
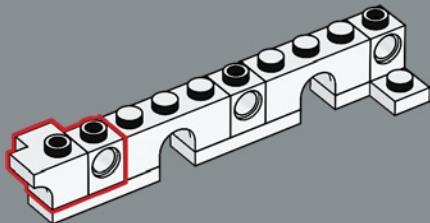

157

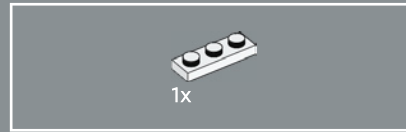
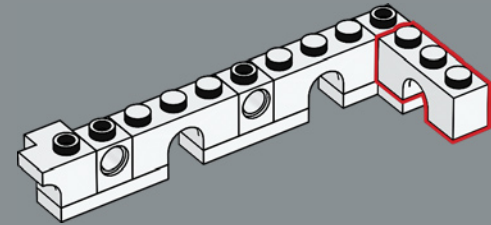

158

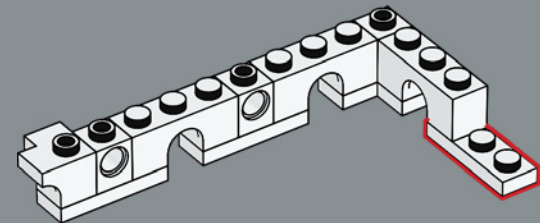

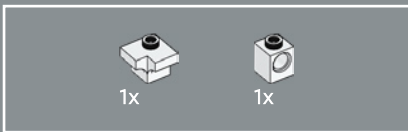

159

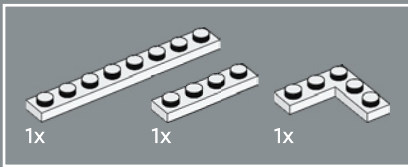
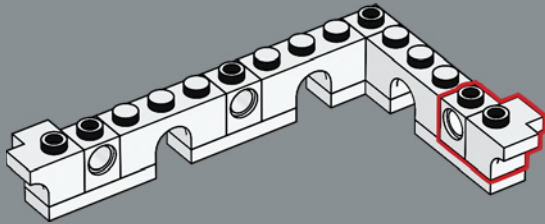

160

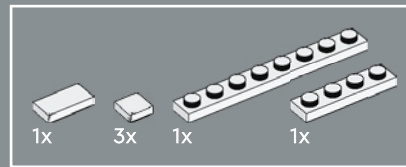
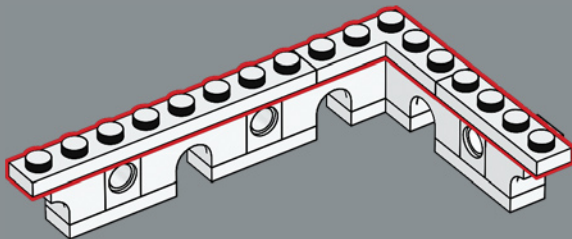

161

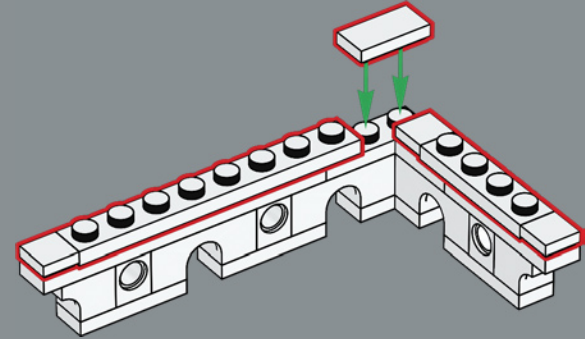

162

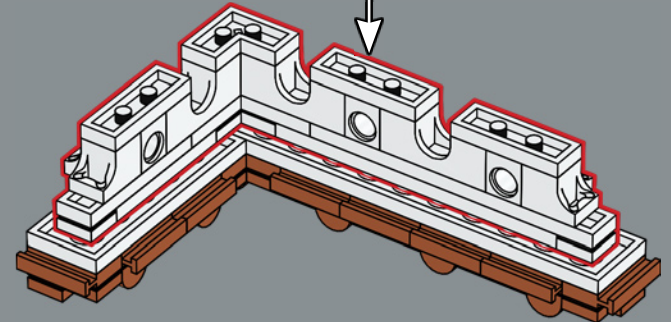

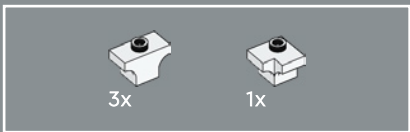

163

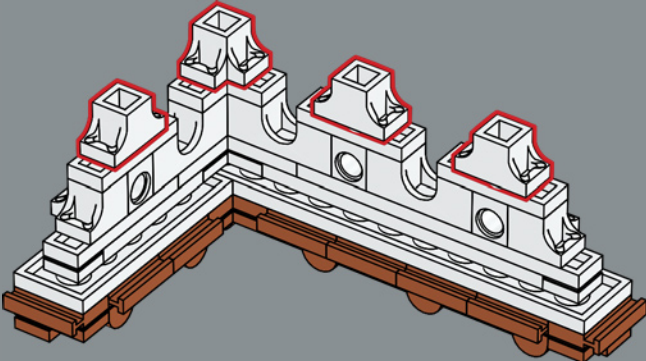

164

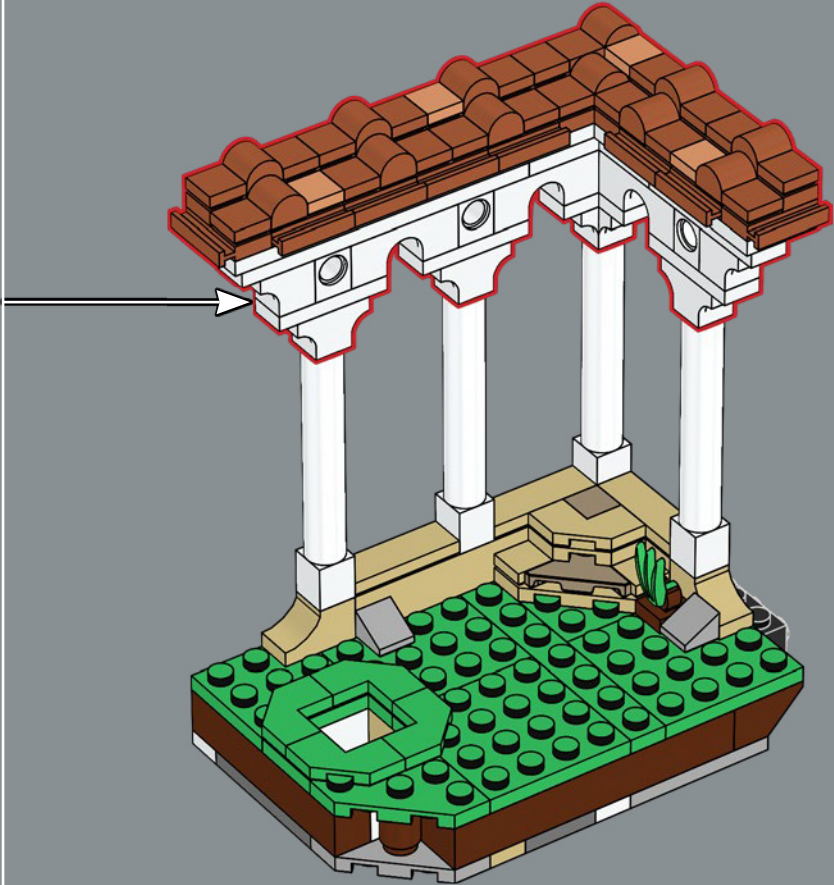

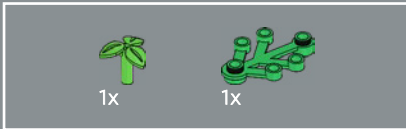
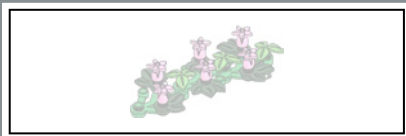

165

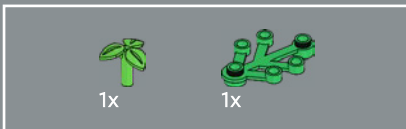
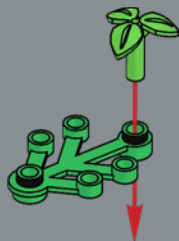

166

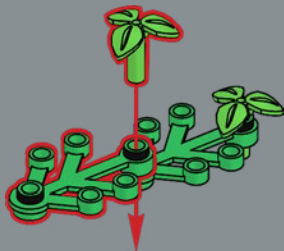

167

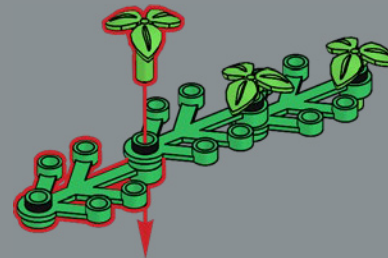

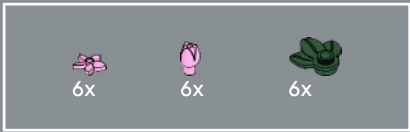

168

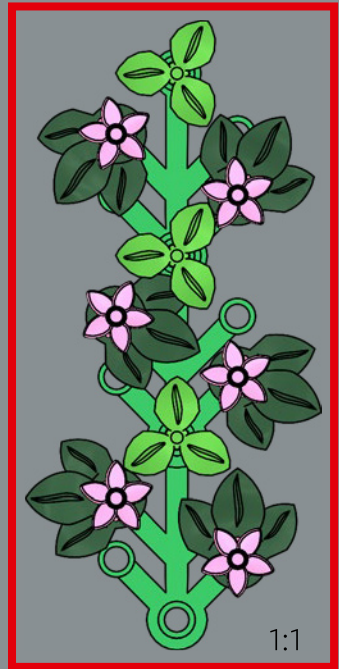
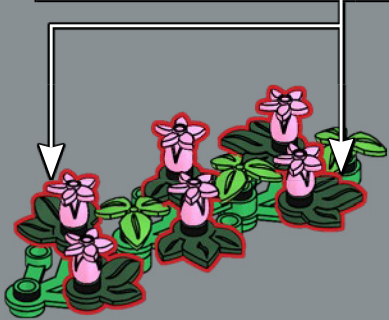
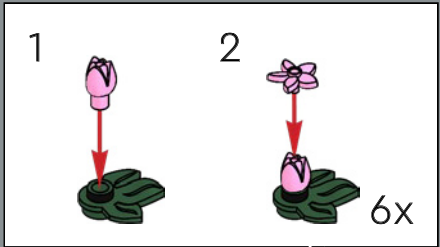

169

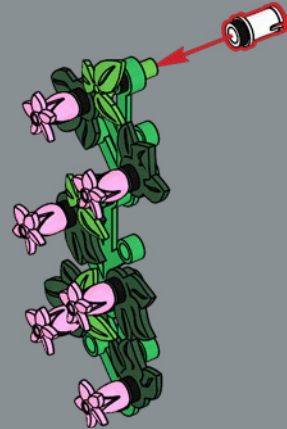

Fiori rosa di Bougainvillea (*Bougainvillea*)
 Ciò che la maggior parte delle persone considera il "fiore" della bougainvillea sono in realtà brattee o "falsi fiori", un diverso tipo di foglia che circonda i veri, minuscoli fiori della pianta.

170

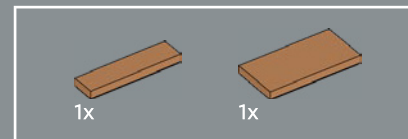
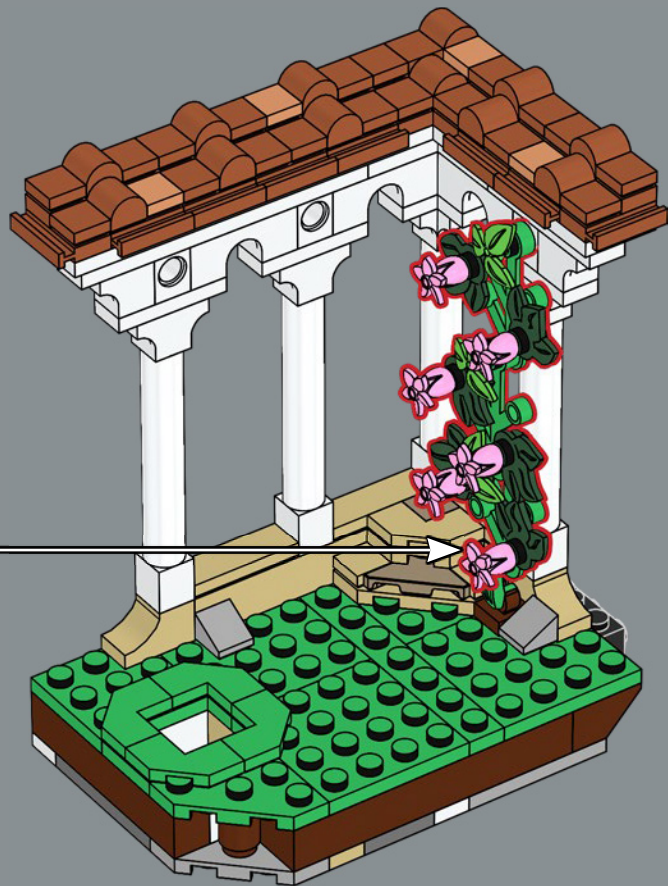

171





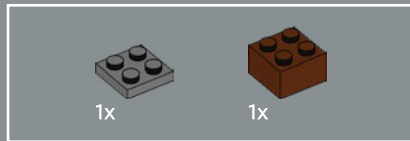
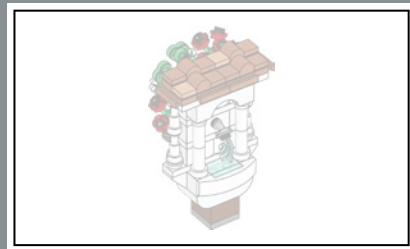

173

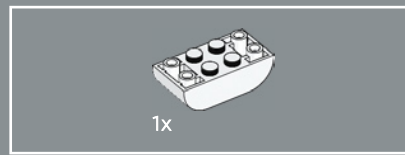
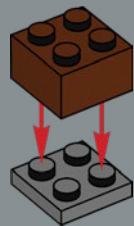

174

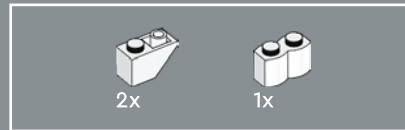
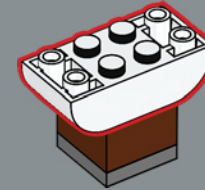

175

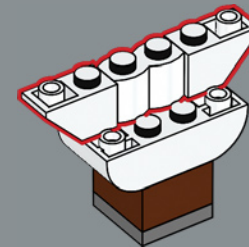

176

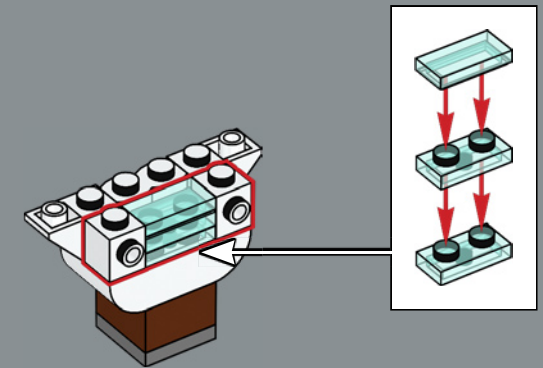



177

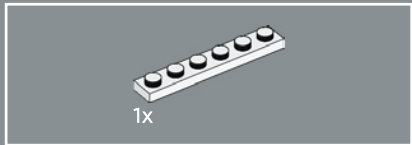
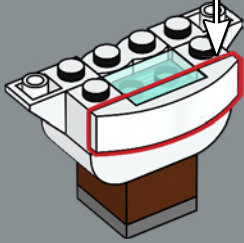
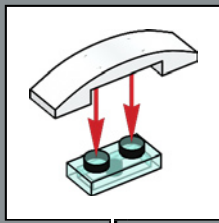

178

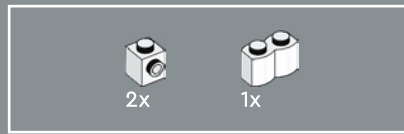
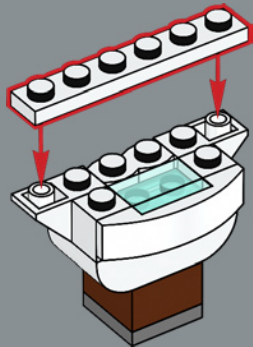

179

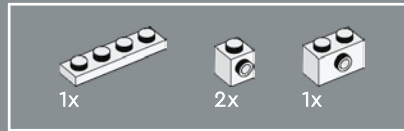
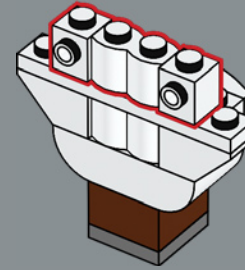

180

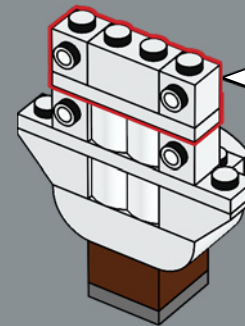
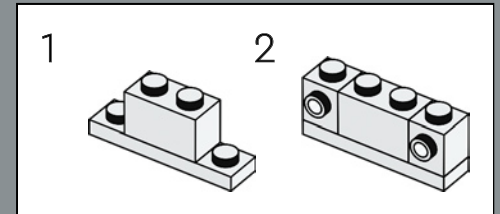

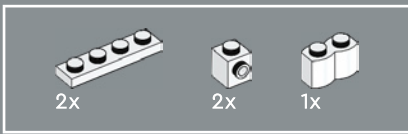

181

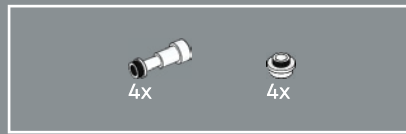
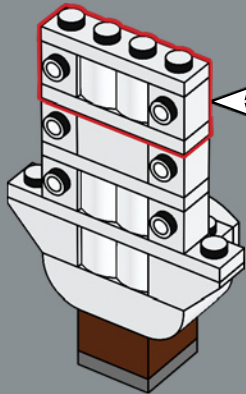
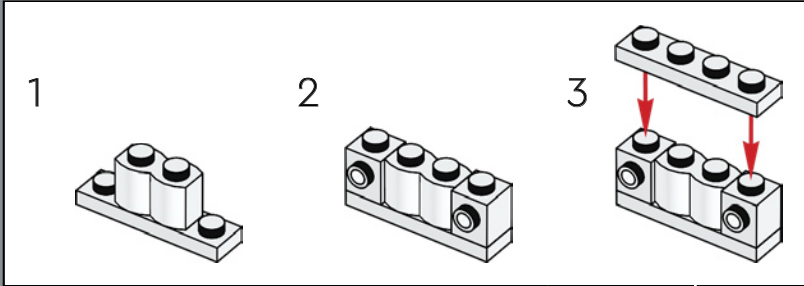

182

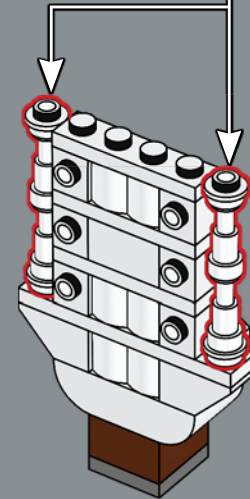
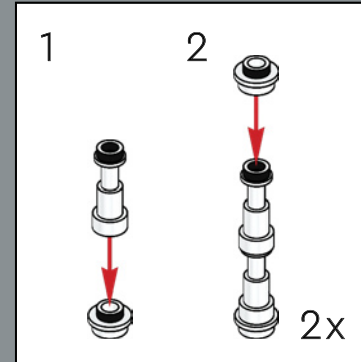



183

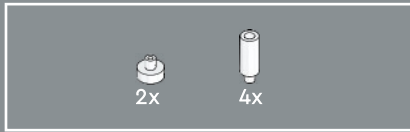
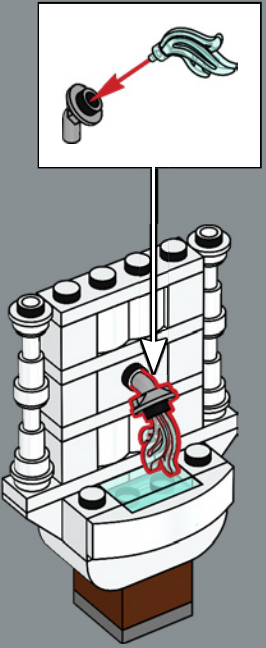

184

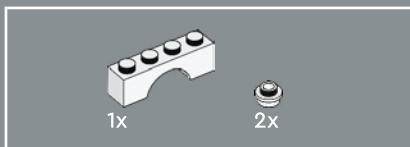
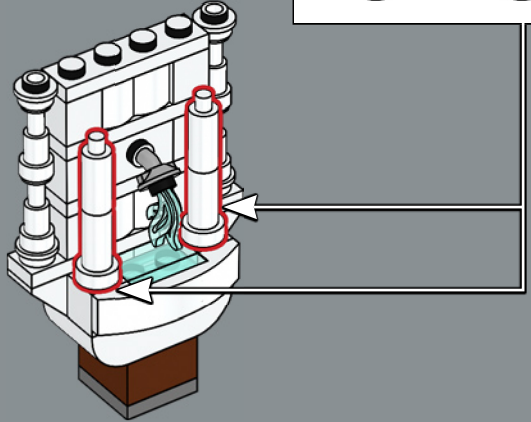
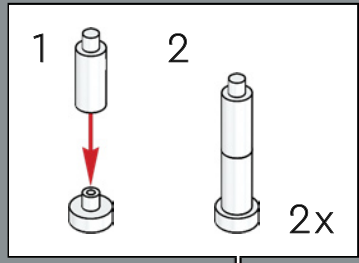

185

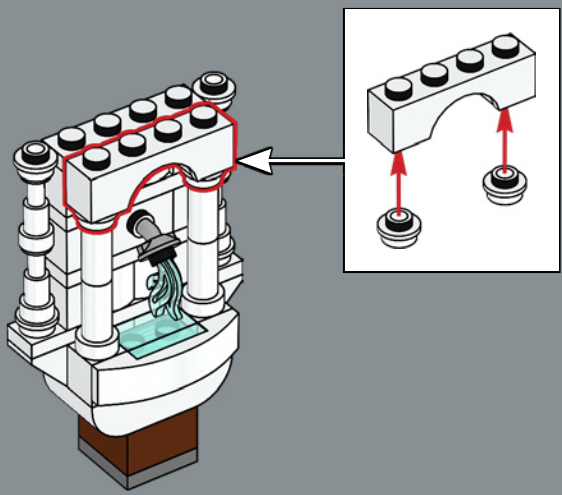

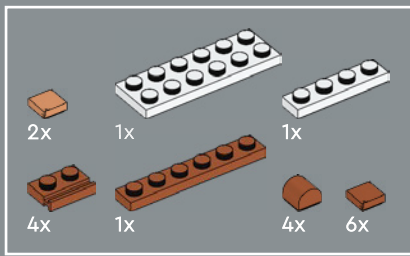

186

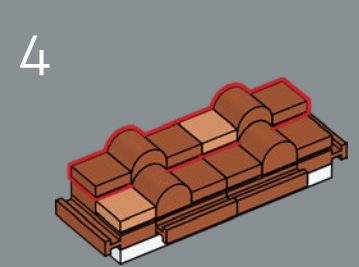
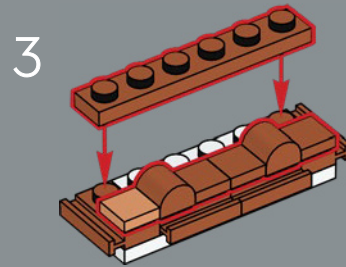
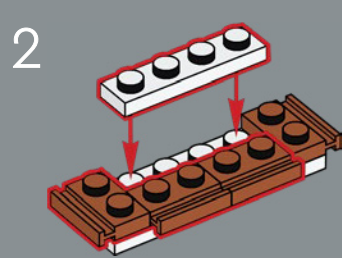
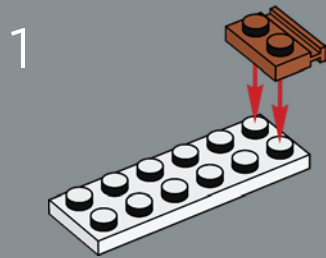



2x

187

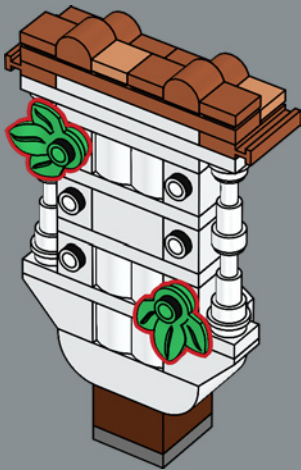

2x

188

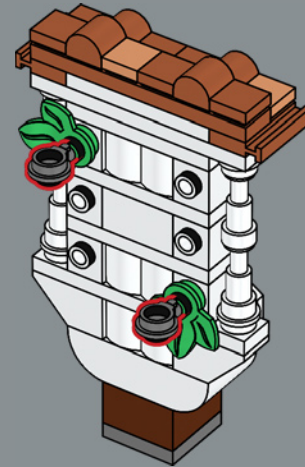

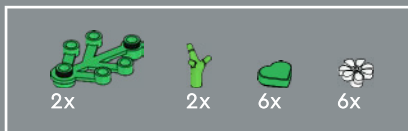

Petunia bianca (*Petunia axillaris*)
 Sebbene alcune specie di petunia possano essere usate
 come decorazione, forse è meglio lasciare che questa
 bellezza fiorisca nel tuo giardino. È imparentata non solo con
 patate e pomodori, ma anche con la letale belladonna!

189

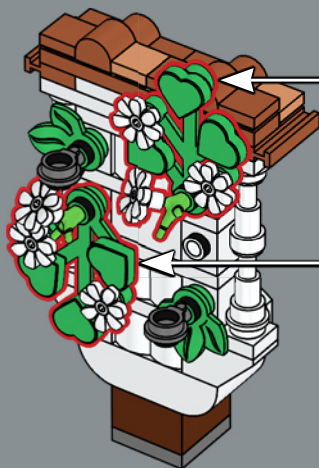
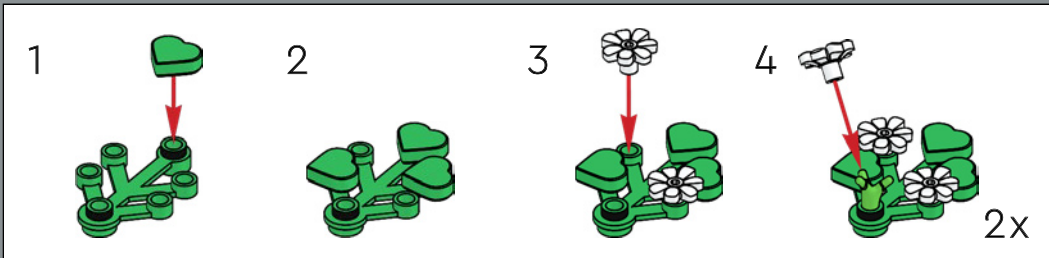

190

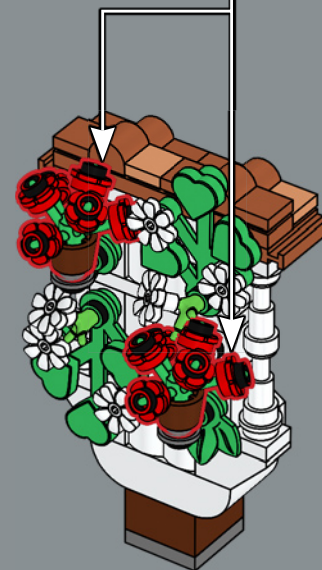
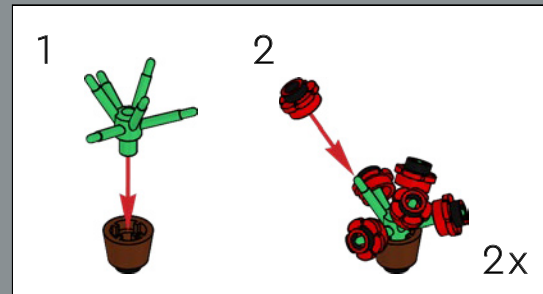

Geranio zonale (*Pelargonium x hortorum*)
 Il profumato geranio zonale serve sia a scopi estetici sia pratici in un giardino
 sereno. I suoi oli naturali emanano un profumo che respinge gli insetti!



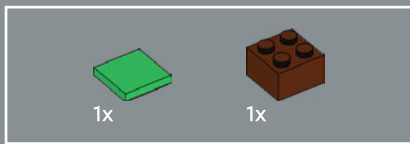

192

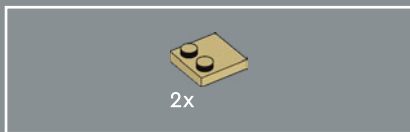
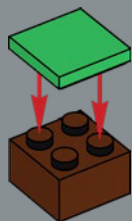

193

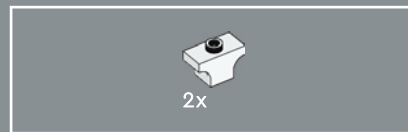
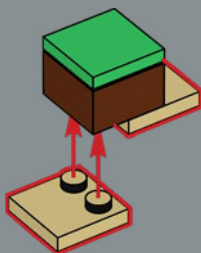

194

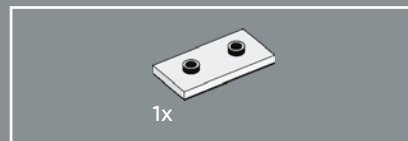
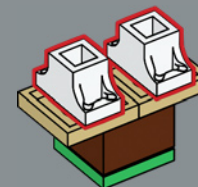

195

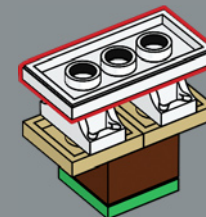

196

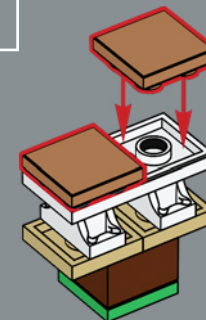



Rane verde iberica (*Pelophylax perezi*)
Originario della penisola iberica, questo piccolo e veloce nuotatore prospera negli habitat d'acqua dolce e nelle zone umide.

197



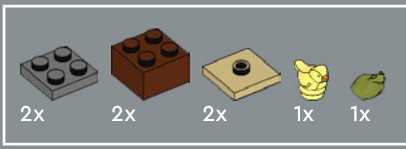

198

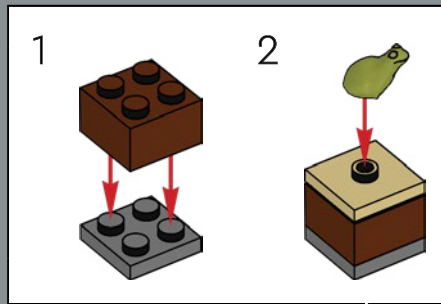

Zigolo giallo (*Emberiza citrinella*)
 Lo zigolo giallo, dal caratteristico piumaggio giallo brillante
 e dal canto inconfondibile, si trova in tutta Europa.

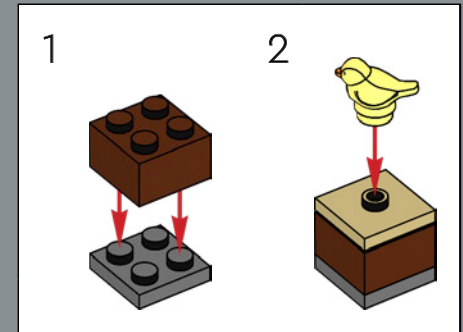

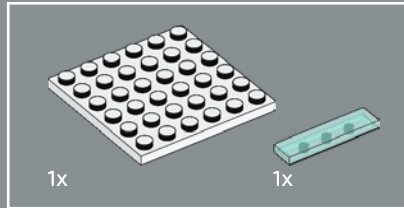
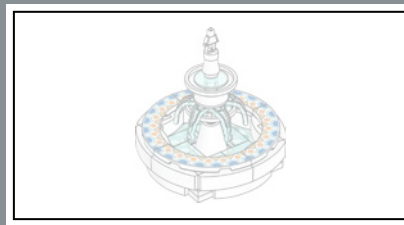

199

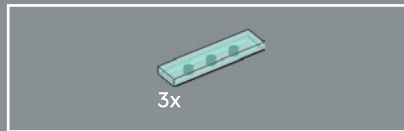
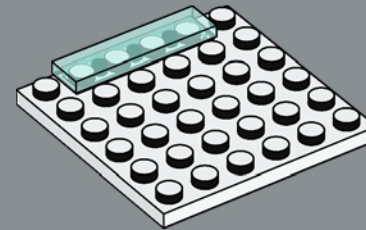

200

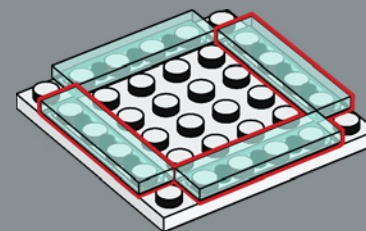

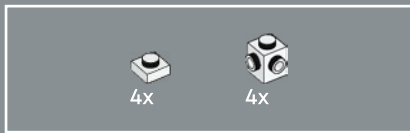

201

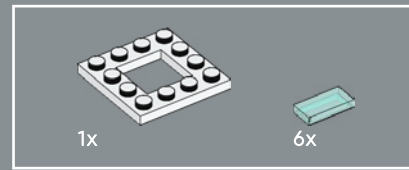
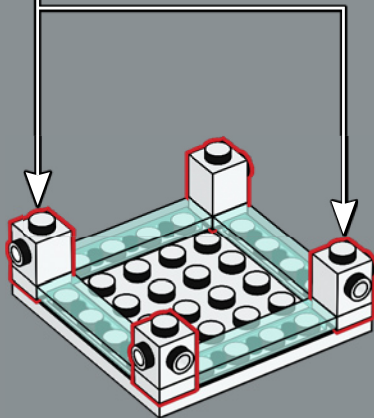
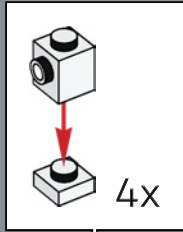

202

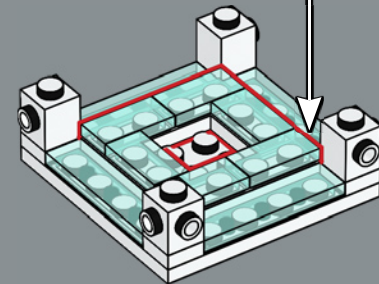
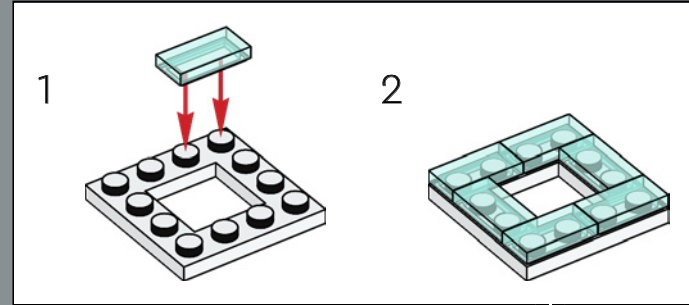

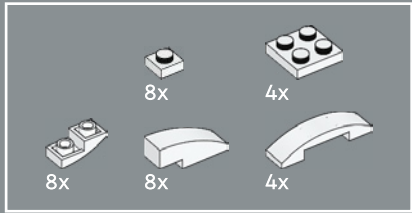
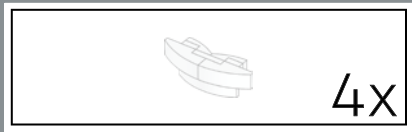

203

1

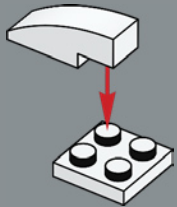

2

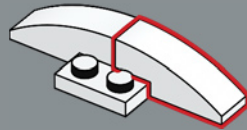

3

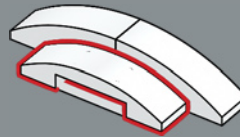

4

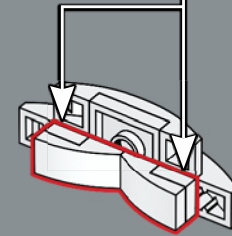
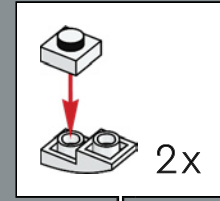

4x

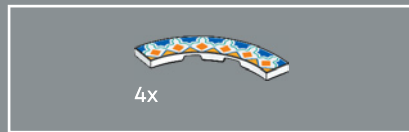

204

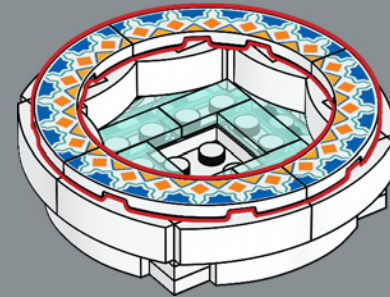
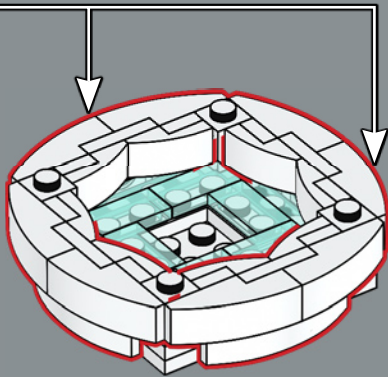

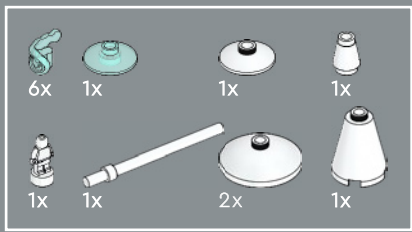

205

1

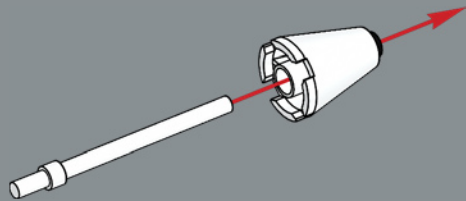

2



3



4



5

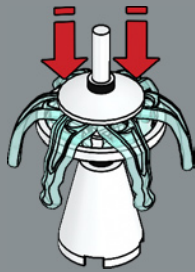

6

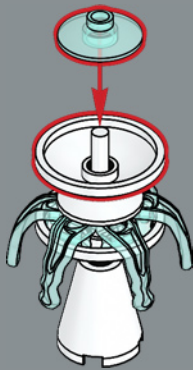

7

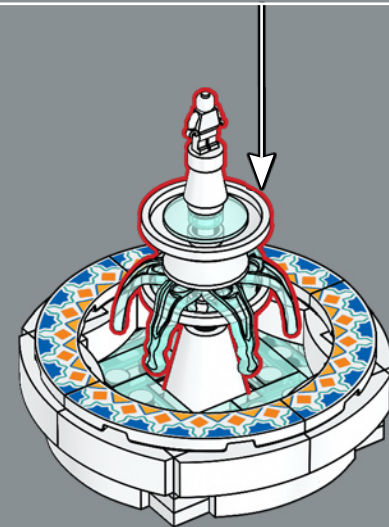
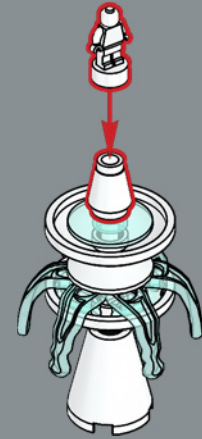



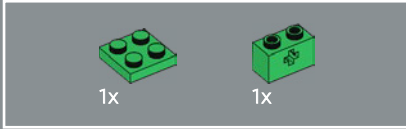

207

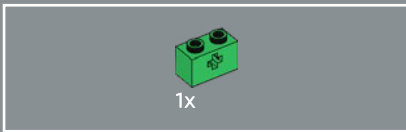
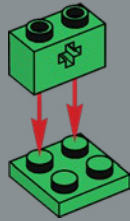

208

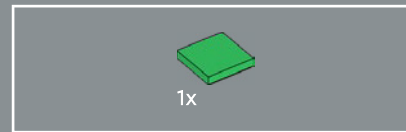
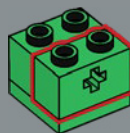

209

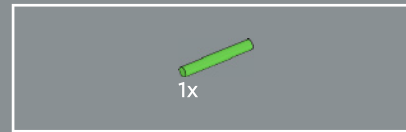
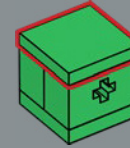

210

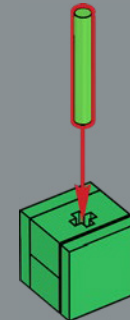
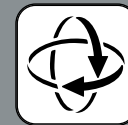

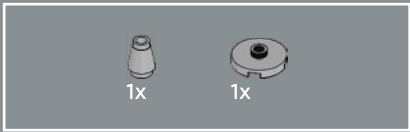

211

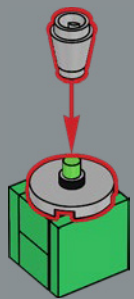

212

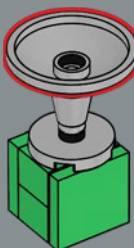

213

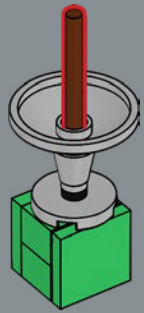



214

1

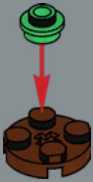

2

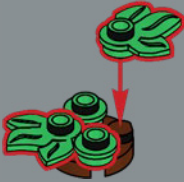

3

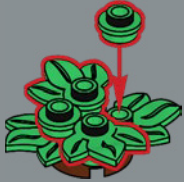

4

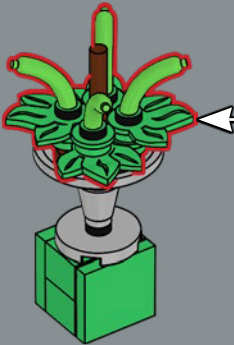

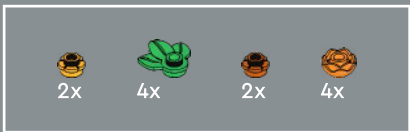

215

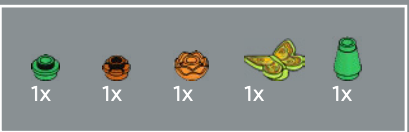
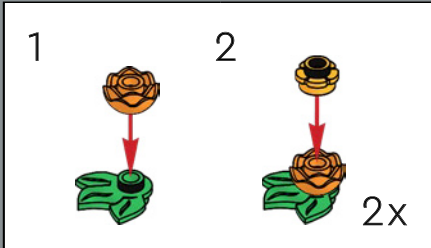
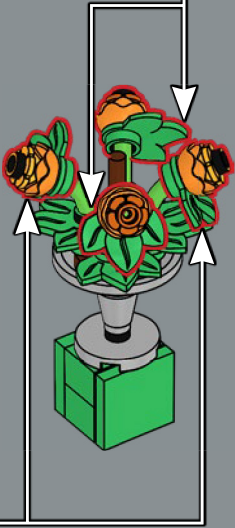
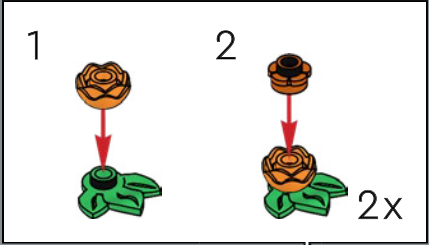

216

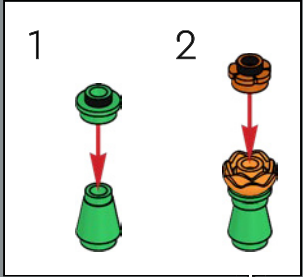

Farfalla luna spagnola (*Graellsia isabellae*)
 La farfalla luna spagnola, una straordinaria specie con ali verdi e incredibili occhi, prospera nei Pirenei. Una specie "relitta", è rimasta sostanzialmente immutata dall'ultima era glaciale.



217

Tagete arancione (*Tagetes patula*)
Il tagete è originario dell'America Centrale, ma questi piccoli raggi di sole aromatici sono amati dai giardinieri e dagli chef di tutto il mondo come decorazione o come tocco piccante ai dolci dessert.



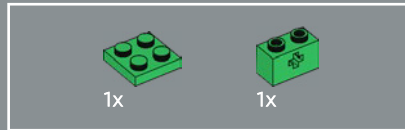
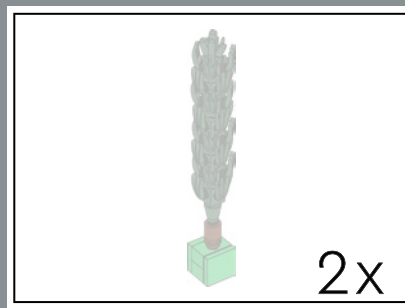

218

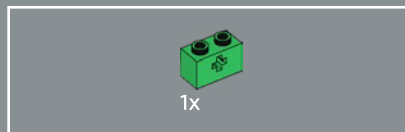
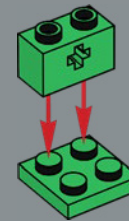

219

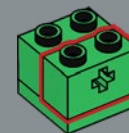

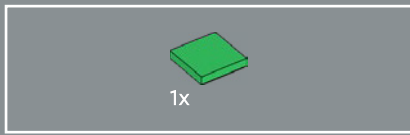

220

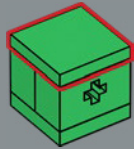

221

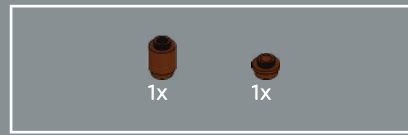
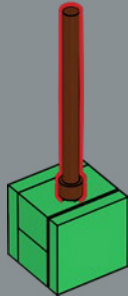

222

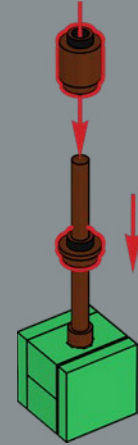

223

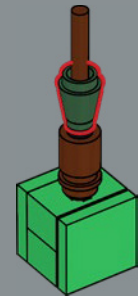

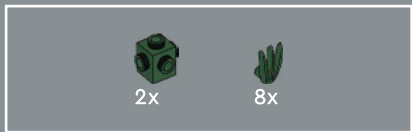

224

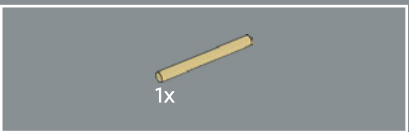
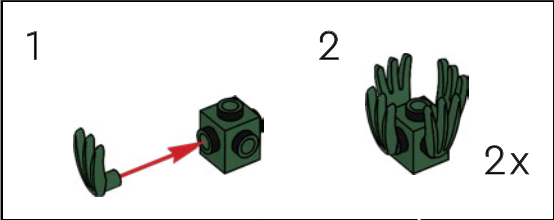

225





226

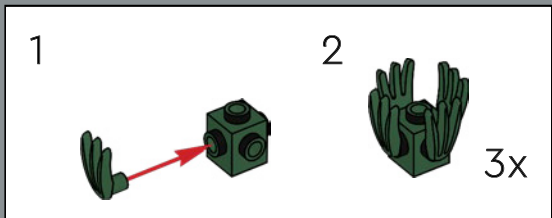

227





228

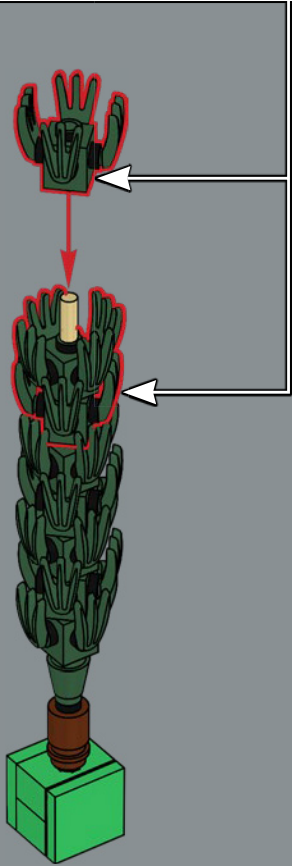
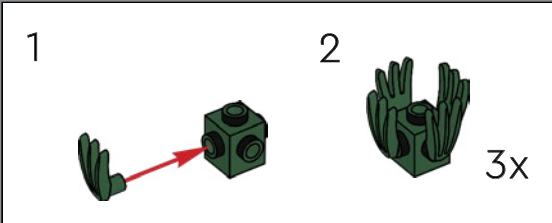

229



Cipresso (*Cupressus sempervirens*)
Con la loro forma e bellezza distintive, i cipressi sono una vista comune nei paesaggi mediterranei. Sapevi che il loro olio aromatico è un ingrediente prezioso nei rimedi per la salute e nei prodotti di bellezza?



2x



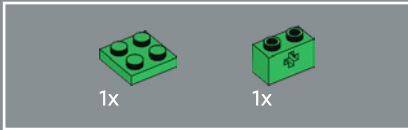
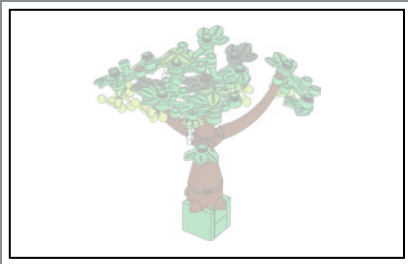

231

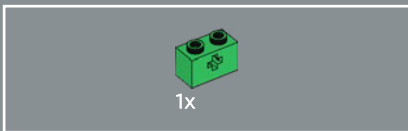
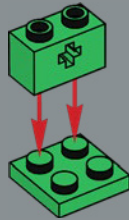

232

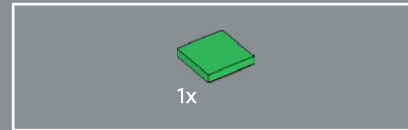
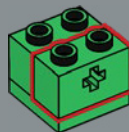

233

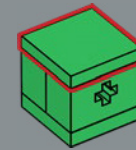

Vite (*Vitis vinifera*)

Un alimento base deliciosamente dolce e succoso, l'uva fu coltivata per la prima volta da antiche civiltà più di 10.000 anni fa.

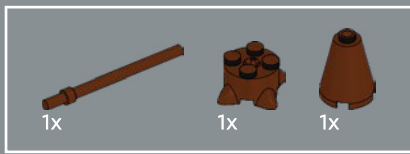

234

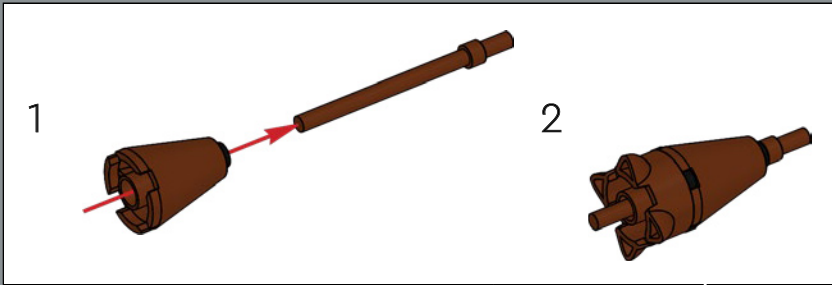

235

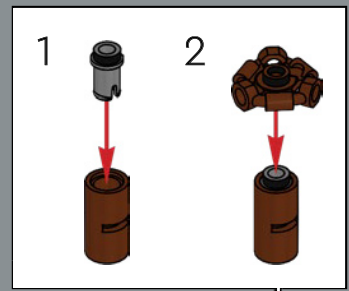

236





237

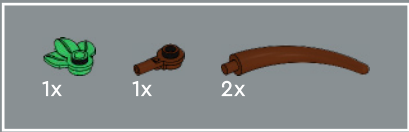

238

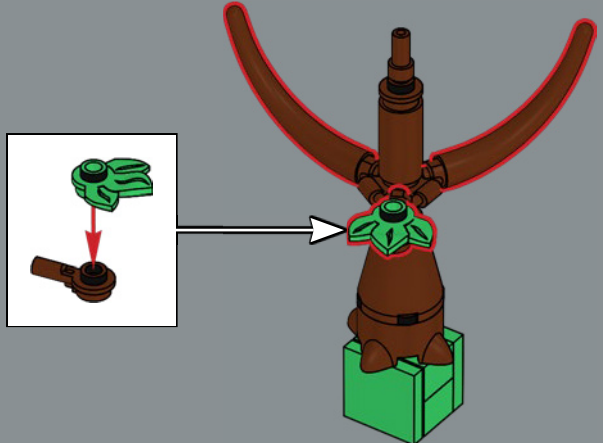

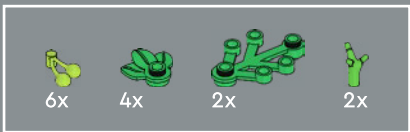

239

1

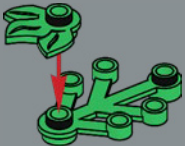

2

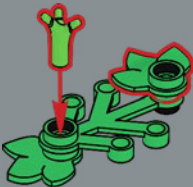

3

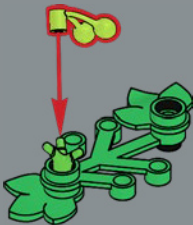

4

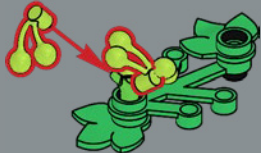

2x

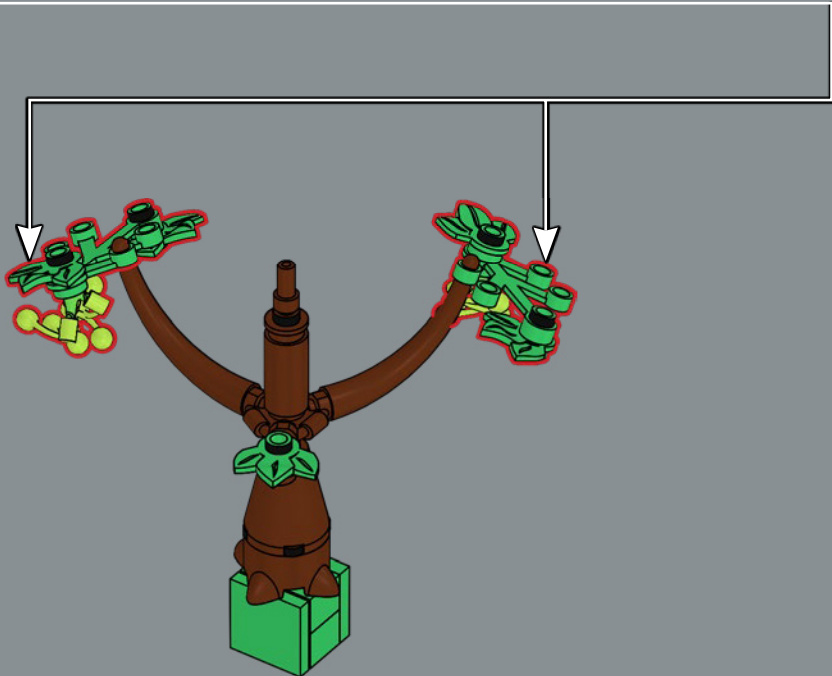

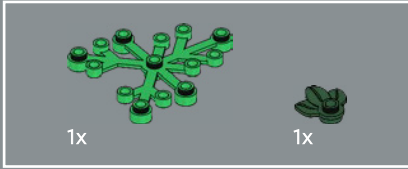
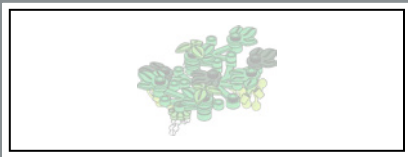

240

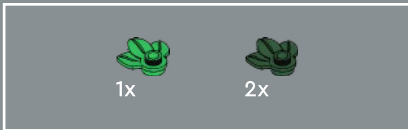
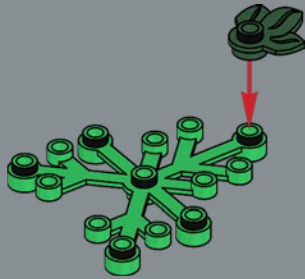

241

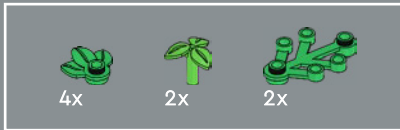
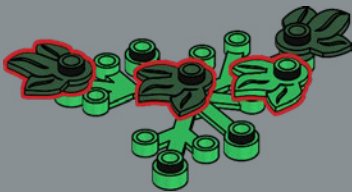

242

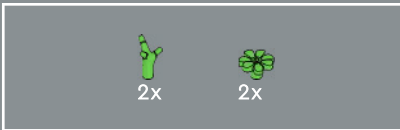
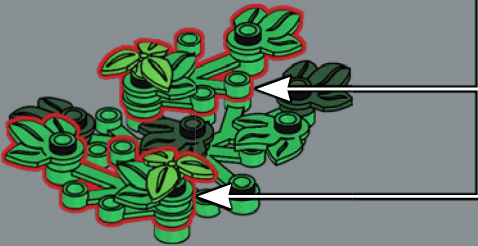
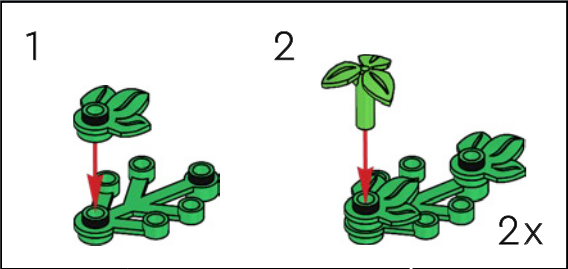

243

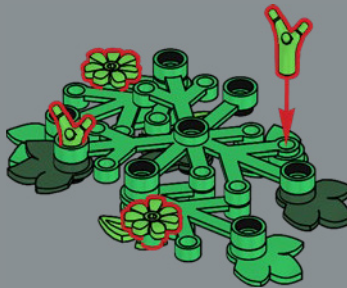



244

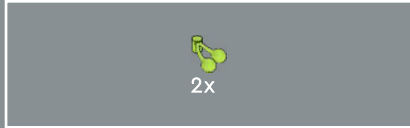

245

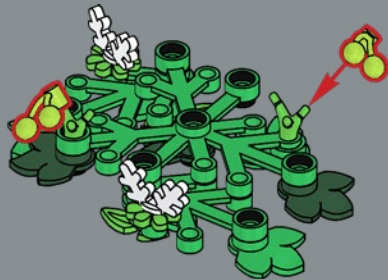

246

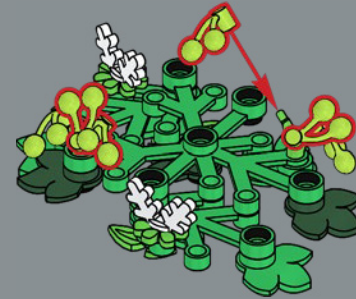

247

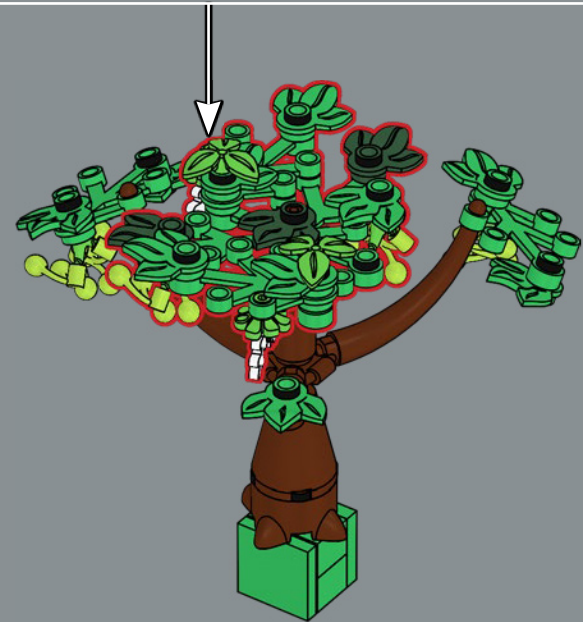



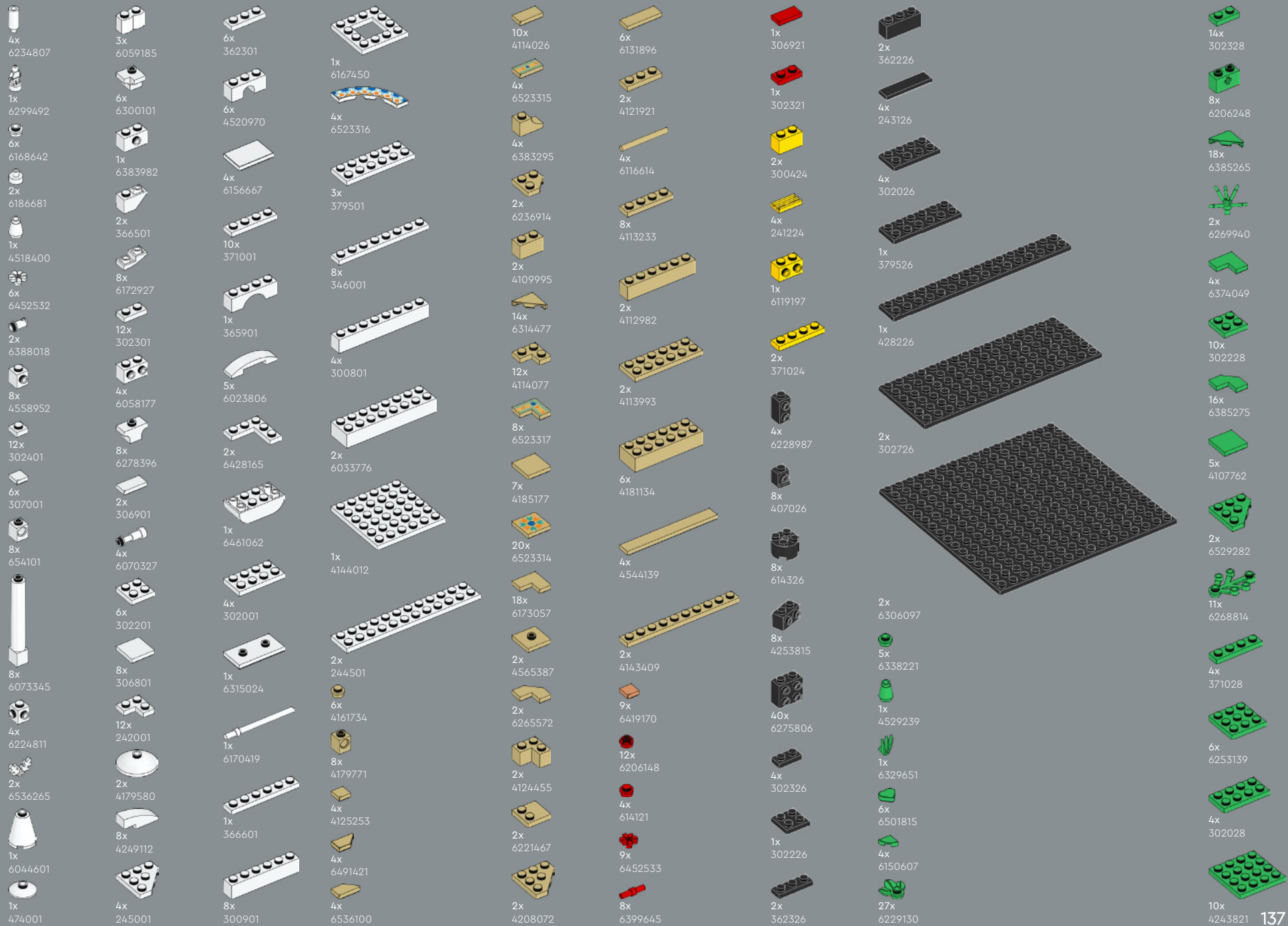



2x
6266968

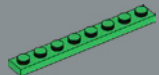

2x
346028

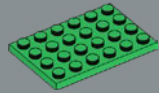

6x
4116671

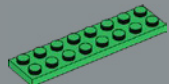

2x
303428



7x
6434871



2x
6488792



4x
6430093



8x
6235080



1x
6161772

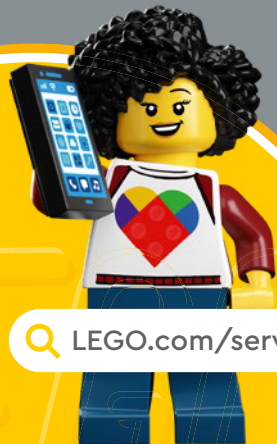

 [LEGO.com/service](https://www.LEGO.com/service)

47x
6143431

28x
6439726

6x
6186012

2x
4570877

20x
6228839

2x
6074892

11x
6253418

6x
6353237

1x
6326099

1x
6245307

3x
6514007

7x
6514224

8x
6510178

5x
6550815

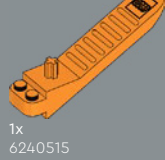

1x
6240515

12x
6087084

1x
6523318

2x
6055172

2x
6480380

24x
6315608

64x
6532422

2x
6411591

12x
6532421

12x
4504375

4x
4521915

2x
6532423

16x
6532420

9x
6400754

2x
4245571

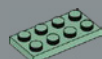

2x
6249817

2x
6209681

6x
6186673

2x
6284586

4x
4211183

4x
6215659

2x
6173143

1x
6348057

1x
6451002

1x
6306775

1x
4211159

1x
6488490

8x
4211180

1x
6492629

1x
6173132

1x
6468829

6x
4211210

8x
6425510

4x
4211200

1x
6116613

2x
4211201

3x
6170468

2x
6372430

2x
4211193

4x
6096701

1x
4529241

1x
6510189

7x
4521921

1x
6183782

8x
4211414

2x
4211387

8x
4211413

2x
4211397

1x
6070564

2x
4211361

2x
4211396

6x
6015347

1x
4612621

2x
4211452

6x
4211425

2x
4211404

2x
4211407

6x
6519672

6x
6096990

1x
6465604

2x
6395635

1x
4504378

1x
4210848

2x
6388118

2x
4211088

3x
4211094

8x
4624186

4x
4210897

2x
4509911

2x
6199511

2x
6187438

6x
4210997

8x
6272145

2x
6313601

4x
6365746

8x
6187006

24x
6102998

22x
6218359

1x
6472547

3x
6475523



YOU COULD WIN



YOU COULD WIN

Your feedback will help shape the future development of this product series.

Visit:

DU KÖNNTEST GEWINNEN

Dein Feedback trägt zur Weiterentwicklung dieser Produktreihe bei.

Geh auf:

VOUS POURRIEZ GAGNER

Vos commentaires nous aideront à concevoir les futurs produits de cette gamme.

Visitez :

POTRESTI VINCERE TU

La tua opinione ci aiuterà a migliorare la creazione futura di questa linea di prodotti.

Visita:

PUEDES GANAR

Tu opinión contribuirá al futuro de esta serie de productos.

Visita:

轻松获奖

您的反馈将有助于我们在今后改进本产品系列。

请访问:

[LEGO.com/productfeedback](https://www.lego.com/productfeedback)

You also have the chance to win a LEGO® set.

Terms and conditions apply.*

Außerdem hast du die Chance, ein LEGO® Set zu gewinnen.

Es gelten die Teilnahmebedingungen.*

Vous pourriez également gagner un ensemble LEGO®.

Des conditions s'appliquent.*

Hai anche la possibilità di vincere un set LEGO®.

Termini e condizioni sono applicabili.*

También tienes la oportunidad de ganar un set LEGO®.

Aplican términos y condiciones.*

您还有机会赢取乐高®套装。

条款和条件适用。*

*[LEGO.com/productfeedback-terms](https://www.lego.com/productfeedback-terms)

